



NEW MEXICO
ENVIRONMENT DEPARTMENT



DOE Oversight Bureau

BILL RICHARDSON
Governor
DIANE DENISH
Lieutenant Governor

1183 Diamond Drive, Suite B
Los Alamos NM 87544 MS M894
Phone (505) 661-2670 Fax (505) 661-4958
www.nmenv.state.nm.us

RON CURRY
Secretary
SARAH COTTRELL
Deputy Secretary

April 20, 2010

Jeffrey M. Casalina
Environmental Projects Office (EPO)
U.S Department of Energy
National Nuclear Security Administration
Los Alamos Site Office
3747 West Jemez Road, MS A316
Los Alamos, NM 87544

Subject: Storm Flow Monitoring along the Rio Grande and Chama River New Mexico Conducted by NMED/DOE Oversight Bureau for FFY 2009 Q-4 April 19, 2010

Dear Mr. Casalina:

This letter transmits the subject Final report. Thank you for the thorough review and thoughtful comments provided by DOE and LANL. We incorporated many of them and they enhanced the report considerably.

If you have any questions or if you would like copies of the complete data set please contact Ralph Ford-Schmid at 476-6023 or contact me at 661-2644.

Sincerely,

Stephen Yanicak, Staff Manager, /POC

SY:rf-s

Enclosure: Data Submittal entitled: "Storm Flow Monitoring along the Rio Grande and Chama River New Mexico Conducted by NMED/DOE Oversight Bureau for FFY 2009 Q-4 April 19, 2010" with the following enclosures:
(1) Table 1. Total PCB, Homologue, SSC and Calculated Total PCB in Suspended Sediment Results in Storm Flow from the Rio Grande and Chama River 2009

- (2) Table 2. Dissolved Metals Results in Storm Flow from the Rio Grande and Chama River 2009
- (3) Table 3. Unfiltered Radiological Results in Storm Flow from the Rio Grande and Chama River 2009
- (4) Table 4. Unfiltered Gamma Radiological Results in Storm Flow from the Rio Grande and Chama River 2009
- (5) Table 5. Suspended Sediment Concentration (SSC), and Percent Particle Size for the Clay and Sand Fraction in Storm Flow from the Rio Grande and Chama River 2009
- (6) Table 6. Percent Particle Size for the Silt Fraction in Storm Flow from the Rio Grande and Chama River 2009
- (7) Table 7. SSC, Sand Fraction, Silt Fraction, and Clay Fraction in Storm Flow from the Rio Grande and Chama River 2009
- (8) Table 8. Former PCB End Uses for various Aroclors
- (9) Figures 1 through 38. Map of Study Area, the Rio Grande above Alameda Location, Hydrographs, and Sample Histories
- (10) Figures 39 through 41 Correlations between Contaminant Concentrations and SSC
- (11) Figures 42 through 50 PCB Homologue Distributions

cc: Thomas Skibitski, Chief, DOE OB/SOS
Gene Turner, MS 316
Armand Groffman, EP WES/LWSP, MS K49



BILL RICHARDSON
Governor
DIANE DENISH
Lieutenant Governor

**NEW MEXICO
ENVIRONMENT DEPARTMENT**

DOE Oversight Bureau

1183 Diamond Drive, Suite B
Los Alamos NM 87544 MS M894
Phone (505) 661-2670 Fax (505) 661-4958
www.nmenv.state.nm.us



RON CURRY
Secretary
SARAH COTTRELL
Deputy Secretary

**Storm Flow Monitoring along the Rio Grande and Chama River New Mexico
Conducted by NMED/DOE Oversight Bureau for FFY 2009 Q-4
April 19, 2010**

The New Mexico Environment Department (NMED) DOE Oversight Bureau (Bureau) has compiled and evaluated surface water data collected along the Rio Grande and Chama River during the fourth quarter FFY 2009. Samples were collected following protocols outlined in Quality Assurance Project Plans (NMED 2006, 2009) and Sampling and Analysis Plans (NMED 2009a) developed by the Bureau and using Oversight Bureau equipment and staff. Twenty samples are evaluated in this report. Seventeen samples were collected during precipitation-induced flow events from four locations along the Rio Grande and one along the Rio Chama. The Bureau established sampling stations along the Rio Grande at Lyden, Otowi Bridge, Buckman Landing, and upstream of the Alameda Bridge in Albuquerque and along the Rio Chama at Chamita. Samples were collected that represent non-storm flows (baseflow) at two locations; at the eastern bank of the Rio Grande upstream of the Alameda bridge (July 10th), and Rio Chama at Chamita (August 10th). One sample collected at Buckman Landing (July 19th) was rejected due to equipment malfunction. Samples were also collected from the Rio Grande at Otowi Bridge, Buckman Landing, and Lower Los Alamos Canyon during a flow event on October 13th where Los Alamos Canyon discharge was reaching the Rio Grande. The October 13th samples have been submitted for analysis but data from them are not available at the time of this report.

During the spring of 2009 NMED held “listening sessions” in several towns across northern New Mexico to help define environmental concerns of citizens. At the Albuquerque listening session, members of the public asked if any Los Alamos National Laboratory (LANL) contaminants have been found in the intake waters for the Albuquerque Bernalillo County Water Utility Authority San Juan-Chama Drinking Water Project (ABCWUA S-JDWP). The same questions were raised at other listening sessions about the City of Santa Fe Buckman Direct Diversion project along the Rio Grande. The Bureau committed to collecting Rio Grande water samples upstream from the ABCWUA S-JDWP intake (near the Alameda Bridge) and the proposed Buckman Direct Diversion and analyzing them for radionuclides, polychlorinated biphenyls (PCBs), dioxin/furans, and metals. The radionuclide, PCB, metals, suspended sediment concentration, and particle size determination results are presented here. The samples for dioxin/furan have been sent to laboratory for analysis but data from them are not available at the time of this report.

This study focused on collecting water samples from the Rio Grande at locations that would provide insight to water quality upstream from the proposed Buckman Direct Diversion project

and the ABCWUA S-JDWP during wet weather events. Storm flows were expected to produce the highest levels of suspended sediment and subsequently the highest levels of contaminants for those constituents that commonly bound to sediment particles (e.g., radionuclides, PCBs). Constituents typically found in storm water discharges from Los Alamos Canyon at LANL were targeted to determine if past or current discharges from the Laboratory are detectable in the Rio Grande during storm flow events.

Summary of Conclusions

Data evaluated do not indicate an influence from past LANL discharges on current water quality conditions near drinking water diversions. The data were not sufficient to answer the same question about current discharges because Los Alamos Canyon was not discharging at the time the upstream or downstream samples were collected in the Rio Grande. Total PCB concentrations were below the PCB human health and wildlife habitat water quality criteria at all four locations upstream from and including the Buckman Direct Diversion, but the concentration exceeded the criteria five times at the Rio Grande upstream from the Alameda Bridge.

Methods

Automated ISCO 3700 water samplers and ISCO 4230 flow meters were installed at each location. The samplers and flow meters were stored in equipment boxes and powered by solar-charged deep-cycle marine batteries. The ISCO flow meters are capable of recording stage (water level) changes over time, enabling the automated samplers to collect an array of water samples, and recording the sample history. Rating curves for each location were developed using stage height measurements from each flow meter and comparing them to the nearest upstream United States Geological Survey (USGS) gage flow measurements in cubic-feet-per-second (CFS). These site-specific rating curves were used to determine a stage height increase equivalent to approximately 250 CFS at the Chama river location or 500 CFS at the Rio Grande locations within a one hour time period. After the flow meter identified an appropriate rate-of-change in flow it initiated a sampling program in the automated sampler. When the samplers were initiated a time delay of up to 35 minutes was included in the sampling program in order to collect a sample as near as possible to the peak of a storm surge. After the delay the automated sampler proceeded to fill two 1-liter amber glass bottles and six 1-liter nalgene bottles with river water.

All sampling equipment was thoroughly decontaminated before deployment, new Teflon-lined suction tubing was used and the sampler peristaltic tubing was replaced at the start of the sampling season. The sampler pumped river water through the suction line twice to condition the suction line with river water from the storm flow event prior to filling lab-certified clean bottles.

One amber glass sample was analyzed by AXYS Analytical Services for PCBs using EPA method 1668A HRGC/HRMS, and one amber glass sample was archived as backup and/or dioxin/furan analysis. Two nalgene bottles were submitted to ARS Analytical LLC from which 500 ml was filtered and used for dissolved metal analyses. The remaining 1.5 liters was sent to Desert Research Institute for suspended sediment concentration (SSC) and particle size analysis. Four 1-liter nalgene containers were submitted to ALS Laboratory Group and analyzed for gross alpha/beta, isotopic uranium (U-234, U-235, U-238), isotopic plutonium (Pu-238 and Pu-

239/240), cesium-137, strontium-90, radium-226 and radium-228. The analytical laboratory increased the alpha spectroscopy count times for plutonium measurements from 300 minutes to 1000 minutes in order to improve the detection limits within the range of regional fallout background levels.

Data Quality and Assurance

Level four data quality packages were obtained for all PCB data presented. All PCB results are blank corrected in Excel spreadsheets using procedures described in §17.6.1.4.4 of EPA Method 1668A (EPA 1999). These procedures are used to eliminate potential bias from laboratory influences. Worksheets containing all raw, blank corrected data and all data quality documentation are available upon request.

Nearly all of the detections reported from the locations upstream from and including Buckman Landing and the single baseflow sample collected from the Rio Grande upstream from the Alameda Bridge were “J” flagged results. Values flagged by the laboratory as “J” indicate that the result is greater than the sample detection limit (SDL) but less than the method detection limit (MDL) and are estimated values. The laboratory we used reported PCB congener SDLs ranging from 1 to 2 pg/L and MDLs ranging from 2.5 pg/L to 36.4 pg/L. For calculating total PCB concentration using USEPA Method 1668A or 1668B congener methods, “J” flagged values for individual congeners are to be included in the sum which is used for Assessment (NMED 2010). The NMED does not determine a minimum quantitation limit for total PCB and the total PCB results may include estimated values.

The “J” flagged data from the five storm flow samples collected in the Rio Grande upstream from the Alameda Bridge on average, constituted less than 1% of the total PCB result. These five samples had on average less than 25% of the detected results “J” flagged and the majority (68% to 81%) of the detections were at high enough levels to be considered quantifiable. Any relationships or correlations discussed in this paper for PCBs in the locations upstream from and including Buckman Landing or the baseflow sample collected at the Rio Grande upstream from the Alameda Bridge have a lower level of certainty associated with them. The higher percentage of quantifiable results for the storm flow samples collected at Rio Grande upstream from the Alameda Bridge provide a much higher level of certainty that the correlations and relationships discussed are valid.

All but four cadmium measurements are reported below detection levels. The four detections were “J” flagged by the laboratory, and they are considered estimated values. The cadmium detection levels are adequate to determine that cadmium did not exceed acute aquatic life criteria, but they were inconclusive for determining chronic aquatic life criteria compliance. The 0.4 µg/L detection limit is nearly twice as high as the average chronic criterion of 0.26 µg/L.

All lead results were less than their detection limits but in three instances the detection limit was higher than the sample-specific chronic life criteria.

One sample, collected from the Rio Grande at Buckman Landing on July 19, was inadvertently collected when the sample port and stage sensor line were covered by sand. The data from that sample are presented for completeness but are not representative of baseflow or storm flow

conditions in the Rio Grande and should not be used for assessment or development of correlations.

Duplicate Error Ratio

The Bureau evaluated the validity of duplicate radiochemistry results by using the Duplicate Error Ratio (DER). The DER is defined as:

$$DER = \left(\frac{|S - D|}{2 * \sqrt{\sigma_s^2 + \sigma_D^2}} \right)$$

Where:

|S - D| = is the absolute value of the difference in the result from the sample minus the result of the duplicate:

σ_s^2 = is the square of the sample's sigma

σ_D^2 = is the square of the duplicate's sigma

Four cesium-137 and potassium-40 results and duplicates were evaluated. The results, with their associated uncertainties, are statistically equivalent.

One result for cadmium-109 in the duplicate analysis for Rio Grande upstream from the Alameda Bridge collected on September 11 and one result for scandium-46 in the duplicate analysis for Rio Grande at Buckman on July 4 had a DER > the Warning Limit of 1.42.

The Bureau evaluates the DER at the 2 σ confidence interval. A DER less than or equal to 1.42 indicates that the results, with their associated uncertainties, are statistically equivalent. A DER greater than 1.42 places the results in the 2 σ "warning" range. A DER greater than 2.13 places the results outside the 3 σ control range.

Most gamma spectroscopy values were non-detect with the exception of some tentatively identified isotopes and estimated values.

Data Evaluation

Data results are compared to the applicable water quality criteria for the various reaches of the Rio Grande watershed studied. The uses are designated and defined by the Water Quality Control Commission (WQCC) in 20.6.4 NMAC State of New Mexico Standards for Interstate and Intrastate Surface Waters. Numeric criteria for these uses are found in 20.6.4.900 J NMAC.

The designated uses for the reach of the Rio Grande from Alameda Bridge upstream to the Angostura diversion works (20.6.4.106) are irrigation, marginal warmwater aquatic life, livestock watering, wildlife habitat and secondary contact. The designated uses for the reach of the Rio Grande from the headwaters of Cochiti reservoir upstream to Rio Pueblo de Taos (20.6.4.114) are irrigation, livestock watering, wildlife habitat, marginal coldwater aquatic life,

primary contact and warmwater aquatic life. A public water supply use and criteria for five radionuclides were proposed for reach 20.6.4.114 at the 2009 Triennial Review. The designated uses for the reach of the Rio Chama from its mouth on the Rio Grande upstream to Abiquiu reservoir (20.6.4.116) are irrigation, livestock watering, wildlife habitat, coldwater aquatic life, warmwater aquatic life and secondary contact.

Tables 1 through 7 contain the analytical data obtained for this study. Table 8 outlines former PCB end uses for various Aroclors (commercial mixtures of PCBs). Figures 1-38 identify the sample locations for the study, hydrographs, and sample history used to help evaluate and describe the data. Figures 39 through 41 demonstrate correlations between contaminant concentrations and suspended sediment concentration. Figures 42 through 50 demonstrate PCB homologue distributions, a useful tool for identifying similarities and differences between locations.

Figure 1 shows the Rio Grande and Chama River monitoring locations sampled in this study. The Lyden location on the Rio Grande is approximately 4.4 miles upstream from the confluence with the Chama River. The Chama River at Chamita location is 2.9 miles upstream from the confluence with the Rio Grande. The Otowi Bridge location is 14.9 miles downstream from the Chama River confluence and Buckman Landing is 3.2 miles further downstream. The Rio Grande above Alameda location is 56 miles downstream from Buckman Landing, and it is located 1.3 miles upstream from the Alameda Bridge.

Figure 1a depicts the location of the sampler at Rio Grande above Alameda. The sampler is located in the Rio Grande, one third of a mile downstream from the North Diversion Channel and the Rio Grande confluence and approximately 1.3 miles upstream from the Alameda Bridge. The intake structure for the Albuquerque Bernalillo County Water Utility Authority San Juan-Chama Drinking Water Project is located approximately 1/4 mile downstream from the Alameda Bridge and approximately 1.5 miles downstream from the sampler location. The original sampler location was at the intake structure and was moved upstream to this location after we found that the automatic adjusting dam structure at the intake prevented our sampler from detecting storm surge flows. In addition, our sampler spuriously tripped repeatedly due to regular fluctuations in river level caused by the adjusting dam.

The USGS manages discharge measurement stations (gages) at the North Diversion Channel (NDC) and along the Rio Grande near Alameda, San Felipe, Otowi Bridge, Embudo, and the Rio Chama near Chamita. Flow measurements from each gage are presented in Figures 2 – 38 for each sampling event. The figures include relevant hydrographs from USGS gages and the ISCO flow meter chart strips associated with each sampling location and event, including notation indicating the time of sample collection. For the Rio Grande upstream from the Alameda Bridge sampling location, the flow measurements from the San Felipe gage station are included even though it is located approximately 22 miles upstream from the sampling location. This is the nearest upstream gage on the Rio Grande to that location. It demonstrates potential influences from Cochiti Reservoir releases, and it does not incorporate potential storm flows from Bernalillo, Corrales, or the Jemez River.

All Buckman landing hydrographs were generated using Otowi Gage discharge data and applying travel time corrections that ranged from 35 minutes to 49 minutes. Travel time was estimated by measuring the time of peak flow at both the Otowi Gage and the Buckman landing flow meter. Travel time averaged 44 minutes with the highest discharges resulting in the shortest travel times. The Buckman landing hydrographs assume no head loss into the stream bed over the \approx 3 mile distance and no input from Pajarito Plateau streams (i.e., Los Alamos Canyon). Review of provisional flow data from the E110 gage in lower Los Alamos Canyon (McInroy 2010) show that Los Alamos Canyon flowed only once from April through September 2009. That flow was for 1 hour and 20 minutes on July 31, 2009 and peak flow was 5.5 CFS. The sampler at Buckman Landing collected a sample on July 30, 2009 and did not detect a storm flow event on July 31, 2009.

Results

PCB Introduction

PCBs are mixtures of synthetic organic chemicals with the same basic chemical structure and similar physical properties that range from oily liquids to waxy solids. No known natural sources of PCBs exist. Because they are non-flammable with properties of chemical stability, high boiling point, and electrical insulation, PCBs were used in hundreds of industrial and commercial applications. Prior to 1974, PCBs were used both for nominally closed applications (e.g., capacitor and transformers, and heat transfer and hydraulic fluids) and in open-end applications (e.g., flame retardants, inks, adhesives, microencapsulation of dyes for carbonless duplicating paper, paints, pesticide extenders, plasticizers, polyolefin catalyst carriers, slide-mounting mediums for microscopes, surface coatings, wire insulators, and metal coatings) (see ASTDR 2000). While the production of PCBs was banned in 1979 there are many PCB containing applications still in use which can become source terms for PCB in the environment. Aroclors were commercial mixtures of PCBs which were best suited for various commercial uses. Table 8 shows former PCB end uses for various Aroclors (adapted from ASTDR 2000). These may be useful for focusing on potential source terms for PCBs found in sediments or storm water investigations.

Total PCB

Analytical results for total (unfiltered) PCBs are found in Table 1. Total PCB concentrations were below the WQCC human health criteria of 640 pg/L in all thirteen samples collected at the locations upstream from and including Buckman Landing. Results for these 13 samples ranged from 2 pg/L to 443 pg/L.

Total PCB concentrations exceeded both the human health criteria and the wildlife habitat criteria of 14,000 pg/L in five of the six samples collected from the Rio Grande upstream from the Alameda Bridge station. The single sample from this location that did not exceed either criterion was a non-storm flow sample collected to determine baseflow conditions in the Rio Grande. Results from these six water samples ranged from 87 pg/L to 389,954 pg/L and had average and median concentrations of 142,696 pg/L and 88,936 pg/L respectively.

Aroclor Equivalent Evaluation

Aroclor equivalents were calculated based on the PCB congeners detected in the five Rio Grande above Alameda storm flow samples and are displayed in Table 1. The calculations for Aroclor

equivalents are performed using algorithms provided to NMED by AXYS Laboratory. In the storm flow samples from the Rio Grande location upstream from the Alameda Bridge, Aroclor 1248, Aroclor 1254, and Aroclor 1260 comprise from 97% to 99% of all PCBs found. Aroclor 1260 provides from 73% to 82 % of the total PCB load at that location.

PCB Homologue Evaluation

There are 209 possible PCB compounds called congeners. The PCBs can also be categorized by degree of chlorination. The term “homologue” is used to refer to all PCBs with the same number of chlorines (e.g., trichlorobiphenyls have 3 chlorine atoms). There are ten possible homologue groups (monochlorobiphenyl to decachlorobiphenyl). These homologue patterns can be used to evaluate samples from different locations for similarities or differences without the confounding issue of relative concentration differences. Various source terms may have unique fingerprints based on their homologue patterns and may be ruled out or implicated as contributing factors in the PCB loading of a waterbody.

PCB homologue patterns from locations upstream from and including Buckman Landing samples (Figures 42, 43, 44, and 46) show a preponderance of lower-chlorinated congeners and in general, a bi-modal distribution, while homologue patterns for Rio Grande above Alameda (Figures 45 and 47) are dominated by higher-chlorinated congeners. Generally, the Rio Grande at Buckman Landing samples show an increase in the percentage of higher-chlorinated congeners when compared to those samples collected at Otowi Bridge (Figure 43 and Figure 44). The baseflow sample collected at Rio Grande above Alameda (July 10) shows a slight contribution from lower-chlorinated congeners but this disappears under storm flow conditions (Figure 45). These homologue pattern distributions suggest that the PCBs found at Rio Grande above Alameda are from a different source than those found upstream of Cochiti Reservoir.

PCB and Suspended Sediment Correlation

PCBs are hydrophobic (meaning “water fearing”). These kinds of chemicals do not readily dissolve in water but instead adsorb to sediment (USGS 2002) and organic materials and become suspended in the water column during high flow events. These chemical contaminants move downstream with the sediments to which they’ve bonded. The fine grained sediment containing the greatest amount of organic material tends to have the highest contaminant levels (ATSDR 2006).

Measurements of PCB concentrations in the stormwater and base flow samples and the calculation of PCB concentrations in the suspended sediments are listed in Table 1. Total PCB concentrations in suspended sediment (pg/g) is calculated by dividing the total PCB measurements in water (pg/L) by the suspended sediment concentrations (g/L) and are found in Table 1. Calculating PCB concentrations in suspended sediments is an important tool to answer source identification questions because the calculation eliminates the variability in water column measurements due to variable suspended sediment concentrations. We compared the mean values of the five storm flow samples from the Rio Grande above Alameda to the twelve other storm flow samples collected in this study. From the upstream data set, we generated a reference value of 225 pg/g total PCB based on the mean plus 2 standard deviations of the data set for PCB in suspended sediment. This reference value represents the largest probable value, at a 95% confidence level, for PCB in suspended sediments found in storm flow for all the sites located upstream from and including Buckman Landing. The mean concentration of total PCB in

suspended sediment (calculated) of the five storm flow samples from the Rio Grande above Alameda from this study is 93,184 pg/g or over 400 times higher than the suspended sediment reference value.

Figure 50 shows that the median and range of the total PCB in suspended sediment concentration generally increased across downstream stations. Median suspended sediment concentrations were comparable in the Chama River at Chamita (26 pg/g), the Rio Grande at Otowi (30 pg/g) and the Rio Grande at Buckman (33 pg/g). In contrast, the median concentration of suspended sediment PCBs in the Rio Grande above Alameda was three orders of magnitude higher (78,128 pg/g). That difference is substantially greater than the variability among the upper stations, as indicated by the range of their values. These comparisons suggest that the PCB levels in suspended sediment from storm flow samples collected from the Rio Grande above Alameda location are not representative of suspended sediments in the Rio Grande at sites located upstream from and including Buckman Landing collected in this study.

We also compared the suspended sediment PCB values in Rio Grande above Alameda storm flow samples to the values found in sediment deposits from the Rio Grande collected during a 2002 – 2003 LANL and NMED Cooperative PCB study (unpublished data). In that study, sediment samples were collected from six locations along the Rio Grande from Embudo south to Albuquerque. Locations included Rio Grande at Embudo, Otowi Bridge, near White Rock (below Ancho Canyon), Peña Blanca, Angostura Diversion, and below Albuquerque (upstream of I-25). These sediment samples were collected with bias towards the finest grained sediments available at each location. One additional sample of sediments from the Rio Grande at Angostura Diversion was collected by the Surface Water Quality Bureau (SWQB) in 2005 (unpublished data) and is included in the assessment illustrated in Figure 49. Using only data from upstream of the Rio Grande above Alameda location, we generated a reference value of 1,035 pg/g total PCB based on the mean plus 2 standard deviations of the data set for the upstream sediments in the Rio Grande. This reference value represents the largest probable value, at a 95% confidence level, for PCB in sediments for the data set from the upstream locations in the Rio Grande. The mean concentration of total PCB in suspended sediment (calculated) of the five storm flow samples from the Rio Grande above Alameda from this study is 93,184 pg/g which is 90 times the generated reference value. This also suggests that the PCB levels in suspended sediment from storm flow samples collected from the Rio Grande above Alameda are not representative of Rio Grande sediments previously collected.

It should also be noted that the baseflow sample of the Rio Grande above Alameda had a suspended sediment PCB concentration that exceeded all upstream storm flow samples with the exception that it was comparable to the 7/30/09 Buckman storm flow sample. It also contains higher percentages of heavier chlorinated homologues and is similar to the PCB patterns found in storm flows at the same location. This suggests that baseflow transport of suspended sediment PCBs could also be significant for the Rio Grande upstream of the Alameda Bridge.

We also compared the PCB homologue patterns in suspended sediment from storm flow samples collected from the Rio Grande above Alameda to PCB homologue patterns found in fish tissue samples collected by SWQB in 2007 and 2008 (unpublished data). Figure 48 shows a similar homologue pattern in fish tissue and the suspended sediments found in storm flow.

Dissolved Metals

Samples for dissolved metals were filtered by the analytical laboratory. Dissolved (filtered) metal results are provided in Table 2. WQCC aquatic life criteria for cadmium, chromium, copper, lead, nickel, silver, and zinc are sample specific and depend on water hardness. All hardness dependent acute aquatic life criteria were calculated based on the hardness value derived from the dissolved calcium and magnesium concentration of each sample. Calculated sample-specific hardness values are also presented in Table 2.

All analytical results for dissolved metals are below the sample-specific acute aquatic life criteria.

Comparisons to the chronic criteria were only conducted on the single base flow sample (July 10) collected from the Rio Grande above Alameda because the chronic criteria only apply during stable hydrological conditions (NMED, 2009c). The cadmium result of 0.99 µg/L in that sample was greater than the chronic aquatic life criteria 0.23 µg/L. However, it should be noted that the result is “J” flagged, is greater than the detection limit, and is considered an estimated value by the analytical laboratory.

All lead, mercury, selenium and silver values were below their detection limits.

The Rio Grande above Alameda 9/11/09 sample had elevated metals compared with all other samples (Cr, Fe, Mn and Ni). The SSC was relatively low (513 mg/L), it was the third lowest in the study data set, and flows from the NDC were moderate (900CFS) during this event. Dissolved iron and manganese can be indicators of water flushed out of areas with low redox potential (e.g. wetlands, marshes). This may be associated with the anoxic conditions found in the embayment area of the NDC prior to the confluence with the Rio Grande. Also, the observed levels of chromium and nickel could suggest anthropogenic sources near Albuquerque. Further investigations should consider the potential of elevated metals at this location.

Radionuclides

Radionuclide analyses were run on nineteen samples, eighteen storm flow and one baseflow samples and are found in Table 3 and Table 4. Gross alpha results have been adjusted by subtracting all uranium and plutonium measurements as described in 20.6.4.7 B NMAC. Adjusted gross alpha results exceeded the livestock watering criterion of 15 pCi/L once at each of the following locations: Rio Chama at Chamita (39 pCi/L), Rio Grande at Otowi (24 pCi/L), Rio Grande at Buckman (18 pCi/L), and three times at Rio Grande above Alameda (33 pCi/L, 32 pCi/L, and 21 pCi/L).

Gross beta results range from 4.5 pCi/L to 60 pCi/L. The highest measurement for gross beta was found at Rio Grande above Alameda (60 pCi/L), followed by Rio Chama at Chamita (59 pCi/L), then Rio Grande above Alameda (56 pCi/L), Rio Grande at Otowi (45 pCi/L), and the Rio Grande at Buckman Landing (39 pCi/L). There is no surface water quality criterion for beta photon activity.

Uranium-234 was detected in each sample and ranged from 0.57 pCi/L to 2.5 pCi/L. Uranium-235 was detected in eight of fourteen samples and ranged from 0.14 pCi/L to 0.47 pCi/L. Uranium-238 was detected in each sample and ranged from 0.32 pCi/L to 2.3 pCi/L. The uranium-238 and uranium-234 ratios are similar (nearly 1:1). The uranium criterion for livestock watering is 5,000 pCi/L.

Plutonium-238 was detected in one sample from Rio Chama at Chamita at 0.0052 pCi/L. The result is very near the minimum detectable activity and less than two sigma and could be a false positive. Sigma is a statistical measure of uncertainty associated with each measurement. Normally, two sigma is used to reflect a 95% confidence interval around the reported value, sometimes three sigma is used to define a much greater confidence interval of 99.9%.

Plutonium-239/240 was detected in seven of the nineteen samples analyzed. Five samples are considered true detections as their activity was greater than the minimum detectable activity and also greater than three sigma. They are from single events at Rio Chama at Chamita (0.05 pCi/L) and Rio Grande at Otowi (0.033 pCi/L), and from three events at Rio Grande above Alameda (0.035 pCi/L, 0.015 pCi/L, and 0.013 pCi/L). The other two detections, Rio Grande at Buckman (0.015 pCi/L), Rio Grande above Alameda (0.011 pCi/L) could be false positives as the results are greater than the minimum detectable activity but only slightly greater than two sigma. There is no current criterion for plutonium-239/240. However, all detections for plutonium-239/240 are well below the proposed criterion of 1.5 pCi/L for public water supply on the main stem Rio Grande (reach 20.6.4.114). The highest value for plutonium-239/240 found was 30 times less than the proposed criterion.

Plutonium concentration in water is strongly correlated to SSC (Englert, et. al. 2004) and it usually binds to sediment, particularly fine grained particles. Plutonium-239/240 values in suspended sediment (pCi/g) are calculated by dividing the plutonium measurements in water (pCi/L) by the suspended sediment concentrations (g/L) and are found in Table 4. We compared those calculated values to the plutonium-239/240 background reference of 0.02 pCi/g for reservoir sediments, from McLin and Lyons, 2002. We chose this reference value as the most representative matrix to compare to suspended sediments in storm flow due to the high percentage of fine sediment particle sizes in reservoir sediment.

This comparison indicates the calculated plutonium-239/240 concentrations in suspended sediment from the sample collected at Alameda on September 11 is larger than the reference value. The calculated value of 0.025 pCi/g for the Alameda samples is near the 0.02 pCi/g reference. We suspect that the analytical uncertainty is also propagated by combining the two analyses, the plutonium and suspended sediment measurements each containing its own degree of uncertainty, in a calculation. Our conclusion is that the plutonium measurements in the Rio Grande storm flow samples are indistinguishable from plutonium in sediments originating from integrated world-wide atmospheric fallout.

Cesium-137 and strontium-90 measurements are below their sample specific minimum detectable activities. There are no criteria for cesium-137 or strontium-90 for any of the designated uses in these reaches though a criterion for cesium-137 was proposed by NMED at the 2009 Triennial Review.

Radium-226 + radium-228 are highest in the July 21 sample from Rio Grande at Alameda at 8.3 pCi/L followed by the July 22 sample from the Rio Grande at Otowi (2.7 pCi/L) and the June 26 sample from Rio Chama at Chamita (2.6 pCi/L). The remaining values range from non-detects to 1.8 pCi/L. Radium-226 + radium-228 values did not exceed the applicable 30 pCi/L livestock watering criterion.

Suspended Sediment Concentration and Particle Size Determinations

Suspended sediment concentration and particle size data are presented in Table 5 through Table 7. We use suspended sediment concentration and particle size determinations to evaluate whole water samples for relationships. Suspended sediment concentration has been shown to be positively correlated to contaminant concentration in unfiltered water samples. This has been demonstrated for plutonium-239/240 (Englert, et. al., 2004) and it appears to be true (this study) for gross alpha and PCBs.

We tested whether a relationship existed between suspended sediments, PCBs, and other contaminants by creating Excel scatter plots. These plots compared pairs of SSC and contaminant concentrations, and developed R^2 values and equations that described the relationships. The square root of R^2 is the linear correlation coefficient r . The linear correlation coefficient r (or Pearson product moment correlation coefficient) measures the strength of the linear relationship between paired x and y values in a sample (Triola 1999). Figure 39 through 41 are examples of these comparisons.

In the case of Figure 39, the x and y are the concentrations of suspended sediments and total PCBs measured in six samples from the Rio Grande at Alameda. An R^2 value of 0.8442 or linear correlation coefficient r value of 0.919 was derived. The r value is greater than the critical value 0.917 for a significance level 0.01 for $n = 6$ (found in Table A-6. Critical Values of the Pearson Correlation Coefficient r , page 724 in Triola 1999) indicating a significant correlation at a 99% confidence level. A strong correlation exists suggesting that the equation (Total PCBs = $167.38 * (\text{SSC}) - 80581$) could be used to predict the concentration of one parameter if the other is known, i.e. total PCB concentration of a sample from similar circumstance could be predicted if the SSC is known.

Comparisons of PCB concentrations and SSC from upstream Rio Grande and Chama stations demonstrated a lack of correlation. PCB measurements were very low and suggest the relative analytical and sampling uncertainty overwhelmed any potential correlation or that source terms were ubiquitous.

Further comparisons are demonstrated in Figures 40 and 41 for SSC and gross alpha. Figure 40 identifies the correlation between SSC and gross alpha for all samples collected. It demonstrates a poor correlation, $R^2 = 0.0349$ or $r = 0.1868$, much less than a critical value 0.468 for $n=18$ and a 0.05 confidence level. The poor correlation is due to a single influential outlier that has an unusually low gross alpha measurement relative to its paired SSC value.

In the case described by Figure 40, it appears that a correlation may exist except for one pair of SSC and gross alpha measurements. Upon further examination of the particle size determinations, we found this sample contained a much larger content of sand than all the others.

It contained 91% sand relative to an average 21% for all other samples. Alternatively, this sample contained only 8.8% silt and clay relative to an average 78% for the remaining samples.

In addition, the strip chart from the flow meter indicates an oscillating stage height which indicates plugging of the sensor line. We suggest there was a sampling inconsistency associated with the sample. The sampling inlet most likely had been temporarily covered by sand during collection and did not produce a representative sample of the water column. The sampling port is fixed along the bank and the river stage is dynamic. During periods of low flow, the river stage recedes and drops new sediments in the river channel, in this case temporarily covering our sample inlet.

Removing this outlier pair and re-evaluating the remaining set of samples in Figure 41, the correlation coefficient r increases to 0.8134 ($R^2=0.6913$). The r value is larger than the critical value 0.606 for $n=17$ (the remaining number of samples) and a 0.01 confidence level. This demonstrates a significant correlation of SSC to gross alpha at 99% confidence, and that relatively large grained sand particles are not as effective as silts and clays in transporting gross alpha contaminant loads.

Summary

This study focused on collecting water samples from the Rio Grande at locations that would provide insight to water quality upstream from the proposed Buckman Direct Diversion project and the Albuquerque Bernalillo County Water Utility Authority San Juan-Chama Drinking Water Project during wet weather events. Storm flows were expected to produce the highest levels of suspended sediment and subsequently the highest levels of contaminants for those constituents that commonly bind to sediment particles (e.g., radionuclides, PCBs). Constituents typically found in storm water discharges from Los Alamos Canyon at LANL were targeted to determine if past or current discharges from the Laboratory are detectable in the Rio Grande during storm flow events. There were no concurrent discharges from Los Alamos Canyon during the sampling dates evaluated. The data suggest:

1. The data evaluated does not indicate an influence from past LANL discharges on current water quality conditions near drinking water diversions;
2. The data were not sufficient to answer the same question about current LANL discharges because Los Alamos Canyon was not discharging at the time the upstream or downstream samples were collected in the Rio Grande;
3. NMED proposes to further explore the question of current discharges by evaluating samples collected while Los Alamos Canyon was discharging (10/13/09) when that data set is available. The NMED will continue to evaluate ongoing monitoring efforts.
4. Adjusted gross alpha results exceeded the livestock watering criterion of 15 pCi/L once at each of the following locations: Rio Chama at Chamita (39 pCi/L), Rio Grande at Otowi (24 pCi/L), Rio Grande at Buckman (18 pCi/L). The criterion was exceeded three times at Rio Grande location upstream from the Alameda Bridge (33 pCi/L, 32 pCi/L, and 21 pCi/L).
5. There is a significant positive correlation of SSC to gross alpha activity indicating that SSC and gross alpha activity will increase or decrease proportionally.

6. Plutonium-239/240 was detected in seven water samples but the highest value found was 30 times less than the proposed water quality criteria. Evaluation of the plutonium-239/240 levels in the suspended sediments show they are indistinguishable from plutonium originating from integrated world-wide atmospheric fallout. There were no detections of cesium-137 and strontium-90.
7. Concentrations of dissolved metals remained below their respective acute aquatic life criteria in all samples.

Evaluations of the concentrations of total PCB and homologue distributions of PCBs found in the Rio Grande upstream of the Alameda Bridge generated the following observations:

1. Total PCB exceeded the PCB human health and wildlife habitat water quality criteria five times at Rio Grande above Alameda;
2. The median concentrations of PCB in suspended sediment from storm flow samples collected from the Rio Grande above Alameda are not representative of those found in the Rio Grande above Buckman Landing collected in this study and are two to three orders of magnitude greater;
3. The concentration of PCB in suspended sediment from storm flow samples collected from the Rio Grande above Alameda are not representative of upstream Rio Grande channel sediments sampled in previously studies (unpublished data);
4. The PCB homologue patterns found at Rio Grande above Alameda suggest that the PCBs found there are from a different source than those found upstream of Buckman Landing
5. The PCB homologue patterns found at Rio Grande above Alameda (this study) are similar to those previously collected downstream of Albuquerque (unpublished data)
6. The PCB homologue patterns found at Rio Grande above Alameda are similar to those found in fish tissue samples collected from the Rio Grande near Albuquerque.
7. There is a positive correlation between total PCB and SSC at the Rio Grande above Alameda sampling location suggesting that the concentration of total PCBs may be predictable for this location if the SSC is known.
8. Additional PCB source investigations in the Albuquerque area may be needed.

Recommendations

Data from samples collected while Los Alamos Canyon was discharging (10/13/09), may provide additional insight into LANL's role in Rio Grande water quality and will be provided along with dioxin/furan data in a supplement to this report when available.

1. Additional sampling of storm flow events along the Rio Grande is recommended, especially when Los Alamos Canyon flows are reaching the Rio Grande to determine LANL's influence (if any) on Rio Grande wet weather water quality.
2. As additional PCB source investigations are conducted, potential source areas such as industrial areas, natural gas transmission lines, rail lines, power generation facilities and power transformers along electrical transmission lines should be considered.

Acknowledgements

We would like to thank those who helped make this study possible. We would like to thank Kathleen Ramsay of Espanola and Elmer Salazar of Lyden for permission to deploy samplers on

their properties. We would also like to thank San Ildefonso Pueblo for allowing us to set a sampler along the Rio Grande near Otowi Bridge and the City of Albuquerque Open Space Program for allowing us to set a sampler in the Rio Grande Valley State Park near Alameda. Thanks also to Phil Bowman, hydrologist with the USGS New Mexico Water Science Center for his assistance in obtaining USGS gage discharge measurements. Thanks also to Los Alamos National Laboratory for their careful review and constructive criticisms of this report.

References

(Where possible, an internet address is provided for the actual reference.)

Agency for Toxic Substances and Disease Registry (ATSDR, 2000). Toxicological Profile for Polychlorinated Biphenyls (PCBs) November 2000 <http://www.atsdr.cdc.gov/toxprofiles/tp17.html>

Agency for Toxic Substances and Disease Registry (ATSDR, 2006). ATSDR Public Health Assessment for PCB Contaminated Sediment In The Lower Fox River And Green Bay Northeastern Wisconsin EPA FACILITY ID: WI0001954841 MARCH 14, 2006
http://www.atsdr.cdc.gov/hac/PHA/FoxRiver/PCBinFoxRiver_GreenBayPHA031406.pdf

Englert, D., Ford-Schmid, R., and Bransford, K., 2004. Post Cerro Grande Fire Channel Morphology in Lower Pueblo Canyon, Reach P-4 West: and Storm Water Transport of Plutonium 239/240 in Suspended Sediments, Los Alamos County, New Mexico, 122 p.
<ftp://ftp.nmenv.state.nm.us/www/doe/publications/lanl/2004PostFireP4West.pdf>

EPA 1999. "Method 1668, Revision A: Chlorinated Biphenyl Congeners in Water, Soil, Sediment, and Tissue by HRGC/HRMS" EPA No. EPA-821-R-00-002 December 1999 112p.

McInroy, D., J., 2010. Letter to Steve Yanicak, Staff Manager/POC, DOE Oversight Bureau. "Five Minute Surface Water Stage and Flow Data from Gage Stations E050, E060, and E110, Water Year 2009. EP2010-0090

McLin, S. G., and Lyons, D. W., 2002, Background radioactivity in rivers and reservoir sediments near Los Alamos, New Mexico: Los Alamos National Laboratory, Report LA-13603-MS, 99 p.

New Mexico Environment Department (NMED 2006) Quality Assurance Project Plan for Surface Water Monitoring Programs, DOE Oversight Bureau, Revision 1. 72 p.
http://www.nmenv.state.nm.us/doe_oversight/documents/SurfaceWaterQAPP2006_000.pdf

New Mexico Environment Department (NMED 2009) Quality Assurance Project Plan for Environmental Monitoring Programs. DOE Oversight Bureau, Revision 4-30-09, 135 p.
http://www.nmenv.state.nm.us/doe_oversight/documents/QAPPDOEOBGeneralDataAcquisitionv4-30-09_000.pdf

New Mexico Environment Department (NMED 2009a) Sample and Analysis Plan for the Regional Storm Water PCB Project, Upper Rio Grande Watershed, New Mexico. Version 2 May, 2009, 71 p.

New Mexico Environment Department (NMED, 2009c). Procedures for Assessing Water Quality Standards Attainment for the State of New Mexico CWA §303(d) / §305(b) Integrated Report: Assessment Protocol, 35 p.
<ftp://ftp.nmenv.state.nm.us/www/swqb/MAS/Protocols/AssessmentProtocol.pdf>

Triola, M., 1999. Elementary Statistics 7th Edition, Addison Wesley Longman, Inc., 791 p.

U. S. Geological Survey (USGS, 2002). Occurrence of Polychlorinated Biphenyls (PCBs) on Suspended Sediment in the Donna Canal, Hidalgo County, Texas, 1999–2001 USGS Fact Sheet 016-2 April 2002
http://pubs.usgs.gov/fs/fs01602/pdf/FS_016-02.pdf

Table 1. Total PCB, Homologue, SSC and Calculated Total PCB in Suspended Sediment Results in Storm Flow from the Rio Grande and Chama River 2009

Sample Location	Sample Type		Date	Time	Homologue Totals																
	(S) Storm Water, (B) Base flow	Date			Time	Total PCB (sum of congeners)	SSC	Total PCB in Suspended Sediment (Calculated)	Mono-Cl	Di-Cl	Tri-Cl	TE-Cl	Pe-Cl	Hx-Cl	Hp-Cl	Oc-Cl	No-Cl	De-Cl	Aroclor 1248 Equivalent	Aroclor 1254 Equivalent	Aroclor 1260 Equivalent
Rio Chama at Chamita	S	6/26/2009	20:05	109	4,257	26	0	2	17	61	4	6	5	12	1	0					
Rio Chama at Chamita	S	7/13/2009	18:11	99	946	105	0	4	21	65	0	2	4	4	0	0					
Rio Chama at Chamita	S	7/21/2009	20:11	5	1,040	5	0	0	0	4	0	0	0	1	0	0					
Rio Grande at Lyden	S	9/13/2009	3:14	2	405	4	0	0	0	1	1	0	0	0	0	0					
Rio Grande at Otowi	S	6/26/2009	23:45	243	1,912	127	12	45	88	14	25	33	17	8	0	2					
Rio Grande at Otowi	S	7/4/2009	17:36	7	410	17	0	0	3	2	1	1	1	0	0	0					
Rio Grande at Otowi	S	7/22/2009	0:07	70	1,911	37	2	7	24	10	10	10	6	1	0	0					
Rio Grande at Otowi	S	8/13/2009	18:23	45	1,896	24	0	0	10	2	3	14	11	3	0	1					
Rio Grande at Buckman	S	6/27/2009	0:34	68	1,361	50	0	4	21	3	1	20	14	3	0	2					
Rio Grande at Buckman	S	7/4/2009	18:18	7	534	13	0	0	1	0	0	1	3	1	0	0					
Rio Grande at Buckman	S	7/30/2009	14:54	443	1,523	291	0	25	71	63	97	129	50	6	2	0					
Rio Grande at Buckman	S	8/13/2009	19:09	23	1,393	16	0	0	8	0	2	8	2	0	1	1					
Rio Grande above Alameda	B	7/10/2009	14:30	87	347	252	0	6	13	3	1	31	30	4	0	0					
Rio Grande above Alameda	S	7/21/2009	19:42	389,954	2,407	162,031	49	2,036	2,933	9,566	43,138	167,688	133,680	28,667	1,869	328	5	12	81		
Rio Grande above Alameda	S	9/9/2009	22:42	79,697	1,020	78,128	10	409	387	1,282	7,292	39,420	24,567	5,854	427	49	4	12	82		
Rio Grande above Alameda	S	9/11/2009	20:24	43,742	513	85,312	13	401	449	1,401	5,565	18,503	13,695	3,406	275	34	6	14	76		
Rio Grande above Alameda	S	9/16/2009	23:15	111,149	1,645	67,587	11	589	654	2,239	11,970	52,179	35,782	7,219	462	43	4	13	80		
Rio Grande above Alameda	S	9/17/2009	11:50	88,936	1,221	72,864	5	533	825	2,649	11,724	40,297	26,824	5,614	413	51	6	17	73		

Table 1a Non-representative Data

Sample Location	Sample Type	Date	Time	Homologue Totals																
				Total PCB (sum of congeners)	SSC	Total PCB in Suspended Sediment (Calculated)	Mono-Cl	Di-Cl	Tri-Cl	TE-Cl	Pe-Cl	Hx-Cl	Hp-Cl	Oc-Cl	No-Cl	De-Cl				
																	pg/L	mg/L	pg/g	pg/L
Rio Grande at Buckman	Equipment Malfunction	7/19/2009	23:46	7	7,544	1	0	0	5	0	0	0	0	0	0	0	0	0	0	1

Table 2. Dissolved Metals Results in Storm Flow from the Rio Grande and Chama River 2009

Sample Location	Sample Type (S) Storm Water, (B) Base Flow	Date	Time	Ag	Al	As	B	Ba	Be	Ca	Cd	Co	Cr	Cu	Fe	K	Mg	Mn	Na	Ni	Pb	Sb	Se	Si	Tl	V	Zn	Hg	Hardness (Calculated)	
Units				ug/L	ug/L	ug/L	ug/L	ug/L	ug/L	ug/L	ug/L	ug/L	ug/L	ug/L	ug/L	ug/L	ug/L	ug/L	ug/L	ug/L	ug/L	ug/L	ug/L	ug/L	ug/L	ug/L	ug/L	ug/L	ug/L	mg/L
Rio Chama at Chamita	S	6/26/2009	20:05	0.72 U	15.8 U	4.43 U		97.5	0.39 J	46,100	0.43 U	0.49 J	0.54 J	2.07 U	9.65 U	2,170	6,010	0.34 U	12,400	0.71 U	1.83 U	3.37 U	5.61 U		2.6 U	7.42	1.23 U	0.05 U	140	
Rio Chama at Chamita	S	7/13/2009	18:11	0.72 U	15.8 U	4.43 U		65.4	0.45 J	39,600	0.44 J	0.79 J	0.5 U	2.07 U	9.65 U	1,940	5,400	0.34 U	10,700	0.71 U	1.83 U	3.37 U	5.61 U		2.6 U	5.56	1.23 U	0.05 U	121	
Rio Chama at Chamita	S	7/21/2009	20:11	0.72 U	15.8 U	4.43 U		55.3	0.41 J	34,300	0.43 U	0.41 J	0.5 U	2.07 U	9.65 U	1,650	5,130	0.34 U	10,100	0.71 U	1.83 U	3.37 U	5.61 U		2.6 U	5.6	1.23 U	0.05 U	107	
Rio Grande at Lyden	S	9/13/2009	3:14	0.72 U	15.8 U	4.43 U	43.8	40.6 E	0.39 J	33,400	0.43 U	0.25 U	1.18 J	2.07 U	29.2 J	3,180	7,340	2.61	25,200	0.71 U	1.83 U	3.37 U	5.61 U	11,800	2.6 U	8.62	6.07 J	0.05 U	114	
Rio Grande at Otowi	S	6/26/2009	23:45	0.72 U	15.8 U	4.43 U		113	0.39 J	50,000	0.43 U	1.66 J	0.5 U	2.07 U	9.65 U	3,030	7,410	0.34 U	18,600	0.71 U	1.83 U	3.37 U	5.61 U		2.6 U	7.85	1.23 U	0.05 U	155	
Rio Grande at Otowi	S	7/4/2009	17:36	0.72 U	15.8 U	10.2		49.7	0.35 J	34,600	0.43 U	0.86 J	0.5 U	2.07 U	9.65 U	2,960	6,210	0.34 U	17,500	0.71 U	1.83 U	3.37 U	5.61 U		2.6 U	5.68	1.23 U	0.05 U	112	
Rio Grande at Otowi	S	7/22/2009	0:07	0.72 U	15.8 U	4.43 U		64.3	0.36 J	38,400	0.67 J	1.2 J	0.5 U	2.07 U	9.65 U	2,270	6,500	0.34 U	15,700	0.71 U	1.83 U	3.37 U	5.61 U		2.6 U	7.56	1.23 U	0.05 U	123	
Rio Grande at Otowi	S	8/13/2009	18:23	0.72 U	40.2 J	4.43 U		68.3	0.42 J	36,300	0.43 U	1.08 J	0.5 U	2.07 U	40.4 J	2,120	5,800	7.59 U	13,400	0.71 U	1.83 U	3.37 U	5.61 U		2.6 U	7.27	11.3	0.05 U	114	
Rio Grande at Buckman	S	6/27/2009	0:34	0.72 U	15.8 U	4.43 U		80.3	0.4 J	36,800	0.43 U	1.37 J	0.5 U	2.07 U	9.65 U	2,650	6,410	0.34 U	16,400	0.71 U	1.83 U	3.37 U	5.61 U		2.6 U	6.23	1.23 U	0.05 U	118	
Rio Grande at Buckman	S	7/4/2009	18:18	0.72 U	15.8 U	4.43 U		46.2	0.43 J	33,700	0.43 U	1.25 J	0.5 U	2.07 U	9.65 U	2,720	6,080	0.34 U	17,400	1.07 J	1.83 U	3.37 U	5.61 U		2.6 U	6.77	8.14 J	0.05 U	109	
Rio Grande at Buckman	S	7/30/2009	14:54	0.72 U	15.8 U	4.43 U		73.90	0.35 J	38,200	0.54 J	0.86 U	0.50 U	2.07 U	9.65 U	2,460	5,550	0.34 U	14,600	0.71 U	1.83 U	3.37 U	5.61 U		2.60 U	6.54	1.23 U	0.05 U	118	
Rio Grande at Buckman	S	8/13/2009	19:09	0.72 U	15.8 U	4.43 U		64	0.37 J	34,700	0.43 U	1.47 J	0.5 U	2.07 U	9.65 U	2,110	5,510	0.34 U	12,700	0.71 U	1.83 U	3.37 U	5.61 U		2.6 U	6.34	1.23 U	0.05 U	109	
Rio Grande above Alameda	B	7/10/2009	14:30	0.72 U	15.8 U	4.43 U		61.5	0.34 J	35,800	0.99 J	1.29 J	0.5 U	2.07 U	9.65 U	3,300	6,820	0.34 U	20,800	0.71 U	1.83 U	3.37 U	5.61 U		2.6 U	8.61	1.23	0.05 U	117	
Rio Grande above Alameda	S	7/21/2009	19:42	0.72 U	15.8 U	4.43 U		78.2	0.4 J	38,600	0.64 J	1.6 J	0.5 U	2.07 U	9.65 U	2,370	1,870	0.34 U	2,920	0.71 U	1.83 U	3.37 U	5.61 U		2.6 U	1.1 U	1.23 U	0.05 U	104	
Rio Grande above Alameda	S	9/9/2009	22:42	0.72 U	40.4 J	4.43 U	26.2	48.4	0.4 J	22,600	0.43 U	0.25 U	0.5 U	2.07 U	83.4 J	2,770	1,680	22.5	4,920	0.71 U	1.83 U	3.37 U	5.61 U	2,270	2.6 U	3.52 J	10.9	0.05 U	63	
Rio Grande above Alameda	S	9/11/2009	20:24	0.72 U	15.8 U	4.43 U	29.5	55.7	0.35 J	26,300	0.43 U	0.25 U	116	5.76 J	552	2,700	1,920	11.9	5,880	43.7	1.83 U	3.37 U	5.61 U	3,190	2.6 U	5.32	5.12 J	0.05 U	74	
Rio Grande above Alameda	S	9/16/2009	23:15	0.72 U	15.8 U	4.43 U	35.7	66.3	0.33 J	32,300	0.43 U	0.25 U	0.5 U	2.07 U	57.6 J	2,710	3,060	1.63	11,900	0.71 U	1.83 U	3.37 U	5.61 U	4,440	2.6 U	5.07	6.01 J	0.05 U	93	
Rio Grande above Alameda	S	9/17/2009	11:50	0.72 U	87.7 J	4.43 U	14.4 J	35.5	0.38 J	14,700	0.43 U	0.25 U	0.96 J	2.07 U	96.3 J	1,710	1,170	1.59	4,700	0.71 U	1.83 U	3.37 U	5.61 U	2,260	2.6 U	3.33 J	8.52 J	0.05 U	41	

Table 2a Non-representive Data

Sample Location	Sample Type	Date	Time	Ag	Al	As	B	Ba	Be	Ca	Cd	Co	Cr	Cu	Fe	K	Mg	Mn	Na	Ni	Pb	Sb	Se	Si	Tl	V	Zn	Hg	Hardness (Calculated)
Units				ug/L	ug/L	ug/L	ug/L	ug/L	ug/L	ug/L	ug/L	ug/L	ug/L	ug/L	ug/L	ug/L	ug/L	ug/L	ug/L	ug/L	ug/L	ug/L	ug/L	ug/L	ug/L	ug/L	ug/L	ug/L	mg/L
Rio Grande at Buckman	Equipment Malfunction	7/19/2009	23:46	0.72 U	15.8 U	4.43 U		57.1	0.4 J	37,100	0.43 U	0.53 J	0.5 U	2.07 U	9.65 U	2,160	6,150	0.34 U	15,400	0.71 U	1.83 U	4.58 J	5.61 U		2.6 U	5.93	1.23 U	0.05 U	118

U = Sample result is less than minimum detection limit

J = Sample result is greater than minimum detection limit but less than reporting detection limit

Table 3. Unfiltered Radiological Results in Storm Flow from the Rio Grande and Chama River 2009

Sample Location	Sample Type	Date	Time	Gross Alpha			Uranium-234			Uranium-235			Uranium-238			Adjusted Gross Alpha Calculated Result pCi/L	Plutonium-238			Pu-239/240			SSC mg/L	Pu-239/240 in suspended sediment (Calculated) Reservoir sediment background McLin and Lyons, 2002 (0.02 pCi/g) pCi/g				
				Result pCi/L	Uncert (2Sigma) pCi/L	MDA pCi/L	Result pCi/L	Uncert (2Sigma) pCi/L	MDA pCi/L	Result pCi/L	Uncert (2Sigma) pCi/L	MDA pCi/L	Result pCi/L	Uncert (2Sigma) pCi/L	MDA pCi/L		Result pCi/L	Uncert (2Sigma) pCi/L	MDA pCi/L	Result pCi/L	Uncert (2Sigma) pCi/L	MDA pCi/L						
Rio Chama at Chamita	S	6/26/2009	20:05	44	8.1	2.6	2.3	0.46	0.046	0.047	0.04	0.022	LT	2.2	0.44	0.038	39	0.0015	0.0074	0.011	U	0.05	0.02	0.014	4,257	0.012		
Rio Chama at Chamita	S	7/13/2009	18:11	11	2.7	2.2	0.71	0.18	0.057	0.02	0.029	0.05	U	0.57	0.16	0.046	9.7	0.0052	0.0085	0.0047	LT	0.0069	0.0098	0.016	U	946	0.007	
Rio Chama at Chamita	S	7/21/2009	20:11	4.4	1.6	1.8	0.74	0.19	0.079	0.015	0.029	0.06	U	0.55	0.15	0.072	3.1	0.0026	0.0064	0.0035	U	0.0013	0.0064	0.012	U	1,040	0.001	
Rio Chama at Chamita	B	8/10/2009	13:50	3.9	1.4	1.3	0.57	0.16	0.062	0.027	0.031	0.047	U	0.43	0.13	0.066	2.9	0	0.0062	0.0093	U	0	0.0062	0.012	U	NA		
Rio Grande at Lyden	S	9/13/2009	3:14	3.1	1.6	2	1.3	0.27	0.036	0.048	0.038	0.033	LT	1	0.22	0.033	0.8	-0.0025	0.0061	0.012	U	0.0012	0.0061	0.0091	U	405	0.003	
Rio Grande at Buckman	S	6/27/2009	0:34	21	4.1	2.1	1.9	0.38	0.048	0.091	0.057	0.049	LT	1.5	0.32	0.041	17	0	0.0073	0.014	U	0.015	0.011	0.014	LT	1,361	0.011	
Rio Grande at Buckman	S	7/4/2009	18:18	1.7	1.1	1.7	LT	0.74	0.2	0.048	0.052	0.046	0.051	LT	0.57	0.16	0.043	0.3	-0.0045	0.0075	0.018	U	0.0015	0.0091	0.018	U	534	0.003
Rio Grande at Buckman	S	7/30/2009	14:54	24	4.6	1.9	2.2	0.43	0.041	0.14	0.07	0.043	LT	1.9	0.39	0.05	20	0	0.006	0.009	U	0.012	0.012	0.018	U	1,523	0.008	
Rio Grande at Buckman	S	8/13/2009	19:09	11	2.3	1.4	1.4	0.35	0.062	0.057	0.054	0.056	LT	0.78	0.22	0.09	8.8	0.0013	0.0063	0.0094	U	0.011	0.0086	0.0094	LT	1,393	0.008	
Rio Grande at Otowi	S	6/26/2009	23:45	28	5.4	2.7	2	0.4	0.055	0.072	0.053	0.052	LT	1.6	0.35	0.045	24	0	0.0074	0.016	U	0.033	0.016	0.017	1,912	0.017		
Rio Grande at Otowi	S	7/4/2009	17:36	1.9	1.2	1.7	LT	0.71	0.18	0.058	0.044	0.04	0.049	U	0.55	0.15	0.067	0.6	0.0027	0.0066	0.0037	U	0	0.0085	0.018	U	410	0.000
Rio Grande at Otowi	S	7/22/2009	0:07	12	2.7	1.7	1.1	0.25	0.041	0.054	0.043	0.037	LT	1.1	0.24	0.032	9.7	0.0025	0.0061	0.0034	U	0.0086	0.0075	0.0091	U	1,911	0.005	
Rio Grande at Otowi	S	8/13/2009	18:23	16	3.4	2	1.9	0.41	0.059	0.046	0.047	0.063	U	1.7	0.37	0.058	12	0.0016	0.0076	0.0042	U	0	0.0098	0.02	U	1,896	0.000	
Rio Grande above Alameda	S	7/21/2009	19:42	38	7.1	2.7	2.5	0.49	0.052	0.12	0.07	0.025	LT	2.3	0.46	0.048	33	0	0.0067	0.01	U	0.035	0.017	0.018	2,407	0.015		
Rio Grande above Alameda	S	9/9/2009	22:42	15	3.2	2	0.82	0.2	0.052	0.05	0.04	0.034	LT	0.7	0.17	0.045	13	0.0011	0.0056	0.0084	U	0.0069	0.0086	0.014	U	1,020	0.007	
Rio Grande above Alameda	S	9/11/2009	20:24	9.6	2.8	1.8	0.6	0.15	0.033	0.11	0.06	0.019	LT	0.46	0.13	0.037	8.4	0	0.0058	0.0087	U	0.013	0.0081	0.0032	LT	513	0.025	
Rio Grande above Alameda	S	9/16/2009	23:15	35	6.4	2.8	1.6	0.33	0.029	0.12	0.062	0.035	LT	1.6	0.32	0.042	32	0.0012	0.0057	0.0032	U	0.015	0.0093	0.0086	LT	1,645	0.009	
Rio Grande above Alameda	S	9/17/2009	11:50	23	4.3	1.8	1	0.23	0.043	0.029	0.031	0.035	U	0.9	0.21	0.03	21	0	0.006	0.0033	U	0.0097	0.0086	0.011	U	1,221	0.008	

Table 3a Non-representative Data

Sample Location	Sample Type	Date	Time	Gross Alpha			Uranium-234			Uranium-235			Uranium-238			Adjusted Gross Alpha Calculated Result pCi/L	Plutonium-238			Pu-239/240			SSC mg/L	Pu-239/240 in suspended sediment (Calculated) Reservoir sediment background McLin and Lyons, 2002 (0.02 pCi/g) pCi/g				
				Result pCi/L	Uncert (2Sigma) pCi/L	MDA pCi/L	Result pCi/L	Uncert (2Sigma) pCi/L	MDA pCi/L	Result pCi/L	Uncert (2Sigma) pCi/L	MDA pCi/L	Result pCi/L	Uncert (2Sigma) pCi/L	MDA pCi/L		Result pCi/L	Uncert (2Sigma) pCi/L	MDA pCi/L	Result pCi/L	Uncert (2Sigma) pCi/L	MDA pCi/L						
Rio Grande at Buckman	Equipment Malfunction	7/19/2009	23:46	1.9	0.96	1.4	LT	0.68	0.17	0.018	0.027	0.031	0.041	U	0.32	0.1	0.03	0.9	0.0028	0.0069	0.0038	U	0.0028	0.0069	0.013	U	7,544	0.000

Table 3. Unfiltered Radiological Results in Storm Flow from the Rio Grande and Chama River 2009 (continued)

Sample Type				Gross Beta			Cesium-137				Strontium-90				Ra-226				Ra-228			Ra-226 + Ra-228
Sample Location	Storm Water (S); Base Flow (B)	Date	Time	Result	Uncertainty (2Sigma)	MDA	Result	Uncertainty (2Sigma)	MDA	Result	Uncertainty (2Sigma)	MDA	Result	Uncertainty (2Sigma)	MDA	Result	Uncertainty (2Sigma)	MDA	Result	Uncertainty (2Sigma)	MDA	Calculated Result
				pCi/L	pCi/L	pCi/L		pCi/L	pCi/L		pCi/L	pCi/L		pCi/L	pCi/L		pCi/L	pCi/L		pCi/L	pCi/L	
Rio Chama at Chamita	S	6/26/2009	20:05	59	10	5.3 M3	-2.6	2.9	5 U,M	0.4	0.31	0.63 U	0.81	0.43	0.3 LT	1.8	0.7	0.79				2.6
Rio Chama at Chamita	S	7/13/2009	18:11	16	3.3	3.3	1.4	2.6	4.3 U	0.019	0.19	0.43 U	0.43	0.29	0.3 LT	0.43	0.42	0.82	U			0.9
Rio Chama at Chamita	S	7/21/2009	20:11	9.4	2.4	3.2	0.12	2.8	4.8 U	-0.027	0.19	0.45 U	0.26	0.3	0.46 U	0.51	0.42	0.78	U			0.8
Rio Chama at Chamita	B	8/10/2009	13:50	8.7	2.3	3.3	-0.77	2.6	4.4 U	0.18	0.17	0.36 U	0.51	0.37	0.49 LT	0.71	0.48	0.87	U			1.2
Rio Grande at Lyden	S	9/13/2009	3:14	7.5	2	2.7	0.015	1.7	2.9 U	0.13	0.28	0.64 U	0.059	0.64	1.2 U,M	0.31	0.53	1.1 U,M				0.4
Rio Grande at Buckman	S	6/27/2009	0:34	29	5.3	3.1	0.69	2.8	4.6 U	0.17	0.23	0.5 U	0.77	0.41	0.38 LT	0.46	0.39	0.74	U			1.2
Rio Grande at Buckman	S	7/4/2009	18:18	6.7	2.1	3.1	-3.9	3.1	5.4 U,M	-0.01	0.19	0.45 U	NA			NA						
Rio Grande at Buckman	S	7/30/2009	14:54	39	6.9	3.7	-1.5	3.2	5.5 U,M	0.23	0.22	0.47 U	0.42	0.29	0.39 LT	0.68	0.45	0.79	U			1.1
Rio Grande at Buckman	S	8/13/2009	19:09	24	4.4	2.8	-1.8	2.7	4.7 U	-0.011	0.19	0.45 U	0.61	0.5	0.69 U	0.83	0.47	0.77	LT			1.4
Rio Grande at Otowi	S	6/26/2009	23:45	45	7.8	4	1.5	3.2	5.3 U,M	0.37	0.23	0.44 U	0.63	0.38	0.31 LT	1.2	0.66	1.1	M3			1.8
Rio Grande at Otowi	S	7/4/2009	17:36	4.5	1.8	3.1	-1.4	3	5.2 U,M	0.045	0.19	0.43 U	0.36	0.33	0.42 U	-0.32	0.5	1.1 U,M				0.0
Rio Grande at Otowi	S	7/22/2009	0:07	24	4.7	4 M3	-1.4	2.6	4.5 U	0.025	0.21	0.48 U	1.4	0.7	0.72	1.3	0.6	0.87				2.7
Rio Grande at Otowi	S	8/13/2009	18:23	31	5.5	3.2	-2.1	3	5.3 U,M	0.27	0.23	0.47 U	0.86	0.44	0.48 LT	1.1	0.56	0.87				2.0
Rio Grande above Alameda	S	7/21/2009	19:42	60	10	5.1 M3	-2.7	2.8	4.9 U	0.11	0.22	0.5 U	5.5	1.7	0.67	2.8	1.1	1.3	M3			8.3
Rio Grande above Alameda	S	9/9/2009	22:42	32	5.7	3.4	0.31	2.2	3.7 U	0.86	0.37	0.59 LT	0.6	0.36	0.43 LT	0.67	0.4	0.68	U			1.3
Rio Grande above Alameda	S	9/11/2009	20:24	18	3.7	3.4	-1.2	2.1	3.6 U	-0.03	0.28	0.66 U	0.64	0.43	0.46 LT	0.46	0.39	0.74	U			1.1
Rio Grande above Alameda	S	9/16/2009	23:15	56	9.5	4.2 M3	0.29	2.2	3.7 U	-0.032	0.29	0.69 U	1	0.5	0.4	0.53	0.4	0.73	U			1.5
Rio Grande above Alameda	S	9/17/2009	11:50	42	7	2.9	1.6	1.8	2.9 U	-0.063	0.25	0.61 U	0.47	0.66	1.1 U,M	0.58	0.45	0.83	U			1.1

Table 3b (continued) Non-representative Data

Sample Location	Sample Type	Date	Time	Gross Beta			Cesium-137			Strontium-90			Ra-226			Ra-228			Ra-226 + Ra-228	
				Result	Uncertainty (2Sigma)	MDA	Result	Uncertainty (2Sigma)	MDA	Result	Uncertainty (2Sigma)	MDA	Result	Uncertainty (2Sigma)	MDA	Result	Uncertainty (2Sigma)	MDA	Calculated Result	
				pCi/L	pCi/L	pCi/L	pCi/L	pCi/L	pCi/L	pCi/L	pCi/L	pCi/L	pCi/L	pCi/L	pCi/L	pCi/L	pCi/L	pCi/L		
Rio Grande at Buckman	Equipment Malfunction	7/19/2009	23:46	7.1	1.9	2.7	-2.9	3	5.3 U,M	0.0047	0.18	0.42 U	0.21	0.25	0.4 U	0.33	0.37	0.73	U	0.5

U= Result is less than the sample specific MDC

M3 = Requested MDC was not met, but the reported activity is greater than the reported MDC

M = Requested MDC not met

U = Result is less than the sample specific MDC

LT = Result is less than Requested MDC, greater than the sample specific MDC

NA = Not Analyzed

Table 4. Unfiltered Gamma Radiological Results in Storm Flow from the Rio Grande and Chama River 2009

Sample Location	Sample Type	Date	Time	Actinium-228			Aluminum-26			Americium-241			Antimony-124			Beryllium-7			Bismuth-212			Bismuth-214			Cadmium-109			Ce-139			Cerium-144												
				Result	UNC	MDA	Result	UNC	MDA	Result	UNC	MDA	Result	UNC	MDA	Result	UNC	MDA	Result	UNC	MDA	Result	UNC	MDA	Result	UNC	MDA	Result	UNC	MDA	Result	UNC	MDA	Result	UNC	MDA							
				pci/L	pci/L	pci/L	pci/L	pci/L	pci/L	pci/L	pci/L	pci/L	pci/L	pci/L	pci/L	pci/L	pci/L	pci/L	pci/L	pci/L	pci/L	pci/L	pci/L	pci/L	pci/L	pci/L	pci/L	pci/L	pci/L	pci/L	pci/L	pci/L	pci/L	pci/L	pci/L	pci/L							
Rio Chama at Chamita	S	6/26/2009	20:05	20	11	17	TI	0.5	3.6	6.1	U	-19	26	44	U	0.63	10	17	U	57	85	140	U	18	47	78	U	0.58	13	21	U,J	-83	90	150	U	-0.37	3.1	5.2	U	5.7	17	29	U
Rio Chama at Chamita	S	7/13/2009	18:11	17	11	17	TI	-0.86	2.9	5.1	U	1.9	3.5	5.8	U	2.7	6.7	11	U	-59	58	100	U	39	37	61	U	3.5	8.9	15	U,J	18	34	57	U	1.2	2.3	3.8	U	6	13	22	U
Rio Chama at Chamita	S	7/21/2009	20:11	16	12	19	U	-0.93	3.9	6.8	U	-0.27	2.7	4.5	U	4.2	6.7	11	U	15	52	88	U	47	45	73	U	0.91	13	21	U,J	14	30	49	U	0.76	2	3.3	U	1.6	11	19	U
Rio Chama at Chamita	B	8/10/2009	13:50	18	9.7	15	TI	-0.24	3.1	5.3	U	7.5	21	35	U	-5.2	5	8.6	U	12	36	61	U	20	36	59	U	-2.9	12	20	U,J	62	65	110	U	-0.45	2.1	3.6	U	-1.5	18	30	U
Rio Grande at Lyden	S	9/13/2009	3:14	0.94	10	17	U	-1.5	2.3	4.1	U	-23	18	31	U	-0.62	4.2	7	U	39	33	53	U	16	26	43	U	7.6	4.5	7.4	J,TI	-31	93	150	U	-0.21	1.5	2.6	U	4.4	5.1	8.3	U
Rio Grande at Buckman	S	6/27/2009	0:34	23	12	18	TI	1.8	4.1	6.8	U	-1.7	35	65	U	11	100	24	U	67	70	110	U	41	43	71	U	5.7	13	21	U,J	-1.3	54	91	U	-1.2	2.6	4.4	U	-5.3	14	24	U
Rio Grande at Buckman	S, DUP	6/27/2009	0:34	10	10	18	U	-0.95	3	5.2	U	-28	22	38	U	-46	28	46	U	-13	64	110	U	25	39	65	U	-1.2	9.8	16	U,J	-53	120	200	U	-2.7	2.7	4.6	U	24	15	24	U
Rio Grande at Buckman	S	7/4/2009	18:18	20	11	17	TI	-0.14	3.5	6.1	U	-9.5	26	44	U	3.3	7.4	12	U	71	61	98	U	8.2	45	76	U	9.6	12	26	U,J	-62	86	150	U	-2.4	4.8	8	U	-17	28	47	U
Rio Grande at Buckman	S, DUP	7/4/2009	18:18	11	12	19	U	1.5	4.1	7	U	-9.4	15	26	U	-4.4	7.8	13	U	33	60	100	U	24	43	71	U	12	6.9	11	J,TI	4	58	97	U	-1.5	2.7	4.6	U	-8.2	13	22	U
Rio Grande at Buckman	S	7/30/2009	14:54	23	12	18	TI	-0.37	3.6	6.2	U	16	19	32	U	-4.1	6.8	12	U	59	52	84	U	13	45	75	U	12	6.5	10	J,TI	21	180	290	U	-0.19	2.6	4.4	U	3.2	16	27	U
Rio Grande at Buckman	S	8/13/2009	19:09	10	8.8	18	U	2.4	3.7	6.2	U	-7.6	33	55	U	13	4.9	7.2	TI	8	35	59	U	31	39	64	U	-0.32	12	20	U,J	-4.8	49	82	U	-2.2	2	3.5	U	-9.9	12	21	U
Rio Grande at Otowi	S	6/26/2009	23:45	11	12	20	U	-0.81	3.5	6.1	U	7.7	16	26	U	7.4	10	17	U	-55	78	140	U	31	46	76	U	-3.8	15	24	U,J	-88	98	160	U	-3.8	3.1	5.3	U	-1.1	14	24	U
Rio Grande at Otowi	S	7/4/2009	17:36	10	10	19	U	0.71	3.3	5.7	U	12	26	43	U	-11	9.7	17	U	0	73	120	U	48	44	70	U	0.21	14	23	U,J	-140	180	300	U	-0.65	3	5.1	U	-7.7	17	29	U
Rio Grande at Otowi	S, DUP	7/4/2010	17:36	-5.6	21	36	U	1.9	3.6	6.1	U	11	15	25	U	-5.8	6.9	12	U	31	50	82	U	56	43	68	U	-1.3	12	20	U,J	-20	52	88	U	-0.85	2.3	3.8	U	-8	13	23	U
Rio Grande at Otowi	S	7/22/2009	0:07	12	8.1	17	U	2.2	2.9	4.8	U	1.5	3.5	5.8	U	8.6	9.8	16	U	34	49	82	U	53	81	130	U	-1.6	12	20	U,J	22	23	38	U	-2.4	2.3	3.8	U	4.9	13	22	U
Rio Grande at Otowi	S	8/13/2009	18:23	5.2	24	39	U	-0.71	3.8	6.6	U	19	20	32	U	4.9	5.7	9.4	U	12	43	72	U	24	43	71	U	3.7	12	20	U,J	-40	76	130	U	0.64	2.2	3.7	U	10	12	20	U
Rio Grande above Alameda	S	7/21/2009	19:42	9	7.8	12	U	0.55	2.4	4.1	U	1.6	18	31	U	-8.4	4.8	8.4	U	26	28	46	U	36	30	49	U	6.3	12	20	U,J	-7.2	57	96	U	-1.2	1.8	3.1	U	-5	11	18	U
Rio Grande above Alameda	S	9/9/2009	22:42	8.6	8.3	13	U	-0.047	2.7	4.6	U	0.82	2.9	4.8	U	-0.69	3.9	6.7	U	29	29	47	U	6.8	30	51	U	7.7	4.4	6.8	J,TI	-20	21	35	U	-1.1	1.3	2.3	U	-0.52	11	19	U
Rio Grande above Alameda	S	9/11/2009	20:24	0.94	10	17	U	-1.5	2.3	4.1	U	-23	18	31	U	-0.62	4.2	7	U	39	33	53	U	16	26	43	U	7.6	4.5	7.4	J,TI	-31	93	150	U	-0.21	1.5	2.6	U	4.4	5.1	8.3	U
Rio Grande above Alameda	S, DUP	9/11/2009	20:24	6.4	5.5	11	U	0.79	2.2	3.6	U	8.5	21	34	U	11	3.5	4.8	TI	27	26	42	U	32	35	57	U	4.1	7.9	13	U,J	42	26	40	W,SI	-0.8	1.5	2.5	U	-7.4	9.1	15	U
Rio Grande above Alameda	S	9/16/2009	23:15	5.8	7.9	13	U	1.9	2.7	4.4	U	1.7	11	18	U	-5.1	4.1	7	U	18	30	49	U	17	33	55	U	7.9	4.1	6.4	J,TI	4.6	56	93	U	0.062	1.8	2.9	U	-0.6	7.6	13	U
Rio Grande above Alameda	S	9/17/2009	11:50	8.2	7.7	12	U	-0.81	2.1	3.6	U	1.3	2.5	4.1	U	7.5	3.2	4.7	TI	22	23	38	U	9.2	27	44	U	0.13	8.1	13	U,J	-26	46	77	U	-0.46	1.4	2.4	U	-2.6	8.7	15	U

Table 4a Non-representative Data

Sample Location	Sample Type	Date	Time	Actinium-228			Aluminum-26			Americium-241			Antimony-124			Beryllium-7			Bismuth-212			Bismuth-214			Cadmium-109			Ce-139			Cerium-144												
				Result	UNC	MDA	Result	UNC	MDA	Result	UNC	MDA	Result	UNC	MDA	Result	UNC	MDA	Result	UNC	MDA	Result	UNC	MDA	Result	UNC	MDA	Result	UNC	MDA	Result	UNC	MDA										
Rio Grande at Buckman	Equipment Malfunction	7/19/2009	23:46	15	12	19	U	2.5	3.9	6.5	U	16	18	29	U	1.3	7.6	13	U	27	58	97	U	5.8	44	75	U	13	6.6	10	J,TI	6.1	56	94	U	-2.5	2.7	4.5	U	8.3	13	21	U

U - Result is less than the sample specific MDC or less than the associated TPU

M - Requested MCD not met.

W - DER is greater than Warning Limit of 1.42

J - Estimated value for lead and bismuth 214 to note bias whenever a multipoint calibration is used

TI - Nuclide identification is tentative.

SI - Nuclide identification and/or quantitation is tentative.

Table 4. Unfiltered Gamma Radiological Results in Storm Flow from the Rio Grande and Chama River 2009 (continued)

Sample Location	Sample Type (S); Base Flow (B); Lab Duplicate (DUP)	Date	Time	Cesium-134			Cesium-137			Chromium-51			Cobalt-56			Cobalt-57			Cobalt-58			Cobalt-60			Europium-152			Europium-154			Europium-155			
				Result pci/L	UNC pci/L	MDA pci/L	Result pci/L	UNC pci/L	MDA pci/L	Result pci/L	UNC pci/L	MDA pci/L	Result pci/L	UNC pci/L	MDA pci/L	Result pci/L	UNC pci/L	MDA pci/L	Result pci/L	UNC pci/L	MDA pci/L	Result pci/L	UNC pci/L	MDA pci/L	Result pci/L	UNC pci/L	MDA pci/L	Result pci/L	UNC pci/L	MDA pci/L	Result pci/L	UNC pci/L	MDA pci/L	
Rio Chama at Chamita	S	6/26/2009	20:05	-2.5	3.3	5.7 U	-2.6	2.9	5 U	M	-210	280	480 U	6	12	20 U	0.2	2.4	4 U	-4.4	7.7	13 U	-0.09	3.2	5.5 U	10	15	25 U	-7.2	16	28 U	4.2	9	15 U
Rio Chama at Chamita	S	7/13/2009	18:11	-3	2.6	4.6 U	1.4	2.6	4.3 U		-16	150	250 U	3	9.1	15 U	-1.3	1.7	2.9 U	3.1	5.5	9 U	-0.88	2.9	5 U	7.8	9.5	20 U	-14	14	25 U	0.13	5.7	9.5 U
Rio Chama at Chamita	S	7/21/2009	20:11	-2.2	2.9	5 U	0.12	2.8	4.8 U		52	120	200 U	8.2	10	17 U	0.09	1.4	2.4 U	-2.1	6.3	11 U	-3.4	3.5	6.4 U	-1.5	16	28 U	-13	17	31 U	-1.1	4.6	7.8 U
Rio Chama at Chamita	B	8/10/2009	13:50	-3.9	2.7	4.7 U	-0.77	2.6	4.4 U		19	74	120 U	4.4	6.8	11 U	0.45	1.5	2.5 U	-0.39	3.9	6.7 U	-2.4	2.7	4.8 U	3.1	13	22 U	-0.54	14	23 U	-1.7	6.4	11 U
Rio Grande at Lyden	S	9/13/2009	3:14	5.4	1.8	2.5 U	0.29	2.2	3.7 U		-0.56	61	100 U	5.5	4.9	7.8 U	-0.27	1.1	1.8 U	2.1	2.9	4.8 U	-1.5	2.1	3.7 U	0.25	10	17 U	3.4	9.4	16 U	0.16	4.4	7.4 U
Rio Grande at Buckman	S	6/27/2009	0:34	-8	4.3	7.5 U	0.69	2.8	4.6 U		280	230	370 U	6.4	12	20 U	1.6	1.9	3.1 U	1.4	6.5	11 U	-0.31	3.4	5.9 U	-18	17	30 U	-2.6	16	27 U	0.17	6.8	11 U
Rio Grande at Buckman	S, DUP	6/27/2009	0:34	-3.1	2.9	5 U	1.5	2.7	4.4 U		100	220	360 U	2.6	10	17 U	0.6	1.8	3 U	-2.9	6.4	11 U	-1.2	2.9	5.1 U	-15	15	26 U	-10	14	24 U	-3.2	6.6	11 U
Rio Grande at Buckman	S	7/4/2009	18:18	-3.4	3.3	5.7 U	-3.9	3.1	5.4 U	M	-40	150	260 U	9	9.6	16 U	0.27	2.3	3.8 U	-0.27	6.1	10 U	-1.4	3	5.3 U	-2.7	16	28 U	11	17	28 U	-4.2	9.2	16 U
Rio Grande at Buckman	S, DUP	7/4/2009	18:18	-0.4	3.3	5.7 U	-1.8	3	5.2 U	M	0.38	150	250 U	6.3	9.9	16 U	-0.5	1.7	2.9 U	4.1	6.3	10 U	-2.7	3.6	6.4 U	-3	16	29 U	2.7	17	29 U	-5.9	18	29 U
Rio Grande at Buckman	S	7/30/2009	14:54	-1.3	3.2	5.5 U	-1.5	3.2	5.5 U	M	-5.2	120	190 U	2.3	8.6	14 U	-0.42	2.3	3.8 U	-1.9	5.5	9.5 U	1.4	3.1	5.2 U	-5.7	15	26 U	-0.32	16	28 U	-5.5	9.1	15 U
Rio Grande at Buckman	S	8/13/2009	19:09	-0.54	2.8	4.8 U	-1.8	2.7	4.7 U		43	69	110 U	4.3	7.3	12 U	-1.6	1.6	2.8 U	1.8	4	6.7 U	3.5	3.2	5.1 U	-18	17	30 U	-4	16	27 U	2.4	6.4	11 U
Rio Grande at Otowi	S	6/26/2009	23:45	-3.1	3.4	6 U	1.5	3.2	5.3 U	M	71	260	440 U	6.4	12	20 U	-1.1	1.9	3.2 U	4.8	8.3	14 U	-0.31	3.5	6.1 U	5.1	16	28 U	-15	17	30 U	2.4	6.7	11 U
Rio Grande at Otowi	S	7/4/2009	17:36	0.14	5.1	8.4 U	-1.4	3	5.2 U	M	-160	220	380 U	0.29	11	18 U	-0.47	2.4	4 U	2	7	12 U	-0.46	3.1	5.5 U	3.4	14	24 U	-2.3	16	28 U	-3.4	9.2	16 U
Rio Grande at Otowi	S, DUP	7/4/2010	17:36	-2.6	3	5.1 U	-0.72	2.7	4.7 U		6.8	120	200 U	-0.62	9.3	16 U	-0.77	1.7	2.9 U	0.75	5.1	8.5 U	-0.57	3.3	5.7 U	-3.7	16	28 U	3.7	16	26 U	1.4	6.7	11 U
Rio Grande at Otowi	S	7/22/2009	0:07	0.67	3.9	6.4 U	-1.4	2.6	4.5 U		-94	120	200 U	2.2	8.4	14 U	0.21	1.6	2.8 U	-2.2	4.8	8.4 U	-0.62	2.9	5 U	-0.76	14	24 U	-13	14	24 U	0.32	5.6	9.3 U
Rio Grande at Otowi	S	8/13/2009	18:23	-1	3.1	5.3 U	-2.1	3	5.3 U	M	-19	83	140 U	4.3	7.8	13 U	-0.31	1.6	2.7 U	0.034	5	8.5 U	-0.48	3.6	6.2 U	-16	17	30 U	-6	16	29 U	4.1	6.6	11 U
Rio Grande above Alameda	S	7/21/2009	19:42	2.4	3.5	5.6 U	-1.2	2.1	3.6 U		-41	72	120 U	2	5.9	9.9 U	-0.51	1.6	2.7 U	-1.8	3.5	6.1 U	-0.57	2.4	4.2 U	-0.84	11	19 U	-7.2	12	21 U	-5.3	10	17 U
Rio Grande above Alameda	S	9/9/2009	22:42	-1	2	3.5 U	0.31	2.2	3.7 U		40	49	81 U	-1.7	6.4	11 U	0.21	0.94	1.6 U	0.16	3.7	6.3 U	0.56	2.2	3.7 U	1.4	11	19 U	-10	12	21 U	1.2	3.2	5.3 U
Rio Grande above Alameda	S	9/11/2009	20:24	5.4	1.8	2.5 U	0.29	2.2	3.7 U		-0.56	61	100 U	5.5	4.9	7.8 U	-0.27	1.1	1.8 U	2.1	2.9	4.8 U	-1.5	2.1	3.7 U	0.25	10	17 U	3.4	9.4	16 U	0.16	4.4	7.4 U
Rio Grande above Alameda	S, DUP	9/11/2009	20:24	-2.8	2.1	3.6 U	0.015	1.7	2.9 U		30	52	86 U	-3.2	5.9	10 U	-0.51	1.2	2 U	0.51	3.3	5.5 U	-0.38	2	3.4 U	-5.9	9.6	17 U	2.1	11	18 U	1.5	4.6	7.7 U
Rio Grande above Alameda	S	9/16/2009	23:15	-0.25	2.2	3.8 U	-0.28	1.9	3.2 U		-2.5	59	100 U	4.8	5.7	9.3 U	-0.54	1.5	2.6 U	-3.4	3.3	5.8 U	-1.6	2.3	4 U	-4.5	12	20 U	-3.9	12	20 U	0	6.2	10 U
Rio Grande above Alameda	S	9/17/2009	11:50	-2.8	1.8	3.2 U	1.6	1.8	2.9 U		9	49	83 U	3.2	4.7	7.8 U	-0.48	2.2	3.7 U	1.8	3	5 U	1.4	2	3.3 U	7.2	9.2	15 U	4.2	9.8	16 U	-1.5	4	6.7 U

Table 4b (continued) Non-representative Data

Sample Location	Sample Type	Date	Time	Result pci/L	UNC pci/L	MDA pci/L	Result pci/L	UNC pci/L	MDA pci/L	Result pci/L	UNC pci/L	MDA pci/L	Result pci/L	UNC pci/L	MDA pci/L	Result pci/L	UNC pci/L	MDA pci/L	Result pci/L	UNC pci/L	MDA pci/L	Result pci/L	UNC pci/L	MDA pci/L	Result pci/L	UNC pci/L	MDA pci/L	Result pci/L	UNC pci/L	MDA pci/L	Result pci/L	UNC pci/L	MDA pci/L	
Rio Grande at Buckman	Equipment Malfunction	7/19/2009	23:46	-0.31	3.3	5.5 U	-2.9	3	5.3 U	M	-71	150	250 U	-1.2	9.6	17 U	-0.46	1.8	3 U	4.6	6.3	10 U	-0.5	3.5	6 U	-2.6	16	27 U	-16	18	31 U	3.1	6.5	11 U

U - Result is less than the sample specific MDC or less than the associated TPU

M - Requested MCD not met.

W - DER is greater than Warning Limit of 1.42

J - Estimated value for lead and bismuth 214 to note bias whenever a multipoint calibration is used

TI - Nuclide identification is tentative.

SI - Nuclide identification and/or quantitation is tentative.

Table 4. Unfiltered Gamma Radiological Results in Storm Flow from the Rio Grande and Chama River 2009 (continued)

Sample Location	Sample Type Storm Water (S); Base Flow (B); Lab Duplicate (DUP)	Date	Time	I-131			Iron-59			Lead-212			Lead-214			Manganese-54			Niobium-94			Niobium-95			Potassium-40			Protactinium-234m			Ruthenium-106												
				Result	UNC	MDA	Result	UNC	MDA	Result	UNC	MDA	Result	UNC	MDA	Result	UNC	MDA	Result	UNC	MDA	Result	UNC	MDA	Result	UNC	MDA	Result	UNC	MDA	Result	UNC	MDA										
				pci/L	pci/L	pci/L	pci/L	pci/L	pci/L	pci/L	pci/L	pci/L	pci/L	pci/L	pci/L	pci/L	pci/L	pci/L	pci/L	pci/L	pci/L	pci/L	pci/L	pci/L	pci/L	pci/L	pci/L	pci/L	pci/L	pci/L	pci/L	pci/L	pci/L										
Rio Chama at Chamita	S	6/26/2009	20:05	980	22000	37000	U	-16	28	48	U	2.4	8	13	U	2.5	11	18	U,J	-2.2	3.5	6.1	U	1.2	2.9	4.9	U	-2.4	7.5	13	U	37	89	150	U	310	480	800	U	-15	31	54	U
Rio Chama at Chamita	S	7/13/2009	18:11	2000	4500	7500	U	12	20	32	U	5.9	7.2	12	U	-3	7.2	12	U,J	0	3	5	U	0.73	2.7	4.5	U	1.6	5.9	9.9	U	0.92	61	100	U	590	450	710	U	3.8	25	42	U
Rio Chama at Chamita	S	7/21/2009	20:11	-160	2600	4400	U	6.3	19	32	U	-0.14	7.4	12	U	3.1	5.2	8.6	U,J	-0.77	3.2	5.5	U	-0.63	3	5.2	U	-2.4	6.6	11	U	-5.8	74	120	U	560	520	840	U	-33	29	51	U
Rio Chama at Chamita	B	8/10/2009	13:50	-100	420	710	U	1.9	12	20	U	1.1	6.4	11	U	4.8	6	12	U,J	0.35	2.7	4.5	U	0.016	2.5	4.2	U	-0.4	4	6.8	U	38	67	110	U	440	410	670	U	-7.5	25	42	U
Rio Grande at Lyden	S	9/13/2009	3:14	86	280	460	U	3.7	9.2	15	U	0.097	5.3	8.8	U	3	4.2	8.5	U,J	-0.56	1.9	3.2	U	-1.1	2.1	3.5	U	0.48	2.8	4.8	U	65	61	98	U	23	440	740	U	3.9	17	29	U
Rio Grande at Buckman	S	6/27/2009	0:34	2900	15000	25000	U	29	26	42	U	2.6	8.1	13	U	-4.5	11	18	U,J	0.96	3.5	5.9	U	-0.84	2.7	4.7	U	3.7	7.6	13	U	8.3	74	120	U	170	480	800	U	-20	32	54	U
Rio Grande at Buckman	S, DUP	6/27/2009	0:34	-1200	16000	28000	U	8.7	23	39	U	3.9	7.7	13	U	-6.3	9.5	16	U,J	-3.2	3	5.2	U	-1	2.7	4.5	U	0.67	6.6	11	U	41	67	110	U	170	420	700	U	-15	27	46	U
Rio Grande at Buckman	S	7/4/2009	18:18	-1200	2400	4100	U	7.4	17	29	U	5.1	4.9	8	U	6.7	5.4	8.7	U,J	0.51	3.4	5.8	U	-0.94	3	5.1	U	-1.1	6	10	U	-32	86	140	U	-120	500	860	U	9.5	33	55	U
Rio Grande at Buckman	S, DUP	7/4/2009	18:18	-710	2500	4200	U	1.6	20	34	U	4.9	8.6	14	U	12	5.5	8.2	J, TI	-2.5	3.8	6.6	U	-2.6	3.1	5.5	U	1.4	6.4	11	U	8.3	76	130	U	400	520	860	U	-17	29	51	U
Rio Grande at Buckman	S	7/30/2009	14:54	210	940	1600	U	-9.2	16	28	U	6.9	4.9	7.9	U	6	5.4	8.7	U,J	-0.35	3.4	5.8	U	-1.8	3	5.1	U	0.49	5	8.5	U	49	88	150	U	-170	510	880	U	27	30	49	U
Rio Grande at Buckman	S	8/13/2009	19:09	33	270	460	U	15	12	20	U	3.3	7.2	12	U	7.3	5	7.9	U,J	-0.84	3	5.2	U	1.8	2.7	4.4	U	-2.4	4.4	7.5	U	29	73	120	U	170	480	810	U	-5.9	28	47	U
Rio Grande at Otowi	S	6/26/2009	23:45	9500	18000	31000	U	20	28	47	U	1.8	8.8	15	U	-3.6	10	17	U,J	-0.94	3.8	6.5	U	-0.71	3.1	5.3	U	-4.8	8.3	15	U	36	80	130	U	200	510	850	U	-25	31	54	U
Rio Grande at Otowi	S	7/4/2009	17:36	-5200	9200	16000	U	-8.7	24	42	U	2.9	9.2	15	U	6.1	4.3	6.8	U,J	-1.8	3.6	6.2	U	0.2	2.9	4.9	U	9.8	7.1	11	U	83	89	150	U	-290	490	860	U	-22	32	55	U
Rio Grande at Otowi	S, DUP	7/4/2010	17:36	-810	1900	3200	U	9.7	18	30	U	-2.8	8.5	14	U	-0.76	8.8	15	U,J	-2.6	3.4	5.9	U	-2.2	2.8	4.8	U	-2.1	5.8	10	U	51	68	110	U	130	490	830	U	-29	30	51	U
Rio Grande at Otowi	S	7/22/2009	0:07	-1500	1700	3000	U	18	17	28	U	-1.2	7	12	U	-1.6	10	17	U,J	2.1	2.4	4	U	0.42	2.6	4.4	U	-3	5.3	9.1	U	37	69	110	U	130	720	1200	U	-13	24	42	U
Rio Grande at Otowi	S	8/13/2009	18:23	70	360	600	U	8.6	13	22	U	-4.2	9	15	U	-0.64	13	22	U,J	-3.7	5.7	9.7	U	1.6	3	5	U	0.91	5	8.5	U	-2.3	80	130	U	170	490	820	U	-21	28	49	U
Rio Grande above Alameda	S	7/21/2009	19:42	19	430	720	U	2.6	10	17	U	0.014	5.5	9.2	U	1.2	7.8	13	U,J	-1.5	2.2	3.9	U	-0.44	2.2	3.7	U	0.69	3.5	6	U	31	58	95	U	390	340	550	U	-21	20	35	U
Rio Grande above Alameda	S	9/9/2009	22:42	130	360	600	U	14	11	17	U	2.9	6.1	10	U	4.7	3.8	6	U,J	-0.33	2.4	4	U	0.73	2.2	3.6	U	-1.3	3.6	6.3	U	54	64	100	U	270	360	590	U	-16	22	37	U
Rio Grande above Alameda	S	9/11/2009	20:24	86	280	460	U	3.7	9.2	15	U	0.097	5.3	8.8	U	3	4.2	8.5	U,J	-0.56	1.9	3.2	U	-1.1	2.1	3.5	U	0.48	2.8	4.8	U	65	61	98	U	23	440	740	U	3.9	17	29	U
Rio Grande above Alameda	S, DUP	9/11/2009	20:24	86	340	560	U	9.5	8.7	14	U	-2	5.9	9.8	U	-4.5	7.9	13	U,J	-0.25	2.2	3.8	U	-1	1.8	3.1	U	-2.9	3.5	6.1	U	12	47	77	U	190	340	560	U	8.6	20	33	U
Rio Grande above Alameda	S	9/16/2009	23:15	-340	380	660	U	10	10	16	U	2.5	4.7	7.7	U	5.7	3.8	6	U,J	-1.4	2.1	3.8	U	-0.83	1.8	3.2	U	1	3.2	5.3	U	18	48	80	U	-340	640	1100	U	-17	22	37	U
Rio Grande above Alameda	S	9/17/2009	11:50	-150	220	380	U	9	8.3	13	U	0.45	5	8.3	U	-0.79	7	12	U,J	-0.12	1.9	3.3	U	1	1.8	3	U	0.12	3	5.1	U	29	46	75	U	40	320	540	U	-6.2	17	29	U

Table 4c (continued) Non-representative Data

Sample Location	Sample Type	Date	Time	I-131			Iron-59			Lead-212			Lead-214			Manganese-54			Niobium-94			Niobium-95			Potassium-40			Protactinium-234m			Ruthenium-106												
				Result	UNC	MDA	Result	UNC	MDA	Result	UNC	MDA	Result	UNC	MDA	Result	UNC	MDA	Result	UNC	MDA	Result	UNC	MDA	Result	UNC	MDA	Result	UNC	MDA	Result	UNC	MDA										
				pci/L	pci/L	pci/L	pci/L	pci/L	pci/L	pci/L	pci/L	pci/L	pci/L	pci/L	pci/L	pci/L	pci/L	pci/L	pci/L	pci/L	pci/L	pci/L	pci/L	pci/L	pci/L	pci/L	pci/L	pci/L	pci/L	pci/L	pci/L	pci/L	pci/L										
Rio Grande at Buckman	Equipment Malfunction	7/19/2009	23:46	-160	2300	3900	U	-1.5	19	33	U	2.1	8.5	14	U	-5.5	10	17	U,J	-1.3	3.8	6.5	U	0.41	3.1	5.3	U	2.2	6.3	11	U	-24	75	130	U	170	520	870	U	14	30	49	U

U - Result is less than the sample specific MDC or less than the associated TPU

M - Requested MCD not met.

W - DER is greater than Warning Limit of 1.42

J - Estimated value for lead and bismuth 214 to note bias whenever a multipoint calibration is used

TI - Nuclide identification is tentative.

SI - Nuclide identification and/or quantitation is tentative.

Table 4. Unfiltered Gamma Radiological Results in Storm Flow from the Rio Grande and Chama River 2009 (continued)

Sample Location	Sample Type Storm Water (S); Base Flow (B); Lab Duplicate (DUP)	Date	Time	Sb-125			Scandium-46			Silver-110m			Sodium-22			Strontium-85			Thallium-208			Thorium-227			Thorium-234			Uranium-235			Zinc-65												
				Result	UNC	MDA	Result	UNC	MDA	Result	UNC	MDA	Result	UNC	MDA	Result	UNC	MDA	Result	UNC	MDA	Result	UNC	MDA	Result	UNC	MDA	Result	UNC	MDA	Result	UNC	MDA										
				pci/L	pci/L	pci/L	pci/L	pci/L	pci/L	pci/L	pci/L	pci/L	pci/L	pci/L	pci/L	pci/L	pci/L	pci/L	pci/L	pci/L	pci/L	pci/L	pci/L	pci/L	pci/L	pci/L	pci/L	pci/L	pci/L	pci/L	pci/L	pci/L	pci/L	pci/L	pci/L	pci/L							
Rio Chama at Chamita	S	6/26/2009	20:05	-2.9	7.5	13	U	-1.6	6.4	11	U	3.2	3.5	5.6	U	2.1	3.1	5.2	U	1.8	9.5	16	U	4.6	3.2	5	U	3.3	15	25	U	44	100	160	U	9.7	13	22	U	-8	8.5	15	U
Rio Chama at Chamita	S	7/13/2009	18:11	4.4	5.5	10	U	6.5	5.3	8.5	U	2.4	3	4.9	U	0.84	2.8	4.7	U	13	7.9	12	TI	0.72	6.5	11	U	-7	19	33	U	13	57	94	U	7.2	14	30	U	-2.3	7.3	13	U
Rio Chama at Chamita	S	7/21/2009	20:11	-0.96	6.2	12	U	-0.18	5.2	9	U	0.25	3.1	5.4	U	-0.57	3.2	5.6	U	9.2	8.3	13	U	5	3.1	4.9	TI	1.4	12	20	U	-17	45	75	U	7.9	8.9	16	U	-2.1	8.3	14	U
Rio Chama at Chamita	B	8/10/2009	13:50	1.7	5.7	11	U	-3.4	3.6	6.4	U	-0.73	2.7	4.6	U	-0.29	2.7	4.6	U	5.8	6.1	9.7	U	0.86	4.9	8.2	U	16	17	27	U	6.4	71	120	U	13	12	19	U	-2.7	6.2	11	U
Rio Grande at Lyden	S	9/13/2009	3:14	1.9	4.2	7.4	U	0.49	2.7	4.6	U	-0.12	2.2	3.8	U	-1.1	2	3.6	U	0.5	4.2	6.9	U	2.5	1.8	2.9	U	-4.5	12	20	U	5.8	52	86	U	-8.2	19	31	U	1	4.7	7.9	U
Rio Grande at Buckman	S	6/27/2009	0:34	8.8	6.8	12	U	-1.2	6.2	11	U	0.39	3.3	5.5	U	-1.1	3.5	6.1	U	-0.3	10	17	U	0.94	5	8.4	U	5.5	20	33	U	35	79	130	U	0.13	11	19	U	-1.9	8.2	14	U
Rio Grande at Buckman	S, DUP	6/27/2009	0:34	7.8	6.2	11	U	-0.44	5.3	9.1	U	-1.4	3.2	5.4	U	0.47	3	5	U	8.5	8.9	14	U	2.5	6.6	11	U	1.7	18	29	U	-34	79	130	U	12	12	19	U	-4.5	7.6	13	U
Rio Grande at Buckman	S	7/4/2009	18:18	0.45	6.8	13	U	-9.9	5.3	9.6	U	0.34	3.3	5.7	U	0	3.2	5.6	U	3.9	8.5	14	U	4.1	3.1	5	U	-13	16	27	U	49	47	76	U	9.4	14	23	U	-2.9	11	19	U
Rio Grande at Buckman	S, DUP	7/4/2009	18:18	-2	7.1	12	U	2.1	5.6	9.4	U	1.8	3.3	5.4	U	-0.034	3.4	5.9	U	4.4	7.8	13	U	-1	7	12	U	0.96	13	22	U	-22	79	130	U	18	11	18	U	2.8	8.3	14	U
Rio Grande at Buckman	S	7/30/2009	14:54	4.6	7	13	U	-2.5	4.8	8.3	U	-1.1	3.5	6	U	0.45	3.3	5.6	U	-0.24	7.6	13	U	6.5	3.3	5	TI	-26	16	27	U	89	47	74	TI	-16	25	42	U	8.5	7.8	13	U
Rio Grande at Buckman	S	8/13/2009	19:09	4.4	5.7	11	U	-0.3	4	6.8	U	0.11	2.8	4.7	U	1.6	3.3	5.5	U	4.7	5.7	9.2	U	1.1	4.5	7.5	U	6.8	20	40	U	3.6	75	120	U	14	8.4	13	TI	4.2	7.1	12	U
Rio Grande at Otowi	S	6/26/2009	23:45	1.4	7.1	13	U	-2.6	7.4	13	U	1.5	3.7	6.1	U	-2.3	3.4	6.1	U	-3.2	9.8	17	U	-1.3	6.9	12	U	-2.5	13	23	U	-47	84	140	U	18	12	18	U	0	8.6	15	U
Rio Grande at Otowi	S	7/4/2009	17:36	6	7	13	U	0.56	5.9	10	U	-1.7	3.5	6.1	U	-1.3	3.1	5.5	U	6.1	5.7	9.1	U	5.6	3.1	4.8	TI	-3.2	24	39	U	36	95	160	U	3.4	25	41	U	3.8	8.4	14	U
Rio Grande at Otowi	S, DUP	7/4/2010	17:36	5.3	6.4	11	U	-4.6	5.1	8.9	U	0.36	2.9	5.1	U	1.7	3.4	5.6	U	2.6	7.4	12	U	-0.59	5.3	8.9	U	0.1	20	33	U	47	64	110	U	-13	22	37	U	-4.1	7.8	14	U
Rio Grande at Otowi	S	7/22/2009	0:07	0.027	5.6	10	U	-0.28	4.6	7.8	U	0.72	2.9	4.9	U	-1.4	2.8	4.9	U	12	7.4	11	TI	-1.7	4.9	8.4	U	0	19	32	U	18	53	88	U	1	24	40	U	2.1	7.3	12	U
Rio Grande at Otowi	S	8/13/2009	18:23	9.6	6.9	12	U	3	4.6	7.7	U	-0.6	3.1	5.3	U	1.5	3.3	5.5	U	3.2	6.3	10	U	-0.45	5.9	9.9	U	0.56	13	22	U	-52	84	140	U	8.7	11	18	U	2.9	7.3	12	U
Rio Grande above Alameda	S	7/21/2009	19:42	1.6	5.1	9	U	-1.6	3.2	5.6	U	-1.3	2.2	3.9	U	0.88	2.4	4.1	U	1.5	4.5	7.4	U	2.2	2.1	3.5	U	0.35	11	18	U	22	59	98	U	-2.9	9.5	16	U	-3.8	5.1	9.1	U
Rio Grande above Alameda	S	9/9/2009	22:42	2.5	4.5	8.1	U	0.074	3.3	5.6	U	1.8	2.2	3.6	U	-1.5	2.2	3.9	U	5.2	4.4	6.9	U	0.79	3.2	5.4	U	-9.6	17	28	U	39	32	52	U	0.88	9.7	16	U	-3.9	5.5	9.7	U
Rio Grande above Alameda	S	9/11/2009	20:24	1.9	4.2	7.4	U	0.49	2.7	4.6	U	-0.12	2.2	3.8	U	-1.1	2	3.6	U	0.5	4.2	6.9	U	2.5	1.8	2.9	U	-4.5	12	20	U	5.8	52	86	U	-8.2	19	31	U	1	4.7	7.9	U
Rio Grande above Alameda	S, DUP	9/11/2009	20:24	0.97	4.4	8	U	0.23	3	5.1	U	1	1.9	3.1	U	-0.79	2.5	4.3	U	3.8	4.2	6.8	U	3.2	2	3.2	U	3.7	14	23	U	18	51	85	U	-2.9	14	24	U	1.8	5	8.5	U
Rio Grande above Alameda	S	9/16/2009	23:15	-2.3	5.2	8.8	U	-0.071	3	5.2	U	0.077	2.1	3.5	U	0.92	2.2	3.6	U	0.97	4.4	7.3	U	2.9	2.2	3.6	U	-0.12	8.5	14	U	-8.1	29	49	U	-4.1	15	24	U	-2	7.7	13	U
Rio Grande above Alameda	S	9/17/2009	11:50	5.4	4	6.8	U	1.6	2.8	4.6	U	0.44	1.9	3.2	U	-0.46	1.9	3.3	U	7	4.3	6.6	TI	0.29	3.7	6.1	U	-2.6	14	23	U	-13	41	67	U	2.7	13	21	U	-1.9	4.7	8.2	U

Table 4d (continued) Non-representative Data

Sample Location	Sample Type	Date	Time	Result	UNC	MDA	Result	UNC	MDA	Result	UNC	MDA	Result	UNC	MDA	Result	UNC	MDA	Result	UNC	MDA	Result	UNC	MDA	Result	UNC	MDA	Result	UNC	MDA	Result	UNC	MDA										
				pci/L	pci/L	pci/L	pci/L	pci/L	pci/L	pci/L	pci/L	pci/L	pci/L	pci/L	pci/L	pci/L	pci/L	pci/L	pci/L	pci/L	pci/L	pci/L	pci/L	pci/L	pci/L	pci/L	pci/L	pci/L	pci/L	pci/L	pci/L	pci/L	pci/L										
Rio Grande at Buckman	Equipment Malfunction	7/19/2009	23:46	4.9	6.5	12	U	2	5.6	9.4	U	3.5	3.4	5.4	U	3.1	3.4	5.6	U	2.5	7.5	12	U	-0.88	6.7	11	U	9.3	13	21	U	-42	83	140	U	19	11	18	TI	-2.7	7.9	14	U

U - Result is less than the sample specific MDC or less than the associated TPU

M - Requested MCD not met.

W - DER is greater than Warning Limit of 1.42

J - Estimated value for lead and bismuth 214 to note bias whenever a multipoint calibration is used

TI - Nuclide identification is tentative.

SI - Nuclide identification and/or quantitation is tentative.

Table 5. Suspended Sediment Concentration (SSC), and Percent Particle Size for the Clay and Sand Fraction in Storm Flow from the Rio Grande and Chama River 2009

Sample Location	Date	Time	Sample Type (S) Storm Water, (B) Baseline	Suspended Sediment Concentration (SSC) mg/L	Sieve fraction=1.0-2.0 mm. For soil: Very Coarse Sand %	Laser fraction=0.5-1.0 mm. For soil: Coarse Sand %	Laser fraction=0.25-0.5 mm. For soil: Medium Sand %	Laser fraction=0.20-0.25 mm. For soil: Fine Sand %	Laser fraction=0.15-0.20 mm. For soil: Fine Sand %	Laser fraction=0.125-0.150 mm. For soil: Fine Sand %	Laser fraction=0.100-0.125 mm. For soil: Very Fine Sand %	Laser fraction=0.075-0.100 mm. For soil: Very Fine Sand %	Laser fraction=0.0625-0.075 mm. For soil: Very Fine Sand %	Laser fraction=0.0015-0.002mm. For soil: Clay %	Laser fraction=0.0010-0.0015mm. For soil: Clay %	Laser fraction=0.0005-0.0010mm. For soil: Clay %	Laser fraction=0.0001-0.0005mm. For soil: Clay %
Units																	
Rio Chama at Chamita	6/26/2009	20:05	S	4,257	0	0	0.4	0.8	2.6	2.8	4.4	6.7	4.6	3.5	3.8	4.8	0.6
Rio Chama at Chamita	7/13/2009	18:11	S	946	0	0	0.1	0.4	1.3	1.5	2.7	5.5	4.9	2.1	2.2	3.1	0.3
Rio Chama at Chamita	7/21/2009	20:11	S	1,040	0	0	0.8	2.3	6.7	6.3	9.1	12.1	7.2	1.3	1.6	2.5	0.4
Rio Grande at Lyden	9/13/2009	3:14	S	405	0	0	0.7	0.1	0.1	0.7	2.5	6.7	6	2.7	2.5	3.2	0
Rio Grande at Otowi	6/26/2009	23:45	S	1,912	0	0	0.1	0.1	0.5	0.7	1.5	3.1	2.6	5.5	5.7	6.4	0.8
Rio Grande at Otowi	7/4/2009	17:36	S	410	0	0	2.6	1.9	4	3.9	6.5	10.4	7	1.5	1.2	1.6	0
Rio Grande at Otowi	7/22/2009	0:07	S	1,911	0	0	0.1	1.1	4.8	5.5	9	13.6	8.6	1.4	1.4	2.2	0
Rio Grande at Otowi	8/13/2009	18:23	S	1,896	0	0	0	0.3	2.6	3.8	7.2	12.2	8.2	2	1.9	2.5	0
Rio Grande at Buckman	6/27/2009	0:34	S	1,361	0	0	0	0	0.3	0.7	1.7	3.4	2.6	5.3	5.6	6.2	1
Rio Grande at Buckman	7/4/2009	18:18	S	534	0	0	1.3	2.3	5.4	4.8	7.3	11	7	1.7	1.5	2.1	0
Rio Grande at Buckman	7/30/2009	14:54	S	1,523	0	0	0.2	0.1	0.3	0.4	1.1	2.7	2.8	3.8	3.8	4.4	0.3
Rio Grande at Buckman	8/13/2009	19:09	S	1,393	0	0	0.1	0.2	1.5	2.6	5.4	10.3	7.8	1.7	1.8	2.6	0.1
Rio Grande above Alameda	7/10/2009	14:30	B	347	0	0	1.7	0.9	0.9	1	3	8.2	7.3	3.1	3.3	4.6	1
Rio Grande above Alameda	7/21/2009	19:42	S	2,407	0	0	0.6	0.6	1.3	1.3	2.1	3.5	2.8	3.3	3.3	4.1	0.6
Rio Grande above Alameda	9/9/2009	22:42	S	1,020	0	0	0.5	0.4	0.7	0.9	1.6	2.9	2.4	4.8	4.9	5.8	1.1
Rio Grande above Alameda	9/11/2009	20:24	S	513	0	0	0.1	0.1	0.5	0.7	1.4	3.1	2.7	5.8	6	6.5	1.3
Rio Grande above Alameda	9/16/2009	23:15	S	1,645	0	0	0.4	0.4	0.9	0.9	1.6	2.8	2.3	5.1	5.6	6.7	2
Rio Grande above Alameda	9/17/2009	11:50	S	1,221	0	0	0.7	0.5	1.1	1.2	2.1	3.7	2.9	4.5	4.8	6	1.5

Table 5a Non-representative Data

Sample Location	Date	Time	Sample Type (S) Storm Water, (B) Baseline	Suspended Sediment Concentration (SSC) mg/L	Sieve fraction=1.0-2.0 mm. For soil: Very Coarse Sand %	Laser fraction=0.5-1.0 mm. For soil: Coarse Sand %	Laser fraction=0.25-0.5 mm. For soil: Medium Sand %	Laser fraction=0.20-0.25 mm. For soil: Fine Sand %	Laser fraction=0.15-0.20 mm. For soil: Fine Sand %	Laser fraction=0.125-0.150 mm. For soil: Fine Sand %	Laser fraction=0.100-0.125 mm. For soil: Very Fine Sand %	Laser fraction=0.075-0.100 mm. For soil: Very Fine Sand %	Laser fraction=0.0625-0.075 mm. For soil: Very Fine Sand %	Laser fraction=0.0015-0.002mm. For soil: Clay %	Laser fraction=0.0010-0.0015mm. For soil: Clay %	Laser fraction=0.0005-0.0010mm. For soil: Clay %	Laser fraction=0.0001-0.0005mm. For soil: Clay %
Rio Grande at Buckman	7/19/2009	23:46	Equipment Malfunction	7,544	0	0	26.2	23.9	24.5	8.4	4.8	2.4	0.8	0.3	0.4	0.6	0.1

Table 6. Percent Particle Size for the Silt Fraction in Storm Flow from the Rio Grande and Chama River 2009

Sample Location	Date	Time	Sample Type (S) Storm Water, (B) Baseline	Laser fraction=0.05-0.0625 mm. For soil: Coarse Silt (Mud)	Laser fraction=0.04-0.05 mm. For soil: Coarse Silt (Mud)	Laser fraction=0.03-0.04 mm. For soil: Coarse Silt (Mud)	Laser fraction=0.02-0.03 mm. For soil: Coarse Silt (Mud)	Laser fraction=0.019-0.020 mm. For soil: Coarse Silt (Mud)	Laser fraction=0.018-0.019 mm. For soil: Coarse Silt (Mud)	Laser fraction=0.017-0.018 mm. For soil: Coarse Silt (Mud)	Laser fraction=0.016-0.017 mm. For soil: Coarse Silt (Mud)	Laser fraction=0.015-0.016 mm. For soil: Coarse Silt (Mud)	Laser fraction=0.014-0.015 mm. For soil: Fine and Very Fine Silt (Mud)	Laser fraction=0.013-0.014 mm. For soil: Fine and Very Fine Silt (Mud)
Units				%	%	%	%	%	%	%	%	%	%	%
Rio Chama at Chamita	6/26/2009	20:05	S	5.9	5.9	7	8.3	1	1.1	1.1	1.2	1.3	1.4	1.5
Rio Chama at Chamita	7/13/2009	18:11	S	7.5	8.8	11.8	14.1	1.5	1.5	1.6	1.6	1.6	1.6	1.7
Rio Chama at Chamita	7/21/2009	20:11	S	8.2	7.7	8.4	8	0.8	0.8	0.8	0.8	0.8	0.8	0.8
Rio Grande at Lyden	9/13/2009	3:14	S	8.4	8.5	9.6	10.1	1.1	1.2	1.2	1.3	1.4	1.5	1.6
Rio Grande at Otowi	6/26/2009	23:45	S	3.6	3.6	4.4	6.4	0.9	1	1.1	1.3	1.4	1.6	1.8
Rio Grande at Otowi	7/4/2009	17:36	S	8.3	7.7	8.1	7.8	0.8	0.9	0.9	0.9	1	1.1	1.1
Rio Grande at Otowi	7/22/2009	0:07	S	9.5	8.1	8.4	7.8	0.8	0.8	0.8	0.8	0.8	0.8	0.8
Rio Grande at Otowi	8/13/2009	18:23	S	9.4	8.3	8.6	7.9	0.8	0.8	0.8	0.8	0.9	0.9	1
Rio Grande at Buckman	6/27/2009	0:34	S	3.3	3.3	4.1	6.4	1	1.1	1.2	1.3	1.4	1.6	1.8
Rio Grande at Buckman	7/4/2009	18:18	S	7.8	6.8	7.3	7.4	0.8	0.8	0.8	0.9	0.9	1	1.1
Rio Grande at Buckman	7/30/2009	14:54	S	4.8	6.1	8.6	11.4	1.4	1.4	1.5	1.6	1.7	1.8	1.9
Rio Grande at Buckman	8/13/2009	19:09	S	10.2	10.1	11.4	10.9	1	1	1	1	1	1	1.1
Rio Grande above Alameda	7/10/2009	14:30	B	9.7	8.8	8.4	7.5	0.8	0.8	0.9	0.9	1	1	1.1
Rio Grande above Alameda	7/21/2009	19:42	S	4.1	4.9	7.1	9.7	1.2	1.3	1.4	1.5	1.6	1.8	1.9
Rio Grande above Alameda	9/9/2009	22:42	S	3.6	4.2	5.3	6.8	0.9	1	1.1	1.2	1.3	1.5	1.7
Rio Grande above Alameda	9/11/2009	20:24	S	3.8	3.9	4.2	4.8	0.6	0.7	0.8	0.9	1	1.2	1.3
Rio Grande above Alameda	9/16/2009	23:15	S	3.5	4	5.2	7	0.9	1	1.1	1.2	1.3	1.4	1.6
Rio Grande above Alameda	9/17/2009	11:50	S	4.1	4.4	5.5	7.1	0.9	1	1.1	1.2	1.3	1.5	1.7

Table 6a Non-representative Data

Sample Location	Date	Time	Sample Type (S) Storm Water, (B) Baseline	Laser fraction=0.05-0.0625 mm. For soil: Coarse Silt (Mud)	Laser fraction=0.04-0.05 mm. For soil: Coarse Silt (Mud)	Laser fraction=0.03-0.04 mm. For soil: Coarse Silt (Mud)	Laser fraction=0.02-0.03 mm. For soil: Coarse Silt (Mud)	Laser fraction=0.019-0.020 mm. For soil: Coarse Silt (Mud)	Laser fraction=0.018-0.019 mm. For soil: Coarse Silt (Mud)	Laser fraction=0.017-0.018 mm. For soil: Coarse Silt (Mud)	Laser fraction=0.016-0.017 mm. For soil: Coarse Silt (Mud)	Laser fraction=0.015-0.016 mm. For soil: Coarse Silt (Mud)	Laser fraction=0.014-0.015 mm. For soil: Fine and Very Fine Silt (Mud)	Laser fraction=0.013-0.014 mm. For soil: Fine and Very Fine Silt (Mud)
Units				%	%	%	%	%	%	%	%	%	%	%
Rio Grande at Buckman	7/19/2009	23:46	Equipment Malfunction	0.9	0.9	0.9	1	0.1	0.1	0.1	0.1	0.1	0.1	0.2

Table 6. Percent Particle Size for the Silt Fraction in Storm Flow from the Rio Grande and Chama River 2009 (Continued)

Sample Location	Date	Time	Sample Type (S) Storm Water, (B) Baseline	Laser fraction=0.012-	Laser fraction=0.011-	Laser fraction=0.010-	Laser fraction=0.009-	Laser fraction=0.008-	Laser fraction=0.007-	Laser fraction=0.006-	Laser fraction=0.005-	Laser fraction=0.004-	Laser fraction=0.003-	Laser fraction=0.002-
				0.013 mm. For soil: Fine and Very Fine Silt (Mud)	0.012 mm. For soil: Fine and Very Fine Silt (Mud)	0.011 mm. For soil: Fine and Very Fine Silt (Mud)	0.010 mm. For soil: Fine and Very Fine Silt (Mud)	0.009 mm. For soil: Fine and Very Fine Silt (Mud)	0.008 mm. For soil: Fine and Very Fine Silt (Mud)	0.007 mm. For soil: Fine and Very Fine Silt (Mud)	0.006 mm. For soil: Fine and Very Fine Silt (Mud)	0.005 mm. For soil: Fine and Very Fine Silt (Mud)	0.004mm. For soil: Fine and Very Fine Silt (Mud)	0.003mm. For soil: Fine and Very Fine Silt (Mud)
Units				%	%	%	%	%	%	%	%	%	%	%
Rio Chama at Chamita	6/26/2009	20:05	S	1.6	1.7	1.8	1.9	2	2.2	2.4	2.8	3.4	4.2	5.4
Rio Chama at Chamita	7/13/2009	18:11	S	1.7	1.8	1.8	1.8	1.8	1.8	1.8	2	2.2	2.6	3.2
Rio Chama at Chamita	7/21/2009	20:11	S	0.8	0.9	0.9	0.9	0.9	0.9	0.9	1.1	1.3	1.5	1.9
Rio Grande at Lyden	9/13/2009	3:14	S	1.7	1.8	2	2.1	2.2	2.3	2.5	2.8	3.2	3.7	4.3
Rio Grande at Otowi	6/26/2009	23:45	S	2	2.2	2.4	2.7	3.1	3.5	4	4.7	5.6	7	9
Rio Grande at Otowi	7/4/2009	17:36	S	1.2	1.3	1.4	1.5	1.6	1.8	2	2.2	2.4	2.6	2.8
Rio Grande at Otowi	7/22/2009	0:07	S	0.9	0.9	0.9	0.9	0.9	1	1	1.2	1.4	1.7	2.1
Rio Grande at Otowi	8/13/2009	18:23	S	1.1	1.1	1.2	1.3	1.4	1.5	1.6	1.9	2.2	2.6	3.1
Rio Grande at Buckman	6/27/2009	0:34	S	2	2.3	2.5	2.8	3.2	3.6	4.1	4.8	5.7	6.9	8.9
Rio Grande at Buckman	7/4/2009	18:18	S	1.2	1.3	1.3	1.4	1.5	1.6	1.8	2.1	2.4	2.6	2.8
Rio Grande at Buckman	7/30/2009	14:54	S	2.1	2.2	2.4	2.6	2.8	3	3.3	3.7	4.4	5.2	6.3
Rio Grande at Buckman	8/13/2009	19:09	S	1.1	1.1	1.1	1.2	1.2	1.2	1.3	1.5	1.8	2.1	2.6
Rio Grande above Alameda	7/10/2009	14:30	B	1.1	1.2	1.3	1.4	1.5	1.7	1.9	2.4	3	3.8	4.9
Rio Grande above Alameda	7/21/2009	19:42	S	2.1	2.3	2.6	2.8	3.1	3.4	3.7	4.2	4.7	5.2	5.8
Rio Grande above Alameda	9/9/2009	22:42	S	1.9	2.1	2.4	2.7	3.1	3.6	4.2	4.9	5.9	6.9	8.1
Rio Grande above Alameda	9/11/2009	20:24	S	1.6	1.8	2.1	2.5	3	3.5	4.3	5.2	6.5	8.1	10.1
Rio Grande above Alameda	9/16/2009	23:15	S	1.8	2	2.2	2.5	2.8	3.2	3.7	4.4	5.4	6.6	8.3
Rio Grande above Alameda	9/17/2009	11:50	S	1.8	2.1	2.3	2.6	2.9	3.2	3.7	4.3	5.1	6	7.3

Table 6b Non-representative Data

Sample Location	Date	Time	Sample Type (S) Storm Water, (B) Baseline	Laser fraction=0.012-	Laser fraction=0.011-	Laser fraction=0.010-	Laser fraction=0.009-	Laser fraction=0.008-	Laser fraction=0.007-	Laser fraction=0.006-	Laser fraction=0.005-	Laser fraction=0.004-	Laser fraction=0.003-	Laser fraction=0.002-
				0.013 mm. For soil: Fine and Very Fine Silt (Mud)	0.012 mm. For soil: Fine and Very Fine Silt (Mud)	0.011 mm. For soil: Fine and Very Fine Silt (Mud)	0.010 mm. For soil: Fine and Very Fine Silt (Mud)	0.009 mm. For soil: Fine and Very Fine Silt (Mud)	0.008 mm. For soil: Fine and Very Fine Silt (Mud)	0.007 mm. For soil: Fine and Very Fine Silt (Mud)	0.006 mm. For soil: Fine and Very Fine Silt (Mud)	0.005 mm. For soil: Fine and Very Fine Silt (Mud)	0.004mm. For soil: Fine and Very Fine Silt (Mud)	0.003mm. For soil: Fine and Very Fine Silt (Mud)
Units				%	%	%	%	%	%	%	%	%	%	%
Rio Grande at Buckman	7/19/2009	23:46	Equipment Malfunction	0.2	0.2	0.2	0.2	0.2	0.2	0.2	0.3	0.3	0.4	0.5

Table 7. SSC, Sand Fraction, Silt Fraction, and Clay Fraction in Storm Flow from the Rio Grande and Chama River 2009

Sample Location	Date	Time	Sample Type (S) Storm Water, (B) Baseline	SSC	Total Sand (>0.0625mm)	Silt (Mud) (0.0625mm - 0.002mm)	Clay (0.002mm - 0.00001mm)
Units				mg/L	%	%	%
Rio Chama at Chamita	6/26/2009	20:05	S	4,257	22.3	65.1	12.7
Rio Chama at Chamita	7/13/2009	18:11	S	946	16.4	75.8	7.7
Rio Chama at Chamita	7/21/2009	20:11	S	1,040	44.5	49.9	5.8
Rio Grande at Lyden	9/13/2009	3:14	S	405	16.8	74.5	8.4
Rio Grande at Otowi	6/26/2009	23:45	S	1,912	8.6	73.3	18.4
Rio Grande at Otowi	7/4/2009	17:36	S	410	36.3	59.4	4.3
Rio Grande at Otowi	7/22/2009	0:07	S	1,911	42.7	52.3	5
Rio Grande at Otowi	8/13/2009	18:23	S	1,896	34.3	59.2	6.4
Rio Grande at Buckman	6/27/2009	0:34	S	1,361	8.7	73.3	18.1
Rio Grande at Buckman	7/4/2009	18:18	S	534	39.1	55.6	5.3
Rio Grande at Buckman	7/30/2009	14:54	S	1,523	7.6	80.2	12.3
Rio Grande at Buckman	8/13/2009	19:09	S	1,393	27.9	65.9	6.2
Rio Grande above Alameda	7/10/2009	14:30	B	347	23	65.1	12
Rio Grande above Alameda	7/21/2009	19:42	S	2,407	12.2	76.4	11.3
Rio Grande above Alameda	9/9/2009	22:42	S	1,020	9.4	74.4	16.6
Rio Grande above Alameda	9/11/2009	20:24	S	513	8.6	71.9	19.6
Rio Grande above Alameda	9/16/2009	23:15	S	1,645	9.3	71.1	19.4
Rio Grande above Alameda	9/17/2009	11:50	S	1,221	12.2	71.1	16.8

Table 7a Non-representative Data

Sample Location	Date	Time	Sample Type (S) Storm Water, (B) Baseline	SSC	Total Sand (>0.0625mm)	Silt (Mud) (0.0625mm - 0.002mm)	Clay (0.002mm - 0.00001mm)
Units				mg/L	%	%	%
Rio Grande at Buckman	7/19/2009	23:46	Equipment Malfunction	7,544	91	7.4	1.4

Table 8. Former PCB End Uses for Various Aroclors

End Use	Aroclor			
	1242	1248	1254	1260
Capacitors			*	
Transformers	*		*	*
Heat transfer	*			
Hydraulics/lubricants				
Hydraulic fluids	*	*	*	*
Vacuum pumps		*	*	
Gas-transmission turbines	*			
Plasticizers:				
Rubbers	*	*	*	
Synthetic resins		*	*	*
Carbonless paper	*			
Miscellaneous:				
Adhesives	*	*	*	
Wax extenders	*		*	
Dedusting agents			*	*
Inks			*	
Cutting oils			*	
Pesticide extenders			*	
Sealants and Caulking Compounds			*	

Figure 1. Rio Grande and Chama River Water Quality Monitoring Locations

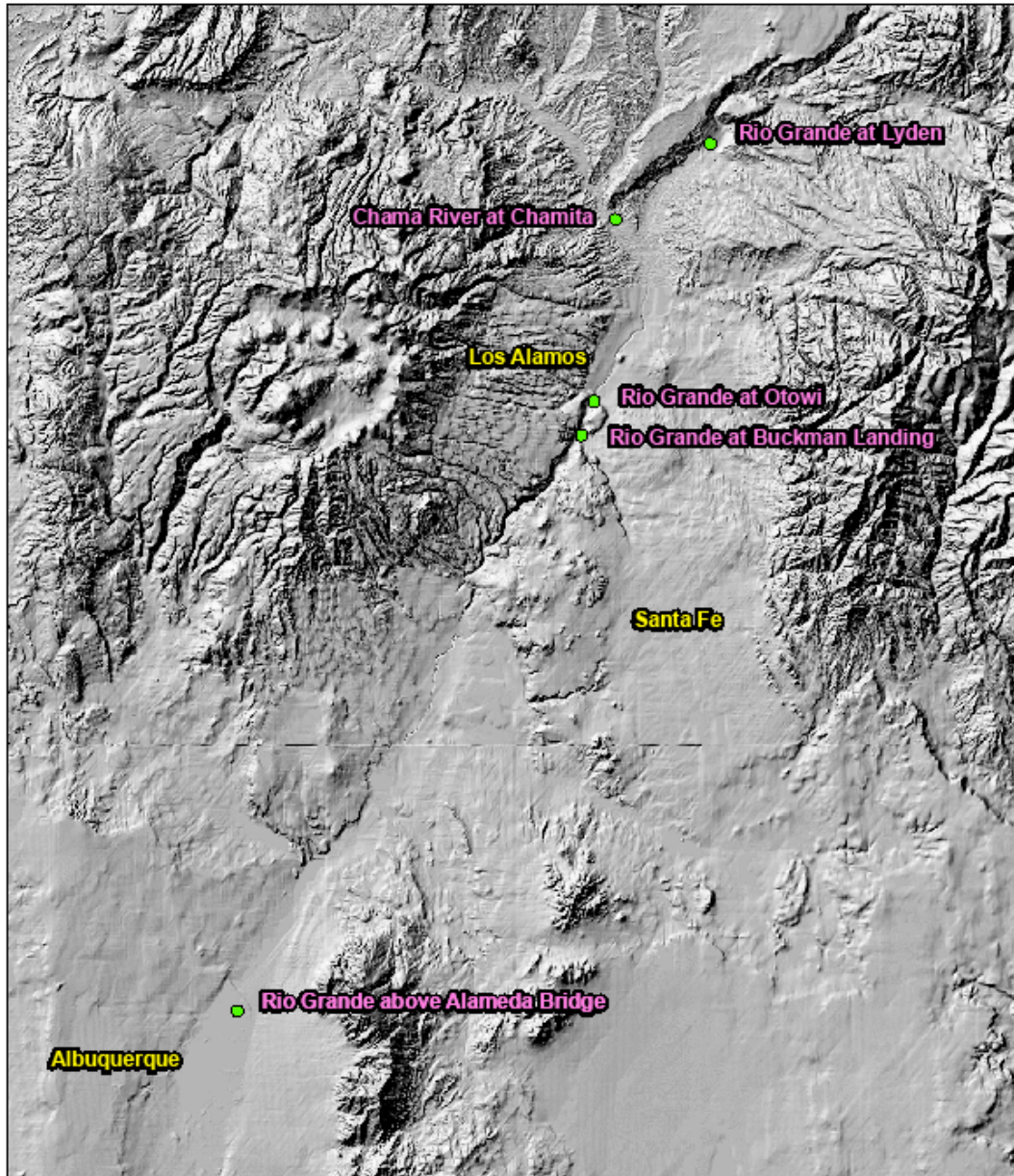

NMED Rio Grande water quality monitoring locations, Q4 FY2009

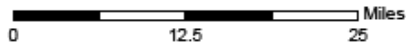

Figure 1b shows the sampler location for the Rio Grande above Alameda samples. The sampler was located south of the northern boundary of the Rio Grande State Park (shaded area along the Rio Grande in center-left of figure). The sampler is located approximately 1/3 mile downstream from the confluence of the NDC and the Rio Grande. The NDC near Alameda USGS gage is located in the lower right hand corner.

Figure 1B Sample Location for Rio Grande above Alameda

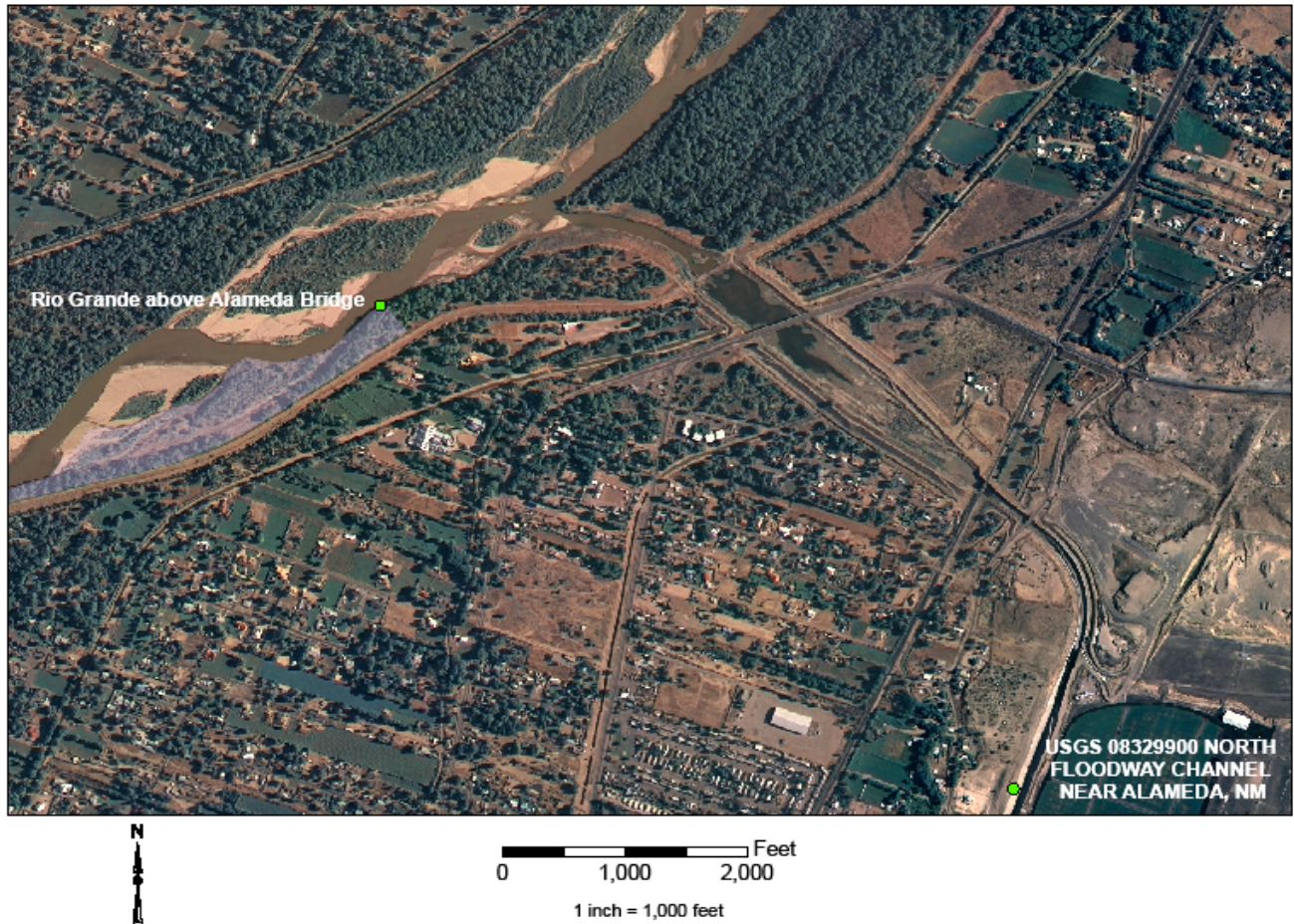
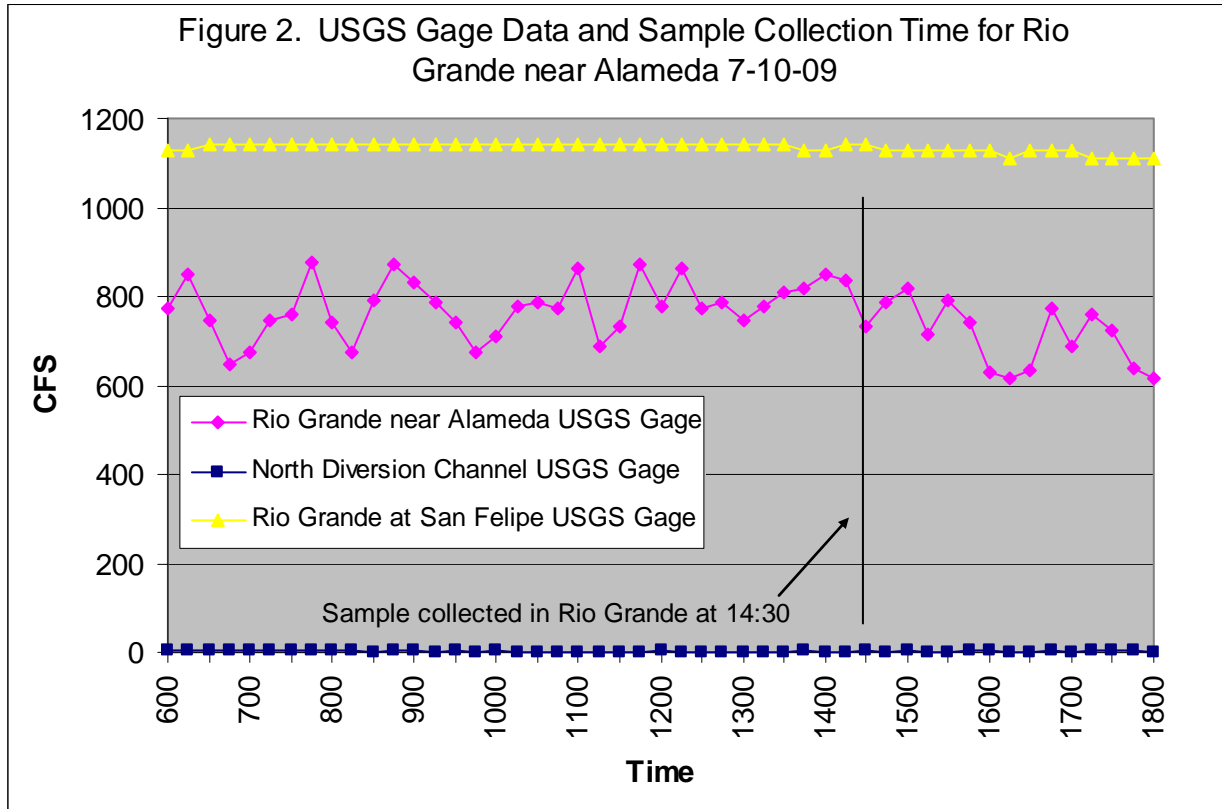

Figure 2 demonstrates flows in the Rio Grande at San Felipe and near Alameda USGS gages along with the NDC during the 7-10-09 baseflow sample collected at the Rio Grande above Alameda location. Flows were steady at the Rio Grande at San Felipe and Rio Grande near Alameda gages and there was no discharge from the NDC at the time of sample.



The distance between USGS gages along the Rio Grande and in the NDC largely govern the relative time delays in response to precipitation caused runoff events. Flow registered at the San Felipe gage at the Rio Grande (22.4 miles upstream) takes approximately 8 hours to manifest at the Rio Grande above Alameda gage. It takes approximately 40 minutes for flows registered at the NDC gage to manifest at the Rio Grande above Alameda sampling station and approximately one hour and 30 minutes for flows from the NDC gage to manifest at the Rio Grande above Alameda gage. These travel times may vary considerably depending on the volume of water discharged from the NDC, changing flows from upstream (Cochiti Reservoir releases or other tributary influences), and the actual flow in the Rio Grande.

Figure 3 demonstrates flows in the Rio Grande at San Felipe and near Alameda USGS gages along with the NDC during the time of the 7-21-09 storm flow sample collection. Flows were steady in the Rio Grande at San Felipe for over 8 hours prior to sample collection. Discharge from the NDC peaked at 19:00, the sampler was enabled at 19:21, and the sample was collected in the Rio Grande at 19:42.

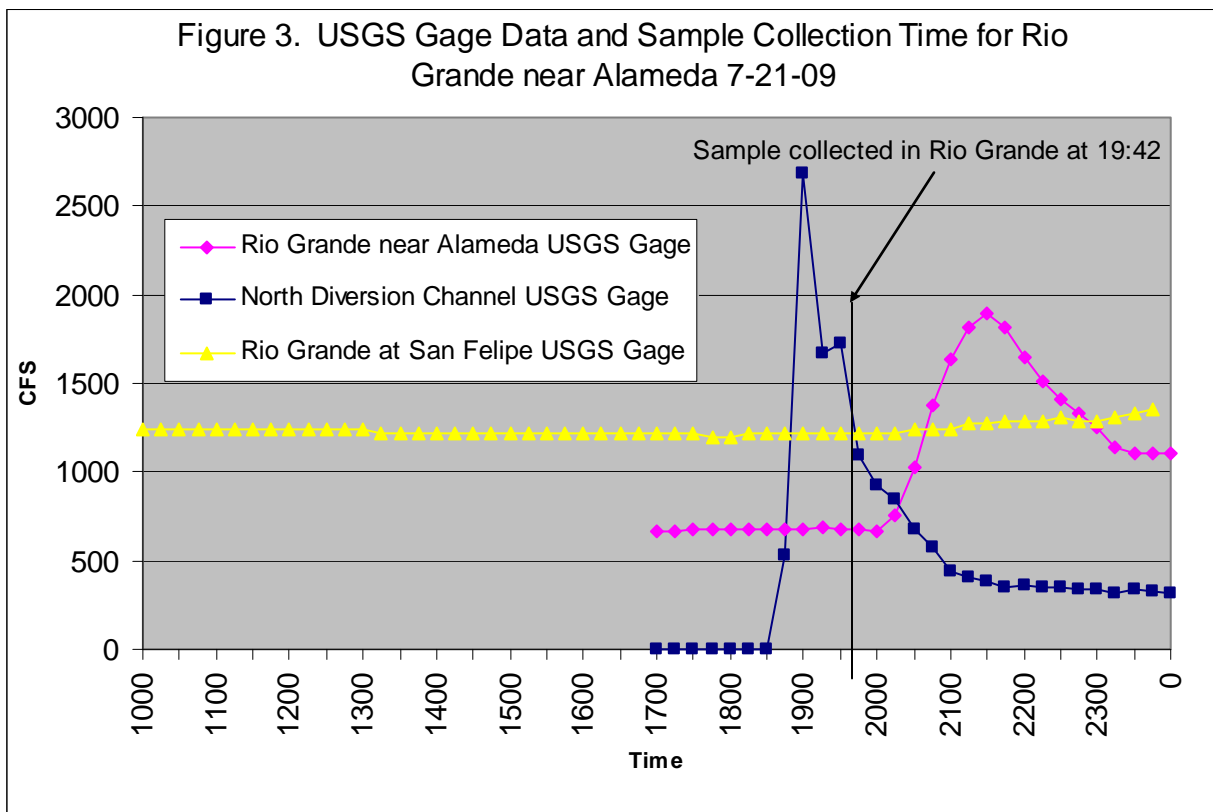

Figure 4 is a copy of the strip chart from the ISCO sampler and shows that the sample was collected near the peak of the hydrograph as the storm surge passed the sampler location.

Figure 4. ISCO Sampler Hydrograph and Sample Collection times for Rio Grande above Alameda 7-21-09

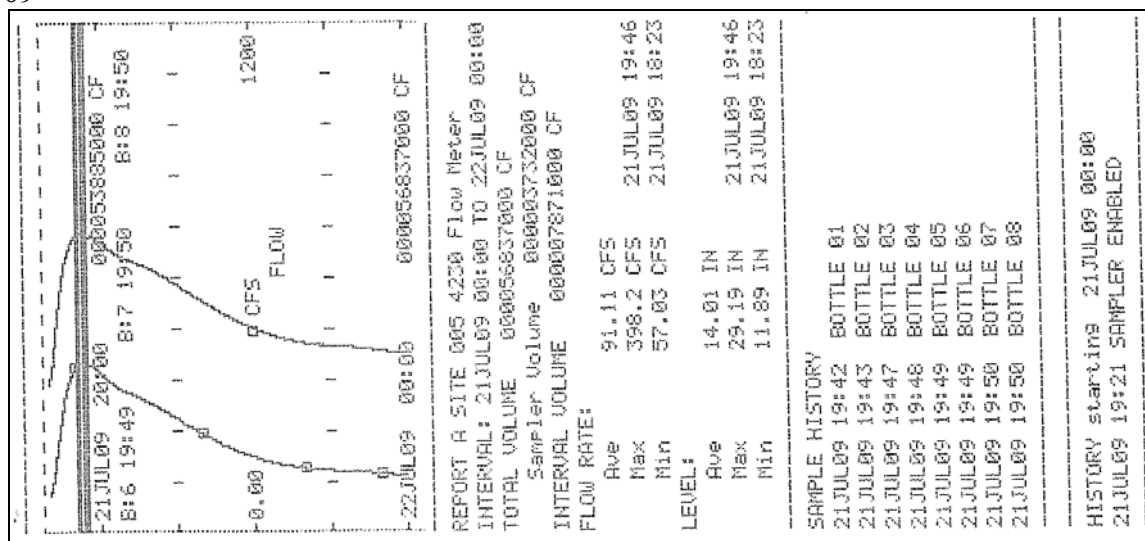

Figure 5 demonstrates flows in the Rio Grande at San Felipe and near Alameda USGS gages along with the NDC during the time of the 9-9-09 storm flow sample collection. Flows were steady in the Rio Grande at San Felipe for over 8 hours prior to sample collection. Discharge from the NDC peaked at 22:15, sampler was enabled at 22:21, and the sample was collected in the Rio Grande at 22:42.

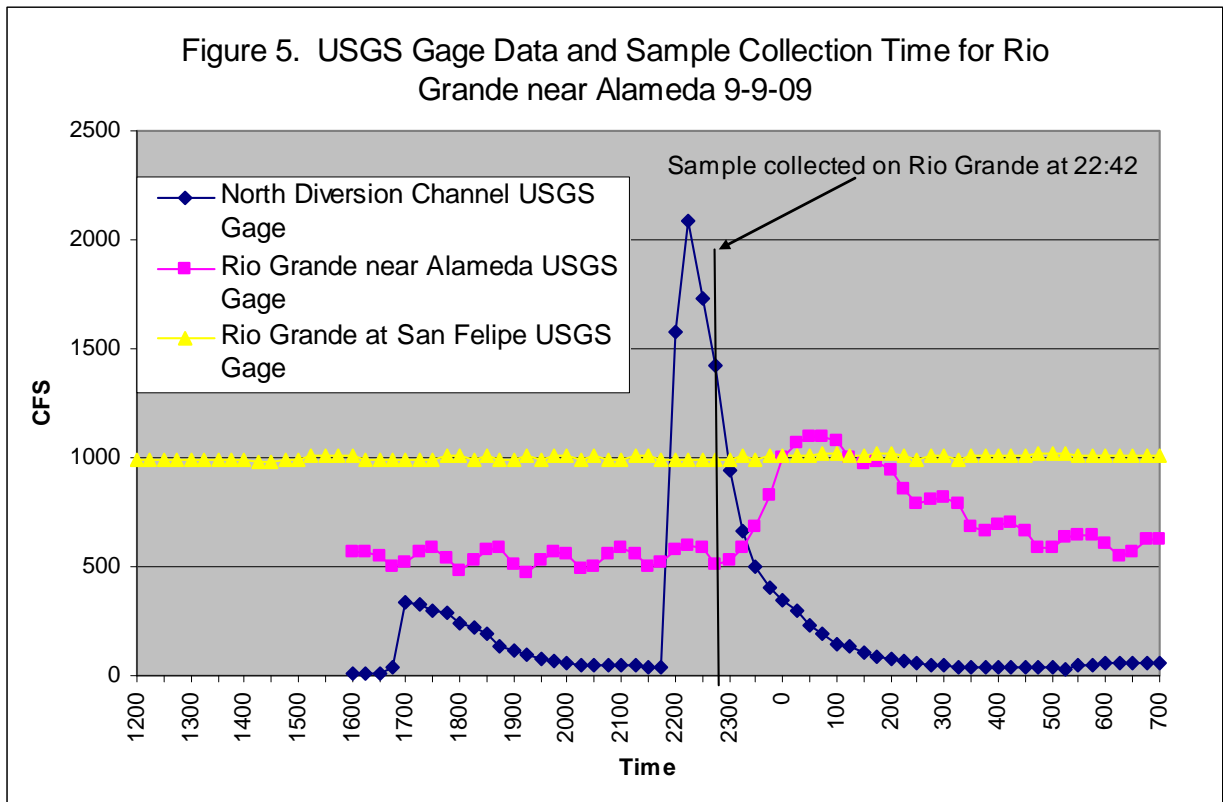

Figure 6 is a copy of the strip chart from the ISCO sampler and shows that the sample was collected near the peak of the hydrograph as the storm surge passed the sampler location.

Figure 6. ISCO Sampler Hydrograph and Sample Collection times for Rio Grande above Alameda 9-9-09

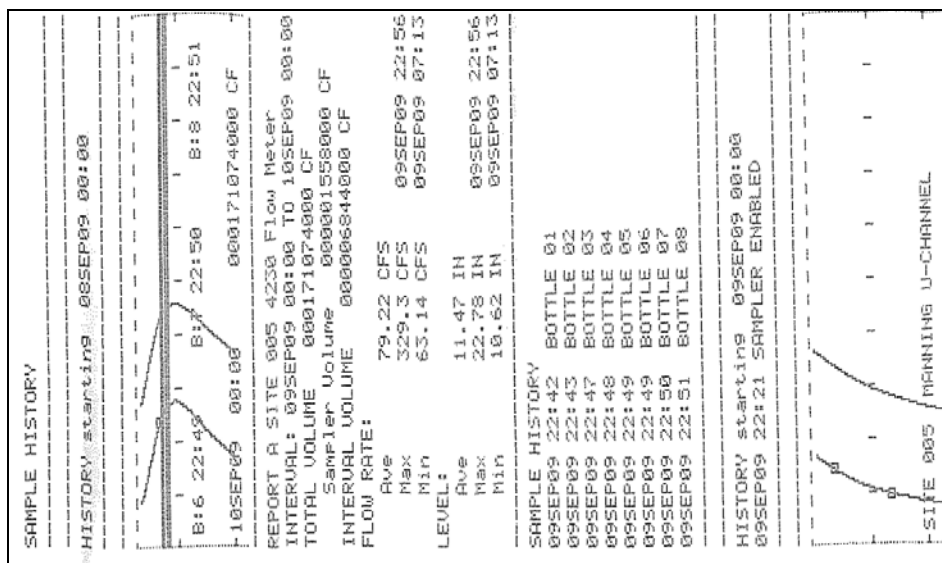

Figure 7 demonstrates flows in the Rio Grande at San Felipe and near Alameda USGS gages along with the NDC during the time of the 9-11-09 storm flow sample collection. Flows were steady (or slightly decreasing) in the Rio Grande at San Felipe for over 8 hours prior to sample collection. Discharge from the NDC peaked at 19:00, sampler was enabled at 19:47, and the sample was collected in the Rio Grande at 20:24.

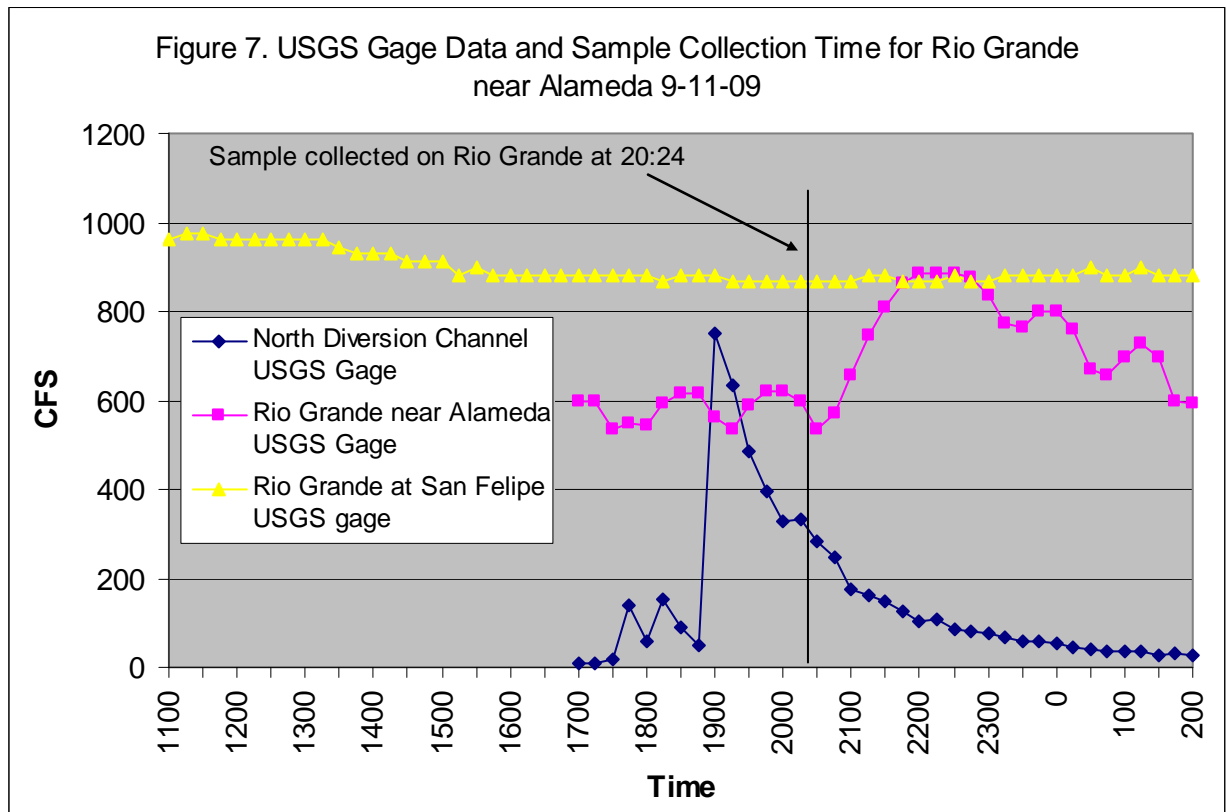

Figure 8 is a copy of the strip chart from the ISCO sampler and shows that the sample was collected on the rising leg near the peak of the hydrograph as the storm surge passed the sampler location.

Figure 8. ISCO Sampler Hydrograph and Sample Collection times for Rio Grande above Alameda 9-11-09

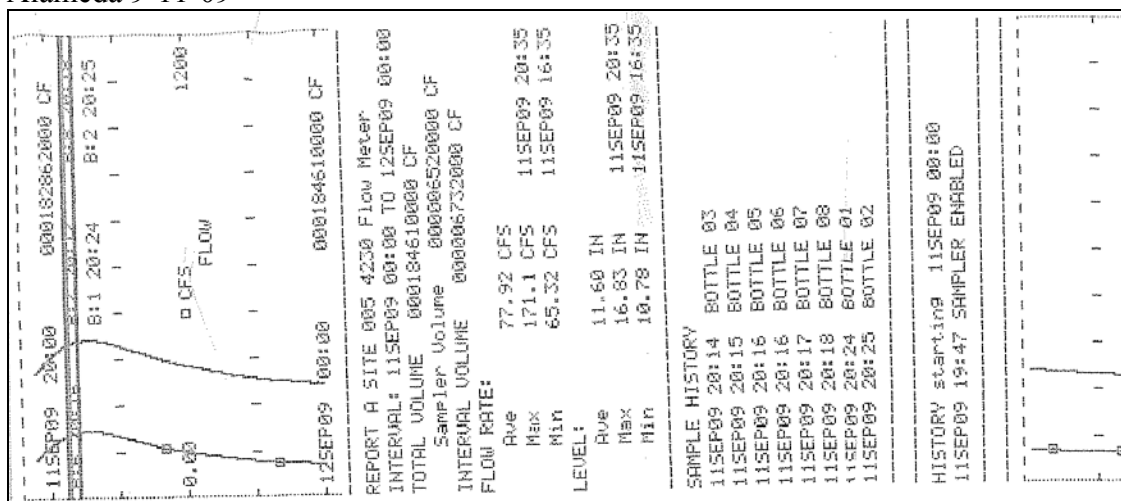

Figure 9 demonstrates flows in the Rio Grande at San Felipe and near Alameda USGS gages along with the NDC during the time of the 9-16-09 storm flow sample collection. Flows had increased nearly 500 CFS in the Rio Grande at San Felipe about 8 hours prior to sample collection. Discharge from the NDC peaked at three intervals between 22:30 and 00:15, sampler was enabled at 22:38, and the sample was collected in the Rio Grande at 23:15.

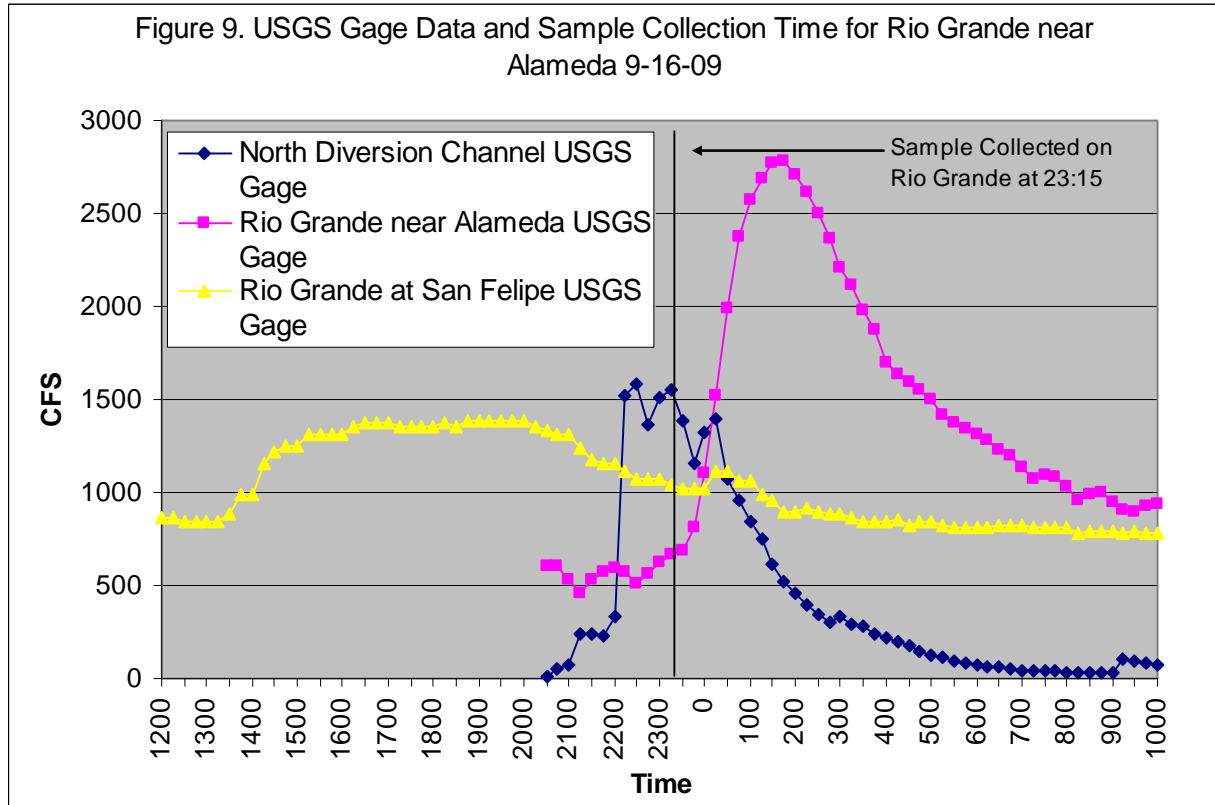

Figure 10 is a copy of the strip chart from the ISCO sampler and shows that the sample was collected on the rising leg of the hydrograph as the storm surge passed the sampler location.

Figure 10. ISCO Sampler Hydrograph and Sample Collection times for Rio Grande above Alameda 9-16-09

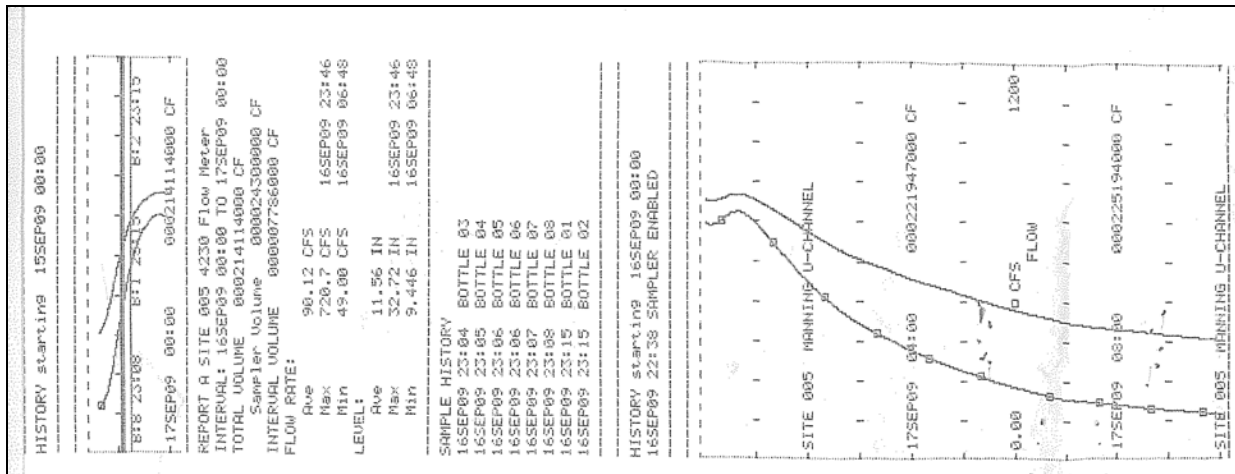

Figure 11 demonstrates flows in the Rio Grande at San Felipe and near Alameda USGS gages along with the NDC during the time of the 9-17-09 storm flow sample collection. Flows were steady in the Rio Grande at San Felipe for over 8 hours prior to sample collection. Discharge from the NDC peaked at 11:30, sampler was enabled at 11:13, and the sample was collected in the Rio Grande at 11:50.

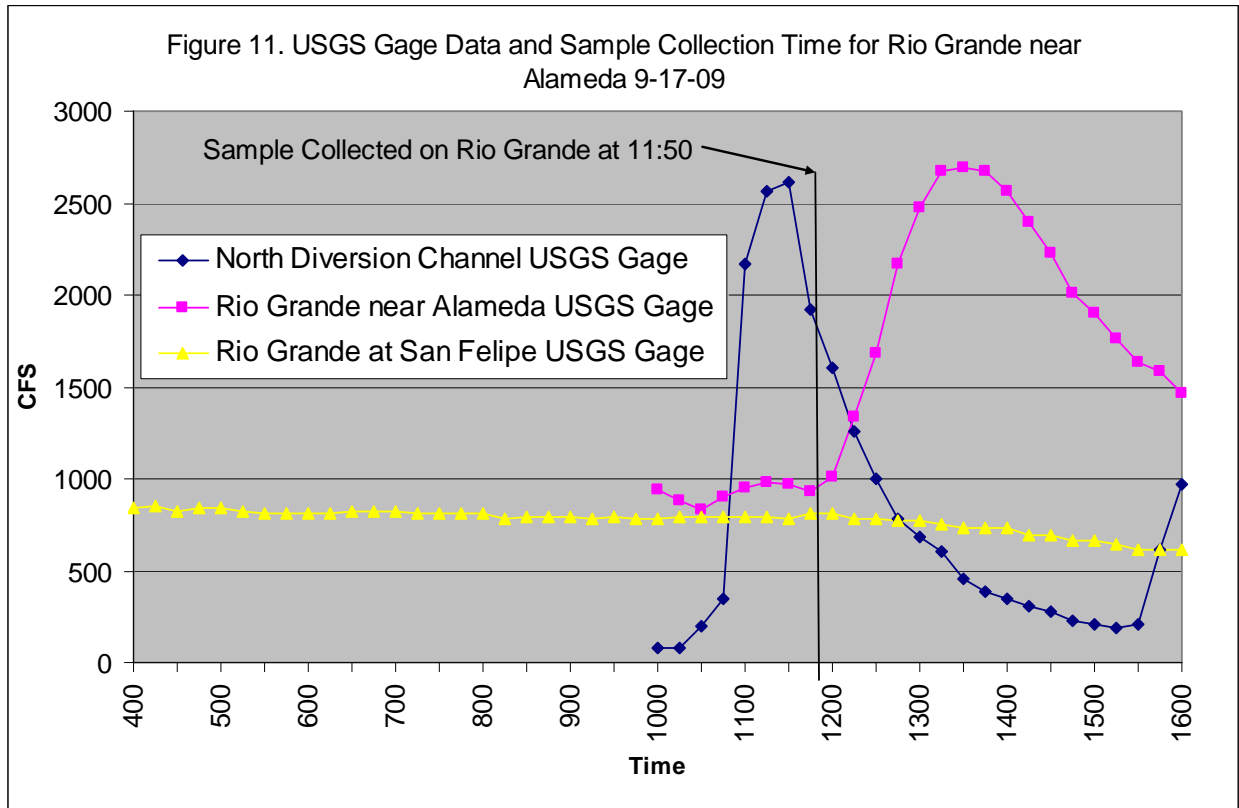

Figure 11 is a copy of the strip chart from the ISCO sampler and shows that the sample was collected on the rising leg of the hydrograph as the storm surge passed the sampler location.

Figure 12. ISCO Sampler Hydrograph and Sample Collection times for Rio Grande above Alameda 9-17-09. Dashed line indicates estimated hydrograph (rain during sample collection smeared graph)

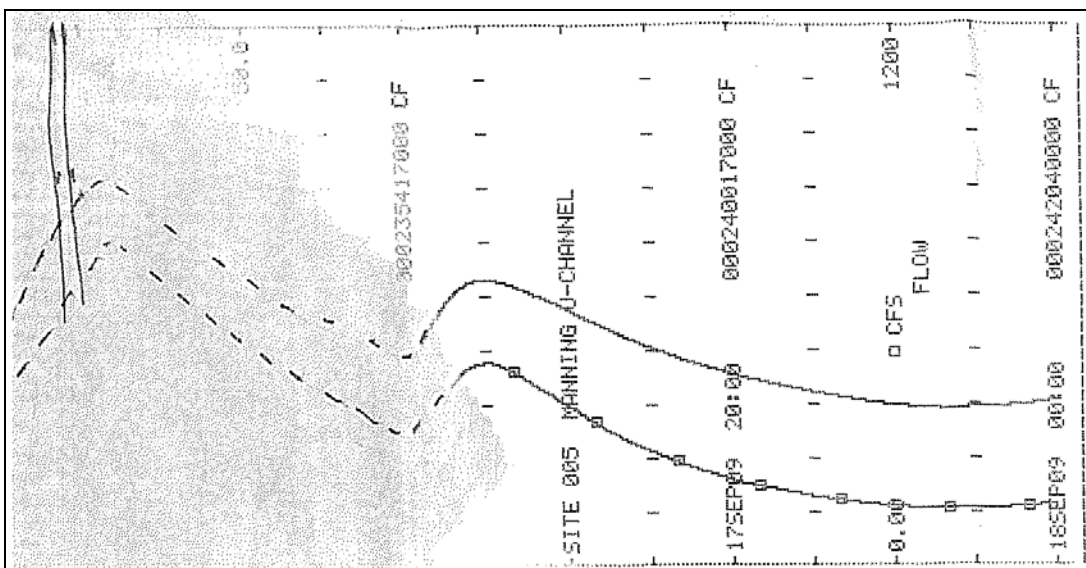
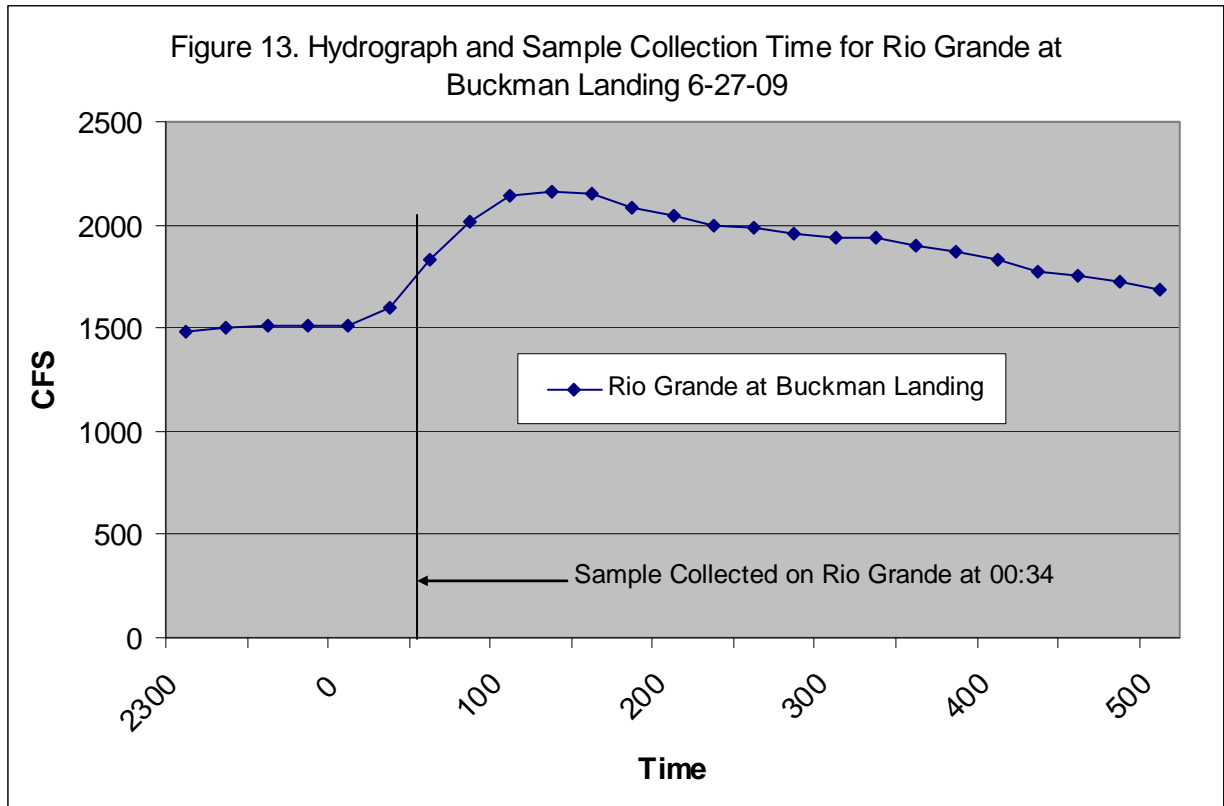

Figure 13 demonstrates flows in the Rio Grande at Buckman Landing on 6-27-09. Flow at the Buckman landing peaked at 01:15 and the sample was collected 41 minutes earlier on the rising leg of the hydrograph. It is approximately 3.3 miles from Otowi Bridge to the Buckman Landing.



Otowi gage data is used as a surrogate for Buckman Landing flows. Peak flow occurred at Buckman Landing 49 minutes after the peak at Otowi and times have been adjusted on graph to compensate. No adjustment of sample time was needed.

Figure 14 is a copy of the strip chart from the ISCO sampler and shows that the sample was collected on the rising leg of the hydrograph as the storm surge passed the sampler location. The time on the strip chart is one hour earlier because the sampler had not been changed from Daylight Standard time to Daylight Savings time.

Figure 14. ISCO Sampler Hydrograph and Sample Collection times for Rio Grande at Buckman Landing 6-27-09

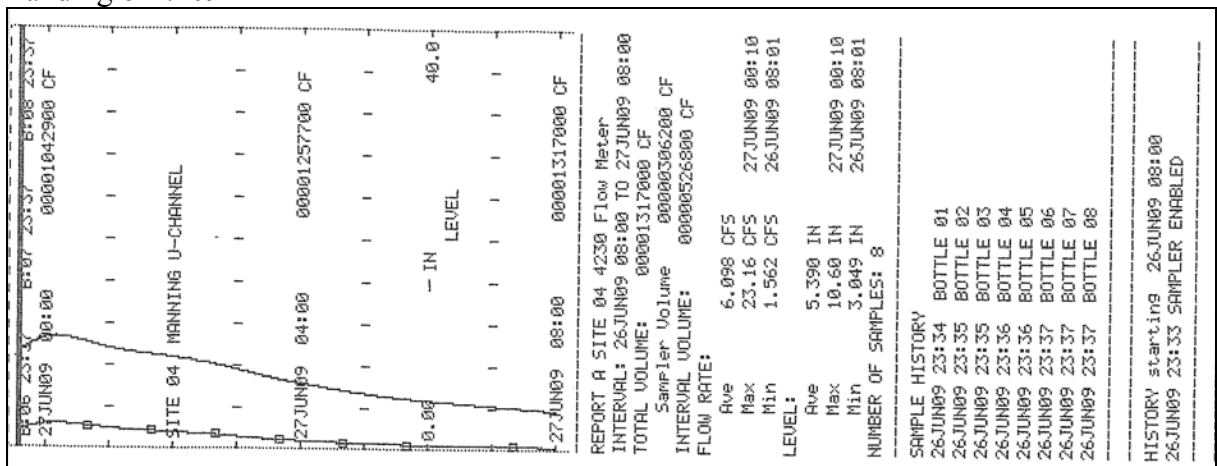
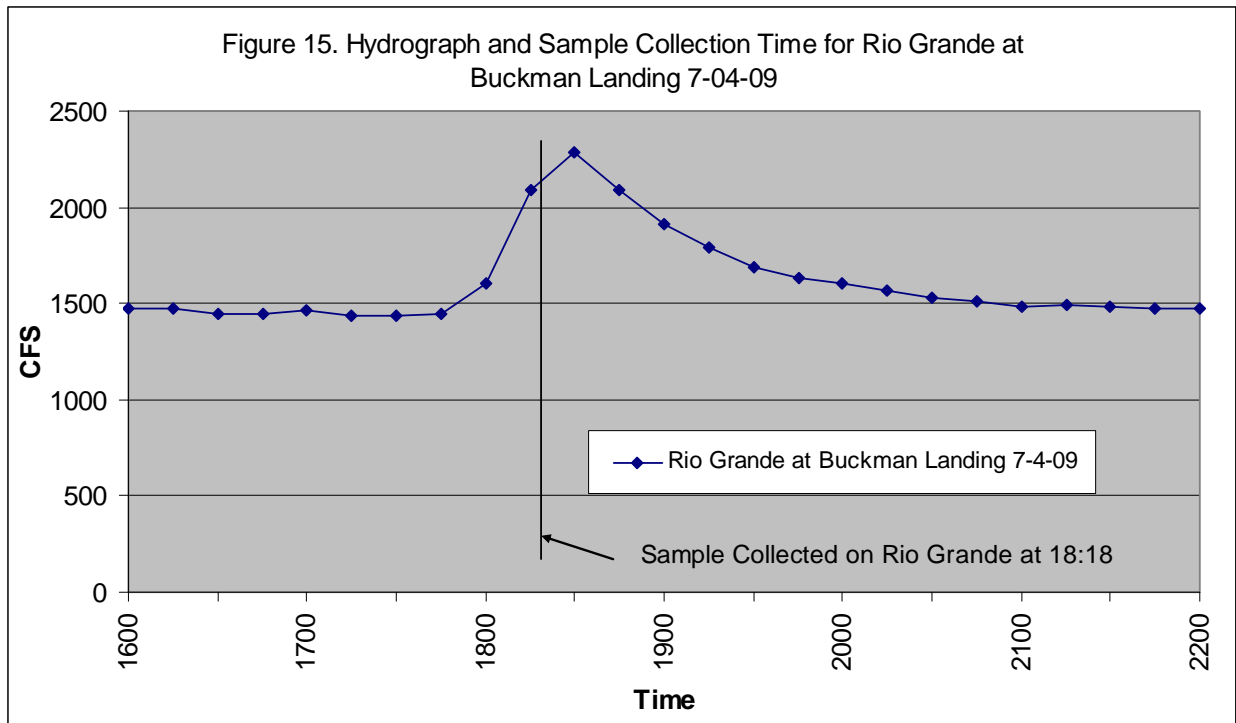

Figure 15 demonstrates flows in the Rio Grande at Buckman Landing on 7-4-09. Flow at the Buckman landing peaked at 18:30 and the sample was collected 12 minutes earlier on the rising leg of the hydrograph.



Otowi gage data is used as a surrogate for Buckman Landing flows. Peak flow occurred at Buckman Landing 35 minutes after the peak at Otowi and times have been adjusted on graph to compensate. No adjustment of sample time was needed.

Figure 16 is a copy of the strip chart from the ISCO sampler at Buckman Landing on 7-4-09 which shows that the sample was collected on the rising leg of the hydrograph as the storm surge passed the sampler location.

Figure 16. ISCO Sampler Hydrograph and Sample Collection times for Rio Grande at Buckman Landing 7-4-09

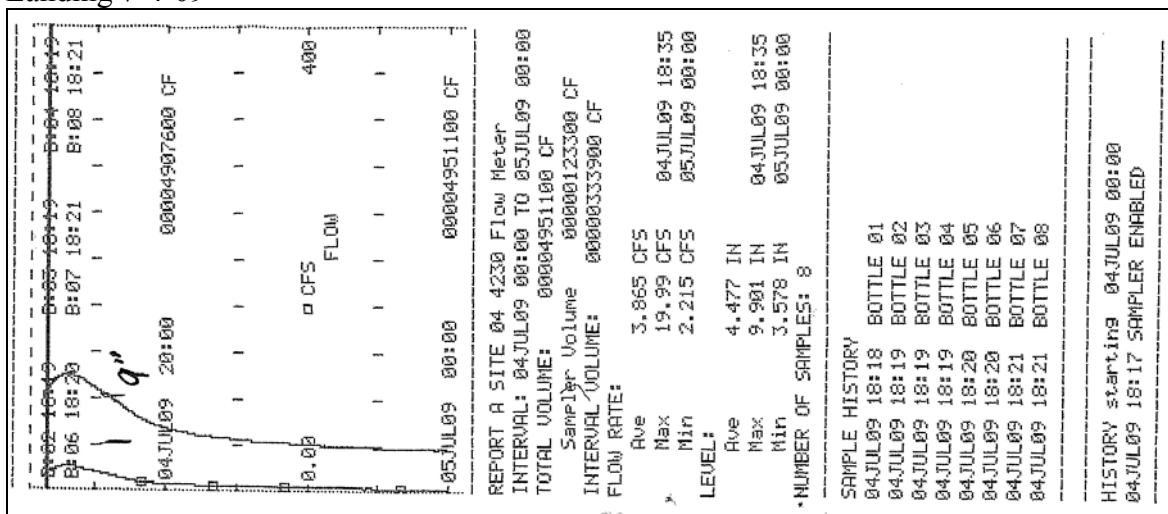
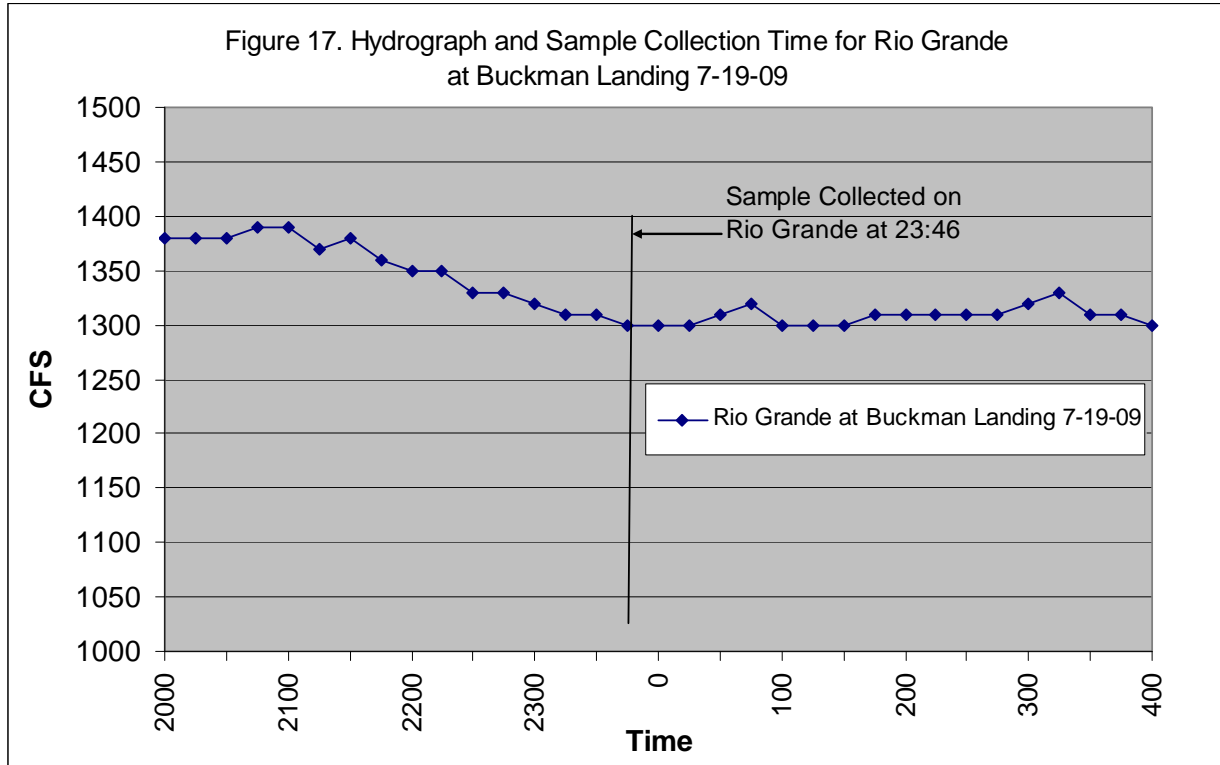

Figure 17 demonstrates flows in the Rio Grande at Buckman Landing on 7-19-09. Flow at the Buckman landing remained constant or declined slightly on this day. The sampler tripped on a spurious signal (most likely a plugged stage sensor line) and a non-storm influenced flow. Particle size and SSC data indicate this sample is not representative of baseflow conditions due to probable covering of sample port with sand deposits.



Otowi gage data is used as a surrogate for Buckman Landing flows. Peak flow occurred at Buckman Landing 45 minutes after the peak at Otowi and times have been adjusted on graph to compensate. No adjustment of sample time was needed.

Figure 18 is a copy of the strip chart from the ISCO sampler at Buckman Landing on 7-19-09. Note repeated stage height fluctuations due to covered and plugged stage sensor line.

Figure 18. ISCO Sampler Hydrograph and Sample Collection times for Rio Grande at Buckman Landing 7-19-09

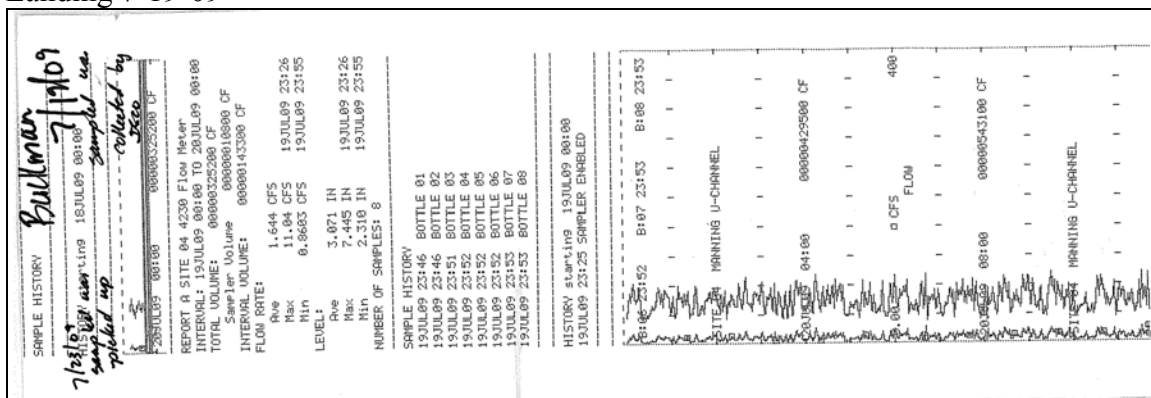
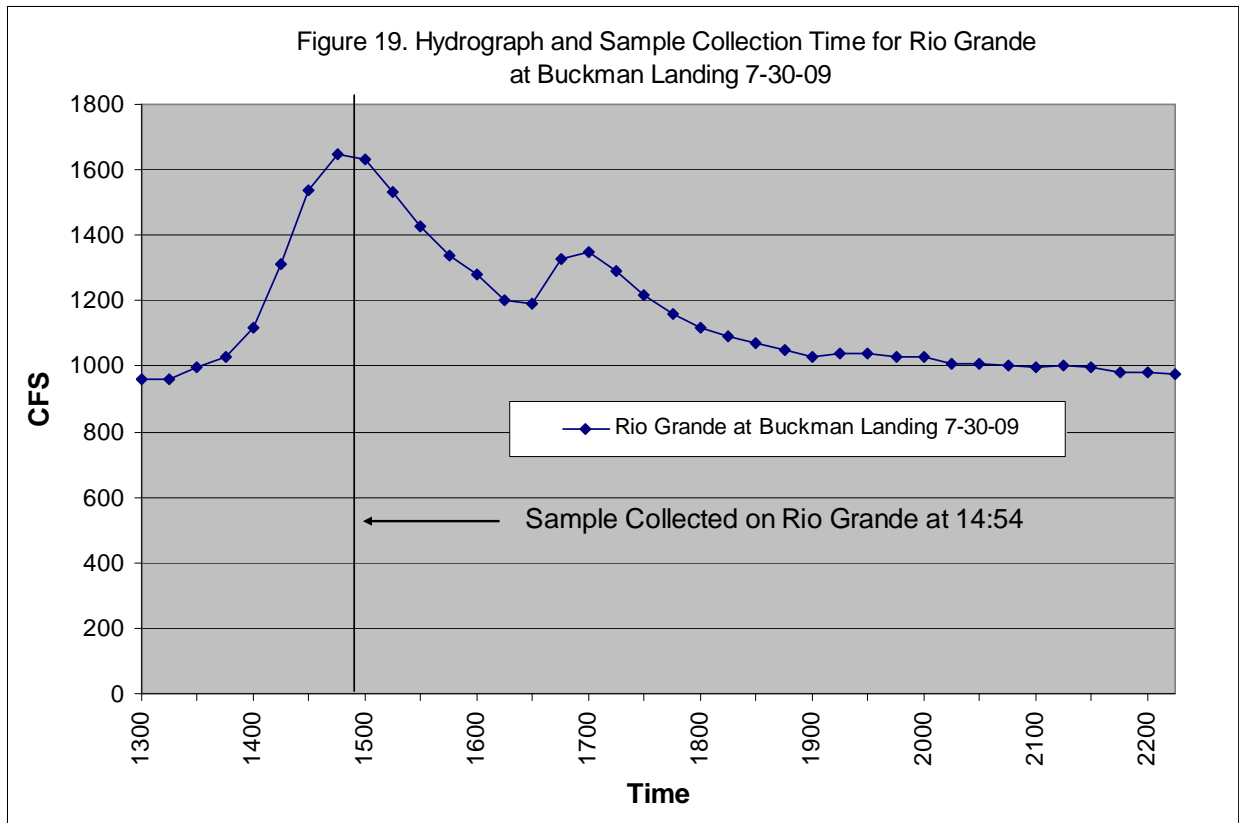

Figure 19 demonstrates flows in the Rio Grande at Buckman Landing on 7-30-09. Flow at the Buckman landing peaked at 14:45 and the sample was collected 9 minutes later very near the peak of the hydrograph.



Otowi gage data is used as a surrogate for Buckman Landing flows. Peak flow occurred at Buckman Landing 48 minutes after the peak at Otowi and times have been adjusted on graph to compensate. No adjustment of sample time was needed.

Figure 20 is a copy of the strip chart from the ISCO sampler at Buckman Landing on 7-19-09.

Figure 20. ISCO Sampler Hydrograph and Sample Collection times for Rio Grande at Buckman Landing 7-30-09

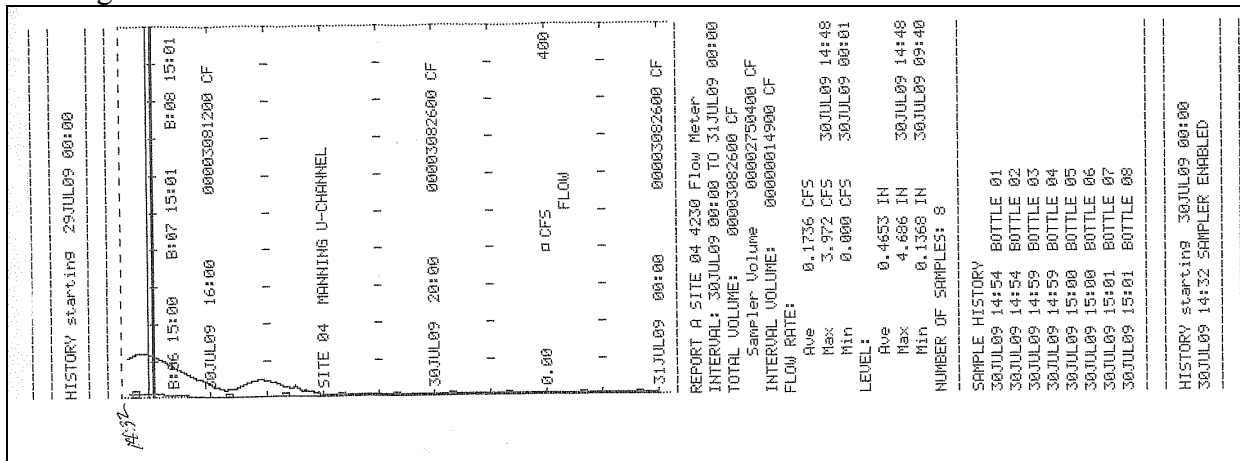
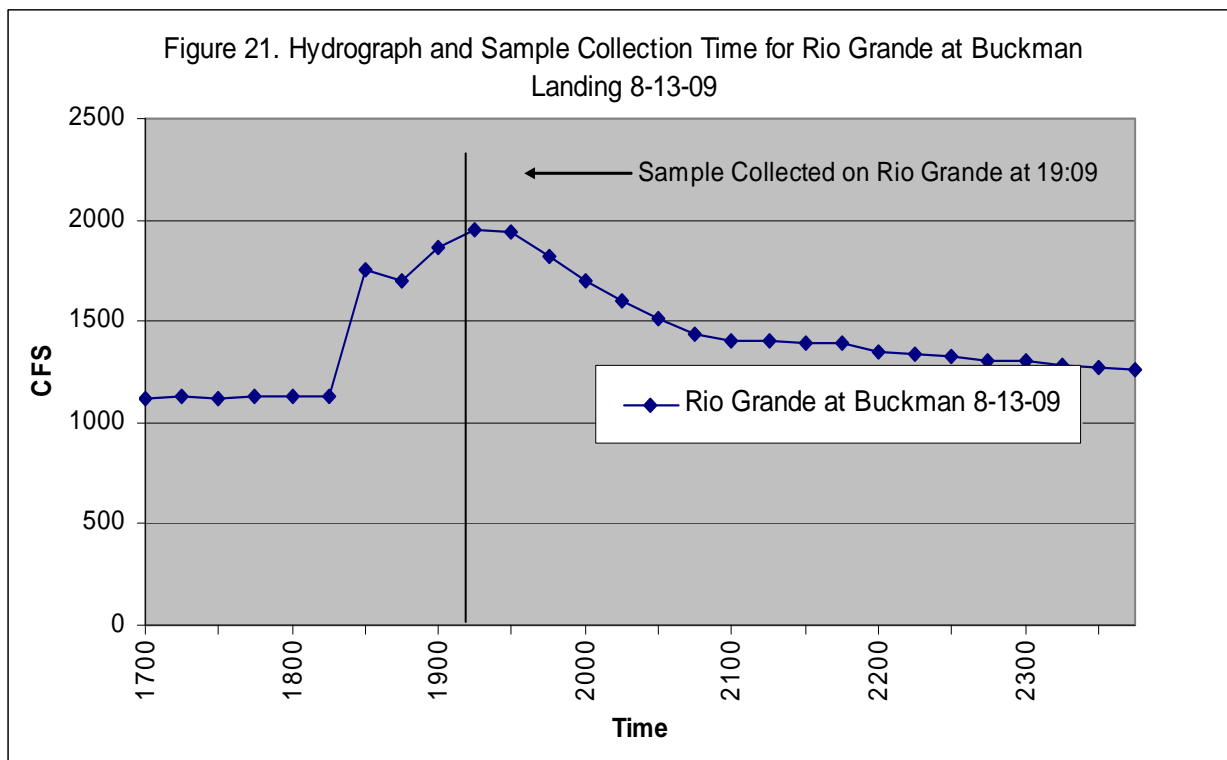

Figure 21 demonstrates flows in the Rio Grande at Buckman Landing on 8-13-09. Flow at the Buckman landing peaked at 19:15 and the sample was collected 6 minutes earlier very near the peak of the hydrograph.



Otowi gage data is used as a surrogate for Buckman Landing flows. Peak flow occurred at Buckman Landing 46 minutes after the peak at Otowi and times have been adjusted on graph to compensate. No adjustment of sample time was needed.

Figure 22 is a copy of the strip chart from the ISCO sampler at Buckman Landing on 8-13-09.

Figure 22 ISCO Sampler Hydrograph and Sample Collection times for Rio Grande at Buckman Landing 8-13-09

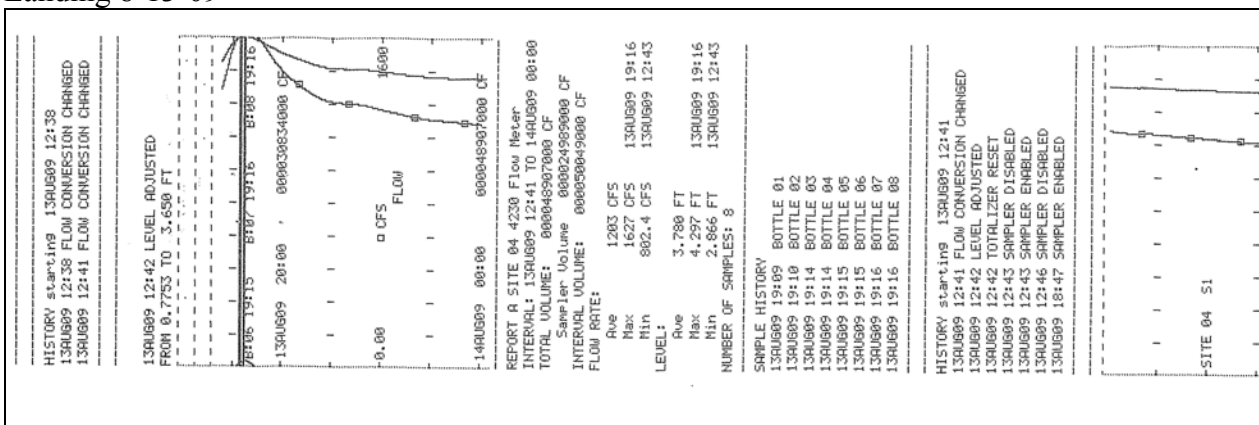

Figure 23 demonstrates flows in the Rio Grande at Otowi Bridge on 6-26-09. Flow at Otowi Bridge peaked at 00:30 and the sample was collected 45 minutes earlier on the rising leg of the hydrograph.

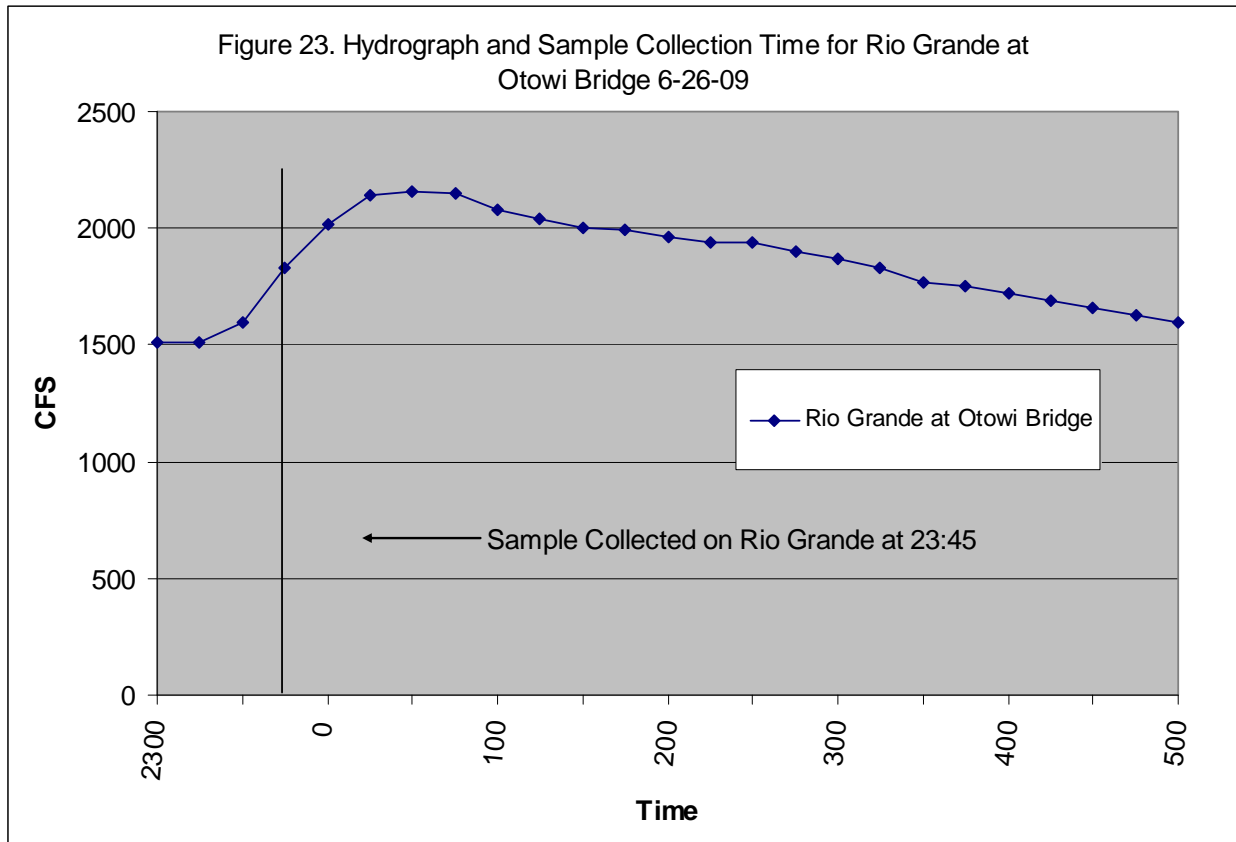

Figure 24 is a copy of the strip chart from the ISCO sampler at Otowi Bridge on 6-26-09.

Figure 24 ISCO Sampler Hydrograph and Sample Collection times for Rio Grande at Otowi Bridge on 6-26-09.

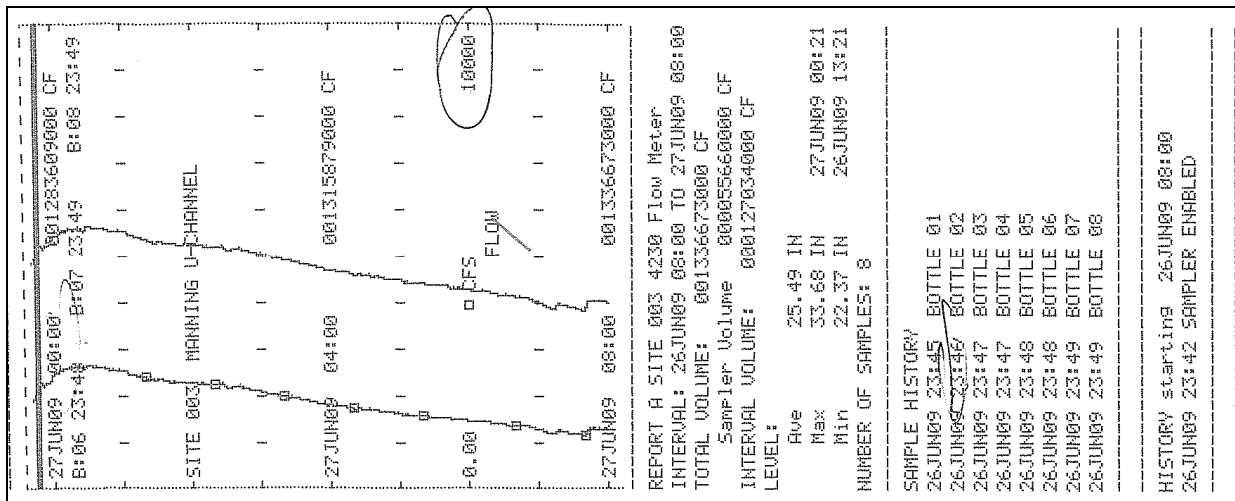

Figure 25 demonstrates flows in the Rio Grande at Otowi Bridge on 7-4-09. Flow at Otowi Bridge peaked at 18:00 and the sample was collected 24 minutes earlier on the rising leg of the hydrograph..

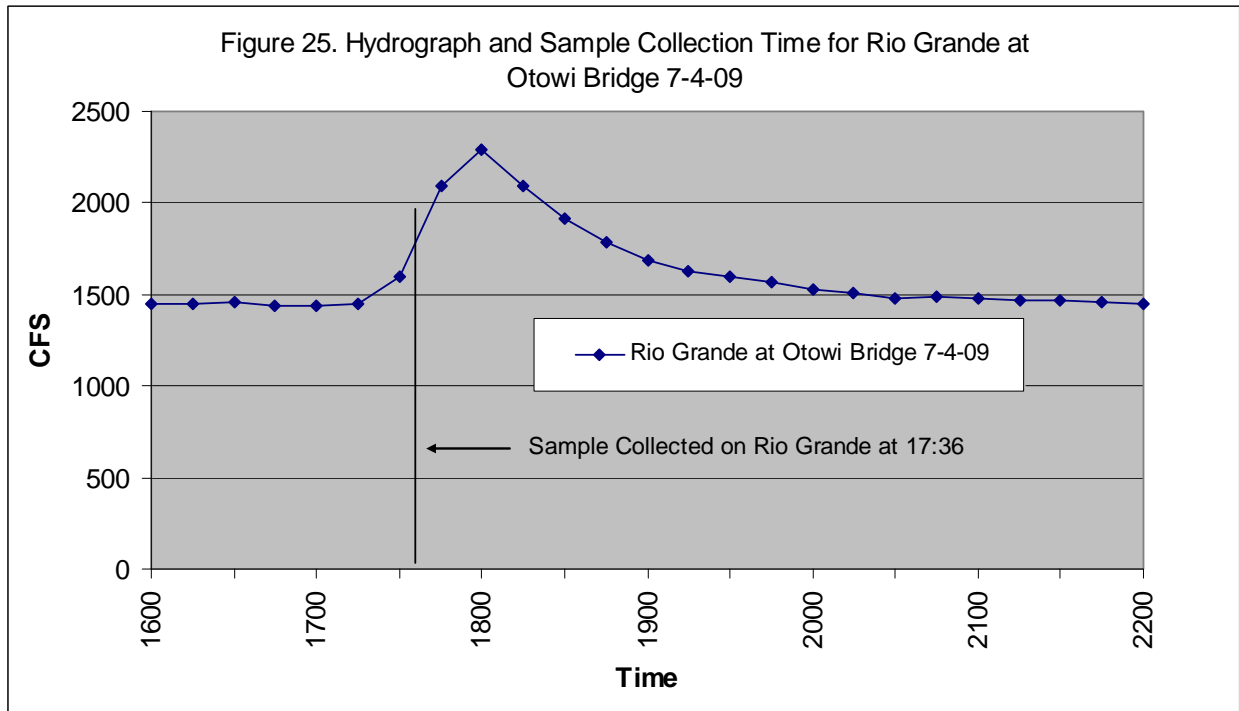

Figure 26 is a copy of the strip chart from the ISCO sampler at Otowi Bridge on 7-4-09.

Figure 26. ISCO Sampler Hydrograph and Sample Collection times for Rio Grande at Otowi Bridge on 7-4-09.

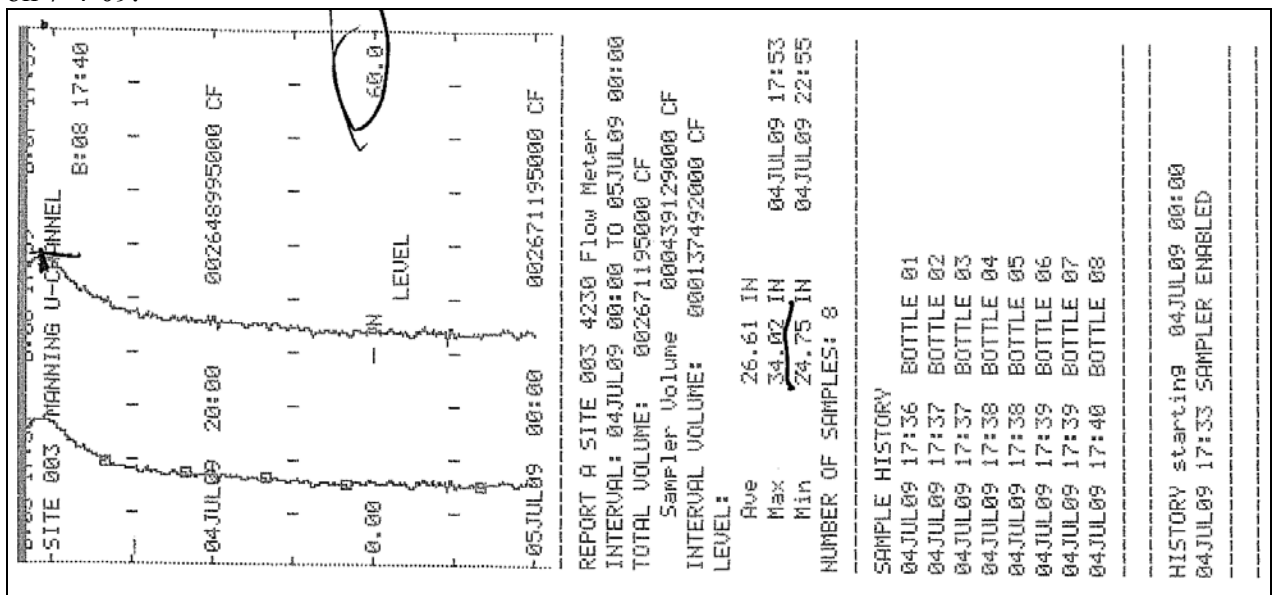

Figure 27 demonstrates flows in the Rio Grande at Otowi Bridge on 7-22-09. Flow at Otowi Bridge peaked at 03:15 and the sample was collected 3 hours and 8 minutes earlier on the rising leg of the hydrograph. This was a slowly rising hydrograph that took over 4 hours to reach the peak of the hydrograph.

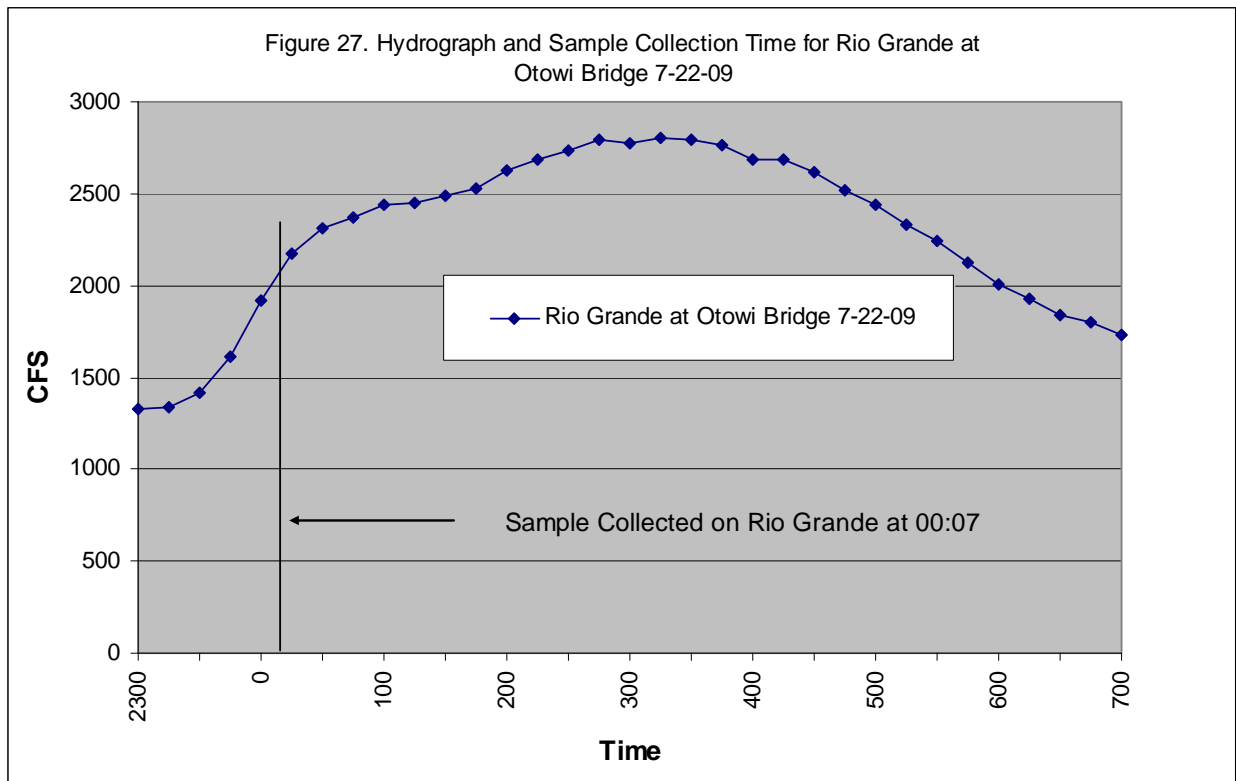

Figure 28 is a copy of the strip chart from the ISCO sampler at Otowi Bridge on 7-22-09.

Figure 28. ISCO Sampler Hydrograph and Sample Collection times for Rio Grande at Otowi Bridge on 7-22-09.

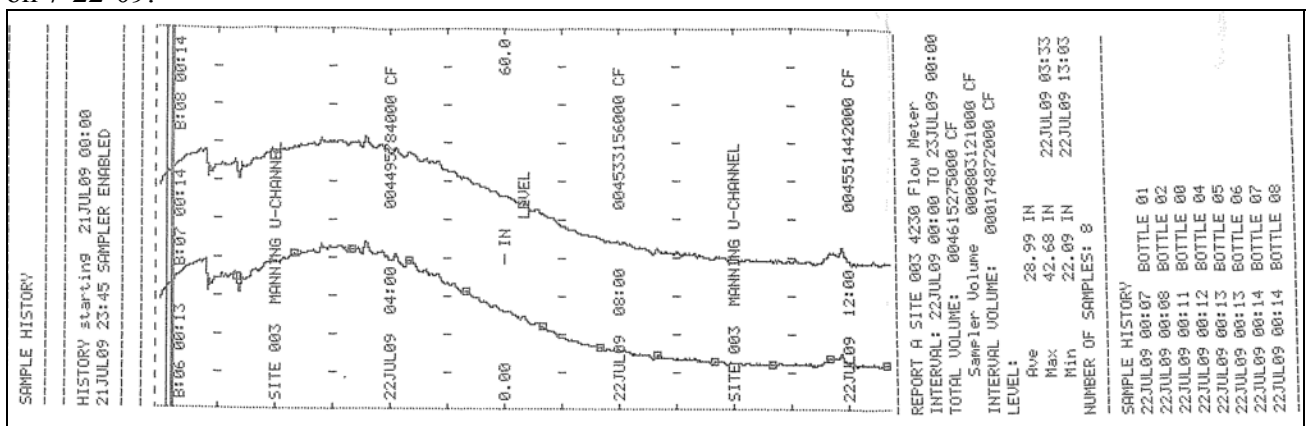

Figure 29 demonstrates flows in the Rio Grande at Otowi Bridge on 8-13-09. Flow at Otowi Bridge peaked at 18:30 and the sample was collected 7 minutes earlier on the rising leg and very near the peak of the hydrograph.

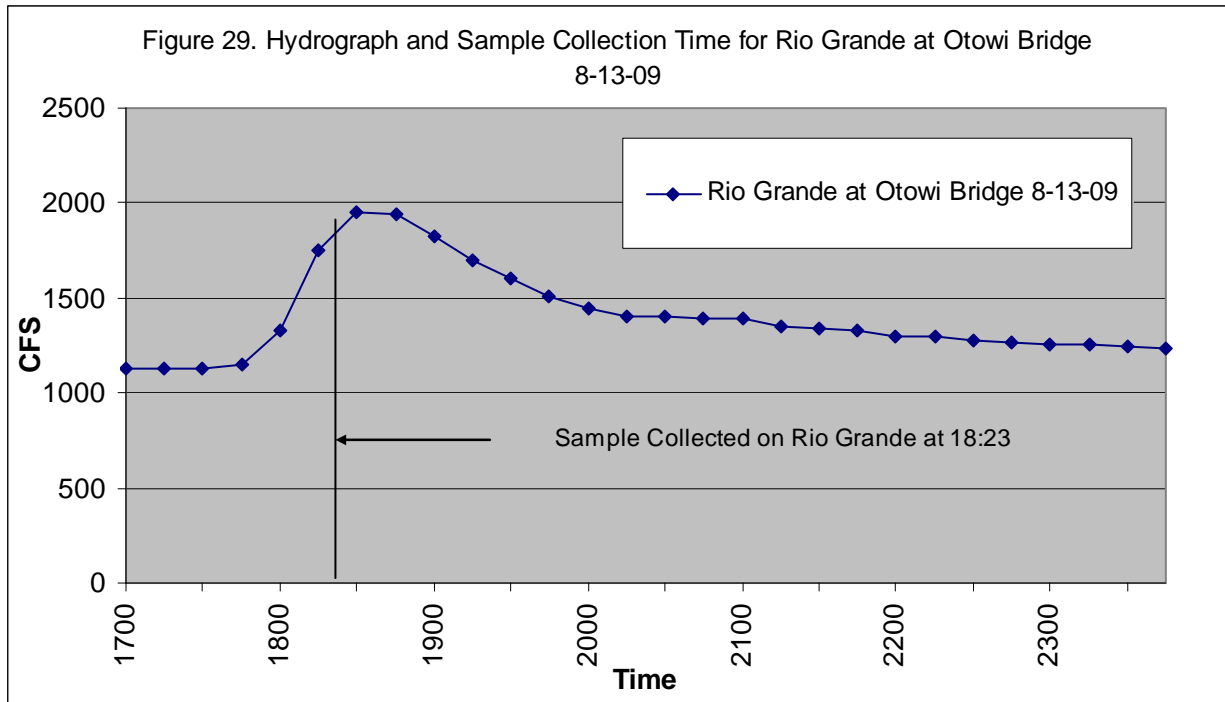

Figure 30 is a copy of the strip chart from the ISCO sampler at Otowi Bridge on 8-13-09.

Figure 30. ISCO Sampler Hydrograph and Sample Collection times for Rio Grande at Otowi Bridge on 8-13-09.

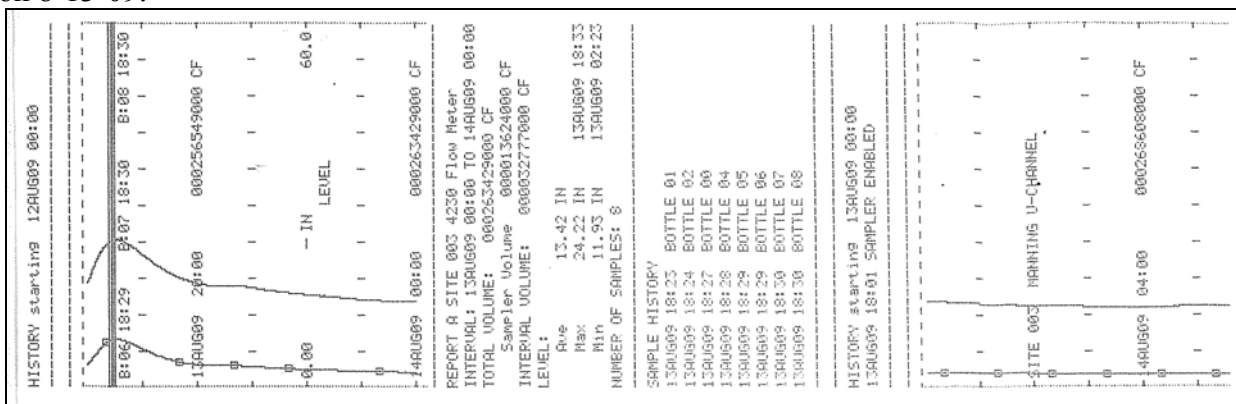

Figure 31 demonstrates flows in the Rio Chama at Chamita on 6-26-09. Flow at Chamita peaked at 20:30 and the sample was collected 25 minutes earlier on the rising leg and near the peak of the hydrograph.

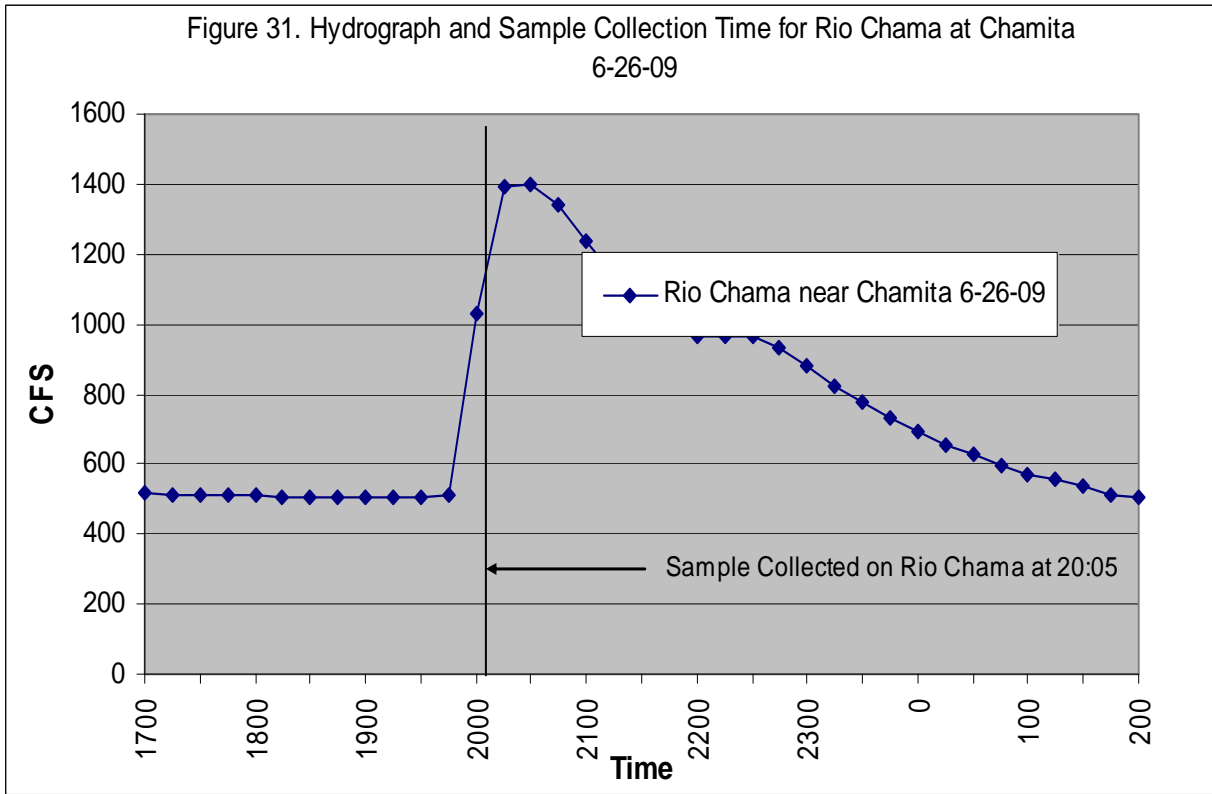

Figure 32 is a copy of the strip chart from the ISCO sampler at Rio Chama at Chamita on 6-26-09.

Figure 32. ISCO Sampler Hydrograph and Sample Collection times for Rio Chama at Chamita on 6-26-09.

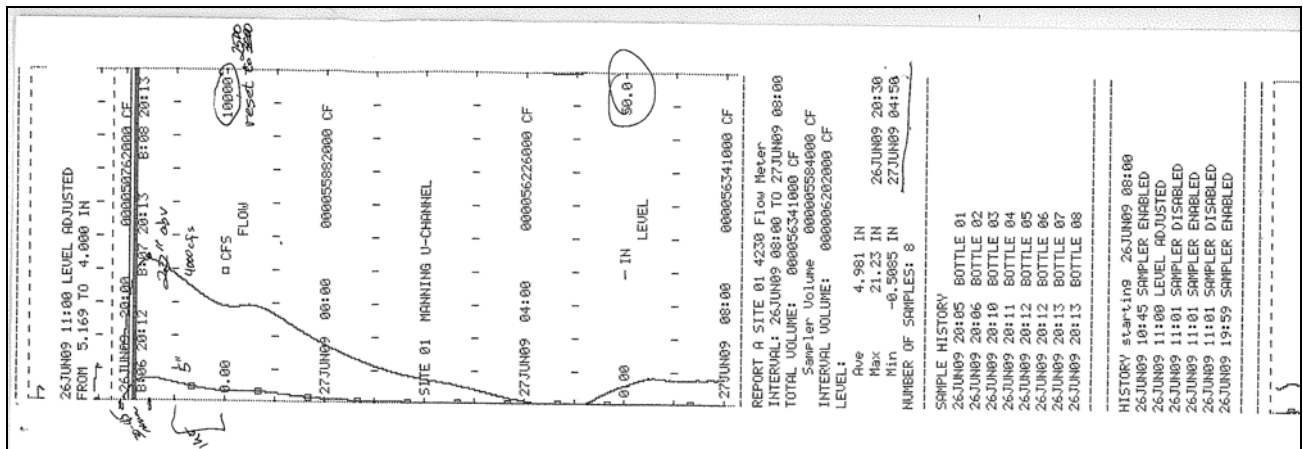

Figure 33 demonstrates flows in the Rio Chama at Chamita on 7-13-09. Flow at Chamita peaked at 18:00 and the sample was collected 11 minutes later on the falling leg of the hydrograph. This was a small flow event and the flows stopped increasing after an approximate 150 CFS increase.

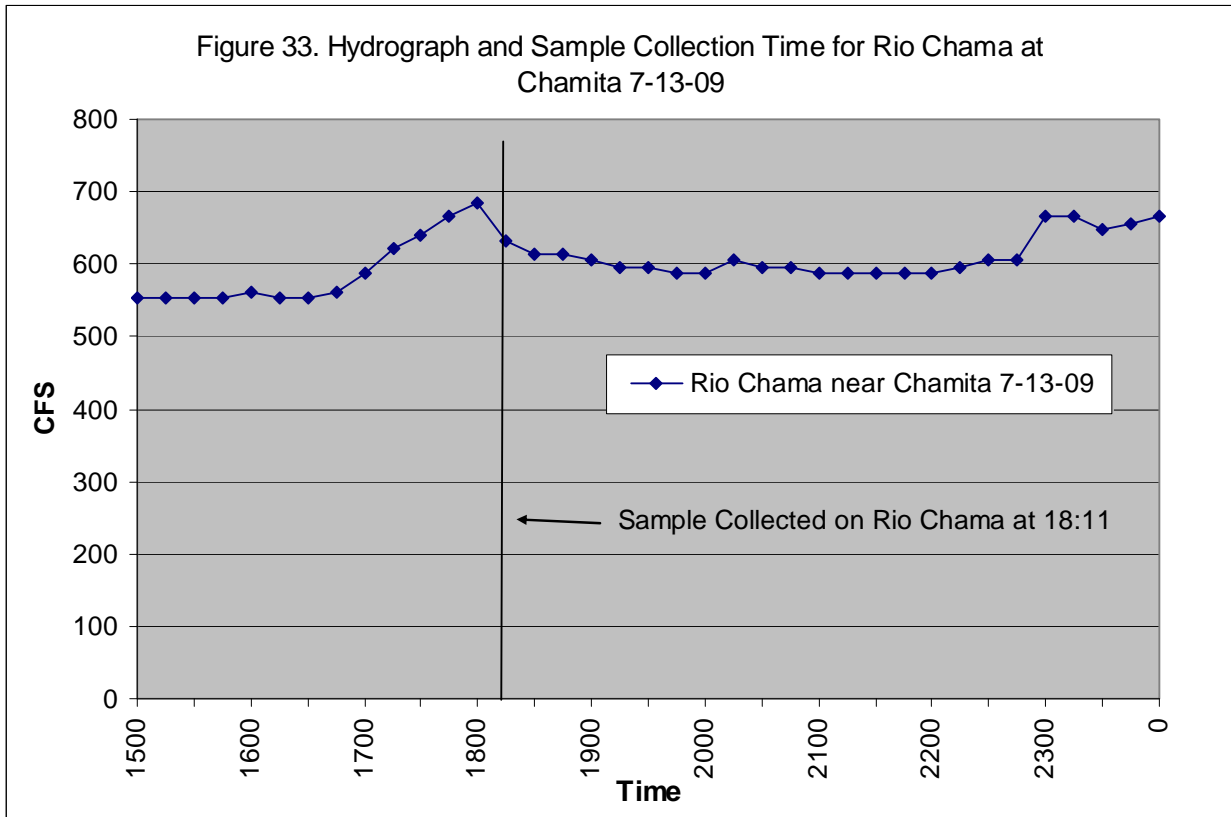

Figure 34 is a copy of the strip chart from the ISCO sampler at Rio Chama at Chamita on 7-13-09.

Figure 32. ISCO Sampler Hydrograph and Sample Collection times for Rio Chama at Chamita on 7-13-09.

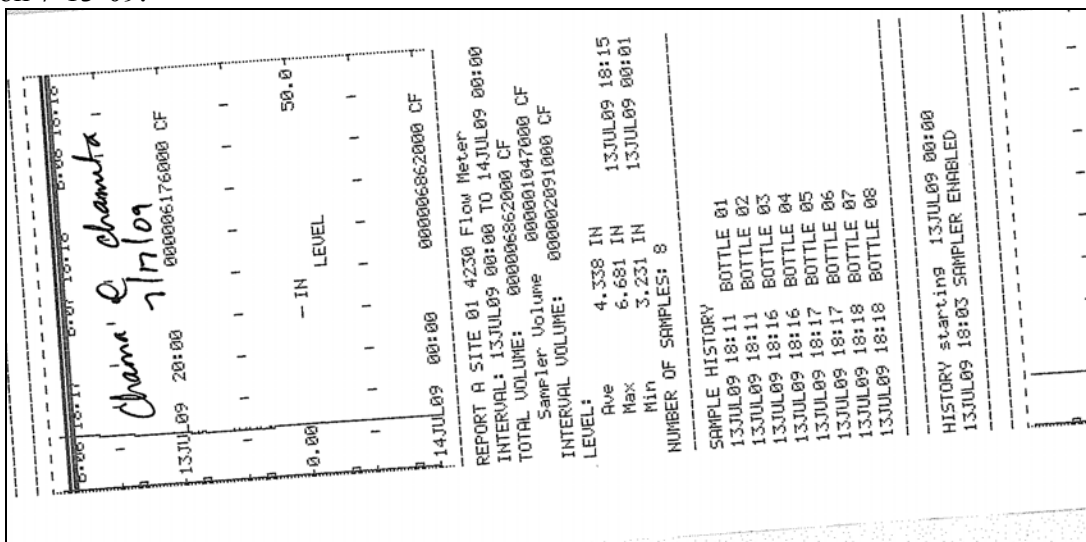

Figure 35 demonstrates flows in the Rio Chama at Chamita on 7-21-09. Flow at Chamita peaked at 23:00 and the sample was collected 2 hours and 49 minutes earlier at the beginning of the rising leg of the hydrograph.

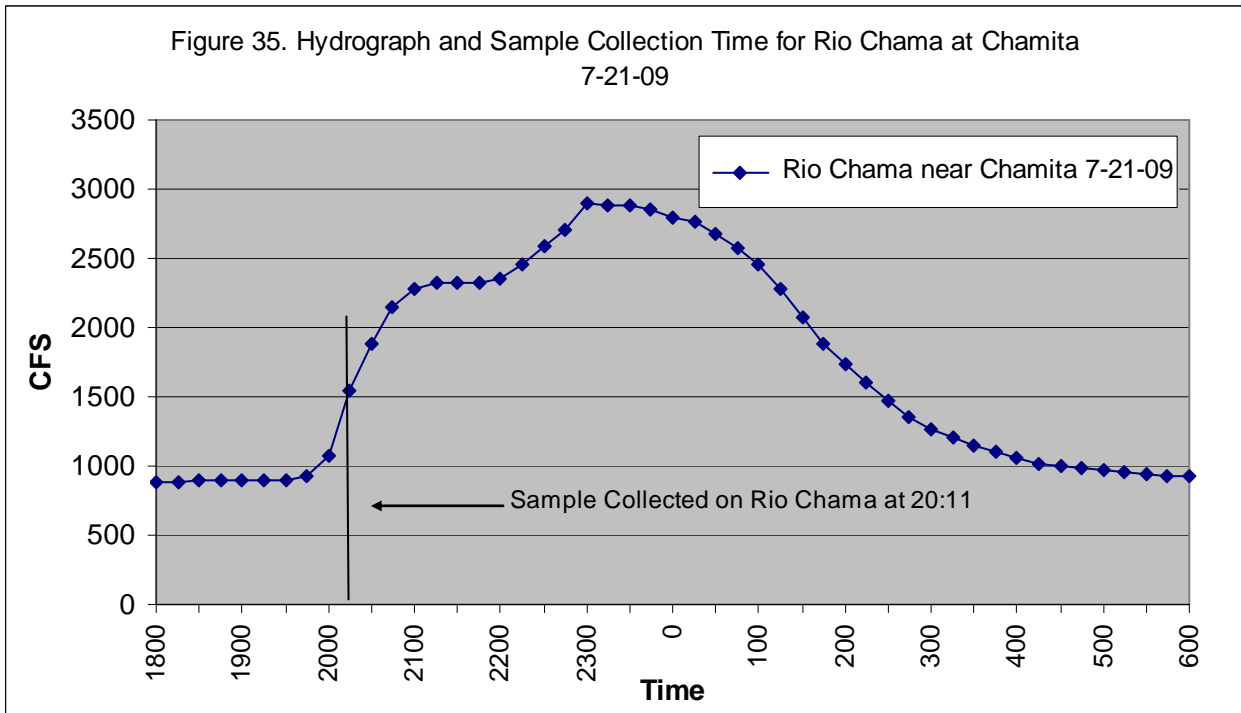

Figure 36 is a copy of the strip chart from the ISCO sampler at Rio Chama at Chamita on 7-21-09.

Figure 36. ISCO Sampler Hydrograph and Sample Collection times for Rio Chama at Chamita on 7-21-09.

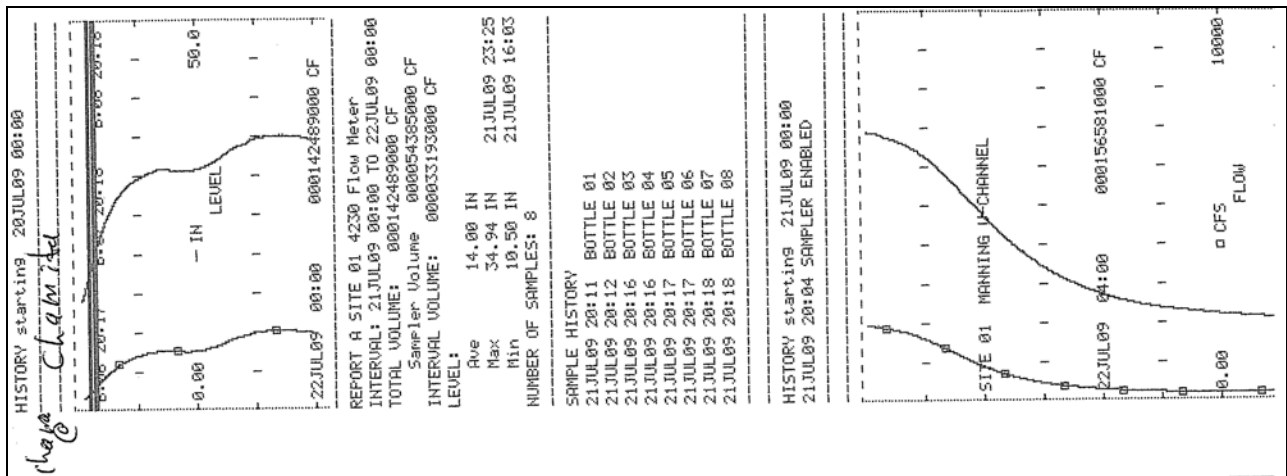

Figure 37 demonstrates flows in the Rio Chama at Chamita on 8-10-09. The sampler malfunctioned and initiated a sample with no apparent rise in discharge. Flow remained constant at Chamita on 8-10-09. No strip chart from the ISCO sampler at Rio Chama at Chamita on 8-10-09 is available.

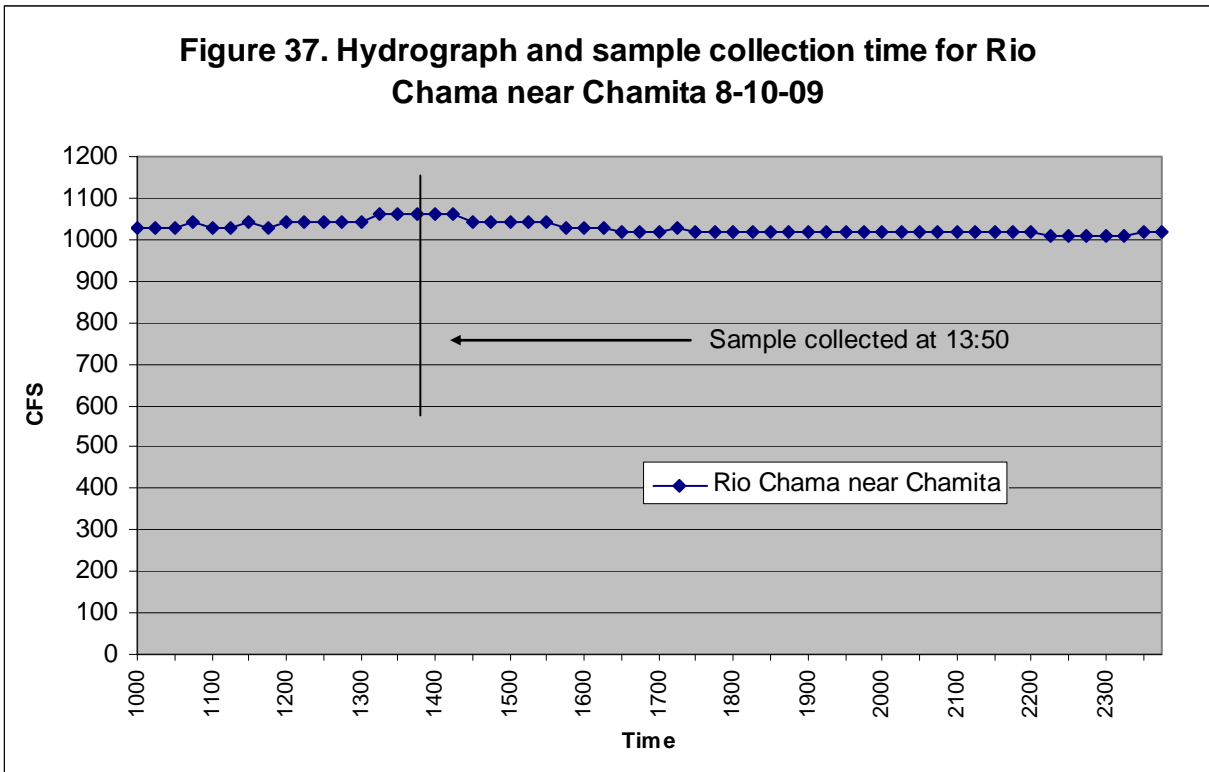
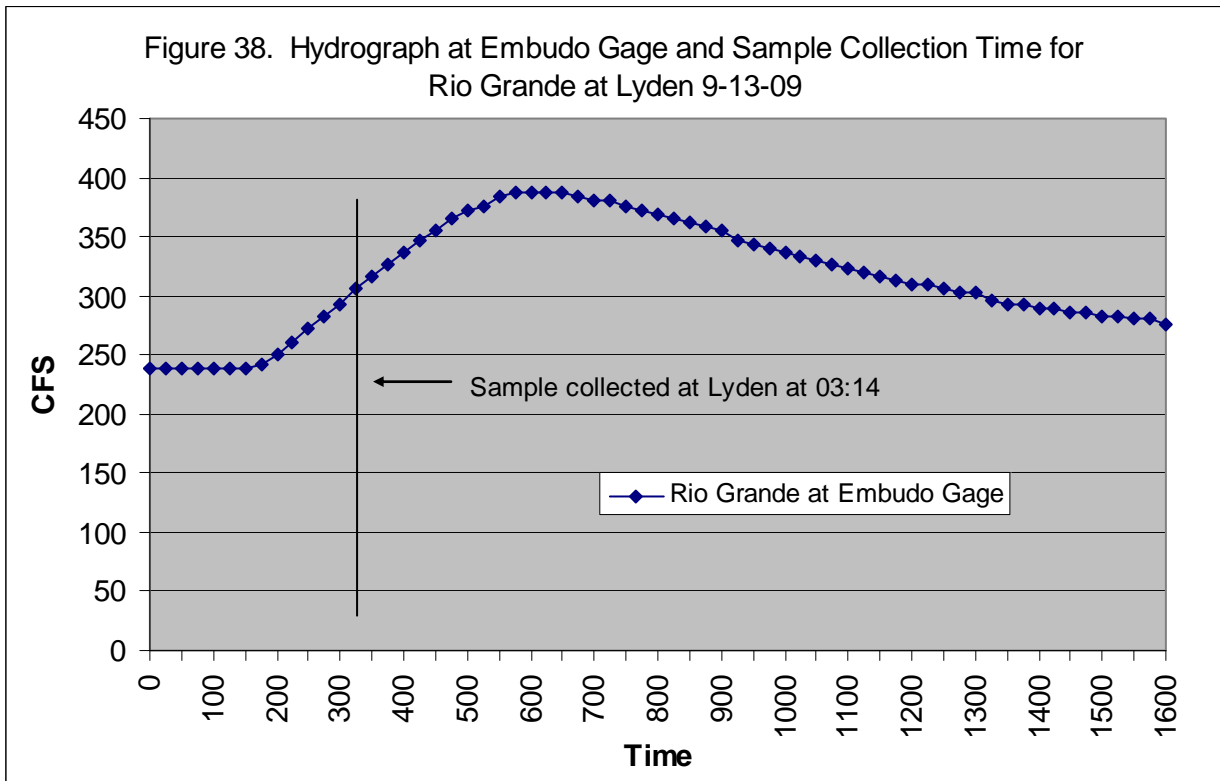

Figure 38 demonstrates flows in the Rio Grande at the Embudo gage on 9-13-09. Flow at the Embudo gage peaked at 05:45 and the sample was collected at Lyden 2 hour and 30 minutes earlier. The gage data shows a gradual 4 hour rise to peak of the hydrograph. There is approximately a 2 hour travel time between the gage at Embudo and the sampler at Lyden.



There was no strip chart available for the flow event at Rio Grande at Lyden on 9-13-09.

Figure 39. Pearson R² correlation between suspended sediment concentration and total PCB at Rio Grande above Alameda

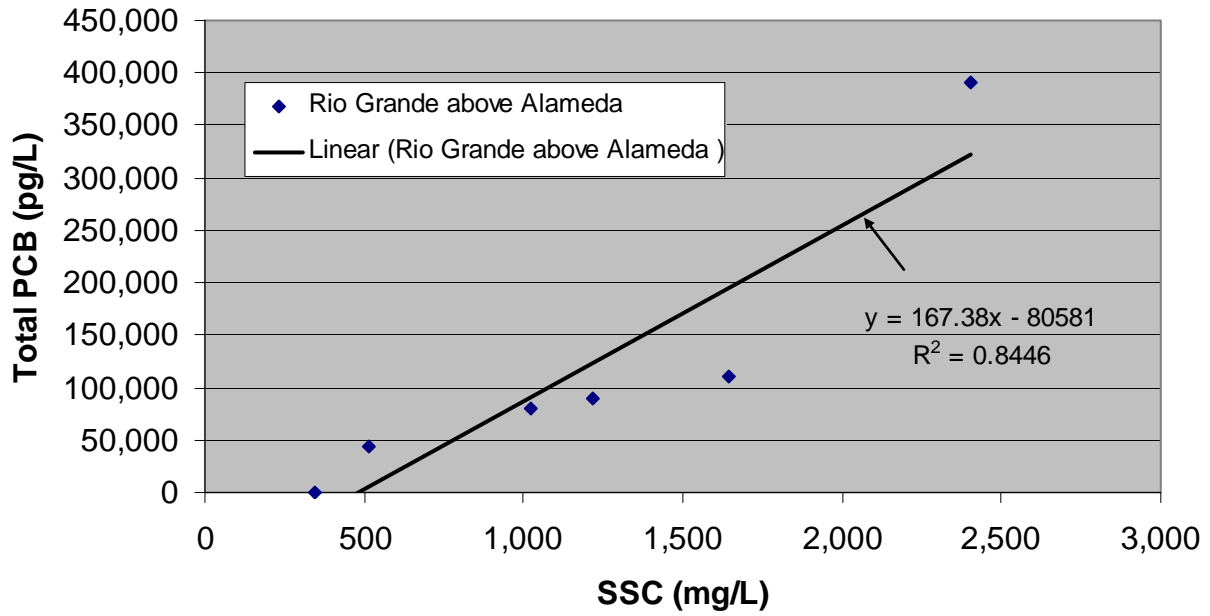

Figure 40. The Pearson R² correlation between suspended sediment concentration and gross alpha for all samples (including outlier with high sand content)

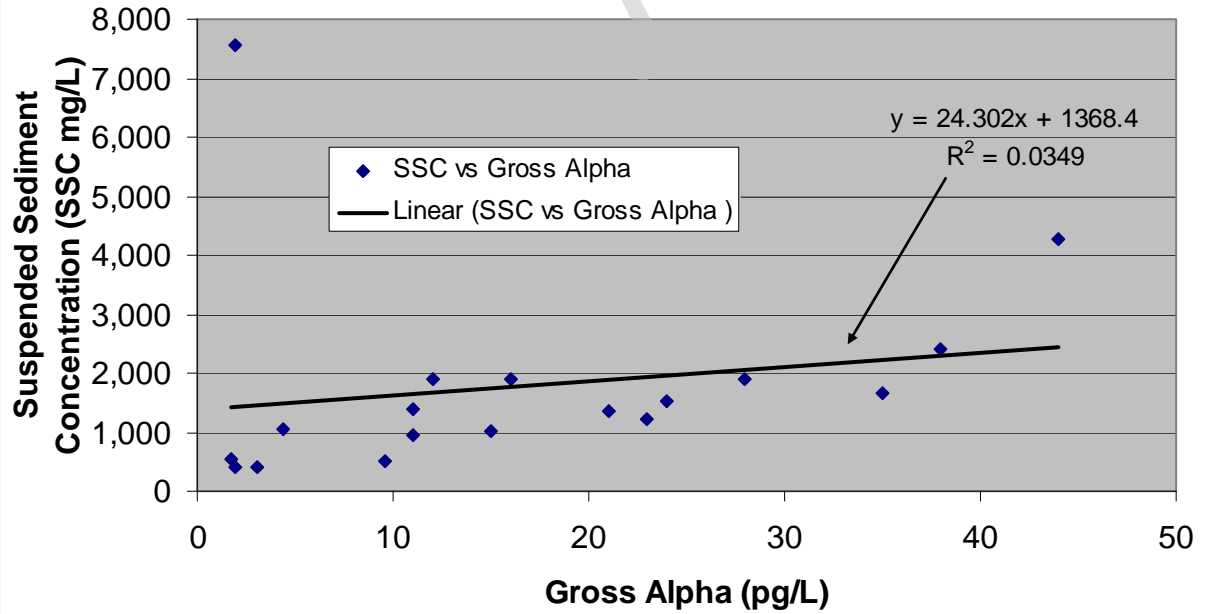

Figure 41. The Pearson R² correlation between suspended sediment concentration and gross alpha for all samples (excluding outlier with high sand content)

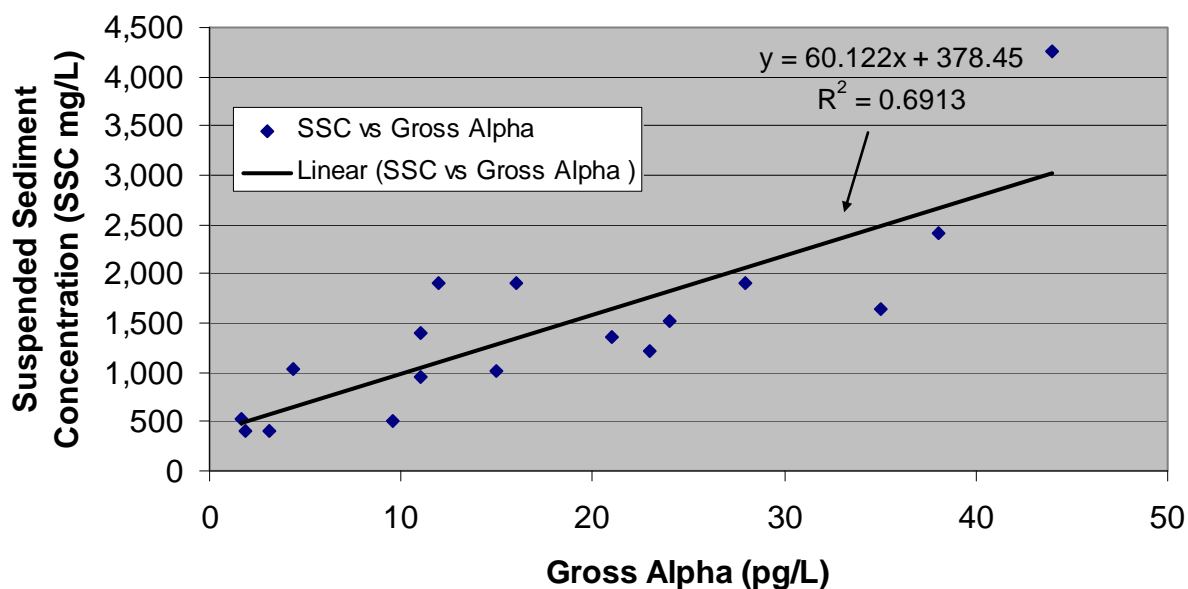

Figure 42. PCB Homologue Data from Storm Flow Samples Collected from the Rio Chama at Chamita Location

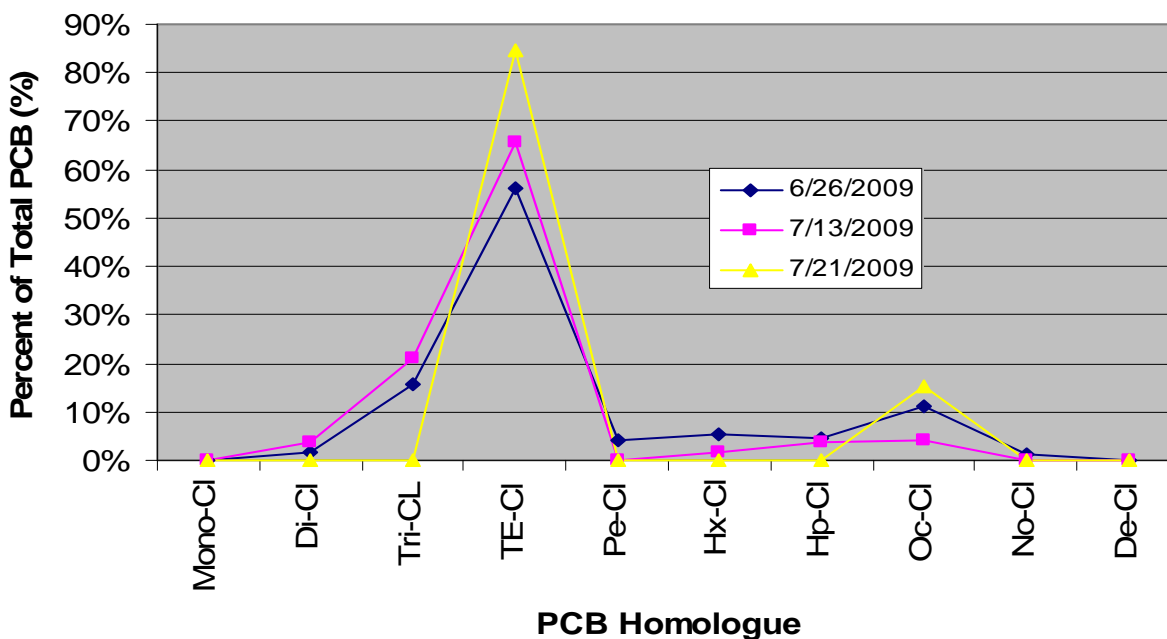

Figure 43. PCB Homologue Data from Storm Flow Samples Collected from the Rio Grande at Otowi Bridge Location

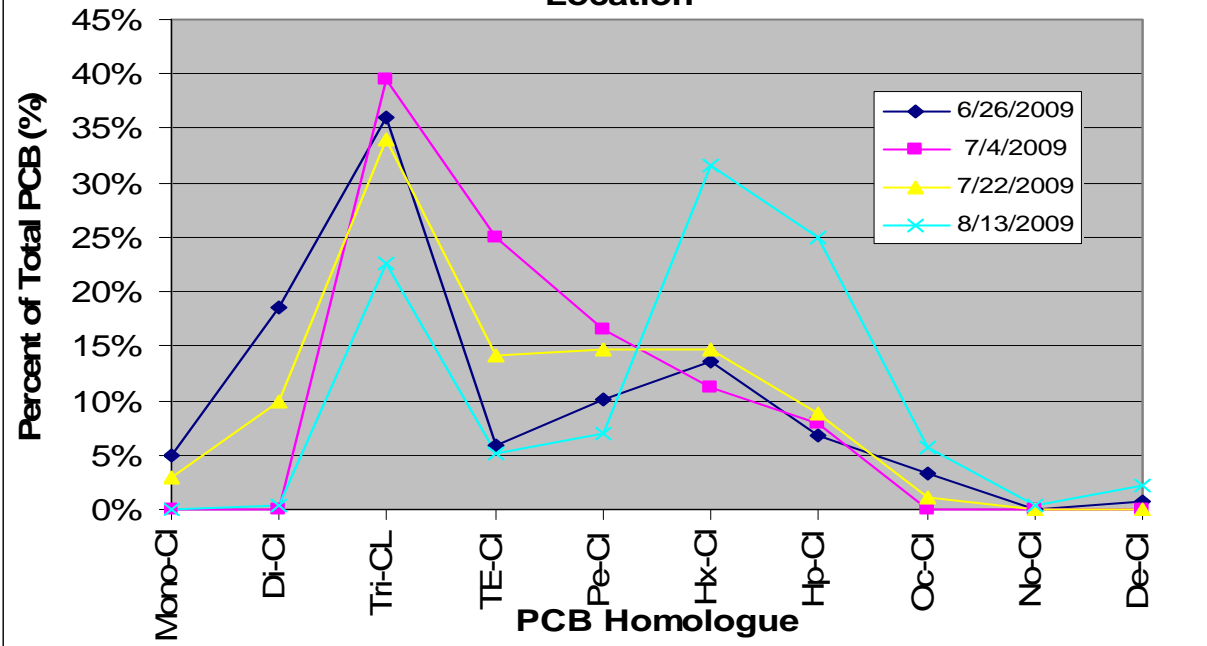

Figure 44. PCB Homologue Data from Baseline and Storm Flow Samples Collected from the Rio Grande at Buckman Landing Location

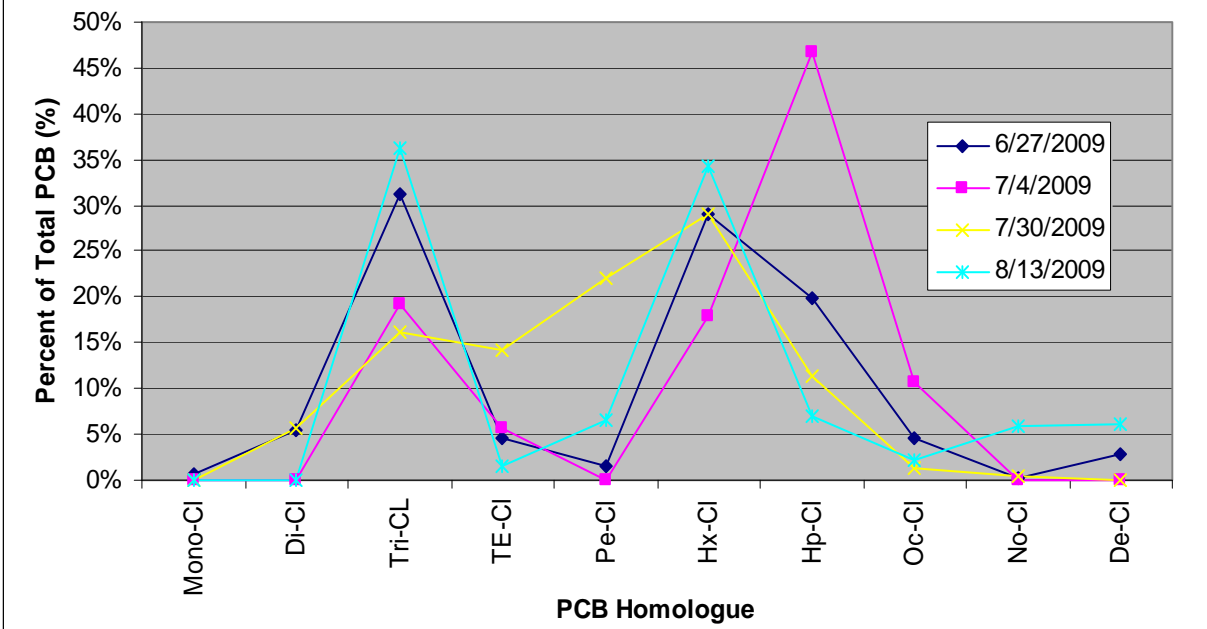

Figure 45. PCB Homologue Data from Baseline and Storm Flow Samples Collected from the Rio Grande above Alameda Location

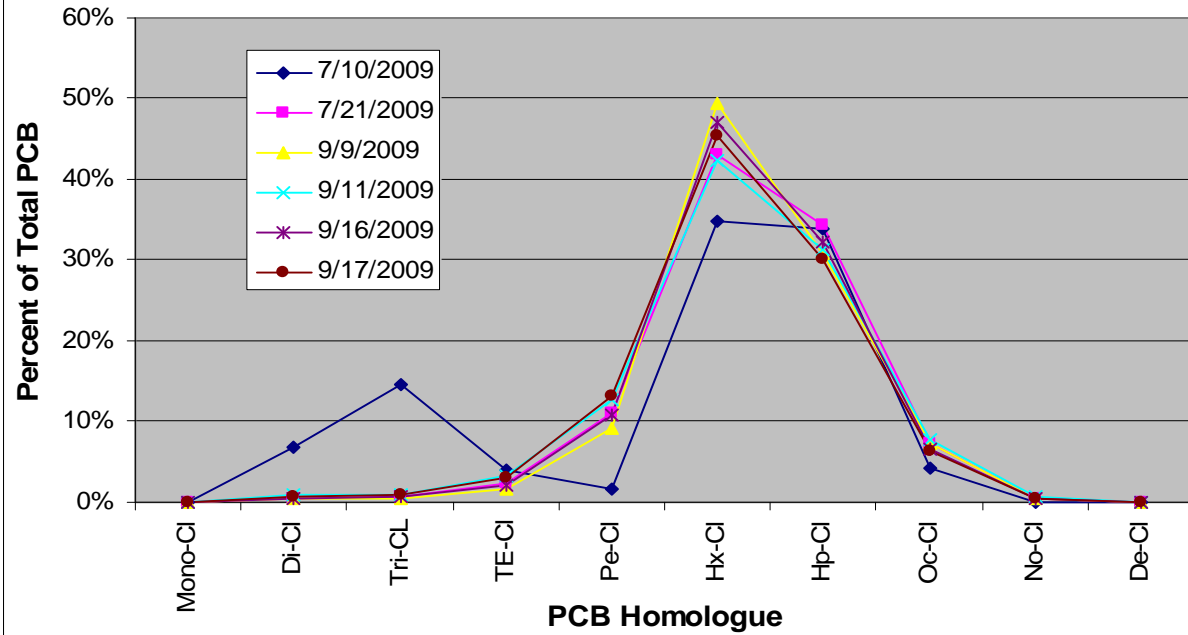

Figure 46. PCB Homologue Data from Storm Flow Samples Collected from the Rio Grande and Chama River Locations (upstream of Buckman Landing)

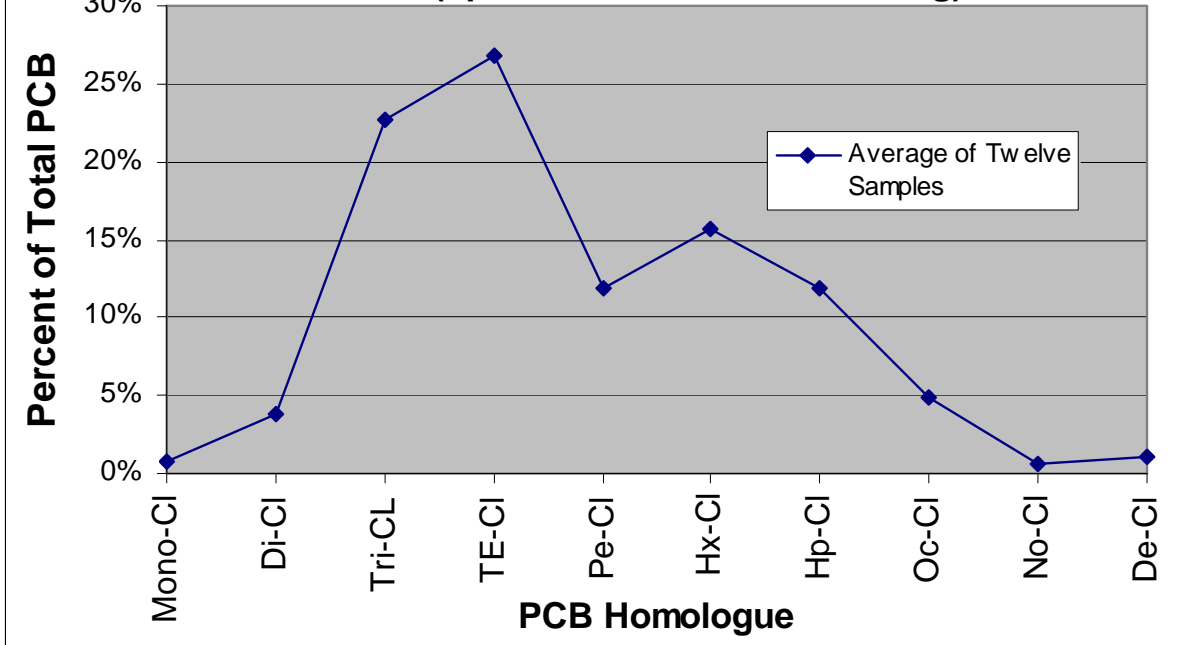

Figure 47. PCB Homologue Data from Storm Flow Samples Collected from the Rio Grande above Alameda Location

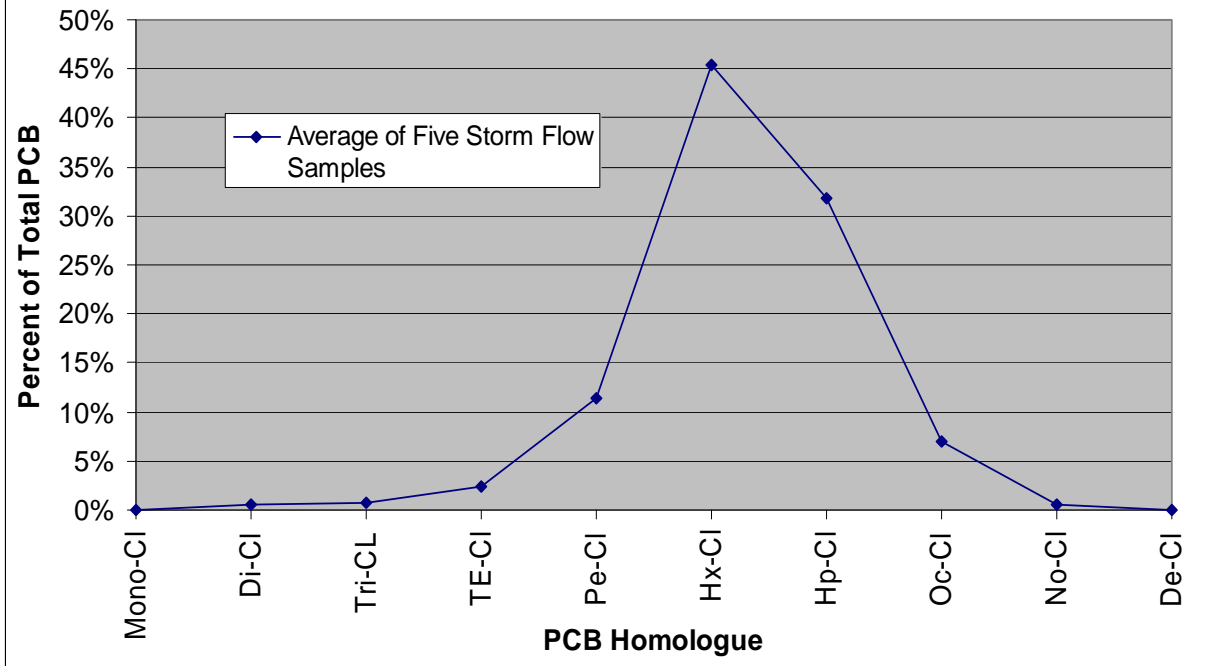

Figure 48. PCB Distribution in Fish Tissue and Suspended Sediments from Rio Grande near Albuquerque

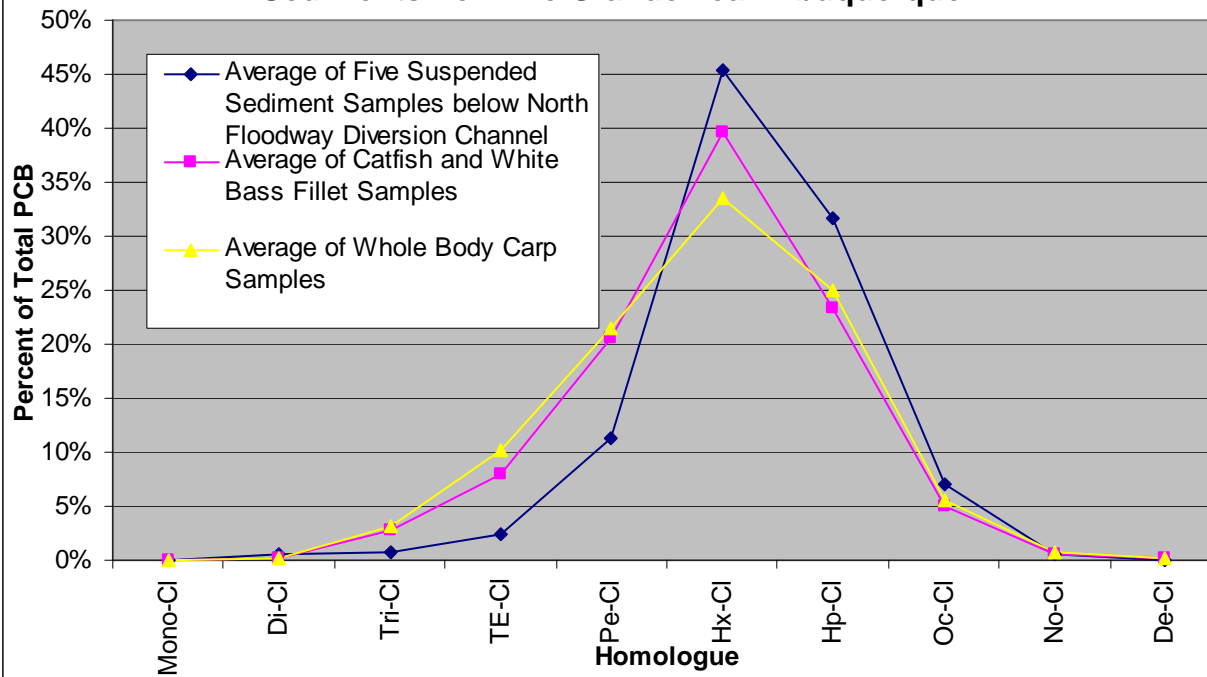

Figure 49. PCB Distribution in Rio Grande Sediments and Storm Flow Samples from Rio Grande above Alameda

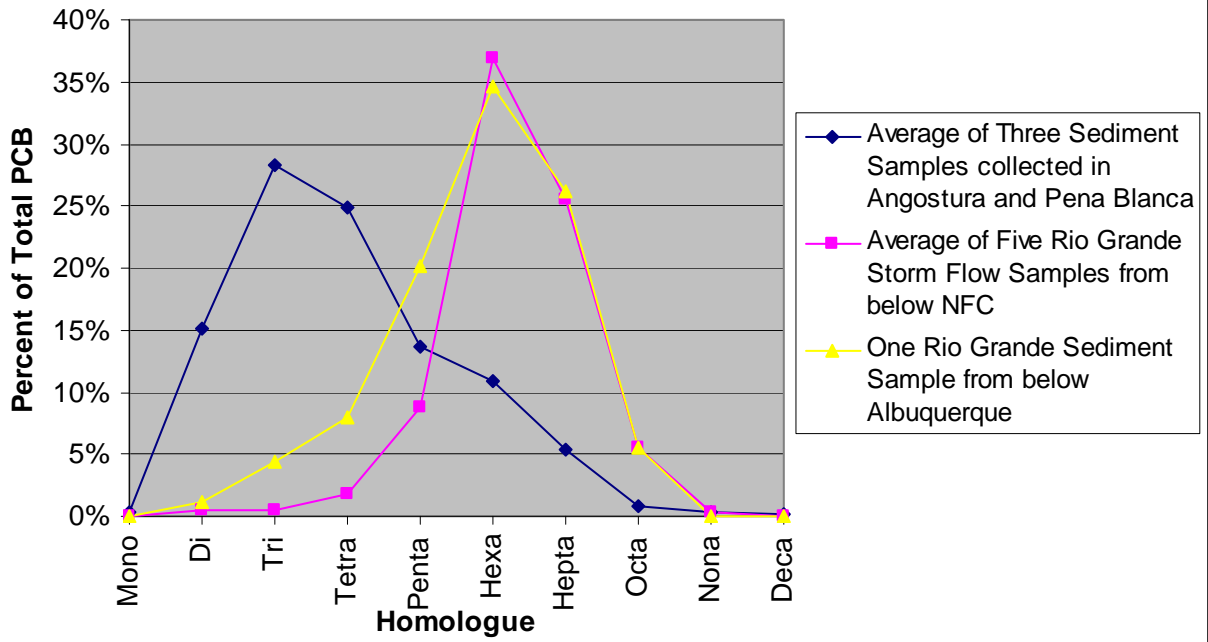
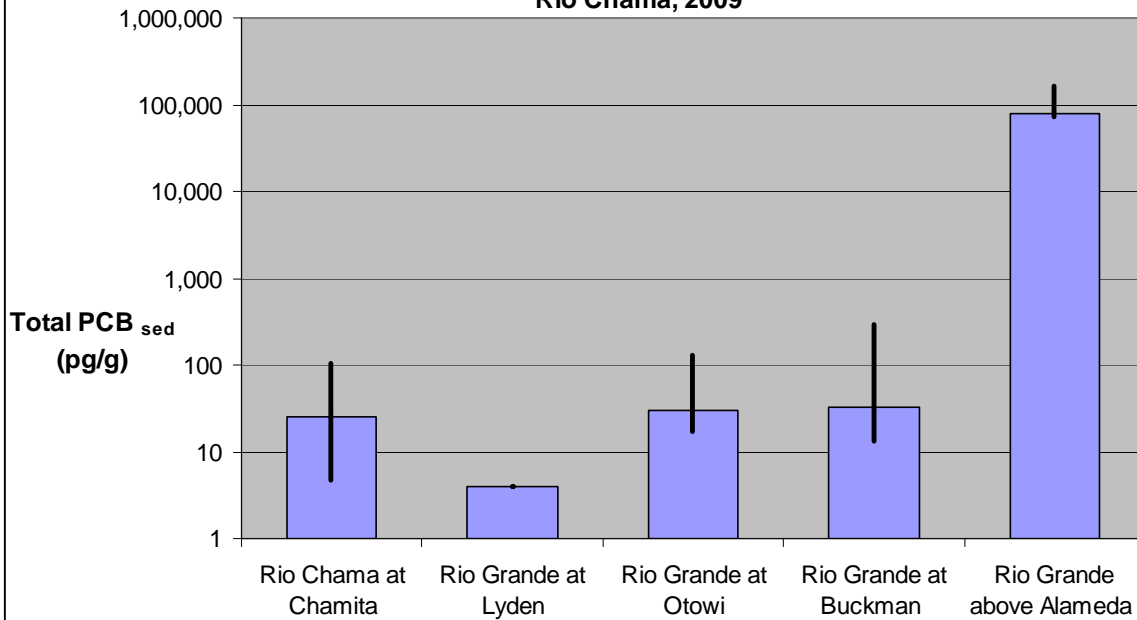

Figure 50. PCB Concentration in Suspended Sediments of the Rio Grande and Rio Chama, 2009



Column height indicates the median
Error bars indicate the range