

NPDES Compliance Inspection Manual



EPA Publication Number: 305-K-17-001
Interim Revised Version, January 2017

THIS PAGE INTENTIONALLY LEFT BLANK

Disclaimer

This Inspection Manual is an inspection support tool provided by the U.S. Environmental Protection Agency (EPA) for use by field personnel conducting inspections under the Clean Water Act (CWA) National Pollutant Discharge Elimination System (NPDES) programs. The statements in this document are intended solely as guidance. The statutory provisions and EPA regulations described in this document contain legally binding requirements. This Inspection Manual is not a regulation and, therefore, does not add, eliminate or change any existing regulatory requirements. While EPA has made every effort to ensure the accuracy of the discussion in this guidance, the obligations of the regulated community are determined by statutes, regulations, or other legally binding requirements. In the event of a conflict between the discussion in this document and any statute or regulation, this document would not be controlling.

This document is not intended, nor can it be relied on, to create any rights, substantive or procedural, enforceable at law by any party in litigation with the United States. This guidance may be revised without public notice to reflect changes in EPA policy. Deviations from this guidance on the part of any duly authorized official, inspector, or agent to follow its contents shall not be a defense in any enforcement action; nor shall deviation from this guidance constitute grounds for rendering the evidence obtained thereby inadmissible in a court of law. The mention of trade names or commercial products does not constitute endorsement or recommendation for their use.

This version of the NPDES Compliance Inspection Manual is released as an interim version in order to allow time for inspectors to use the Manual and provide feedback to EPA's Office of Enforcement and Compliance Assurance (OECA). OECA is interested in user comments that will enhance a future final version of the Manual. In addition, as OECA's efforts with states through E-Enterprise continue, this Interim Revised NPDES Compliance Inspection Manual will inform development of Smart Tools software and hardware for NPDES inspectors to use in the field.

Please send your comments on this Interim Revised NPDES Compliance Inspection Manual to OECA at NPDEScompliance@epa.gov by December 31, 2017.

Contents

Chapter 1 – INTRODUCTION	1
A. Purpose and Objectives.....	3
B. Inspection Types	3
Compliance Evaluation Inspection (CEI).....	4
Compliance Sampling Inspection (CSI)	4
Performance Audit Inspection (PAI).....	4
Off-Site Desk Audit	4
Compliance Biomonitoring Inspection	5
Toxics Sampling Inspection	5
Diagnostic Inspection	5
Reconnaissance Inspection (RI)	5
Pretreatment Compliance Inspection (PCI).....	6
Focused Compliance Inspection (FCI).....	6
Follow-up Inspection (FUI)	7
Sewage Sludge/Biosolids Inspection	7
Significant Industrial User (SIU) Inspection	7
Combined Sewer Overflow (CSO) Inspection.....	7
Sanitary Sewer Overflow (SSO) Inspection.....	8
Stormwater Inspection.....	8
Municipal Separate Storm Sewer System (MS4) Audit	9
Municipal Separate storm Sewer System (MS4) Inspection	9
Concentrated Animal Feeding Operation (CAFO) Inspection.....	9
Summary	9
C. Legal Authority for NPDES Inspections.....	10
Inspection Authority.....	10
State Program Authority	10
D. Responsibilities of the EPA NPDES Inspector	11
Indian Country Inspections.....	11
Legal Responsibilities.....	12
Procedural Responsibilities	12
Inspection Procedures.....	12
Training and Credentialing Responsibilities	14
Safety Responsibilities.....	15
Professional Responsibilities	15
Professional Attitude.....	16
Gifts, Favors, Luncheons.....	16
Requests for Information	16
Quality Assurance Responsibilities.....	17
Next Generation Compliance	17
E. References.....	23
Chapter 2 – INSPECTION PROCEDURES	24
A. Pre-Inspection Preparation.....	26

Contents (Continued)

Review of Facility Background Information	26
Sources of Facility Background Information	29
Developing an Inspection Plan and/or Checklist.....	30
Developing a Health and Safety Plan	31
Notifying the Facility.....	31
Notifying state of Federal Inspection	32
Preparing Equipment and Supplies	32
B. Off-site Surveillance.....	34
Considerations.....	34
C. Entry	35
Entry Procedures.....	35
Problems with Entry or Consent	36
Warrants.....	38
D. Opening Conference	38
Considerations.....	38
E. Documentation.....	41
Inspector's Field Notebook.....	41
Samples	42
Interviews and Statements.....	42
Digital Images	44
Video.....	45
GPS	45
Drawings and Maps.....	45
Printed Matter.....	45
Electronic Records.....	45
Copies of Records.....	45
General Considerations.....	47
Confidential Business Information (CBI)	47
F. Closing Conference	50
G. Inspection Report	51
Objective of the NPDES Inspection Report	51
Effectively Communicate and Document Findings in the Inspection Report	52
Elements of a Report.....	54
Integrated Compliance Information System (ICIS).....	55
H. References.....	56
Chapter 3 – DOCUMENTATION/RECORDKEEPING AND REPORTING	57
A. Inspection Authority and Objectives.....	58
Authority and Objectives.....	58
B. Evaluation Procedures	59
Verification, Recordkeeping, and Reporting Evaluation Procedures	59
Compliance Schedule Status Review.....	62
POTW Pretreatment Requirements Review.....	63

Contents (Continued)

In-depth Investigations.....	64
C. Verification, Recordkeeping, and Reporting Evaluation Checklist.....	65
Chapter 4 – FACILITY SITE REVIEW—Wastewater Treatment plants	69
A. Objectives.....	70
B. Physical Inspection of the Facility	70
General Conditions in Overall Plant	72
Wastewater Collection System	73
Preliminary Treatment at the Headworks.....	73
Primary Clarifier.....	74
Secondary Biological Treatment Units	75
Secondary Clarifier	76
Advanced Physical Treatment Units.....	76
Disinfection.....	78
Sludge Handling.....	79
Polishing Ponds or Tanks	82
Plant Effluent.....	82
Flow Measurement	82
Chemical Treatment Units.....	83
Standby Power and Alarms	83
General Housekeeping	83
Production Changes	83
C. Permit Compliance and Operation and Maintenance Evaluation	84
Compliance Evaluation.....	84
Operation Evaluation	85
Maintenance Evaluation.....	91
D. References.....	92
E. Facility Site Review Checklist.....	94
Chapter 5 – SAMPLING	98
A. Evaluation of Permittee Sampling Program and Compliance Sampling.....	99
Objectives and Requirements	99
Significant Industrial User Monitoring Program.....	100
Biosolids Monitoring Program.....	100
Toxicity Testing Program	100
StormWater Program	100
B. Sampling Procedures and Techniques.....	100
Wastewater Sample Collection Techniques.....	101
EPA Sample Identification Methods.....	106
Wastewater Sample Preservation and Holding Time.....	106
Transfer of Custody and Shipment of Samples	107
Quality Control	108
Quality Assurance Project Plan	112
Data Handling and Reporting	113

Contents (Continued)

C. References.....	113
D. Permittee Sampling Inspection Checklist	115
Chapter 6 – FLOW MEASUREMENT	117
A. Evaluation of Permittee's Flow Measurement.....	118
Objective and Requirements	118
Evaluation of Facility Installed Flow Devices and Data	118
Evaluation of Permittee Data Handling and Reporting	120
Evaluation of Permittee Quality Control	121
B. Flow Measurement Compliance	121
Objectives	121
Flow Measurement System Evaluation.....	121
Closed Conduit Evaluation Procedures	123
Primary Device Inspection Procedures	123
Secondary Device Inspection Procedures	126
C. References.....	129
D. Flow Measurement Inspection Checklist.....	131
Chapter 7 – LABORATORY PROCEDURES AND QUALITY ASSURANCE.....	133
A. Objectives and Requirements.....	134
B. Sample Handling Procedures	134
Evaluation of Permittee Sample Handling Procedures	134
C. Laboratory Analyses Techniques Evaluation.....	135
Evaluation of Permittee Laboratory Analytical Procedures	135
Evaluation of Permittee Laboratory Facilities and Equipment	136
D. Quality Assurance and Quality Control	138
Evaluation of the Precision and Accuracy of the Permittee Laboratory	138
Example of Laboratory QA/QC Measures for Microbial Analyses	140
Evaluation of Permittee Data Handling and Reporting	140
Evaluation of Permittee Laboratory Personnel.....	141
Evaluation of Contract Laboratories	141
Overview of the Discharge Monitoring Report Quality Assurance Program and How It Relates to the Inspection Program.....	141
E. References.....	142
F. Laboratory Quality Assurance Checklist	144
Chapter 8 – TOXICITY	147
A. Objectives.....	148
B. Requirements of WET Testing.....	149
Types of WET Testing	149
WET Test Components	150
Effluent	151
Dilution Water	152

Contents (Continued)

Test System	154
Test Organisms	154
Reference Toxicants	156
Conduct of the Test(s)	157
Recordkeeping and Data Reporting	157
Review Checklist	158
C. Analysis of WET Data	159
D. Toxicity Reduction Evaluations and Toxicity IDentification Evaluations (TRES/TIEs)	168
E. References.....	170
Chapter 9 – PRETREATMENT	172
A. Review of the General Pretreatment Regulations	173
Development of 40 CFR Part 403	173
Summary and Background	174
Program Development and NPDES Requirements.....	175
Approval Authority Responsibilities	180
Control Authority Responsibilities.....	180
Industry Responsibilities	182
B. Pretreatment Compliance Inspections and OTHER COMPLIANCE EVALAUTION ACTIVITIES..	189
Scope of PCIs and Audits	189
PCI Checklist Components and Inspection Report	191
Pretreatment Audit Checklist Components	192
C. References.....	193
Chapter 10 – SEWAGE SLUDGE (BIOSOLIDS).....	196
A. Review of the Sewage Sludge Regulations (Biosolids).....	198
Land Application Requirements (40 CFR Part 503, Subpart B).....	200
Surface Disposal Requirements (40 CFR Part 503, Subpart C)	203
Incineration Requirements (Subpart E).....	204
B. Sludge (Biosolids) Inspection Procedures	209
Scope of Inspection Activities.....	209
Inspection Preparation	210
Records Review	211
Facility Site Review	214
Sampling and Laboratory Quality Assurance (QA)	216
C. References.....	229
Chapter 11 – STORMWATER.....	234
A. Background and History	236
Regulation Overview (40 CFR 122.26).....	236
B. Stormwater Discharges Associated with Industrial Activity (Not Including Construction).....	241
Applicability (Who is Covered)	241
Permit Applications for Stormwater Discharges Associated with Industrial Activity	244

Contents (Continued)

Monitoring (including Self-Inspections)	249
C. Stormwater Discharges Associated with Construction Activity	254
Applicability (Who is Covered)	254
Permit Applications for Stormwater Discharges Associated With Construction Activity.....	256
Stormwater Pollution Prevention Plan Requirements	258
SWPPP Implementation/In the Field.....	264
D. Stormwater Discharges From Municipal Separate Storm Sewer Systems	266
Applicability (Who is Covered)	266
Permit Applications for Stormwater Discharges From Municipal Separate Storm Sewer Systems.....	267
Stormwater Management Program (SWMP) Development	269
SWMP Implementation/In the Field	273
E. References.....	274
Chapter 12 – COMBINED SEWER OVERFLOWS.....	281
A. Background and History of the CSO Policy	282
B. CSO Inspection Procedures.....	285
Preparation.....	285
On-site Records Review.....	287
Interviews.....	289
Facility Site Inspection.....	292
C. References.....	292
D. CSO Evaluation Checklist.....	294
Chapter 13 – SANITARY SEWER OVERFLOWS	296
A. Overview of SSOs.....	297
B. SSO Inspection Procedures.....	299
Preparation.....	299
Records Review	301
Interviews.....	302
Facility Site Inspection.....	303
C. References.....	306
Chapter 14 – INSPECTING GREEN INFRASTRUCTURE CONTROLS	308
A. Introduction	310
Science of Green Infrastructure	310
Design and Inspection Preparation	311
Considerations on Inspection Timing	312
Types of Green Infrastructure Management Practices.....	313
B. Infiltration Controls	314
Description	314
Design of Infiltration Controls	316

Contents (Continued)

Inspecting Infiltration Controls.....	317
Common Infiltration Control Issues	317
C. Permeable Pavement Controls	319
Description	319
Design of Permeable Pavements and Pavers	322
Inspecting Permeable Pavements	322
Common Permeable Pavement Issues.....	323
D. Rainwater Harvesting Systems	325
Description	325
Design of Rainwater Harvesting Systems.....	326
Inspecting Rainwater Harvesting Systems	329
Common Rainwater Harvesting Issues.....	329
E. Green Roofs.....	331
Description	331
Design of Green Roofs.....	332
Inspecting Green Roofs	334
Common Green Roof Issues	335
F. References.....	335
Chapter 15 – CAFO PROGRAM INSPECTIONS.....	339
A. Overview of NPDES CAFO Program.....	341
Introduction.....	341
Background and History of the CAFO Regulations	341
NPDES CAFO Permits.....	352
Operations Covered by Subpart C—Dairy Cows and Cattle Other than Veal Calves and by Subpart D—Swine, Poultry and Veal Calves.....	355
Best Professional Judgment (BPJ)	359
Other Technology-Based Limitations that Apply to Discharges from CAFOs.....	359
Water Quality-Based Effluent Limitations and Standards.....	360
Requirements for the Land Application Area of Permitted Large CAFOs	360
Monitoring, Recordkeeping, and Reporting Requirements of NPDES Permits for CAFOs	365
B. Preparing for the CAFO Or AFO Inspection.....	371
Selection of Facilities for Inspection.....	371
Compliance Determination Strategy	372
CAFO Inspector Responsibilities and Preparation Activities	374
CAFO Inspection Plan	386
C. The CAFO Inspection—Facility Tour	388
Arrival On-Site	388
Opening Conference.....	391
Record and On-Site Document Review	393
Facility Tour	394
D. The CAFO Inspection—Records Review and the NMP.....	411

Contents (Continued)

Unpermitted Large CAFOs.....	411
Records for Permitted Large CAFOs	414
E. Closing Conference	424
F. After the CAFO or AFO Inspection.....	425
Communication With The CAFO Operator	426
G. References.....	428
Chapter 16 – VESSEL GENERAL PERMIT (VGP)	430
A. Background and Overview	431
Background and History of the VGP	431
VGP Overview.....	431
B. Permits.....	434
Authorization under the VGP	434
Discharge Types Specifically Not Authorized By the VGP	435
Technology-Based Effluent Limits and related requirements Applicable to All Vessels.....	435
Effluent Limits and Related Requirements For Specific Discharge Categories	438
Vessel Class-Specific Requirements	443
Additional Water Quality-Based Effluent Limits	445
C. Permit Inspections and Monitoring	446
Self Inspections and Monitoring	446
Permit Recordkeeping.....	449
Additional Recordkeeping for vessels Equipped with Ballast Tanks	451
Permit Reporting	452
Vessel Inspection Overview.....	454
VGP Inspection Procedures	455
D. Safety Hazards	465
Expected Hazards	465
Physical Hazards	465
Thermal Hazards.....	465
Chemical Hazards	465
Biological Hazards.....	466
Personal Protective Equipment (PPE)	466
E. Violations and Examples	466
Common VGP Violations and Examples of Good and Bad Practices.....	466
Good and Bad Practices.....	467
F. References.....	470
Chapter 17 – POLLUTION PREVENTION	472
A. Overview of Pollution Prevention.....	473
Pollution Prevention Goals.....	473
Waste Management Hierarchy	473
Pollution Prevention Benefits.....	475
B. Pollution Prevention Opportunity Assessment Procedures for Industrial Facilities	478

Contents (Continued)

Preparation.....	479
Interview.....	480
Facility Site Visit.....	480
C. Pollution Prevention Opportunity Assessment Procedures For Municipal wastewater treatment plants	484
D. References.....	486
E. Checklists	488
Chapter 18 – MULTIMEDIA CONCERNS	495
A. Introduction	496
B. Overview of the Multimedia Approach to Inspections.....	496
C. Multimedia Concerns at NPDES Facilities and the Multimedia Screening Program.....	498
Hazardous Waste.....	498
Hazardous Waste Cleanup Actions Under RCRA/CERCLA	499
Nonhazardous Sludge.....	499
Air	500
Multimedia Screening	500
D. NPDES Inspectors and Multimedia Inspections	501
Description of a Multimedia Inspection	501
The NPDES Inspector's Role in a Multimedia Inspection	502
E. References.....	503
Chapter 19 – APPEARING AS A WITNESS	505
A. Introduction	506
B. Pre-Testimony Matters	506
Preparation.....	506
Legal Etiquette, Appearance, and Demeanor	507
C. Giving Testimony	508
General Considerations.....	508
Pre-Trial Testimony: Depositions	509
Trial Testimony: Direct Examination	509
Trial Testimony: Cross-Examination	510
D. Special Considerations	511
Technical Testimony.....	511
Expert Witness.....	512

Appendices

Appendix A – EPA Order 3500.1, Training and Development for Individuals who lead Compliance Inspections/Field Investigations	513
Appendix B – EPA Order 3510, EPA Federal Credentials for Inspections and Enforcement of Environmental Statutes	527
Appendix C – EPA Order 1440.2, Health and Safety Requirements for Employees Engaged in Field Activities.....	528
Appendix D – EPA’s Memorandum on Practices to Follow and Avoid when Requesting Information	538
Appendix E – Sample CWA Section 308 Information Collection Request Letter (308 Letter).....	542
Appendix F – Final Fact Sheet: The Do’s and Don’ts of Using U.S. EPA Credentials	549
Appendix G – EPA’s Memorandum On Entry Procedures	556
Appendix H – EPA’s Policy on the Use of Digital Cameras for Inspections	566
Appendix I – EPA’s Memorandum On Deficiency Notice Guidance	567
Appendix J – Inspection Conclusion Data Summary (ICDS)	573
Appendix K – Draft Guidance for Releasing Civil Inspection Reports	575
Appendix L – Sample Discharge Monitoring Report (DMR) Form	577
Appendix M – Example Chain-of-Custody Form	579
Appendix N – Updated Fact Sheet: Department of Transportation Hazardous Materials.....	581
Appendix O – Supplemental Flow Measurement Information.....	585
Appendix P – Sludge Inspection Checklists	612
Appendix Q – No Exposure Certification Form	626
Appendix R – NPDES Industrial Storm Water Investigation and Case Development (Industrial).....	631
Appendix S – Industrial Source Control BMP Questions.....	642
Appendix T – Notice of Termination for Stormwater	647
Appendix U – Typical "C" Coefficients	650
Appendix V – Rain Zones of the United States	652
Appendix W – NOAA Rainfall Worksheet	654
Appendix X – NPDES Industrial Storm Water Investigation and Case Development (Construction)	656
Appendix Y – Construction Source Control BMP Questions	670
Appendix Z – Infiltration Control Inspection Form	674
Appendix AA – Permeable Pavements Inspection Form	677
Appendix AB – Rainwater Harvest Inspection Form	680
Appendix AC – Green Roof Inspection Form	683
Appendix AD – Animal Industry Overview	686

Contents (Continued)

Appendix AE – Management/Soil Science	712
Appendix AF – Standard Operating Procedure (SOP): Biosecurity Procedures for Visits to Livestock and Poultry Facilities	719
Appendix AG – Field and Personal Protective Equipment	730
Appendix AH – Mapping Tool (Region 5)	733
Appendix AI – Sample Permitted CAFO Inspection Checklist	738
Appendix AJ – Regional Inspections Checklists	752
Appendix AK – Growth Stages of Common Field Crops	772
Appendix AL – Inspection Introduction Letter	776
Appendix AM – Sampling Procedures and Equipment	780
Appendix AN – Sample Quality Assurance Project Plan (QAPP)	787
Appendix AO – Detailed Review of Nutrient Management Plan Implementation	825
Appendix AP – Inspection Report Template (R7)	842
Appendix AQ – Media-Specific Inspection Components	853
Appendix AR – National Multimedia Screening Inspection Worksheet	880

List of Tables

Table 1-1. NPDES-Related Statutes and Regulations.....	11
Table 1-2. Inspector's Responsibilities.....	13
Table 2-1. Inspection Equipment List.....	33
Table 4-1. Operation and Maintenance Function Evaluation Questions.....	86
Table 5-1. Compositing Methods.....	102
Table 5-2. Quality Control Procedures for Field Analysis and Equipment.....	110
Table 8-1. Recommended Effluent Sampling Strategies for Continuous and Intermittent Discharges for Flow-Through, Static Renewal, and Static Toxicity Tests ^a	153
Table 8-2. Summary of TAC per EPA Method	165
Table 9-1. Summary of the General Pretreatment Regulations	184
Table 9-2. Categorical Pretreatment Standards	188
Table 10-1. Records Relevant for Sludge Operations	217
Table 10-2. Operating Records for Specific Unit Processes	218
Table 10-3. Sludge Sampling Points	220
Table 10-4. Recordkeeping Requirements for Class A Pathogen Reduction Alternatives ^a	223
Table 10-5. Recordkeeping Requirements for Class B Pathogen Reduction Alternatives ^a	225
Table 10-6. Recordkeeping Requirements for Vector Attraction Reduction Sludge Processing Options.....	225
Table 10-7. Sludge Handling Process Evaluation	226
Table 10-8. Pollutants Monitored for Land Application, Surface Disposal, and Incineration.....	229
Table 11-1. Summary of Stormwater Permitting Regulations.....	238
Table 11-2. Summary of Permit Requirements Under the NPDES Stormwater Program Regulations	240
Table 11-3. SIC Codes Regulated for Stormwater Discharges	250
Table 11-4. Industrial Categories Associated with Industrial Activity	252
Table 11-5. Examples of Site-Specific Industrial Stormwater Control Measures	253
Table 11-6. Site-Specific Construction Stormwater Control Measures	266
Table 12-1. Nine Minimum CSO Controls	284
Table 12-2. Elements of the Long-Term CSO Control Plan	284
Table 12-3. CSO Records	288
Table 12-4. CSO Interview Questions	290
Table 13-1. Documents to Review	305

List of Tables (Continued)

Table 14-1. Sample Design Management Practice Selection Matrix According to Site Characteristics (Source: Modified from Dorman et al., 2013).....	314
Table 15-1. Large CAFOs	345
Table 15-2. Medium CAFOs	347
Table 15-3. Information Required on NPDES Application Forms 1 and 2B	352
Table 15-4. Effluent Limitation Summary	354
Table 15-5. Required Records for Permitted Large CAFOs	366
Table 15-6. Required Records for Permitted Small and Medium CAFOs.....	368
Table 15-7. Example Inspection Focus for Compliance Determination Strategy Based on Inspection Type	372
Table 15-8. Minimum Measures and Associated Records Applying to Unpermitted Large CAFOs.....	412
Table 15-9. Example Records and Potential Compliance Alerts Associated with NMP Minimum Measures i–v	416
Table 15-10. Example Records and Potential Compliance Alerts Associated with NMP Minimum Measures vi–viii	421
Table 16-1. Vessel Discharge Descriptions.....	461
Table 17-1. Useful Facility Information to Conduct a Pollution Prevention Opportunity Assessment	484

List of Exhibits

Exhibit 1-1. Next Generation Compliance Components	17
Exhibit 1-2. Example ITM Query	20
Exhibit 1-3. Results from Example ITM Query in Exhibit 1-2	20
Exhibit 1-4. Effluent Limit Exceedances Search Form	21
Exhibit 1-5. Effluent Limit Exceedances Search Sorting Table	22
Exhibit 1-6. Effluent Limit Exceedances Search – Facility View	22
Exhibit 10-1. Sludge Quality Requirements for Land Application Uses	206
Exhibit 10-2. Land Applied Sludge Requirements Based on Level of Treatment Achieved	207
Exhibit 10-3. Sludge Quality Requirements for Surface Disposal	208
Exhibit 17-1. Waste Management Hierarchy.....	477
Exhibit 17-2. Benefits of Pollution Prevention.....	477
Exhibit 17-3. Pollution Prevention Opportunity Assessment	483

CHAPTER 1 – INTRODUCTION

Contents

A. Purpose and Objectives	3
B. Inspection Types	3
Compliance Evaluation Inspection (CEI).....	4
Compliance Sampling Inspection (CSI).....	4
Performance Audit Inspection (PAI).....	4
Off-Site Desk Audit.....	4
Compliance Biomonitoring Inspection.....	5
Toxics Sampling Inspection.....	5
Diagnostic Inspection.....	5
Reconnaissance Inspection (RI).....	5
Pretreatment Compliance Inspection (PCI).....	6
Focused Compliance Inspection (FCI).....	6
Follow-up Inspection (FUI).....	7
Sewage Sludge/Biosolids Inspection.....	7
Significant Industrial User (SIU) Inspection.....	7
Combined Sewer Overflow (CSO) Inspection.....	7
Sanitary Sewer Overflow (SSO) Inspection.....	8
Stormwater Inspection.....	8
Municipal Separate Storm Sewer System (MS4) Audit.....	9
Municipal Separate storm Sewer System (MS4) Inspection.....	9
Concentrated Animal Feeding Operation (CAFO) Inspection.....	9
Summary.....	9
C. Legal Authority for NPDES Inspections	10
Inspection Authority.....	10
State Program Authority.....	10
D. Responsibilities of the EPA NPDES Inspector	11
Indian Country Inspections.....	11
Legal Responsibilities.....	12
Procedural Responsibilities.....	12
Inspection Procedures.....	12
Training and Credentialing Responsibilities.....	14
Safety Responsibilities.....	15
Professional Responsibilities.....	15
Professional Attitude.....	16
Gifts, Favors, Luncheons.....	16
Requests for Information.....	16
Quality Assurance Responsibilities.....	17
Next Generation Compliance.....	17
E. References	23

List of Tables

Table 1-1. NPDES-Related Statutes and Regulations.....	11
Table 1-2. Inspector's Responsibilities.....	13

List of Exhibits

Exhibit 1-1. Next Generation Compliance Components	17
Exhibit 1-2. Example ITM Query	20
Exhibit 1-3. Results from Example ITM Query in Exhibit 1-2	20
Exhibit 1-4. Effluent Limit Exceedances Search Form.....	21
Exhibit 1-5. Effluent Limit Exceedances Search Sorting Table	22
Exhibit 1-6. Effluent Limit Exceedances Search – Facility View	22

Associated Appendices

- A. EPA Order 3500.1, Training and Development for Individuals who lead Compliance Inspections/Field Investigations.
- B. EPA Order 3510, EPA Federal Credentials for Inspections and Enforcement of Environmental Statutes.
- C. EPA Order 1440.2, Health and Safety Requirements for Employees Engaged in Field Activities.

A. PURPOSE AND OBJECTIVES

Compliance monitoring is a cornerstone of the Environmental Protection Agency's (EPA's) program to achieve clean water. The primary goal of EPA compliance monitoring efforts, such as on-site inspections, is to ensure and document whether entities regulated under the National Pollutant Discharge Elimination System (NPDES) and pretreatment programs are complying with their Clean Water Act (CWA) obligations. EPA's NPDES inspection program identifies and documents noncompliance, supports authorized state NPDES programs, supports the enforcement process, monitors compliance with enforcement orders and decrees, establishes presence in the regulated community, deters noncompliance, supports the permitting process, and furthers the broad watershed protection and restoration goals of the NPDES program. The purpose of this guidance is to provide inspectors with an in-depth knowledge of the NPDES inspection process.

EPA inspects NPDES facilities where we directly implement the program (e.g., in states without NPDES program authorization and in Indian country). In addition, EPA sometimes conducts inspections in states with NPDES program authorization at the request of states to complement the state's own inspection efforts and to respond to tips or complaints. EPA regions and states communicate closely throughout the year on inspection planning and targeting to maintain a strong NPDES compliance monitoring program.

Throughout this Manual, EPA has made every effort to avoid references to or identification of particular facilities. Any specific examples of noncompliance found in the Manual are offered as facts with the goal of helping inspectors be well-prepared to conduct thorough inspections that support the enforcement process. Such examples are not a statement about any one facility's compliance status or the adequacy of the authorized state's compliance monitoring program.

Routine EPA NPDES compliance inspections should be performed in a manner designed to:

- Determine compliance status with regulations, permit conditions, and other program requirements.
- Verify the accuracy of information submitted by permittees.
- Verify the adequacy of sampling and monitoring conducted by the permittee.

Other purposes of compliance inspections include:

- Gathering evidence to support enforcement actions
- Obtaining information that supports the permitting process
- Assessing compliance with orders or consent decrees

B. INSPECTION TYPES

This manual provides guidance applicable to each type of inspection an NPDES inspector may be required to conduct at an NPDES permitted facility or an unpermitted facility with discharges. Specifically, this manual provides information and references on the components

necessary to complete the various types of NPDES inspections. Many of the chapters also include checklists. An inspector should not rely solely on the checklist, but use it as one of the tools when conducting an inspection and evaluating compliance. The different types of inspections are described below.

COMPLIANCE EVALUATION INSPECTION (CEI)

The CEI is a non-sampling inspection designed to verify permittee compliance with applicable permit self-monitoring requirements, effluent limits, effluent toxicity, and compliance schedules. Inspectors should review records, make visual observations, and evaluate treatment facilities, laboratories, effluents, and receiving waters. During the CEI, the inspector must examine both chemical and biological self-monitoring, which form the basis for all other inspection types except the Reconnaissance Inspection.

COMPLIANCE SAMPLING INSPECTION (CSI)

The CSI is a sampling inspection designed with the same objectives as a CEI. The inspector conducts the same tasks for a CSI as for a CEI, with the additional task of taking and analyzing representative samples. Inspectors can then verify the accuracy of the permittee's self-monitoring program and reports through chemical and/or bacteriological analysis, determine compliance with discharge limitations and Whole Effluent Toxicity (WET) permit requirements, determine the quantity and quality of effluents, and provide evidence for enforcement proceedings where appropriate.

PERFORMANCE AUDIT INSPECTION (PAI)

The inspector conducts a PAI to evaluate the permittee's self-monitoring program. As with a CEI, the PAI verifies the permittee's reported data and compliance through a records check. However, the PAI provides a more resource-intensive review of the permittee's self-monitoring program and evaluates the permittee's procedures for sample collection, flow measurement, chain-of-custody, laboratory analyses, data compilation, reporting, and other areas related to the self-monitoring program. In a CEI, the inspector makes a cursory visual observation of the treatment facility, laboratory, effluents, and receiving waters. In a PAI, the inspector observes the permittee performing the self-monitoring process from sample collection and flow measurement through laboratory analyses, data workup, and reporting. The PAI does not include the collection of samples by the inspector. However, the inspector may require the permittee to analyze performance samples for laboratory evaluation purposes.

OFF-SITE DESK AUDIT

An Off-site Desk Audit is a comprehensive off-site compliance evaluation of information, data, records, and facility reports to make a facility-level or program-level (for pretreatment and Municipal Separate Storm Sewer Systems) compliance determination. Routine off-site compliance monitoring activities, such as reviewing self-monitoring reports or records of phone calls with the facility, are not enough to be considered an off-site desk audit. An Off-site Desk Audit may include review of agency-gathered testing, sampling and ambient monitoring data, responses to CWA section 308 requests, compliance deliverables submitted pursuant to permits or enforcement orders, remote sensing, aerial or satellite images, Discharge Monitoring

Reports (DMRs), annual reports, conversations with facilities, and tips and complaints. In conducting an Off-site Desk Audit, regions and states may utilize video conferencing with facility personnel to gather additional information as they conduct their evaluation. For example, video conferencing could enable the auditor to join facility personnel on a virtual walking tour of all or part of the facility. The Off-site Desk Audit must be performed by an authorized inspector (consistent with appropriate federal, state, or tribal authority) or other credible regulator (i.e., an individual designated by the EPA or state/local/tribal agency with sufficient knowledge, training, or experience to assess compliance). This individual should select the candidate for the Off-site Desk Audit based on personal knowledge of the facility, in conjunction with information from DMRs, other reports, and prior on-site inspections, and have adequate information about the facility's activities to make a compliance determination.

COMPLIANCE BIOMONITORING INSPECTION

This inspection includes the same objectives and tasks as a CSI. A Compliance Biomonitoring Inspection reviews a permittee's toxicity bioassay techniques and records maintenance to evaluate compliance with the biomonitoring terms of the NPDES permit and to determine whether the permittee's effluent is toxic. The Compliance Biomonitoring Inspection also includes the collection of effluent samples by the inspector to conduct acute and chronic toxicity testing to evaluate the biological effect of a permittee's effluent discharge(s) on test organisms. Each state should be able to conduct biomonitoring inspections, have a designated contractor to conduct inspections, or have an equivalent program to independently verify a discharger's compliance with Whole Effluent Toxicity permit requirements.

TOXICS SAMPLING INSPECTION

A Toxics Sampling Inspection has the same objectives as a conventional CSI. However, it emphasizes toxic substances regulated by the NPDES permit. The Toxics Sampling Inspection covers priority pollutants other than heavy metals, phenols, and cyanide, which are typically included in a CSI (if regulated by the NPDES permit). A Toxics Sampling Inspection uses more resources than a CSI because sophisticated techniques are required to sample and analyze toxic pollutants. A Toxics Sampling Inspection may also evaluate raw materials, process operations, and treatment facilities to identify toxic substances requiring controls.

DIAGNOSTIC INSPECTION

The Diagnostic Inspection primarily focuses on Publicly Owned Treatment Works (POTWs) that have not achieved permit compliance. POTWs that are having difficulty diagnosing their problems are targeted. The purposes of the Diagnostic Inspection are to identify the causes of noncompliance, suggest immediate remedies that will help the POTW achieve compliance, and support current or future enforcement action.

RECONNAISSANCE INSPECTION (RI)

The RI is an on-site inspection that can be conducted with or without sampling and is used to obtain a preliminary overview of a permittee's compliance program. The inspector performs a brief visual inspection of the permittee's treatment facility, effluents, and receiving waters. The RI uses the inspector's experience and judgment to quickly summarize any potential compliance

problems. The objective of the RI is to expand inspection coverage without increasing inspection resources. The RI is the briefest and least resource intensive of all NPDES inspections.

PRETREATMENT COMPLIANCE INSPECTION (PCI)

The PCI evaluates the POTW's implementation of its approved pretreatment program. It includes a review of the POTW's records on monitoring, inspections, and enforcement activities for its industrial users (IUs). The PCI may be supplemented with IU inspections. An IU inspection is an inspection of any IU that discharges to the POTW.

While conducting a PCI, the region or state should ensure that the POTW is following its Enforcement Response Plan when the POTW identifies IU noncompliance. The PCI should include an appropriate number of IU inspections or site visits to evaluate the control authority oversight procedures and to assess accurate application of categorical pretreatment standards. The PCI can include IU sampling, depending on the reason for the inspection. For example, samples may be collected and analyzed to verify the industrial user's self-monitoring program. Inspectors may prefer to conduct the PCI concurrently with an NPDES inspection of the POTW. For additional information on the steps involved in conducting a PCI, see EPA's *Guidance for Conducting a Pretreatment Compliance Inspection* (EPA, 1991), available at <http://nepis.epa.gov/Exe/ZyPURL.cgi?Dockkey=50000629.txt>.

Noted that a related type of review procedure, the pretreatment audit, is also performed by Approval Authorities. The pretreatment audit is not covered in depth in this manual because it is a program management tool, not an NPDES compliance inspection. The Pretreatment Audit is defined and discussed in the *Control Authority Pretreatment Audit Checklist and Instructions* (EPA, 2010), available at https://www3.epa.gov/npdes/pubs/final_pca_checklist_and_instructions_%20feb2010.pdf.

FOCUSED COMPLIANCE INSPECTION (FCI)

The FCI is an on-site inspection that evaluates compliance for one or more specific portions of a facility (e.g., specific operation or process stream), permit or program (e.g., a pretreatment control authority's oversight of industrial users) to make a compliance determination. A fact-driven analysis determines whether a comprehensive inspection or an FCI is appropriate for the particular facility. Some industries that typically require full process-based inspections may not qualify for an FCI. The scope of an FCI should be informed by the facility's compliance history, information about recent changes in the facility's operation, and other data that indicates a portion of the program or facility that is more likely to have associated compliance issues.

An FCI is more detailed than an RI, but not as comprehensive as a CEI, CSI, DI, or PCI. Although the scope of an FCI is narrower than a CEI, the level of detail required for the portion of the facility, permit or program aspect reviewed should be comparable to the level of detail required for a CEI. An RI, which only requires a preliminary overview of a permittee's compliance program and brief inspection of the facility, does not qualify as an FCI.

FOLLOW-UP INSPECTION (FUI)

The FUI is a resource intensive inspection conducted when a routine inspection or complaint identifies a compliance problem. For an FUI, the appropriate resources are assembled to deal effectively with a specific enforcement problem. A Legal Support Inspection (LSI) is a type of follow-up inspection that is appropriate when an enforcement problem has been identified during a routine inspection or in response to a complaint. An LSI focuses on a collecting information that may be used in an enforcement action. Information gathered during the inspection may be used to determine the appropriate enforcement action.

SEWAGE SLUDGE/BIOSOLIDS INSPECTION

The objective of a Sewage Sludge/Biosolids Inspection is to assess facilities engaged in a regulated sludge or biosolids activity (see 40 CFR Part 503) to evaluate compliance with applicable regulatory provisions, including sludge monitoring, recordkeeping and reporting, treatment operations, sampling and laboratory quality assurance, and use or disposal practices. Sewage Sludge/Biosolids Inspection are on-site activities that may be conducted in conjunction with compliance inspections at major and non-major POTWs. The PCI, CEI, and PAI are the most likely vehicles for evaluating compliance with sludge requirements.

SIGNIFICANT INDUSTRIAL USER (SIU) INSPECTION

The SIU Inspection of an indirect discharger is performed where agencies are acting as the pretreatment control authority pursuant to 40 CFR 403.10 in the absence of a local POTW with an approved pretreatment program, or where EPA or the state is otherwise performing oversight. The SIU Inspection is an on-site activity that includes a close review of the indirect discharge permit and the SIU's compliance, recordkeeping, and reporting since the last inspection. The pretreatment regulations provide that state and local control authorities must conduct sampling inspections of all SIUs at least annually to evaluate compliance with applicable pretreatment standards independent of the IU's self-monitoring reports (see 40 CFR 403.8(f)).

COMBINED SEWER OVERFLOW (CSO) INSPECTION

During a CSO inspection, the inspector conducts an on-site inspection in response to information received regarding a known or suspected overflow event. A CSO inspection evaluates compliance with the CWA and CSO Policy requirements as written in the NPDES permit, an enforcement order, a consent decree, or another enforceable document. The inspector should verify whether the permittee is preventing CSOs during dry weather, implementing the nine minimum controls, adhering to a schedule for development, submission, and implementation of a long-term CSO control plan, eliminating or relocating overflows to sensitive areas, adhering to effluent limitations, implementing a post-construction compliance monitoring program, and complying with the terms of any consent decrees or enforcement orders.

SANITARY SEWER OVERFLOW (SSO) INSPECTION

During an SSO Inspection, the inspector conducts an on-site inspection in response to information received regarding a known or suspected overflow event. An SSO Inspection evaluates compliance with NPDES permit terms and conditions for system design, operation and maintenance, permit reporting requirements, an enforcement order, a consent decree, or another enforceable document. The inspector collects information to verify that the permittee is complying with the NPDES standard permit conditions (duty to mitigate and proper operation and maintenance) and the required notification procedures. The inspector also determines whether there have been any additional unpermitted discharges, or discharges from a location other than the discharge point specified in the permit, to waters of the United States. When preparing for an SSO Inspection, the inspector should consider Office of Enforcement and Compliance Assurance's *Guide for Evaluating Capacity, Management, Operation, and Maintenance (CMOM) Programs at Sanitary Sewer Collection Systems* (EPA, 2005), available at http://www.epa.gov/npdes/pubs/cmom_guide_for_collection_systems.pdf.

STORMWATER INSPECTION

Stormwater inspections at industrial facilities and construction sites are designed to evaluate compliance with NPDES permits for stormwater discharge. A stormwater inspection may also evaluate whether an industrial facility or construction site has obtained NPDES permit coverage if required. Most NPDES permits for construction sites and industrial facilities require the development of a site-specific Stormwater Pollution Prevention Plan (SWPPP) to document how the facility intends to comply with the terms and conditions of the permit, including effluent limits. During the on-site inspection, the inspector reviews the permit and the measures described in the SWPPP to evaluate whether the facility is following its plan for complying with the permit. The inspector also reviews records, such as self-inspection reports, to verify that the facility is complying with its permit and following the SWPPP, and walks the site to verify that the SWPPP is accurate and Best Management Practices (BMPs) are in place and functioning properly.

Construction Stormwater Inspection

Construction site stormwater inspections ensure that regulated facilities have an NPDES permit for stormwater discharge and all relevant controls are implemented and actions are taken at construction sites to prevent pollutants and sediment in stormwater from impacting water quality. The required controls and actions are listed in the permit and typically include required BMPs, documented self-inspections, BMP maintenance, and prohibitions on specific discharges. An inspector must also determine the adequacy of stormwater quality control measures.

Industrial Stormwater Inspection

Industrial facility stormwater inspections ensure that the facility has appropriate NPDES stormwater permit coverage, and that adequate best management practices are utilized at regulated industrial facilities to minimize the discharge of pollutants in stormwater. In general, the inspection will focus on areas related to manufacturing, processing, or raw material storage at an industrial plant. Examples include, but are not limited to, industrial plant yards, material handling sites, refuse sites, shipping and receiving areas, and manufacturing buildings. These

inspections also include evaluation of other permit requirements, such as documented self-inspections, visual monitoring, and sampling.

MUNICIPAL SEPARATE STORM SEWER SYSTEM (MS4) AUDIT

An MS4 Audit is used to evaluate overall MS4 stormwater management program implementation, and identify problems the local government may have in implementing the program. MS4 Audits involve an on-site visit and comprehensive review of the MS4 owner/operators stormwater management program including the legal authority, procedures, implementation of procedures, and adequate resources, where applicable, for the following program elements: (1) structural and source control measures; (2) detection and removal of illicit discharges and improper disposal into storm sewers; (3) monitoring and controlling pollutants in stormwater discharges; (4) implementing and maintaining structural and nonstructural best management practices (BMPs); (5) implementation schedules and assignment of appropriate individuals; (6) the inspection and enforcement program for covered industrial facilities and construction sites; and (7) the dry weather screening program. The auditor should decide whether controls are in place and in good working order, and whether facilities have schedules for construction of structural control measures.

MUNICIPAL SEPARATE STORM SEWER SYSTEM (MS4) INSPECTION

An MS4 Inspection is an on-site inspection that involves reviewing some, but not all, elements of the MS4 stormwater management program to evaluate whether the MS4 is implementing an adequate program in the selected program elements. The program elements would be selected by the region or a state after review of the MS4 permit and other relevant information. See the MS4 Audit description for program elements.

CONCENTRATED ANIMAL FEEDING OPERATION (CAFO) INSPECTION

The objective of this inspection is to evaluate compliance with applicable regulations and permit requirements. To evaluate compliance with requirements and regulations, a CAFO inspection involves review of facility documents and records, such as the facility's permit, nutrient management plan, animal inventory, and all associated records. The on-site inspection also includes assessing the structural integrity, maintenance condition, and storage availability of the facility. For CAFOs that land-apply manure, litter, or process wastewater, the CAFO inspection will include review of in-field and edge-of-field conservation practices, land application protocols and all other factors relevant to determining whether the CAFO has non-agricultural stormwater discharges from land application areas. Where appropriate, CAFO inspections may include sampling of manure, litter, wastewater, and/or soil. A CAFO inspection may also require collection of information necessary to establish whether the receiving water of any CAFO discharge is a water of the United States.

SUMMARY

Compliance personnel should choose the type of inspection to be conducted based on the compliance status of the facility, the information needed from the facility, the type of facility involved, data about the quality of the receiving water, etc. The type of inspection selected will inform what activities will be conducted on-site, such as what additional information the

inspector will gather or verify during the inspection. Where feasible, compliance personnel should perform background and records reviews prior to going on-site to streamline on-site activities and to utilize resources more efficiently. Note that some types of NPDES inspections may encompass several elements from multiple inspection types (e.g., a stormwater inspection may encompass elements from both a CSI and a PAI).

C. LEGAL AUTHORITY FOR NPDES INSPECTIONS

The Federal Water Pollution Control Act of 1956, as amended by the Clean Water Act (CWA) of 1972 and the Water Quality Act of 1987, gives EPA the authority to regulate the discharge of pollutants to waters of the United States. The CWA provides broadly defined authority to establish the NPDES Permit Program, define pollution control technologies, establish effluent limitations, obtain information through reporting and compliance inspections, and take enforcement actions (both civil and criminal) when violations of the CWA occur. Table 1-1 lists applicable NPDES statutes and regulations.

INSPECTION AUTHORITY

Section 301 of the CWA prohibits the discharge of pollutants, unless the discharge complies with, among others, section 402 of the CWA. Under section 402 of the CWA, point source dischargers of pollutants (e.g., municipal wastewater treatment plants, industries, animal feedlots, aquatic animal production facilities, and mining operations) must apply for and receive a permit that sets specific limits and operating conditions to be met by the permittee. To determine whether a person is complying with the prohibition in section 301 of the CWA, section 308 authorizes inspections, monitoring, and information gathering. Relevant to this manual, section 308 of the CWA provides for two types of monitoring:

- Self-monitoring and reporting
- Monitoring by EPA or the state

Accordingly, EPA or authorized states may conduct an inspection, including stormwater, biosolids, combined sewer overflows, sanitary sewer overflows, concentrated animal feeding operations, or pretreatment inspections, to verify compliance with an existing NPDES permit or to determine if discharges are occurring without authorization.

STATE PROGRAM AUTHORITY

Section 402 of the CWA allows EPA to authorize states to administer the NPDES program, including permit issuance, compliance monitoring, and enforcement. EPA retains its enforcement authority, even in authorized states. Federal regulations require EPA and authorized states to enter formal cooperative agreements to ensure timely, accurate monitoring of compliance with permit conditions, among other things. States may implement requirements and regulations that are more stringent or broader in scope than those under the CWA.

Table 1-1. NPDES-Related Statutes and Regulations

Topic	Reference	
	CWA ^a Section	40 CFR ^b Section
Federal NPDES Permit Program	402	122
State Program	510	123
Inspections, Records, and Reports	308	122,123
Technology Standards	304, 306	125
Electronic Reporting of NPDES Information From NPDES-Regulated Facilities	304	127
Toxic Pollutant Effluent Standards	307	129
Water Quality Planning and Management	303, 305	130
Water Quality Standards	303	131
Secondary Treatment Regulations	402	133
Sludge Management	405	257, 501, 503
Pretreatment Standards	307, 402	403
Effluent Guidelines	301, 302	405–471

^a Clean Water Act.

^b Code of Federal Regulations, revised as of July 1, 2012.

D. RESPONSIBILITIES OF THE EPA NPDES INSPECTOR

The primary role of an NPDES inspector is to gather information that can be used to determine the reliability of the permittee's self-monitoring data and evaluate compliance with permit conditions, applicable regulations, and other requirements. The NPDES inspector also plays an important role in case development and support. To fulfill these roles, inspectors are required to know and use policies and procedures for effective inspection and evidence collection, accepted safety practices, and quality assurance standards.

INDIAN COUNTRY INSPECTIONS

Each regional inspector should understand and apply the *EPA Policy for the Administration of Environmental Programs on Indian Reservations* (Indian Policy—EPA, 1984a) and their region's policies and procedures when conducting inspections in Indian country. EPA's Indian Policy is available at <https://www.epa.gov/tribal/epa-policy-administration-environmental-programs-indian-reservations-1984-indian-policy>. States and tribal governments that conduct inspections should follow the requirements outlined in EPA's guidance memorandum entitled *Guidance for Issuing Federal EPA Inspector Credentials to Authorize State/Tribal Governments to Conduct Inspections on Behalf of EPA* (EPA, 2004) available at <https://www.epa.gov/compliance/guidance-issuing-federal-epa-inspector-credentials-authorize-employees-statetribal>.

Inspectors should research applicable policy and procedures when performing inspections in Indian country. If a facility is owned or managed by a tribal government or owned and managed by a private party, EPA generally will notify tribal governments in advance of visiting a reservation and will inform the tribal government of the results of each inspection. If advance notice is not possible due to circumstances beyond the control of the EPA inspector or if the visit involves an unannounced inspection, the tribal government should be contacted as soon as possible. EPA should address out-of-compliance facilities that are in Indian country (and/or owned or managed by a tribal government) in a manner consistent with the Indian Policy and EPA's *Guidance on the Enforcement Principles Outlined in the 1984 Indian Policy*, (EPA, 2001). Enforcement guidance is located at <https://www.epa.gov/enforcement/transmittal-final-guidance-enforcement-principles-outlined-1984-indian-policy-january-17>.

Regions should also be familiar with the American Indian Environmental Office's website www.epa.gov/tribal. EPA Indian program contacts can help identify facilities in Indian country. Their contact information is located at <https://www.epa.gov/tribal/forms/contact-us-about-environmental-protection-indian-country>. Please be aware that while it is often very difficult to identify these facilities, EPA should still follow the applicable guidance concerning working with tribes.

LEGAL RESPONSIBILITIES

Inspectors must conduct all inspection activities within the legal framework established by the CWA, including:

- Presenting proper credentials
- Properly handling confidential business information (CBI)

Inspectors also must be familiar with the conditions of the specific permit, CWA, and regulations.

PROCEDURAL RESPONSIBILITIES

Inspectors must be familiar with general inspection procedures and evidence collection techniques to ensure adequate inspections and to avoid endangering potential legal proceedings on procedural grounds.

INSPECTION PROCEDURES

Inspectors should observe standard procedures for conducting each inspection element. The elements of the inspection process listed in Table 1-2 are common to most NPDES compliance inspections. They are grouped by the major inspection activities:

- Pre-inspection preparation
- Entry
- Opening conference
- Facility inspection
- Closing conference

- Inspection report

Table 1-2. Inspector's Responsibilities

Pre-inspection preparation—Establish purpose and scope of inspection.
<ul style="list-style-type: none"> • Review background information and EPA/state records, including permit and permittee compliance file.
<ul style="list-style-type: none"> • Develop plan for inspection.
<ul style="list-style-type: none"> • Prepare documents and equipment, including appropriate safety equipment.
<ul style="list-style-type: none"> • Coordinate schedule with laboratory if samples are to be collected.
<ul style="list-style-type: none"> • Coordinate schedule with other appropriate regulatory authorities.
<ul style="list-style-type: none"> • Contact party responsible for sample transportation for packing/shipping requirements.
<ul style="list-style-type: none"> • Ensure state/tribe is notified of pending inspection.
Entry—Establish legal entry to facility.
<ul style="list-style-type: none"> • Identify self and present official credentials to the responsible official.
<ul style="list-style-type: none"> • If denied entry, call your supervisor/Office of Regional Counsel.
Opening conference—Orient facility officials to inspection plan.
<ul style="list-style-type: none"> • Discuss inspection objectives and scope.
<ul style="list-style-type: none"> • Establish working relationship with facility officials.
Facility inspection—Document compliance/noncompliance with permit conditions; collect evidence including photographs and copies of records.
<ul style="list-style-type: none"> • Conduct visual inspection of facility.
<ul style="list-style-type: none"> • Review facility records.
<ul style="list-style-type: none"> • Inspect monitoring location, equipment, and operations.
<ul style="list-style-type: none"> • Collect samples, if appropriate.
<ul style="list-style-type: none"> • Review laboratory records for QA/QC and use of approved methods.
<ul style="list-style-type: none"> • For on-site analysis, review laboratory procedures to verify analytical methodology and use of approved methods.
<ul style="list-style-type: none"> • Document inspection activities.
Closing conference—Conclude inspection.
<ul style="list-style-type: none"> • Collect additional or missing information.
<ul style="list-style-type: none"> • Clarify questions with facility officials.
<ul style="list-style-type: none"> • Prepare necessary receipts.
<ul style="list-style-type: none"> • Review inspection findings and inform officials of follow-up procedures.
<ul style="list-style-type: none"> • Issue deficiency notice, if appropriate.
Inspection report—Organize inspection findings in a report with field notes, copies of records, photographs, and other relevant information.
<ul style="list-style-type: none"> • Prepare narrative report, checklists, and documentary information as appropriate.
<ul style="list-style-type: none"> • Enter appropriate data into ICIS, including inspection type data that may be collected on the 3560 Report Form.
<ul style="list-style-type: none"> • Sign and date the report.

Evidence Collection

Inspectors must be familiar with general evidence gathering techniques. Because the government's case in a civil, criminal, or administrative enforcement action depends on the evidence gathered, inspectors must keep detailed records of each inspection. These notes and

documentation will be used for preparing the inspection report, determining the appropriate enforcement response, and giving testimony in an enforcement case.

Inspectors must know how to:

- Substantiate facts with items of evidence, including samples, photographs, document copies, statements from witnesses, and personal observations.
- Evaluate what evidence should be collected (routine inspections).
- Follow chain-of-custody procedures.
- Collect and preserve evidence consistent with Chapter 5, “Sampling.”
- Write clear, objective, and informative inspection reports.

Inspection procedures are discussed in detail in Chapter 2 of this manual.

TRAINING AND CREDENTIALING RESPONSIBILITIES

Training and credential requirements for inspectors are provided in EPA Order 3500.1, *Training Requirements for EPA Personnel Who Are Authorized to Conduct Civil Compliance Inspections/Field Investigations* (Appendix A) and EPA Order 3510, *EPA Federal Credentials for Inspections and Enforcement of Environmental Statutes* (Appendix B). To obtain and maintain inspector credentials, inspectors and their first-line supervisors must certify that the inspector has completed all required training and maintain copies of all required training documentation.

Training

EPA Order 3500.1 establishes consistent EPA-wide training and development programs for employees to conduct environmental compliance inspections/field investigations to ensure that they have working knowledge of regulatory requirements, inspection methodology, and health and safety measures. Those who conduct environmental compliance inspections/field investigations must be properly trained to perform these functions in a legally and technically sound manner. Training required by the Order consists of two parts: Basic Inspector Curriculum and Program-Specific Curriculum (Appendix A). In addition, annual refresher training is required. Inspectors must also complete the required Occupational Health and Safety Curriculum per EPA Order 1440.2 (Appendix C).

Inspector training courses will also be available to federal, state, local, and tribal environmental enforcement personnel, including contractor employees and Senior Environmental Employee enrollees.

Credentialing

EPA Order 3510 addresses roles and responsibilities to issue and manage inspector credentials and letters of authorization, which are provided to employees of EPA, states, tribes, territories, contractors, grantees (e.g., Senior Environmental Employment Program Enrollees (SEE)), and employees of other federal agencies who are authorized by EPA to conduct inspections or investigations and take samples on EPA’s behalf. The order states that credentials are issued to qualified individuals who have met the minimum inspector training requirements outlined in EPA Order 3500.1, health and safety requirements outlined in EPA Order 1440.2, and any

subsequent Orders or Guidelines addressing health and safety requirements. Employee credential holders are responsible for:

- Complying with internal policies for training and background investigation.
- Using credentials only for authorized, official duties.
- Safeguarding their credentials.
- Returning credentials to the Program or Regional Office when they expire or when no longer responsible for conducting EPA inspections.
- Adhering to applicable EPA CBI regulations and program-specific CBI requirements.
- Completing annual refresher training, keeping records of training completion dates, and providing the information to first-line supervisors as required.

SAFETY RESPONSIBILITIES

The inspection of wastewater and other environmental pollution control facilities always poses a certain degree of health and safety risk. To avoid unnecessary risks, the inspector should be familiar with all safety obligations and practices. The safety equipment and procedures required for an inspector will be based on either standard safety procedures or the site-specific information from the facility. Inspectors should do the following:

- Use safety equipment in accordance with available guidance and labeling instructions.
- Maintain safety equipment in good condition and proper working order.
- Dress appropriately for the activity and wear appropriate protective clothing. For example, appropriate protective gloves should be worn during sample collection to protect the inspector and to prevent the potential for sample contamination. Disposable gloves are preferred to assure that no cross contamination occurs between sampling points.
- Use any safety equipment customary in the establishment being inspected (e.g., hard hat or safety glasses).
- Never enter confined spaces unless properly trained, equipped, and permitted (if applicable).

For any safety-related questions not covered in this manual, the inspector should comply with the facility's current approved safety requirements for greater detail if one is available. An inspector should look at Appendix C to locate EPA's Order 1440.2, *Health and Safety Requirements for Employees Engaged in Field Activities*.

PROFESSIONAL RESPONSIBILITIES

Inspectors are expected to perform their duties with the highest degree of professionalism. Procedures and requirements ensuring ethical actions have been established through many years of government inspection experience. The procedures and standards of conduct listed below have evolved for the protection of the individual and EPA, as well as industry.

- All inspections are to be conducted within the framework of the U.S. Constitution and with due regard for individual rights regardless of race, sex, religion, or national origin.
- EPA inspectors are to conduct themselves at all times in accordance with the regulations prescribing employee responsibilities and conduct.
- The facts of an inspection must be noted and reported completely, accurately, and objectively.
- During an inspection, any act or failure to act motivated by private gain is illegal. Actions that could be construed as such should be scrupulously avoided.
- A continuing effort should be made to improve professional knowledge and technical skill in the inspection field.

PROFESSIONAL ATTITUDE

The inspector is a representative of EPA and is often the initial or only contact between EPA and the permittees. In dealing with facility representatives and employees, inspectors must be professional, tactful, courteous, and diplomatic. A firm but responsive attitude will encourage cooperation and initiate good working relations. Inspectors should always speak respectfully of any product, manufacturer, or person.

GIFTS, FAVORS, LUNCHEONS

Inspectors may not accept favors, benefits, or job offers under circumstances that might be construed as influencing the performance of governmental duties. It is prudent to avoid even the appearance of compromising federal ethics statutes and regulations. If offered a bribe, the inspector must not accept money or goods. Since this act may violate federal laws, regulations and may also violate criminal statute, report the incident in detail as soon as possible to a supervisor and the Deputy Ethics Officials. If it appears that a federal criminal statute was violated, report this right away to the EPA's Office of the Inspector General (OIG information is at <https://www.epa.gov/office-inspector-general/forms/contact-office-inspector-general>).

The EPA website on ethics contains extensive information on conflicts of interest, gifts, and luncheons. It is recommended that each inspector go to the Resource Library section and review information in the Conflict of Interest, Gifts, and Travel sections.

Note also that it is prudent for EPA inspectors to decline business luncheons while on EPA business. The inspector must pay his/her own fees for meals. When in doubt about a possible issue, contact a Deputy Ethics Official to clarify what can and cannot be accepted and report any possible infraction of the ethics statutes and rules. See page 20, *U.S. EPA Guidance on Ethics and Conflict of Interest* (EPA, 1984b) and 5 CFR Part 2635, Standards of Ethical Conduct for Employees of the Executive Branch, January 1, 2013.

REQUESTS FOR INFORMATION

EPA seeks to make information concerning EPA and its work freely and equally available to all interested individuals, groups, and organizations. In fact, EPA employees have both a legal and traditional responsibility for making useful educational and safety information available to the

public. This policy, however, does not extend to information about a suspected violation, evidence of possible misconduct, confidential business information, or other information protected from release under the Freedom of Information Act. The disclosure of information is discussed further in Chapter 2, under the “Confidential Information” section.

QUALITY ASSURANCE RESPONSIBILITIES

The inspector must assume primary responsibility for ensuring the quality and accuracy of the compliance inspection and the integrity of samples collected. While other organizational elements play an important role in quality assurance, it is the inspector who must ensure that all data introduced into an inspection file are complete, accurate, and representative of existing conditions. To help the inspector meet this responsibility, Regional Offices have established quality assurance plans that identify individual responsibilities and document detailed procedures, to be used during sampling inspections.

The objective of a quality assurance plan is to establish standards that will guarantee that inspection and analytical data meet the requirements of all users. Many elements of quality assurance plans are incorporated directly into the basic inspection procedures and may not be specifically identified as quality assurance techniques.

The inspector must be aware that following established inspection procedures is critical to the inspection program. These procedures have been developed to reflect the following quality assurance elements:

- Valid data collection
- Approved standard methods
- Control of service, equipment, and supplies
- Standard data handling and reporting

NEXT GENERATION COMPLIANCE

Today’s pollution challenges require a modern approach to compliance, taking advantage of new tools and approaches while strengthening vigorous enforcement of environmental laws. Next Generation Compliance is EPA’s integrated strategy to do that, designed to bring together the best thinking from inside and outside EPA.

Next Generation Compliance consists of five interconnected components (see Exhibit 1-1), each designed to improve the effectiveness of the compliance program:

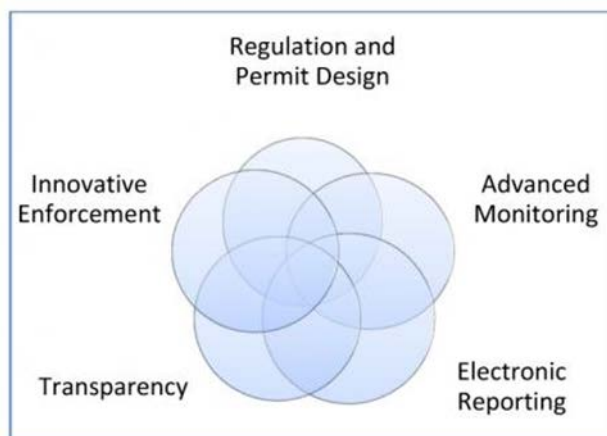

Exhibit 1-1. Next Generation Compliance Components

- Design regulations and permits that are easier to implement, with a goal of improved compliance and environmental outcomes.
- Use and promote advanced emissions/pollutant detection technology so that regulated entities, the government, and the public can more easily see pollutant discharges, environmental conditions, and noncompliance.
- Shift toward electronic reporting to help make environmental reporting more accurate, complete, and efficient while helping EPA and co-regulators better manage information, improve effectiveness and transparency.
- Expand transparency by making information more accessible to the public.
- Develop and use innovative enforcement approaches (e.g., data analytics and targeting) to achieve more widespread compliance.

Electronic Reporting

EPA promulgated the NPDES Electronic Reporting Rule (“final rule”) to modernize CWA reporting for municipalities, industries, and other facilities by converting to an electronic data reporting system (see 80 FR 64064). The final rule requires regulated entities and state and Federal regulators to use existing, available information technology to electronically report data required by the NPDES permit program instead of filing written paper reports. The use of electronic reporting will save time and resources for permittees, states, tribes, territories, and the U.S. Government while increasing data accuracy, improving compliance, and supporting EPA’s goal of better protecting the nation’s waters. This regulation helps provide greater clarity on who is and who is not in compliance, and enhances transparency by providing a timelier, more complete, more accurate, and nationally-consistent set of data about the NPDES program.

Several commenters during the rulemaking questioned how the Electronic Reporting Rule will affect current records retention requirements. Commenters focused on the durational retention requirements, and sought clarification on electronic reporting requirements in the event of system failure. The final rule requires that the electronic reporting tool used to receive electronic submissions comply with the federal Cross-Media Electronic Reporting Regulation (CROMERR) at 40 CFR Part 3. Information that is reported electronically via a CROMERR-approved reporting tool takes the place of the paper record submission. The final rule changes the form of the record from paper-based to electronic. Therefore, records retained pursuant to record retention requirements—regulation-based or permit-based—can be kept in an electronic format so long as they are compliant with the CROMERR requirements. This rule does not change how long records need to be retained under existing regulations or as specified in permits. NPDES inspectors should identify all available electronic records in EPA’s NPDES data system (ICIS-NPDES) such as DMRs or program reports. Inspectors should not assume that the facility has paper copies of records that were previously submitted to their authorized NPDES program (e.g., DMRs or program reports).

Inspection Targeting

Inspectors will now be able to use a more complete and accurate set of NPDES program data to better target facilities. EPA's data access tool, Enforcement and Compliance History Online (ECHO), has a number of tools that inspectors can use to refine their inspection lists and focus on the most important environmental problems.

The ECHO website provides a single place to find up-to-date regulatory compliance and enforcement data. With integrated compliance and enforcement information for more than hundreds of thousands of EPA-regulated facilities nationwide, ECHO's features range from simple to advanced - catering to concerned citizens seeking information about community facilities to those who perform detailed analyses and complex searches.

The site offers a set of search and visualization interfaces, models, management support tools, and reference materials assisting public and government users in accessing and analyzing information related to compliance and enforcement of environmental laws. A password-protected government-only area, ECHO Gov, grants select users access to non-public inspection targeting tools and enforcement-sensitive case information. The next two sections contain examples that NPDES inspectors might find useful for developing inspection lists or for preparation for an inspection. For suggestions for improving ECHO or ECHO Gov, please contact EPA at: <https://echo.epa.gov/resources/general-info/contact-us>.

Inspection Targeting Model Using ECHO Gov

EPA developed the Inspection Targeting Model (ITM) with the goals of sharpening the focus of inspections and making the inspection planning process more efficient and data driven. The purpose of this model is to distinguish between facilities that have strong records of compliance and those who have records indicating historical compliance problems, with additional data providing context regarding water quality. Inspectors will need to log into ECHO Gov to access the ITM (i.e., the ITM is not available to the public).

The ITM scores facilities based on: inspection frequency; violations/SNC status; compliance schedule; enforcement history; water quality; and facility characteristics. Facility-level scores and the underlying data are made available via a simpler user interface on ECHO Gov. The ITM pulls relevant inspection, violation, enforcement, and water quality data, and then applies weightings to each data point to produce a single-number ranked score. The weighting algorithm is designed to indicate which facilities appear to be in most need of an inspection. Exhibit 1-2 shows a screenshot of an example ITM query and Exhibit 1-3 shows a screenshot of the results of this example query.

CWA Inspection Targeting Model Query [Related Tools](#) [Help](#)

State: Designation: Major Minor

Output: ITM Summary Scores Only
 ITM Detailed Scores and ITM Summary Scores
 Values, ITM Detailed Scores, and ITM Summary Scores
 Values Only (Sorting Tool) Remove permittees without sufficient compliance data.

Exhibit 1-2. Example ITM Query

Clean Water Act Inspection Targeting Model Results

188 Records Returned - Search Controls: State = "AL"; Designation = "Major"; Output Mode = "Scores"; Sufficient Compliance Data Only = "No"

[Download a comma delimited text file](#) [Help](#)

Facility Identification Information								Total Score	Inspection Frequency (1)		
Facility Identification	SIC Code	NPDES ID Third Character	Permits Issue Agency	Region Code Within State	Compliance Tracking On?	Complete/Incomplete	Lower Priority?	All Sections	Date since last inspection (CMS) (1a)	Date since any surveillance (1c)	Time since permit expiration (1e)
								Score	Score	Score	Score
CULLMAN WWTP 1437 WELTI ROAD CULLMAN, AL 35056 AL0050423	4952	NPD		04	On	Complete	N	32	0	0	0
HELENA WWTP 590 OLD TOWNE PLACE HELENA, AL 35080 AL0023116	4952	NPD		04	On	Complete	N	25	0	0	0
WRIGHT SMITH JR. WWTP 1879 CONCEPTION STREET ROAD MOBILE, AL 36652 AL0023094	4952	NPD		04	On	Complete	N	24	0	0	0

Exhibit 1-3. Results from Example ITM Query in Exhibit 1-2

Effluent Limit Exceedances Search Using ECHO

The ECHO “Effluent Limit Exceedances Search” provides EPA, states, and the public with an efficient method of identifying and ranking NPDES permittees with violations of their effluent limits (see Exhibit 1-4). The search will identify instances where self-monitoring discharge data (discharge monitoring report (DMR) data) in ICIS-NPDES indicates an exceedance of the NPDES permit effluent limit. Users can search on one or more criteria and then sort the results (see Exhibit 1-5).

Users can also ‘drilldown’ to a facility and see all the effluent exceedances in one report. This facility level report can be printed out onto 8.5” x 11” paper (see Exhibit 1-6). One potential benefit for this new search is to provide users with the ability to quickly and easily create a

report of effluent violations that could be attached as an appendix or supporting material to a letter or enforcement action.

The new search is meant to be easy to use and includes the following features:

- Intuitive searching.
- Searches can be broad (nationwide) or specific (e.g., watershed-based).
- Searches using facility name (useful for investigations of large companies with multiple facilities).
- Searches from NPDES, Facility Registry (FRS), and the Toxic Release Inventory (TRI) will accept multiple IDs in each text box.

Select Year Range (up to 5 years): Start Year: End Year:

1 Location or Watershed

Nationwide

Search by Location

Zip Code:

EPA Region: [View EPA regional map](#)

OR

State:

City:

County:

Search by Watershed

Zip Code:

Watershed ID (2-Digit to 12-Digit HUC):

[Find 12-digit HUC on a map](#)

Major U.S. Watersheds:

Only include facilities that discharge:

to impaired waterbodies

pollutants contributing to a waterbody impairment

to counties or watersheds with ESA-listed aquatic species

2 Pollutant

All Pollutants

Specify Pollutant

Pollutant Name(s) (or partial name(s))

Separate pollutants with a semicolon (/)

Chemical Abstract Service Number (CAS) (without dashes)

Pollutant Categories

With calculated loadings:

- Nitrogen
- Phosphorus
- Organic Enrichment
- Solids
- Metals
- Clean Water Act Priority Pollutants
- CERCLA Hazardous Substances
- TRI Chemicals
- Radionuclides

Without calculated loadings:

- Pathogen Indicators
- Temperature
- Wastewater Flow
- General Radioactivity
- Color
- Whole Effluent Toxicity

Only include facilities with:

Any exceedance Only SNC exceedances

Minimum number of exceedances:

Across entire facility

Any single facility outfall

Only include facilities with specific limit exceedances:

Enter a value for ONE of the options below.

Percent over limit (%) >=

Pounds over limit (lbs) >=

Toxic pounds over limit (TWPE) >=

Limit results based on data quality flags

3 Industry

All Point Sources

Publicly Owned Treatment Works (POTWs) Only

Industrial Point Sources (non-POTW)

Point Source Category:

Industrial Sector ID (2-Digit SIC Code):

OR

Enter a Industrial Sector ID (4-digit SIC Code):

[SIC Code lookup](#)

2-digit NAICS code:

4 Facility

Facility Name:

Separate multiple facility IDs with a comma or carriage return. LIMIT: 400

NPDES Permit ID:

FRS ID:

TRI ID:

Major/Minor indicator:

Compare DMR to TRI feature is only available on data through 2013.

Only include facilities that link to TRI ID(s)

Limit to facilities that:

- Report TRI releases to surface waters
- DO NOT report TRI releases to surface waters

Only include facilities that DO NOT link to TRI ID(s)

Clear selection

Exhibit 1-4. Effluent Limit Exceedances Search Form

Effluent Limit Exceedances Search Results

Instructions. The table below presents facility-level (and if selected, pollutant-level) information about the facilities that match the selected search criteria. Note that if a pollutant or pollutant category is selected in the search criteria, the E90 exceedance counts and pollutant loadings will not reflect total facility exceedances.

Columns in the results table are organized into four themes. The Facility Identifiers theme always remains visible, but the other themes may be toggled on and off. Click on a NPDES ID to access a facility's Effluent Limit Exceedance Exceedances Report. For more information, see [Effluent Limit Exceedances Search Results Help](#).

Search criteria:

Reporting Years 2010 to 2014 and EPA Region: 01 and Pollutant category: Clean Water Act Priority Pollutants and Non-POTWs and All SIC codes and All point source categories

Loads for the current year are not based on a full reporting year because data are not complete.

Displaying: 1 through 42 of 42 facilities.

Show/Hide Columns: Facility Characteristics | Enforcement and Compliance | Pollutant Loadings

Enforcement and Compliance									Pollutant Load				
Most Recent Formal Enforcement Action	E90 Facility Total	E90 Max Outfall	E90 Trend	E90 2010	E90 2011	E90 2012	E90 2013	E90 2014	Total Pounds	Total TWPE (lb-eq)	Total Load Over Limit (lbs)	Total TWPE Over Limit (lb-eq)	2010 Load Over Limit (lbs)
02/22/2012	40	40		1	17	4	14	4	1,710	1,264	75.3	0.75	2.81
11/10/2014	39	39		4	6	13	12	4	379	99.2	0.58	0.36	0.55

Exhibit 1-5. Effluent Limit Exceedances Search Sorting Table

Effluent Limit Exceedances Report [Print](#)

For detailed information on the contents of this report, see [Effluent Limit Exceedances Report Help](#).

SINGATA TECHNOLOGIES, AFFLORD, MA, 02708

<p>Facility Information NPDES ID: MA0021751 FID ID: 11000001071 Other NPDES IDs associated with this FID ID: None SIC Code: 2810000100000000 CWA & TSD ID for this facility's permit page Major Water Pollution Type: Facility Type: Non-POTW Latitude: 41.947221 Longitude: -71.288207 # Days SIC Code 1156 - ROLL, DRAW & EXTRUD NONFERROUS # Days NICS Code</p> <p>Receiving Water Information Waterbody Name (From CWSID): SPEEDWAY TEMPLER COOPERS RD - BRDOL Waterbody Name and Number (EPA Regs): H2B3 Reading River (01000040001) Listed for Impairment?: No Impairment Class: Not provided</p>	<p>Permit Information Permit Status: Permit Issuance: EPA REGION 01 Original Issue Date: 03/14/1977 Last Issue Date: 10/25/2010 Permit Effective Date: 01/01/2011 Permit Expiration Date: 12/31/2018 O&M Signer: Approved Pre-treatment Program?: N/A Conditional Sewer Overflow (CSO) Outfall: N/A</p> <p>Enforcement Information Last Formal Enforcement Action: 02/22/2012 Civil Enforcement Case Number: 01-0012-0008 O&M/CAW Decklet Number: Type Description: CWA 308B AD Per Compliance</p>
--	---

Adjust Date Range: Start Date: 01/01/2010 End Date: 12/31/2014 [Update Report](#)

Total Violation Counts	Number of Violations	Days in Violation	Months in Violation
	51	51	28

Violation Counts by Parameter	Parameter Code	Description	Limit Type	Number of Violations	Days in Violation
	9180	Trichloroethylene	DAILY MX	14	14
	7709	cis-1,2-Dichloroethylene	DAILY MX	11	11
	7839	Trichloroethane	DAILY MX	26	26

Violation Details	Date	Outfall	Parameter	Average Daily Flow (MGD)	Limit Type	DMB Value	Limit Value	% Exceedance	Load Over Limit (lb/period)	Days per Period	Days in Violation
	09/30/2010	002	9180 - Trichloroethylene	0.134	DAILY MX	0.18	0.1	84	2.81	30	1
	01/31/2011	002	9180 - Trichloroethylene	0.201	DAILY MX	0.024	0.005	396	1.029	31	1
	01/31/2011	002	7839 - Trichloroethane	0.201	DAILY MX	0.062	0.005	1142	2.96	31	1

Basic Facility, Permit, Receiving Waterbody, and Enforcement Information

Effluent Exceedances Over Time

Effluent Exceedances by Parameter

Detailed View of Every Effluent Exceedance (can span many pages)

Exhibit 1-6. Effluent Limit Exceedances Search - Facility View

Thus, inspectors can use the results of the Effluent Limit Exceedances Search in ECHO to narrow down facilities that are potential targets for inspection.

E. REFERENCES

The following is a list of resources providing additional information.

U.S. Environmental Protection Agency. (1984a). *EPA Policy for the Administration of Environmental Programs on Indian Reservations*.

U.S. Environmental Protection Agency. (1984b). *U.S. Environmental Protection Agency Guidance on Ethics and Conflict of Interest*.

U.S. Environmental Protection Agency. (1986). *Pretreatment Compliance Inspection and Audit Manual for Approval Authorities*. EPA 833/B-86-100.

U.S. Environmental Protection Agency. (1991). *Guidance for Conducting a Pretreatment Compliance Inspection*. EPA 300/R-92-009.

U.S. Environmental Protection Agency. (2001). *Guidance on the Enforcement Principles Outlined in the 1984 Indian Policy*.

U.S. Environmental Protection Agency. (2003). *Role of the EPA Inspector in Providing Compliance Assistance During Inspections*.

U.S. Environmental Protection Agency. (2005). *Guide for Evaluating Capacity, Management, Operation, and Maintenance (CMOM) Programs at Sanitary Sewer Collection Systems*. EPA 305-B-05-002.

U.S. Environmental Protection Agency. (2004). *Guidance for Issuing Federal EPA Inspector Credentials to Authorize State/Tribal Governments to Conduct Inspections on Behalf of EPA*.

U.S. Environmental Protection Agency. (2010). *Control Authority Pretreatment Audit Checklist and Instructions*. EPA 833-B-10-001.

U.S. Environmental Protection Agency. (2011). *Introduction to the National Pretreatment Program*. EPA 833-B-11-001.

CHAPTER 2 – INSPECTION PROCEDURES

Contents

A. Pre-Inspection Preparation.....	26
Review of Facility Background Information	26
Sources of Facility Background Information	29
Developing an Inspection Plan and/or Checklist.....	30
Developing a Health and Safety Plan	31
Notifying the Facility.....	31
Notifying state of Federal Inspection	32
Preparing Equipment and Supplies	32
B. Off-site Surveillance.....	34
Considerations.....	34
C. Entry	35
Entry Procedures	35
Problems with Entry or Consent	36
Warrants.....	38
D. Opening Conference	38
Considerations.....	38
E. Documentation.....	41
Inspector's Field Notebook.....	41
Samples	42
Interviews and Statements.....	42
Digital Images	44
Video.....	45
GPS	45
Drawings and Maps.....	45
Printed Matter.....	45
Electronic Records.....	45
Copies of Records.....	45
General Considerations.....	47
Confidential Business Information (CBI)	47
F. Closing Conference	50
G. Inspection Report	51
Objective of the NPDES Inspection Report	51
Effectively Communicate and Document Findings in the Inspection Report	52
Elements of a Report.....	54
Integrated Compliance Information System (ICIS).....	55
H. References.....	56

List of Tables

Table 2-1. Inspection Equipment List..... 33

Associated Appendices

- D. EPA’s Memorandum on Practices to Follow and Avoid When Requesting Information
- E. Sample CWA Section 308 Information Collection Request Letter (308 Letter)
- F. Final Fact Sheet: The Do’s and Don’ts of using U.S. EPA Credentials
- G. EPA’s Memorandum on Entry Procedures
- H. EPA’s Policy on the Use of Digital Cameras for Inspections
- I. EPA’s Memorandum on Deficiency Notice Guidance
- J. Inspection Conclusion Data Sheet (ICDS) Form
- K. Draft Guidance for Releasing Civil Inspection Reports

A. PRE-INSPECTION PREPARATION

Pre-planning is necessary to ensure that the inspection is focused and is conducted smoothly and efficiently. It involves the following activities:

- Reviewing facility background information
- Developing an inspection plan
- Developing a Quality Assurance Project Plan (QAPP) for sampling, if applicable
- Notifying the facility, if applicable
- Notifying the state, tribe, or POTW of the federal inspection, if applicable
- Preparing equipment

REVIEW OF FACILITY BACKGROUND INFORMATION

The Clean Water Act (CWA) and related NPDES regulations establish procedures, controls, and other requirements applicable to a facility. In addition, state regulations, and local ordinances may be applicable to the same facility. Therefore, collection and analysis of available background information on the candidate facility is essential for effective planning and overall success of a compliance inspection. Materials from available files, company websites, and other information sources can enable inspectors to familiarize themselves with facility operations, conduct a timely inspection, minimize inconvenience to the facility by not requesting data previously provided, conduct a thorough and efficient inspection, clarify technical and legal issues before entry, and develop a sound and factual inspection report.

Various types of information that may be available for review are listed below. The list is not intended to be exhaustive and all listed information may not be relevant for all inspections. The inspector should determine the amount of background information necessary for the inspection and focus on the characteristics unique to the facility (e.g., design, historical practices, legal requirements).

General Facility Information

- Maps showing facility location, drainage inlets, wastewater discharge pipes, sampling points, overflow and bypass points, and geographic features.
- Plant layout and process flow diagram.
- Names, titles, and telephone numbers of responsible facility officials.
- Any special entry requirements (e.g., security).
- Any safety requirements.
- Description of unit operations including design and operating data (e.g., design flow or capacity, typical operating flows, maintenance requirements), if available.
- Description of wastewater discharges (e.g., outfalls, discharge frequency, flowrate).
- Production levels—past, present, and future.
- Hydrological data.
- Geology/hydro-geology of the area.

- Changes in facility conditions since previous inspection/permit application.
- Available aerial photographs.

Requirements, Regulations, and Limitations

- Copies of existing permits and permit applications. Permits provide information on the limitations, requirements, and restrictions applicable to discharges; compliance schedules; and monitoring, analytical, and reporting requirements. Permit applications provide technical information on facility size, layout, and location of pollutant sources; treatment and control practices; contingency plans and emergency procedures; and pollutant characterization—types, amounts, applicability of effluent guidelines, and points/locations of discharge. Permit applications for air, solid, and hazardous waste treatment and disposal permits may provide additional information to the inspector that is not available elsewhere.
- Notices of intent (NOI), regulations, requirements, and restrictions placed on permittee discharges, including Spill Prevention Control and Countermeasure Plans (SPCC Plans) and Stormwater Pollution Prevention Plans (SWPPPs).
- Monitoring and reporting requirements and available monitoring stations.
- Special exemptions and waivers, if any.
- Documents required by SPCC Plans and SWPPPs, including inventories of Material Safety Data Sheets (MSDS), maintenance records, training manuals, and training documentation.
- Receiving stream water quality standards, the condition of the receiving stream (e.g., is the stream impaired and for what parameters), and any Total Maximum Daily Load (TMDL) evaluations for the receiving stream.
- Information concerning sludge, air, solid, and hazardous waste treatment and disposal.

Facility Compliance and Enforcement History

- Previous inspection reports, including local (municipal), state, and federal inspections.
- Correspondence among facility, local, state, and federal agencies.
- Complaints and reports, follow-up studies, findings, and remedial action.
- Documentation on past compliance violations, exceedances, status of requested regulatory corrective action, if any.
- Enforcement actions such as compliance schedules and consent orders.
- Status of current and pending litigation against facility.
- Self-monitoring data and reports.
- Previous EPA, state, or consultant studies and reports.
- Previous deficiency notices issued to the facility.
- Laboratory capabilities and analytical methods used by the facility.
- Name(s) of contract laboratories, if applicable.

- NPDES data including Discharge Monitoring Reports (DMR) and Quality Assurance (QA) files.
- Emergency Planning and Community Right to Know Act (EPCRA) data submittals.
- Reports from special studies (e.g., stream monitoring, internal audits) or compliance schedules.

Pollution Control and Treatment Systems

- Description and design data for pollution control or treatment systems (e.g., design flow or capacity, typical operating flows, maintenance requirements), if available.
- Sources and characterization of discharge.
- Type and amount of wastes discharged.
- Available routes for bypasses or diversions, and spill containment facilities.
- Pollution control units, treatment methods, and monitoring systems.

Pretreatment Information

- Information concerning compliance schedule to install technologies (industrial facilities) or develop a pretreatment program (Publicly Owned Treatment Works (POTWs)).
- Pretreatment reports as required by the NPDES permit and the General Pretreatment Regulations, regional, state, or local requirements.
- The POTW's Enforcement Response Plan and sewer use ordinance, including local discharge limits.
- POTW pretreatment procedures (e.g., sampling, inspection compliance evaluation, SNC).
- POTW annual reports.
- Information concerning industrial discharges to POTWs, such as:
 - Industrial monitoring and reporting requirements
 - POTW monitoring and inspection program
 - Waste contribution to the POTW
 - Compliance status of industry with pretreatment requirements
 - POTW enforcement initiatives

Chapter 9 of this manual discusses pretreatment program requirements in greater detail.

Municipal Separate Storm Sewer System (MS4)

- Legal authority
- Program procedures
- Reports to permitting authority
- A list of construction and industrial stormwater facilities within the MS4

SOURCES OF FACILITY BACKGROUND INFORMATION

Regional and State Files and Websites

EPA Regional Offices and state agencies maintain files that can provide the information listed below. In addition, many states maintain websites where permits and permit applications may be available.

- Compliance, enforcement, and litigation history including copies of inspection reports and citizen complaints and actions taken. Previous inspection reports can provide general facility information, as well as problems or concerns noted in previous inspections.
- Facility self-monitoring data.
- Quarterly Noncompliance Reports (QNCRs).
- DMR QA reports.
- Permits and permit applications including special exemptions and waivers applied for and granted or denied.
- NOI filings.
- Facility files pursuant to other regulatory programs may also contain useful information prior to the NPDES inspection. Some of the other regulatory programs and their reporting requirements include Toxic Substances Control Act (TSCA) reports on PCB activities; Resource Conservation and Recovery Act (RCRA) biannual reports; Comprehensive Environmental Response, Compensation and Liability Act (CERCLA) reportable quantity release reports; EPCRA Section 312 Tier II reports and Section 313 Form R reports; Federal Insecticide, Fungicide and Rodenticide Act (FIFRA) pesticide production registrations; and Clean Air Act (CAA) annual emission inventory reports and permit applications.
- Other correspondence including process operational problems/solutions; pollution problems/solutions; laboratory capabilities or inabilities; and other proposed or historical remedial actions. This information can provide design and operation data, recommendations for process controls, identification of pollutant sources, treatment/control systems improvement, and remedial measures.

EPA Websites and Information Resources

EPA's website contains several data tools that could be reviewed prior to the inspection:

- DMR Pollutant Loading Tool (<http://cfpub.epa.gov/dmr/>)—This site allows users to determine who is reporting discharges, what pollutants they are discharging and how much, and where they are discharging. The tool calculates pollutant loadings from permit and DMR data from EPA's Integrated Compliance Information System for the National Pollutant Discharge Elimination System (ICIS-NPDES)¹.

¹ ICIS-NPDES has replaced the Permit Compliance System (PCS).

- Electronic Notice of Intent (eNOI) (<https://www.epa.gov/npdes/electronic-notice-intent-enoi>)—This site allows users to view NOIs for construction projects under EPA’s Construction General Permit (CGP) for Low Erosivity Waivers (LEWs) or for industrial facilities seeking coverage under EPA’s Multi-Sector General Permit (MSGP).
- Enforcement and Compliance History Online (ECHO) (<https://echo.epa.gov/>)— This public site allows users to search for facility compliance and enforcement information including permit, inspection, violation, and enforcement actions. ECHO Gov (<https://echo.epa.gov/login>) includes additional data that is available only to government agencies.

Technical Reports, Documents, and References

These information sources provide general information on waste loads and characterization, industrial process operations, and pertinent specific data on available treatment/control techniques, such as their advantages or disadvantages and limits of application and pollutant removal efficiencies. Such sources include Development Documents for Effluent Limitations Guidelines and Standards.

In addition, general websites and mapping programs (e.g., Google Earth, Geographic Information Systems) can provide an overview of the facility layout, features, and outfalls.

Company Data Sources

Many companies maintain individual web sites that contain valuable information regarding the company’s financial status, significant purchases and sales, new business ventures, etc.

Inspectors may follow Appendix D, EPA’s *Memorandum on Practices to Follow and Avoid When Requesting Information*, should requesting information be necessary while conducting background research.

DEVELOPING AN INSPECTION PLAN AND/OR CHECKLIST

Inspection plans and inspection checklists are helpful tools for organizing and conducting compliance inspections. A plan is recommended to effectively conduct a compliance inspection. After reviewing the available background information, the inspector prepares a comprehensive plan to define inspection objectives, tasks and procedures, resources required to fulfill the objectives, and inspection schedule. When developing an inspection plan, inspectors should consider the following:

- Objectives
 - What is the purpose of the inspection?
 - What is to be accomplished?
- Tasks
 - What tasks are to be conducted?
 - What information must be collected?
 - What records will be reviewed?

- Procedures
 - What procedures are to be used?
 - Will the inspection require special procedures?
- Resources
 - What personnel will be required?
 - What equipment will be required?
- Schedule
 - What will be the time requirements and order of inspection activities?
 - What will be the milestones?
- Coordination
 - What coordination with laboratories or other regulatory agencies will be required?

An outline of tentative inspection objectives, meetings to be held, and records that will be reviewed can be prepared and presented to the facility officials during the opening conference.

In addition, inspectors may prepare a checklist to use during the inspection to ensure potential compliance issues have been assessed. The checklist content will vary depending on the type of inspection, but should distill the applicable regulatory and permit requirements into a simple format allowing the inspector to easily assess and document compliance. Existing checklists may be used or modified for the inspection.

DEVELOPING A HEALTH AND SAFETY PLAN

Inspectors must comply with the health and safety training requirements under EPA Order 1440.2 (see Appendix C, (*"EPA Order 1440.2, Health and Safety Requirements for Employees Engaged in Field Activities"*)). Supervisors are responsible for ensuring that these requirements are met. Additionally, a Health and Safety Plan (HASP) must be prepared prior to the inspection or field investigation to determine any health and safety hazards associated with the inspection. When developing a HASP, inspectors and supervisors should consider factors such as the site conditions, weather conditions (when applicable), required personal protective equipment, any personnel medical conditions, and the job functions that will be performed on-site.

NOTIFYING THE FACILITY

Announced Inspections

EPA conducts both announced and unannounced inspections. When conducting announced inspections, the facility operator is sometimes notified by a CWA section 308 Information Collection Request Letter or "308 Letter" that the facility is scheduled for an inspection (Appendix E is an example of a typical 308 Letter). The signature authority for a 308 Letter may be delegated to a section chief, but each region should verify the delegation. The 308 Letter advises the permittee that an inspection is imminent and usually requests information regarding on-site safety regulations to avoid problems concerning safety equipment at the time

of inspection. This letter may request items such as facility contact names and updated process information. The 308 Letter may specify the exact date of inspection, if coordination with the permittee is required. The 308 Letter can also inform the permittee of the right to assert a claim of confidentiality.

In cases where an inspection will be announced, inspectors should:

- Explain the nature and extent of the inspection.
- Provide a timeframe for the scheduled activities.
- Document any contact with the facility (e.g., phone call, letter, email).
- Request the availability of facility personnel and records/documents during the inspection.
- Inquire about special safety and security requirements.
- Inform the facility of its right to assert a confidentiality claim

The inspector should also determine whether there are program-specific forms or requirements that must be completed during the notification process.

Unannounced Inspections

When the facility is not notified in advance, the inspector has an opportunity to observe normal facility operations, rather than a facility that has been prepared for an inspection. However, the inspector may miss interviews with unavailable personnel. The inspector may find that unannounced inspections are valuable when inspecting large or complex facilities. Decisions on whether an inspection will be announced or unannounced should be made in consultation with the inspector's management and, if necessary, counsel. Unannounced inspections are appropriate if there is concern that the facility may conceal or alter evidence of noncompliance, or if the inspection team suspects that illegal discharge(s) may be occurring.

NOTIFYING STATE OF FEDERAL INSPECTION

The inspector should notify the appropriate state regulatory agency, tribe, or POTW in a timely manner of inspections to be conducted in its jurisdiction, if notification is deemed appropriate. Notification should also be provided at the municipal level for delegated programs. The state should be notified of all federal inspections unless disclosing inspection information would jeopardize an unannounced inspection. Applicable agreements and policy should be reviewed regarding this notification. This responsibility may vary depending on the region.

PREPARING EQUIPMENT AND SUPPLIES

The inspector must prepare all equipment and supplies required for the inspection. Safety equipment and procedures required for a facility are based on the response to the 308 Letter or standard safety procedures. Safety requirements must be met, not only for safety reasons, but to ensure that the inspector is not denied entry to the facility or parts of it. If the inspector will use a checklist, it should be developed or obtained during the pre-inspection preparation.

If sampling is to be performed, part of the pre-inspection process may involve preparing sampling equipment and the development of a Quality Assurance Project Plan (QAPP). A QAPP is a tool for planners to document the type and quality of data needed and to describe the methods for collecting and assessing those data. QAPPs are discussed further in Chapter 5, Section B of this manual. Sampling requires additional equipment, which may vary according to the facility inspected and the type of inspection. Table 2-1 includes a list of inspection and field sampling equipment that may be needed.

All equipment must be checked, calibrated, and tested before use. The inspector also must ensure that all materials necessary to complete an inspection are taken to the inspection site.

Table 2-1. Inspection Equipment List

Typical Inspection Equipment	
Documents and Recordkeeping Tools	
<ul style="list-style-type: none"> • Credentials • Background files • Checklists • Bound, waterproof, chemical-resistant logbook 	<ul style="list-style-type: none"> • Shipping labels • Analysis request forms • Waterproof pen • Calculator
Personal Protective Equipment^a	
<ul style="list-style-type: none"> • Hardhat • Hearing protection • Safety shoes • Gloves 	<ul style="list-style-type: none"> • Coveralls • Reflective safety vest (Class III) • Safety glasses/goggles • Rainwear
Safety Equipment^b	
<ul style="list-style-type: none"> • First-aid kit • Meters (oxygen content, explosivity, and toxic gas) • Safety harness and retrieval system • Ventilation equipment 	<ul style="list-style-type: none"> • Respirator • Filter cartridges • Self-contained breathing apparatus (If appropriate)
Tools	
<ul style="list-style-type: none"> • Multi-tooled jack knife (Swiss Army Type) • Electrical and duct tape • Tape measure • Handheld range finder and level • Extra batteries • Extra memory cards for camera, digital camera, video camera • Flashlight 	<ul style="list-style-type: none"> • Screwdriver • Adjustable wrench and vise grips • Bucket (plastic or stainless steel, as appropriate) • Nylon cord • GPS • Laptop computer • Cell phone
Additional Equipment for Sampling	
Sampling Documentation	
<ul style="list-style-type: none"> • Sampling plan 	<ul style="list-style-type: none"> • Sampling QAPP
Sampling Materials	

Table 2-1. Inspection Equipment List

<ul style="list-style-type: none"> • Automatic samplers • Tubing • Sample containers for all potential analytical methods, including extras • Sample bottle labels • Bottle dipper • Decontamination supplies • Batteries/extension cords • Sample bottle labels/sample seals • Plastic security tape 	<ul style="list-style-type: none"> • Chain-of-custody forms • Dissolved oxygen meters • pH meter • TRC meter • pH buffer • Deionized water • Chart paper • Thermometer • Coolers/ice • Preservatives
Sample Transportation Materials	
<ul style="list-style-type: none"> • Bubble pack material • Filament tape 	<ul style="list-style-type: none"> • Airbill/Bill of Lading
Flow Measurement Devices	
<ul style="list-style-type: none"> • Measurement devices (e.g., flumes, weirs, portable ultrasound or bubble systems) • Flow discharge tables 	<ul style="list-style-type: none"> • Ruler • Stopwatch or watch with second hand • level

^a Additional personal protective equipment (PPE) and safety equipment may be required for specific types of inspections.

^b Some of the equipment listed may be used for confined space entry. Only personnel trained in confined space entry should enter confined spaces.

B. OFF-SITE SURVEILLANCE

CONSIDERATIONS

Often many potential concerns can be identified prior to entering the facility, such as illegal discharges, stressed vegetation, spills, smoke, or illegal dumping. Off-site surveillance also provides an opportunity for the inspector to observe traffic patterns into and out of the facility, and determine material/product handling procedures in areas such as loading docks or equipment staging areas. Off-site surveillance also provides the inspector with geographical coordinate information, which can be used to reference photos, locations, violations, etc., and allows the inspector to determine the layout of the facility and make judgments about how to prioritize the inspection.

The inspector should document the following information when conducting off-site surveillance:

1. Location of the off-site surveillance: Was the off-site surveillance conducted from a public right-of-way?
2. Facility layout and orientation: A brief sketch of the layout and orientation (as viewed from the public right-of-way) should be noted.

3. Visible concerns: What are some obvious concerns visible from public right-of-way (e.g., containers, loading areas, tanks, obvious discharges, improper disposal)?

C. ENTRY

ENTRY PROCEDURES

Authority

The authority for entry is found in section 308(a)(4)(B) of the CWA, which states:

...the Administrator or his authorized representative (including an authorized contractor acting as a representative of the Administrator), upon presentation of his credentials (i) shall have a right of entry to, upon, or through any premises in which an effluent source is located or in which any records are required to be maintained...and (ii) may at reasonable times have access to and copy any records, inspect any monitoring equipment or method...and sample any effluents which the owner or operator of such source is required to sample...

In addition, NPDES permits may contain inspection authority provisions.

Arrival

The facility inspection should occur during normal working hours unless information indicates another time would be more appropriate. The inspector should announce him/herself and ask to speak to a facility official. Prior to entering a facility, inspectors should observe it as thoroughly as possible from public right-of-way (e.g., roads, sidewalks).

Credentials

When the proper facility officials have been located, the inspector must introduce himself or herself as an EPA inspector and present the proper EPA credentials. Contractors performing the inspection on EPA's behalf should identify themselves as contractors and present their credentials or authorization letter. Credentials indicate that the holder is a lawful representative of the regulatory agency and is authorized to perform NPDES inspections. The credentials must be presented regardless of whether identification is requested. The inspector should document that credentials were presented.

If the facility officials question the inspector's credentials after the credentials have been reviewed, the officials may telephone the appropriate state or EPA Regional Office for verification of the inspector's identification. Credentials must never be relinquished or allowed to be copied. For more detailed information on the use of EPA Credentials, please refer to the fact sheet "The Do's and Don'ts of Using EPA Credentials" (Appendix F).

Consent

If the inspector is allowed to enter, entry is considered voluntary and consensual.

The receptiveness of facility officials toward inspectors is likely to vary among facilities. Most inspections will proceed without difficulty. In other cases, officials may be reluctant to give entry consent because of misunderstood responsibilities, inconvenience to a facility's schedule,

or other reasons that may be overcome by diplomacy and discussion. If consent to enter is denied, the inspector should follow denial of entry procedures (see Problems with Entry or Consent below).

Whenever there is a difficulty in gaining consent to enter, inspectors should tactfully probe the reasons and work with officials to overcome the problems. Care should be taken, however, to avoid threats of any kind, inflammatory discussions, or deepening of misunderstandings. If the situation is beyond the authority or ability of the inspector, the inspector should leave the facility and contact the supervisor or Office of Regional Counsel for further guidance.

Claims of Confidentiality

The inspector should explain the permittee's right to claim material as confidential business information (CBI). The facility representative should be made aware that the inspector may examine areas related to effluent production or storage even if the permittee has asserted claims of confidentiality. CBI is discussed in greater detail later in this chapter.

Waivers, Releases, and Sign-In Logs

When the facility provides a blank sign-in sheet, log, or visitor register, it is acceptable for inspectors to sign it. However, EPA employees must not sign any type of "waiver" or "visitor release" that would relieve the facility of responsibility for injury or that would limit the rights of EPA to use data obtained from the facility.

If such a waiver or release is presented, the inspectors should politely explain that they cannot sign and request a blank sign-in sheet. If the inspectors are refused entry because they do not sign the release, they should leave and immediately report all pertinent facts to the appropriate supervisor and/or legal staff. All events surrounding the refused entry should be fully documented. Problems should be discussed cordially and professionally.

Less desirable and as a last resort the inspector may cross-out and initial any wording that is unacceptable due to its restrictive nature. The facility must agree with this option.

PROBLEMS WITH ENTRY OR CONSENT

Because a facility may consider an inspection to be an adversarial proceeding, the facility employees may question the legal authority, techniques, and competency of inspectors. Facility officials also may display antagonism toward EPA personnel. In such cases, inspectors should cordially restate the statutory authority that they are inspecting under and seek an explanation for the denial of entry. If entry is still denied, the inspector should leave and obtain further direction from their EPA supervisor or legal staff. Professionalism and politeness must prevail at all times.

Entry Procedures

The following summarizes procedures that EPA developed as a result of the 1978 U.S. Supreme Court decision in *Marshall v. Barlow's, Inc.* Appendix G contains EPA's Memorandum on Entry Procedures, "Conduct Inspections After the Barlow's Decision," in its entirety.

- Ensure that all credentials and notices are presented properly to the facility owner or agent in charge.
- If entry is not granted, ask the reason for the denial to see if obstacles (such as misunderstandings) can be cleared. If resolution is beyond the authority of the inspector, he or she may suggest that the officials seek advice from their attorneys (if they have them) to clarify EPA's inspection authority under section 308 of the CWA.
- Sometimes it can be unclear if entry is being denied. If this is the case, clearly ask if entry is being denied. If entry is still denied, the inspector should withdraw from the premises and contact his or her supervisor or regional counsel. The supervisor will confer with attorneys to discuss the desirability of obtaining an administrative warrant.
- All observations pertaining to the denial are to be carefully noted in the field notebook and inspection report. Include such information as the facility name and exact address, name and title of person(s) approached, name and title of the person(s) who refused entry, date and time of denial, detailed reasons for denial, facility appearance, and any reasonable suspicions of regulatory violations. All such information will be important should a warrant be sought.

Actions to Take if Entry is Denied

If entry is denied, either to the entire facility or parts of the facility, the inspector should:

- Cite the appropriate EPA inspection authority to the company official, ask if he/she understands the reason for your presence, and record the answer and any reason given for entry denial.
- Record the name, title and telephone of the individual denying entry, as well as the date and time.
- Leave the premises.
- Document any site conditions and the events related to the entry denial after leaving the facility and inform your immediate supervisor or regional counsel.

Important Considerations

Inspectors should use discretion and avoid potentially threatening or inflammatory situations. If a threatening confrontation occurs, the inspector should document it and then report it immediately to the supervisor or staff attorney. If feasible, statements from witnesses should be obtained and included in the documentation.

Withdrawal of Consent During Inspection

If the facility representative asks the inspector to leave the premises after the inspection has begun, the inspector should leave as quickly as possible following the procedures discussed previously for denial of entry. All activities and evidence obtained before the withdrawal of

consent are valid. The inspector should ensure that all personal and government equipment is removed from the facility.

WARRANTS

The inspector may be instructed by EPA attorneys, under certain circumstances, to conduct an inspection under search warrant. A warrant is a judicial authorization for appropriate persons to enter specifically described locations to inspect specific functions. A pre-inspection warrant possibly could be obtained where there is reason to believe that entry will be denied when the inspector arrives at the facility or when the inspector anticipates violations that could be hidden during the time required to obtain a search warrant. This would be done only in unusual circumstances.

D. OPENING CONFERENCE

Once credentials have been presented, the inspector can proceed to outline inspection plans with facility officials. At the opening conference, the inspector provides names of the inspectors, the purpose of the inspection, authorities under which the inspection is being conducted, and procedures to be followed. EPA encourages cooperation between the inspectors and the facility officials to facilitate assignments and ensure the success of the inspection.

CONSIDERATIONS

Inspection Objectives

A discussion of inspection objectives will inform facility officials of the purpose and scope of the inspection and may help avoid misunderstandings.

Order of Inspection

A discussion of the order in which the inspection will be conducted will help eliminate wasted time by allowing officials time to make records available and start up intermittent operations.

Meeting Schedules

A schedule of meetings with key personnel will allow facility officials adequate time to spend with the inspector.

List of Records

A list of facility records that will need to be reviewed as part of the inspection should be provided to facility officials (i.e., permits, DMRs, chain-of-custody forms, sampling data, operation and maintenance records, training records, lab data sheets, and other records can be requested depending on the inspections type being performed). This will allow the officials adequate time to gather the records and make them available for the inspector.

Accompaniment

It is important that a facility official accompany the inspector during the inspection (unless the facility is unmanned) not only to answer questions and describe the plant and its principal operating characteristics, but also for safety and liability considerations. Discussion of such

needs with facility officials will provide them the opportunity to allocate personnel for this purpose, however, in some circumstances, the facility official may choose not to accompany the inspector. Even in these situations, the inspector should talk to the personnel responsible for performing sample collection and analysis, or other relevant functions, to gather specific information on these procedures (including required knowledge of responsible personnel).

Permit Verification

The inspector should verify pertinent information included in the permit, such as facility name and address, receiving waters, and discharge points. The inspector should also validate (or obtain) accurate outfall location data (i.e., the precise latitude and longitude of each outfall using a handheld, calibrated GPS unit).

Safety Requirements

The inspector should be prepared with the appropriate safety equipment (e.g., hard hat, safety shoes, safety glasses, safety vest) The inspector should reaffirm which Occupational Safety and Health Administration (OSHA) and other facility safety regulations will be involved in the inspection and should determine whether his safety equipment is adequate.

Split Samples

Facility officials should be informed during the opening conference of their right to receive a split or duplicate of any physical sample collected for laboratory analysis if sufficient sample volume is collected. Officials should indicate at this point their desire to receive split and duplicate samples so that arrangements can be made to secure the samples during inspection. It is the responsibility of the facility to provide its own sample bottles, preservatives, etc.

Photography

Photography is an essential tool used to help the inspector prepare a thorough and accurate inspection report, to present evidence in enforcement proceedings, and to document conditions found at a site. The CWA gives the inspector the authority to collect and copy records including digital images during an inspection. See Section E, "Documentation," for additional information on documenting digital images.

The inspector should work with facility personnel during the opening conference to ensure photography meets the sites requirements. Prior to taking digital images, the inspector should obtain the permittee's approval. The inspector should be tactful in handling any concerns or objections a permittee may have about the use of a camera. In some cases, the inspector may explain to the permittee's representative that wastestreams, receiving waters, and wastewater treatment facilities are public information, not trade secrets. If the facility representative expresses reservations about allowing the inspector to take digital images, these concerns should be discussed to seek a mutually acceptable solution. This can be as simple as agreeing to avoid photographing sensitive items which are irrelevant to the inspection, and/or allowing the representative to view each digital image as it is taken. The facility may also have concerns about the safety of taking photographs in areas where there are explosive vapors and may require equipment be intrinsically safe or may need to issue a "hot work" permit allowing the

use of the camera in certain areas. The inspector should work with the facility personnel to determine areas that may not allow digital cameras.

The facility representative can claim digital images as CBI if they contain confidential information, but inspection photographs should not be deleted except for rare circumstances. An inspection image may be deleted if the image is claimed as CBI and the inspector is not authorized to receive CBI. Additionally, the image may be deleted if it contains CBI that is not relevant to the inspection or if it captures facility staff, and it is against the facility's policy to photograph its employees. In cases where an image is deleted, the inspector should note why it was deleted in the inspection notebook.

If the facility would like to retain copies of digital images taken during the inspection, the inspector should suggest that the facility staff accompany the inspector and take their own digital images of the same areas that the inspector is taking. According to *EPA's Information Security National Rules of Behavior*, to maintain EPA Information Technology (IT) security, an EPA computer, tablet or other electronic device should never be physically connected to a facility computer or device. Additionally, the inspector must only use EPA-authorized internet connections that meet the required security and communication standards to wirelessly transmit digital images. The inspector may provide the facility copies of digital images taken during the inspection upon request via email.

As a general rule, it is considered a denial of entry when a facility imposes any photographic restrictions that limit the inspector from properly performing the inspection. In the event the permittee's representative still refuses to allow digital images, and the inspector believes the images will have a substantial impact on future enforcement proceedings, the inspector's supervisor or regional attorneys should be consulted for further instructions.

Facilities may claim that certain digital images are CBI, in which case the inspector must handle the digital images following all CBI procedures. If there are other circumstances such as national security issues, the inspector should try to collect the evidence needed without taking digital images. The inspector should inform the site representative that he or she will be taking digital images as a routine part of their inspection. If entry is denied, the inspector may photograph areas of the facility exposed to public view, when standing outside the facility.

Small Businesses

The inspector should provide the facility with EPA's "Small Business Resources Information Sheet," where applicable. The information sheet provides resources to help small businesses understand and comply with federal and state environmental laws. EPA's "Small Business Resources Information Sheet" can be found at: <https://www.epa.gov/compliance/small-business-resources-information-sheet>.

Closing Conference

A post-inspection meeting should be scheduled with appropriate officials to provide a final opportunity to gather information, answer questions, present initial observations of deficiencies, and complete administrative duties. The inspector should not make

determinations of compliance or noncompliance while on-site or during the closing conference. Determinations of compliance or noncompliance should be made back at the office in consultation with appropriate management.

New Requirements

The inspector should discuss and answer questions pertaining to any new rules and regulations that might affect the facility. If the inspector is aware of proposed rules that might affect the facility, he or she may wish to encourage facility officials to obtain a copy.

E. DOCUMENTATION

Providing documentation of an inspection is an inspector's basic responsibility. Documentation serves to "freeze" the actual conditions existing at the time of inspection so that evidence can be examined objectively by compliance personnel.

Documentation is a general term referring to all printed information and electronic media produced, copied, or taken by an inspector to provide evidence of suspected violations. Forms of documentation include the field notebook, statements, photographs, videotapes, drawings, maps, printed matter, mechanical recordings, and copies of records.

INSPECTOR'S FIELD NOTEBOOK

The core of all documentation relating to an inspection is the field notebook, which provides accurate and inclusive documentation of all inspection activities. A bound notebook with sequentially numbered pages should be used, and entries should be made in permanent, waterproof ink. A new inspection notebook should be used for each new inspection. Multiple inspections from different facilities should not be kept in a single notebook as they lose their validity if separated from the notebook, such as when one set of notes is needed for the court record. You will lose all notes from other inspections contained in the notebook if inspection notes are subpoenaed.

The notebook will form the basis for written reports and should contain only facts and pertinent observations. Language should be objective, factual, and free of personal feelings or terminology that might prove inappropriate. Cross out and initial any errors in the notebook. The field notebook should never leave the inspector's possession during the inspection. Do not allow a facility to copy the field notebook. Notebooks become an important part of the evidence package and can be admissible in court. The field notebook is a government record and subject to record retention schedules.

Inspection Notes

An inspector may need to testify in an enforcement proceeding. Therefore, it is imperative that each inspector keep detailed records of inspections, investigations, samples collected, and related inspection functions. An inspector should note the date and time of arrivals and departures each day of the inspection and document the sequence of events during each day of the inspection. Types of information that should be entered into the field notebook include the following:

Observations

Record all conditions, practices, and other observations that will be useful in preparing the inspection report or that will validate other types of evidence. For example, weather conditions such as rain/snowfall events prior to and during the inspection are useful and can assist the inspector in determining whether inflow/infiltration is a problem with the facility, or whether stormwater controls were adequate.

Documents and Digital Images

All documents taken or prepared by the inspector such as the completed checklists for the inspection report should be noted and related to specific inspection activities. The inspector should adequately document each digital image so that its content can be properly identified with the site, date, GPS coordinates (if available), photographer name, and description of the digital image. The “Digital Images” section below contains additional documentation information.

Unusual Conditions and Problems

Note and describe unusual conditions and problems in detail.

General Information

List names and titles of all facility personnel contacted during the inspection and the activities they perform. Business cards of facility representatives may be useful. Any statements made by facility personnel during the inspection should be included in the field notebook along with other general information. Information about a facility's recordkeeping procedures may also be useful in later inspections.

SAMPLES

For sample analytical results to be admissible as evidence, a logical and documented connection must be shown between samples taken and analytical results reported. This connection is shown by using a chain-of-custody form that identifies and accompanies a sample between the time it is collected and the time it is analyzed. Sampling techniques and procedures are discussed in Chapter 5, "Sampling."

INTERVIEWS AND STATEMENTS

Inspectors may attempt to obtain a formal statement from a person who has personal, firsthand knowledge of facts pertinent to a potential violation. In most inspections, the majority of information will be collected through informal statements and interviews. The inspector should interview as many of the facility personnel as possible to prepare an accurate description of the facility and its operations. It is useful to talk with people throughout the work area. For informal statements and interviews, attribute assertions to specific facility personnel as much as possible. Do not tape record without the individual's knowledge. When conducting an interview, ask how, what, where, when, and why. Allow adequate time for the personnel to respond.

For interviews, open-ended questions are usually the most useful for gathering information. However, the yes/no, or close-ended questions are also sometimes necessary when the inspector is trying to collect specific information.

The principal objective of obtaining a formal statement is to record in writing, clearly and concisely, relevant factual information. Request the person making the statement sign and date the statement to certify that the document reflects an accurate summary of what they said.

Procedures and Considerations

- Determine the need for a statement. Will it provide useful information? Is the person making the statement qualified to do so by personal knowledge?
- Ascertain all the facts. Make sure all information is factual and firsthand. Record statements that are relevant and that the person can verify in court. Avoid taking statements that cannot be personally verified.
- In preparing a statement, use a simple narrative style with clear, plain stilted language.
 - Narrate the facts in the words of the person making the statement.
 - Use the first-person singular ("I am manager of . . .").
 - Present the facts in chronological order (unless the situation calls for another arrangement).
- Positively identify the person making the statement (name, address, position).
- Show why the person is qualified to make the statement.
- Present the pertinent facts.
- Have the person read the statement and make any necessary corrections before signing. If necessary, read the statement to the person in the presence of a witness.
 - All mistakes that are corrected must be initialed by the person making the statement.
- Ask the person making the statement to write a brief concluding paragraph indicating that he or she read and understood the statement and have that person sign this declarative statement. This safeguard will counter a later claim that the person did not know what he or she was signing.
- If he or she refuses to sign the statement, elicit an acknowledgment that it is true and correct. Ask for a statement in his or her own hand ("I have read this statement and it is true, but I am not signing it because..."). Failing that, declare at the bottom of the statement that the facts were recorded as revealed and that the person read the statement and avowed it to be true. Attempt to have any witness to the statement sign the statement including the witness' name and address.
- Provide a copy of the statement to the signer if requested.

DIGITAL IMAGES

The documentary value of digital images ranks high as admissible evidence. Clear digital images of relevant subjects provide an objective record of conditions at the time of inspection. If possible, keep "sensitive" operations out of the photographed background. To avoid capturing confidential information, the inspector should confer with the permittee to determine if the intended digital image will contain confidential information. If the inspector must take a digital image of an area containing confidential information, the facility representative can claim the image as CBI. Facilities may claim that certain digital images are CBI, in which case the inspector must handle the images following all CBI procedures. Digital images can also be used to collect copies of paper records where photocopiers are not available.

The primary objective of inspection photography is to create an image that accurately documents the inspector's observations and that can be used to testify that the image is a "true and accurate representation of what he or she saw on that date."

Digital cameras offer the advantage of immediate viewing of the image to assure proper composition and exposure. Date and time information is stored with the digital image and should be downloaded and stored with the image. Prior to taking digital images, the inspector should ensure the date and time settings on the camera are accurate. The site, photographer name, GPS coordinates (if available), weather conditions, and a description of the photograph (including compass direction if known (e.g., looking north or facing northwest)) should be recorded in the inspector's field notebook or a separate photograph log. Some digital cameras have built in GPS capability. If the camera does not, a separate GPS unit could be used to record the location. Video cameras and some digital cameras allow information about the digital image to be voice recorded. Refer to Appendix H, "EPA's Policy on the Use of Digital Cameras for Inspections," for EPA guidance on using digital cameras for inspections.

Equipment

Depending on the situation, there are normally three types of digital images that can be taken: 1) the establishing shot, 2) the subject, and 3) the detail shot. The "establishing shot" or wide-angle shot is a digital image taken from a distance that shows the subject in relation to permanent landmarks that can be used for reference in establishing the location of the subject. The "subject" shot emphasizes a specific object or event. The "detail" shot or close-up is typically an area of interest within the subject, such as a nameplate or leaky valve. It may be helpful to include an object of known size for scale reference such as a notebook or pen.

Safety

In areas where there is a danger of explosion, flash images should not be taken. In some situations, where explosive vapors may be present, such as petroleum refineries, hot-work permits, provided by the facility, may be necessary to take digital images. If there is a danger of electrical shock, digital images should be taken from a distance known to be safe. As mentioned previously, inspectors can work with facility personnel during the opening conference to ensure photography meets the sites requirements.

VIDEO

For some inspections, video cameras can be more effective in documenting your findings. Video cameras not only can document motion relative to a violation, but record sound, have extreme zoom capabilities, and can operate in very low light conditions. When recording sound, inspectors must be aware that all comments are recorded.

GPS

GPS units can document the latitude, longitude, and altitude for photographs, samples, or facility unit operations and features. The GPS coordinates can be entered into the field notebook or can be electronically downloaded.

DRAWINGS AND MAPS

Schematic drawings, maps, charts, and other graphic records can be useful supporting documentation. They can provide graphic clarification of site location relative to the overall facility, relative height and size of objects, and other information which, in combination with samples, photographs, and other documentation, can produce an accurate, complete evidence package. Electronic maps of the facility, available through Google Earth, should be obtained prior to the inspection and used to verify any changes that may have occurred since the Google Earth image was taken.

Drawings and maps should be simple and free of extraneous details. Include basic measurements and compass points to provide a scale for interpretation. Identify drawings and maps by source, inspector's initials, and date.

PRINTED MATTER

Brochures, literature, labels, and other printed matter may provide important information regarding a facility's conditions and operations.

Collect these materials as documentation if they are relevant. The inspector should create a receipt of documents and samples taken from the facility, ensuring that all printed matter obtained during the inspection is listed on this receipt.

ELECTRONIC RECORDS

Properly date and sign printouts of electronic records so they can be entered as evidence. Charts, graphs, and other hard copy documents produced from computer output should be treated as printed documentation and handled accordingly.

COPIES OF RECORDS

Facility records should be reviewed to verify the facility properly reports and maintains the required records and to verify permit compliance. The facility may store records in a variety of information retrieval systems, including written or printed materials or electronic format.

Obtaining Copies of Necessary Records

When copies of records are necessary for an inspection report consider, storage and retrieval methods.

Written or printed records generally can be photocopied on-site. Portable photocopier machines may be available to inspectors through the Regional Office. Where possible, inspectors should ask the facilities in advance if copying equipment would be available. When necessary, inspectors can obtain approval from the appropriate EPA authority to pay a facility a "reasonable" price for use of copying equipment. If the facility does not have a photocopier and a portable photocopier is not available, a photocopier machine is usually accessible at a nearby site (e.g., post office, convenience store). However, inspectors must obtain permission from the permittee prior to taking records off-site for copying. Information on some records may also be gathered with a camera.

- At a minimum, all copies made for or by the inspector should be listed in a document receipt, along with any printed matter or samples taken.
- When photocopying is impossible or impractical, close-up photographs or videotape or hand copying could be used.

Computer or electronic records may require the generation of hard copies for inspection purposes. Arrangements should be made during the opening conference, if possible, for these copies. Records could also be transferred electronically to a flash drive or disc. Photographs of computer screens or electronically saved screen shots may provide adequate copies of records if other means do not exist.

Identification Procedures

The records reviewed during an inspection should immediately be adequately identified to ensure the records can be differentiated and tracked throughout the EPA custody process and are admissible in court. When inspectors are called to testify, they must be able to identify each document and state its source and the reason for its collection if asked.

The inspector should log the records taken on the receipt of documents and samples taken from the facility, to be signed by both a facility representative and the inspector. The document receipt should clearly list each item taken with a descriptive title and assign each item a number. Once a facility representative and the inspector sign off on the receipt, the facility should make a copy of this receipt for their records. This receipt can also include other relevant information about what is taken from the facility, such as the number of pages in a document. The document and sample receipt thus provides a valuable reference for what records, copies, samples, etc. were obtained during the inspection.

Logging

Documents obtained during the inspection should be entered in the field notebook by a logging or coding system. The system should include the identifying number, date, and other relevant information:

- The reason for copying the material (i.e., the nature of the suspected violation or discrepancy).
- The source of the record (i.e., type of file, individual who supplied record).
- The manner of collection (i.e., photocopy, other arrangements).

GENERAL CONSIDERATIONS

- Return originals to the proper person or to their correct location.
- Group related records together.
- Handle CBI records according to the special confidential provisions discussed below.

Routine Records

The inspector may find it convenient to make copies of records, such as laboratory analysis sheets and data summaries, to refresh his or her memory when preparing the inspection report. It is not always necessary to follow the formal identification and logging requirements when such records are obtained for general information purposes or to aid in the preparation of routine inspection reports.

CONFIDENTIAL BUSINESS INFORMATION (CBI)

Handling of CBI or Trade Secrets during Inspections

Section 308(b)(2) of the CWA (40 CFR Part 2) protects and defines trade secrets and Confidential Business Information (CBI) from public disclosure. Section 308(a)(4) of the CWA states that an inspector may sample an effluent, request information, have access to the location of the effluent, and inspect any monitoring equipment. The information that is collected is available to the public, unless the information is claimed as CBI. If a permittee does not want inspection information to be available to the public, he or she must request that EPA consider the information confidential.

When conducting compliance inspections, an inspector may have to deal with claims of business confidentiality as authorized under section 308 of the CWA and as defined under 40 CFR Part 2, Subpart B. This section of the statute is designed to protect CBI from unauthorized disclosure. CBI includes information considered to be trade secrets (including chemical identity, processes, or formulation) or commercial or financial information that could damage a company's competitive position if they became publicly known. Inspectors that handle CBI must complete applicable CBI training and be cleared to handle CBI.

Any business being inspected has the right to claim all or any part of the information gathered during that inspection, other than effluent data or publicly available information, as CBI. See section 308(b) of the CWA; 40 CFR 2.302(e) and 2.20. EPA often notifies the business of its right to assert a claim of confidentiality at the time of the 308 letter. Frequently, the 308 Letter is used for this notification. After the business has responded to the 308 letter and, in that response, has asserted whatever claims of business confidentiality for eligible information it intends to make, EPA generally will be aware of any issues related to the handling of the information claimed as CBI.

The affected business may assert a CBI claim at any time, per 40 CFR 2.203(c), unless EPA requires the business to assert all CBI claims at the time of submission of a response to the 308 Letter and failure to do so may result in disclosure without further notice. See 40 CFR 2.203(a). If no such timing requirement is provided in the 308 Letter, the business can make such a claim at the time of the inspection or at any time after the inspection. Any CBI claim must be in writing and signed by a responsible company official. Information claimed as CBI can be later reviewed to determine whether the claim is valid. The CBI claim relates only to the public availability of such data and cannot be used to deny facility access to inspectors performing duties under section 308 of the CWA. Therefore, a business is entitled to assert a CBI claim for all information that an inspector requests or has access to; however, a business may not refuse to release information requested by the inspector under the authority of section 308 of the CWA on the grounds that the information is considered CBI or a trade secret.

While the business is entitled to make a CBI claim on all information that an inspector requests or has access to while on-site (other than effluent data or publicly available information), these CBI claims are subject to review by EPA's Office of General Counsel or Office of Regional Counsel and the business may be asked to substantiate its CBI claims. See 40 CFR 2.204(e). If a CBI claim for certain information is received by EPA after the information itself is received by EPA, EPA will make such efforts as are administratively practicable to associate the late claim with copies of the previously submitted information in EPA's files. See 40 CFR 2.203(c). However, EPA cannot assure that such efforts will be effective, considering the possibility of prior disclosure or widespread prior dissemination of the information.

When a business makes the CBI claim, the Regional Office normally will not determine the validity of that claim until there is a request for the information from a third party, if EPA desires to determine whether the business information is entitled confidential treatment, if it is likely the EPA will be requested to disclose this information, or if EPA believes that the information should be included in the public record in connection with a proceeding. The exact procedures for making and handling CBI determinations are contained in 40 CFR Part 2, Subpart B. Until the EPA makes an adverse determination on the CBI claims, the information is entitled confidential treatment and protected from release.

In some cases, entry to a facility may be denied based on the claim by a permittee that there is CBI at the facility. In such cases, the inspector should recite the relevant subsections of 308 so they are clearly understood by all parties involved. The inspector should then explain the provisions of 40 CFR Part 2, Subpart B, concerning EPA's handling of CBI and information claimed as CBI. For example, the inspector could suggest that the protected material or process be segregated from other non-CBI information or processes. If the facility representative still refuses entry, the inspector should not contest the issue but should treat the matter as denial of entry and immediately notify the appropriate EPA enforcement office for instructions.

Types of Information Excluded from Confidential Treatment

To understand CBI claims, an inspector should know the types of information entitled confidential treatment as defined in 40 CFR Part 2. The regulations specifically exclude certain types of information from confidential treatment. This "public information" includes the NPDES

permit application and all "effluent data" as defined in 40 CFR 2.302(a)(2)(i). According to this definition, effluent data include all information necessary to determine the identity, amount, frequency, concentration, temperature, and other characteristics (to the extent they are related to water quality) of:

- Any pollutant that has been discharged by the source (or any pollutant resulting from any discharge from the source).
- The pollutant which, under an applicable standard or limitation, the source was authorized to discharge (including, to the extent necessary for such purpose, a description of the manner or rate of operation of the source).

Effluent data may also include a general description of the location and/or nature of the source to the extent necessary to distinguish it from other sources (e.g., a description of the device, installation, or operation constituting the source).

Confidentiality Agreements and Nondisclosure

Inspectors, whether EPA, the state, or EPA contractors conducting NPDES compliance inspections, shall not sign any pledge of secrecy or confidentiality agreements or any agreement that would limit the EPA's ability to disclose information received while inspecting a facility or inconsistent with 40 CFR Part 2, Subpart B. See 40 CFR 2.215. Section 308 of the CWA does not specify that a secrecy agreement must be executed as a condition of entry.

Unauthorized disclosure of confidential information by EPA or state employees and authorized contractors is prohibited by law (33 U.S.C. 1318(b) and 18 U.S.C. Part 1905). In addition, all contractor inspectors must sign a statement that they will be personally bound by 40 CFR Part 2, Subpart B, and not disclose trade secrets or CBI.

It is not appropriate for the compliance inspector to determine whether a permittee's CBI claim is appropriate or justified. Once such a claim is made, the information must not be disclosed and must be kept confidential until a determination is made by the appropriate EPA legal office. EPA employees who violate these requirements may be subject to dismissal, suspension, or fines. Criminal action may be taken against EPA employees and authorized contractors or subcontractors who are unauthorized to disclose CBI.

Best Practices for Handling Confidential Business Information

Routine security measures will help ensure that reasonable precautions are taken to prevent unauthorized persons from viewing CBI or information claimed as CBI. When practical circumstances prohibit the inspector from following the procedures exactly, he or she should take steps to protect the information and note those procedures in the field notebook. He or she should mark all information claimed as CBI received as such and place in a locked filing cabinet or a safe immediately after the inspection is completed. Maintain a chain-of-custody record for all CBI and information claimed as CBI. Since CBI and information claimed as CBI requires special handling procedures, it may be useful to keep it in a separate notebook in a secure/locked location. By doing this, only the CBI material, and not the entire notebook of inspection findings, would have to be kept in a locked filing cabinet.

- While traveling. The inspector may be on the road for several days while conducting inspections. The inspector is responsible for ensuring that the information collected is handled securely.
 - Maintain physical possession of the documents. Documents and field notes are considered secure if they are in the physical possession of the inspector and are not visible to others while in use.
 - Keep inspection documents that contain sensitive information in a locked briefcase. If it is impractical to carry the briefcase store the briefcase in a locked area, such as the trunk of a motor vehicle.
 - Place physical samples in locked containers and store in a locked portion of a motor vehicle. The chain-of-custody procedures provide further protection for ensuring the integrity of the sample.
 - CBI should not be stored in checked baggage if travelling by airplane.
- In the office. Each region should develop CBI standard operating procedures. It is useful to indicate who the Regional Administrator, Division Director, Branch Chief or Document Control Officer has authorized to have access to CBI. An access log should be maintained for all transactions. Do not copy information marked "trade secret" and/or "confidential business information" unless there is written authority from the Regional Administrator, Division Director, Branch Chief, or Document Control Officer. Requests for access to CBI or information claimed as CBI by any member of the public, or by an employee of a federal, state, or local agency, must be handled according to the procedures contained in the EPA Freedom of Information Act regulations under 40 CFR Part 2, Subpart B. All such requests should be referred to the responsible regional organizational unit.

F. CLOSING CONFERENCE

To achieve the most effective results from compliance inspections, the inspector should communicate results promptly to the facility management and personnel. The inspector should limit the discussion to preliminary findings of the inspection. If appropriate, the inspector may compare findings with the permittee's NPDES permit requirements, consent decrees, administrative orders, and other enforcement actions. At no time should inspectors state whether any of the observed deficiencies are violations.

Facility officials are usually anxious to discuss the findings of an inspection before the inspector(s) leave. Inspectors should hold a closing meeting or conference for the presentation and discussion of preliminary inspection findings. The closing conference provides an opportunity to describe areas of concern (e.g., unpermitted discharge; parts of a SWPPP missing; routine inspections not being done; silt fence not installed; discharge to a storm drain). During this meeting or conference, inspectors can answer final questions, prepare necessary receipts, provide information about the NPDES program, and request the compilation of data that were not previously available during the inspection. It also presents an opportunity to deliver compliance assistance materials and/or information in accordance with EPA's *National Policy on the Role of the EPA Inspector in Providing Compliance Assistance During Inspections*

(EPA, 2003), available at: <https://www.epa.gov/compliance/policy-role-epa-inspector-providing-compliance-assistance-during-inspections>.

Inspectors should be prepared to discuss follow-up procedures, such as how results of the inspection will be used and what further communications the region, state, tribe, or locality may have with the facility. Inspectors should conduct closing conferences in accordance with any applicable guidelines or standard operating procedures (SOPs) established by the EPA Regional Administrator, State Commissioner, Tribal Official, or Local Director.

The inspector may issue a Deficiency Notice that specifies existing or potential problems in a permittee's self-monitoring program. Issuing a Deficiency Notice on-site or after the site inspection provides a swift and simple method for improving the quality of data from NPDES self-monitoring activities. An example Deficiency Notice and EPA's "Memorandum on Deficiency Notice Guidance" are provided in Appendix I.

G. INSPECTION REPORT

The adequacy of compliance follow-up to correct problems or deficiencies noted during the inspection greatly depends on the report prepared by the inspector. The following sections of this chapter detail procedures for collecting and substantiating the information used to prepare this report. Once collected, however, the inspector should organize and arrange the material so that compliance personnel can make maximum use of the evidence or inspection information. The information presented in this section provides general guidelines for organizing evidence and preparing an inspection report.

OBJECTIVE OF THE NPDES INSPECTION REPORT

The objective of a NPDES inspection report is to organize and coordinate all inspection information and evidence into a comprehensive, usable document. To meet this objective, information in an inspection report must be presented in a clear, well-organized manner. The information should be objective and factual; the report must not speculate on the ultimate result of the inspection findings. Inspectors must avoid using of the term "violation" and should instead use words like finding or deficiency. The following are particularly important:

- Information in the report should be factual and based on sound inspection practices. Observations should be the verifiable result of firsthand knowledge. Compliance personnel must be able to depend on the accuracy of all information.
- Information in an inspection report should be relevant to the subject of the report. Extraneous data that clutters a report and may reduce its clarity and usefulness should not be included in the report. Avoid personal comments and opinions.
- Substantiate suspected deficiency(s) by as much factual information as is feasible to gather. Organize all information pertinent to the subject into a complete package. Documentation (e.g., photographs, statements, sample documentation) accompanying the report should be referenced clearly so that anyone reading the report will get a

complete, clear overview of the situation. The more comprehensive the evidence is, the better and easier to determine compliance or noncompliance.

EFFECTIVELY COMMUNICATE AND DOCUMENT FINDINGS IN THE INSPECTION REPORT

This is especially critical when the findings and observations support that an alleged deficiency has occurred. The following includes examples of how to effectively communicate alleged deficiencies.

1. First, state the requirement in the actual language of the statute, permit, or regulation and then describe and present the evidence that shows how the facility failed to meet the requirement. It can be helpful to repeat the same words used in the statute, permit, or regulation when describing what was observed at the facility. Each alleged deficiency should be made obvious to the reader by thoroughly and clearly describing all documents, photographs, statements, and other evidence in the inspection report. This should include the inspector's own observations. For example:
 - a. **Failure to meet Missouri State Operating Permit (MSOP) conditions.** The Missouri MSOP, MO0023456, issued to the City of Pollutionville, at Section C. Special Conditions, Subsection 6. General Criteria, contains the following requirement: "a) Waters shall be free from substances in sufficient amounts to cause formation of putrescent, unsightly or harmful bottom deposits or prevent full maintenance of beneficial uses." On January 5, 2002, at the WWTP's outfall 32 (see map—attachment 3), I observed the receiving water body, Greenfoot Stream, to have approximately 4–5 inches of sludge deposit on the bottom 9 inches (see photos #10–14, approximation of depth made with 12" ruler) as well as a blood worm population (photos #15–16, estimate of blood worm population based on counting the number of blood worms per square foot of water surface to a depth of about 1 foot). Greenfoot Stream is on the Missouri 303(d) list for nutrient content. Mr. Smith, the plant operator, signed a statement that the plant had been losing solids to the stream for four months due to an increased organic load from Acme Meat Packing Co. (see attachment 5) ...
 - b. **Failure to properly operate and maintain treatment system; failure to meet the TSS daily maximum limit.** Part IV.B.3 of the EPA Region 8 NPDES Permit, WY0112233, (the permit) states, "The permittee shall at all times properly operate and maintain all facilities and systems of treatment and control (and related appurtenances) which are installed or used by the permittee to achieve compliance with the conditions of this permit." During the inspection, I observed that the secondary clarifier was not operating. Mr. Helpful, the superintendent, stated that the secondary clarifier had been offline for the past month until money for a new drive unit could be procured, and the old drive unit became jammed and no longer works. Based on sampling records I reviewed at the facility, the facility effluent has exceeded the daily maximum total suspended solids limit of 45 mg/L listed in Part II.B.1 of the permit on March 23, 2014 (190 mg/L); March 31, 2014 (104 mg/L); April 6, 2014 (188 mg/L); and April 11, 2014 (154 mg/L).

Use a separate, indented paragraph to highlight each alleged deficiency along with an obvious font change.

Each inspector should use the following techniques to ensure a well-documented inspection report:

1. Write the report as soon as possible upon return from the field. As noted earlier, excessive delays or reports not written “near-in-time” to the inspection can compromise EPA’s ability to conduct timely enforcement.
2. Write the report in the active voice and in a “compare and contrast” style. Each alleged deficiency identified should be stated in a manner where the facts are presented and then compared, against the statute, permit or regulatory requirement.
3. Use simple, direct language, short sentences and paragraphs, and avoid repetition.
4. Identify, by name and relationship to the facility, who said what and when.
5. Clearly identify all alleged deficiencies observed during the inspection or evaluated prior to the report write-up.
6. Reference the applicable statute, permit, or regulation for each alleged deficiency identified. If the inspection is conducted in a state that is authorized to implement the regulation, then the applicable state law or regulation should be referenced.
7. Provide a complete and detailed description of all materials (e.g., all photographs, maps, diagrams) gathered to support the potential violation.
8. Identify, number, and reference all attachments in the text of the field report.
9. Use consistent word choice; e.g., if a particular device is called a “Waste-o-matic,” use the term “Waste-o-matic” throughout the report to describe that device.
10. Do not use negative inferences. For example, avoid saying “...the only drums found were...,” which is not first person and implies that no other drums were at the facility. Simply state what was observed; e.g., “During the inspection, I observed five drums which were...”
11. Do not use vague and ambiguous terms or statements. For example, avoid using words like indicated, implied, suggested, several, many, some, or it was determined.
12. Do not use absolute terms like all, always, or every, unless the findings and observations have been fully verified and documented. Be as precise and accurate as possible.
13. Do not repeat or use information obtained from previous inspection reports that was not verified during the inspection unless the purpose of stating previous alleged violations is to establish that there is a pattern of the same alleged violations.
14. Describe all actions (including timeframes) that the facility said they would complete as a result of the inspection.

ELEMENTS OF A REPORT

Although specific information requirements for an inspection report will vary, most reports will contain the same basic elements:

- Supplementary narrative information
- Copies of completed checklists
- Documentation
- Inspection Conclusion Data Sheet (if required by the regional office Standard Operating Procedures)

Supplementary Narrative Information

Supplementary narrative information could be a memorandum in the case of routine inspections or a narrative report when major violations are detected. When a narrative report is necessary to fully describe a compliance inspection, the contents of the report should focus on supporting or explaining the information provided.

The narrative report should be a concise, factual summary of observations and activities, organized logically and legibly, and supported by specific references to accompanying documentation.

Basic steps in writing the narrative report include the following:

- **Reviewing the information**
 - The first step in preparing the narrative is to collect all information gathered during the inspection. Review the inspector's field notebook in detail. Review all evidence for relevance and completeness. A telephone call or, in unusual circumstances, a follow-up visit may be needed to obtain additional or supplementary information. Record any phone call relating to the inspection in the inspector's logbook with date and time.
- **Organizing the material**
 - Organize the information according to need, present it logically and comprehensively. Organize the narrative so that it is easily understood.
- **Referencing accompanying material**
 - Reference all documentation accompanying a narrative report clearly so that the reader will be able to easily locate the items. The "Documentation" section in this chapter provides details on document identification. The inspector should check all documentation for clarity before writing the report.
- **Writing the narrative report**
 - Once the material is reviewed, organized, and referenced the narrative can be written. The purpose of the narrative is to factually record the procedures used in, and findings resulting from, the evidence-gathering process. The inspector should refer to routine procedures and practices used during the inspection, but should

detail facts relating to potential violations and discrepancies. The field notebook is a guide for preparing the narrative report.

- If the inspector has followed the steps presented in this manual, the report will develop logically from the organizational framework of the inspection. In preparing the narrative, the inspector should strive to use plain and simple language and always proofread the narrative carefully.
- **Copies of completed checklists**
 - Refer to comprehensive checklists in the technical chapters of this manual and in the appendices. When appropriate, use these checklists to collect information during the inspection, the region may modify these to specific concerns. Include copies of all completed checklists in the inspection report.
- **Documentation**
 - Include or reference all documentation produced or collected by the inspector to provide evidence of suspected violations in the inspection report. The “Documentation” section in this chapter provides details on obtaining and organizing this material.

INTEGRATED COMPLIANCE INFORMATION SYSTEM (ICIS)

The inspection office should ensure that all required data are entered into ICIS, which is used for national tracking of NPDES permit information. EPA does not credit the inspection until it is coded/entered into ICIS. Therefore, timely completion of reports and data entry into ICIS is essential as part of the compliance inspection follow-up. Make every effort to ensure that data are entered no later than 30 days after the inspection is completed.

Integrated Compliance Information System (ICIS)

ICIS supports the information needs of the National Enforcement and Compliance program as well as the unique needs of the NPDES program. ICIS integrates data that is currently located in more than a dozen separate data systems. The web-based system enables individuals from states, communities, facilities, and EPA to access integrated enforcement and compliance data from any desktop connected to the Internet. EPA's ability to target the most critical environmental problems will improve as the system integrates data from all media.

ICIS features include:

- Desktop access
- Internet access
- Integrated data
- Real-time entry and retrieval of data
- Powerful reporting capabilities
- User-friendliness

Inspection Conclusion Data Sheet (ICDS)

In FY 2002, EPA began collecting information on EPA NPDES compliance inspection outcomes using a manual ICDS form. In FY 2003, the Office of Enforcement and Compliance Assurance (OECA) launched ICIS to electronically capture compliance and enforcement information, including ICDS data. Regions have the option of submitting ICDS information by submitting summary information at mid-year and end-of-year to EPA Headquarters similar to other manually reported information or entering the ICDS data directly into ICIS. Regions must decide whether EPA inspectors or central data entry personnel will be responsible for entering the data into ICIS. If EPA inspectors enter the data, no manual ICDS form will be needed since the information to fill out the form should be included in the inspector's notes. If central data entry personnel enter the data, EPA inspectors should complete the manual ICDS form and forward it to their first-line supervisor for review prior to data entry into ICIS. The ICDS form is included in Appendix J.

H. REFERENCES

Suarez, J.P. (2003). *Role of the EPA Inspector in Providing Compliance Assistance During Inspections*. U.S. Environmental Protection Agency Memorandum, Final National Policy.

CHAPTER 3 – DOCUMENTATION/RECORDKEEPING AND REPORTING

Contents

A. Inspection Authority and Objectives	58
Authority and Objectives.....	58
B. Evaluation Procedures	59
Verification, Recordkeeping, and Reporting Evaluation Procedures	59
Compliance Schedule Status Review.....	62
POTW Pretreatment Requirements Review.....	63
In-depth Investigations.....	64
C. Verification, Recordkeeping, and Reporting Evaluation Checklist	65

Associated Appendices

- L. Sample Discharge Monitoring Report Form

A. INSPECTION AUTHORITY AND OBJECTIVES

AUTHORITY AND OBJECTIVES

Statutory Recordkeeping Authority:	Clean Water Act (CWA) Sections 308 and 402
Regulatory Requirements:	Title 40 Code of Federal Regulations (CFR) Parts 122, 136, 401, 403, 405–471, and 503, as applicable
Inspection Authority:	CWA Section 308

The National Pollutant Discharge Elimination System (NPDES) permit system requires facilities to maintain records and report periodically on the quantity and type of discharged effluent. The permit stipulates recordkeeping and reporting conditions. Evaluations are conducted at selected permitted facilities to determine compliance with permit requirements. The procedures listed below should be used for these routine inspections. If suspected violations are disclosed during the routine evaluation, a more intensive investigation should be conducted.

A review of facility records should determine that recordkeeping requirements are being met. In particular, the following questions should be answered:

- Is facility verifying data being collected as required by the permit?
- Is all required information available?
- Is the information current?
- Is the information being maintained for the required time period?
- Do the records reviewed indicate areas needing further investigation?
- Do the records show compliance?
- Are the records certified?

During the site inspection, the inspector does not have the authority to require the following:

- A specific organizational method for the facility records.
- Facility copies of the records or access to a copier. The inspector should be prepared to make their own copies with a portable scanner/printer or plan to copy the records at a professional copier.

B. EVALUATION PROCEDURES

VERIFICATION, RECORDKEEPING, AND REPORTING EVALUATION PROCEDURES

During the inspection

During the facility site inspection, the inspector should verify the following requirements of the permit:

- The number and location of discharges are as described in the permit.
- All discharges, if permitted, are in accordance with the general provisions of the permit, such as no noxious odors, no visible entrained solids in discharge, no deposits at or downstream of the outfall, no color change in the receiving stream, and no fish or vegetation kills near the outfalls.

The inspector should review the permit to determine recordkeeping and reporting requirements. Throughout the inspection, the inspector should compare facility's operations with the permit to verify that required permit activities are correct, current, and complete. Obtain some of the information needed to verify the permit during the opening conference and compare with the facility permit. This information includes the following:

- Correct name and address of facility
- Correct name and location of receiving waters
- Number and location of discharge points (if any)
- Principal products and production rates (where appropriate)

The inspector should check for records that will verify that notification has been made to the Environmental Protection Agency (EPA) or to the state when: 1) discharges differ from those stated in the permit, 2) a discharge violates the permit, and 3) a bypass has occurred. The inspector should also check to ensure that the facility maintains the appropriate records for a minimum of three years (or five years for sewage sludge). These records may include the following:

- Sampling and analysis data:
 - Dates, times, and locations of sampling
 - Sample types collected
 - Analytical methods and techniques
 - Results of analyses
 - Dates and times of analyses
 - Name(s) of analytical and sampling personnel

- Monitoring records:
 - Discharge Monitoring Reports (DMRs), including information on flow, pH, Dissolved Oxygen (DO), etc., as required by permit. A blank DMR form is included in Appendix L.
 - Original charts from continuous monitoring instrumentation.
 - Verification of the validity of the data on the DMRs. An inspector can perform this verification by tracking the raw data from the laboratory bench sheets or other databases to the final reported DMR entries.
- Laboratory records:
 - Calibration and maintenance of equipment
 - Calculations (i.e., on bench sheets or books)
 - Quality assurance/quality control (QA/QC) analysis data
 - Laboratory standard operating procedures (SOPs)
 - Results of DMR QA studies
- Facility operating records:
 - Daily operating log.
 - Summary of all laboratory tests run and other required measurements, including reference test method used (Inspectors should reference the most recent version of the Standard Methods or 40 CFR Part 136 methods for test procedures).
 - Chemicals used (pounds of chlorine per day, etc.).
 - Weather conditions (temperature, precipitation, etc.).
 - Equipment maintenance completed and scheduled.
 - Equipment downtime and failures.
 - Spare parts inventory.
 - Monitoring equipment calibration records.
- Treatment plant records (required under the Federal Construction Grants program):
 - Plant Operations and Maintenance (O&M) Manual
 - Percent removal records
 - "As built" engineering drawings
 - Copy of construction specifications
 - Equipment supplier manual
 - Data cards (i.e., maintenance records) on all equipment
- Management records:
 - Average monthly operating records
 - Annual reports
 - Emergency conditions (power failures, bypass, upsets, chlorine failure reports, etc.)

- Pretreatment records:
 - Publicly Owned Treatment Works (POTW) and industrial monitoring and reporting requirements.
 - Industrial user discharge data.
 - Compliance status records (IU inspection reports, SNC evaluations, POTW sampling information, etc.).
 - POTW enforcement initiatives and Enforcement Response Plan.
 - POTW procedures listed in 40 CFR 403.8(f)(2).
 - Industrial waste survey information.
- Risk Management Plan (RMP)
- Stormwater Pollution Prevention Plan (SWPPP)
- Self-inspection records
- Spill Prevention Control and Countermeasure (SPCC) Plan

When required, a properly completed RMP, SWPPP, and/or SPCC Plan should be available. The inspector also may gather information on the SPCC and forward this information to the appropriate program office for follow-up action plans.

- Best Management Practices (BMPs) (where required).
- Two types of BMP plans are included in NPDES permits:
 - BMP plans to minimize or prevent release of significant amounts of any toxic or hazardous pollutants to public waters. The plans may discuss general operations and maintenance of the plant, good housekeeping procedures on the facility grounds, and other plans and procedures specific to best management of the facility.
 - Site-specific BMP plans to address particular toxic or hazardous chemicals or other conditions particular to the facility. Site-specific BMP may include procedures, monitoring requirements, construction of barriers such as dikes and berms, or other appropriate measures for solving specific problems.

In addition, inspectors should ensure that sludge records to verify compliance with 40 CFR Part 503 are maintained for a minimum of five years. The facility needs to keep records to be reviewed (such as sludge records and laboratory records) on-site for the inspector.

The inspector should document all inspection activities (see Chapter 2, Section E). Inadequacies, discrepancies, or other problems disclosed during this review may warrant more intensive investigation.

The inspector should validate (or obtain) accurate outfall locational data during the inspection. Locational data includes the precise latitude and longitude of each outfall (including metadata such as source, datum, precision, etc.). EPA collects this information as part of the EPA permit applications for inclusion in ICIS-NPDES. Locational data are becoming increasingly critical for

Agency-wide geospatial applications, including everything from mapping to prioritizing enforcement and permitting efforts.

COMPLIANCE SCHEDULE STATUS REVIEW

If the permit contains a compliance schedule or if the facility is under an enforcement action with a compliance schedule, the inspector should determine:

- Whether the permittee is conforming to the compliance schedule and, if not, whether final requirements will be achieved on time.
- The accuracy of reports relating to compliance schedules.
- The length of delay associated with a construction violation.
- Whether any schedule violations are beyond the control of the discharger.
- Whether requests for permit modifications are valid.

If the permit contains a compliance schedule, only review the schedule in detail if the need becomes apparent during records review and preparation of the inspection plan. Actions to review should include beginning new construction, contract and equipment orders, authorization and financing arrangements, and/or attainment of operational status. The specific compliance schedule actions are described below.

Construction Progress

The inspector must know whether contracts for labor and material have been fulfilled and whether the permittee or the permittee's engineering consultant is monitoring progress. These aspects are extremely important, particularly in plants where numerous contracts are likely for labor and equipment.

If the permittee or the engineering consultant reports that construction or acquisition of equipment is behind schedule, the inspector should:

- Ask to see the permittee's or the resident engineer's progress report and determine whether the report indicates that the final compliance schedule required by the permit can be met.
- If the report indicates that the final date will not be met, advise the permittee that the compliance schedule of the NPDES permit requires the permittee to notify the permit-issuing authority promptly of any possible delay in achieving compliance and of measures taken to minimize the delay.
- Inquire whether the facility superintendent or chief operator and operating personnel are receiving adequate training concerning the operational aspects of the new treatment unit while construction is under way. They must be prepared to perform the essential operating functions when the facility is placed in service.

Construction Contracts and Equipment Orders

The inspector should review the appropriate documents to determine whether the permittee has obtained the necessary approval to begin construction. The inspector should note the start and completion dates (or scheduled delivery dates in service or equipment contracts).

Authorization and Financing

If construction is incomplete, the inspector should determine whether the permittee has the authority and financial capability (mortgage commitments, corporate resolution, etc.) to complete the required structures.

Attainment of Operational Status

If construction has been completed but the facility is not yet operational, the inspector should determine whether the facility is using appropriate procedures to ensure attainment of working status at the earliest possible time. The inspector should verify the following:

- Appropriate self-monitoring procedures that the facility has initiated. It is especially important that the result of operational and effluent quality monitoring be reviewed to determine whether progress is being made toward optimum efficiency in each treatment unit and in the entire plant.
- Appropriate recordkeeping procedures.
- Appropriate work schedules and assignments. (For municipal facilities, the O&M Manual should provide essential guidance.)

POTW PRETREATMENT REQUIREMENTS REVIEW

The inspector must collect specific information to evaluate compliance with pretreatment requirements. A summary of inspector procedures for this review is provided below and for more detail see Chapter 9, "Pretreatment."

As part of the inspection, the inspector must collect information about the POTW's compliance with its approved pretreatment program and applicable regulations, as well as the compliance status of its industrial users (IUs) with categorical pretreatment standards or locally developed discharge limitations. POTW's that do not have an approved pretreatment programs should have pretreatment requirements in its permit, such as the requirement to notify the permitting authority of new significant industrial users in its service area or requirements to prevent pass-through and interference. The inspector should review POTW records to determine the following:

- Whether all the contributing industries, including the number of significant industrial users (SIUs) are accounted.
- Whether all IUs are properly identified and classified.
- Whether IUs have submitted required reports and notifications to the POTW. These include baseline monitoring reports (BMRs), compliance schedule progress reports, 90-day compliance reports, periodic compliance reports, notifications of changed

discharge, potential problem discharges, violation and resampling, and hazardous waste discharge.

- Whether all the contributing IUs are in compliance with applicable standards, such as categorical pretreatment standards, local limits, general and specific prohibitions, etc.
- Whether permits containing all required elements have been issued to significant IUs in a timely manner.
- Whether inspections and sampling (including evaluation of the need for slug control plans) of SIUs are conducted at the required frequency.
- Whether the POTW has notified all affected IUs of classification and applicable standards and requirements, including Resource Conservation and Recovery Act (RCRA) obligations.
- Whether appropriate enforcement actions have been taken against all noncompliant IUs in accordance with the POTW's Enforcement Response Plan and whether the names of all IUs in significant noncompliance are published at least annually.
- Whether contributing IUs with compliance schedules are meeting applicable schedule deadlines and compliance schedule reporting requirements.

IN-DEPTH INVESTIGATIONS

The inspector should conduct an in-depth inspection of a permittee's records and reports to substantiate a suspected violation; to verify self-monitoring data to use as corroborative evidence in an enforcement action; or to confirm apparent sampling, analysis, or reporting discrepancies discovered during the limited inspection. For example, discrepancies warrant an in-depth review if the inspector:

- Suspects the discharge does not meet required standards and no definite operational problems have been established.
- Suspects grossly inaccurate self-reporting data with recordkeeping procedures and/or the filing of reports.
- Suspects the cursory review indicates omissions or laxity in the preparation of records.
- Suspects evidence of falsification of records
- Suspects laboratory review of analytical data indicates errors in QC or data management.

Confer with supervisor for more guidance and assistance as needed in performing an in-depth investigation.

In-depth Investigation Procedures

The following procedures should guide the inspector in conducting an in-depth investigation:

- Determine investigation objective. What is the specific purpose of the investigation?
- Determine information needed. What specific data will substantiate a violation or respond to the investigation objective?

- Determine data source. What records will contain these required data?
- Review inspection authority. Authority to inspect under section 308 is limited to those records required by the permit/regulations.
- Inspect direct and indirect data sources. Examine records likely to provide the required data directly. In the absence of direct data, use indirect sources of information to develop a network of information relevant to the data being sought.
- Take statements from qualified facility personnel. See Chapter 2, Section E, for specific procedures.
- Prepare documentation. Copy and identify all records relevant to the information being sought. See Chapter 2, Section E, for specific procedures.
- Follow confidentiality procedures. Any record inspected may be claimed by the facility as confidential. Treat such records in accordance with EPA procedures. See the discussion on Confidential Business Information in Chapter 2, Section E.

C. VERIFICATION, RECORDKEEPING, AND REPORTING EVALUATION CHECKLIST

This section provides an example of the type of checklist inspectors should use during inspections. The checklist should capture facility information and whether permit conditions are being met, as well as provide documentation for each suspected violation. The purpose of such a checklist is to concisely and thoroughly keep track of all the necessary information. Additionally, when required by regulations, inspectors should ensure records are certified.

A. PERMIT VERIFICATION			
Facility Name and Mailing Address:			
Brief Facility Description:			
Permit Number and Facility Representative:			
Inspection Date and Time, Inspector Names:			
Yes	No	N/A	1. Inspection observations verify information contained in permit.
Yes	No	N/A	2. Current copy of permit is on-site.
Yes	No	N/A	3. Name and mailing address of permittee are correct.
Yes	No	N/A	4. Records accurately identify name and location of receiving waters.
Yes	No	N/A	5. Number and location of discharge points are as described in permit.
Yes	No	N/A	6. All discharges are permitted.
Yes	No	N/A	7. Facility is as described in permit.

Yes	No	N/A	8. Notification was given to EPA/state of new, different, or increased discharges.
Yes	No	N/A	9. Facility maintains accurate records of influent volume, when appropriate.
Yes	No	N/A	10. The facility used Federal Construction Grant funds to build the plant.
B. RECORDKEEPING AND REPORTING EVALUATION			
Yes	No	N/A	1. Maintain records and reports as required by permit.
Yes	No	N/A	2. All required information is available, complete, and current.
Yes	No	N/A	3. Information is maintained for three years (or five years for sewage sludge).
Yes	No	N/A	4. If the facility monitors more frequently than required by permit (using approved methods), these are results reported.
			5. Analytical results are consistent with data reported on DMRs:
Yes	No	N/A	a. The data is transcribed accurately from the bench sheets to the DMRs.
Yes	No	N/A	b. The calculations are performed properly (including loading, averages, etc.).
			6. Sampling and analyses data include:
Yes	No	N/A	a. Dates, times, and location of sampling.
Yes	No	N/A	b. Sample types collected.
Yes	No	N/A	c. Instantaneous flow at grab sample stations.
Yes	No	N/A	d. Name of individual performing sampling.
Yes	No	N/A	e. Analytical methods and techniques.
Yes	No	N/A	f. Results of analyses and calibration.
Yes	No	N/A	g. Dates and times of analyses.
Yes	No	N/A	h. Name of person performing analyses.
			7. Monitoring records include:
Yes	No	N/A	a. Flow, pH, DO, etc., as required by permit.
Yes	No	N/A	b. Monitoring charts maintained for three years (or five years for sewage sludge).
Yes	No	N/A	c. Flowmeter calibration records maintained.
Yes	No	N/A	d. Locational data (latitude and longitude of each outfall).
Yes	No	N/A	8. Laboratory equipment calibration and maintenance records are adequate.
			9. Treatment plant records include (Note—these records are only required for facilities built with Federal Construction Grant Funds):
Yes	No	N/A	a. O&M Manual.
Yes	No	N/A	b. Percent removal records.
Yes	No	N/A	c. "As-built" engineering drawings.
Yes	No	N/A	d. Construction specifications.
Yes	No	N/A	e. Schedules and dates of equipment maintenance repairs.
Yes	No	N/A	f. Equipment supplies manual.
Yes	No	N/A	g. Equipment data cards.
			10. Management records include:

Yes	No	N/A	a. Average monthly operating records.
Yes	No	N/A	b. Annual reports.
Yes	No	N/A	c. Emergency conditions.
			11. Pretreatment records contain inventory of industrial waste contributors, including:
Yes	No	N/A	a. Monitoring data.
Yes	No	N/A	b. Inspection reports.
Yes	No	N/A	c. Compliance status records.
Yes	No	N/A	d. Enforcement actions.
C. COMPLIANCE SCHEDULE STATUS REVIEW			
Yes	No	N/A	1. Permittee is meeting or has met compliance schedule.
Yes	No	N/A	2. Permittee has obtained necessary approvals to begin construction.
Yes	No	N/A	3. Financial arrangements are complete.
Yes	No	N/A	4. Executed contracts for engineering services.
Yes	No	N/A	5. Completed design plans and specifications.
Yes	No	N/A	6. Construction has begun.
Yes	No	N/A	7. Facility superintendent/chief operator and operating personnel have received adequate training on use of the new treatment unit.
Yes	No	N/A	8. Construction is on schedule.
Yes	No	N/A	9. Equipment acquisition is on schedule.
Yes	No	N/A	10. Facility has completed construction.
Yes	No	N/A	11. Operational startup has begun.
Yes	No	N/A	12. Permittee has requested an extension of time.
D. POTW PRETREATMENT REQUIREMENTS REVIEW			
Yes	No	N/A	THE FACILITY IS SUBJECT TO PRETREATMENT REQUIREMENTS.
			1. Status of POTW pretreatment program:
Yes	No	N/A	a. EPA approved the POTW pretreatment program. (If not, is approval in progress?)
Yes	No	N/A	b. The POTW is in compliance with the pretreatment program compliance schedule. (If not, note why, what is due, and intent of the POTW to remedy.)
			2. Status of Compliance with Categorical Pretreatment Standards.
Yes	No	N/A	a. How many POTW IUs, federal or state, are subject to pretreatment standards?
Yes	No	N/A	b. Are these IUs aware of their responsibility to comply with applicable standards?
Yes	No	N/A	c. Has the facility submitted BMRs (403.12) for these industries?
Yes	No	N/A	i. Have categorical IUs in noncompliance (on BMR reports) submitted compliance schedules?

Yes	No	N/A	ii. How many categorical IUs on compliance schedules are meeting the schedule deadlines?
Yes	No	N/A	d. If the compliance deadline has passed, have all IUs submitted 90-day compliance reports?
Yes	No	N/A	e. Are all categorical IUs submitting the required semiannual report?
Yes	No	N/A	f. Are all new industrial discharges in compliance with new source pretreatment standards?
Yes	No	N/A	g. Has the POTW submitted an annual pretreatment report?
Yes	No	N/A	h. Has the POTW taken enforcement action against noncomplying IUs?
Yes	No	N/A	i. Is the POTW conducting inspections of industrial contributors?
Yes	No	N/A	3. Are the IUs subject to Prohibited Limits (403.5) and Local Limits more stringent than EPA in compliance? (If not, explain why, including need for revision of limits.)
Document any issues below:			

CHAPTER 4 – FACILITY SITE REVIEW—WASTEWATER TREATMENT PLANTS

Contents

A. Objectives.....	70
B. Physical Inspection of the Facility	70
General Conditions in Overall Plant	72
Wastewater Collection System	73
Preliminary Treatment at the Headworks.....	73
Primary Clarifier.....	74
Secondary Biological Treatment Units	75
Secondary Clarifier	76
Advanced Physical Treatment Units.....	76
Disinfection.....	78
Sludge Handling.....	79
Polishing Ponds or Tanks.....	82
Plant Effluent.....	82
Flow Measurement	82
Chemical Treatment Units.....	83
Standby Power and Alarms	83
General Housekeeping	83
Production Changes	83
C. Permit Compliance and Operation and Maintenance Evaluation	84
Compliance Evaluation	84
Operation Evaluation	85
Maintenance Evaluation.....	91
D. References.....	92
E. Facility Site Review Checklist.....	94

List of Tables

Table 4-1. Operation and Maintenance Function Evaluation Questions.....	86
---	----

List of Exhibits

Exhibit 4-1. General Wastewater Treatment Flow Diagram.....	97
---	----

A. OBJECTIVES

The objectives of a facility site review are to:

- Assess the physical conditions of the facility's current treatment processes and operations.
- Evaluate the permittee's operation and maintenance activities that impact plant performance.
- Check the completeness and accuracy of the permittee's performance/compliance records.
- Determine whether the treatment units are achieving the required treatment efficiencies.

To accomplish this, a National Pollutant Discharge Elimination System (NPDES) inspector should conduct a physical inspection of the facility (i.e., site survey), interview various levels of management and staff, and review facility records.

The information in this chapter is based on a comprehensive inspection at a Publicly Owned Treatment Works (POTW). The information is applicable to Wastewater Treatment Plants (WWTPs). This chapter includes an example of a Facility Site Review Checklist at the end of this chapter.

B. PHYSICAL INSPECTION OF THE FACILITY

This section pertains to inspections of WWTPs. To conduct a proper NPDES inspection the inspector must fully understand the wastewater treatment processes used at the facility and how each process fits into the overall treatment scheme. A General Wastewater Treatment Plant Flow Diagram is included at the end of this chapter (

Exhibit 4-1).

The inspector should conduct an examination of process treatment units, sampling and flow monitoring equipment, outfalls, and the receiving stream, particularly focusing on areas of the permittee's premises where pollutants are generated, pumped, conveyed, treated, stored, or disposed of. As the inspector becomes more knowledgeable about the facility being inspected, they should focus on areas that are likely to impact permit compliance and evaluate overall performance of the treatment facility. Inspectors should not enter confined spaces during the inspection of the facility unless they are properly training for confined space entry procedures.

During the inspection, the inspector should pay attention to the operational factors listed below and carefully document all the observations.:

- Influent characteristics, including:
 - Appearance (color, odor, etc.)
 - Combined sewer loads

- Infiltration/inflow
- Industrial contributions
- Diurnal/seasonal loading variations

- Process control and settings
- Unit operations including supply of treatment chemicals
- Equipment design and current operating conditions
- Maintenance and operation staff
- Safety controls and equipment
- Effluent characteristics, including:
 - Appearance of discharge
 - Receiving stream appearance including any staining, deposits, or eutrophication
 - Evidence of toxicity of the discharge

- Other conditions particular to the plant

The inspector should evaluate the facility in terms of solids management, looking for evidence of excessive solids levels in clarifiers and sludge thickeners, insufficient solids wasting capabilities, the need for temporary sludge holding tanks, dewatering systems such as belt presses out of service, and sludge drying beds with excessive amounts of sludge. The Environmental Protection Agency's (EPA's) *Field Manual for Performance Evaluation and Trouble Shooting at Municipal Wastewater Facilities* (EPA, 1978) is a good reference for operational characteristics of plants. Additional resources for inspectors to learn more about wastewater treatment processes and facilities are provided at the end of this chapter in Section D, "References."

The physical inspection, along with staff interviews and record reviews (discussed in subsequent sections of this chapter), may lead the inspector to determine:

- Whether a major facility design problem requires an engineering solution.
- Whether problems can be solved through proper operation and maintenance of the treatment facilities.
- Whether periodic equipment malfunctions at the facility indicate the need for equipment overhaul or replacement.

When conducting the inspection, the inspector should be aware of and look for physical conditions that indicate past, existing, or potential problems. Conditions to look for in the plant (generally and in specific processes) are listed in the following subsections. The presence of these conditions will give the inspector an idea of the types of problems present, the parts of the treatment process causing the problems, and the potential solution to existing problems.

GENERAL CONDITIONS IN OVERALL PLANT

General Indicators

- Suspected poor water quality of the effluent discharge.
- Excessive scum buildup; grease, foam, or floating sludge in clarifiers; high sludge blanket levels in the secondary clarifiers, or excessively high solids inventories in the aeration basins (unusually high mixed liquor suspended solids (MLSS)).
- Sludge washout occurrences, or any other ineffective or inadequate sludge wasting capabilities.
- Hydraulic overload caused by storms, discharges of cooling water, or undersized facility or process.
- Noxious odors in wet wells and grit chambers and around aerobic and anaerobic biological units, scum removal devices, and sludge handling and treatment facilities.
- Evidence of severe corrosion at the treatment plant and in the collection system.
- Discoloration of the ground or a strong chemical smell may indicate past spills at the plant; further investigation of spills may be warranted.
- Vital treatment units out of service for repairs. Determine when the units went out of service, the type of failure, and when they will be put back in service.
- Excessive noise from process or treatment equipment.
- Any unusual equipment intended to correct operation problems (e.g., special pumps, floating aerators in diffused air systems, chemical feeders, temporary construction or structures, or any improvised system).
- Ruptures in chemical feed lines.

Flow Indicators

- Surging of influent lines, overflow weirs, and other structures.
- Hydraulically overloaded process or equipment.
- Flow through bypass channels.
- Overflows at alternative discharge points, channels, or other areas.
- Excessive septage dumping by septic tank pumpers.
- Flow from unknown source or origin.
- Open-ended pipes that appear to originate in a process or storage area and periodically discharge to the ground or to surface water. Although these pipes have been disconnected from a closed system or otherwise removed from service, they can still be connected to a discharge source.
- Flow charts indicating acute Infiltration and Inflow (I/I) problems following rain events.

Unusual Waste Indicators

- Collected screenings, slurries, sludges, waste piles, or byproducts of treatment. Their disposal, including runoff of any water, must be such that none enters navigable waters or their tributaries.
- Improper or lack of recycling of filtrates and supernatants from sludge dewatering and treatment.
- Improper storage of chemicals and hazardous substances with attention to the proper diking of chemicals and hazardous substances and segregation of incompatible chemicals. Generally, spill containment should be such that the dike could contain the contents of the largest tank.
- Spills or mishandling of chemicals.

WASTEWATER COLLECTION SYSTEM

Piping/Transport

- Degrading quality of piping material. Most commonly used materials are ductile iron, concrete, or polyvinyl chloride (PVC).

Pumping Station

- Dangerously high wet well levels at the pump station.
- Malfunctioning alarm system to notify of low-high wet well levels, pump failure, and power failure.
- Inadequate pumping capacity when wet well levels are high.
- Inoperable pumps.

PRELIMINARY TREATMENT AT THE HEADWORKS

Screening

- Spacing of screening bars outside the range of 0.25 to 2.0 inches
- Surge conditions in the influent sewer lines
- Excessive screen clogging
- Excessive buildup of debris against screen
- Oil and grease buildup
- Excessive scouring velocities through the screen during cleaning
- Improper disposal of screened material
- Excessive odors
- Pass through of grease and debris that shows up in the final effluent

Shredding/Grinding

- Blockage in sludge pumps or lines
- Bypass of shredding/grinding equipment
- Equipment removed or inoperable

Grit Removal

- Velocity-controlled grit removal processes with wastewater velocity exceeding or significantly less than 1 foot per second.
- Grit chamber clogged or subject to odors.
- Clogging in pipes and sedimentation basin sludge hoppers.
- Less than typical grit accumulation in subsequent processes.
- Inoperable air diffusers leading to excessive organic content of grit.
- Wear of grit removal/handling equipment.
- Excessive odors in grit removal area.

Influent Pumping

- Inadequate pumping capacity during periods of high influent flow
- Inoperable pumps

Flow Equalization

- Equalization tank never empty
- Excessive odors
- Inoperable aerators, if aerated
- Ability to bypass directly to surface water

PRIMARY CLARIFIER

General Indicators

- Excessive gas bubbles or grease on surface
- Black and odorous wastewater
- Poor removal of suspended solids in primary clarifier
- Excessive buildup of solids in center well of circular clarifier
- Unlevel discharge weirs
- Fouling of overflow weirs
- Evidence of short circuiting
- Ineffective scum rake
- Scum overflow or lack of adequate scum disposal, full scum pit
- Excessive floating sludge and/or scum (high sludge blanket level)
- Excessive sludge on bottom, inadequate sludge removal
- Noisy sludge scraper drive
- Broken sludge scraper equipment
- Poor maintenance of sludge pumps (leaking) or pump gallery

SECONDARY BIOLOGICAL TREATMENT UNITS

Trickling Filter/Activated Biofilters

- Filter ponding (indicating clogged media)
- Dried or collapsed media
- Leak at center column of filter's distribution arms
- Uneven distribution of flow on filter surface
- Uneven or discolored growth
- Excessive growth of biomass
- Excessive sloughing of growth
- Odor
- Clogging of trickling filter's distribution arm orifices
- Restricted rotation of distribution arms
- Filter flies, worms, or snails
- Ice buildup on trickling filter media or distribution arms
- Inappropriate recirculation rates of filter or secondary effluent

Rotating Biological Contactors

- Odor
- Development of white biomass on rotating biological contactor (RBC) media
- Excessive sloughing of growth
- Excessive breakage of rotating disks or shafts in RBC units
- Shaft, bearing, drive gear, or motor failure
- Solids accumulation in RBC units

Activated Sludge Tanks

- Excessive breakage of paddles on brush aerators.
- Shaft, bearing, drive gear, or motor failure on disk or brush aerators.
- Dead spots in aeration tanks.
- Use of floating aerators in basins designed with bottom air diffusers.
- Failure of surface aerators.
- Inoperative air compressors.
- Air rising unevenly.
- Excessive air leaks in compressed air piping.
- Dark mixed liquor in aeration tank (grey or black).
- Dark foam or bad odor on aeration tanks.
- Stable dark tan foam on aeration tanks that sprays cannot break up.
- Thick billows of white, sudsy foam on aeration tank.

- Low Dissolved Oxygen (DO, < 1.0 mg/l) in aeration tank (except in areas used for denitrification).
- Inadequate return activated sludge rates.
- Solids-related measurements outside of expected range (e.g., MLSS and/or Mixed Liquor Volatile Suspended Solids (MLVSS) concentration, Food to Mass ratio (F:M), sludge age, or mean cell residence time).

Stabilization Ponds/Lagoons

- Trees growing on the bank or within the root zone distance from the bank
- Erosion of stabilization pond bank or dike
- Excessive foliage or animal burrows in pond bank or dike
- Excessive weeds in stabilization ponds
- Foaming and spray in aerated lagoon
- Dead fish or aquatic organisms
- Buildup of solids around influent pipe
- Excessive scum on surface

SECONDARY CLARIFIER

General Indicators

- Excessive gas bubbles on surface.
- Fouling of overflow weirs.
- Unlevel overflow weirs.
- Evidence of short circuiting.
- Excessive buildup of solids in center well of circular clarifier.
- Deflocculation in clarifier.
- Pin floc in overflow.
- Ineffective scum rake.
- Floating sludge on surface; rising sludge or bulking sludge.
- Billowing sludge.
- Excessively high sludge blanket.
- Clogged sludge withdrawal ports on secondary clarifier for either sludge wasting or sludge return.
- Unequal sludge blanket levels in parallel units.
- Inappropriate return and wasting rates.
- Poor maintenance of sludge pumps (leaking) or pump gallery.

ADVANCED PHYSICAL TREATMENT UNITS

Filtration

- Filter surface clogging

- Short filter run
- Air displacement of gravel media
- Formation of mud balls in filter media
- Air binding of filter media
- Loss of filter media during backwashing
- Recycled filter backwash water exceeding 5 percent
- Effluent TSS and BOD levels exceeding 10 mg/L
- Excessive effluent turbidity

Microscreening

- Erratic rotation of microscreen drums
- Plugging
- Drive system noisy or overheating
- Backwash exceeding 5 percent of flow treated

Activated Carbon Adsorption

- Excessive biological growth resulting in strong odor
- pH above 9.0 standard units (S.U.)
- Plugged carbon pores
- Presence of carbon dust in effluent
- Excessive carbon regeneration

Nitrification

- Hydraulic overload
- Inadequate pH control/chemical addition
- Low DO (<2 mg/L) in the aeration basin
- Pin floc in final effluent
- Sludge rising because of gasification in secondary clarifier

Denitrification

- Air temperature below 15°C
- pH below 6.0 S.U. or above 8.0 S.U.
- Excessive methanol or other chemical additions
- Septic sludge conditions.

Ammonia Stripping

- Excessive hydraulic loading rate
- Tower packing coated with calcium carbonate
- pH below 10.8 S.U.
- Inadequate tower packing depth

- Air temperature below 65°F (18 °C)

DISINFECTION

Chlorination

- Sludge buildup in contact chamber
- Gas bubbles
- Inadequate retention time (typically 30 minutes at peak flow conditions)
- Floating scum and/or solids
- Evidence of short circuiting (poor tank baffling)
- Inadequate ventilation of chlorine feeding room and storage area
- High temperatures in chlorination rooms
- Improper operation of automatic feed or feedback control
- Excessive foaming downstream
- Evidence of toxicity downstream (dead fish, other dead organisms)
- Improper chlorine feed, storage, and reserve supply
- Leak detection equipment is tied into the plant alarm system
- Self-Contained Breathing Apparatus (SCBA) available on-site
- Proper training in use of SCBA
- Lack emergency SOP and/or RMP (Risk Management Plan)
- No chlorine repair kit available

Dechlorination

- Improper storage of sulfur dioxide cylinders.
- Inadequate ventilation of sulfur dioxide feeding room.
- Automatic sulfur dioxide feed or feedback control not operating properly.
- Depressed DO after dechlorination.
- Improper storage and mixture of sodium metabisulfite containers.
- Reduced efficiency of activated carbon dechlorination units because of organic and inorganic compound interference.
- No SCBAs available on-site.
- Improper training in use of SCBA.
- No emergency SOP and/or RMP.

Ultraviolet (UV)

- Quartz sleeves not kept clean
- Bulbs are not all operational
- Effluent has high turbidity
- Fecal coliform tests show inadequate bacterial kill

SLUDGE HANDLING

General Indicators

- The facility does not waste sludge.
- Inadequate sludge removal from clarifiers or thickeners.
- Poor dewatering characteristics of thermal treated sludge.
- Thickened sludge too thin.
- Fouling of overflow weirs on gravity thickeners.
- Air flotation skimmer blade binding on beaching plate.
- Unordinary down time of sludge treatment units.
- Sludge disposal inadequate to keep treatment system in balance - storing excess sludge inventory within other treatment units such as activated sludge basin, or clarifiers due to inadequate sludge wasting capabilities.
- Mass balance inappropriate (ratio of sludge wasted should be 0.65-0.85 lbs. of sludge per lb. of Biochemical Oxygen Demand (BOD) removed).
- Sludge decant or return flows high in solids.
- Odors.
- Improper loading rates.
- Lack of adequate process control (unit removal efficiencies, DO, sludge age, F:M ratio, etc.).

Sludge Anaerobic Digestion

- Inoperative mechanical or gas mixers
- Inoperative sludge heater or low temperature
- Inadequate gas production
- Unexpected gas composition
- Floating cover of digester tilting
- Inoperative gas burner
- Supernatant emitting a sour odor from either primary or secondary digester
- Excessive suspended solids in supernatant
- Supernatant recycle overloading the Wastewater Treatment Plant (WWTP)
- pH problems

Sludge Aerobic Digestion

- Excessive foaming in tank
- Objectionable odor in aerobically digested sludge
- Insufficient dissolved oxygen in digester
- Digester overloaded
- Clogging of diffusers in digester
- Mechanical aerator failure in digester

- Inadequate supernatant removal from sludge lagoons
- Solids accumulation in tank

Sludge Dewatering

- Drying beds
 - Poor sludge distribution on drying beds
 - Vegetation in drying beds (unless reed design)
 - Dry sludge remaining in drying beds (storage)
 - Inadequate drying time on drying beds
 - Some unused drying beds
 - Dry sludge stacked around drying beds where runoff may enter navigable waters
 - Filtrate from sludge drying beds returned to front of plant
 - Inadequate sludge wasting capabilities as indicated by all beds being full, and high solids inventory within the treatment units
- Centrifuge
 - Excessive solids in fluid phase of sample after centrifugation
 - Inadequate dryness of centrifugal sludge cake
 - Excessive vibration or other mechanical problems
- Filter press
 - High level of solids in filtrate from filter presses or vacuum filters
 - Thin filter cake caused by poor dewatering
 - Vacuum filter cloth binding
 - Low vacuum on filter
 - Improperly cleaned vacuum filter media
 - Sludge buildup on belts and/or rollers of filter press
 - Excessive moisture in belt filter press sludge cake
 - Difficult cake discharge from filter presses
 - Filter cake sticks to solids-conveying equipment of filter press
 - Frequent media binding of plate filter press
 - Sludge blowing out of filter press
 - Insufficient run time of sludge dewatering equipment

Sludge Stabilization

- Lagoon
 - Objectionable odor from sludge lagoon
 - Damage to dikes around sludge drying lagoons
 - Unlined sludge lagoons

- Sludge lagoons full, overflowing sludge back to plant or to natural drainage
- Deep rooted vegetation on dikes or berms
- Composting
 - Piles that give off foul odor
 - Inoperable blower
 - Temperature does not reach 122–140°F (50–60°C)
 - Uncontrolled stormwater runoff
- Heat drying/pelletizing
 - Excess moisture in sludge feed
 - Insufficient air flow or drying temperature achieved
 - Inadequate drying of final product (excess moisture in final product)
 - Excess odors associated with treatment area
 - Excess odors associated with treated product
- Alkaline stabilization
 - Insufficient amount of lime (or other alkaline additive) used to ensure pH is raised sufficiently.
 - Inadequate mixing provided to ensure good contact of lime (or other alkaline additive) with sludge solids.
 - pH problems.
 - Excess odors associated with treatment area.
 - Excess odors associated with treated product.
 - Excessive lime dust around treatment equipment.
- Incineration
 - Objectionable odors associated with treatment area
 - Evidence of excessive ash around unit
 - Visible smoke or dust exhaust from unit
 - Noncompliance with air permit parameters
 - Spilling or leaking sludge from dewatered sludge transfer equipment
- Sludge disposal
 - Sludge constituents not analyzed before disposal
 - Sludge not transported in appropriate and approved vehicle
 - Surface runoff of sludge at land application site
 - Liquid sludge (i.e., less than 10 percent solids) applied to landfill site
 - Sludge fails paint filter test
 - Inadequate coverage of sludge in subsurface plow injection system

- Objectionable odors generated at land application site
- Slow drying of soil-sludge mixture in subsurface injection system
- Sludge pooling at land application sites
- Breeding flies, vectors, and/or odors at landfill site
- Inadequate burial of sludge at landfill site
- Excessive erosion at sludge sites
- Sludge disposed of in unpermitted sites
- Disposal not in accordance with federal, state, or local regulations
- Sludge lagoons full and overflowing
- Inadequate runoff control at landfill or land application sites

POLISHING PONDS OR TANKS

- Objectionable odor, excessive foam, floating solids, or oil sheens in polishing ponds or tanks.
- Solids or scum accumulations in tank or at side of pond.
- Evidence of bypassed polishing ponds or tanks.

PLANT EFFLUENT

- Excessive suspended solids, turbidity, foam, grease, scum, color, and other macroscopic particulate matter present.
- Potential toxicity (dead fish, dead plants at discharge).
- Stained sediments in receiving waters.
- Sludge in the receiving water, anaerobic sediments, and blood worms.
- Low dissolved oxygen content.
- Eutrophication.

FLOW MEASUREMENT

- Improper placement of flow measurement device.
- Flow totalizer not calibrated.
- Buildup of solids in flume or weir.
- Broken or cracked flume or weir.
- Improperly functioning magnetic flowmeter.
- Clogged or broken stilling wells.
- Weir plate edge corroded or damaged; i.e., not sharp edged (< 1/8"), or not level.
- System not capable of measuring maximum flow.
- Sizing of system adequate to handle flow range.
- Flow measurement error greater than ± 10 percent.
- Flow measurement that includes all wastewater discharged and does not include wastestreams that are recirculated back to the treatment plant.

CHEMICAL TREATMENT UNITS

- Evidence of heavy corrosion
- No portion-measuring device at feed unit
- pH measuring not evident at pH adjustment tank
- Chemicals left open when they should be closed
- Chemicals outdated
- Chemical containers stored improperly or hazardously
- Inappropriately stored, moved, or handled chemical tank cars (trucks or train)
- Spilled dry chemicals on floor between storage area and feed units
- Improperly disposed of empty chemical containers
- Large containers handled improperly, container transfer equipment not maintained
- No appropriate sized berms or dikes at liquid chemical feed units
- Inadequate supply of chemicals
- Chemical dust covering feed unit area or, storage and transfer areas
- Use of an inappropriate coagulant
- Improperly stored or handled glass carboys (acid storage)

STANDBY POWER AND ALARMS

- Emergency generator with no automatic switch-over.
- Generator not regularly checked and exercised.
- No separate electrical substation feed line.
- Portable generators with quick connects.
- Portion of plant operated by the standby power.
- Treatment units and headworks equipped with alarms to notify operations staff of unit failure or loss of power.
- System for Supervisory Control and Data Available (SCADA):
 - Only large facilities tend to have this equipment.
 - SCADA to monitor and operate lift station in the collection system.

GENERAL HOUSEKEEPING

- Facility control panel in disrepair or not in use
- Wastewater pipelines not clearly distinguished from product pipelines
- Spills or leaks in dry areas not remediated in a timely manner

PRODUCTION CHANGES

- For a POTW, change in service area.
- For a POTW, increase or decrease in intake flows from industrial, commercial, or domestic sectors.

- For an IU, change in production volume.
- For an IU, large alteration of processes (inputs, temperature, etc.).

C. PERMIT COMPLIANCE AND OPERATION AND MAINTENANCE EVALUATION

In addition to the physical inspection of the plant, inspectors should also evaluate the operation and maintenance of the plant equipment and the facility's compliance with their permit requirements. When the physical inspection findings indicate that specific practices of the facility contribute to or cause problems, the inspector should detail the problems and use that information to evaluate the operation and maintenance procedures.

Inspectors should interview various staff to provide a better idea of what is happening on-site. If conflicting information is received during staff interviews, make sure to clarify this information before leaving the site. If the staff does not clearly answer a question, rephrase the question and ask it later during the inspection. The inspector should interview facility staff to:

- Gather background information.
- Determine normal operation and maintenance procedures.
- Evaluate knowledge and ability.
- Determine the number of operation, maintenance, laboratory, and other essential staff.

The inspector should also review the following records as needed:

- Operator logs
- Operations and maintenance records
- Operations and maintenance manual
- Sampling and laboratory records
- Monitoring reports

COMPLIANCE EVALUATION

The inspector should bring to the inspection a few submitted Discharge Monitoring Reports (DMRs) to compare with the monitoring reports kept on-site. To evaluate compliance with permit requirements, the inspector should:

- Compare monitoring report data to the permit requirements and verify that all non-compliance has been reported, monitoring requirements have been met, and analysis is in accordance with permit requirements.
- Compare the laboratory data to reported data to ensure transcription errors have not occurred and ensure all data on the DMR is accurate.
- Evaluate laboratory analytical procedures and methods to ensure the accuracy of the effluent discharge data.
- Randomly check calculations to evaluate accuracy of reported data.

OPERATION EVALUATION

Operating factors affecting plant performance range from qualitative factors such as the skills and aptitudes of operators (e.g., process knowledge and general aptitude), to physical deficiencies in laboratory equipment or a lack of flexibility in process equipment. The evaluation of operation functions must focus on wastewater treatment, sludge treatment/disposal, and laboratory analysis. The evaluation should be based on the following topics:

- Policies and procedures
- Organization
- Staffing and training
- Planning
- Management controls

Although each of the preceding evaluation topics should be covered in the review of operation functions, the four areas discussed in the following paragraphs should particularly concern the inspector:

Policies and Procedures

Written operating procedures and standard reference texts enable the operator to achieve efficient plant operation. The operations manual prepared for the facility is the most important reference that an inspector should review when evaluating plant policies and procedures. Other reference materials relating to operations that should be available to the operator include manufacturers' literature, publications by professional organizations (e.g., the Water Environment Federation), and EPA publications.

Staffing and Training

Even the best engineered facility cannot perform to its potential without enough capable and qualified staff. The inspector must consider the abilities and limitations of the operating staff. Most states have some type of certification program for operators. The inspector may inquire about how many of the staff has been trained and to what degree staff is certified. Staff interviews may include the individual in charge of the overall operation, the chief operator, specific unit process operators, and laboratory staff. The inspector should ascertain the hours the facility is manned and unmanned. If the facility is regularly unmanned, the inspector should inquire about unit alarms, in the event of equipment failure or loss of power, alarm telemetry or autodialers, facility response procedures and whether there have been any unit bypasses as a result of the plant being unmanned.

Health and Safety

At all times, the facility should follow safe operating procedures. Employees must be trained in emergency shut-down, fire control, and spill response procedures, as well as in the use of safety equipment, safe sampling techniques, and safe handling of chemicals and wastes. Employees should not enter confined spaces unless properly trained and equipped. Managers must be aware of the Occupational Safety and Health Administration (OSHA) Right-to-Know

laws regarding potentially dangerous chemicals in the workplace. This law specifically requires a written hazard communication program, labeling of chemicals, and the availability of material safety data sheets to employees upon request. Safety practices specified in the NPDES permit should be verified by the inspector, however, if safety concerns unrelated to the permit are observed, the facility should be referred to OSHA to address the concern.

Management Controls

Monitoring practices are a good indicator of both the emphasis placed on operations and the operator's understanding of process controls. Factors affecting a facility's monitoring capabilities include the following:

- The sampling program
- Performance testing
- Analytical capabilities
- Recordkeeping practices

An effective process control program is essential to a treatment facility's optimal performance. In most cases, the inspector will rely on discussions with the plant superintendent and/or operators to supplement available records and the technical evaluation. The key considerations for effective process controls include the following:

- Process control data
- Process knowledge of the operators
- The basis for the control practices
- Implementation of the control practices
- Past performance
- Operator emphasis on controls
- Recordkeeping

Table 4-1 presents the basic review questions that an inspector should ask in evaluating operation functions.

Table 4-1. Operation and Maintenance Function Evaluation Questions

Policies and Procedures
<ul style="list-style-type: none"> • Is there a formal or informal set of policies for facility operations? • Do policies address: <ul style="list-style-type: none"> – Compliance with permit? – Maintaining process controls? – Quality control? – Preventive maintenance? • Is there a set of standard procedures to implement these policies? • Are the procedures written or informal?

Table 4-1. Operation and Maintenance Function Evaluation Questions

<ul style="list-style-type: none"> • Do the procedures consider the following areas? <ul style="list-style-type: none"> – Collection system – Emergency – Energy conservation – Equipment record system – Inventory management – Labor relations scheduling – Laboratory – Maintenance planning – Monitoring – Operating procedures – Process control – Pumping stations – Safety – Sludge disposal – Treatment chemical supply – Treatment process – Work orders
<ul style="list-style-type: none"> • Are the procedures followed?
<p>Organization</p>
<ul style="list-style-type: none"> • Is there an organizational plan (or chart) for operations? • Does the plan include: <ul style="list-style-type: none"> – Delegation of responsibility and authority? – Job descriptions? – Interaction with other functions (such as maintenance)? • Is the plan formal or informal? • Does staff have access to and understand the plan? • Does the facility follow the plan? • Is the plan consistent with policies and procedures? <ul style="list-style-type: none"> – Is the plan flexible? – Can it handle emergency situations? – Does the plan clearly define lines of authority and responsibility in the following subfunctional areas?
<ul style="list-style-type: none"> ▪ Laboratory ▪ Monitoring practices ▪ Process control ▪ Mechanical ▪ Instruments ▪ Electrical ▪ Sludge disposal ▪ Buildings and grounds ▪ Collection system ▪ Automotive ▪ Pumping stations ▪ Supplies and spare parts
<p>Staffing</p>
<ul style="list-style-type: none"> • Is there an adequate number of staff to achieve policies and procedures? • Have you considered long-term, strategic workforce planning and recruitment? • Are staff members adequately qualified for their duties and responsibilities by demonstrating the following: <ul style="list-style-type: none"> – Certification – Qualifications – Ability

Table 4-1. Operation and Maintenance Function Evaluation Questions

<ul style="list-style-type: none"> – Job performance – Understanding of treatment processes • Is staff used effectively to support plant activities? • Has the potential for borrowing personnel from other plants been considered? • Are training procedures followed for: <ul style="list-style-type: none"> – Orientation of new staff? – Training new operators? – Training new supervisors? – Continuing training of existing staff? – Cross training staff between plant jobs needing more staff/support? • Which of the following training procedures are used? <ul style="list-style-type: none"> – Formal classroom – Home study – On-the-job training – Participation in professional organization • Does the training program provide specific instruction for the following operations and maintenance activities? 														
<table border="0"> <tr> <td>– Automotive</td> <td>– Inventory control</td> </tr> <tr> <td>– Building maintenance</td> <td>– Laboratory procedures</td> </tr> <tr> <td>– Electrical</td> <td>– Mechanical</td> </tr> <tr> <td>– Emergency procedures</td> <td>– Monitoring practices</td> </tr> <tr> <td>– Equipment troubleshooting</td> <td>– Safety</td> </tr> <tr> <td>– Handling personnel problems</td> <td>– Treatment processes</td> </tr> <tr> <td>– Instrumentation</td> <td></td> </tr> </table>	– Automotive	– Inventory control	– Building maintenance	– Laboratory procedures	– Electrical	– Mechanical	– Emergency procedures	– Monitoring practices	– Equipment troubleshooting	– Safety	– Handling personnel problems	– Treatment processes	– Instrumentation	
– Automotive	– Inventory control													
– Building maintenance	– Laboratory procedures													
– Electrical	– Mechanical													
– Emergency procedures	– Monitoring practices													
– Equipment troubleshooting	– Safety													
– Handling personnel problems	– Treatment processes													
– Instrumentation														
<ul style="list-style-type: none"> • Does management encourage staff motivation? • Does management support its first-line supervisors? • Is staff motivation maintained through any of the following tools? <ul style="list-style-type: none"> – Encouragement for training – Job recognition – Job security – Promotional opportunities – Salary incentives – Working environment 														
<p>Operations</p>														
<ul style="list-style-type: none"> • How does the facility establish operating schedules? • Do schedules attempt to attain optimum staff utilization? • Are line supervisors included in manpower scheduling? • Are staff involved in and/or informed of manpower planning? • Is there sufficient long-term planning for staff replacement and system changes? 														

Table 4-1. Operation and Maintenance Function Evaluation Questions

<ul style="list-style-type: none"> • Are there procedures in manpower staffing for emergency situations? • How are process control changes initiated? • How do process control changes interact with management controls? • How are laboratory results used in process control? • Are there emergency plans for treatment control? • Is there an effective energy management plan? Is the plan used? • To what extent are operations personnel involved in the budget process? • Do budgets adequately identify and justify the cost components of operations? • Are future budgets based on current and anticipated operating conditions? • Do operating and capital budget limits constrain operations? • Can budget line items be adjusted to reflect actual operating conditions?
Maintenance
<ul style="list-style-type: none"> • Are maintenance activities planned? Is the planning formal or informal? • Does the facility have sufficient management controls to affect realistic planning and scheduling? If the controls exist, are they used? • Are operating variables exploited to simplify maintenance efforts? • To what extent are the supply and spare part inventories planned in conjunction with maintenance activities? • Have minimum and maximum levels been established for all inventory items? • Does the facility have a maintenance emergency plan? • Is the maintenance emergency plan current? Is the staff knowledgeable about emergency procedures? • Does a plan exist for returning to the preventive maintenance mode following an emergency? • Are preventive maintenance tasks scheduled in accordance with manufacturer’s recommendations? • Is adequate time allowed for corrective maintenance? • Are basic maintenance practices (preventive and corrective) and frequencies reviewed for cost-effectiveness? • Do the management controls provide sufficient information for accurate budget preparation? • Does the maintenance department receive feedback on cost performance to facilitate future budget preparation? • To what extent are maintenance personnel involved in the budget process? • Do budgets adequately identify and justify the cost components of maintenance? • Are future budgets based on current and anticipated operating and maintenance conditions? • Do maintenance and capital budget limits constrain preventive maintenance (equipment replacement and improvements)? • Does the maintenance department receive adequate feedback on cost performance? • Can budget line items be adjusted to reflect actual maintenance conditions?
Management Controls
<ul style="list-style-type: none"> • Are current versions of the following documents maintained? <ul style="list-style-type: none"> – Operating reports – Work schedules

Table 4-1. Operation and Maintenance Function Evaluation Questions

- Activity reports
- Performance reports (labor, supplies, energy)
- Expenditure reports (labor, supplies, energy)
- Cost analysis reports
- Emergency and complaint calls
- Process control data, including effluent quality
- Do the reports contain sufficient information to support their intended purpose?
- Are the reports usable and accepted by the staff?
- Are the reports being completed as required?
- Are the reports consistent among themselves?
- Are the reports used directly in process control?
- Are the reports reviewed and discussed with operating staff?
- What types of summary reports are required?
- To whom are reports distributed and when?

Management Controls (Maintenance)

- Does a maintenance record system exist? Does it include the following?
 - As-built drawings
 - Shop drawings
 - Construction specifications
 - Capital and equipment inventory
 - Maintenance history (preventive and corrective)
 - Maintenance costs
 - Equipment manuals
- Does the facility keep a current base record system as part of daily maintenance practices?
- Does the facility have a work order system for scheduling maintenance? Is it explicit or implicit?
- Which of the following do work orders contain?
 - Date
 - Location
 - Work requirements
 - Assigned personnel
 - Work order number
 - Nature of problem
 - Time requirements
 - Space for reporting work performed, required parts and supplies, time required, and cost summary
 - Responsible staff member and supervisory signature requirements
- When emergency work must be performed without a work order, is one completed afterward?
- Are work orders usable and acceptable by staff as essential to the maintenance program? Are they completed?

Table 4-1. Operation and Maintenance Function Evaluation Questions

- Is work order information transferred to a maintenance record system?
- Does a catalog or index system exist for controlling items in inventory?
- Are withdrawal tickets used for obtaining supplies from inventory?
- Do the tickets contain cost information and interact well with inventory controls and the work order system?
- Is the cost and activity information from work orders aggregated to provide management reports? Is this information also used for budget preparation?
- Is the maintenance performance discussed regularly with staff?
- How is the cost of contract maintenance or the use of specialized assistance recorded?
- Are safeguards and penalties adequate to prevent maintenance cards from being returned without the work being done?
- Is the preventive maintenance record checked after an emergency equipment failure?

MAINTENANCE EVALUATION

Facility maintenance directly affects the ability of the facility to run efficiently and to comply with its NPDES permit. The two types of facility maintenance are preventive maintenance and corrective maintenance:

- Preventive maintenance:
 - Reduces facility operating costs by eliminating breakdowns and the need for corrective maintenance.
 - Improves the facility's reliability by minimizing the time equipment is out of service.
 - Increases the useful life of equipment, thus avoiding costly premature replacement.
 - Avoids possible compliance violations.
- Corrective maintenance:
 - Returns malfunctioning equipment to operation
 - Avoids or minimizes possible violations

Evaluation of the maintenance function should focus on the ability to maintain process equipment, supply of treatment chemicals, vehicles, and building and grounds. Although each of the five evaluation topics (policies and procedures, organization, staffing, planning, and management controls) should be covered for each facility inspected, the principal areas of concern in the maintenance evaluation are:

- Staffing and training
- Planning and scheduling
- Management controls, including records systems and inventory control

Only well-trained, competent plant staff can be expected to perform adequate physical inspections, repairs, and preventive maintenance. Wastewater facility maintenance is complex and requires a variety of skills. An ongoing training program is essential because many of these skills are not readily available.

Maintenance planning and scheduling are essential to effective corrective and preventive maintenance. The maintenance supervisor should prepare work schedules listing job priorities, work assignments, available personnel, and timing.

A detailed records system is the basis of any maintenance program. Records are used to establish maintenance histories on equipment, diagnose problems, and anticipate—and thereby avoid—equipment failure, making records an effective tool for preventive maintenance.

A central inventory of spare parts, equipment, and supplies should be maintained and controlled. The basis for the inventory should be the equipment manufacturer's recommendations, supplemented by specific, historical experience with maintenance problems and requirements. Inventoried supplies should be kept at levels sufficient to avoid process interruptions.

A maintenance cost control system should be an integral part of every wastewater facility. Budgets must be developed from past cost records and usually are categorized according to preventive maintenance, corrective maintenance, and projected and actual major repair requirements. Annual costs must be compared to the budget periodically to control maintenance expenditures. Evaluating costs this way serves to control expenditures and provides a baseline for future budgets.

The basic concerns that need to be addressed and evaluated during the inspector's maintenance program review are presented in Table 4-1. These questions may help identify the causes of a facility's operation and maintenance problems.

D. REFERENCES

The following is a list of resources providing more information on wastewater treatment facilities and their processes.

U.S. Environmental Protection Agency. (1973). *Maintenance Management Systems for Municipal Wastewater Facilities*. EPA 430/9-74-004.

U.S. Environmental Protection Agency. (1978). *Field Manual for Performance Evaluation and Troubleshooting at Municipal Wastewater Treatment Facilities*. MO No. 16, EPA 430/9-78-001.

U.S. Environmental Protection Agency. (1979). *Inspector's Guide for Evaluation of Municipal Wastewater Treatment Plants*. EPA 430/9-79-010.

U.S. Environmental Protection Agency. (1982). *Comprehensive Diagnostic Evaluation and Selected Management Issues*. EPA 430/9-82-003.

U.S. Environmental Protection Agency. (1999a). *Wastewater Technology Fact Sheet Ozone Disinfection*. EPA 832-F-99-063.

U.S. Environmental Protection Agency. (1999b). *Wastewater Technology Fact Sheet Ultraviolet Disinfection*. EPA 832-F-99-064.

U.S. Environmental Protection Agency. (2000a). *Biosolids Technology Fact Sheet Centrifuge Thickening and Dewatering*. EPA 832-F-00-053.

U.S. Environmental Protection Agency. (2000b). *Biosolids Technology Fact Sheet Belt Filter Press*. EPA 832-F-00-057.

U.S. Environmental Protection Agency. (2000c). *Decentralized Systems Technology Fact Sheet Aerobic Treatment*. EPA 832-F-00-031.

U.S. Environmental Protection Agency. (2000d). *Decentralized Systems Technology Fact Sheet Evapotranspiration*. EPA 832-F-00-033.

U.S. Environmental Protection Agency. (2000e). *Guide for Evaluating Capacity, Management, Operation, and Maintenance Programs at Wastewater Treatment Plants*. EPA 300-B-00-015.

U.S. Environmental Protection Agency. (2000f). *Wastewater Technology Fact Sheet Ammonia Stripping*. EPA 832-F-00-019.

U.S. Environmental Protection Agency. (2000g). *Wastewater Technology Fact Sheet Chemical Precipitation*. EPA 832-F-00-018.

U.S. Environmental Protection Agency. (2000h). *Wastewater Technology Fact Sheet Dechlorination*. EPA 832-F-00-022.

U.S. Environmental Protection Agency. (2000i). *Wastewater Technology Fact Sheet Force Main Sewers*. EPA 832-F-00-071.

U.S. Environmental Protection Agency. (2000j). *Wastewater Technology Fact Sheet Granular Activated Carbon Adsorption and Regeneration*. EPA 832-F-00-017.

Water Environment Federation (WEF). (1992). *Wastewater Treatment Plant Design*. MOP No. 8.

Water Pollution Control Federation (WPCF). (1990). *Operation of Wastewater Treatment Plants*. MOP No. 11.

E. FACILITY SITE REVIEW CHECKLIST

The following is an example of a checklist that may be used by inspectors at a facility site review.

A. Operation and Maintenance Evaluation			
Yes	No	N/A	1. Facility properly operates and maintains treatment units
Yes	No	N/A	2. Facility has standby power or other equivalent provision.
Yes	No	N/A	3. Adequate alarm system for power or equipment failures is available.
Yes	No	N/A	4. Sludge disposal procedures are appropriate: a. Disposal of sludge according to regulations b. State approval for sludge disposal received.
Yes	No	N/A	
Yes	No	N/A	5. All treatment units, other than backup units, are in service.
Yes	No	N/A	6. Facility follows procedures for facility operation and maintenance.
Yes	No	N/A	7. Sufficient sludge is disposed of to maintain treatment process equilibrium.
Yes	No	N/A	8. Organizational Plan (chart) for operation and maintenance is provided.
Yes	No	N/A	9. Plan establishes operating schedules.
Yes	No	N/A	10. Facility has written emergency plan for treatment control.
Yes	No	N/A	11. Maintenance record system exists and includes: a. As-built drawings b. Shop drawings c. Construction specifications d. Maintenance history e. Maintenance costs f. Repair history g. Records of equipment repair and timely return to service.
Yes	No	N/A	
Yes	No	N/A	
Yes	No	N/A	
Yes	No	N/A	
Yes	No	N/A	
Yes	No	N/A	
Yes	No	N/A	12. Adequate number of qualified operator's on-hand.
Yes	No	N/A	13. Facility has established procedures for training new operators.
Yes	No	N/A	14. Facility maintains adequate spare parts and supplies inventory.
Yes	No	N/A	15. Facility keeps instruction files for operation and maintenance of each item of major equipment.
Yes	No	N/A	16. Operation and maintenance manual is available.
Yes	No	N/A	17. Regulatory agency is notified of any bypassing. (Dates: _____)
Yes	No	N/A	18. a. Hydraulic overflows and/or organic overloads are experienced. b. Untreated bypass discharge occurs during power failure. c. Untreated overflows occurred since last inspection. Reason: d. Flows were observed in overflow or bypass channels. e. Checking for overflows is performed routinely. f. Overflows are reported to EPA or to the appropriate state agency as specified in the permit.
Yes	No	N/A	
Yes	No	N/A	
Yes	No	N/A	
Yes	No	N/A	
Yes	No	N/A	

B. Safety Evaluation			
Yes	No	N/A	1. Facility uses undiked/unbermed oil/chemical storage tanks.
Yes	No	N/A	2. Facility maintains up-to-date equipment repair records.
Yes	No	N/A	3. Dated tags show out-of-service equipment. a. Proper facility/unit lock-out and tag-out procedures are being followed.
Yes	No	N/A	4. Facility schedules/performs routine and preventive maintenance on time.
Yes	No	N/A	5. Facility provides personal protective clothing (e.g., safety helmets, ear protectors, goggles, gloves, rubber boots with steel toes, eyewashes in labs).
Yes	No	N/A	6. Safety devices are readily available: a. Fire extinguishers. b. Oxygen deficiency/explosive gas indicator. c. Self-contained breathing apparatus near entrance to chlorine room. d. Safety harness. e. First aid kits. f. Ladders to enter manholes or wet-wells (fiberglass or wooden for electrical work). g. Traffic control cones. h. Safety buoy at activated sludge plants. i. Life preservers for lagoons. j. Fiberglass or wooden ladder for electrical work. k. Portable crane/hoist.
Yes	No	N/A	
Yes	No	N/A	
Yes	No	N/A	
Yes	No	N/A	
Yes	No	N/A	
Yes	No	N/A	
Yes	No	N/A	
Yes	No	N/A	
Yes	No	N/A	
Yes	No	N/A	
Yes	No	N/A	7. Plant has general safety structures such as rails around or covers over tanks, pits, or wells.
Yes	No	N/A	8. Emergency phone numbers are listed, including EPA and state.
Yes	No	N/A	9. Plant is generally clean, free from open trash areas.
Yes	No	N/A	10. Facility has available portable hoists, for equipment removal.
Yes	No	N/A	11. All plant personnel are immunized for typhoid, tetanus, and hepatitis B.
Yes	No	N/A	12. No cross connections exist between a potable water supply and non-potable source.
Yes	No	N/A	13. Gas/explosion controls such as pressure-vacuum relief valves, no smoking signs, explosimeters, and drip traps are present near anaerobic digesters, enclosed screening or degritting chambers, and sludge-piping or gas-piping structures.
Yes	No	N/A	14. Facility has enclosed and identified all electrical circuitry.
Yes	No	N/A	15. Personnel are trained in electrical work to be performed as well as safety procedures.

Yes	No	N/A	16. Chlorine safety precautions are followed:
Yes	No	N/A	a. NIOSH-approved 30-minute air pack?
Yes	No	N/A	b. All standing chlorine cylinders chained in place?
Yes	No	N/A	c. All personnel trained in the use of chlorine?
Yes	No	N/A	d. Chlorine repair kit available?
Yes	No	N/A	e. Chlorine leak detector tied into plant alarm system?
Yes	No	N/A	f. Chlorine cylinders stored in adequately ventilated areas?
Yes	No	N/A	g. Ventilation fan with an outside switch?
Yes	No	N/A	h. Posted safety precautions?
Yes	No	N/A	i. Existing emergency SOP and/or RMP or SPCC?
Yes	No	N/A	17. Facility has complied with the six employer responsibilities for the Worker Right-to-Know Law (P.A. 83-240)
Yes	No	N/A	18. Emergency Action Plan on file with local fire department and appropriate emergency agency.
Yes	No	N/A	19. Laboratory safety devices (eyewash and shower, fume hood, proper labeling and storage, pipette suction bulbs) available.
Yes	No	N/A	20. Facility post warning signs (no smoking, high voltage, non-potable water, chlorine hazard, watch-your-step, and exit).

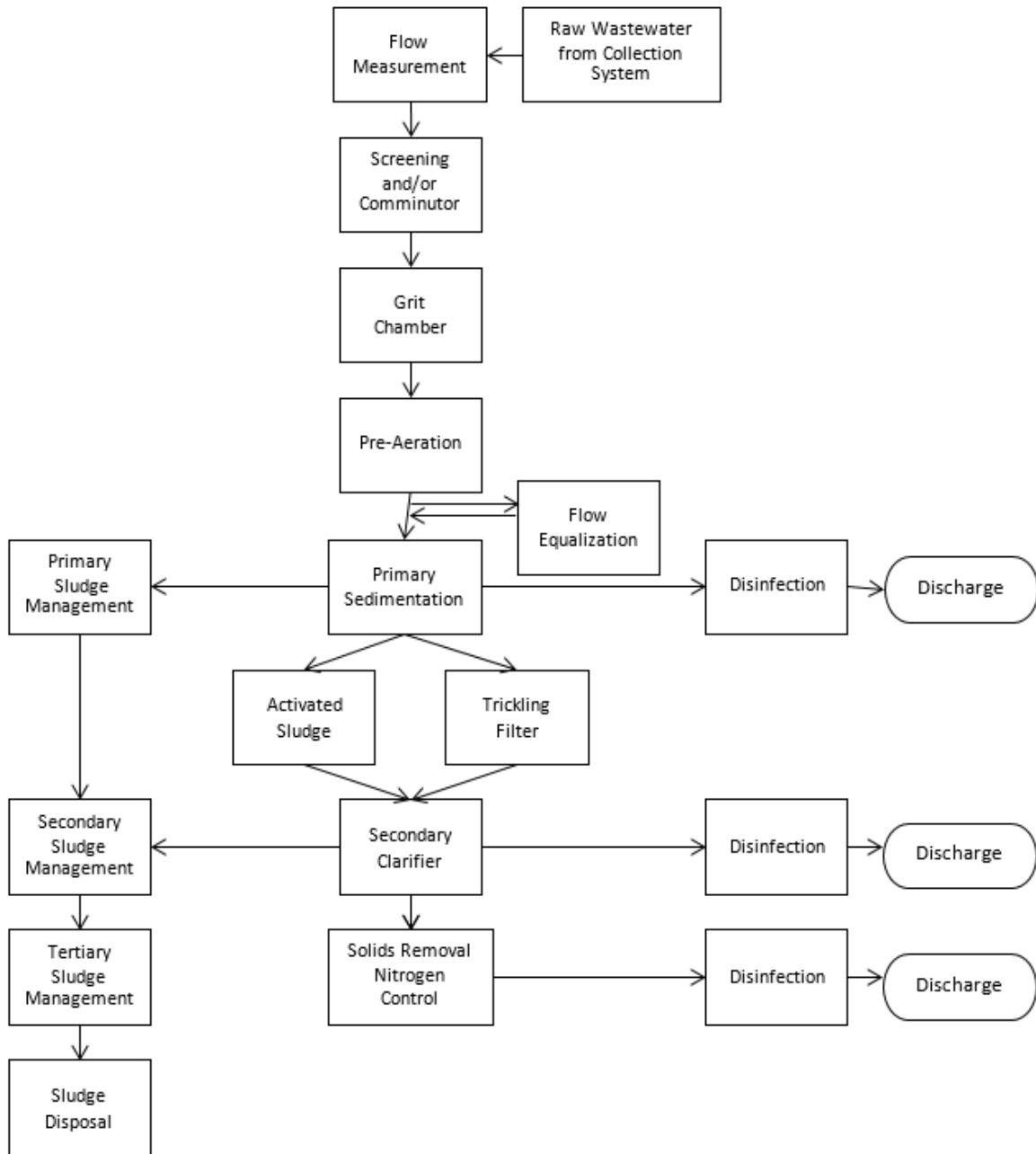

Exhibit 4-1. General Wastewater Treatment Flow Diagram

CHAPTER 5 – SAMPLING

Contents

A. Evaluation of Permittee Sampling Program and Compliance Sampling.....	99
Objectives and Requirements	99
Significant Industrial User Monitoring Program.....	100
Biosolids Monitoring Program.....	100
Toxicity Testing Program	100
StormWater Program	100
B. Sampling Procedures and Techniques.....	100
Wastewater Sample Collection Techniques.....	101
EPA Sample Identification Methods.....	106
Wastewater Sample Preservation and Holding Time.....	106
Transfer of Custody and Shipment of Samples	107
Quality Control	108
Quality Assurance Project Plan	112
Data Handling and Reporting	113
C. References.....	113
D. Permittee Sampling Inspection Checklist	115

List of Tables

Table 5-1. Compositing Methods.....	102
Table 5-2. Quality Control Procedures for Field Analysis and Equipment.....	110

Associated Appendices

- M. Example Chain-of-Custody Form
- N. Updated Fact Sheet: Department of Transportation Hazardous Materials Training

Related Websites

Agency-wide Quality System Documents: <https://www.epa.gov/quality/agency-wide-quality-system-documents>

A. EVALUATION OF PERMITTEE SAMPLING PROGRAM AND COMPLIANCE SAMPLING

Wastewater sampling/analysis is an integral part of the National Pollutant Discharge Elimination System (NPDES) Compliance Monitoring Program. NPDES permits contain specific and legally enforceable effluent limitations and monitoring requirements.

OBJECTIVES AND REQUIREMENTS

When evaluating the permittee sampling program, the inspector should:

- Verify that the permittee's sampling program complies with the permit.
- Verify that the permittee's sampling program complies with:
 - Title 40 of the *Code of Federal Regulations* (CFR), sections 136.1 to 136.6 and Appendices A, B, and C (Guidelines for Establishing Test Procedures for the Analysis of Pollutants) for wastewater samples; and 40 CFR Part 503.
- Document potential violations to support enforcement action.

In addition, specific objectives of the sampling conducted by inspectors include the following:

- Verify compliance with effluent limitations.
- Verify accuracy of reports and program self-monitoring.
- Support enforcement action.
- Support permit development reissuance and/or revision.
- Determine the quantity and quality of effluent.

Sampling, analysis, preservation technique, sample holding time, and sample container requirements are provided under 40 CFR Part 136 as authorized by section 304(h) of the Clean Water Act (CWA). Chapter 7 contains more information on required analytical procedures "Laboratory Analyses Techniques Evaluation." See the checklist for use in evaluating the permittee's sampling program at the end of this chapter.

For all NPDES permittees the inspector should perform a review of sampling procedures and quality control measures the facility uses to ensure the integrity of sample data.

To evaluate sampling procedures, assess the following eight areas:

- Sample site locations
- Sample collection techniques
- Field measurements
- Sample labeling (including locations) and documentation
- Sample preservation and holding time
- Transfer of custody and shipment of samples
- Quality control

- Data handling and reporting

SIGNIFICANT INDUSTRIAL USER MONITORING PROGRAM

It is the responsibility of the permitted Publicly Owned Treatment Works (POTW) with a pretreatment program to oversee sampling procedures of industrial users and to conduct compliance monitoring of its own. Therefore, during a Pretreatment Compliance Inspection (PCI) or audit, the inspector may also need to evaluate POTW sampling procedures for significant industrial users who discharge to the POTW in addition to evaluating the sampling procedures of any permitted POTW. According to the General Pretreatment Regulations, 40 CFR 403.12(o), industrial users and POTWs subject to 40 CFR 403.12 reporting requirements must maintain the following monitoring records:

- Date, exact place, method and time of sampling, and name of sampler
- Date of analysis
- Name of analyst
- Analytical techniques/methods used
- Analytical results

During a PCI or an audit, the inspector evaluates the POTW industrial user monitoring program with respect to the criteria specified in the POTW pretreatment program. Elements of the sampling scheme will include the eight areas addressed above and any other areas specifically addressed in the pretreatment program. Chapter 9 discusses the focus of this evaluation in greater detail.

BIOSOLIDS MONITORING PROGRAM

Chapter 10 discusses evaluation of a permittee's biosolids monitoring program. Lists of approved biosolids analytical methods, sample containers, preservation techniques, and holding times for biosolids samples can be found on EPA's website at:
<https://www.epa.gov/biosolids/additional-information-biosolids-managers#analytical>.

TOXICITY TESTING PROGRAM

Chapter 8 discusses evaluation of a permittee's Whole Effluent Toxicity testing program. In addition, for methods manuals for Whole Effluent Toxicity testing go to
<https://www.epa.gov/cwa-methods/whole-effluent-toxicity-methods>.

STORMWATER PROGRAM

Chapter 11 provides considerations for performing stormwater monitoring.

B. SAMPLING PROCEDURES AND TECHNIQUES

Whether an inspector is evaluating a permittee's sampling program or conducting compliance sampling on the permittee's effluent, that inspector must be familiar with the procedures and techniques necessary for accurate sampling of wastewaters. The following discussion details

the procedures for sample collection, preservation, sample transfer including chain-of-custody, quality control, and data handling.

WASTEWATER SAMPLE COLLECTION TECHNIQUES

Sample collection is an important part of the compliance monitoring program. Without proper sample collection procedures, the results of such monitoring programs are neither useful nor valid, even with the most precise and accurate analytical measurements.

Selection of Representative Sampling Sites

Normally, samples should be collected at the location specified in the permit. In some instances, the sampling location specified in the permit may not be adequate for the collection of a representative sample. In that case, the inspector should determine the most representative sampling point available and collect a sample at that location as well as the location specified by the permit (or chosen by the permittee). If the facility disagrees, the reason for the conflict must be documented for later resolution by the permitting authority.

Sample Types

Two types of sample techniques are used: grab and composite. For many monitoring procedures, the regulations at 40 CFR Part 136 do not specify sampling type. For these procedures, the NPDES permit writer determines the appropriate sample type based on the data objective, and/or the required analytical method and specifies the sampling technique in the NPDES permit.

Grab Samples. Grab samples are individual samples collected at a specific time not exceeding 15 minutes and are representative of the conditions at the time the sample is collected. The sample volume depends on the type and number of analyses to be performed. The collection of a grab sample is appropriate when a sample is needed to:

- Represent an effluent that does not discharge on a continuous basis.
- Provide information about instantaneous concentrations of pollutants at a specific time.
- Allow collection of a variable sample volume.
- Corroborate composite samples.
- Monitor parameters not amenable to compositing (e.g., pH, temperature, dissolved oxygen, chlorine, purgeable organics, oil and grease, coliform bacteria, and others specified by the NPDES permit, which may include phenols, sulfites, and hexavalent chromium).

Composite Samples. Composite samples are samples collected over time, either by continuous sampling or by mixing discrete samples. Composite samples represent the average characteristics of the wastestream during the compositing period. Composite samples are collected when:

- Average pollutant concentration during the compositing period is desired.
- Mass per unit time loadings are calculated.

- Wastewater characteristics are highly variable.

The four primary methods of composite sample collection are time compositing, flow proportion compositing, sequential compositing, and continuous compositing. Table 5-1 lists the advantages and disadvantages of these methods. The permit may specify which type of composite sample to use. Composite samples are collected either manually by combining multiple grab samples or by using automatic sampling equipment. Inspectors should consider variability in wastestream flow rate, parameter concentrations and the approved EPA methods when choosing compositing methods, sampling equipment (tubing and containers), and quality assurance procedures. The compositing methods are as follows:

- Time Composite Sample: This method requires discrete sample aliquots collected in one container at constant time intervals. This method is appropriate when the flow of the sampled stream is constant (flow rate does not vary more than ± 10 percent of the average flow rate) or when flow monitoring equipment is not available.

Table 5-1. Compositing Methods

Method	Advantages	Disadvantages	Comments
Time Composite			
Constant sample volume, constant time interval between samples.	Minimal manual effort; requires no flow measurement.	May lack representativeness for highly variable flows.	Widely used in both automatic and manual sampling.
Flow-Proportional Composite			
Constant sample volume, time interval between samples proportional to stream flow.	Minimal manual effort.	Requires accurate flow measurement reading equipment; manual compositing from flowchart.	Widely used in automatic as well as manual sampling.
Constant time interval between samples, sample volume proportional to total stream flow at time of sampling.	Minimal instrumentation.	Manual compositing from flowchart in absence of prior information on the ratio of minimum to maximum flow; chance of collecting too small or too large individual discrete samples for a given composite volume.	Used in automatic samplers and widely used as manual method.
Constant time interval between samples, sample volume proportional to total stream flow since last sample.	Minimal instrumentation.	Manual compositing from flow chart in absence of prior information on the ratio of minimum to maximum flow; chance of collecting too small or too large individual discrete samples for a given composite volume.	Not widely used in automatic samplers but may be done manually.

Table 5-1. Compositing Methods

Method	Advantages	Disadvantages	Comments
Sequential Composite			
Series of short period composites, constant time intervals between samples.	Useful if fluctuations occur and the time history is desired.	Requires manual compositing of aliquots based on flow.	Commonly used; however, manual compositing is labor intensive.
Series of short period composites, aliquots taken at constant discharge increments.	Useful if fluctuations occur and the time history is desired.	Requires flow totalizer; requires manual compositing of aliquots based on flow.	Manual compositing is labor intensive.
Continuous Composite			
Constant sample volume.	Minimal manual effort, requires no flow measurement highly variable flows.	Requires large sample capacity; may lack representativeness for highly variable flows.	Practical but not widely used.
Sample volume proportional to stream flow.	Minimal manual effort, most representative especially for highly variable sample volume, variable pumping capacity and power.	Requires accurate flow measurement equipment, large sample volume, variable pumping capacity, and power.	Not widely used.

- **Flow-Proportional Composite Sample**—in one method, a constant sample volume is collected at varying time intervals proportional to stream flow (e.g., 200 milliliters sample collected for every 5,000 gallons of flow). In the other method (which has two variations, see Table 5-1), the sample is collected by increasing the volume of each aliquot as the flow increases, while maintaining a constant time interval between the aliquots.
- **Sequential Composite Sample**—this method requires discrete samples collected in individual containers at constant time intervals or discharge increments; for example, samples collected every 15 minutes, composited into separate containers each hour. The discrete samples can then be manually flow-proportioned to form the composite sample. Alternatively, a constant sample volume is collected at constant discharge volume increments measured with a flow totalizer.
- **Continuous Composite Sample**—collect this sample continuously from the wastestream. The sample may be constant volume, or the volume may vary in proportion to the flow rate of the wastestream.

Influent Sample Collection. Document and take influent samples at points of high turbulence flow to ensure good mixing. In some instances, the most desirable location may not be accessible. Ensure sampling points are located prior to any internal facility return lines, and sampling equipment should be placed so that it does not interfere with flow measuring devices. The preferred sampling points for raw wastewater are at the most downstream location from the collection lines, but prior to preliminary treatment:

- Waste flowing from the last process in a manufacturing operation, for an industrial user.
- Pump wet well (if turbulent).
- Upstream collection lines, tank, or distribution box following pumping from the wet well or sump.
- Flume throat.
- Aerated grit chamber.
- Upstream siphon following the comminutor (in absence of grit chamber).

If it is not possible to sample at a preferred point, choose an alternative location and document the basis for choosing that location.

Effluent Sample Collection. Collect effluent samples at the location specified in the NPDES permit. Occasionally, municipal plant permits may specify sampling prior to chlorination. For these plants, monitor all parameters at the upstream location except fecal coliforms, pH, and total residual chlorine. Collect wastewater for use in bioassays at the location specified in the facility's NPDES permit.

Collect samples either manually (grab or composite) or with automatic samplers (continuous or composite). The following general guidelines apply when taking samples:

- Take samples at a location specified in the NPDES permit and/or at a location selected to yield a representative sample.
- Use the sampling method (grab, composite, continuous) specified in the permit. Some parameters that must be collected as an individual grab sample are dissolved oxygen, total residual chlorine, oil and grease, coliform bacteria, purgeable organics, sulfides, cyanide, and total phenols.
- Avoid collecting large nonhomogeneous particles and objects.
- Collect the sample facing upstream to avoid contamination.
- Do not rinse sample container with sample when collecting oil and grease and microbiological samples, but fill the container directly to within 2.5 to 5 cm from the top.
- Fill the container completely if the sample is to be analyzed for purgeable organics, oxygen, ammonia, hydrogen sulfide, free chlorine, pH, hardness, sulfite, ammonium, ferrous iron, acidity, or alkalinity.
- Collect sufficient volume to allow for quality assurance testing. (see EPA's website <https://www.epa.gov/cwa-methods> for a listing of all approved sampling methods. Each sampling method will indicate the required sampling equipment, sampling containers and sampling volume, but additional volumes may be necessary for quality assurance testing.)

The following general guidelines apply when using automatic samplers:

- Collect samples where the wastewater is well mixed. Collect the sample near the center of the flow channel at 0.4 to 0.6 depth (mid-depth).
- Obtain a sufficient volume of sample to perform all required analyses plus any additional amount for quality control. Individual portions of a composite sample should be at least 100 milliliters to minimize sampler solids bias.
- For automatic samplers that use a peristaltic pump, obtain adequate flow rates in the sampler tubing to effectively transport the suspended solids. To avoid solids bias, the velocity of the wastewater in sample tubing should be at least 2 feet per second (fps) and the tubing diameter should be at least 0.25 inch.
- Time of sample collection begins when the last aliquot is dispensed into the composite sample container.

Sample Volume

The volume of sample collected depends on the type and number of analyses needed, as reflected in the parameters to be measured. Obtain the volume of the sample sufficient for all the required analyses plus an additional amount to provide for any split samples or repeat analyses. EPA approved sampling methods provide a guide to sample volumes required for determining the constituents in wastewater (available at <https://www.epa.gov/cwa-methods>). Consult the laboratory receiving the sample for any specific volume required. EPA's *Methods for Chemical Analysis of Water and Wastes* (EPA, 1979a) and *Handbook for Sampling and Sample Preservation of Water and Wastewater* (EPA, 1982), and the current EPA-approved edition of *Standard Methods for the Examination of Water and Wastewater* (American Public Health Association (APHA), American Water Works Association (AWWA), and Water Environment Federation (WEF), 2013) contain specific recommended minimum sample volumes for different pollutant parameters.

Sample Containers

The regulations at 40 CFR Part 136 describe required sample containers, sample preservation, and sample holding time. EPA approved sampling methods indicate appropriate sample containers for each analysis. It is essential that the sample containers be made of chemically resistant material unaffected by the concentrations of the pollutants measured. In addition, sample containers must have a closure that will protect the sample from contamination. Collect wastewater samples for chemical analysis in plastic (polyethylene) containers. Exceptions to this general rule are oil and grease samples, pesticides, phenols, polychlorinated biphenyls (PCBs), and other organic pollutant samples. Collect these in properly cleaned glass jars or bottles and seal. Collect bacteriological samples in properly sterilized plastic or glass containers. Collect samples that contain constituents that will oxidize when exposed to sunlight (such as iron cyanide complexes) in dark containers.

Ensure sample containers are clean and uncontaminated. Check analytical procedures to determine if they specify container cleaning procedures. Use precleaned and sterilized disposable containers (e.g., polyethylene cubitainers). If these are not used or if the analytical

method does not specify procedures, use the following procedures for cleaning sample containers:

- Wash with hot water and detergent.
- Rinse with acid (e.g., nitric for metals).
- Rinse with tap water, then rinse three or more times with organic-free water.
- Rinse glass containers with an interference-free, redistilled solvent (such as acetone or methylene chloride for extractable organics).
- Dry in contaminant-free area.

EPA SAMPLE IDENTIFICATION METHODS

Identify each sample accurately and completely. Use labels or tags to identify the samples that are moisture-resistant and able to withstand field conditions. If moisture-resistant labels are not available, place a piece of tape over each label to prevent water damage. Use a waterproof pen to complete the labels or tags. A numbered label or tag associated with a field sample data sheet containing detailed information on the sample is preferable to using only a label or tag for information². The information for each sample should include the following:

- Facility name/location
- Sample site location
- Sample number
- Name of sample collector
- Date and time of collection
- Indication of grab or composite sample with appropriate time and volume information
- Identification of parameter to be analyzed
- If the sample is preserved and, if so, the preservative used

WASTEWATER SAMPLE PRESERVATION AND HOLDING TIME

In most cases, wastewater samples contain one or more unstable pollutants that require immediate (e.g., within 15 minutes) preservation and/or analysis. Provide appropriate chemical preservation before transferring samples to the laboratory. EPA approved sampling methods indicate appropriate sample preservation for each analysis (sampling methods are available at <https://www.epa.gov/cwa-methods>). Procedures used to preserve samples include cooling, pH adjustment, and chemical treatment. For some parameters, such as cyanide and phenols, add preservatives to sample bottles prior to or immediately following sample collection. For many samples, if preservatives are not appropriately used, bacteria can quickly degrade certain constituents (such as phenols and phosphorus). Other constituents may volatilize (such as volatile organics and sulfides) or may react to form different chemical species (hexavalent

² Note: Preprinted labels, data sheets, chain-of-custody forms, etc., can be done in the field using software developed by the Superfund Program.

chromium, for example). Proper preservation and holding times are essential to ensure sample integrity (see 40 CFR Part 136).

Analysis of samples within one day ensures against error from sample deterioration. However, such prompt analysis is not feasible for composite samples in which portions may be stored for as long as 24 hours. Where possible, provide sample preservation during compositing, usually by refrigeration to 6°C (or icing). If using an automatic sampler with ice, replace the ice as necessary to maintain low temperatures. This is a limitation of automatic samplers used during the summer when ice must be frequently replaced.

Table II of 40 CFR 136.3(e) indicates maximum sample holding times. Times listed are the maximum holding times between sample collection and analysis that are allowed for the sample to be considered valid. Unless otherwise specified in the method, holding time limitations begin upon combination of the last aliquot in a sample. When use of an automatic sampler makes it impossible to preserve each aliquot, the chemical samples may be preserved by maintaining at 6°C until compositing and sample splitting is completed (40 CFR 136.3(e)).

TRANSFER OF CUSTODY AND SHIPMENT OF SAMPLES

To ensure the validity of the permit compliance sampling data in court, written records must accurately trace the custody of each sample through all phases of the monitoring program (EPA Order 5360.1). The primary objective of this chain-of-custody is to create an accurate written record (see an example chain-of-custody form in Appendix M) that can be used to trace the possession and handling of the sample from the moment of its collection through its analysis and introduction as evidence. The following procedures are appropriate for the transfer of custody and shipment of samples:

- Use sample seals to protect the sample's integrity from the time of collection to the time it is opened in the laboratory, including the time the sample is within an automatic sampling apparatus, thus the automatic sampler should be sealed on the outside. The seal should indicate the collector's name, the date and time of sample collection, and sample identification number. For automatic samplers, seals should indicate the sample time at which the apparatus began sampling, as the sample container is subsequently sealed in the apparatus.
- Pack samples properly to prevent breakage. Seal or lock the shipping container to readily detect any evidence of tampering. Use of tamper-proof evidence tape is recommended.
- Place samples on ice or synthetic ice substitute that will maintain sample temperature at 6°C throughout shipment.
- The responsibility for proper packaging, labeling, and transferring of possession of the sample lies with the inspector. Accompany every sample with a sample tag and a chain-of-custody record that has been completed, signed, and dated. The chain-of-custody record should include the names of sample collectors, sample identification numbers, date and time of sample collection, location of sample collection, and names and signatures of all persons handling the sample in the field and in the laboratory.

- The originator retains a copy of the chain of custody forms. Also, the originator must retain all receipts associated with the shipment.
- EPA Inspectors with the responsibility of working with hazardous materials that are placed in commerce (transporting/shipping) must have hazardous materials training as required by the Department of Transportation (see Appendix N).
- When transferring possession of samples, the transferee must sign and record the date and time on the chain-of-custody record (use the currently approved record). In general, custody transfers are made for each sample, although samples may be transferred as a group, if desired. For each sample being transferred, the transferee should list the sample and their name on the custody record. Each person who takes custody must fill in the appropriate section of the chain-of-custody record. Both the transferee and person who takes custody of the sample(s) must sign the custody record.
- Pack and ship samples in accordance with applicable International Air Transportation Association (IATA) and/or DOT regulations.

QUALITY CONTROL

Conduct control checks during the actual sample collection to determine the performance of sample collection techniques. In general, the most common monitoring errors usually are improper sampling methodology, improper preservation, inadequate mixing during compositing and splitting, and excessive sample holding time. In addition, collect and analyze the following samples to check sample collection techniques:

Blanks

- Trip blank. Trip blanks are vial(s) filled at the laboratory with deionized water. The blank(s) follows the same handling and transport procedures as the samples collected during the event. The blank(s) functions as a check on sample contamination originating from sample transport, shipping and from site conditions.

Note: Expose the trip blank vial(s), to the same environmental conditions (light, temperature, etc.) of the sample vial(s) but do not open until it is time for analysis.

- Field blank/field reagent blank. Field blanks are similar to trip blanks except they are prepared in the field with deionized water exactly as the sample(s) that are collected. Field blanks are used to check for analytical artifacts and/or background introduced by sampling and analytical procedures.
- Temperature blank. A temperature blank is a small sample bottle filled with distilled water that is placed in each cooler prior to shipment. Upon arrival at the laboratory the temperature of the sample bottle is measured to evaluate if samples were adequately cooled during sample shipment.
- Equipment/rinsate blank. Collect an equipment/rinsate blank when using an automatic sampler or other non-dedicated equipment during the sampling process. The blank is a check of the equipment cleanliness. For automatic samplers, prepare blanks prior to collecting samples, by pumping deionized organic free water (rinsate) through the

sampler and collecting the discharge purge water in a sample container for analysis for the constituents of concern.

Field Duplicate. Collect a field duplicate sample simultaneously from the same source at selected stations on a random timeframe by grab samples or from two sets of field equipment installed at the site. Duplicate samples check analytical precision as well as evaluate the “representativeness” of the sample aliquot.

Split Samples. Split samples are samples that have been divided into two containers for analysis by separate laboratories. These samples provide an excellent means of identifying discrepancies in the permittee’s analytical techniques and procedures. When filling split samples from a single composite jug, shake the composited sample well and half fill the EPA sample container, then shake the composite again and fill half of the permittee’s container. Repeat the procedure for each parameter collected.

The laboratories performing the sample analyses should also use the following control measures:

Prep/Reagent Blank. A prep/reagent blank is a sample consisting of reagent(s), without the target analyte or sample matrix, introduced into the analytical procedure at the appropriate point and carried through all subsequent steps to determine the contribution of the reagents and to aid in identifying errors in the observed value that may result from the analytical steps.

Quality Control Sample. A quality control sample is an uncontaminated sample matrix spiked with known amounts of analytes from a source independent from the calibration standards. Use this sample to establish intra-laboratory or analyst specific precision and bias or to assess the performance of all or a portion of the measurements’ system.

Matrix Spike/Matrix Spike Duplicate (MS/MSD). A matrix spike/matrix spike duplicate sample is three times the normal volume required for a specific chemical analysis to which a known quantity of analyte has been added prior to all sample preparation. The laboratory utilizes the MS/MSD samples as part of their Quality Assurance/Quality Control Program.

- Use a matrix spike to verify accuracy of the analytical procedures.
- A matrix spike duplicate is a duplicate of a matrix spike sample. It measures the precision of the analysis in terms of relative percent difference.

Table 5-2 indicates quality control procedures for field analyses and equipment. Quality control is discussed in greater detail in Chapter 7 of this manual and EPA's *NPDES Compliance Inspector Training module: Laboratory Analyses* (EPA, 1990).

Table 5-2. Quality Control Procedures for Field Analysis and Equipment

Parameter	General	Daily	Other Frequency
Dissolved Oxygen			
Membrane Electrode	<ul style="list-style-type: none"> Enter the make, model, and serial and/or ID number for each meter in a logbook. Report data to nearest 0.1 mg/L. 	<ul style="list-style-type: none"> Calibrate meter using manufacturer's instructions or Winkler-Azide method. Check membrane for air bubbles and holes. Change membrane and Potassium chloride (KCl) solution if necessary. Check leads, switch contacts, etc., for corrosion and shorts if meter pointer remains off-scale. 	<ul style="list-style-type: none"> Annually, check instrument calibration and linearity using a series of at least three dissolved oxygen standards. Annually, take all meters to the laboratory for maintenance, calibration, and quality control checks.
Winkler-Azide Method	Record data to nearest 0.1 mg/L.	Duplicate analysis should be run as a precision check. Duplicate values should agree within ± 0.2 mg/l.	
pH			
Electrode Method	Enter the make, model, and serial and/or ID number for each meter in a logbook.	<ul style="list-style-type: none"> Calibrate the system against traceable standard buffer solutions of known pH value that closely brackets the actual sample pH (e.g., 4, 7, and 10 at the start of a sampling run). Periodically check the buffers during the sample run and record the data in the logbook. Be on the alert for erratic meter response arising from weak batteries, cracked electrodes, fouling, etc. Check response and linearity following highly acidic or alkaline samples. Allow additional time for equilibration. Check against the closest reference solution each time a violation is found. Rinse electrodes thoroughly between samples and after calibration. Blot dry. Store the probe in approved storage solution (e.g., KCl) 	

Table 5-2. Quality Control Procedures for Field Analysis and Equipment

Parameter	General	Daily	Other Frequency
Conductivity			
	Enter the make, model, and serial and/or ID number for each meter in a logbook.	<ul style="list-style-type: none"> Standardize with KCl standard solutions having similar specific conductance values to those anticipated in the samples. Calculate the cell constant using two different standards. Rinse cell after each sample to prevent carryover. 	<ul style="list-style-type: none"> Quarterly, take all meters to lab for maintenance, calibration, and quality control checks. Quarterly, check temperature compensation. Quarterly, check date of last platinizing, if necessary. Quarterly, analyze NIST or EPA reference standard solutions, and record actual vs. observed readings in the logbook.
Residual Chlorine			
Amperometric Titration	Enter the make, model, and ID and/or serial number of each titration apparatus in a logbook. Report results to nearest 0.01 mg/l.	Refer to instrument manufacturer's instructions for proper operation and calibration procedures.	Biweekly, return instrument to lab for maintenance and addition of fresh, standardized reagents.
Temperature			
Manual Thermometer	<ul style="list-style-type: none"> Enter the make, model, and serial and/or ID number and temperature range. All standardization should be against a traceable NIST or NIST calibrated thermometer. Reading should agree within $\pm 1^{\circ}\text{C}$. If enforcement action is anticipated, calibrate the thermometer before and after analysis. All data should be read to the nearest 1°C. Report data between 10° and 99°C to two significant figures. 	Check for air spaces or bubbles in the column, cracks, etc. Compare with a known source if available.	<ul style="list-style-type: none"> Initially and annually, determine accuracy throughout the expected working range of 0°C to 50°C. A minimum of three temperatures within the range should be used to verify accuracy. Preferably, the 3 temperature readings should be taken within the following ranges: $5\text{--}10^{\circ}\text{C}$, $15\text{--}25^{\circ}\text{C}$, and $35\text{--}45^{\circ}\text{C}$.
Thermistors, Thermographs	Enter the make, model, and serial and/or ID number of the instrument in a logbook. All standardization shall be against a NIST or NIST calibrated thermometer. Reading	Check thermistor and sensing device for response and operation according to the manufacturer's instruction. Record actual versus standard temperature in logbook.	Initially and annually, determine accuracy throughout the expected working range of 0°C to 50°C . A minimum of three temperatures within the range should be used to verify

Table 5-2. Quality Control Procedures for Field Analysis and Equipment

Parameter	General	Daily	Other Frequency
	should agree within $\pm 1^{\circ}\text{C}$. If enforcement action is anticipated, refer to the procedure listed above.		accuracy. Preferably, the 3 temperature readings should be taken within the following ranges: 5–10°C, 15–25°C, and 35–45°C.
Flow Measurement			
	Enter the make, model, and serial and/or ID number of each flow measurement instrument in a logbook.	Install the device in accordance with the manufacturer's instructions and with the procedures given in owner's manual.	Annually affix record of calibration (as per NIST standard or manufacturer's suggested standard) to the instrument log.
Automatic Samplers			
	Enter the make, model, and serial and/or ID number of each sampler in a logbook.		For each sampling event, check intake velocity vs. head (using a minimum of three samples), and clock time setting vs. actual time interval. Calibrate annually and record results in a logbook.

QUALITY ASSURANCE PROJECT PLAN

The EPA has developed the Quality Assurance Project Plan (QAPP) as a tool for project managers and planners to document the type and quality of data needed for the agency to make environmental decisions and to describe the methods for collecting and assessing those data. The QAPP is required for all EPA projects resulting in the generation, collection, and use of environmental data. The development, review, approval and implementation of the QAPP is an integral part of an Agency-wide Quality System, which is required per the authority of EPA Order 5360.1 A2.

If the EPA is to have confidence in the quality of data used to support environmental decisions, there must be a systematic planning process in place. A product of the systematic planning process is the QAPP. An example of the systematic planning process endorsed by the EPA is the Data Quality Objectives (DQO) Process. The QAPP ensures that the needed management and technical practices are in place so that environmental data used to support agency decisions are of adequate quality and usability for their intended purpose.

Prior to the start of data collection, a QAPP defining the goals and scope of the project, the need for sample collection, a description of the data quality objectives and QA/QC activities to ensure data validity and usability must be developed by the project officer. Thereafter, a review by all parties to the sampling effort, such as a Quality Assurance (QA) Officer, must be conducted. Also, EPA laboratories will require a copy of an approved QAPP prior to conducting any sample analysis. This QAPP requirement applies to both EPA staff and outside contractors. The process for approval of the QAPP and other documents related to the data collection activity should be outlined in the lead organization's Quality Management Plan (QMP).

For further information on QAPP's please visit the Office of Environmental Information (OEI) web page at: <https://www.epa.gov/quality/agency-wide-quality-system-documents>.

DATA HANDLING AND REPORTING

Verified analytical results are normally entered into a laboratory data management system of some type. The system should contain the sampling data, including time and exact location, analysis dates and times, names of analysts, analytical methods/techniques used, and analytical results. Data are then reported to the inspector for inclusion into the compliance report. The quality assurance manual by EPA (EPA, 1979b) and the article by J.J. Delfino (Delfino, 1977) provide useful information to the inspector on many data management techniques.

C. REFERENCES

The following is a list of resources providing additional information on sampling.

- American Public Health Association (APHA), American Water Works Association (AWWA), and World Economic Forum (WEF). (2013). *Standard Methods for the Examination of Water and Wastewater*.
- Associated Water and Air Resources Engineers, Inc. (1973). *Handbook for Industrial Wastewater Monitoring*. USEPA Technology Transfer.
- Delfino, J.J. (1977). "Quality Assurance in Water and Wastewater Analysis Laboratories." *Water and Sewage Works*, 124(7), 79-84.
- Federal Register. (1984). *Guidelines Establishing Test Procedures for the Analysis of Pollutants Under the Clean Water Act; Final Rule and Interim Final Rule and Proposed Rule*. Vol. 49, No. 209.
- Harris, D.J., and Keffer, W.J. (1974). *Wastewater Sampling Methodologies and Flow Measurement Techniques*. U.S. Environmental Protection Agency Region VII. EPA-907/9-74-005.
- Lauch, R.P. (1975). *Performance of ISCO Model 1391 Water and Wastewater Sampler*. U.S. Environmental Protection Agency. EPA-670/4-75-003.
- Lauch, R.P. (1976). *A Survey of Commercially Available Automatic Wastewater Samplers*. U.S. Environmental Protection Agency. EPA-600/4-76-051.
- Shelley, P.E. (1975). *Design and Testing of a Prototype Automatic Sewer Sampling System*. Office of Research and Development, U.S. Environmental Protection Agency. EPA 600/2-76-006.
- Shelley, P.E., and Kirkpatrick, G.A. (1975). *An Assessment of Automatic Sewer Flow Samplers*. Office of Research and Development, U.S. Environmental Protection Agency. EPA-600/2-75-065.

- U.S. Environmental Protection Agency. (1978). *Methods for Benzidine, Chlorinated Organic Compounds, Pentachlorophenol and Pesticides in Water and Wastewater*. Environmental Monitoring and Support Laboratory, Cincinnati, Ohio.
- U.S. Environmental Protection Agency. (1979a). *Methods for Chemical Analysis of Water and Wastes*. EPA-600/4-79-020.
- U.S. Environmental Protection Agency. (1979b). *Handbook for Analytical Quality Control in Water and Wastewater Laboratories*. EPA-600/4-79-019.
- U.S. Environmental Protection Agency. (1979c). *NPDES Compliance Sampling Inspection Manual*. MCD-51.
- U.S. Environmental Protection Agency. (1981). *Methods for Organic Chemical Analysis of Water and Wastes by GC, HPLC and GC/MS*. Environmental Monitoring Support Laboratory, Cincinnati, Ohio.
- U.S. Environmental Protection Agency. (1982). *Handbook for Sampling and Sample Preservation of Water and Wastewater*. EPA-600/4-82-029.
- U.S. Environmental Protection Agency. (1990). *NPDES Compliance Monitoring Inspector Training Module: Laboratory Analysis*. EPA 833-R-90-103.
- U.S. Environmental Protection Agency. (2000a). *Manual for the Evaluation of Laboratories Performing Aquatic Toxicity Tests*. EPA-600/4-90/031.
- U.S. Environmental Protection Agency. (2000b). *Guidance for the Data Quality Objectives Process (G-4)*. EPA-600/R-96/055.
- U.S. Environmental Protection Agency. (2002a). *Methods for Measuring the Acute Toxicity of Effluents and Receiving Waters to Freshwater and Marine Organisms*. EPA 821-R-02-012.
- U.S. Environmental Protection Agency. (2002b). *Short-term Methods for Estimating the Chronic Toxicity of Effluents and Receiving Waters to Freshwater Organisms*. EPA 821-R-02-013.
- U.S. Environmental Protection Agency. (2002c). *Short-term Methods for Estimating the Chronic Toxicity of Effluents and Receiving Waters to Marine and Estuarine Organisms*. EPA 821-R-02-014.
- U.S. Environmental Protection Agency. (2002d). *Guidelines Establishing Test Procedures for the Analysis of Pollutants; Whole Effluent Toxicity Test Methods; Final Rule*. 40 CFR Part 136.
- U.S. Environmental Protection Agency. (2001- Reissued May 21, 2006). *EPA Requirements for QA Project Plans (QA/R-5)*. EPA-240/B-01/003.

Wood, L.B., and Stanbridge, H.H. (1968). "Automatic Samplers," Water Pollution Control, 67(5): 495-520.

D. PERMITTEE SAMPLING INSPECTION CHECKLIST

A. PERMITTEE SAMPLING EVALUATION			
Yes	No	N/A	1. Take samples at sites specified in permit.
Yes	No	N/A	2. Locations adequate for representative samples.
Yes	No	N/A	3. Flow proportioned samples obtained when required by permit.
Yes	No	N/A	4. Complete sampling and analysis on parameters specified by permit.
Yes	No	N/A	5. Conduct sampling and analysis in frequency specified by permit.
Yes	No	N/A	6. Permittee uses method of sample collection required by permit. Required method: _____ If not, method being used is: () Grab () Manual Composite () Automatic Composite
Yes	No	N/A	7. Sample collection procedures adequate: a. Samples refrigerated during compositing. b. Proper preservation techniques used. c. Containers and sample holding times before analyses conform to 40 CFR 136.3. d. Samples analyzed in timeframe needed.
Yes	No	N/A	
Yes	No	N/A	
Yes	No	N/A	
Yes	No	N/A	8. Facility performs monitoring and analyses more often than required by permit; if so, results reported in permittee's self-monitoring report.
Yes	No	N/A	9. Samples contain chlorine.
Yes	No	N/A	10. Use contract laboratory for sample analysis.
Yes	No	N/A	11. POTW collects samples from industrial users in pretreatment program.
B. SAMPLING INSPECTION PROCEDURES AND OBSERVATIONS			
Yes	No	N/A	1. Obtain grab samples.
Yes	No	N/A	2. Obtain composite sample. Compositing Frequency: _____ Preservation: _____
Yes	No	N/A	3. Refrigerate sample during compositing.
Yes	No	N/A	4. Obtain flow-proportioned sample.
Yes	No	N/A	5. Obtain sample from facility sampling device.
Yes	No	N/A	6. Sample representative of volume and nature of discharge.
Yes	No	N/A	7. Sample split with permittee.
Yes	No	N/A	8. Employ chain-of-custody procedures.
Yes	No	N/A	9. Samples collected in accordance with permit.
Yes	No	N/A	10. Observe excessive foam, grease, floating solids at the outfall.

C. AUTOMATIC SAMPLER PROCEDURES AND OBSERVATIONS			
Yes	No	N/A	1. Sample intake tubing place in a well-mixed, representative location (0.4 to 0.6 depth).
Yes	No	N/A	2. Individual aliquot volume checked and at least 100ml.
Yes	No	N/A	3. Proper sample tubing (Teflon™ for organics, otherwise Tygon®) and tubing at ID at least 0.25 inch.
Yes	No	N/A	4. Proper composite sample container (glass for organics, otherwise plastic.
Yes	No	N/A	5. Proper refrigeration (6°C or ice), with required documentation.
Yes	No	N/A	6. Proper wastewater velocity in the sample tubing (at least 2 fps).

CHAPTER 6 – FLOW MEASUREMENT

Contents

A. Evaluation of Permittee's Flow Measurement.....	118
Objective and Requirements.....	118
Evaluation of Facility Installed Flow Devices and Data	118
Evaluation of Permittee Data Handling and Reporting	120
Evaluation of Permittee Quality Control	121
B. Flow Measurement Compliance	121
Objectives	121
Flow Measurement System Evaluation.....	121
Closed Conduit Evaluation Procedures	123
Primary Device Inspection Procedures	123
Secondary Device Inspection Procedures	126
C. References.....	129
D. Flow Measurement Inspection Checklist.....	131

Associated Appendices

- O. Supplemental Flow Measurement Information

A. EVALUATION OF PERMITTEE'S FLOW MEASUREMENT

OBJECTIVE AND REQUIREMENTS

To comply with the permit requirements established under the National Pollutant Discharge Elimination System (NPDES), the permittee must accurately determine the quantity of wastewater being discharged. Discharge flow measurement is an integral part of the NPDES program, it is important that the inspector evaluate the accuracy of the measurement.

In addition to providing usable information for enforcement purposes, flow measurement serves to:

- Provide data for pollutant mass loading calculations.
- Provide operating and performance data on the wastewater treatment plant.
- Compute treatment costs, based on wastewater volume.
- Obtain data for long-term planning of plant capacity, versus capacity used.
- Provide information on Infiltration and Inflow (I/I) conditions, and the need for cost-effective I/I correction.

A Flow Measurement Inspection Checklist for the inspector's use appears at the end of this chapter.

EVALUATION OF FACILITY INSTALLED FLOW DEVICES AND DATA

There are two types of wastewater flow: closed-channel flow and open-channel flow. Closed-channel flow occurs under pressure in a liquid-full conduit (usually a pipe). The facility will usually have a metering device inserted into the conduit that measures flow. Examples of closed-channel flow measuring devices are the Venturi meter, the Pitot tube, the paddle wheel, the electromagnetic flowmeter, Doppler, and the transit-time flowmeter. In practice, closed-channel flow is normally encountered between treatment units in a wastewater treatment plant, where liquids and/or sludges are pumped under pressure.

Open-channel flow occurs in conduits that are not liquid-full. Open-channel flow is partially full pipes not under pressure. Open-channel flow is the most prevalent type of flow at NPDES-regulated discharge points. Open-channel flows are typically measured using primary and secondary devices. Primary devices are standard hydraulic structures, such as flumes and weirs that are inserted in the open channel. Inspectors can obtain accurate flow measurements merely by measuring the depth of liquid (head) at the specific point in the primary device. In a weir application, for example, the flow rate is a function of the head of liquid above the weir crest.

Facilities use secondary devices in conjunction with primary devices to automate the flow measuring process. Typically, secondary devices measure the liquid depth in the primary device and convert the depth measurement to a corresponding flow, using established mathematical relationships. Examples of secondary devices are gauges, floats, ultrasonic transducers, bubblers, and transit-time flowmeters. A recorder generally measures the output of the

secondary device transmitted to a recorder and/or totalizer to provide instantaneous and historical flow data to the operator. Outputs may also be transmitted to sampling systems to facilitate flow proportioning. Appendix O, “Supplemental Flow Measurement Information,” contains further information on flow measurement devices.

The inspector must assure that the permittee obtains accurate wastewater flow data to calculate mass loading (quantity) from measured concentrations of pollutants discharged as required by many NPDES permits. The permittee must produce data that meet requirements in terms of precision and accuracy. Precision refers to data reproducibility or the ability to obtain consistent data from repeated measurements of the same quantity. Accuracy refers to the agreement between the amount of a component measured by the test and the amount present.

The accuracy of flow measurement (including both primary and secondary devices) varies widely with the device, its location, environmental conditions, and other factors such as maintenance and calibration. Faulty fabrication, construction, and installation of primary devices are common sources of errors. Improper calibration, misreading, and variation in the speed of totalizer drive motors are major errors related to secondary devices (see Appendix O, “Supplemental Flow Measurement Information”). When evaluating facility installed devices, the inspector should do the following:

- Verify that the facility has installed primary and/or secondary devices according to the manufacturer's manual instructions.
- Inspect the primary device for evidence of corrosion, scale formation, or solids accumulation that may bias the flow measurement.
- Verify that weirs are level, plumb, and perpendicular to the flow direction.
- Verify that flumes are level and smooth-finished, the throat walls (narrowed section of flume) are plumb, and the throat width is the standard size intended.
- Inspect historical records (i.e., strip charts and logs) for evidence of continuous flow measurements and for routine and maintenance operations schedules. Compare periods of missing data with maintenance logs for explanations of measuring system problems.
- Observe the flow patterns near the primary device for excessive turbulence, velocity, or accumulating foam. The flow lines should be straight.
- Ensure that the flow measurement system or technique being used measures the entire wastewater discharge as required by the NPDES permit. Inspect carefully the piping to determine whether there are any wastewater diversions, return lines, or bypasses around the system. Make sure the system meets the permit requirement, such as instantaneous or continuous, daily, or other time interval measures. Note anomalies in the inspection report.
- Verify that the site chosen for flow measurement by the facility is appropriate and is in accordance with permit requirements.

- Verify that the site chosen by the facility for flow measurement is suitable for the type of discharge, flow range, suspended solids concentration, and other relevant factors.
- Determine if the facility has closed-channel flow measuring devices where the pipe is always full. If these devices are used, then there must also be a means for the permittee and regulatory agencies/inspector to verify the accuracy of these meters. Primary open-channel flow measuring devices such as weirs and flumes should be used in an open-channel segment above or below the closed-channel segment to verify the flow measured by the closed-channel flow measuring devices.
- Verify that the facility uses appropriate tables, curves, and formulas to calculate flow rates.
- Review and evaluate calibration and maintenance programs for the discharger's flow measurement system. The permit normally requires the facility to check the calibration regularly by the permittee. The facility must ensure that their flow measurement systems are calibrated by a qualified source at least once a year to ensure their accuracy. Lack of such a program is considered unacceptable for NPDES compliance purposes.
- Verify that the facility calibrates secondary flowmeter systems to be within 10 percent of the primary flow measurement system.
- Verify that primary and secondary devices are adequate for normal flow as well as maximum expected flows. Note whether the flow measurement system can measure the expected range of flows.
- Collect accurate flow data during inspection to validate self-monitoring data collected by the permittee.
- The facility must install a flow measuring system that has the capability of routine flow verification by the permittee or appropriate regulatory personnel.

EVALUATION OF PERMITTEE DATA HANDLING AND REPORTING

The permittee or facility must keep flow measurement records for a minimum period of three years. Many flow-measuring devices produce a continuous flowchart for plant records. Flow records should contain date, flow, time of reading, and operator's name. The facility should record maintenance, inspection dates, and calibration data.

The inspector should review the permittee's records and note the presence or absence of data such as:

- Frequency of routine operational inspections.
- Frequency of maintenance inspections.
- Frequency of flowmeter calibration (should be as specified in permit, generally at least once per year).
- Irregularity or uniformity of flow.

EVALUATION OF PERMITTEE QUALITY CONTROL

The inspection should evaluate the following quality control issues during a compliance inspection to ensure:

- Proper operation and maintenance of equipment
- Accurate records
- Sufficient inventory of spare parts
- Valid flow measurement techniques
- Precise flow data
- Adequate frequency of calibration checks

Evaluate precision of float driven flow meters when flows are stable. Push the float gently downward, hold for 30 seconds, then allowed to return normally. The recorded flow rate should be the same before and after the float was moved. Evaluate accuracy by measuring the instantaneous flow rate at the primary device used at the facility and comparing the value against the value on the meter, graph, integrator, or company record. The difference between two stable totalizer readings (flow is steady for 10 minutes or more) should not exceed ± 10 percent of the instantaneous flow measured at the primary device. Note that most flow measurement systems have both an instantaneous meter readout and a totalizer. Both devices should agree, but that is not always the case due to electrical and other various malfunctions in the flow measuring system. In most cases, the totalizer reading will be what is reported by the permittee. If this is the case, then that device should be checked for accuracy and the permittee's flow measuring system rated accordingly.

In addition, the inspector can evaluate accuracy by installing a second flow measurement system, sometimes referred to as a reference system. Agreement in measured flow rates between the two systems should be within ± 10 percent of the reference rate if all conditions are as recommended for the systems.

B. FLOW MEASUREMENT COMPLIANCE

OBJECTIVES

The current NPDES program depends heavily on the permittee's submittal of self-monitoring data. The flow discharge measured during the NPDES compliance inspection should verify the flow measurement data collected by the permittee, support any enforcement action that may be necessary, and provide a basis for reissuing or revising the NPDES permit.

FLOW MEASUREMENT SYSTEM EVALUATION

The responsibility of the inspector includes collecting accurate flow data during the inspection and validating data collected during the permittee's self-monitoring.

The NPDES inspector must check both the permittee's flow data and the flow measurement system to verify the permittee's compliance with NPDES permit requirements. If a flow-measuring device is located below ground or in confined space, inspectors are not to enter

confined spaces unless trained and permitted to do so. When evaluating a flow measurement system, the inspector should consider and record findings on the following:

- Whether the system measures the entire discharge flow.
- The system's accuracy and good working order. This will include a thorough physical inspection of the system and comparison of system readings to actual flow or those obtained with calibrated portable instruments.
- The need for new system equipment.
- The existence or absence of a routine calibration and maintenance program for flow measurement equipment.

If the permittee's flow measurement system is accurate within ± 10 percent, the inspector should use the installed system. If the flow sensor or recorder is found to be inaccurate, the inspector should determine whether the equipment can be corrected in time for use during the inspection. If the equipment cannot be repaired in a timely manner, use the portable flow sensor and recorder used to assess the accuracy of the permittee's system for the duration of the inspection. If nonstandard primary flow devices are being used, request the permittee to supply data on the accuracy and precision of the method being employed.

For flow measurement in pipelines, the inspector may use a portable flowmeter. The inspector should select a flowmeter with an operating range wide enough to cover the anticipated flow to be measured. The inspector should test and calibrate the selected flowmeter before use. The inspector should select the site for flow measurement according to permit requirements and install the selected flowmeter according to the manufacturer's specifications. The inspector should use the proper tables, charts, and formulas as specified by the manufacturer to calculate flow rates.

Four basic steps are involved in evaluating the permittee's flow measurement system:

- Physical inspection of the primary device
- Physical inspection of the secondary device and ancillary equipment
- Flow measurement using the primary/secondary device combination of the permittee
- Certification of the system using a calibrated, portable instrument

Facilities with a closed pipe flow measurement system present a challenge to the inspector. Have the facility personnel explain the operation of the system and how they calibrate the flow measurement system. Check if it is calibrated yearly at a minimum. It is suggested that the facility conduct periodic monthly checks of the flow measurement system. The inspector can do a calibration of the closed pipe flow measurement systems in the following ways:

1. If an open-channel primary device is maintained at the facility the inspector can obtain an instantaneous head reading to verify the accuracy of the closed channel flow measuring system. Flow should be within ± 10 percent of the closed channel system.

2. The inspector can use a portable flow meter (usually consists of two strap-on sensors that mount on the pipe and utilize the Doppler principle) to verify the accuracy of the facility's flow measurement system by conducting side-by-side comparisons. Flow should be within ± 10 percent.
3. Confirm that the calibration procedure demonstrated by the facility's calibration personnel is adequate.

The following sections present procedures for inspecting the more common types of primary and secondary devices, for measuring flow using common permanent and portable systems, and for evaluating flow data. Please note that the number of primary/secondary device combinations is limitless; therefore, it is not feasible to provide procedures for all systems. When encountering systems other than those discussed here the inspector should consult the manufacturer's manual or facility personnel for advice on how the flow-measurement system operates before preparing a written inspection procedure.

CLOSED CONDUIT EVALUATION PROCEDURES

For closed-channel flow, the inspector performs the following checks on the system:

- Check for straight pipe runs of sufficient length both upstream (8–10 inches) and downstream (4–6 inches) of the measuring device.
- Determine if the meter size is appropriate for pipe diameter and flow ranges based on equipment manufacturer literature.
- Determine frequency of cleaning of pressure taps.

PRIMARY DEVICE INSPECTION PROCEDURES

The two most common open-channel primary devices are sharp-crested weirs and Parshall flumes. Common sources of error when using them include the following:

- Faulty fabrication—weirs may be too narrow or not "sharp" enough. Flume surfaces may be rough, critical dimensions may exceed tolerances, or throat walls may not be vertical.
- Improper installation—the facility may install weirs and flumes too near pipe elbows, valves, or other sources of turbulence. The devices may be out of level or plumb.
- Sizing errors—the primary device's recommended applications may not include the actual flow range.
- Poor maintenance—primary devices corrode and deteriorate. Debris and solids may accumulate in them. Specific inspection procedures for the sharp-crested weir, the Parshall flume, and the Palmer-Bowlus flume devices follow.

Sharp-Crested Weir Inspection Procedures

- Inspect the upstream approach to the weir.
 - Verify that the weir is perpendicular to the flow direction.

- Verify that the approach is a straight section of conduit with a length at least 20 times the maximum expected head of liquid above the weir crest.
- Observe the flow pattern in the approach channel. The flow should occur in smooth stream lines without velocity gradients and turbulence.
- Check the approach, particularly near the weir, for accumulated solids, debris, or oil and grease. The approach must have no accumulated matter.
- Inspect the sharp-crested weir.
 - Verify that the crest of the weir is level across the entire conduit traverse.
 - Measure the width of the weir crest. The edge of the weir crest should be no more than 1/8-inch thick.
 - Make certain the weir crest corresponds to zero-gauge elevation (zero output on the secondary device).
 - Measure the angle formed by the top of the crest and the upstream face of the weir. This angle must be 90 degrees.
 - Measure the chamfer (beveled edge) on the downstream side of the crest. The chamfer should be approximately 45 degrees.
 - Visually survey the weir-bulkhead connection for evidence of leaks or cracks that permit bypass.
 - Measure the height of the weir crests above the channel floor. The height should be at least twice the maximum expected head (2H) of liquid above the crest.
 - Measure the width of the end contraction. The width should be at least twice the maximum expected head (2H) of the liquid above the crest.
 - Confirm the location of the head-measuring device. The device should be located upstream of the weir at a point at least four times the maximum head.
 - Inspect the weir for evidence of corrosion, scale formation, or clinging matter. The weir must be clean and smooth.
 - Observe flow patterns on the downstream side of the weir. Check for the existence of an air gap (ventilation) immediately adjacent to the downstream face of the weir. Ventilation is necessary to prevent a vacuum that can induce errors in head measurements. Also, ensure that the crest is higher than the maximum downstream level of water in the conduit.
 - Verify that the nappe is not submerged and that it springs free of the weir plate.
 - If the weir contains a V-notch, measure the apex angle. The apex should range from 22.5 degrees to 90 degrees. Verify that the head is between 0.2 and 2.0 feet. The weir should not be operated with a head of less than 0.2 feet since the nappe may not spring clear of the crest.

King's *Handbook of Hydraulics* (King, 1963) frequently referenced throughout this chapter, provides a detailed discussion on weirs.

Parshall Flume Inspection Procedures

- Inspect the overall flume design.
 - Check that the flume is in a straight section of the conduit.
 - Check that the flume design is symmetrical and level in the transverse and translational directions.
 - Check that the flume is smooth-finished and constructed using a corrosion resistant material.
 - Measure the dimensions of the flume. Dimensions are strictly prescribed as a function of throat width (see Figure O-5 in Appendix O for critical dimensions).
 - Measure the head of liquid in the flume at two-thirds upstream of the throat in the convergence section and compare with the acceptable ranges in Table O-4 in Appendix O.
 - Check that the flow at the entrance is free of turbulence or "white" water. Flows should be laminar through the flume with uniform velocities across the width of the flume. Smaller flumes should have velocities less than 0.5 meters per second. Larger flumes should have velocities less than 2 meters per second.

- Inspect the flume approach (convergent section).
 - Confirm that the upstream channel is straight, horizontal, and of a uniform cross-section for a distance that is at least ten times the flume throat width.
 - Verify that the mouth of the convergent section is as wide as the channel and that the convergent section is merged flushed against the channel wall with rounded transitions (smooth transition between convergent section and channel wall—i.e., no sharp edges) to avoid turbulence in the flow.
 - Check that the upstream channel is free of accumulated matter. Accumulated matter may be indicative of oversizing of the flume or an incorrect setting of the flume in the channel.
 - Confirm that the location of the liquid measuring device is two-thirds upstream of the throat in the convergence section.

- Inspect the flume discharge (divergent section).
 - Check that the design of the downstream channel is low enough to allow free discharge conditions in the divergent section of the flume.
 - Check that the downstream channel is also free of accumulated matter.
 - Verify that the head of water in the discharge is not restricting flow through the flume. There should not be any obstruction, constriction, or channel turns in the divergent section that may cause the flow to back up in the flume. The existence of a "standard wave" is good evidence of free flow and verifies that there is no submergence present. This must be accounted for in the calculation of flow rate through the flume as described in the next section.

- Determine whether submergence occurs at or near maximum flow (e.g., look for water marks on the wall).

Palmer-Bowlus Flume Inspection Procedures

- Inspect the overall flume design as outlined above. These flumes are seldom used for effluent flow measurement.
- Inspect the flume.
 - The flume should be in a straight section of the conduit.
 - Flow at the entrance should be free of "white" water.
 - Observe the flow in the flume. The profile should approximate that depicted in Figure O-8 in Appendix O.
 - The flume should be level in the transverse direction and should not exceed the translational slope in Table O-6 in Appendix O.
 - Measure the head of water in the flume. Head should be within the ranges specified in Table O-6 in Appendix O.
- Inspect the flume discharge.
 - Verify that free flow exists. Look for the characteristic "standing wave" in the divergent section of the flume.

Venturi Meter Inspection Procedures

- Verify that the facility installed the Venturi meter according to manufacturer's instructions.
- Verify that the facility installed the Venturi meter downstream from a straight and uniform section of pipe, at least 5 to 20 diameters, depending on the ratio of pipe to throat diameter and whether straightening vanes are installed upstream. (Installation of straightening vanes upstream will reduce the upstream piping requirements.)
- Verify that the pressure measuring taps are free of debris and are not plugged.
- Verify the facility calibrated the Venturi meter in place by either the volumetric method or the comparative dye dilution method to check the manufacturer's calibration curve or to develop a new calibration curve.

SECONDARY DEVICE INSPECTION PROCEDURES

The following are common sources of error in the use of secondary devices:

- Improper location—gauge is in the wrong position relative to the primary device.
- Inadequate maintenance—gauge is not serviced regularly.
- Incorrect zero setting—zero setting of gauge is not the zero point of the primary device.
- Operator error—human error exists in the reading.

Flow Measurement Procedures in Weir Applications

- Determine that the head measurement device is positioned 3 to 4 head lengths upstream of a weir.
- Verify that the zero or other point of the gauge is equal to that of the primary device.

The inspector should use an independent method of measuring head, such as with a yardstick or carpenter's rule (be sure to take your measurement at least four times the maximum head upstream and from the weir and convert to nearest hundredth of a foot). To determine flow rate, use the appropriate head discharge relationship formula (see Table O-1 in Appendix O).

Flow Measurement Procedures in Parshall Flume Applications

Flow Measurement—Free-Flow Conditions.

- Determine upstream head (H_a) using staff gauge.
 - Verify that staff gauge is set to zero head. Use either a yardstick or carpenter's rule.
 - Verify that staff gauge is at proper location (two-thirds the length of the converging section back from the beginning of the throat).
 - Read to nearest division the gauge division at which liquid surface intersects gauge.
 - Read H_a in feet from staff gauge.
- To determine flow rate, use Figure N-6 in Appendix O in the unit desired, use tables published in flow measurement standard references, or calculate using the coefficients in Table O-5 in Appendix O.

Flow Measurement—Submerged-Flow Condition.

Generally, it is difficult to make field measurements with submerged-flow conditions. In cases when measurements can be obtained (using a staff or float gauge), the procedures listed below should be followed:

- Determine upstream head using staff or float gauge.
 - Read to nearest division and, at the same time as for H_b , the gauge division at which liquid surface intersects gauge.
 - Calculate H_a from gauge reading.
- Determine downstream head (H_b) using staff or float gauge.
 - H_b refers to a measurement at the crest.
 - Read to nearest division, and at the same time as for H_a , the gauge division at which liquid surface intersects gauge.
 - Calculate H_b from staff reading.
- Determine flow rate.
 - Calculate percent submergence:

$$\left[\frac{H_b}{H_a} \right] \times 100$$

- Consult Table O-6 in Appendix O.
- When a correction factor is obtained, use H_a and find free-flow from Figure I-6.
- Multiply this free-flow value by the correction factor to obtain the submerged flow.

The inspector may use an independent method of measuring head, such as a yardstick or carpenter's rule at the proper head measurement point. Because of the sloping water surface in the converging section of a flume, it is essential that the proper head measurement point be used.

Flow Measurement in Palmer-Bowlus Flume Applications

- Obtain head measurements as in the Parshall Flume application, using the secondary device. The head is the height of water above the step. The total depth upstream of the step is not the head.
- Refer to manufacturer-supplied discharge tables to convert head measurements to flow data. Palmer-Bowlus flumes, unlike Parshall flumes, are not constructed to standard dimensional standards. The inspector must not use discharge tables supplied by other manufacturers.

Verification

Most flow measurement errors result from inadequate calibration of the flow totalizer, and recorder. If the inspector has determined that the primary device has been installed properly, verification of the permittee's system is relatively simple. Compare the flow determined from the inspector's independent measurement to the flow of the permittee's totalizer or recorder. The permittee's flow measurements should be within 10 percent of the inspector's measurements to certify accurate flow measurement. Optimally, flow comparisons should be made at various flow rates to check system accuracy.

When the permit requires that the daily average flow be measured by a totalizing meter, the inspector should verify that the totalizer is accurate (i.e., properly calibrated). This can be done during a period of steady flow by reading the totalizer and at the same time starting a stopwatch. Start the stopwatch just as a new digit starts to appear on the totalizer. After 10 to 30 minutes, the totalizer should be read again; just as a new digit begins to appear, the stopwatch is read. Subtract the two totalizer readings to determine the total flow over the measured time period. Calculate the flow rate in gallons per minute by using the time from the stopwatch. Compare this flow rate to the flow determined by actual measurement of the head made at the primary device at the time interval. Consider the calibration of the totalizer satisfactory if the two flows are within 10 percent of each other, when the actual measured flow is used as the known value, or divisor, in the percent calculation.

C. REFERENCES

The following is a list of resources providing additional information on flow measurement.

Associated Water and Air Resource Engineers, Inc. (1973). *Handbook for Industrial Wastewater Monitoring*. USEPA, Technology Transfer.

Blasso, L. (1975). "Flow Measurement Under Any Conditions," *Instruments and Control Systems*, 48(2): 45-50.

Bos, M.G. (1976). *Discharge Measurement Structures*, Working Group on Small Hydraulic Structures International Institute for Land Reclamation and Improvement, Wageningen, The Netherlands.

Eli, R., and Pederson, H. (1979). *Calibration of a 90° V-Notch Weir Using Parameters Other than Upstream Head*. EPA-600/4-80-035.

ISCO. (2006). *Open Channel Flow Measurement Handbook*, Lincoln, Nebraska.

King, H.W., and Brater, E.F. (1963). *Handbook of Hydraulics*. 5th ed. New York: McGraw-Hill Book Co.

Mauis, F.T. (1949). "How to Calculate Flow Over Submerged Thin-Plate Weirs." *Eng. News-Record*. p. 65.

Metcalf and Eddy Inc. (2013). *Wastewater Engineering*. New York: McGraw-Hill Book Company.

Robinson, A.R. (1965). *Simplified Flow Corrections for Parshall Flumes Under Submerged Conditions*. Civil Engineering, ASCE.

Shelley, P.E., and Kirkpatrick, G.A. (1975). *Sewer Flow Measurement; A State of the Art Assessment*. U.S. Environmental Protection Agency, EPA-600/2-75-027.

Simon, A. (1976). *Practical Hydraulics*. New York: John Wiley & Sons.

Smoot, G.F. (1974). *A Review of Velocity-Measuring Devices*. U.S. Department of the Interior (USDI), United States Geological Survey (USGS). Open File Report, Reston, Virginia.

Stevens. (1978). *Water Resources Data Book*, Beaverton, Oregon: Leupold & Stevens.

Thorsen, T., and Oden, R. (1975). "How to Measure Industrial Wastewater Flow," *Chemical Engineering*, 82(4): 95-100.

U.S. Department of Commerce, National Bureau of Standards. (1975). *A Guide to Methods and Standards for the Measurement of Water Flow*. COM-75-10683.

U.S. Department of the Interior (USDI), Bureau of Reclamation. (2001). *Water Measurement Manual*, 2nd Ed.

U.S. Environmental Protection Agency. (1981). *NPDES Compliance Flow Measurement Manual*. Office of Water Enforcement and Permits Enforcement Division.

U.S. Environmental Protection Agency. (1991). Video: *National Pollutant Discharge Elimination System (NPDES) Parshall Flume inspection*. EPA 832-V91-001. Available at:
<http://www.youtube.com/watch?v=y6hiOLgTo6g>

D. FLOW MEASUREMENT INSPECTION CHECKLIST

A. GENERAL			
Yes	No	N/A	1. a. Primary flow measuring device properly installed and maintained.
Yes	No	N/A	b. Flow measured at each outfall? _____ Number of outfalls? _____
Yes	No	N/A	c. Is there a straight length of pipe or channel before and after the flowmeter of at least 5 to 20 diameter lengths?
Yes	No	N/A	d. If a magnetic flowmeter is used, are there sources of electric noise in the near vicinity?
Yes	No	N/A	e. Is the magnetic flowmeter properly grounded?
Yes	No	N/A	f. Is the full pipe requirement met?
Yes	No	N/A	2. a. Flow records properly kept.
Yes	No	N/A	b. All charts maintained in a file.
Yes	No	N/A	c. All calibration data entered into a logbook.
Yes	No	N/A	3. Actual discharged flow measured.
Yes	No	N/A	4. Effluent flow measured after all return lines.
Yes	No	N/A	5. Secondary instruments (totalizers, recorders, etc.) properly operated and maintained.
Yes	No	N/A	6. Spare parts stocked.
Yes	No	N/A	7. Effluent loadings calculated using effluent flow.
B. FLUMES			
Yes	No	N/A	1. Flow entering flume reasonably well-distributed across the channel and free of turbulence, boils, or other disturbances.
Yes	No	N/A	2. Cross-sectional velocities at entrance relatively uniform.
Yes	No	N/A	3. Flume clean and free of debris and deposits.
Yes	No	N/A	4. All dimensions of flume accurate and level.
Yes	No	N/A	5. Side walls of flume vertical and smooth.
Yes	No	N/A	6. Sides of flume throat vertical and parallel.
Yes	No	N/A	7. Flume head being measured at proper location.
Yes	No	N/A	8. Measurement of flume head zeroed to flume crest.
Yes	No	N/A	9. Flume properly sized to measure range of existing flow.
Yes	No	N/A	10. Flume operating under free-flow conditions over existing range of flows.
Yes	No	N/A	11. Flume submerged under certain flow conditions.
Yes	No	N/A	12. Flume operation invariably free-flow.

C. WEIRS			
Yes	No	N/A	1. What type of weir does the facility use?
Yes	No	N/A	2. Weir exactly level.
Yes	No	N/A	3. Weir plate plumb and its top and edges sharp and clean.
Yes	No	N/A	4. Downstream edge of weir is chamfered at 45°.
Yes	No	N/A	5. Free access for air below the nappe of the weir.
Yes	No	N/A	6. Upstream channel of weir straight for at least four times the depth of water level and free from disturbances.
Yes	No	N/A	7. Distance from sides of weir to side of channel at least 2H.
Yes	No	N/A	8. Area of approach channel at least (8 × nappe area) for upstream distance of 15H.
Yes	No	N/A	9. If not, is velocity of approach too high?
Yes	No	N/A	10. Head measurements properly made by facility personnel.
Yes	No	N/A	11. Leakage does not occur around weir.
Yes	No	N/A	12. Use of proper flow tables by facility personnel.
D. OTHER FLOW DEVICES			
			1. Type of flowmeter used:
			2. What are the most common problems that the operator has had with the flowmeter?
			3. Measured wastewater flow: _____ MGD; Recorded flow: _____; Error _____%
E. CALIBRATION AND MAINTENANCE			
Yes	No	N/A	1. Flow totalizer properly calibrated.
			2. Frequency of routine inspection by proper operator: _____/day.
			3. Frequency of maintenance inspections by plant personnel: _____/year.
Yes	No	N/A	4. Flowmeter calibration records kept. Frequency of flowmeter calibration: _____/month.
Yes	No	N/A	5. Flow measurement equipment adequate to handle expected ranges of flow rates.
Yes	No	N/A	6. Calibration frequency adequate.

CHAPTER 7 – LABORATORY PROCEDURES AND QUALITY ASSURANCE

Contents

A. Objectives and Requirements.....	134
B. Sample Handling Procedures.....	134
Evaluation of Permittee Sample Handling Procedures	134
C. Laboratory Analyses Techniques Evaluation.....	135
Evaluation of Permittee Laboratory Analytical Procedures	135
Evaluation of Permittee Laboratory Facilities and Equipment	136
D. Quality Assurance and Quality Control	138
Evaluation of the Precision and Accuracy of the Permittee Laboratory	138
Example of Laboratory QA/QC Measures for Microbial Analyses	140
Evaluation of Permittee Data Handling and Reporting	140
Evaluation of Permittee Laboratory Personnel.....	141
Evaluation of Contract Laboratories	141
Overview of the Discharge Monitoring Report Quality Assurance Program and How It Relates to the Inspection Program.....	141
E. References.....	142
F. Laboratory Quality Assurance Checklist.....	144

A. OBJECTIVES AND REQUIREMENTS

The analytical laboratory provides both qualitative and quantitative information for determining the extent of permittee compliance with permit discharge requirements. To be valuable or useful, the data must be representative and accurately describe the characteristics and concentrations of constituents in the samples submitted to the laboratory. The objectives of laboratory Quality Assurance (QA) are to monitor and document the accuracy and precision of the results reported and to meet reliability requirements.

QA refers to a total program for ensuring the reliability of data by utilizing administrative and technical procedures and policies regarding personnel, resources, and facilities. QA is required for all functions bearing on environmental measurements and includes activities such as project/study definition; sample collection and tracking; laboratory analysis; data validation, analysis, reduction, and reporting; documentation; and data storage systems. Thus, the QA program is designed to evaluate and maintain the desired quality of data. Quality Control (QC), a function of QA, is the routine application of procedures for controlling the accuracy and precision of the measurement process and includes the proper calibration of instruments and the use of the appropriate analytical procedures.

The regulations at Title 40 of the *Code of Federal Regulations* (CFR), section 122.41(e) (conditions applicable to all permits), requires adequate laboratory and process controls, including appropriate QA/QC procedures. Each permittee's laboratory must have a QA/QC program. The laboratory must document the QA/QC program in a written QA/QC manual and the laboratory should make it available to all personnel responsible for sample analyses. The manual must clearly identify the individuals involved in the QA program and document their responsibilities. The laboratory's standard operating procedures must meet user requirements in terms of specificity, completeness, precision, accuracy, representativeness, and comparability of the required testing procedures. The laboratory should devote approximately 10 to 20 percent of their resources to their QA/QC program.

Guidance in this chapter is broad-based and may not be applicable to every laboratory. This chapter includes a Laboratory Quality Assurance Checklist for the inspector's use at the end of the chapter. For detailed information concerning laboratory QA/QC, refer to Environmental Protection Agency's (EPA's) *Handbook for Analytical Quality Control in Water and Wastewater Laboratories* (EPA, 1979) and EPA's *National Pollutant Discharge Elimination System (NPDES) Compliance Monitoring Inspector Training Module: Laboratory Analysis* (EPA, 1990). If a more detailed assessment of a laboratory is required, personnel with more extensive knowledge of the methodologies should perform the inspection.

B. SAMPLE HANDLING PROCEDURES

EVALUATION OF PERMITTEE SAMPLE HANDLING PROCEDURES

Proper sample handling procedures are necessary in the laboratory from the sample's receipt to its discard. Sample handling procedures for small permittees may differ from procedures for larger permittees because staff organizational structures and treatment facility designs vary

from one facility to the next. However, proper sample handling procedures should be standardized, utilized and documented by all permittees. In evaluating laboratory sample handling procedures, the inspector should verify the following:

- The laboratory area is secure and restricts entry to authorized personnel only.
- The laboratory has a sample security area that is dry, clean, and isolated; has sufficient refrigerated space; and can be locked securely.
- The laboratory has a sample custodian and a back-up custodian.
- The custodian receives all incoming samples, signs the chain-of-custody record sheet accompanying the samples, and locks the samples in the sample security area refrigerator.
- The custodian ensures that samples are properly stored.
- The custodian performs or analyzes checks of proper preservation, container type, and holding times and documents the results.
- The custodian distributes and retrieves samples to and from personnel who perform the analyses (i.e., analysts) and documents the transfer of the samples in the chain-of-custody record, which is retained as a permanent record. The chain-of-custody record typically identifies the sample identification number, sample collection date and time, sample type, sample location, sample volume, and preservatives.
- The custodian and analysts ensure the minimum possible number of people handle the samples.
- The custodian only disposes of samples and records upon direction from the laboratory director, in consultation with previously designated enforcement officials, when it is certain that the information is no longer required or that the samples have deteriorated.

C. LABORATORY ANALYSES TECHNIQUES EVALUATION

EVALUATION OF PERMITTEE LABORATORY ANALYTICAL PROCEDURES

The permittee's laboratories or its contract laboratories must use uniform methods, thus, eliminating methodology as a variable when data are compared or shared among laboratories. The permittee's laboratory must consult 40 CFR Part 136 for the alternative methods approval process. A permittee may only use alternative test procedures if the procedures have EPA approval, as specified by 40 CFR 136.4 and 136.5, and promulgated under Public Law (PL) 92-500.

Many standardized test procedures promulgated under 40 CFR Part 136 are covered in EPA's *Methods for Chemical Analysis of Water and Wastes* (EPA, 1983) and the latest accepted edition of *Standard Methods for the Examination of Water and Wastewater* (American Public Health Association (APHA), American Water Works Association (AWWA), and Water Environment Federation (WEF), 2013). Revisions and new additions to this manual are made whenever new analytical techniques or instruments are developed. These are considered

accepted after final publication in the Federal Register.³ Other approved methods from United States Geological Survey (USGS), American Society for Testing and Materials (ASTM), and several commercial vendor methods are also referenced in 40 CFR Part 136.

In evaluating laboratory analytical procedures, the inspector should verify the following:

- The laboratory personnel follow analytical methods specified in the most current 40 CFR Part 136.
- The laboratory personnel properly perform any deviations allowed by 40 CFR Part 136 and maintain documentation of any EPA-approved deviation from specified procedures.
- The laboratory personnel follow QA/QC procedures that conform to the procedures specified in the permit, analytical method, or methods compendium for approved 40 CFR Part 136 methods from a consensus organization. For example, the Standard Methods for the Examination of Water and Wastewater (APHA, AWWA, and WEF) contains QA/QC procedures.
- The laboratory personnel maintain a QA/QC record on reagent preparation, instrument calibration and maintenance, incubator temperature, and purchase of supplies.
- The laboratory personnel conduct QA/QC checks on materials, supplies, equipment, instrument calibration and maintenance, facilities, analyses, and standard solutions.

EVALUATION OF PERMITTEE LABORATORY FACILITIES AND EQUIPMENT

To verify that the proper analytical procedures are being followed, the inspector should have the responsible analyst describe each of the procedures. The inspector should be alert to any deviation from the specified analytical method. Any questions regarding the proper procedures can be resolved by referring to the cited methodology. Even simple analyses can yield invalid results if the methodology cited in 40 CFR Part 136 is not exactly followed. Certain required deviations from the approved methods are cited in 40 CFR Part 136, notes.

Laboratory Services

The availability of laboratory services affects data reliability. In evaluating laboratory services, the inspector should verify that the laboratory provides the following:

- Adequate supply of laboratory pure water, free from chemical interferences and other undesirable contaminants. The laboratory personnel should check water quality routinely and document it.
- Adequate bench, instrumentation, storage, and recordkeeping space.
- Clean and orderly work area to help avoid contamination.
- Adequate circulation and egress.
- Adequate humidity and temperature control.
- Adequate lighting and ventilation.

³ The most current 40 CFR Part 136 may supersede any method or technique cited in this manual.

- Dry, uncontaminated compressed air when required.
- Efficient fume hood systems.
- Necessary equipment such as a hot plate, incubator, water bath, refrigerator for samples, glassware, pH meter, thermometer, balance, etc.
- Electrical power for routine laboratory use and, if appropriate, voltage-regulated sources for delicate electronic instruments.
- Vibration-free area for accurate weighing.

The inspector should also check that the laboratory personnel use proper safety equipment (e.g., lab coats, gloves, safety glasses, goggles, and fume hoods) where necessary. The inspector should document any problems and refer to the proper authority (e.g., Occupational Safety and Health Administration (OSHA)).

Instruments and Equipment

Instrumentation is extremely important in the analytical laboratory. To a certain extent, analytical instrumentation is always developmental; manufacturers are continually redesigning and upgrading their products, striving for miniaturization, enhanced durability and sensitivity, and improved automation. In evaluating laboratory instruments and equipment, the inspector should verify the following:

- The laboratory personnel follow standard and specific procedures for selecting and cleaning glassware and containers. Chapter 2 of EPA's *NPDES Compliance Monitoring Inspector Training Module: Laboratory Analysis* (EPA, 1990) contains detailed information on glassware cleaning.
- The laboratory personnel follow written requirements (e.g., standard operating procedures) for daily operation of instruments and equipment.
- The laboratory contains emergency equipment such as a fire extinguisher, eye wash station, shower, first aid kit, lab coats, gloves, and goggles.
- Standards and appropriate blanks are available from suppliers to perform standard calibration procedures. The laboratory personnel should use standard concentrations that closely bracket actual sample concentrations. Sources of standards are documented and where possible, traceable to a national standard (e.g., National Institute of Standards and Technology (NIST)).
- The laboratory personnel maintain records of each set of analyses performed including the order in which calibration, QA/QC, and samples were analyzed (i.e., analysis run logs or instrument run logs).
- The laboratory personnel follow written troubleshooting procedures to identify common equipment malfunctions.
- The laboratory personnel follow written schedules for replacement, cleaning, checking, and/or adjustment by service personnel.
- The laboratory personnel maintain documentation on equipment maintenance and service checks.

Commonly used analytical instruments include analytical balances, pH meters, dissolved oxygen meters, conductivity meters, turbidity meters, spectrophotometers, atomic absorption spectrophotometers, organic carbon analyzers, selective ion analyzers, gas-liquid chromatographs, titrimetric analyses, and temperature controls. Chapter 2 of EPA's *NPDES Compliance Monitoring Inspector Training Module: Laboratory Analysis* (EPA 1990) includes a detailed discussion on these instruments.

Supplies

Chemical reagents, solvents, and gases are available in many grades of purity, ranging from technical grade to various ultrapure grades. The purity of the materials required in analytical chemistry varies with the type of analysis. The parameter being measured, the analytical method, and the sensitivity and specificity of the detection system determine the purity of the reagents required. Do not use reagents of lesser purity than that specified by the method. In evaluating laboratory supplies, the inspector should verify that the laboratory personnel:

- Check the accuracy of purchased solutions as per method requirements.
- Prepare stock solutions and standards using volumetric glassware.
- Prepare and standardize reagents against reliable primary standards.
- Use the required reagent purity for the specific analytical method.
- Check working standards frequently to determine changes in concentration or composition.
- Verify concentrations of stock solutions before being used to prepare new working standards.
- Label standards and reagents properly including the preparation date, concentration, the analyst's identification, storage requirements, and discard date.
- Store standards, reagents, and solvents in appropriate containers and under required method conditions and manufacturer's directions. If conditions are not specified, store standards and reagents according to 40 CFR Part 136, Table II.
- Store standards, reagents and solvents using clean containers of suitable composition with tight-fitting stoppers.
- Discard standards and reagents after recommended shelf-life has expired or when signs of discoloration, formation of precipitates, or significant changes in concentrations are observed.

D. QUALITY ASSURANCE AND QUALITY CONTROL

EVALUATION OF THE PRECISION AND ACCURACY OF THE PERMITTEE LABORATORY

The purpose of laboratory control procedures is to ensure high-quality analyses using control samples, control charts, reference materials, and instrument calibration. The laboratory must initiate and maintain controls throughout the analysis of samples. Specifically, each testing batch must contain at least one blank, standard, duplicate, and spiked (as applicable) sample analysis. When a batch contains more than 10 samples, every tenth sample should be followed by a duplicate and a spike (as applicable). Consult each method for specific QC requirements.

The precision of laboratory findings refers to the reproducibility or degree of agreement among replicate measurements of the same quantity. The closer the numerical values of the measurements come to each other, the more precise the measurements are. In a laboratory QC program, precision is determined by the analysis of actual samples in duplicate. These may represent a range of concentrations and a variety of interfering materials usually encountered during the analysis. Accuracy refers to the degree of difference between observed values and known or actual values. The closer the value of the measurement comes to the actual value, the more accurate the measurement is. The accuracy of a method can be determined by analyses of samples to which known amounts of reference standards have been added (spiked samples).

In evaluating the precision of the measurement process, the inspector should verify that the laboratory personnel:

- Introduce duplicate samples into the train of actual samples at least 10 percent of the time to monitor the performance of the analytical system.
- Prepare and use precision control charts or other statistical techniques for each analytical procedure. Develop precision control charts by collecting data from a minimum of 15 to 20 duplicate samples (run in controlled conditions) over an extended period (e.g., 10 to 20 days). Statistical methods include calculation of mean, standard deviation, and variance to define the range and variability of the data.
- Take corrective actions when data fall outside the warning and control limits.
- Document out-of-control data, the situation, and the corrective action taken.

In evaluating accuracy of the measurement process, the inspector should verify that the laboratory personnel:

- Introduce spiked samples into the train of actual samples at least 10 percent of the time to monitor the performance of the analytical system. In the spiked samples, the amount of additive is appropriate to the detection limit and sample concentration.
- Prepare and use accuracy control charts for each analytical procedure. Develop accuracy control charts by collecting data from a minimum of 15 to 20 spiked samples (run in controlled conditions) over an extended period.
 - Establish accuracy limits (as percent recovery) based on standard deviations whose upper and lower control limits are three times the standard deviation above and below the central line.
 - Establish the upper and lower warning limits at twice the standard deviation above and below the central line. Note: Some parameters have a defined warning limit required by 40 CFR Part 136.
- Take corrective actions when data fall outside the warning and control limits.
- Document out-of-control data, the situation, and the corrective action taken.

EXAMPLE OF LABORATORY QA/QC MEASURES FOR MICROBIAL ANALYSES

As an example of the laboratory quality measures an inspector might evaluate, the following discussion applies to microbial analysis. Microbial contamination is a common concern related to animal feeding operations and sanitary treatment systems covered by the NPDES standards. Common microbial contaminants of concern in wastewater and sewage sludge include total coliform, fecal coliform, and enterococci. Appropriate microbial laboratory control measures the inspector should verify include the use by laboratory personnel of:

- Positive and negative controls—controls are known cultures that are analyzed exactly like a field sample and will produce an expected positive or negative result for a given type of medium.
- Media sterility checks—media are incubated at the appropriate temperature without the field sample and observed for growth to verify the media is not contaminated with the evaluated microorganisms prior to use in the laboratory.
- Dilution sterility checks—dilution water is analyzed exactly like a field sample and observed for growth to verify the water is not contaminated with the evaluated microorganisms prior to use in the laboratory.
- Sample bottle blanks—a blank is analyzed for each bottle lot used during the sampling episode to verify the sample bottles had not been contaminated with the evaluated microorganisms prior to the field sampling.
- Membrane filter preparation blanks—membrane filter blanks are analyzed at the beginning of each set of filtered samples to verify the membrane filtration equipment is not contaminated with the evaluated microorganisms prior to use in the laboratory.
- Incubator temperature monitoring—incubator temperatures are monitored in the laboratory to verify that prepared microbial samples are being incubated at the correct temperatures.

The analytical methods for microbial analyses are specified in 40 CFR Part 136, Table IA.

EVALUATION OF PERMITTEE DATA HANDLING AND REPORTING

An analytical laboratory must have a system for uniformly recording, correcting, processing, and reporting data. The inspector should verify that the laboratory personnel:

- Use correct formulas to calculate the final results.
- Apply round-off rules uniformly.
- Establish significant figures for each analysis.
- Provide data in the form/units required for reporting.
- Ensure cross-checking calculations provisions are available.
- Determine control chart approaches and statistical calculations for the purposes of QA/QC and reporting.

- Maintain laboratory report forms that provide complete data documentation and facilitate data processing.
- Keep permanently bound laboratory notebooks or pre-printed data forms to document the procedures performed and the details of the analysis, such as the original value recorded, correction factors applied, blanks used, data values reported, personnel that performed the tests, and any abnormalities that occurred during the testing procedure.
- Define procedures for correction of data entry errors. Original data entries can be read and the individual(s) making the corrections are clearly identified.
- Back up computer data with duplicate copies (i.e., electronic and hardcopy).
- Maintain data records that allow the recalculation of all results reported by the laboratory(ies) from the original unprocessed results (i.e., raw data) to the final results sent to EPA and the regulatory authority for a minimum of three years.

EVALUATION OF PERMITTEE LABORATORY PERSONNEL

Analytical operations in the laboratory vary in complexity. Consequently, the laboratory should clearly define work assignments. All analysts should be thoroughly instructed in basic laboratory operations. Those persons performing complex analytical tasks should be qualified and properly trained. All analysts must follow specified laboratory procedures and be skilled in using the laboratory equipment and techniques required for the analyses assigned to them. In evaluating laboratory personnel, the inspector should consider the following factors:

- Adequacy of training.
- Skill and diligence in following procedures.
- Skill and knowledge in using equipment and analytical methods (particularly for complex equipment such as gas chromatography).
- Precision and accuracy in performing analytical tasks.
- Assignment of clearly defined tasks and responsibilities.

EVALUATION OF CONTRACT LABORATORIES

When the permittee contracts with the laboratory to analyze samples, the inspector may need to evaluate the laboratory practices at the contracted laboratory. The practices can also be evaluated by other designated EPA inspectors. If a deficiency is identified at a contract laboratory, the permittee is responsible for the deficiency and will be notified.

OVERVIEW OF THE DISCHARGE MONITORING REPORT QUALITY ASSURANCE PROGRAM AND HOW IT RELATES TO THE INSPECTION PROGRAM

The validity of the NPDES program depends on the quality of the self-monitoring program. The Discharge Monitoring Report Quality Assurance (DMR QA) program is an important tool used to ensure the quality of NPDES self-monitoring data. The program is designed to evaluate and improve the ability of laboratories serving NPDES permittees to analyze and report accurate self-monitoring data.

Major and selected minor permittees under the NPDES program are required to participate in the annual DMR-QA study program. DMR-QA evaluates the analytical ability of the laboratories that routinely perform self-monitoring analyses required by their NPDES permit. EPA also approves certain state laboratory certification programs to be used as either a full or a partial substitute for DMR-QA. Under the program, permittees must purchase NPDES performance evaluation samples containing constituents normally found in industrial and municipal wastewaters from accredited providers. The permittee analyzes these samples using the analytical methods and laboratory normally employed for their reporting of NPDES self-monitoring data. The supplier of the performance evaluation sample will evaluate the results and respond to the permittee.

Highlights

- The DMR-QA Program has been an excellent means of focusing on and improving the quality of laboratory results used in developing DMR data. Improvements in the DMR-QA data have been significant.
- This program has helped major permittees identify and correct both analytical and data handling problems in their laboratories.
- In general, permittees are receptive to the program and recognize its value, including some who challenged EPA's authority to require participation.
- Regions and states are generally supportive and have made good use of the results of this program for targeting inspections and directing other follow-up activities. This ability to concentrate corrective actions on problem permittees results in an increased efficiency in improving the self-monitoring data of all NPDES permittees.
- The program is one of the least resource-intensive methods for maintaining direct and regular technical contact with NPDES permittees. It has been recognized as a cost-effective effort.
- Utilizing computer technology, the following ways of managing and analyzing DMR QA data were started in fiscal year 1985: compiling tracking summaries, comparing performance of the major industries, tracking multiple permittees, and regenerating past performance evaluation reports.

The results of the DMR-QA are provided to and tracked by EPA and the state DMR-QA coordinator. The DMR-QA Program and the NPDES inspection programs are interdependent in several areas. First, EPA can use DMR-QA evaluations of permittee performance to target the inspections since the evaluations identify potential problems in the laboratory analysis or data handling and reporting. This targeting helps to direct limited resources to permittees who need them most. Non-reporting of DMR-QA results is also an important trigger for on-site inspections. Secondly, EPA can identify instances when the QA results do not comply with the parameters specified in the permit to check during the inspection.

E. REFERENCES

The following is a list of resources providing additional information on laboratory procedures.

ASTM. (1982). *Annual Book of Standards: Part 31, Water*. Philadelphia, PA: ASTM.

American Public Health Association (APHA), American Water Works Association (AWWA), and World Economic Forum (WEF). (2013). *Standard Methods for the Examination of Water and Wastewater*.

Brown, E., Skougstad, M.W. and Fishman, M.J. (1970). *Methods for Collection and Analysis of Water Samples for Dissolved Minerals and Gases*. U.S. Geological Survey Techniques of Water Resources Inv., Book 5.

Delfino, J.J. (1977). "Quality Assurance in Water and Wastewater Analysis Laboratories." *Water and Sewage Works*, 124(7): 79-84.

Federal Register. (1986). *Guidelines Establishing Test Procedures for the Analysis of Pollutants Under the Clean Water Act* (also see October 26, 1986). Vol 51. No. 125.

Plumb, R.H., Jr. (1981). "Procedure for Handling and Chemical Analysis of Sediment and Water Samples." U.S. Environmental Protection Agency Technical Report, EPA/CE-81-1.

U.S. Geological Survey (USGS), United States Department of the Interior (USDI). (1985). "Methods for determination of inorganic substances in water and fluvial sediments." Open File Report 85-495.

U.S. Environmental Protection Agency. (1979). *Handbook for Analytical Quality Control in Water and Wastewater Laboratories*. EPA-600/4-79-019.

U.S. Environmental Protection Agency. (1983). *Methods for Chemical Analysis of Water and Wastes*. EPA-600/4-79-020.

U.S. Environmental Protection Agency. (1990). *NPDES Compliance Monitoring Inspector Training Module: Laboratory Analysis*. EPA 833-R-90-103.

U.S. Environmental Protection Agency. (1999a). *Methods and Guidance for Analysis of Water, Version 2.0*. EPA 821-C-99-004.

U.S. Environmental Protection Agency. (2004). *National Environmental Laboratory Accreditation Conference (NELAC): Constitution, Bylaws, and Standards*. EPA-600/R-04/003.

U.S. Environmental Protection Agency. (2005). *EPA Quality Manual for Environmental Programs*. CIO 2105-P-01-0.

U.S. Environmental Protection Agency. (2013). *EPA Microbiology Resources*. Available online at: <https://www.epa.gov/water-research/microbiological-methods-and-online-publications>

F. LABORATORY QUALITY ASSURANCE CHECKLIST

A. GENERAL			
Yes	No	N/A	1. Laboratory maintains a written QA/QC manual.
B. SAMPLE HANDLING PROCEDURES			
Yes	No	N/A	1. Access to laboratory area restricted to authorized personnel only.
Yes	No	N/A	2. Sample security area available within laboratory that is dry, clean, and isolated; has sufficient refrigerated space; and can be locked securely.
Yes	No	N/A	3. Laboratory refrigerator utilizes a thermometer with NIST certification or that is annually calibrated against another NIST-certified thermometer and documented using certification tags.
Yes	No	N/A	4. Laboratory has a sample custodian and a back-up custodian.
Yes	No	N/A	5. Custodian receives and logs in all incoming samples.
Yes	No	N/A	6. Custodian properly stores samples.
Yes	No	N/A	7. Custodian performs checks of proper preservation, container type, and holding times performed and documents the results.
Yes	No	N/A	8. Custodian distributes and retrieves samples to and from the analysts.
Yes	No	N/A	9. Custodian maintains chain-of-custody documentation.
Yes	No	N/A	10. Custodian and analysts ensure the minimum possible number of people handles the samples.
Yes	No	N/A	11. Custodian disposes of the samples and records upon direction of the laboratory director.
C. LABORATORY PROCEDURES			
Yes	No	N/A	1. EPA-approved written analytical testing procedures used and protocols are easily accessible by laboratory personnel.
Yes	No	N/A	2. If alternate analytical procedures used, proper written approval obtained.
Yes	No	N/A	3. Calibration and maintenance of instruments and equipment satisfactory.
Yes	No	N/A	4. QA procedures used.
Yes	No	N/A	5. QC procedures adequate.
			6. Duplicate samples are analyzed _____ % of time.
			7. Spiked samples are used _____ % of time.
Yes	No	N/A	8. Whole Effluent Toxicity (WET) testing is required by the permit and conducted by the laboratory. Culturing procedures are adequately documented for each organism tested.
Yes	No	N/A	9. WET testing protocols are clearly described.
Yes	No	N/A	10. Commercial laboratory used.
			Name: _____
			Address: _____
			Contact: _____
			Phone: _____

			Certification #: _____
D. LABORATORY FACILITIES AND EQUIPMENT			
Yes	No	N/A	1. Adequate supply of laboratory pure water available for specific analysis.
Yes	No	N/A	2. Adequate bench, instrumentation, storage, and recordkeeping space available.
Yes	No	N/A	3. Clean and orderly work area available to help avoid contamination.
Yes	No	N/A	4. Adequate circulation and egress.
Yes	No	N/A	5. Adequate humidity and temperature control.
Yes	No	N/A	6. Adequate lighting and ventilation.
Yes	No	N/A	7. Dry, uncontaminated compressed air available.
Yes	No	N/A	8. Efficient fume hood systems available.
Yes	No	N/A	9. Adequate electrical sources available.
Yes	No	N/A	10. Instruments/equipment available and in good condition.
Yes	No	N/A	11. Vibration-free area for accurate weighing available.
Yes	No	N/A	12. Proper safety equipment (lab coats, gloves, safety glasses, goggles, and fume hoods) used when necessary.
Yes	No	N/A	13. Proper volumetric glassware used.
Yes	No	N/A	14. Glassware properly cleaned.
Yes	No	N/A	15. Written requirements for daily operation of instruments/equipment available.
Yes	No	N/A	16. Standards and appropriate blanks available to perform daily check procedures.
Yes	No	N/A	17. Sources of standards documented and where possible traceable to a national standard (e.g., NIST).
Yes	No	N/A	18. Records of each set of analysis including order in which calibration, QA/QC, and samples were analyzed are available.
Yes	No	N/A	19. Written troubleshooting procedures for instruments/equipment are available.
Yes	No	N/A	20. Written schedules for required maintenance are available.
Yes	No	N/A	21. Check the accuracy of purchased solutions as per method requirements.
Yes	No	N/A	22. Prepare stock solutions and standards using volumetric glassware.
Yes	No	N/A	23. Prepare and standardize reagents against reliable primary standards.
Yes	No	N/A	24. Use the required reagent purity for the specific analytical method.
Yes	No	N/A	25. Frequently checked working standards to determine changes in concentration or composition.
Yes	No	N/A	26. Verify concentrations of stock solutions before being used to prepare new working standards.
Yes	No	N/A	27. Background reagents and solvents run with every series of samples.
Yes	No	N/A	28. Label standards and reagents properly, including the preparation date, concentration, the analyst's identification, storage requirements, and discard date.
Yes	No	N/A	29. Store standards, reagents, and solvents in appropriate containers and under required method conditions and manufacturer's directions.
Yes	No	N/A	30. Store standards, reagents, and solvents using clean containers.

Yes	No	N/A	31. Replace gas cylinders at 100-200 psi.
Yes	No	N/A	32. Written procedures exist for cleanup, hazard response methods, and applications of correction methods for reagents and solvents.
Yes	No	N/A	33. Discard standards after recommended shelf-life has expired or when signs of discoloration, formation of precipitates, or significant changes in concentrations are observed.
E. LABORATORY PRECISION, ACCURACY, AND CONTROL PROCEDURES			
Yes	No	N/A	1. Analyzed multiple control samples (i.e., blanks, standards, duplicates, and spikes) for each type of QA/QC check and recorded information. Every tenth sample should have been followed by a duplicate and a spike.
Yes	No	N/A	2. Plotted precision and accuracy control methods used to determine whether valid, questionable, or invalid data are being generated throughout the analysis.
Yes	No	N/A	3. Taken corrective actions when data fall outside the warning and control limits.
Yes	No	N/A	4. Recorded out-of-control data, the situation, and the corrective action taken.
F. DATA HANDLING AND REPORTING			
Yes	No	N/A	1. Used correct formulas to calculate final results.
Yes	No	N/A	2. Applied round-off rules uniformly.
Yes	No	N/A	3. Established significant figures for each analysis.
Yes	No	N/A	4. Recorded data in the proper form and units for reporting.
Yes	No	N/A	5. Ensured cross-checking calculations provisions are available.
Yes	No	N/A	6. Developed and followed control chart approaches and statistical calculations for QA/QC.
Yes	No	N/A	7. Laboratory report forms developed to provide complete data documentation and to facilitate data processing.
Yes	No	N/A	8. Laboratory notebooks or pre-printed data forms bound permanently utilized to provide good documentation.
Yes	No	N/A	9. Procedures for correction of data entry errors are defined.
Yes	No	N/A	10. Backed up computer data with duplicate copies (i.e., electronic and hardcopy).
Yes	No	N/A	11. Efficient filing system exists, enabling prompt retrieval of information and channeling of report copies.
Yes	No	N/A	12. Data records allow recalculation of all results reported by the laboratory(ies) from the original unprocessed results (raw data) to the final results sent to EPA and the regulatory authority for a minimum of three years.
G. LABORATORY PERSONNEL			
Yes	No	N/A	1. Enough analysts present to perform the analyses necessary.
Yes	No	N/A	2. Analysts have on hand the necessary references for EPA procedures being used.
Yes	No	N/A	3. Analysts trained in procedures performed through formal or informal training or certification programs.

CHAPTER 8 – TOXICITY

Contents

A. Objectives.....	148
B. Requirements of WET Testing.....	149
Types of WET Testing	149
WET Test Components	150
Effluent	151
Dilution Water	152
Test System	154
Test Organisms	154
Reference Toxicants	156
Conduct of the Test(s)	157
Recordkeeping and Data Reporting	157
Review Checklist.....	158
C. Analysis of WET Data	159
D. Toxicity Reduction Evaluations and Toxicity IDentification Evaluations (TRES/TIEs)	168
E. References.....	170

List of Tables

Table 8-1. Recommended Effluent Sampling Strategies for Continuous and Intermittent Discharges for Flow-Through, Static Renewal, and Static Toxicity Tests ^a	153
Table 8-2. Summary of TAC per EPA Method	165

Related Websites

Office of Science and Technology/Engineering and Analysis Division Methods home page (including Whole Effluent Toxicity): <https://www.epa.gov/cwa-methods/whole-effluent-toxicity-methods>

Office of Wastewater Management/Water Permits Division National Pollutant Discharge Elimination System Permits Program—Whole Effluent Toxicity home page: <https://www.epa.gov/npdes/npdes-permit-limits#wet>

Office of Wastewater Management/Water Permits Division – Recorded Webinars and Training – Whole Effluent Toxicity (WET) Training: <https://www.epa.gov/npdes/npdes-training#wettraining> (Note: Module 8, *NPDES WET Compliance and Enforcement*)

A. OBJECTIVES

Toxicity is a characteristic of a substance (or group of substances) that causes adverse effects in organisms. Adverse effects include an increased rate of morbidity (the rate of occurrence of disease) and mortality (the rate of occurrence of death), as well as those effects that limit an organism's ability to survive in nature, such as impaired reproductive ability, mobility or growth. Toxicity of a substance is measured by observing the responses of organisms to increasing concentrations of that substance. One substance is more toxic than another when it causes the same adverse effects at a lower concentration.

Whole Effluent Toxicity (WET) is a National Pollutant Discharge Elimination System (NPDES) permits program parameter designed to evaluate the toxicity of the entire wastestream as opposed to its individual components. WET testing may be performed or evaluated as part of one of five NPDES inspections:

- Compliance Evaluation Inspection (CEI)
- Compliance Sampling Inspection (CSI)
- Performance Audit Inspection (PAI)
- Toxics Sampling Inspection (XSI)
- Compliance Biomonitoring Inspection

In addition, an inspector should consider the toxicity of a municipal treatment plant's effluent as part of Pretreatment Compliance Inspections (PCIs), since the effluent toxicity may originate from industrial or commercial discharges to the municipal treatment plant.

EPA test methods manuals for Whole Effluent Toxicity testing can be accessed at:
<https://www.epa.gov/cwa-methods/whole-effluent-toxicity-methods>.

The inspector should understand the permittee's WET testing requirements so that the appropriate objectives can be met. These objectives may include:

- Assess compliance with NPDES permit conditions.
- Assess NPDES permit conditions for clear and inclusive language.
- Consider overall laboratory WET test performance (reference toxicants and other WET quality assurance/quality control (QA/QC) requirements) especially EPA's minimum WET test methods' Test Acceptability Criteria (TAC).
- Evaluate quality of self-monitoring data.
- Assess adequacy of self-monitoring procedures.
- Document presence or absence of toxic conditions.
- Identify need to perform Toxicity Reduction Evaluation (TRE) and/or a Toxicity Identification Evaluation (TIE).
- Identify permit terms and conditions that may not be strong enough to ensure state WET water quality standards are met.

B. REQUIREMENTS OF WET TESTING

WET tests are techniques to determine the toxicity of a permittee's discharge or effluent by measuring the responses of organisms to varying concentrations of the facility's effluent and test dilution water. The EPA WET test methods, as revised November 2002, are specified in 40 CFR Part 136 and described in the EPA WET test methods manuals (accessible at <https://www.epa.gov/cwa-methods/whole-effluent-toxicity-methods>). This section provides general background on WET tests and guidance for inspectors to consider when performing various types of inspections concerning WET tests (laboratory performance, effluent sampling, shipping, records, etc.).

TYPES OF WET TESTING

Depending on the EPA WET test required under a NPDES permit, the WET test designs may vary according to nationally standardized testing and where applicable, regional specific protocols. They vary in the number of test organisms used, duration of the test (acute or chronic), or in the way in which the effluent contacts the organism (flow-through, static, static renewal). The permitting authority will select the appropriate WET test design depending on the suspected toxicants present and the intended use of the WET test results. For example, a preliminary Range screening or T-test WET uses comparatively fewer organisms than the full scale WET test (five test concentrations plus a control treatment) because the results are derived from the comparison of a single effluent test concentration to the control treatment. This initial screening WET test is usually conducted to assess if toxicity is present and should be followed up with a multiple concentration WET test to generate a dose-response curve unless the statistical analysis used was designed for a two concentration WET test and is sufficiently robust for interpreting WET data generated from a T-test. WET data interpretation and analysis is discussed in more detail in Section C of this chapter. The more common EPA WET tests have requirements that include a multi-concentration dilution series consisting of a control treatment (no effluent) and five effluent test concentrations (serial dilutions of effluent sample plus dilution water, except for the 100-percent effluent test concentration). EPA WET test methods have minimum mandatory test acceptability criteria (TAC) that must be met for the WET test and its results to be considered a valid WET test.

EPA WET tests have method specific requirements that include: the number of test organisms per test chamber, the number of test replicates per test dilution, a test design of a control treatment plus five effluent dilution test concentrations, and specified test durations for acute and chronic testing. See the EPA WET test methods for more details. The response of each organism in each test concentration is observed and recorded. The toxicity of the effluent sample is determined by analyzing the response of the test organisms in relation to the effluent test concentration to which the organisms were exposed.

WET testing may be performed as either acute or chronic tests in accordance with standardized EPA WET test methods. The terms acute and chronic refer to the length of time that the organisms are exposed to the toxicant, and the respective WET test endpoints (i.e., acute-lethal, chronic-lethal and sub-lethal). The duration of the tests is prescribed in the WET test

method specified in the NPDES permit. Generally, acute tests measure short-term extreme negative effect responses, such as death or a debilitating physiological disorder. A test organism response to toxicity observed within 96 hours or less is typically considered an acute measurement. Chronic tests involve a causative agent that lingers or continues for a relatively longer period, often one-tenth of an organism's lifespan or more. "Chronic" should be considered a relative term depending on the lifespan of an organism. WET chronic tests typically run for seven days. A chronic effect may result in negative responses such as death (lethal endpoint), as well as stunted growth and reduced mobility or reproductive rates (sub-lethal endpoints).

Common test responses indicating the presence of toxic conditions include:

- Death—increase in number of organisms killed by a test solution when compared to the control treatment.
- Inhibited growth—measurement of reduction in growth (including mean weight of an organism) compared to the control treatment.
- Reduced reproduction or mobility—measurement of reduction in reproductive rates or mobility compared to the control treatment.
- Terata—increase in number of gross abnormalities shown in early life stages compared to the control treatment.

Other WET test design terms describe the way that test organisms are physically exposed to WET test concentrations such as: flow-through, static renewal, and static. In a flow-through test, effluent and dilution water are mechanically renewed continuously. This test setup requires specialized equipment (a serial or proportional dilutor or syringe pumps) and has higher operating costs than a static test. In a static renewal test, the test solutions are replaced periodically (usually daily) with fresh effluent and dilution water. In a static test, the solutions used at the start of the test are not replaced for the test's duration. Both static renewal and static tests require less sophisticated equipment. The decision of which WET test design type is required should be specified in the NPDES permit for both acute and/or chronic tests according to the respective EPA's WET test methods (40 CFR Part 136 and EPA Pacific West Coast methods (EPA, 1995)), which can be incorporated by reference.

WET TEST COMPONENTS

The following discussions pertain primarily to issues in a laboratory audit.

WET tests, as defined in EPA WET test methods (40 CFR Part 136 or EPA's Pacific West Coast WET methods), consist of the following components:

- Sampling, including a chain-of-custody form.
- Effluent.
- Receiving water.
- Dilution water (preferably the receiving water but in some instances a synthetic water approved by the regulatory agency).

- Testing system.
- Test organisms (in house mass cultures or externally purchased).
- QA/QC requirements, including EPA WET test method TACs.
- Reference toxicants.
- WET test data evaluation and analysis.

As described in the EPA approved WET test methods, organisms in the testing system are exposed to a combination of effluent and dilution water to produce WET test results. Each component of the test, including food items, must be of a specific quality for successful toxicity testing. The inspector should determine if the test components adhere to the requirements specified in the NPDES permit and the NPDES EPA WET test method referenced or incorporated into the NPDES permit's general conditions section (e.g., EPA's WET test methods at 40 CFR Part 136). The inspector should review the permittee's sampling logbook, chain-of-custody forms, source of WET test organisms used and the testing laboratory reports for the information necessary to assess the quality of the test components.

Each component has specific requirements (e.g., sample location for the effluent, maximum sample holding time, dilution water constituents, health of the test organisms, appropriate choice of test apparatus materials). Accurate and reproducible test results can only be expected when the critical test components are handled properly. It is, therefore, very important to understand the relationships between these test components and the critical factors that determine the acceptability (e.g., to be considered a valid WET test) of each based on quality assurance requirements and to ensure the validity of the generated WET test results. During a NPDES inspection, the inspector is likely to encounter the critical factors described in the following sections.

EFFLUENT

The effluent sampling strategy should be specified in the NPDES permit. Effluent samples must be representative of the entire final effluent discharge and free of contamination from other sources. The monitoring frequency selected by the permitting authority should be specified in the NPDES permit and should be representative of the permitted effluent discharge including accounting for the variability of the effluent due to several possible factors including but not limited to seasonal changes, facility process variations, available receiving water dilution (if allowed by state water quality standards or permitting regulations for mixing zones), etc. Samples collected to be shipped to an off-site laboratory must be maintained at a temperature ranging from 0° to 6°C by chilling the sample(s) to 6°C during or immediately after collection, shipped in ice to the designated testing laboratory accompanied by a chain-of-custody form, and refrigerated (0° to 6°C) upon receipt by the testing laboratory.

The type and frequency of samples taken (e.g., grab, composite) must be consistent with those required in the NPDES permit. For flow-through tests that are not done by pumping effluent directly into dilutors, daily sample sizes must be sufficient to supply the dilutor for periods ranging from 24 to 36 hours. This volume will depend on the type of WET test being conducted and the number of dilutions being run. For static renewal tests, daily sample volumes should be

sufficient to replenish all dilutions in the test series and provide separate containers of the dilutions to allow for dissolved oxygen (DO), pH, salinity, temperature and other chemical analyses without contaminating the test dilutions. This volume will depend on the type of WET test being conducted and dilutions being run. For static-renewal toxicity tests, composite and grab samples for 7-day chronic testing requires the use of an original sample and two renewal samples over the duration of the test. Preferably, and after using the original sample, renewal samples should be put into use on days 3 and 5 of testing. Table 8-1 provides guidance as to representative sampling strategies for various situations. For some volatile toxicants that are acutely toxic (e.g., chlorine), standard composite sampling does not yield an effluent sample that is representative of the actual permitted effluent discharge due to volatilization of chlorine during sampling, shipping and holding. On-site flow-through testing would yield more appropriate WET test results where, considering available dilution, the effluent contains measurable amounts of chlorine.

Samples for on-site laboratory testing should be used immediately when practical, but must be used within 36 hours of collection. It is usually not possible to refrigerate the large-volume samples (200 liters or more) that are required for flow-through fish tests, but all other samples should be either iced or refrigerated if they are not to be used immediately. Note: hand-delivered samples used on the same day of collection do not need to be cooled at 0° to 6°C prior to WET test initiation.

As a minimum requirement in all cases, tests should be initiated within 36 hours of collection. In the case of short-term chronic tests, samples taken on days one, three, and five may be held for a longer period of time to complete the test. In no case should preservatives be added to or chemical disinfection performed on the effluent sample(s) prior to being tested for toxicity, nor should the effluent samples be dechlorinated unless the permit specifically allows for sample dechlorination.

DILUTION WATER

The choice of dilution water to use in WET tests should be specified in the NPDES permit and depends on the purpose of the toxicity test. Synthetic dilution water is used to evaluate the inherent toxicity of the effluent. Dilution water from the receiving stream or a nontoxic equivalent is used to test for interactions after an effluent discharge thoroughly mixes with the receiving water (where state laws allow for a mixing zone). Receiving waters, synthetic waters, or synthetic waters adjusted to approximate receiving water characteristics may be used for dilution water, if the water meets the qualifications for an acceptable dilution water. EPA WET test methods manuals describe various techniques for the preparation of synthetic dilution water that may be necessary to use if the natural receiving water exhibits unacceptable levels of toxicity. Under no circumstances should the dilution water cause toxic responses in the WET test organisms. A lack of toxic responses or observed impacts to the control treatment organisms is one indicator of the possible suitability of the dilution water. EPA WET test methods specify mandatory TACs for test organisms in control treatments for each test species for both acute and chronic tests for both lethal and sub-lethal endpoints. TAC is further discussed in Section C of this chapter.

Dilution water obtained from receiving waters should be collected following all sampling procedures including the use of a chain-of-custody form, and should be used immediately for testing. If the dilution water will not be used within 24 hours, it should be refrigerated (0° to 6°C) as soon as it is collected. In any case, to ensure that no appreciable change in toxic characteristics occurs before testing, the holding time from the time the receiving water sample is collected to the first use of the receiving water sample in the WET test initiation must not exceed 36 hours unless a variance has been granted. If a delay in the WET test initiation of up to 36 hours is necessary, the receiving water samples must be stored under strict conditions (i.e., temperatures of 0° to 6°C). The location of the receiving water sample should be noted in the permittee's sampling log and the chain-of-custody form. It should be upstream and out of the influence of the permitted outfall. The location should be free of other sources of contamination (e.g., other facility outfalls).

Table 8-1. Recommended Effluent Sampling Strategies for Continuous and Intermittent Discharges for Flow-Through, Static Renewal, and Static Toxicity Tests^a

Continuous Discharge				
TEST TYPE	CHRONIC	ACUTE Retention Time < 14 Days	ACUTE Retention Time >14 Days	
Flow-through**	-	Two Grab samples daily; early a.m. and late p.m.	One grab sample daily.	
Static Renewal	3x 24-hour composite samples, every other day.	Four separate grab samples each day for four concurrent tests.	One grab sample on first day.	
Static	Single 24-hour composite sample on first day.	Four separate grab samples on first day for four concurrent tests.	One grab sample on first day.	
Intermittent Discharge				
TEST TYPE	CHRONIC	ACUTE Continuous Discharge During 1 or 2 Adjacent 8-Hour Shifts	ACUTE Discharge from Batch Treatment	ACUTE Discharge to Estuary on Outgoing Tide
Flow-Through ^b	-	One grab sample midway through shifts daily.	One grab sample of discharge daily.	One grab sample of discharge daily.
Static Renewal	3x 24-hour composite samples collected for duration of discharge unless discharge ceases.	One grab sample midway through shifts on first day.	One grab sample of discharge daily.	One grab sample of discharge daily.
Static	Composite sample collected for duration of discharge, first day.	One grab sample midway through shifts on first day.	One grab sample of discharge on first day.	One grab sample of discharge on first day.

^a Sampling requirements should be clearly specified in the permit.

^b For flow-through tests, it is always preferable to pump directly to the dilutor.

TEST SYSTEM

WET tests may be performed in a fixed or mobile laboratory. Depending on the scope of the program, facilities may include equipment for rearing, holding, and acclimating test organisms. Temperature control is achieved using circulating water baths, heat exchangers, or environmental chambers. Holding, acclimation, and dilution water should be temperature controlled and aerated whenever possible. Air used for aeration must be free of oil and fumes; filters to remove oil in the air are desirable. Test facilities must be well-ventilated and free of fumes. During holding, acclimating, and testing, conditions should remain as constant as possible and test organisms should be shielded from external disturbances (held under the same conditions as those used for testing). Reference toxicants should be properly stored in a closed area separate from the WET testing areas.

Any materials that contact either the effluent or dilution water must not release, absorb, or adsorb toxicants. Many choices for test equipment are available. Properly prepared (see discussion at end of this section) glassware and stainless steel are generally acceptable for effluent freshwater holding, mixing, and transfer to WET test chambers. Stainless steel, however, is not acceptable for saltwater systems. Square-sided glass aquaria should be held together with small beads of silicone adhesive, with any unnecessary adhesive removed from inside the aquaria. If stainless steel containers are used, they must be welded, not soldered. Other specialized containers of Nitex or Teflon™ are also acceptable. Tanks for storing effluents and dilution water may also be made of fiberglass. All containers or tubes made from these materials are reusable with appropriate cleaning (see below).

Polyethylene, polypropylene, polyvinyl chloride, polystyrene, and Tygon® may also be used for containers or tubing, but should be checked for toxicity before being used in a WET test. Because these materials may absorb toxicants during a test, their reuse is discouraged to prevent absorbed toxicants from leaching into new effluent or dilution water.

Copper, galvanized metal, brass, lead, and rubber must not contact the testing solutions at any time.

New plastic ware (from a known nontoxic source) can be used after rinsing with dilution water. New glassware should be soaked overnight in dilute (20 percent) nitric or hydrochloric acid, rinsed in tap water, and then rinsed with dilution water before use.

Glassware and stainless steel components that must be reused should be soaked in an appropriate detergent used for toxicity testing and scrubbed (or washed in a laboratory dishwasher), rinsed twice with tap water, rinsed with dilute acid, rinsed twice with tap water, rinsed with full strength acetone, rinsed twice with tap water, and then rinsed with dilution water before use. Glassware for algae tests should be neutralized in sodium bicarbonate before use.

TEST ORGANISMS

Organisms used for toxicity testing are limited to certain species for which there are established EPA WET testing protocols (40 CFR Part 136 and EPA Pacific West Coast WET Test methods

(EPA, 1995)). Some examples of freshwater and saltwater test species commonly used in WET tests include: a) freshwater—daphnids (water flea, invertebrate) and fathead minnows (fish vertebrate); b) saltwater—algae (plant), mysids (shrimp, invertebrate) and silversides (fish vertebrate). The life stage, source, acclimation and feeding procedures, presence of disease, and the number of organisms placed in test chambers all affect the degree to which test organisms respond to toxicants. Therefore, it is important that these factors comply with EPA's required WET test method procedures. Test conditions for various types of tests and organisms are summarized in the test acceptability criteria tables that can be accessed at <https://www.epa.gov/cwa-methods/whole-effluent-toxicity-methods>.

The inspector should ascertain, as closely as possible, that the following procedures are being observed:

- The correct test organisms (including the choice of test organisms to account for *species sensitivity* for the tested effluent, the most sensitive species must be used under the NPDES permit regulations for reasonable potential determinations (40 CFR 122.44(d)(1)(ii)) must be utilized in the test (most often as specified in the NPDES permit). "Wild" (e.g., collected from the receiving stream) organisms are rarely appropriate in WET testing.
- The laboratory should record the source of test organisms (hatchery, in-house, or elsewhere). Also, test organisms used in toxicity testing must be of known history, free of disease, and acclimated to test conditions. Culture information should be recorded. Test organisms must be of the appropriate age and the appropriate number of organisms must be used in each WET test chamber before initiating a WET test.
- A daily log (that is a daily bench sheet for each WET test being performed) should be kept by the laboratory concerning the WET test organisms including: feeding, mortality, reproduction, growth, mobility, and any abnormal behavioral observations. Measurements for each test chamber should be recorded such as pH, temperature, dissolved oxygen, conductivity, etc. to ensure optimal testing conditions are maintained.
- The testing laboratory must adhere to the following procedures for holding test organisms:
 - Test organisms purchased may be used to start mass cultures. However, if the organisms are to be used for WET chronic testing, then at the start of the test they must be no more than 48 hours old (if fish, purchased and shipped) or no more than 24 hours old (if fish, not shipped, or if freshwater invertebrates such as *Ceriodaphnia dubia*). Freshwater invertebrates used in a test must have been released within an 8-hour period, to avoid impacts on reproductive performance.
 - Maintain DO levels above 4 mg/L for warm water species and above 6 mg/L for cold water species.
- Test organisms should not be subjected to changes of more than 2 units of pH in any 24-hour period or 3 degrees of temperature in any 12-hour period.

- Test organisms should be fed according to the EPA WET test method requirements for the WET test. When feeding is necessary for mysid or fish tests, excess food should be removed daily during renewal by aspirating with a pipette, to avoid problems such as food buildup leading to excessive oxygen demand.
- Test organisms should be handled as little as possible to minimize stress:
 - Dip nets should be used for large organisms (e.g., salmonids).
 - Pipettes should be used for transferring small organisms such as juvenile fathead minnow, fry minnows, silverside fry, and, daphnid or midge larvae.

REFERENCE TOXICANTS

Reference toxicants are used to evaluate the health and sensitivity of WET test organisms over time and for documenting initial and ongoing laboratory performance. A laboratory performs a definitive toxicity test with a reference toxicant at least once per month for each toxicity test method conducted in that month. The monthly WET test results are plotted on a control chart to track trends in organism health or sensitivity.

Although EPA does not require the use of specific reference toxicants or set required acceptance ranges for reference toxicants for reference toxicant testing, EPA does recommend that laboratories conduct frequent reference toxicant tests. EPA recommends that the results of these reference toxicant tests be used to evaluate the health and sensitivity of the test organisms over time and for documenting initial and ongoing laboratory performance. Testing laboratories must perform at least one acceptable reference toxicant test per month for each type of toxicity test method conducted in that month regardless of the source of test organisms. If a test method is conducted only monthly, or less frequently, a reference toxicant test must be performed concurrently with each effluent toxicity test to document ongoing laboratory performance and to assess organism sensitivity and consistency when organisms are cultured in-house. When organisms are obtained from external suppliers, concurrent reference toxicant tests must be performed with each effluent sample tested, unless the test organism supplier provides control chart data from at least the past five months of reference toxicant testing, which will assess organism sensitivity and health. The EPA WET test method manuals require a laboratory to obtain consistent, precise results with reference toxicant toxicity tests with effluents under the NPDES permits. It is important that the reference toxicants should be securely stored in an area separate and away from the laboratory's mass cultures or purchased test organisms to prevent unintended exposure or contamination of test organisms by the reference toxicants. This should be one of the inspector's checklist items when inspecting a WET laboratory.

An attempt should be made to match the type of reference toxicant used (e.g., metal or chlorinated organic) to the major pollutant in the wastewater tested. Reference toxicant data must be included with the testing laboratory report.

Reference toxicant test results should not be used as *de facto* criteria for rejection of individual effluent or receiving water tests. The EPA WET test methods manuals provide guidance for what to do when more than 1 reference test in 20 reference toxicant tests falls outside of

control chart limits, or when a reference toxicant test result falls “well” outside of the control treatment limits. However, when reference toxicity tests indicate possible anomalies, the laboratory should investigate sources of variability, take corrective actions to reduce identified sources of variability, and perform an additional reference toxicant test during the same month.

CONDUCT OF THE TEST(S)

EPA WET test methods should be carried out by analysts who are experienced in the use or conduct of aquatic tests and the interpretation of data from aquatic toxicity testing. Test conditions should match those specified in the summary of test condition tables provided for each EPA WET test method. Physical and chemical measurements taken during the test (e.g., temperature, pH, and DO) must be conducted at the minimum frequency specified in the EPA WET test method manuals. The appropriate procedures are described in each EPA WET test method section of the manuals, by following the table of specified test conditions and required TACs.

RECORDKEEPING AND DATA REPORTING

Proper recordkeeping is essential to an effective NPDES WET test monitoring program. Entities collecting samples for WET testing should consistently use chain-of-custody (COC) procedures to document effluent or receiving water sample transfer. Hand-written entries on bench sheets and COC tags must generally be clear and legible. The analyst should maintain a sample log containing information as to the date, time, and type of sample taken as well as the sampler's name. Unusual conditions should be noted. When evaluating the contract lab's WET test data reporting, the inspector should verify that the following are included:

- Summary of test results, description of test conditions, material tested, test dilution water and other data for quality assurance.
- Methods used for all analyses. The method title, method number, and method source should be provided in the laboratory standard operating procedure (SOP) and test report. Tests must be conducted as stated in the SOP, and the laboratory should verify the test was conducted according to the SOP.
- Date and time test started, date and time test terminated, type and volume of test chambers, volume of solution used per chamber, number of organisms per test chamber, number of replicate test chambers per treatment.
- The test temperature (mean and range), details of whether test was aerated or not, feeding frequency, amount and type of food, and any pH control measures taken.
- The test endpoint(s), and any deviation(s) from EPA's WET test methods (40 CFR Part 136 or EPA Pacific West Coast WET test methods (EPA, 1995)) must be clearly noted.
- The reference toxicity results for WET tests conducted for the test period with specific test details to verify species, temperature, and dilution water used in reference toxicant test.
- Any acclimation of test organisms (temperature mean and range) and the reason(s) for acclimation.

- Any other relevant information.

Any deviations from specifications, as contained in EPA's WET test methods, should be documented and described in the data report by the testing laboratory. Data results for each WET test should include the raw toxicity data in tabular form, including daily records of affected test organisms in each concentration (including control treatments and effluent test concentration replicates); data in graphical form (plots of toxicity data); and a table of LC₅₀s, NOECs, IC₂₅, IC₅₀, etc. (as required in the respective NPDES permit). Records should indicate the statistical approach used to calculate endpoints, include a summary table of physical and chemical data, and include laboratory documentation of variability as part of the quality assurance/quality control (QA/QC). For more information on possible contributing factors to WET variability and recommendations for reducing it, see section 7.3 of EPA's *Understanding and Accounting for Method Variability in Whole Effluent Toxicity Applications Under the National Pollutant Discharge Elimination System Program* (EPA, 2000a).

REVIEW CHECKLIST

While WET test reviews are performed as part of a routine NPDES facility inspection and usually are not comprehensive, the inspector and the permittee should carefully prepare in advance for the inspection. Laboratory inspection reviews can quickly ascertain if the facility is following their NPDES permit requirements and, secondarily, identify any obvious problems with reporting or laboratory performance. Inspectors should refer to the following checklist of possible issues that can be identified during a NPDES facility inspection.

Yes	No	N/A	Does the facility have a copy of its NPDES permit readily available? (Recommended: The inspector should bring a copy of the NPDES permit in the event the permittee does not have a complete copy at the time of inspection)
Yes	No	N/A	Were the WET tests required by the NPDES permit performed? Check the permit for the WET testing frequency and any special conditions related to WET testing, including whether a testing frequency decrease is authorized and the basis or rationale for decreasing the WET testing frequency (which should be documented in the NPDES permit fact sheet). This can be done prior to arriving on-site including contacting the NPDES state permitting authority or EPA if the state is not NPDES authorized.
Yes	No	N/A	Are all test reports for WET tests performed over the last three years available for review?
Yes	No	N/A	Are the test reports complete (e.g., bench data sheets for chemicals and test organisms, reference toxicant test results, chain of custody forms or tags, statistical analyses)?
Yes	No	N/A	Was the correct type of WET test performed including the choice of an appropriate (<i>most sensitive species</i>) WET test species used?

Yes	No	N/A	Did the effluent samples contain any measurable chlorine, or > 10 mg/l ammonia?
Yes	No	N/A	Was the WET test initiated within 36 hours of the first effluent sample being taken? This can be verified by checking the dates and times on the chain-of-custody forms or tags and bench sheets.
Yes	No	N/A	Did the laboratory or permittee make any judgment decisions beyond their authority? If Yes, describe:
Yes	No	N/A	Were there any deviations from the appropriate EPA WET test method? See NPDES permit and EPA WET test methods' test acceptability criteria.
Yes	No	N/A	Were the valid WET test results recorded and did they indicate non-compliance with the NPDES permits? If Yes, what follow-up actions were taken by the permittee and/or the permitting authority?
Yes	No	N/A	Were the WET test results reported correctly by the permittee and on the DMR?
Yes	No	N/A	Was the WET test determined to be invalid due to poor test organism performance in the control treatment?
Yes	No	N/A	If the WET test was declared invalid, was a new effluent sample collected, a new WET test performed and reported?

In the case of a PAI, both the laboratory performing the WET tests and the NPDES permittee are evaluated. This type of inspection requires more extensive information than is presented in this section. The inspector is therefore referred to the EPA's *Manual for the Evaluation of Laboratories Performing Aquatic Toxicity Tests* (EPA, 1991a) for the protocol to perform a PAI.

C. ANALYSIS OF WET DATA

WET test review should be conducted by both the testing laboratory, the permittee, and the NPDES regulatory authority. A review of WET tests includes: checking the WET test conditions; checking WET data or WET test results; and checking EPA WET test methods' TAC for test organisms in the control treatment(s) (and WET test variability for non-lethal endpoints such as the EPA WET test method's required percent minimum significant different (PMSD) determinations). Considerations for each of these WET test reviews are discussed below.

WET test results or WET data need to be interpreted so that compliance with the NPDES permittee's WET permit limits can be determined. For the NPDES permits program, each of EPA WET test methods contain several recommended statistical approaches. In addition, in 2010 EPA HQ (Water Permits Division/Office of Wastewater Management) developed a statistical approach referred to as the Test of Significant Toxicity (TST) as another option for statistically analyzing and interpreting valid WET test data—see EPA's *National Pollutant Discharge Elimination System Test of Significant Toxicity Technical Document* (EPA, 2010a).

The following definitions may help the inspector to interpret the WET test results:

- The LC₅₀ (for lethal concentration) is the calculated percentage of effluent (point estimate) at which 50 percent of the organisms die during the test period. Usually, the LC₅₀ is calculated statistically by computer programs that fit the dose-response curve to a mathematical function. Computer-based calculation procedures usually print an estimate of the error associated with the LC₅₀ estimate.
- The EC₅₀ (for effect concentration) is the calculated concentration (point estimate) at which 50 percent of the organisms indicate a particular impaired response or WET test measured effect (not necessarily death) due to exposure to a toxicant. For some species (e.g., *Ceriodaphnia dubia*—freshwater water flea, invertebrate) where the point of death is not certain, immobility is often used as a surrogate for death. Results for responses like the immobility responses in *Daphnia* (water flea, invertebrate) may be reported as an EC₅₀ (calculated in the same manner as the LC₅₀). Often, however, no distinction is made between the EC₅₀ and the LC₅₀ when the response is a surrogate for death.
- The No Observed Effect Concentration (NOEC) is the highest tested concentration at which the organisms' responses are not statistically different from the control treatment organisms' responses. The NOEC (like the Lowest Observed Effect Concentration (LOEC) and Chronic Value (ChV) defined in the following paragraph) is normally determined only for chronic tests.
- The LOEC is the lowest tested effluent test concentration at which the organisms' responses are statistically different from those in the control treatments.
- The ChV is the calculated geometric mean of the NOEC and LOEC (the square root of the product of the NOEC and LOEC).
- The Inhibition Concentration (IC₂₅) is the calculated percentage of effluent (point estimate) at which the organisms exhibit a 25-percent reduction in a non-quantal biological measurement such as fecundity or growth.
- The percent effect response measured at the critical dilution is reported. For example, state water quality standard (WQS) or NPDES permit WET limit may prohibit toxicity at 100 percent effluent or less. In this case, the observed percent effect response at 100 percent effluent would be reported.
- The response may be reported in Toxic Units (TU), either for Acute (TU_a) or Chronic (TU_c) test endpoints.
- A *no significant toxicity* assessment is a recommended statistical analysis alternative type of NPDES permit limit to a NOEC permit limit, as determined by the EPA's recommended TST statistical approach. No significant toxicity applies when the value calculated using a Welch's t-test is *significantly different* (i.e., greater) than a critical value. Thus, for NPDES permits, the assessment for no significant toxicity is based on statistically analyzing the measured effects at the control treatment to an effluent test concentration, which for NPDES permitting is usually the in-stream waste concentration or IWC. The IWC should be one of the effluent test concentrations in the WET test

usually bracketed by the other effluent test concentrations in a multiple test concentration test design.

Overall, there is an inverse relationship between the degree of toxicity and the effluent concentration percentage causing a toxic response. Therefore, the same toxicity test response (e.g., LC₅₀), at lower percentages of an effluent concentration indicates higher toxicity than WET test results at higher percentages of an effluent concentration. So, the magnitude of a TU indicates the degree of toxicity. TUs are defined as 100/LC₅₀ for acute and 100/NOEC for chronic, with the LC₅₀ or NOEC expressed as a percent effluent concentration. An effluent with an LC₅₀ of 50 percent has an acute toxicity of 2 acute toxic units (100/50 = 2 TU_a). Similarly, an effluent with a NOEC of 25-percent effluent has a chronic toxicity of 4 chronic toxic units (100/25= 4 TU_c). The major advantage of using toxic units to express toxicity test results is that toxic units increase linearly as the toxicity of the effluent increases and so the higher the numeric TU, the greater the magnitude of measured toxicity. Therefore, an effluent with a TU_a of 4 is twice as toxic as an effluent with a TU_a of 2. Additionally, the NOEC, LC₅₀, and other statistical analyses are entered into the national enforcement database, ICIS, as pass/fail, whereas TUs are entered as a discrete number and can therefore reveal more about toxicity over time. EPA's *Technical Support Document for Water Quality-based Toxics Control* (EPA, 1991b) provides a more extensive discussion of the application of toxic units and the relevance to NPDES permits.

Review of Test Conditions. For WET test data submitted under NPDES permits, all required EPA WET test conditions must be met or the WET test is considered invalid and a new WET test is required using a newly collected effluent sample. Deviations from recommended EPA WET test *mandatory requirements* be evaluated on a case-by-case basis to determine the validity of the WET test results. Deviations from *recommended* test conditions may or may not invalidate a WET test result depending on: the degree of the departure from WET test conditions, the objective of the WET test, and the potential or observed impact of the deviation on the WET test result. Consideration of these factors should be carefully considered before rejecting or accepting a WET test result as valid. For example, if dissolved oxygen is measured below 4.0 mg/L in one WET test chamber, the reviewer should consider whether the observed mortality in that WET test chamber corresponds with the drop in dissolved oxygen. Whereas slight deviations in WET test conditions may not invalidate an individual WET test result, test condition deviations that continue to occur frequently in a laboratory may indicate the need for improved quality control in that laboratory.

Each WET test method has specified acceptable ranges of test conditions that are to be met, such as temperature, dissolved oxygen concentration, salinity, pH, light intensity and duration of photoperiod, organism loading (numbers or weight per volume), feeding, and cleaning procedures. WET tests not meeting the test conditions, Test Acceptability Criteria (TAC), and the non-lethal endpoint percent minimum significant difference (PMSD) for a specific WET test method should be carefully reviewed by the inspector. Also, the WET test and the WET test results should be referred to the EPA or state regional biologist and the NPDES regulatory authority (or permit writer). For each parameter discussed in these tables, the parameter is either *recommended (should do)* or *required (must do)*. For example, the chronic *Ceriodaphnia*

dubia test type is required (must) to be conducted. The inspector should review the EPA WET test methods for a more extensive discussion of each of the *recommended (should)* and *required (must)* WET test specifications. The EPA WET test methods manuals for Whole Effluent Toxicity testing can be accessed at <https://www.epa.gov/cwa-methods/whole-effluent-toxicity-methods>.

Review of Calculated WET Test Results. Inspectors should review WET test results (from multi-concentration tests) reported under the NPDES permits program according to EPA guidance on the evaluation of concentration-response relationships (EPA, 2000a). This guidance provides review steps for 10 different concentration-response patterns that may be encountered in WET test data. Based on the review, the guidance provides one of three determinations:

1. The calculated effect concentrations are reliable and should be reported.
2. The calculated effect concentrations are anomalous and should be explained.
3. The test was inconclusive and a new WET test should be conducted using a newly collected effluent sample.

It should be noted that the determination of a valid concentration-response relationship is not always clear cut. Data from some WET tests may suggest consultation with professional toxicologists and/or NPDES regulatory officials. Tests that exhibit unexpected concentration-response relationships may indicate a need for further investigation and possibly require a new WET test to be conducted using a newly collected effluent sample.

Questionable results in an acute test include:

- Higher mortalities in lower effluent test concentrations than in higher effluent test concentrations.
- 100-percent mortality in all effluent test concentrations.
- Greater percent mortality in the control treatment than in the lower effluent test concentrations.

Questionable results in a chronic test include:

- Greater growth or reproduction or fewer terata at higher effluent test concentrations than at lower effluent test concentrations.
- No growth or reproduction or 100-percent terata at all effluent test concentrations.
- Less growth or reproduction or more terata in control treatments than in lower effluent test concentrations.

When any of these abnormalities occur (outside of experimental error), the results and test conditions should be reviewed by the EPA and/or state regional biologist or NPDES toxicologist and reported to the NPDES regulatory authority (permit writer). Part of the inspector's review may also include a review of the laboratory's WET test data results and an explanation or interpretation of the WET test results. DMRs are expected to include this information.

In addition to reviewing the concentration-dose response relationship, the inspector should review within-test variability of individual WET tests. For example, when NPDES permits require chronic sub-lethal hypothesis testing endpoints (e.g., reproduction for the *Ceriodaphnia dubia* test), within-test variability should be reviewed and variability criteria applied as described in the chapter “Report Preparation and Test Review” of each WET test method.

Within-test variability is measured as the percent minimum significant difference (PMSD), and is calculated by the test reporting entity, then compared to established upper and lower bounds for test PMSDs. WET tests conducted under NPDES permits that fail to meet these variability criteria and that show “no toxicity” at the permitted receiving water concentration (i.e., not significantly different from the control treatment) are considered invalid WET tests and a new WET test must be conducted using a newly collected effluent sample. Circumstances that indicate that the results of the WET test may be questionable include: pH of the water was less than 6 or greater than 9, feeding schedule used during the test differed from the feeding schedule recommended in the methods manuals, organism culture was contaminated with rotifers, or if the test was repeated due to laboratory error. For additional circumstances that may yield WET test results with questionable variability, the inspector should refer to EPA’s *Final Report: Interlaboratory Variability Study of EPA Short-term Chronic and Acute Whole Effluent Toxicity Test Methods* (EPA, 2001a).

To avoid penalizing laboratories that achieve unusually high precision, lower PMSD bounds are applied when a hypothesis WET test result (e.g., no observed effect concentration NOEC) or lowest observed effect concentration (LOEC) is reported. Lower PMSD bounds are based on the 10th percentiles of national PMSD data. The 10th percentile PMSD represents a practical limit to the sensitivity of the WET test method because few laboratories can achieve such precision on a regular basis and most do not achieve it even occasionally. In determining hypothesis WET test results, an effluent test concentration is not considered toxic if the relative difference from the control treatment is less than the lower PMSD bounds. See EPA’s *Understanding and Accounting for Method Variability in Whole Effluent Toxicity Applications Under the National Pollutant Discharge Elimination System Program* (EPA, 2000a), for specific examples of implementing lower PMSD bounds.

Review of Test Acceptability Criteria (TAC) for Controls. Each EPA WET test method also has specific required WET test acceptability criteria or TAC (e.g., minimum control survival) that must be achieved to be considered a valid WET test result. See the summary of test conditions and TAC for each specific EPA WET test method. In general, the valid interpretation of WET test results requires that control treatment organisms must meet minimum TAC for survival, growth, and/or reproduction as required by the respective EPA WET test methods. A summary of TACs per EPA WET test method can be found in Table 8-2.

Mortality in control treatments must not exceed 10 percent for acute toxicity tests and 20 percent for chronic tests (or other values as required by states through their regulations). If organism survival in the control treatments does not meet 90 or 80 percent for an acute or chronic test, respectively, then the WET test results should not be used for calculating summary statistics, and a determination of compliance using the WET test results cannot be made. For

chronic tests, test organism in the control treatments must also meet minimum requirements for growth and reproduction contained in the EPA WET test methods manuals. When using dual controls, the dilution water control treatment should, through statistical analysis, be used to determine the acceptability of the WET test control treatment, and for comparisons against the effluent test concentrations.

Table 8-2. Summary of TAC per EPA Method

EPA Method	Organism with Scientific Name	Endpoint Type	Test Type	Minimum # per Test Chamber	Minimum # of Rep per Conc.	Minimum # Effluent Conc.	Test Duration	Test Acceptance Criteria (TAC)
2000.0	Fathead minnow (<i>Pimephales promelas</i>)	Survival	Acute	10	2	5	48–96 hours	> 90% survival in controls
1000.0	Fathead minnow (<i>Pimephales promelas</i>)	Survival and growth (larval)	Chronic	10	4	5	7 days	> 80% survival in controls; average dry weight per surviving organism in control chambers equals or exceeds 0.25 mg
1002.0	Water flea (<i>Ceriodaphnia dubia</i>)	Survival and reproduction	Chronic	1	10	5	Until 60% of surviving control organisms have 3 broods (6–8 days)	> 80% survival and an average of 15 or more young per surviving female in the control solutions. 60% of surviving control organisms must produce three broods
1007.0	Mysid shrimp (<i>Americamysis bahia</i>)	Survival and growth	Chronic	5	8	5	7 days	> 80% survival; average dry weight > 0.20 mg in controls

Table 8-2. Summary of TAC per EPA Method

EPA Method	Organism with Scientific Name	Endpoint Type	Test Type	Minimum # per Test Chamber	Minimum # of Rep per Conc.	Minimum # Effluent Conc.	Test Duration	Test Acceptance Criteria (TAC)
1016.0	Purple urchin (<i>Strongylocentrotus purpuratus</i>) or Sand dollar (<i>Dendraster excentricus</i>)	Fertilization	Chronic	100	4	4	40 min (20 min plus 20 min)	> 70% egg fertilization in controls; %MSD < 25%; and appropriate sperm counts
1017.0	Giant kelp (<i>Macrocystis pyrifera</i>)	Germination and germ-tube length	Chronic	100 for germination 10 for germ-tube length	5	4	48 hours	≥ 70% germination in controls; ≥ 10 μm germ-tube lengths in controls; %MSD of < 20% for both germination and germ-tube length NOEC must be below 35 μg/L in reference toxicant test
1014.0	Red abalone (<i>Haliotis rufescens</i>)	Larval development	Chronic	100	5	4	48 hours	≥ 80% normal larval development in controls Statistical significance @ 56 μg/L zinc % MSD < 20%

Table 8-2. Summary of TAC per EPA Method

EPA Method	Organism with Scientific Name	Endpoint Type	Test Type	Minimum # per Test Chamber	Minimum # of Rep per Conc.	Minimum # Effluent Conc.	Test Duration	Test Acceptance Criteria (TAC)
2002.0	Water flea (<i>Ceriodaphnia dubia</i>)	Survival	Acute	5	4	5	24, 48, or 96 hours	> 90% survival in controls
1003.0	Green algae (<i>Selenastrum capricornutum</i>)	Growth (cell counts, chlorophyll fluorescence, absorbance, or biomass)	Chronic	10,000 cells/mL	4	5	96 hours	Mean cell density of at least 1 X 10 ⁶ cells/mL in the controls; variability (CV%) among control replicates less than or equal to 20%

D. TOXICITY REDUCTION EVALUATIONS AND TOXICITY IDENTIFICATION EVALUATIONS (TRES/TIES)

Toxicity Reduction Evaluations (TREs) and Toxicity Identification Evaluation (TIEs) are procedures used with the EPA's NPDES permits program to enable permittees to identify and reduce toxicity that is observed using WET tests. EPA's TRE and TIE procedures manuals can be found at the following website: <https://www.epa.gov/npdes/npdes-permit-limits#wet>.

A TRE is a site-specific study of the effluent or wastewater at a treatment facility. The TRE process is generally a stepwise process that attempts to identify the class of potential toxicants and, if possible, isolate the chemical causing toxicity. A TRE generally consists of six steps, but all six steps may not be required depending on the facility site-specific situation. Once the identification/isolation process has confirmed the potential cause of toxicity, the evaluation step uses techniques to determine what action(s) is needed to reduce or treat the chemical or chemicals causing toxicity in the effluent. If the evaluation step is completed successfully, the TRE should confirm that the actions chosen to reduce toxicity are successful. There are many possible ways to reduce toxicity depending on the cause of toxicity.

The need for a permittee to conduct a TRE may arise when the NPDES WET permit limit is exceeded during WET monitoring in accordance with the NPDES permit. NPDES WET permit limits are established to prevent excursions from state WET water quality standards, so an exceedance of a WET permit limit can sometimes trigger additional permit requirements. These permit triggers are actions the permittee must take to identify and resolve the toxicity to come back into compliance with the permit. Accelerated WET monitoring is a common permit trigger that can vary from state to state, but there's usually a requirement for more frequent WET testing over a short time period, generally a few weeks, to determine if the toxicity is persistent. If the effluent toxicity is not measured at a level that exceeds the permit limit, based on the data generated by the accelerated WET testing, the permit usually allows for a return to the previous WET monitoring frequency schedule. If toxicity continues to measure in exceedance of the WET permit limit, based on the accelerated WET testing data, then the TRE process is initiated. It is extremely important for the permittee and the permitting authority to agree upon an adequate work plan (developed by the permittee) that includes a schedule and reporting requirements throughout the TRE/TIE process, and especially when the TRE is first initiated.

In practice, most of the TRE work completed by the permittee is conducted through the permittee's labs or consultants. Therefore, it is important for the EPA or state NPDES permitting authority to ensure that the TRE process is on track and that the permittee resolves the toxicity problem in an appropriate and timely manner. The NPDES permitting authority can provide key recommendations to the permittee to ensure that all available information and possible strategies are considered in the evaluation. An important recommendation is that the permittee has a TRE work plan that is sufficiently detailed and includes frequent communication with the NPDES permitting authority. TRE work plan requirements vary from

state to state, but commonly include schedule and reporting requirements to ensure effluent toxicity is reduced or eliminated and compliance with the permit is achieved.

A TRE is most likely to be successful if there is a good partnership between the people who know the facility and the experts in engineering, toxicology, and perhaps hydrology, who know how to determine the causes of the effluent toxicity. For example, the toxicologist on the team can help link water quality characteristics to toxicity for different USEPA WET test species.

Regardless of the facility, a TRE almost always starts with a review of available data, such as influent and effluent chemical and physiochemical data, facility treatment data, and WET test data. Often, a thorough review of these data can be very useful in helping to determine what might be causing toxicity in the effluent. Facility treatment information that is often useful in conjunction with the effluent toxicity data include parameters such as effluent carbonaceous oxygen demand (COD), biological oxygen demand (BOD), mixed liquor solids, volatile solids, and removal rates of COD and BOD based on influent and effluent concentrations. The work plan should include the data and other information available for the evaluation, any interim reports or other deliverables to be sent to the NPDES permitting authority, and the roles and responsibilities of the TRE plan's team members.

One optional step in the six-step TRE approach is to identify the *exact cause of effluent toxicity*. This is commonly referred to as a Toxicity Identification Evaluation or TIE. Although not necessary, a TIE can often be very helpful in a TRE because toxicity can be more certainly controlled if the identity of the toxicant(s) is known. In general, the TIE is a three-phase process that characterizes, identifies and confirms the cause or causes of toxicity. Guidance documents for each of the three phases of toxicity identification evaluations and the Phase I TIE for chronically toxic effluents can be found at the EPA website provided at the beginning of this section. A TIE couples effluent chemical analysis and WET test results. Although sometimes it may take additional effort to identify the exact cause of effluent toxicity, particularly in very complex effluent situations, experienced WET testing laboratories and consultants can help ensure that the TIE is not an expensive, time-consuming venture. TIEs are applicable to evaluating toxicity of permitted effluents, ambient waters and sediments including bulk sediment or pore waters.

The role of the NPDES permitting authority in TIEs is to support innovative approaches that are technically feasible and scientifically sound, and to discourage approaches that are costly and/or not results-oriented. In some instances, the discharger may need to use novel approaches to identify the cause of toxicity. The NPDES permitting authority can assist the permittee by providing technical information where appropriate. However, conducting the TIE/TRE is the responsibility the permittee. The role of the NPDES permitting authority is to allow the TIE/TRE process to proceed and to confirm that the permittee is making good progress towards completing the TRE.

In addition to NPDES permit conditions, there are several other mechanisms that the NPDES permitting authority can use to require a permittee to conduct a TRE. The NPDES permitting authority can require a TRE through a CWA section 308 letter, a CWA section 309

administrative order, or as part of the Consent Decree requirements in the settlement of a civil judicial enforcement action. The role of the inspector is to evaluate whether the permittee has met the TRE/TIE milestones and to verify whether the permittee has implemented the selected controls and eliminated toxicity.

E. REFERENCES

The following is a list of resources providing additional information on toxicity and testing.

U.S. Environmental Protection Agency. (1991a). *Manual for the Evaluation of Laboratories Performing Aquatic Toxicity Tests*. EPA 600-4-90-031.

U.S. Environmental Protection Agency. (1991b). *Technical Support Document for Water Quality-based Toxics Control*. EPA 505-2-90-01.

U.S. Environmental Protection Agency. (1995). *Short-term methods for estimating the chronic toxicity of effluents and receiving waters to West Coast marine and estuarine organisms*. EPA 600-R-95-136.

U.S. Environmental Protection Agency. (1996). *Clarifications Regarding Flexibility in Part 40 CFR Part 136 Whole Effluent Toxicity (WET) Test Methods*. EPA Memorandum.

U.S. Environmental Protection Agency. (1997). *Clarifications Regarding Whole Effluent Toxicity Test Methods Recently Published at Part 40 CFR Part 136 and Guidance on Implementation of Whole Effluent Toxicity in Permits*. EPA Memorandum.

U.S. Environmental Protection Agency. (1999a). *Errata for the Effluent and Receiving Water Toxicity Testing Manuals*. EPA 600-R-98-182.

U.S. Environmental Protection Agency. (1999b). *Whole Effluent Toxicity: Guidelines Establishing Test Procedures for the Analysis of Pollutants, Whole Effluent Toxicity Tests; Final Rule, Technical Corrections*. Office of Science and Technology, Engineering and Analysis Division. 64 FR 4975.

U.S. Environmental Protection Agency. (1999c). *Toxicity Reduction Evaluation Guidance for Municipal Wastewater Treatment Plants*. Office of Wastewater Management, Water Permits Division. EPA 833-B-99-002.

U.S. Environmental Protection Agency. (2000a). *Understanding and Accounting for Method Variability in Whole Effluent Toxicity Applications Under the National Pollutant Discharge Elimination System Program*. Office of Wastewater Management, Water Permits Division. EPA 833-R-00-003.

U.S. Environmental Protection Agency. (2000b). *Method Guidance and Recommendations for Whole Effluent Toxicity (WET) Testing (40 CFR Part 136)*. Office of Science and Technology, Engineering and Analysis Division. EPA 821-B-00-004.

- U.S. Environmental Protection Agency. (2001a). *Final Report: Inter-laboratory Variability Study of EPA Short-term Chronic and Acute Whole Effluent Toxicity Test Methods, Vol. 1*. Office of Science and Technology, Engineering and Analysis Division. EPA 821-B-01-004.
- U.S. Environmental Protection Agency. (2001b). *Final Report: Inter-laboratory Variability Study of EPA Short-term Chronic and Acute Whole Effluent Toxicity Test Methods, Vol. 2: Appendix*. Office of Science and Technology, Engineering and Analysis Division. EPA 821-B-01-005.
- U.S. Environmental Protection Agency. (2001c). *Clarifications Regarding Toxicity Reduction and Identification Evaluations in the National Pollutant Discharge Elimination System Program*.
- U.S. Environmental Protection Agency. (2002a). *Methods for Measuring the Acute Toxicity of Effluents and Receiving Waters to Freshwater and Marine Organisms*. EPA 821-R-02-012.
- U.S. Environmental Protection Agency. (2002b). *Short-term Methods for Estimating the Chronic Toxicity of Effluents and Receiving Waters to Freshwater Organisms*. EPA 821-R-02-013.
- U.S. Environmental Protection Agency. (2002c). *Short-term Methods for Estimating the Chronic Toxicity of Effluents and Receiving Waters to Marine and Estuarine Organisms*. EPA 821-R-02-014.
- U.S. Environmental Protection Agency. (2002d). *Guidelines Establishing Test Procedures for the Analysis of Pollutants; Whole Effluent Toxicity Test Methods; Final Rule*. 40 CFR Part 136.
- U.S. Environmental Protection Agency. (2010a). *National Pollutant Discharge Elimination System Test of Significant Toxicity Technical Document*. EPA 833-R-10-004.
- U.S. Environmental Protection Agency. (2010b). *National Pollutant Discharge Elimination System Test of Significant Toxicity Implementation Document*. EPA 833-R-10-003.
- U.S. Environmental Protection Agency. (2010c). *NPDES Permit Writer's Manual: Chapter 6. Water Quality-Based Effluent Limitations*. EPA 833-K-10-001.
- U.S. Environmental Protection Agency. (2016). *Clean Water Act Methods Update Rule for the Analysis of Effluent - Final Rule*. Available at: <https://www.epa.gov/cwa-methods/methods-update-rule-support-documents>

CHAPTER 9 – PRETREATMENT

Contents

A. Review of the General Pretreatment Regulations	173
Development of 40 CFR Part 403	173
Summary and Background	174
Program Development and NPDES Requirements.....	175
Approval Authority Responsibilities	180
Control Authority Responsibilities.....	180
Industry Responsibilities	182
B. Pretreatment Compliance Inspections and OTHER COMPLIANCE EVALAUTION ACTIVITIES..	189
Scope of PCIs and Audits	189
PCI Checklist Components and Inspection Report	191
Pretreatment Audit Checklist Components	192
C. References.....	193

List of Tables

Table 9-1. Summary of the General Pretreatment Regulations	184
Table 9-2. Categorical Pretreatment Standards	188

List of Exhibits

Exhibit 9-1. Approval Authority versus Control Authority	177
Exhibit 9-2. Pretreatment Implementation Flow Diagram	179

Related Websites

Office of Wastewater Management (OWM) National Pretreatment Program Homepage:
<https://www.epa.gov/npdes/national-pretreatment-program#overview>

A. REVIEW OF THE GENERAL PRETREATMENT REGULATIONS

DEVELOPMENT OF 40 CFR PART 403

In addition to materials in this chapter, inspectors must be familiar with Chapter 1, "Introduction," and Chapter 2, "Inspection Procedures."

The Clean Water Act (CWA) requires the Environmental Protection Agency (EPA) to promulgate regulations to control the discharge of pollutants to the Nation's waters to preserve their physical, chemical, and biological integrity. The CWA addresses the problem of indirect discharges of pollutants from industrial and commercial users of Publicly Owned Treatment Works (POTWs) to waters of the United States by requiring the EPA to promulgate federal standards for the pretreatment of wastewater discharged to a POTW. See CWA section 307(b)(3). To address indirect discharges from nondomestic users⁴ to POTWs, EPA has established the National Pretreatment Program as a component of the National Pollutant Discharge Elimination System (NPDES) program. (The NPDES permitting program is the primary regulatory mechanism to control point-source discharges to the surface waters of the United States.) Pretreatment regulations apply to all nondomestic sources that introduce pollutants into a POTW. These sources of indirect discharges are more commonly referred to as Industrial Users (IUs). The National Pretreatment Program requires industrial and commercial dischargers to treat or control pollutants in their wastewater before discharge to POTWs that could pass through or interfere with the treatment plant, impact the collection system, threaten worker health and safety, or contaminate sludges.

The CWA provides for EPA to approve states to administer their own NPDES program under prescribed conditions. Authorized state NPDES programs must have authority to issue permits for discharges from POTW that assure that compliance with pretreatment standards by significant sources subject to such standards (see CWA section 402(b)(8)).

EPA initially promulgated the General Pretreatment Regulations (40 CFR Part 403) on June 26, 1978. The regulations have been revised and updated multiple times. The most recent significant update to the Pretreatment Regulations was promulgated on October 14, 2005 (70 FR 60134). The 2005 rule, known as the Pretreatment Streamlining Rule, includes revisions that reduce the overall regulatory burden on both industrial users of the POTW system (IUs) and the pretreatment program Control Authorities (as explained below and defined in 40 CFR 403.3) without adversely affecting environmental protection. The rule is available at <https://www.epa.gov/npdes/npdes-pretreatment-streamlining-rule-fact-sheets>. It differs from other major amendments to the General Pretreatment Regulations in that it increased POTW flexibility in program implementation, allowing, in certain instances, a reduction in minimum program requirements. Approved pretreatment programs in existence at the time of the Streamlining Rule are likely based on the older, more restrictive requirements. POTWs may need to modify their approved pretreatment programs.

⁴ Pretreatment regulations apply to all nondomestic sources that introduce pollutants into a POTW. These sources of indirect discharges are more commonly referred to as Industrial Users (IUs).

A summary of the General Pretreatment Regulations is provided in Table 9-1. Major technical changes resulting from final regulatory amendments or court decisions are included in this table.

SUMMARY AND BACKGROUND

The three specific objectives cited in 40 CFR 403.2 of the General Pretreatment Regulations are to:

- Prevent the introduction of pollutants that would cause interference with the POTW system or limit the use and disposal of its sludge.
- Prevent the introduction of pollutants that would pass through the treatment works or be otherwise incompatible.
- Improve the opportunities to recycle or reclaim municipal and industrial wastewaters and sludges.

In addition, objectives of the pretreatment program include improved POTW worker health and safety and reduction of influent loadings to sewage treatment plants. Briefly stated, the definitions for interference and pass through are the following (see 40 CFR 403.3 for exact definitions):

- “Interference” is a discharge that alone or in conjunction with other discharges, disrupts the POTW or sludge processes, uses, and disposal, and therefore causes violation of any requirement of the POTW's NPDES permit or prevents the POTW from using its chosen sludge use or disposal practice.
- “Pass through” is a discharge that exits the POTWs to waters of the United States in quantities or concentrations which, alone or in conjunction with other discharges, causes a POTW NPDES permit violation.

The General Pretreatment Regulations detail the procedures, responsibilities, and requirements of EPA, states, POTWs, and IUs. All regulated entities must properly implement their part of the pretreatment program for regulatory objectives to be met. The specific responsibilities of each are explained below.

EPA has chosen to promulgate pretreatment standards at the same time it promulgates effluent limitations guidelines for industry categories of direct dischargers under CWA sections 301(b) and 304(b). These pretreatment standards are applicable to industrial indirect dischargers—those discharging to POTWs—and are known as categorical pretreatment standards. EPA has also developed other nationally applicable pretreatment standards (*national pretreatment standards*) under CWA section 307(b) in its General Pretreatment Regulations for Existing and New Sources of Pollution at 40 CFR Part 403. Such pretreatment standards are applicable to any user of a POTW, defined as a source of an indirect discharge (40 CFR 403.3(i)).

These national pretreatment standards include 1) a general prohibition and 2) specific prohibitions. The general prohibition prohibits any user of a POTW from introducing a pollutant

into the POTW that will cause pass through or interference. As noted above, EPA's regulations define both pass through and interference. In addition, under the Pretreatment Regulations, certain POTWs must develop and enforce local limits to implement the general and specific prohibitions of the regulations at 40 CFR 403.5(a)(1) and (b). Local limits that are developed by a POTW in accordance with the regulations are pretreatment standards for purposes of section 307(d) of the CWA (40 CFR 403.5(d)). See also 40 CFR 403.3(l) ("The term *National Pretreatment Standard, Pretreatment Standard, or Standard* ... includes any prohibitive discharge limits established pursuant to Part 403.5.").

The term Publicly Owned Treatment Works or POTW means a treatment works as defined by section 212 of the CWA, which is owned by a state or municipality (as defined by section 502(4) of the CWA). This definition includes any devices and systems used in the storage, treatment, recycling and reclamation of municipal sewage or industrial wastes of a liquid nature. It also includes sewers, pipes and other conveyances only if they convey wastewater to a POTW Treatment Plant. The term POTW also means the municipality as defined in section 502(4) of the CWA, which has jurisdiction over the discharges to and from such a treatment works.

Many of the specific prohibitions for discharge into a POTW system found in 40 CFR 403.5(b) provide municipalities with the basis for instituting a proactive capacity, management, operation, and maintenance (CMOM) program; and protecting the collection system from degradation due to explosion, corrosion, and obstruction. If they are not yet required to implement a local pretreatment program by the terms of 40 CFR Part 403 or equivalent state law, then such municipalities should evaluate implementation of local pretreatment controls, particularly if locations of overflows such as Sanitary Sewer Overflows (SSOs) and Combined Sewer Overflows (CSOs) are predictable (based on facility history) and persistent. The regulations at 40 CFR Part 403 authorize the creation of a local pretreatment program, even if it is not required by state or federal law.

Guidance manuals developed to assist EPA Regional Offices, States, and POTWs with implementation of the National Industrial Pretreatment Program are available on EPA's NPDES Pretreatment Publications website (<https://www.epa.gov/npdes/national-pretreatment-program-events-training-and-publications#publications>). Select publications are listed in Section C, "References," of this chapter.

PROGRAM DEVELOPMENT AND NPDES REQUIREMENTS

The General Pretreatment Regulations at 40 CFR 403.8(a) require all POTWs with design flows greater than 5 million gallons per day (MGD) and receiving industrial discharges that pass through or interfere with the operation of the POTW, or are otherwise subject to Pretreatment Standards, to develop local pretreatment programs (unless the state government has elected to administer the local program). EPA or a state authorized to implement a state pretreatment program) may also require other POTWs to implement pretreatment programs. A POTW with an approved local pretreatment program is the "Control Authority." The terms of the POTW Control Authority's NPDES permit describes its implementation and enforcement responsibilities with respect to the local pretreatment program. Failure to adequately comply

with its terms constitutes an NPDES violation that could subject the POTW to an enforcement action.

States with authority to approve local pretreatment programs are responsible for overseeing and coordinating the development and approval of these local pretreatment programs. Before state approval is obtained, EPA is the Approval Authority for local pretreatment programs. States with NPDES pretreatment programs must receive EPA authorization before they may function as Approval Authorities for pretreatment. The conditions for approval of an NPDES state pretreatment program are found at 40 CFR 403.10.

The EPA is the Approval Authority until a state is authorized to administer the pretreatment program. Once a state is authorized, the EPA maintains oversight responsibilities and enforcement authority. A state can serve as both the Approval Authority for local programs and as the Control Authority for IUs that discharge to POTWs without an approved local program. POTWs never serve as Approval Authorities. See Exhibit 9-1 for a visual representation of Control Authority and Approval Authority. Before any pretreatment inspection, the inspector should gain a clear understanding of who serves as the Approval Authority and the Control Authority in the municipality.

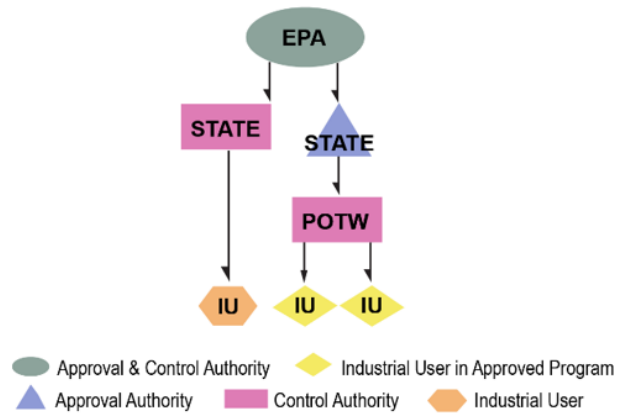

Authorized States

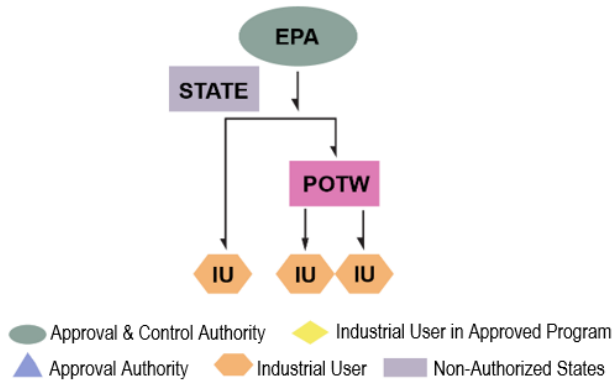

Non-Authorized States

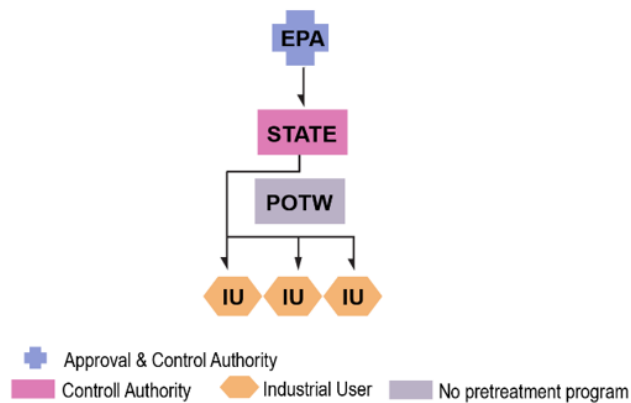

**States Assuming Direct Responsibility
Under 40 CFR 403.10(e)**

Exhibit 9-1. Approval Authority versus Control Authority

The NPDES permit issued to a POTW that is required to develop a pretreatment program must include development and implementation requirements that become enforceable components of the permit. The General Pretreatment Regulations detail the requirements of a pretreatment program and implementation of the program. Among other things, POTWs must have the legal authority to control the contribution the POTW receives from significant industrial users (SIUs)⁵ through a permit, order or similar means that may include either general or individual control mechanisms. Individual permits or general control mechanisms authorize the discharge of wastewater to a POTW upon condition that the discharger complies with the permit terms. An SIU permit is effective for only a limited period and must be revocable by the issuing authority at any time for just cause. In addition, the Control Authority's legal authority will typically include a provision that forbids the discharge of industrial wastewater from an SIU without a current Industrial User permit.

An IU individual permit or general control mechanism should describe, in a single document, all the duties and obligations of the permittee including all applicable Pretreatment Standards and Requirements (40 CFR 403.8(f)(2)). At a minimum, it must include the following:

- Prohibited discharge standards, applicable categorical standards, local limits.
- Effluent limits (including Best Management Practices (BMPs) that are based on applicable general Pretreatment Standards, categorical Pretreatment Standards, local limits, and state and local law.
- Monitoring and reporting requirements.
- Statement of permit duration.
- Statement of nontransferability.
- Statement of applicable civil and criminal penalty.
- Requirements to control slug discharges if determined by the POTW to be necessary.

Permits should not simply reference the applicable laws, but they must contain effluent limitations (expressed in terms of concentration or mass of pollutants that may be discharged over a given period including applicable BMPs), schedules for monitoring and reporting, requirements regarding sampling location and scope, and actual civil and criminal penalties as set forth by the POTW's legal authority. Such conditions must reflect the most stringent of applicable federal, state, and local Pretreatment Standards and Requirements.

⁵ The term *significant industrial user* is defined at 40 CFR 403.3(v)(1).

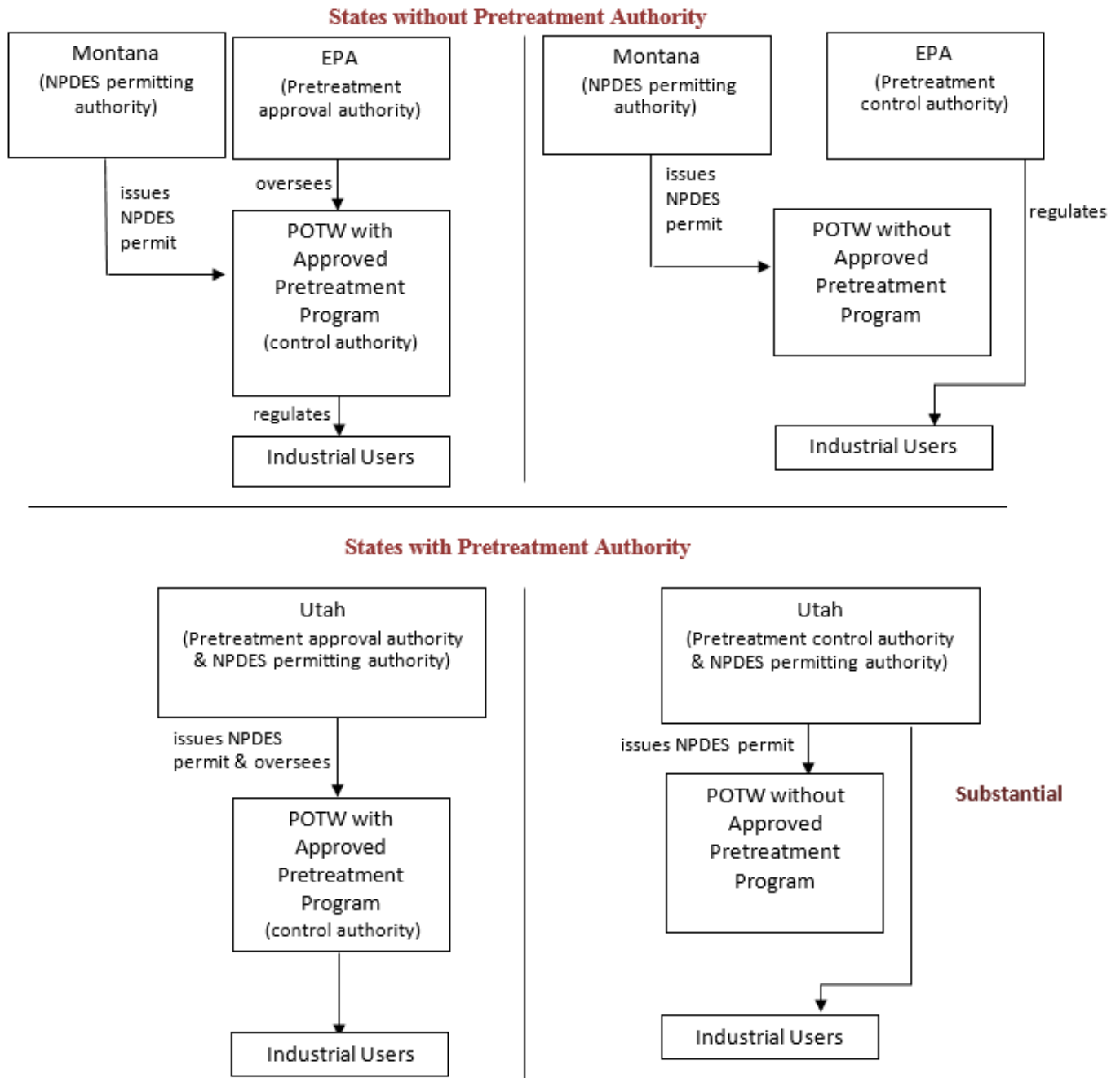

Exhibit 9-2. Pretreatment Implementation Flow Diagram

APPROVAL AUTHORITY RESPONSIBILITIES

The EPA Regional Office or an approved state administers a pretreatment program. The principal tasks for which an Approval Authority (EPA Regional Office or delegated state) is responsible are the following:

- Reviewing and approving POTW pretreatment programs and minor modifications (see "Control Authority Responsibilities" for what Control Authority program development entails).
- Overseeing POTW program implementation—i.e., conducting Pretreatment Compliance Inspections (PCIs) and audits—and reviewing annual report reviews.
- Providing POTWs with technical assistance on the requirements of the General Pretreatment Regulations, categorical pretreatment standards, and POTW pretreatment program requirements.
- Notifying POTWs of new and existing program requirements.
- Determining SIU and POTW compliance with all applicable federal requirements.
- Applying and enforcing pretreatment standards and requirements at IUs discharging to POTWs that do not have an approved local pretreatment program.
- Initiating enforcement action against noncompliant POTWs or IUs.

The General Pretreatment Regulations at 40 CFR 403.10 identify the requirements a state must meet to receive approval of the pretreatment program as part of its NPDES authority, that is, to become an Approval Authority. For states preferring to assume the responsibility of directly regulating IUs discharging to POTWs and, hence, being considered the Control Authority in lieu of POTWs within the state, 40 CFR 403.10(e) provides that option.

CONTROL AUTHORITY RESPONSIBILITIES

Before the Approval Authority approves a POTW to operate the local Authority's pretreatment program as the Control Authority, the Approval Authority (EPA or State) is the Control Authority for IUs discharging to the POTW. After program approval, the Control Authority becomes responsible for implementing the General Pretreatment Regulations (40 CFR 403.8(f)), its approved local POTW pretreatment program, and the requirements of its NPDES permit. Note the POTW must comply with its NPDES permit regardless of program approval. To fully implement the pretreatment program throughout the entire service area, the Control Authority has responsibilities related to several specific areas:

- As provided in 40 CFR 403.8(f)(1), the Control Authority must have the legal authority to:
 - Deny (or condition) any new or increased contribution to the POTW from each IU.
 - Require IUs to comply with applicable pretreatment standards and requirements.
 - Require development of compliance schedules for the installation of technology necessary to meet pretreatment standard.

- Control through permit, order, or similar means the contribution of each IU to ensure compliance with applicable pretreatment requirements.
- Require submission of notices and self-monitoring reports as necessary to assure IU compliance and carry out all required inspections, surveillance, and monitoring necessary to determine industrial user compliance.
- Enter premises of IUs to assure compliance.
- Obtain remedies for noncompliance including seeking injunctive relief for noncompliance; Seeking or assessing civil or criminal penalties of at least \$1,000 a day per violation; Immediately halting a discharge that presents or appears to present an imminent endangerment to the health or welfare of persons or to the environment or that threatens to interfere with the POTW's operation.
- Comply with confidentiality requirements.
- Develop and enforce an adequate sewer use ordinance, and if necessary, interjurisdictional agreements.
- As provided in 40 CFR 403.8(f)(2) and 403.5(c), the Control Authority must develop and implement procedures to ensure compliance with pretreatment standards including:
 - Identify and locate all possible IUs that may be subject to the pretreatment program.
 - Identify the character and volume of pollutants contributed to the POTW.
 - Notify all IUs of appropriate pretreatment standards, any changes to the regulations, and applicable requirements of the Resource Conservation and Recovery Act (RCRA).
 - Update the industrial survey to identify new IUs that should be regulated by the Control Authority's pretreatment program, and identify changes in manufacturing processes and wastewater discharge characteristics at existing facilities.
 - Identify categorical IUs that qualify as non-significant categorical IUs or middle tier IUs and determine appropriate permitting and monitoring requirements if state and local legal authority allows the control authority to make such designations.
 - Maintain a list of SIUs and submit updates to the Approval Authority annually.
- As provided in 40 CFR 403.8(f)(2), to ensure IU compliance, the Control Authority must:
 - Establish reporting, inspection, and monitoring requirements and procedures to enable evaluation of compliance, including proper QA/QC and chain-of-custody procedures for sampling and analysis.
 - Inspect and sample IUs. At a minimum, SIUs must be sampled and inspected at least once a year.
 - Evaluate each SIU at least once for the need for a slug discharge control program.
 - Perform sampling and analysis in a manner to produce evidence admissible in enforcement proceedings or in judicial actions.
 - Develop and implement an Enforcement Response Plan to guide compliance evaluation and enforcement activities.

- Evaluate industry compliance by reviewing and analyzing industrial user self-monitoring reports and Control Authority monitoring data.
- Investigate instances of noncompliance.
- Initiate appropriate enforcement action to bring users into compliance.
- Establish other procedures as required and/or determined to be needed to regulate the SIUs discharging to the POTW.
- As provided in 40 CFR 403.8(f)(2)(viii), the Control Authority must develop and implement procedures to comply with public participation requirements of EPA regulations, including:
 - Develop and implement a procedure to evaluate IUs that are in significant noncompliance as defined in 40 CFR 403.8(f)(2)(vii).
 - Publish at least annually, in the local newspaper with the greatest circulation, a list of the IUs that were in significant noncompliance within the past 12 months.
 - Notify the public of any changes to the sewer use ordinance or local limits after approval by the Approval Authority.
 - Submit substantial pretreatment program modifications to the Approval Authority and notify the Approval Authority of non-substantial modifications.
- Data management:
 - Maintain records of pertinent industrial user activities and compliance status, including compliance with Best Management Practices (BMP) requirements.
 - Maintain a current understanding of the categorical pretreatment standards and General Pretreatment Regulations, and notify IUs of any changes.
 - Provide the Approval Authorities with any reports required.
- As provided in 40 CFR 403.8(f)(3), the Control Authority must:
 - Provide adequate resources and qualified personnel for program implementation.

INDUSTRY RESPONSIBILITIES

Industrial dischargers to POTWs must comply with the following:

- Prohibited Discharge Standards—The general and specific prohibited discharge standards (40 CFR 403.5) noted in Table 9-1 and any specific local limits required to implement the prohibitions.
- Appropriate Pretreatment Standards—Categorical pretreatment standards (40 CFR Parts 405–471), state requirements.
- Reporting Requirements—As required by 40 CFR 403.12 or 403.3, and/or by the Control Authority. The requirements provided in 40 CFR 403.12 are summarized in Table 9-1.
- POTW Requirements—As specified in the approved POTW’s legal authority.

The categories for which the EPA has developed categorical pretreatment standards are listed in Table 9-2. IUs that meet a pretreatment standard's applicability are considered categorical IUs. Categorical pretreatment standards are national, uniform, technology-based standards that apply to dischargers to POTWs from specific industrial categories (i.e., indirect dischargers). They are designed to prevent the discharge of pollutants that pass through, interfere with, or are otherwise incompatible with the operation of POTW. Dischargers subject to categorical pretreatment standards are required to comply with those standards by a specified date, typically no more than three years after the effective date of the categorical standard. EPA develops these standards at the same time it is developing effluent limitations guidelines for specific industry categories and typically, like effluent limitations. These categorical pretreatment standards apply to the wastewaters from specific manufacturing processes. The standards apply at the point of discharge from the pretreatment unit for the regulated process, or if there is no pretreatment unit, they apply at the end of the regulated process.

As previously noted, EPA has also developed national pretreatment standards that apply to all indirect dischargers that include general prohibitions (i.e., no pass through or interference) and specific prohibitions (e.g., no introduction of pollutants that create a fire hazard). To protect the POTW system from interference, pass through, and sludge contamination or any of the specific prohibitions, the Control Authority must develop and enforce local limits to control the introduction of such pollutants. These local limitations are generally applied at the point where the industrial facility discharges to the POTW.

Where there is both a categorical pretreatment standard and local limit applied over the same time period (e.g., both daily maximum limits), a categorical industrial user must meet the categorical pretreatment standard or the local limit for each pollutant regulated, whichever is the more stringent. The point at which the Control Authority's local limit applies may differ from the point at which the categorical pretreatment standard applies. In this case, the control authority must either calculate an adjustment to the categorical pretreatment standard to compare it to the local limit or sample at both points to determine compliance with both the categorical pretreatment standards and local limits.

When evaluating the pretreatment standards to determine the appropriate limitation, the inspector should understand that different categorical pretreatment standards are developed for each type of industry. If the industry combines the flows from more than one regulated process or combines a regulated process flow with other flows before these wastes are treated, the Control Authority and the industry must adjust the categorical pretreatment standard using the Combined Wastestream Formula (CWF). The equation is provided in 40 CFR 403.6(e) of the General Pretreatment Regulations. If the wastewaters are mixed after treatment, the categorical pretreatment standards must still be adjusted, in this case by flow weighted averaging of all flows introduced prior to the sample point. In either case, the resulting alternative limit cannot be set below the level of detection for that pollutant. Additional information on the combined wastestream formula and the flow weighted averaging formula is provided in EPA's *Guidance Manual for Implementing Production-Based Pretreatment Standards and the Combined Wastestream Formula* (EPA, 1985) available at <https://www3.epa.gov/npdes/pubs/owm0260.pdf>.

Categorical IUs have specific reporting requirements as per 40 CFR 403.12 and the respective categorical standard regulation. A summary of the reports that categorical industries are required to submit is provided in Table 9-1. A Control Authority may require additional reports from all IUs discharging to the system, including categorical IUs. A control authority may reduce sampling and reporting requirements for facilities that meet the definition of non-significant categorical IUs or middle-tier categorical IUs established by the pretreatment streamlining rule.

Table 9-1. Summary of the General Pretreatment Regulations

403.1	Purpose and Applicability
403.2	Objectives of General Pretreatment Regulations
403.3	Definitions
403.4	State or Local Law
	The Federal General Pretreatment Regulations are not meant to affect any state or local regulatory requirements as long as these requirements are at least as stringent as the federal regulations.
403.5	National Pretreatment Standards: Prohibited Discharges
	This section specifies general and specific prohibited discharge standards that Control Authorities must incorporate into their pretreatment programs. The general prohibitions specify that pollutants introduced into POTWs by a nondomestic source shall not pass through the POTW or interfere with the operation or performance of the works. The section provides that Control Authorities required to develop local pretreatment programs and POTWs where interference and pass through are likely to recur develop and enforce specific limitations (local limits, including Best Management Practices) to implement the general prohibitions against interference, pass through, and sludge contamination.
	The specific prohibitions specify prevention of discharge of pollutants that cause any of the following at the POTW:
	<ul style="list-style-type: none"> • Fire or explosion hazard, including no discharge with a closed-cup flashpoint of less than 60°C (140°F) using test methods in 40 CFR 261.21. • Corrosive structural damage (no pH<5.0). • Obstruction to the flow in the POTW. • Interference.
	<ul style="list-style-type: none"> • Heat causing inhibition of biological activity and temperatures at the POTW treatment plant to exceed 40°C (104°F). • Petroleum oils, non-biodegradable cutting oils, or products of mineral oils in amounts that will cause interference or pass through. • Fume toxicity or reactivity. • Trucked or hauled pollutants except at designated discharge points.

Table 9-1. Summary of the General Pretreatment Regulations

	Additionally, IUs are provided with an affirmative defense (if specified conditions are met) for actions brought against them for alleged violations of the general or specific prohibitions contained in this section.
403.6	National Pretreatment Standards: Categorical Standards
	This section discusses development and implementation of categorical pretreatment standards including, but not limited to, compliance deadlines, concentrations and mass limits, prohibition of dilution as a substitute treatment, and the Combined Wastestream Formula (CWF) to determine discharge limitations.
403.7	Revision of Categorical Pretreatment Standards to Reflect POTW Removal of Pollutants
	This section (referred to as the removal credits provision) provides the criteria and procedures to be used by a POTW in revising the pollutant discharge limits specified in categorical pretreatment standards to reflect removal of pollutants by the POTW.
403.8	Pretreatment Program Requirements: Development & Implementation by POTW
	This section covers the requirements for pretreatment program development by a Control Authority. Included in this section are criteria for determining which POTWs must develop pretreatment programs, incorporation of approved programs and compliance schedules into NPDES permits, deadlines for program approvals, and program and funding requirements. 403.8(f) sets out the requirements for an approvable POTW program. Specifically, it requires, among other things, that the Control Authority must have sufficient legal authority to enforce the approved pretreatment program that must include either individual industrial user control mechanisms such as a permit as well as, in certain cases, general control mechanisms for groups of similar IUs. The section also discusses that all Control Authorities with approved programs, or programs under development, must develop and implement procedures to ensure compliance with the requirements of a pretreatment program (which includes annual inspection and sampling requirements and the definition of SNC).
403.9	Control Authority Pretreatment Programs and/or Authorization to Revise Pretreatment Standards: Submission for Approval
	This section discusses requirements and procedures for submission and review of Control Authority pretreatment programs. Included in this section are discussions of conditional program approval, approval authority action, and notification where submissions are defective.
403.10	Development and Submission of NPDES State Pretreatment Programs
	This section discusses requirements and procedures for submission and review of NPDES state pretreatment programs. Included in this section are discussions of approvals and deadlines for state programs, legal authority, program and funding requirements, and contents of program submissions.
403.11	Approval Procedures for Control Authority Pretreatment Programs and Revision of Categorical Pretreatment Standards

Table 9-1. Summary of the General Pretreatment Regulations

	<p>This section provides the administrative procedures for the review and approval or denial of Control Authority pretreatment program submissions and requests for removal credit authority.</p>
403.12	<p>Reporting Requirements for POTWs and IUs</p>
	<p>This section presents reporting requirements for Control Authorities and IUs. Reports required by IUs include the following:</p> <ul style="list-style-type: none"> • Baseline Monitoring Report (BMR). Due to the Control Authority within 180 days of the effective date of the categorical pretreatment standards (40 CFR 403.6). In addition, new source BMR reporting requirements are discussed in this section. • Compliance schedule progress reports. Due to the Control Authority within 14 days of completion of compliance schedule milestones or due dates. • 90-day compliance report. Due to the Control Authority within 90 days of the compliance date of the categorical standards or 90 days after beginning discharge for a new source. • Periodic reports on continued compliance. Due to the Control Authority at least semiannually, usually in June and December after the compliance date. The Control Authority may waive monitoring requirements if specified conditions are met. • Notices of potential problems including slug loadings. Due to the Control Authority immediately upon identification of discharges, including slug loadings that could cause problems to the POTW for both non-categorical and categorical IUs. • Notice of changed discharge. Due to the Control Authority from categorical and non-categorical users in advance of any significant change in volume or character of pollutants discharged. • Notice of violation and resampling. Notification due to the Control Authority within 24 hours of noting a violation; results of resampling due within 30 days. • Notification of hazardous waste discharge. Notification to the POTW, EPA, and state Hazardous Waste authorities of the hazardous wastes discharges to the POTW. <p>Reports required from Control Authorities include the following:</p> <ul style="list-style-type: none"> • Compliance schedule (for development of pretreatment programs) progress reports • Annual POTW reports to the Approval Authority. • Annual certification by Non-Significant Categorical IUs. <p>This section also discusses in detail the monitoring requirements for IUs and signatory and recordkeeping requirements (including requirements for electronic documents) for Control Authorities and IUs.</p>

Table 9-1. Summary of the General Pretreatment Regulations

403.13	Variations from Categorical Pretreatment Standards for Fundamentally Different Factors
	This provision allows an industrial user, POTW or any interested person, to request a variance for the establishment of limits either more or less stringent than that required by a categorical pretreatment standard. The primary criterion required for approval of this variance is that the factors relating to the industrial user's discharges be fundamentally different from factors considered by EPA in establishing categorical pretreatment standards for these discharges.
403.14	Confidentiality
	This section covers confidentiality requirements and prohibitions for EPA, states, and Control Authorities. Effluent data are available to the public without restriction.
403.15	Net/Gross Calculation
	This provision provides for adjustment of categorical pretreatment standards to reflect the presence of pollutants in the industrial user's intake water.
403.16	Upset Provision
	This provision is consistent with the NPDES regulations and allows an upset of an industry's pretreatment system (which meets the conditions of an upset as specified in this provision) to be an affirmative defense to an action brought for noncompliance with categorical pretreatment standards. The industrial user shall have the burden of proof for such a defense.
403.17	Bypass
	This provision requires IUs to operate their treatment systems at all times and includes criteria for allowing a bypass to occur and notification procedures for both an anticipated and unanticipated bypass.
403.18	Modification of Control Authority Pretreatment Programs
	This provision specifies procedures and criteria for "minor" and "substantial" modifications to approved Control Authority pretreatment programs and incorporation of substantial modifications into the Control Authority.
403.19	Provisions of specific applicability to the Owatonna Waste Water Treatment Facility
	This section provides specific regulatory requirements for the Owatonna Waste Water Treatment Facility and its participating IUs to implement a project under the Project XLC program in Steele County, Minnesota. This project includes legal authorities and requirements that are different than the administrative requirements otherwise specified in 40 CFR Part 403.
403.20	Pretreatment Program Reinvention Pilot Projects Under Project XL
	This section provides administrative procedures to allow any POTW with a final "Project XL" agreement to implement a Pretreatment Program that includes legal authorities and

Table 9-1. Summary of the General Pretreatment Regulations

	requirements that are different than the administrative requirements otherwise specified in 40 CFR Part 403.
Appendix A	[Reserved]
Appendix B	[Reserved]
Appendix C	[Reserved]
Appendix D	Selected Industrial Subcategories Considered Dilute for Purposes of the Combined Wastestream Formula (previously titled "Selected Industrial Subcategories Exempted from Regulation Pursuant to Paragraph 8 of the NRDC v. Costle Consent Decree")
	The Appendix D published on January 21, 1981, provided a list of industrial subcategories that had been exempted (pursuant to paragraph 8 of the NRDC vs. EPA Consent Decree) from regulation by categorical pretreatment standards. Appendix D was revised on October 9, 1986, to update the list of exempted industrial categories and to correct previous errors by either adding or removing various subcategories or by changing the names of some categories or subcategories. Each of the subcategories, as indicated by the revised Appendix D title, contains wastestreams that are classified as dilute for purposes of applying categorical pretreatment standards to other wastestreams and for using the combined wastestream formula to adjust these standards.
Appendix E	Sampling Procedures
	This Appendix provides a general description of composite and grab sampling procedures.
Appendix F	[Reserved]
Appendix G	Pollutants Eligible for a Pollutant Credit

Table 9-2. Categorical Pretreatment Standards

Industrial Categories with Categorical Pretreatment Standards in Effect			Effluent Guidelines Currently Under Development ^a
	N	Aluminum Forming (Part 467)	<ul style="list-style-type: none"> • Steam Electric Power Generation • Shale Gas Extraction • Dental Amalgam
E	N	Battery Manufacturing (Part 461)	
E	N	Builder's Paper and Board Mills (Part 431)	
E	N	Carbon Black Manufacturing (Part 458)	
E	N	Centralized Waste Treatment (Part 437)	
	N	Coil Coating (Part 465)	
E	N	Copper Forming (Part 468)	
	N	Duck Operations (Part 412)	
E	N	Electrical and Electronic Components (Part 469)	
E	N	Electroplating (Part 413)	
	N	Fertilizer Manufacturing (Part 418)	
	N	Glass Manufacturing (Part 426)	
	N	Grain Mills Manufacturing (Part 406)	

Table 9-2. Categorical Pretreatment Standards

Industrial Categories with Categorical Pretreatment Standards in Effect		Effluent Guidelines Currently Under Development ^a
	N Ink Formulating (Part 447)	
E	N Inorganic Chemicals (Part 415)	
E	N Iron and Steel Manufacturing (Part 420)	
E	N Leather Tanning and Finishing (Part 425)	
E	N Metal Finishing (Part 433)	
E	N Metal Molding and Casting (Part 464)	
E	N Nonferrous Metals Forming and Metal Powders (Part 471)	
E	N Nonferrous Metals Manufacturing (Part 421)	
E	N Organic Chemicals, Plastics, and Synthetic Fibers (Part 414)	
	N Paint Formulating (Part 446)	
E	N Paving and Roofing Materials (Part 443)	
E	N Pesticide Chemicals (Part 455)	
E	N Petroleum Refining (Part 419)	
E	N Pharmaceutical Manufacturing (Part 439)	
E	N Porcelain Enameling (Part 466)	
	N Pulp, Paper, and Paperboard (Part 430)	
	N Rubber Manufacturing (Part 428)	
E	N Soap and Detergent Manufacturing (Part 417)	
E	N Steam Electric Power Generating (Part 423)	
E	N Timber Products Processing (Part 429)	
E	N Transportation Equipment Cleaning (Part 442)	
	N Waste Combustors (Part 444)	

E = Standards in effect for existing sources.

N = Standards in effect for new sources.

^a From 2010 final Effluent Guidelines Program Plan (October 2011).

B. PRETREATMENT COMPLIANCE INSPECTIONS AND OTHER COMPLIANCE EVALAUTION ACTIVITIES

SCOPE OF PCIS AND AUDITS

The Pretreatment Compliance Inspection (PCI), the pretreatment program audit, and the program performance report (submitted at least annually by the Control Authority) are tools EPA and state officials use to assess the Control Authority's pretreatment program.

EPA uses the PCI to evaluate Control Authority compliance monitoring and enforcement activities. The inspector also determines whether any changes have been made to the Control Authority program since the last PCI, audit, performance report (i.e., annual report), or Control Authority modification request for approval. Further, the inspector collects information on Control Authority program implementation for further evaluation by compliance personnel.

The inspector may conduct the PCI in conjunction with other NPDES inspections to conserve travel resources and allow integration of information on a POTW's operations. PCIs can be

conducted along with Compliance Evaluation Inspections (CEIs), Compliance Sampling Inspections (CSIs), Performance Audit Inspections (PAIs), Diagnostic Inspections (DIs), and other non-routine inspections, such as Toxics Sampling Inspections, and Compliance Biomonitoring Inspections. The inspector may combine a PCI with a site visit regarding sludge compliance as discussed in Chapter 10.

Note that the POTW personnel involved in a CSI may be different from the ones involved in a PCI. Also, PCIs and audits rely heavily on file and record reviews to evaluate the Control Authority's pretreatment program. These records may have little bearing on the sampling inspection of the treatment facility. This distinction of a PCI to a CSI should be addressed during planning for the inspection.

Audits provide a comprehensive review of the Control Authority pretreatment program. The audit addresses all the items covered in a PCI, but in greater detail. Consequently, the audit is more resource intensive than the PCI. Additionally, the pretreatment audit is generally considered to be a program function and it is not the focus of this Chapter. More information about how to conduct pretreatment compliance audits is available at https://www3.epa.gov/npdes/pubs/final_pca_checklist_and_instructions_%20feb2010.pdf.

In general, there are three major components of a PCI:

- Pre-visit preparation for the PCI:
 - Coordination with the EPA Regional or State Pretreatment Coordinator.
 - Review of background information: approved program documentation, Control Authority annual reports (if available), NPDES permit/NPDES permit fact sheet, NPDES permit compliance status, previous inspection reports, and program modification requests from the Control Authority.
 - Notification of Control Authority (if appropriate).
- On-site:
 - Entry (presenting credentials)
 - Opening conference with Control Authority officials
 - Review of pretreatment files
 - IU site visits (as appropriate)
 - Interview of officials using PCI or audit checklist
 - Tour of POTW (optional)
 - Closing conference
- Follow-up:
 - Preparation of report
 - Data entry into ICIS-NPDES
 - Reportable Noncompliance/Significant Noncompliance (RNC/SNC) determination
 - Follow-up letter to the Control Authority

- Enforcement action (when necessary)
- NPDES permit or program modifications (when necessary)

EPA's *Clean Water Act National Pollutant Discharge Elimination System Compliance Monitoring Strategy* (CMS) (EPA, 2014) describes the off-site desk audit as a compliance monitoring activity that regions and states can use, under certain circumstances, to make a compliance determination. In order for the off-site desk audit to count toward CMS implementation, the region or state must report the activity to ICIS-NPDES and the desk audit must be conducted by an authorized inspector or other credible regulator with sufficient knowledge, training or experience to assess compliance. The off-site desk audit may include, but is not limited to, the following activities:

- Review of POTW permit, reports and records, including annual pretreatment reports and annual biosolids reports for years covering the period since the last PCI or audit.
- Review of agency-gathered testing, sampling and ambient monitoring data.
- Evaluation of responses to CWA section 308 information requests, such as IU self-monitoring reports.
- Consideration of other information to identify any unpermitted IUs or mis-categorized IUs.
- Consideration of the POTW's sewer use ordinance and enforcement response policy.
- Review of compliance deliverables submitted pursuant to permits or enforcement actions.
- Analysis of aerial or satellite images.

If a PCI is conducted with an unannounced NPDES inspection, it also may be unannounced, but the Control Authority officials should be notified of the PCI upon arrival of the inspection team. At many POTWs, personnel responsible for implementing the pretreatment program may not be the same as those operating the treatment plant.

The protocol involved in the on-site portion of the inspection is comparable to that of other NPDES inspections. The Pretreatment Program PCI typically includes site visits of industrial facilities discharging to the POTW. The inspector should select IUs for site visits as needed to evaluate the Control Authority's procedures for properly categorizing, monitoring and inspecting IUs. For more detailed information on conducting PCIs, refer to EPA's *Guidance for Conducting a Pretreatment Compliance Inspection* (EPA, 1991a).

PCI CHECKLIST COMPONENTS AND INSPECTION REPORT

EPA developed the PCI checklist to assist NPDES inspectors in conducting and documenting the PCI. However, it should be noted that the checklist in the 1991 PCI guidance has not been updated to evaluate changes in the regulations as a result of the 2007 Pretreatment Streamlining Rule. EPA pretreatment inspectors may find EPA's *Control Authority Pretreatment Audit Checklist and Instructions* (EPA, 2010) helpful for conducting pretreatment inspections. See the next section for a description of this checklist.

In addition to the completed checklist, the inspector may include other materials collected during the PCI in the final report as appendices, such as:

- Example of Control Authority control mechanism or enforcement actions
- Names of IUs that were not sampled or inspected in the past year
- Control Authority's Enforcement Response Plan
- Annual list of IUs in significant noncompliance

See the EPA's *Guidance for Conducting a Pretreatment Compliance Inspection* (EPA, 1991a) for the PCI checklist. The manual goes through each checklist section individually and explains the intent of the questions. As noted earlier, the manual provides more detailed information concerning the procedures for conducting the PCI.

PRETREATMENT AUDIT CHECKLIST COMPONENTS

The audit checklist has been developed to assist with a detailed review of a POTW pretreatment program, including pretreatment program modification, legal authority, industrial user characterization, control mechanism evaluation, application of pretreatment standards and requirements, compliance monitoring, enforcement, data management/public participation, resources, and environmental effectiveness/pollution prevention. The audit checklist is part of the *Control Authority Pretreatment Audit Checklist and Instructions* (EPA, 2010). The manual provides specific guidance on conducting an audit and using the checklist.

The audit checklist is divided into the following sections:

- Section I: Data Review
- Section II: File Evaluation
- Section III: Observations and Concerns
- Attachment A: Pretreatment Program Status Update
- Attachment B: Pretreatment Program Profile
- Attachment C: Legal Authority Review Checklist
- Industrial User Site Visit Data Sheet
- WENDB Data Entry Worksheet;
- Pretreatment Compliance Audit Required ICIS Data Elements Worksheet
- RNC Worksheet.

Inspectors should note that the 2010 audit checklist includes the WEN database entry worksheet; however, the WEN database is no longer utilized. Inspectors should now enter audit information into the ICIS-NPDES database and may use the ICIS-NPDES Data Entry Worksheet to do so.

The audit checklist collects more detailed information than the PCI checklist and, as with the completed PCI checklist, also may be augmented by additional audit data:

- NPDES pretreatment permit conditions.

- Control Authority enforcement documents with pretreatment requirements (i.e., administrative order, consent decree).
- Locally developed discharge limitations as included in the approved program (or any limits that have been changed by the Control Authority).
- Copy of sewer use ordinance if different from that in the approved program.
- Control Authority sampling and inspection schedule for regulated IUs.
- List of IUs not sampled or inspected in the past year.
- Control Authority chain-of-custody form.
- List of noncompliant IUs and history of enforcement actions taken.
- Annual list of IUs in significant noncompliance.

C. REFERENCES

EPA's *Guidance for Conducting a Pretreatment Compliance Inspection* (September 1991) contains a list of reference materials (publications and memoranda) available from EPA or the Pretreatment Coordinator in your region. These documents and additional guidance manuals developed to assist EPA Regional Offices, states, POTWs, and IUs with implementation of the General Pretreatment Program are available on EPA's NPDES Pretreatment Publications website (<https://www.epa.gov/npdes/national-pretreatment-program-publications>).

Checklists for conducting pretreatment compliance inspections and audits are provided in EPA's *Guidance for Conducting a Pretreatment Compliance Inspection* (EPA, 1991a) and *Control Authority Pretreatment Audit Checklist and Instructions* (EPA, 2010). It should be noted that these checklists have not been updated to evaluate changes in the regulations as a result of the 2007 Pretreatment Streamlining Rule. Each checklist provides a list of questions that should be considered during an audit or PCI. The inspector should contact the Regional or State Pretreatment Coordinator before a PCI or an audit is done.

The following is a list of resources providing additional information on the NPDES pretreatment program.

Memoranda

Determining Industrial User Significant Noncompliance (January 17, 1992).

Determining Industrial User Compliance Using Split Samples (January 21, 1992).

Use of Grab Samples to Detect Violations of Pretreatment Standards (October 1, 1992).

Using Split Samples to Determine Industrial User Noncompliance (April 12, 1993).

Information on the Misuse of Sodium Dimethyldithiocarbamate (June 2, 2000).

Regulatory Determination for the PreKote™ Surface Preparation Process (April 1, 2003).

Product and Product Group Discharges Subject to Effluent Limitations and Standards for the Organic Chemicals, Plastics, and Synthetic Fibers Point Source Category—40 CFR Part 414 (April 2005).

New Source Dates for Direct and Indirect Dischargers (September 28, 2006).

Oversight of SIUs Discharging to POTWs without Approved Pretreatment Programs (May 18, 2007).

Applicability of Effluent Guidelines and Categorical Pretreatment Standards to Biodiesel Manufacturing (August 11, 2008).

Best Practices for NPDES Permit Writers and Pretreatment Coordinators to Address Toxic and Hazardous Chemical Discharges to POTWs (November 3, 2016)

EPA Guidance

U.S. Environmental Protection Agency. (1983). *Guidance Manual for POTW Pretreatment Program Development*. EPA 833/B-83-100.

U.S. Environmental Protection Agency. (1985). *Guidance Manual for Implementing Production-Based Pretreatment Standards and the Combined Wastestream Formula*. EPA 833-B-85-201.

U.S. Environmental Protection Agency. (1991a). *Guidance for Conducting a Pretreatment Compliance Inspection*. EPA300/R-92-009.

U.S. Environmental Protection Agency. (1991b). *Control of Slug Loadings to POTWs: Guidance Manual*. 21 W-4001.

U.S. Environmental Protection Agency. (1992). *Guidance to Protect POTW Workers from Fume Toxic and Reactive Gases and Vapors*. EPA 812-B-92-001.

U.S. Environmental Protection Agency. (1994a). *Industrial User Inspection and Sampling Manual for POTWs*. EPA 831-B-94-001.

U.S. Environmental Protection Agency. (1994b). *Multijurisdictional Pretreatment Programs Guidance Manual*. EPA 833-94-005.

U.S. Environmental Protection Agency. (1999). *Guidance Manual for Control of Wastes Hauled to Publicly Owned Treatment Works*. EPA 833-B-98-003.

U.S. Environmental Protection Agency. (2004a). *Local Limits Development Guidance*. EPA 833-R-04-002A.

U.S. Environmental Protection Agency. (2004b). *Mercury Pollutant Minimization Program Guidance*. Region 5, NPDES Programs Branch.

U.S. Environmental Protection Agency. (2007a). *EPA Model Pretreatment Ordinance*. EPA 833-B-06-002.

U.S. Environmental Protection Agency. (2007b). *Checklist – Pretreatment Program Legal Authority Reviews*.

U.S. Environmental Protection Agency. (2010). *Control Authority Pretreatment Audit Checklist and Instructions*. EPA 833-B-10-001.

U.S. Environmental Protection Agency. (2011a). *Introduction to the National Pretreatment Program*. EPA 833-B-11-001.

U.S. Environmental Protection Agency. (2011b). *Procuring Analytical Services: Guidance for Industrial Pretreatment Programs*. EPA 833-B-11-001.

U.S. Environmental Protection Agency. (2012). *Industrial User Permitting Guidance Manual*. 833-R-12-001A.

U.S. Environmental Protection Agency. (2014). *Clean Water Act National Pollutant Discharge Elimination System Compliance Monitoring Strategy*. Available at:
<https://www.epa.gov/compliance/clean-water-act-national-pollutant-discharge-elimination-system-compliance-monitoring>

CHAPTER 10 – SEWAGE SLUDGE (BIOSOLIDS)

Contents

A. Review of the Sewage Sludge Regulations (Biosolids)	198
Land Application Requirements (40 CFR Part 503, Subpart B).....	200
Surface Disposal Requirements (40 CFR Part 503, Subpart C)	203
Incineration Requirements (Subpart E).....	204
B. Sludge (Biosolids) Inspection Procedures	209
Scope of Inspection Activities.....	209
Inspection Preparation.....	210
Records Review	211
Facility Site Review	214
Sampling and Laboratory Quality Assurance (QA)	216
C. References	229

List of Tables

Table 10-1. Records Relevant for Sludge Operations	217
Table 10-2. Operating Records for Specific Unit Processes	218
Table 10-3. Sludge Sampling Points	220
Table 10-4. Recordkeeping Requirements for Class A Pathogen Reduction Alternatives ^a	223
Table 10-5. Recordkeeping Requirements for Class B Pathogen Reduction Alternatives ^a	225
Table 10-6. Recordkeeping Requirements for Vector Attraction Reduction Sludge Processing Options.....	225
Table 10-7. Sludge Handling Process Evaluation	226
Table 10-8. Pollutants Monitored for Land Application, Surface Disposal, and Incineration.....	229

List of Exhibits

Exhibit 10-1. Sludge Quality Requirements for Land Application Uses	206
Exhibit 10-2. Land Applied Sludge Requirements Based on Level of Treatment Achieved	207
Exhibit 10-3. Sludge Quality Requirements for Surface Disposal	208

Associated Appendices

P. Sludge Inspection Checklists

Related Websites

Office of Wastewater Management (OWM) home page: <http://www.epa.gov/owm>

Office of Science and Technology (OST) home page: <https://www.epa.gov/aboutepa/about-office-water#science>

A. REVIEW OF THE SEWAGE SLUDGE REGULATIONS (BIOSOLIDS)

In addition to materials in this chapter, inspectors must be familiar with Chapter 1, "Introduction," and Chapter 2, "Inspection Procedures."

Section 405 of the Clean Water Act (CWA) mandated the development of a federal sludge management program. On February 19, 1993, the Environmental Protection Agency (EPA) promulgated technical standards for the final use or disposal of sewage sludge (see Title 40 *Code of Federal Regulations* (CFR) Part 503, Volume 58 *Federal Register* (FR) 9248). These regulations contain technical standards for three sewage sludge use or disposal practices:

- Land Application (Subpart B)
- Surface Disposal (Subpart C)
- Incineration (Subpart E)

The regulations at 40 CFR Part 503 also include pathogen and alternative vector attraction reduction requirements for sewage sludge applied to the land or placed on a surface disposal site (Subpart D).

The federal and state sludge management programs currently regulate the final use and disposal of sewage sludge, the residual generated from the treatment of domestic sewage in a treatment works. Although the regulations refer to the residual generated from the treatment of domestic sewage as sewage sludge, the term "biosolids" is the current term in general use for those sewage sludges that have been treated and conditioned through biological, chemical, and/or physical processes for beneficial reuse as a soil amendment for growing plants and trees.

In preparation for the issuance of the final technical standards, the National Pollutant Discharge Elimination System (NPDES) regulations were revised to include sludge use or disposal requirements. EPA considers the sludge regulations at 40 CFR Part 503 as the minimum requirements applicable to and enforceable against any facility engaged in a regulated sludge use or disposal practice, regardless of whether that facility's NPDES permit contains sludge use or disposal conditions. EPA has the authority to issue a notice of violation or take other appropriate enforcement actions against facilities that do not comply with 40 CFR Part 503 regulations.

Facilities that are subject to NPDES permit requirements for aqueous discharges to surface waters, such as Publicly Owned Treatment Works (POTWs), are also subject to 40 CFR Part 503 regulations as generators and preparers of sewage sludge. Additionally, facilities that may not have previously been permitted under the NPDES program and are subject to 40 CFR Part 503 regulations will be required to apply for an NPDES permit. Regulated facilities include:

- Facilities designated by the permitting authority as treatment works treating domestic sewage.⁶
- Industrial facilities that separately treat domestic sewage and generate biosolids regulated by 40 CFR Part 503.
- All surface disposal site owners/operators.
- Septage haulers who land apply septage.
- All biosolids incinerator owners/operators.
- Facilities changing the quality of biosolids regulated by 40 CFR Part 503.

The regulations at 40 CFR Part 503 only apply to use and disposal of sewage sludge (including domestic septage), which replaces only a portion of the original 1979 regulations on land application and surface disposal of sludge in 40 CFR Part 257. The land application of industrial sludge continues to be regulated by 40 CFR Part 257. However, disposal of sewage sludge in Municipal Solid Waste Landfills (MSWLFs) is regulated in 40 CFR Part 258 and the operations and air emissions of sewage sludge incinerators is regulated by the Clean Air Act (CAA) under 40 CFR Part 60 and 40 CFR Part 129.

In general, the regulations at 40 CFR Part 503 apply the following types of requirements to the three practices for sewage sludge use or disposal:

- Pollutant limits—9 pollutants under land application (40 CFR 503.13), 3 pollutants under surface disposal (40 CFR 503.23), and 7 pollutants under incineration (40 CFR 503.43).
- Pathogen and vector attraction reduction requirements.
- Nitrogen application rate requirements.
- Management practices for siting and operation of sludge use or disposal activities.
- Minimum monitoring requirements.
- Specific recordkeeping and reporting requirements.

A brief explanation of the requirements that apply to each sewage sludge use or disposal practice is provided below. Pathogen and alternative vector attraction reduction requirements in Subpart D are included in the descriptions for land application (Subpart B) and surface disposal (Subpart C) of sewage sludge and are not described separately in this document.

⁶ *Treatment works* is either a federally owned, publicly owned, or privately owned device or system used to treat (including recycle and reclaim) either domestic sewage or a combination of domestic sewage and industrial waste of a liquid nature. *Domestic sewage* is waste and wastewater from humans or household operations that is discharged to or otherwise enters a treatment works. *Domestic septage* is either liquid or solid material removed from a septic tank, cesspool, portable toilet, Type III marine sanitation device, or similar treatment works that receives only domestic sewage (and does not receive either commercial wastewater or industrial wastewater and does not include grease removed from a grease trap at a restaurant). Note the Part 503 regulations also include simplified requirements for the land application of domestic septage.

LAND APPLICATION REQUIREMENTS (40 CFR PART 503, SUBPART B)

Land application consists of the spreading, spraying, injection, or incorporation of biosolids, including material derived from sewage sludge (e.g., compost, sewage sludge pellets), onto or below the surface of the land to take advantage of the soil-enhancing qualities of the sewage sludge.

General

The general requirements in 40 CFR Part 503, Subpart B prohibit the land application of sewage sludge to agricultural land, forest, a public contact site, or a reclamation site if the sludge does not meet the pollutant limits or ceiling concentrations established in 40 CFR 503.13(b)(1). The person who prepares bulk sewage sludge for land application is responsible for providing the applicator of the sewage sludge a written notification of the concentration of total nitrogen (as N, on a dry weight basis) in the bulk sewage sludge. The preparer of the sewage sludge is responsible for obtaining this information and disseminating this information to respective owners or lease holders to comply with 40 CFR 503.7 regulations.

For sewage sludge that is applied to land in a state other than the state in which the bulk sewage sludge is prepared, the applicator will also provide written notice, prior to the initial application, to the permitting authority for the state in which the bulk sewage sludge is proposed to be applied. The notice shall include:

- The location, by either street address or latitude and longitude, of each land application site.
- The approximate time period bulk sewage sludge will be applied to the site.
- The name, address, telephone number, and NPDES permit number (if appropriate) for the person who prepares the bulk sewage sludge.
- The name, address, telephone number, and NPDES permit number (if appropriate) for the person who will apply the bulk sewage sludge.

Pollutant Limits

The regulations establish four types of limits for nine pollutants. Exhibit 10-1 at the end of this section illustrates which limits apply, based on the final sludge use; conversely, Exhibit 10-2 illustrates which requirements apply, based on the level of treatment achieved.

- **Ceiling Concentration Limits**—Maximum limits as milligram of pollutant per kilogram of sludge on a dry weight basis for bulk sewage sludge or sewage sludge sold or given away in a bag or other container that can be land applied (listed in Table 1 of 40 CFR 503.13).
- **Cumulative Pollutant Loading Rates (CPLRs)**—Total amount of pollutant (kilograms) in sludge that does not meet pollutant concentration limits that can be applied to a hectare of agricultural land, forest, public contact site, or reclamation site. When this loading rate is reached, no additional sludge can be applied to the site. CPLRs are listed in Table 2 of 40 CFR 503.13.

- **Pollutant Concentration Limits**—Monthly average concentration of pollutant as milligram per kilogram of sludge on a dry weight basis (listed in Table 3 of 40 CFR 503.13). They apply to sewage sludge sold or given away in a bag or other container that can be applied to land and as an alternative limit to CPLRs for bulk sewage sludge.
- **Annual Pollutant Loading Rates**—The amount of pollutant (kilograms) in a bagged product that can be applied in a 365-day period on an area (hectare) of land, calculated as the product of the concentration of each pollutant in the sewage sludge (kilograms of pollutant per kilograms of sludge) and the annual whole sludge application rate for the sewage sludge (kilograms sludge per year). The loading rates (listed in Table 4 of 40 CFR 503.13) are alternative limits to pollutant concentration limits for sewage sludge sold or given away in a bag or other container on a dry weight basis that can be applied each year.

Management Practices

The regulations at 40 CFR 503.14 lists five management practices that supplement the pollutant limits and provide additional protection to endangered species and their habitats, surface water, wetlands, groundwater, and human exposure to the sludge. Four of these practices are applicable to the land application of bulk sludge; one practice is applicable to the labeling or reporting of the bag or other container in which sewage sludge is sold or given away for land application.

Operational Standards: Pathogen and Vector Attraction Reduction Requirements

Prior to land application, sludge must meet both pathogen reduction (i.e., reduction of disease-causing organisms) and vector attraction reduction (i.e., reduction of rodents, flies, mosquitoes, or other organisms capable of transporting infectious agents, ultimately to humans) requirements.

The 1993 40 CFR Part 503 regulations (58 FR 9387) retained substantially the same pathogen reduction requirements as the original 1979 40 CFR Part 257 (44 FR 53460) requirements for land applied sludge. Land-applied sludge must meet one of two categories of pathogen reduction requirements:

- **Class A requirements (40 CFR 503.32(a))** must be met when applying bulk sewage sludge to a lawn or home garden or when sewage sludge is sold or given away in a bag or other container to be applied to land. Class A requirements result in a pathogen reduction of the sludge to at or below the detection limits of the method. Class A sewage sludge may be used without site restrictions or limiting public access. Six alternative pathogen reduction approaches are available for achieving Class A sludge in Subpart D.
- **Class B requirements (40 CFR 503.32(b))** significantly reduce (but do not eliminate) the pathogens in the sludge and require a waiting period before the land on which the sludge was applied may be used for certain activities. Site restrictions limit the application of Class B sewage sludge to agricultural land, forest, public contact site, or a reclamation site. To meet pathogen reduction requirements, land-applied domestic septage must meet site restriction requirements in 40 CFR 503.32(b)(5) or meet pH

requirements at 40 CFR 503.32(c)(2) and a subset of the site restriction requirements (40 CFR 503.32(b)(5)(i)–503.32(b)(5)(iv)). Three pathogen reduction alternatives (with specific site restrictions for use of the treated sludge) are provided for achieving Class B sludge in Subpart D.

The regulations at 40 CFR Part 503 also require compliance with one of eight vector attraction reduction treatment alternatives if the sludge will be sold or given away in a bag or other container (40 CFR 503.33(a)(3)). Bulk sewage sludge applied to lawns or home gardens must also meet one of eight vector attraction reduction treatment alternatives (40 CFR 503.33(a)(2)). Bulk sewage sludge applied elsewhere must meet one of ten treatment alternatives (40 CFR 503.33(a)(1)).

Monitoring, Recordkeeping, and Reporting Requirements

The regulations at 40 CFR Part 503 requires a minimum monitoring frequency for pollutants and pathogen and vector reduction parameters based on the annual amount of sewage sludge generated by a facility (as shown in Table 1 of 40 CFR 503.16). As with other NPDES provisions, the permitting authority may reduce monitoring frequencies based upon consistent demonstrated performance for at least two years. Land application of domestic septage requires monitoring for pathogen and vector attraction reduction parameters to ensure compliance with those requirements.

The recordkeeping requirements at 40 CFR Part 503 differ depending on the type of pollutant limits applied. Recordkeeping requirements, including certification statements specified in 40 CFR Part 503, are imposed on generators/preparers of sewage sludge and on appliers of domestic septage. The regulations require the facility to retain the specific information for 5 years, except that some information on applicable cumulative pollutant loading rates must be retained by the facility indefinitely.

While all facilities must maintain records, only a subset must report under the regulations at 40 CFR Part 503. Facilities should verify reporting requirements with the permitting authority. Those facilities that must report at least once per year are listed below.

- Class I sludge management facilities⁷
- POTWs with a design capacity equal to or greater than 1 Million Gallons per Day (MGD)
- POTWs serving a population of 10,000 or more

⁷ *Class I sludge management facility* is any publicly owned treatment works (POTW), as defined in 40 CFR 501.2, required to have an approved pretreatment program under 40 CFR 403.8(a) (including any POTW located in a state that has elected to assume local program responsibilities pursuant to 40 CFR 403.10(e)) and any treatment works treating domestic sewage, as defined in 40 CFR 122.2, classified as a Class I sludge management facility by the EPA Regional Administrator, or, in the case of approved State programs, the Regional Administrator in conjunction with the State Director, because of the potential for its sewage sludge use or disposal practice to affect public health and the environment adversely.

SURFACE DISPOSAL REQUIREMENTS (40 CFR PART 503, SUBPART C)

A surface disposal site is an area of land that contains one or more active sewage sludge units (i.e., land on which only sewage sludge is placed for final disposal). This does not include land on which sewage sludge is either stored or treated. Surface Disposal includes monofills (sewage sludge-only landfills), dedicated disposal surface application sites, piles or mounds, impoundments, or lagoons.

General

Subpart C requires that sewage sludge shall not be placed on an active sewage sludge unit unless the pollutant limits in 40 CFR 503.23 are met. If an active unit is located within 60 meters of a geologic fault with displacement in Holocene time, located in an unstable area, or located in a wetland, the unit must be enclosed. The operator/owner must notify the permitting authority 180 days prior to closing a unit. Prior owners are required to notify the subsequent owner of the presence of sewage sludge.

Pollutant Limits

The surface disposal regulations at 40 CFR 503.23 control three pollutants. Limits apply to sewage placed at a surface disposal site that does not have a liner and leachate collection system. There are no pollutant limits on sewage sludge placed in sewage sludge units equipped with a liner and leachate collection system. The distance between the active sewage sludge unit and the site property line/boundary determine the specific pollutant limits that apply; the closer to the boundary, the more stringent the limits (see Table 10-3). An owner/operator can request site-specific pollutant limits; the permitting authority establishes these limits through a permit.

Management Practices

The regulations at 40 CFR 503.24 establish a total of 14 management practice requirements. Many are one-time surface disposal site location restrictions. Others address operational activities (e.g., liner, leachate and runoff collection systems, methane gas monitoring) and post-closure activities.

Operational Standards

Prior to surface disposal, sludge must meet both pathogen reduction and vector attraction reduction requirements. Sludge that is placed at a surface disposal site must meet one of the Class A or Class B pathogen reduction alternatives, unless the sewage sludge is covered daily with soil or other material. The inspector should note, however, that the site restrictions included in the Class B pathogen reduction alternatives only apply to land applied sewage sludge, not to surface disposal. In addition to pathogen reduction, surface disposed sludge must also meet one of eleven vector attraction reduction alternatives specified in 40 CFR Part 503, Subpart D. Although domestic septage does not have pathogen reduction requirements, one of four vector attraction reduction requirements must be met prior to placing it on an active sewage sludge unit.

Monitoring, Recordkeeping, and Reporting Requirements

The regulations at 40 CFR Part 503 require a minimum monitoring frequency for pollutants and pathogen and vector reduction parameters based on the annual amount of sewage sludge disposed by a facility (as shown in Table 1 of 40 CFR 503.26). Like land application requirements for monitoring, the permitting authority may reduce monitoring frequencies based upon consistent demonstrated performance for at least two years. Surface disposal of domestic septage requires monitoring for vector attraction reduction parameters to ensure compliance with those requirements.

Recordkeeping requirements (40 CFR 503.26 to 503.28) include certification statements specified for the sludge generator or final preparer and/or the owner/operator of the surface disposal site. The facility must maintain all records for 5 years. While all facilities must maintain records, only a subset must report under the sewage sludge regulations. Facilities should verify reporting requirements with the permitting authority. Those facilities that must report at least once per year are listed below.

- Class I sludge management facilities
- POTWs with a design capacity equal to or greater than 1 Million Gallons per Day (MGD)
- POTWs serving a population of 10,000 or more

INCINERATION REQUIREMENTS (SUBPART E)

Incineration of sewage sludge is the firing of sludge at high temperatures in an enclosed device.

General

Sewage sludge incineration must be in compliance with the requirements in this subpart.

Pollutant Limits

The sewage sludge regulations impose pollutant limits on seven pollutants in the exit gas from a sewage sludge incinerator stack. Beryllium and mercury must comply with the national emissions standards in subparts C and E of 40 CFR Part 61. Limits on the five remaining metals are calculated by the permitting authority based on-site-specific factors using the equations specified in 40 CFR 503.43. Lead limits factor in the National Ambient Air Quality Standard for lead. Limits for arsenic, cadmium, chromium, and nickel are based on chemical-specific risk-specific concentrations. Limits for the remaining two pollutants (mercury and beryllium) are derived from air emission standards promulgated under 40 CFR Part 61. These limits appear in the permit issued to the owner/operator of the sewage sludge incinerator.

Management Practices

The seven management practices in 40 CFR 503.45 ensure that certain detection and measurement instruments are correctly installed, calibrated, operated, and maintained; that incinerator maximum combustion temperature and air pollution control equipment operating standards are established; and that endangered species and their habitats are protected. The permitting authority is required to include specific management practice requirements based on-site-specific factors and these should appear in the incinerator's permit.

Operational Standards

The sewage sludge regulations establish an average monthly standard on the total hydrocarbons (THC) or carbon monoxide (CO) concentration in the exit gases (i.e., stack gas) of an incinerator to protect from excessive emissions of organic pollutants. The owner/operator must correct the measured concentrations to account for variations in moisture and oxygen content in the stack gas. The monthly standards must be normalized to 0 percent moisture and 7 percent oxygen in the stack gas. Monthly average concentrations of 100 parts per million (ppm) for TCH or CO must be met.

Monitoring, Recordkeeping and Reporting Requirements

The regulations at 40 CFR 503.47 and 503.48(a) impose monitoring requirements on the incinerator owner/operator. Sections 503.46 to 503.48 of the sludge regulations require monitoring of (a) sewage sludge for pollutant (i.e., seven metals) concentrations; (b) incinerator stack exit gases for total hydrocarbon or, alternatively, carbon monoxide (CO), oxygen concentrations and moisture content; and (c) incinerator combustion temperatures and air pollution control equipment operating parameters. Monitoring requirements to demonstrate compliance with Part 61 beryllium and mercury standards are also imposed on owners/operators of sewage sludge incinerators (40 CFR 503.47(d)–(e)).

Records required to be maintained by owners/operators of incinerators are specified both in 40 CFR 503.47 and site-specific conditions in the NPDES or sludge permit. Owners/operators must keep records for a minimum of five years and include information on sludge pollutant limits, management practices, and monitoring requirements.

While all facilities must maintain records, only a subset must report under the sewage sludge regulations. Facilities should verify reporting requirements with the permitting authority. Those facilities that must report at least once per year are listed below.

- Class I sludge management facilities
- POTWs with a design capacity equal to or greater than 1 million gallons per day (MGD)
- POTWs serving a population of 10,000 or more

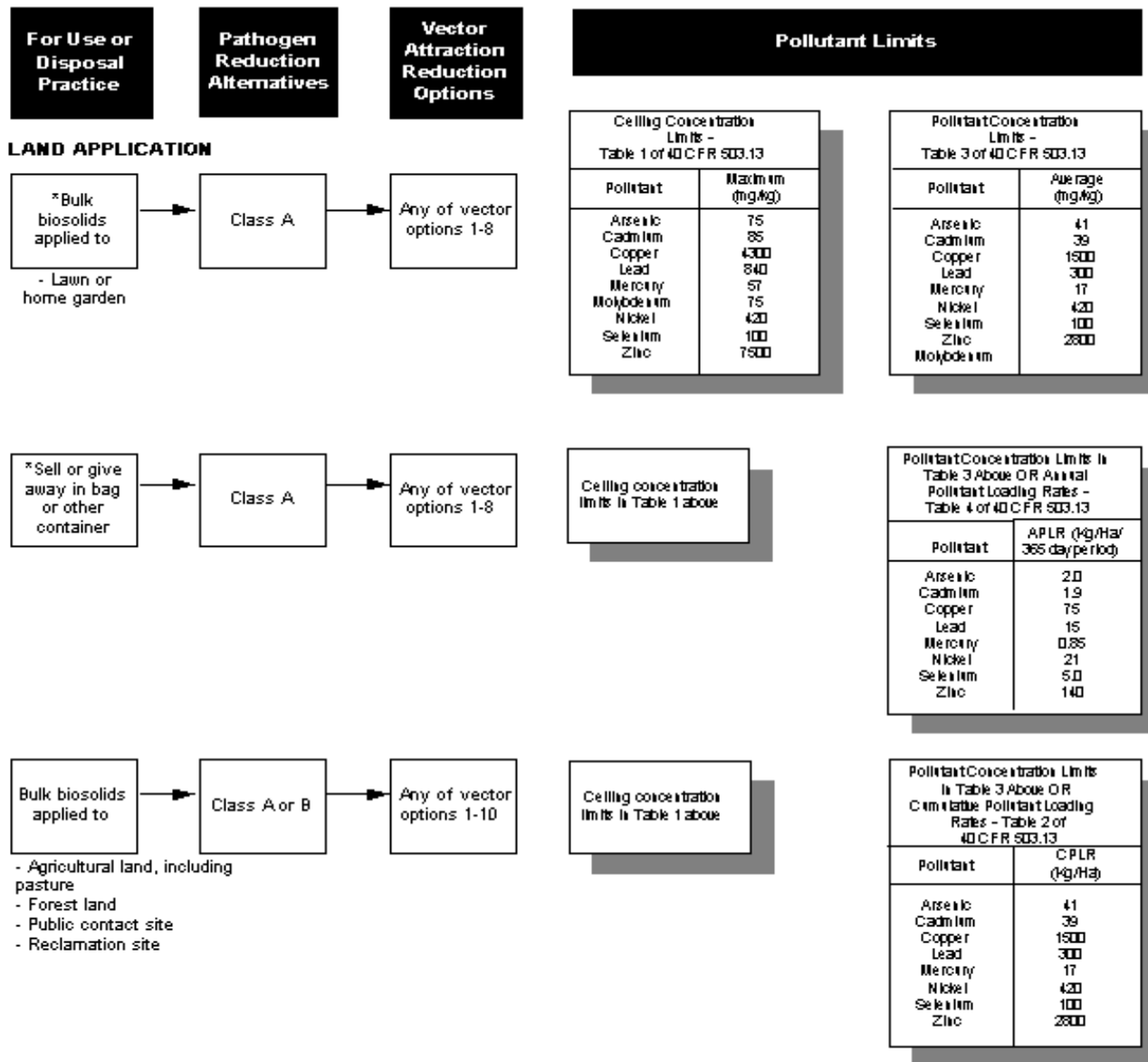

*Exceptional Quality (EQ) material. General requirements, management practices, site controls, and harvesting restrictions do not apply.

Exhibit 10-1. Sludge Quality Requirements for Land Application Uses

SLUDGE TYPE

RESULTING REQUIREMENTS

Exceptional Quality (EQ)

- 1) Meets all pollutant concentration limits (Table 2-1, p. 29)
- 2) Meets any of the Class A alternatives (Table 2-5, p. 37)
- 3) Meets any of V.A.R. Options 1-8 (Table 2-6, p. 37)

Unregulated for Use
Monitoring, Recordkeeping, and
Reporting Requirements

Pollutant Concentration (PC)

- 1) Meets all pollutant concentration limits (Table 2-1, p. 29)
- 2) Meets any of the Class B alternatives (Table 2-5, p. 37)
- 3) Meets any of V.A.R. Options 1-10 (Table 2-6, p. 37)

Site Restrictions (Fig. 2-4, p. 38)
Management Practices (Fig. 2-9, p. 45)
General Requirements (Fig. 2-8, p. 44)
Monitoring, Recordkeeping, and
Reporting Requirements

OR

- 1) Meets all pollutant concentration limits (Table 2-1, p. 29)
- 2) Meets any of the Class A alternatives (Table 2-5, p. 37)
- 3) Meets V.A.R. Option 9 or 10 (Table 2-6, p. 37)

Management Practices (Fig. 2-9, p. 45)
General Requirements (Fig. 2-8, p. 44)
Monitoring, Recordkeeping, and
Reporting Requirements

Cumulative Pollutant Loading Rate (CPLR)

- 1) Meets ceiling concentration limits (Table 2-1, p. 29)
- 2) Meets any Class A or Class B alternative (Table 2-5, p. 37)
- 3) Meets any of V.A.R. Options 1-10 (Table 2-6, p. 37)

Site Restrictions (Fig. 2-4, p. 38)
Management Practices (Fig. 2-9, p. 45)
General Requirements (Fig. 2-8, p. 44)
Monitoring, Recordkeeping, and
Reporting Requirements
CPLR Loading Rate Limits
(Table 2-1, p. 29)

**Annual Pollutant Loading Rate (APLR)
(For solids sold or given away)**

- 1) Meets ceiling concentration limits (Table 2-1, p. 29)
- 2) Meets any of the Class A alternatives (Table 2-5, p. 37)
- 3) Meets any of V.A.R. Options 1-8 (Table 2-6, p. 37)

Site Restrictions (Fig. 2-4, p. 38)
Management Practices (Fig. 2-9, p. 45)
General Requirements (Fig. 2-8, p. 44)
Monitoring, Recordkeeping, and
Reporting Requirements
APLR Loading Rate Limits
(Table 2-1, p. 29)

Note: Tables and pages numbers reference above are from EPA's *A Plain English Guide to the EPA Part 503 Biosolids Rule*, September 1994

Exhibit 10-2. Land Applied Sludge Requirements Based on Level of Treatment Achieved

SURFACE DISPOSAL

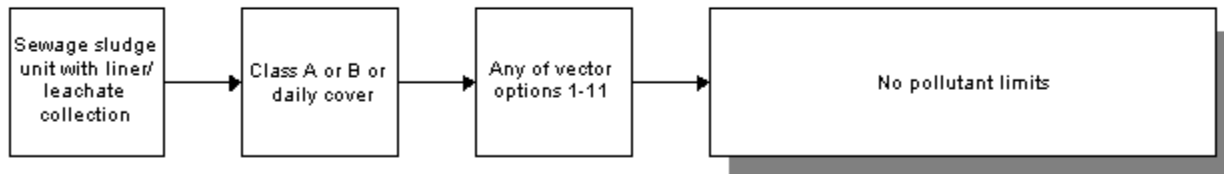
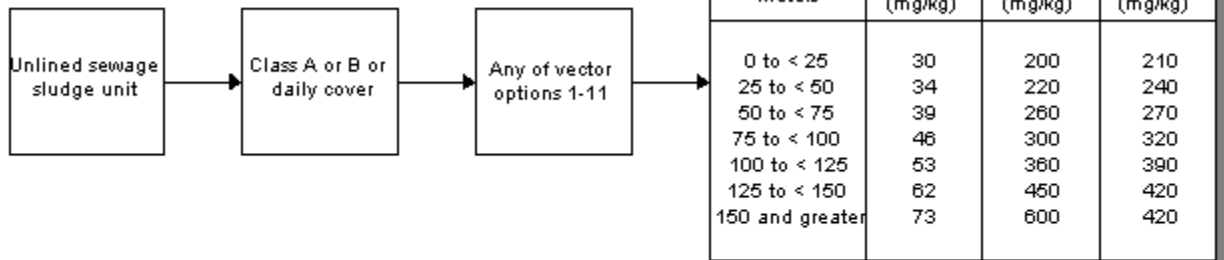

* Site-specific limits may be approved by the permitting authority, if requested.

Exhibit 10-3. Sludge Quality Requirements for Surface Disposal

B. SLUDGE (BIOSOLIDS) INSPECTION PROCEDURES

SCOPE OF INSPECTION ACTIVITIES

Inspectors should verify compliance with the following general activities:

- Sludge monitoring, recordkeeping, and reporting
- Sludge treatment operations and maintenance
- Sludge sampling and laboratory Quality Assurance (QA)

EPA intends for the evaluation of sludge management activities to be incorporated into the existing NPDES inspection structure so that inspection resources can be used most efficiently. The inspector can identify and investigate problems that might contribute to noncompliance with sludge requirements during any inspection site visit. The Pretreatment Compliance Inspection (PCI), the Compliance Evaluation Inspection (CEI), the Compliance Sampling Inspection (CSI), and the Performance Audit Inspection (PAI) are the most likely vehicles for evaluating compliance with sludge requirements. Examples of how the NPDES inspector may use existing NPDES inspections when evaluating sludge requirements are presented below.

- PCI—During a PCI, the inspector evaluates a POTW’s compliance with its pretreatment program, which includes consideration of whether any pollutants from non-domestic sources are passing through the treatment processes and accumulating in the sludge.
- CEI—The inspector has historically looked at sludge treatment as part of the CEI because of its effect on wastewater treatment. Evaluation of sludge treatment during a CEI should be expanded to include a review of sludge monitoring, reporting, and record-keeping, and a more comprehensive evaluation of the Operation and Maintenance (O&M) of sludge treatment processes, to evaluate compliance with sludge permit requirements.
- CSI—The CSI is used if the inspector decides that sludge sampling is necessary to determine compliance with applicable requirements.
- PAI—The PAI may evaluate compliance with sludge monitoring requirements, and evaluate the permittee’s sludge sampling and analytical procedures.

While NPDES inspectors are not required to conduct an in-depth compliance assessment of sludge final use and disposal practices when such practices occur away from the wastewater treatment plant (WWTP), it can help ascertain the vector reduction compliance status at these sites rather than at the WWTP. In situations where final use and disposal requirements have been established in the facility’s NPDES permit (e.g., management practices such as 10-meter buffer zones between the sludge application site and surface waters) and the activity is off-site, the inspector should verify compliance with those requirements through a records review at the facility. As part of a sampling inspection, the inspector may need to sample the sludge to determine compliance with pollutant limits.

EPA intends to focus sludge inspection activities on those aspects of sludge management that the inspector can easily evaluate during an existing NPDES compliance or pretreatment inspection. Inspectors will rely on an evaluation of sludge treatment operations, the observation of on-site sludge storage and disposal activities, and the review of sludge monitoring and disposal records to identify actual and potential noncompliance with sludge requirements. Inspectors should document compliance or noncompliance with sludge final use or disposal requirements in accordance with standard NPDES compliance inspection procedures. An optional inspection checklist is useful for documenting that all necessary information has been collected. Sludge Inspection checklists are included in Appendix P of this manual. These checklists are based on the checklists in EPA's *Guidance for NPDES Compliance Inspector: Evaluation of Sludge Treatment Processes* (EPA, 1991a) and *Guidance for NPDES Compliance Inspector: Verifying Compliance with Sludge Requirements* (EPA, 1991b), as modified by EPA Region 8. The checklists should be used in conjunction with the checklist questions found in the 1991 guidance manuals. However, sludge permits may contain additional sludge permit conditions based on case-by-case considerations that are not included on the checklist. The inspector should identify additional permit requirements and verify compliance with these conditions as well. To accomplish this, it is recommended that the inspector expand the checklist, if necessary, to ensure that it is specific to the NPDES permit and the sludge final use or disposal activity. The inspector should complete the checklist and should incorporate his/her findings and conclusions in the final inspection report prepared for the facility.

The NPDES compliance inspector should also consult EPA's *Guidance for NPDES Compliance Inspector: Evaluation of Sludge Treatment Processes* (EPA, 1991a) when preparing to conduct a sludge inspection. This technical reference presents a detailed examination of sludge unit processes and contains extensive technical checklists that summarize the most critical elements of sludge thickening, stabilization, conditioning, dewatering, and disinfection. A technical understanding of the proper design and operation of the sludge treatment processes is essential for conducting thorough and informed sludge inspections.

INSPECTION PREPARATION

On preparing for the inspection, the inspector should:

- Review the NPDES permit (or the facility's sludge permit, if applicable). When reviewing the NPDES permit file in preparation for the inspection, identify:
 - Permit conditions applicable to sludge including treatment; general requirements; management practices; and monitoring, reporting, and recordkeeping requirements.
 - Any additional requirements in the NPDES permit that may reflect state regulations. Additionally, the NPDES permit may incorporate a separate state permit by reference, in which case the state permit is also enforceable under the federal CWA.
- Review sludge self-monitoring data.
- Become familiar with the sludge disposal practices used.

- Review appropriate federal regulations (i.e., 40 CFR Part 503, or 40 CFR Part 258 if sludge is disposed of in a municipal solid waste landfill, and any other applicable state or local regulations).
- Review relevant guidance for background information and implementation procedures (e.g., guidelines on calculating agronomic rate, EPA's Process Design Manuals (EPA, 1975; EPA, 1979; EPA, 1982; EPA, 1995a)).
- Verify that records kept by the permittee help in evaluation of compliance with sludge requirements.

RECORDS REVIEW

The sewage sludge regulations contain recordkeeping and reporting requirements. The facility's NPDES or sludge permit may have additional recordkeeping or reporting requirements. The inspector should conduct an evaluation of the sludge records and reports found at the facility to determine compliance with these recordkeeping and reporting requirements. The inspector may find sampling records and files containing sludge feed rate measurements from several different wastestreams. The inspector should use the procedures listed below for these routine inspections. If suspected violations are uncovered during the routine evaluation, a more intensive investigation should be conducted.

The inspector should evaluate compliance by asking the following questions:

- Does the facility have all required information available for review?
- Does the facility address all regulated pollutants and sludge use and disposal practices?
- Does the facility have all the current sludge information?
- Does the facility maintain sludge records for at least 5 years?
- Does the facility's information contained in the sludge records support the data submitted to the permitting authority?
- Do the facility's records indicate areas needing further investigation?

The inspector should also identify whether violations of sludge-related permit requirements (e.g., concentration limits and/or management practices) have been reported to the control authority, as required by the permit. Finally, the inspector should verify that the permittee has notified EPA of any changes to sludge use or disposal practices.

Evaluation Procedures

The inspector should first review the permit and fact sheet and list all sludge recordkeeping requirements.

Table 10-1 is a list of records that may be relevant for sludge. This list is supplemented by Table 10-2, which describes records relevant to the operation of specific sludge treatment unit processes. Throughout the inspection, compare the facility's operations with the permit conditions to verify that required permit activities for sludge are correct, current, and complete.

An evaluation of sludge self-monitoring records and/or procedures involves the same elements as an evaluation of their wastewater monitoring data; however, there are some special considerations inherent in sludge sampling. In evaluating the permittee's records, inspectors should look for documentation regarding:

- Regulated pollutants—As identified in the NPDES permit or applicable federal or state regulations.
- Monitoring frequency—As identified in the NPDES permit or applicable federal or state regulations. The inspector should note that 40 CFR Part 503 establishes minimum monitoring frequencies based on the quantity of sewage sludge used or disposed of.
- Sample location—The appropriate sampling point is the final treatment process the sludge goes through before leaving the treatment plant for use or disposal. For example, if a composted sludge is land applied, the finish compost pile/distribution pile should be sampled. If digested sludge is land applied, the sludge should be sampled as it is transferred from the digester or dewatering to the truck prior to being hauled off-site. Table 10-3 identifies sludge sampling points appropriate for the various types of treated sludge.
- Sample types—Grabs or composites may be appropriate depending on the situation, but it is important to note that a grab sample from a lagoon, drying bed, compost pile, or truck must consist of numerous samples collected from various places in the lagoon, bed, pile, or truck and must be combined to make a representative sample.
- Sample volume—If evaluating the sample collection process or taking samples, the inspector must ensure that the container is not filled completely. Some space should be left to allow for expansion of the sample due to gas production. Rapid cooling of the sample will also reduce gas production.
- Sample containers—Sample containers are generally the same types as those used for collection of wastewater samples.
- EPA sample identification methods—Same as for wastewater sampling.
- Preservation and holding times—The primary difference in sludge preservation is that samples should not be chemically preserved in the field because the sludge matrix makes it difficult to thoroughly mix the preservative into the sample. However, samples should be iced.
- Chain-of-custody—Same as for wastewater sampling.
- Quality control—Same as for wastewater sampling.
- Analytical procedures used by lab—The analytical methods used for sludge are different from those used for wastewater. Approved analytical methods are listed in 40 CFR 503.8 or 40 CFR Part 136, where 40 CFR Part 503 does not require a specific method. For example, 40 CFR Part 503 requires that analyses for inorganic pollutants use the procedures in *Test Methods for Evaluating Solid Waste, Physical/Chemical Methods* (EPA, 1980a). The inspector should note the information recorded regarding sample

handling and analysis at the laboratory and verify that it is correct. If evaluating the laboratory, the procedures are the same as those followed in a PAI. The inspector should look at:

- Analytical procedures
- Laboratory services
- Instruments and equipment
 - Calibration
 - Maintenance
- Supplies
- Quality Assurance/Quality Control (QA/QC)
 - Precision and accuracy of measurement process
 - Data handling and reporting
 - Records retention
 - Personnel qualifications
- Analytical results—Verify that results documented in the files are consistent with those reported.

The inspector should verify that reporting requirements are fulfilled according to the permit and applicable regulations. The NPDES permit may or may not have specific reporting requirements; however, the 40 CFR Part 503 sludge standards have specific reporting requirements that apply regardless of whether they appear in the NPDES permit. The May 1989 revisions to the NPDES regulations (54 FR 18716) established standard permit conditions regarding notification of change and at least annual reporting of sludge monitoring results. As NPDES permits are reissued, they will contain, at a minimum, these standard conditions as well as conditions specified in 40 CFR Part 503. Based on the applicable requirements, the inspector should verify that:

- Reports contain all required information.
- Reports are submitted at the required frequency.
- Data are reported in the Discharge Monitoring Report (DMR) or other approved form.

Inspectors should review unit operation records to verify compliance with pathogen and vector attraction reduction requirements. Table 10-4, Table 10-5, and Table 10-6 list the records and operating requirements for the 40 CFR Part 503, Class A pathogen reduction alternatives, the Class B pathogen reduction alternatives, and the vector attraction reduction options, respectively. Inspectors are not expected to review each monitoring record, but rather to verify that records are being maintained and are available for review. If a permittee has problems meeting either its pathogen or vector attraction reduction requirements (e.g., fecal coliform or percent volatile solids reduction), the inspector should review treatment operating records to identify potential noncompliance with the operating requirements specified in 40 CFR Part 503 for the pathogen and vector reduction process employed by the permittee. For example, an

inspector might check a treatment facility's pH or temperature records to determine whether the sludge has been maintained at the appropriate pH or temperature for the required duration during treatment.

The inspector should verify that records are available for all disposal practices:

- Volume of sludge disposed of.
- Sludge quality data.
- Specific records appropriate for demonstrating compliance with the general requirements, management practices, and operational standards.

The inspector should verify whether records are maintained in accordance with permit requirements. Federal regulations provide that all permits must include a provision requiring that sludge records be kept by the appropriate entity for five years. The regulations establish specific recordkeeping requirements for each party involved in the sewage sludge use or disposal process. During records review, the inspector may observe:

- Records not organized or placed in different areas throughout the facility.
- Non-representative sampling of disposed sludge.
- Incorrect reporting of sludge, e.g., failure to report on a dry weight basis.
- Inaccurate recordkeeping to determine pathogen and vector attraction reduction.
- Process control parameters that are not maintained.

FACILITY SITE REVIEW

In the facility site review, the inspector should include any area where sludge is generated, treated, stored, dewatered or disposed. A visual inspection can determine where monitoring devices are placed and whether they are appropriate.

Inspection of Solids Handling Unit Processes

Sludge processing arguably poses the greatest challenges in wastewater treatment from the standpoints of design, operation, and maintenance.

When conducting the walk-through visual inspection of the facility, the inspector should be aware of, and look for, physical conditions that are indicative of potential or existing problems. The inspector should also note any out of service equipment and the general conditions of the area and equipment. Some of the more common indicators of potential problems are listed in Table 10-7. The presence of these conditions may warrant a more in-depth inspection of the sludge treatment processes. An optional checklist is provided at the end of this chapter to assist the inspector during the facility site review. The questions on this checklist are sludge-specific and should be asked in conjunction with the Facility Site Review checklist. In addition, many of the questions in the NPDES checklist relate to the overall operation of the facility and therefore, can also be applied to sludge evaluations (e.g., treatment units properly operated and maintained).

The inspector should determine whether the facility is operating its sludge treatment and disposal processes in a manner consistent with the requirements established in its NPDES permit. If the inspector discovers conditions at the facility that threaten public health or the environment (e.g., contaminating groundwater or surface water, exposing the public to pathogens or disease vectors, or compromising public safety), the inspector should inform the enforcement staff so that appropriate action can be taken. If known endangerment is discovered, the criminal investigations unit should be informed.

Many large-scale operations are conducted outside, such as sludge drying, composting, temporary and long-term storage, and loading and hauling. Inspectors should note these outside operations' exposure to rainfall and runoff collection and treatment methods. If stormwater collection devices have been constructed, the inspector should evaluate the performance and maintenance of these devices as well as their design capacity (e.g., the 10-year, 24-hour storm event or the 25-year, 24-hour storm event). Visual observations can detect obvious problems that may contribute to the contamination of surface water or groundwater such as erosion, breaches of dikes or berms, or cracks in the concrete or asphalt. The inspector should inquire as to whether the capacity of the collection devices has ever been exceeded during any storm event.

The sludge loading area should be inspected to determine how the sludge is being hauled or transported. The inspector should note the size of the truckloads and the number of truckloads hauled over a 1-day period (or another time period). Table 10-4, Table 10-5, and Table 10-6 are useful to the inspector in verifying the permittee's records and reports on the volume of sludge generated and disposed of.

Sludge Storage

The inspector should also verify that the permittee has adequate storage capacity for its sludge in the event that its preferred disposal method is interrupted for any reason (e.g., noncompliance with cumulative loading rates on the land application site). There are no federal requirements specifying a minimal storage capacity; the appropriate capacity will vary depending on the amount of sludge generated and the facility's use or disposal option(s). Storage capacity should address normal, routine storage prior to disposal and should anticipate emergency conditions, such as:

- Equipment malfunction
- Inclement weather
- Unanticipated loss of disposal site:
 - Farmer decides to discontinue use of sewage sludge
 - Landfill violates requirements and may no longer accept sludge or must close

Some states have developed storage capacity requirements. If the permittee cannot dispose of its sludge in the preferred manner, it should have either adequate storage capacity for its sludge or clearly established plans for alternative methods of disposal.

SAMPLING AND LABORATORY QUALITY ASSURANCE (QA)

The sludge inspection should evaluate the nature, scope, and adequacy of sludge sampling and analysis conducted by the permittee. The most likely existing inspection vehicle for conducting this evaluation is the PAI, since it involves a detailed assessment of the permittee's self-monitoring activities, including sample collection and laboratory analysis (likely completed by an off-site laboratory). The findings of the sampling and laboratory QA review should be summarized by the inspector and included in the final inspection report for the facility.

Sampling Procedures and Techniques

The inspector's evaluation of the permittee's sludge sampling procedures will address similar criteria as those evaluated in the context of wastewater sampling. The sampling procedure elements that should be evaluated during the inspection include:

- Sample collection techniques:
 - Selection of representative sampling sites
 - Sample types
 - Sample volume
 - Sample containers
- EPA sample identification methods
- Sample preservation and holding time
- Chain-of-custody and shipment of samples
- Quality control (QC):
 - Duplicates
 - Blanks
- Data handling and reporting

A detailed discussion on evaluating these elements can be found in Chapter 5. While many of these elements are evaluated using the same criteria, regardless of the media being sampled, sludge sample collection techniques and sample preservation are different. The inspector should review EPA's sewage sludge sampling video and refer to EPA's *POTW Sludge Sampling and Analysis Guidance Document* (EPA, 1989) for detailed information regarding sludge sampling procedures. Additionally, the inspector can review 40 CFR Part 136 for additional methods. Table 10-3 of this manual summarizes appropriate sample locations. Lists of approved biosolids analytical methods, sample containers, preservation techniques, and holding times for biosolids samples can be found on EPA's website at: <https://www.epa.gov/biosolids/additional-information-biosolids-managers#analytical>. In addition to these references, a few special sludge sampling considerations are described below.

- Equipment. The equipment used to collect sludge samples is different from that used to collect wastewater samples. The automatic composite samplers used to collect wastewater cannot be used to collect sludge samples because the high solids content of the sludge fouls the tubing. The type of equipment used to collect samples of soil or

other solid waste material is more appropriate for the collection of sludge samples. Stainless steel buckets, trowels, and augers are typically used to collect solid sludge cake. Graduated glass or plastic pitchers or cylinders, or plastic or stainless steel buckets are used to collect liquid sludge samples.

- **Sample Location.** If the permit does not identify a specific sludge sampling location, the inspector must select one. See EPA's 1993 sewage sludge sampling video for an overview of this process (EPA, 1993a). The inspector can review 40 CFR Part 136 for additional methods. EPA's *POTW Sludge Sampling and Analysis Guidance Manual* (EPA, 1989) states that for purposes of enforcement, sludge samples must come from the treatment unit process immediately prior to sludge disposal or end use. Often, the last unit process is one of the dewatering processes described in the accompanying technical guidance. Table 10-3, EPA's *POTW Sludge Sampling and Analysis Guidance Manual* (EPA, 1989a), suggests appropriate sampling points for a variety of unit processes.

Table 10-1. Records Relevant for Sludge Operations

Sludge Use/Disposal Records
<ul style="list-style-type: none"> • Volume • Type of use and/or disposal options used • Use/disposal sites
Sludge Operating Records
<ul style="list-style-type: none"> • Daily operating log • Equipment maintenance scheduled and completed
Sludge Monitoring Records
<ul style="list-style-type: none"> • Constituents/pollutants in sludge • Mass of sludge generated and disposed of (in dry metric tons per year)
Sludge Sampling and Analytical Data
<ul style="list-style-type: none"> • Dates, times, and locations of sampling • Sampling protocols and analytical methods • Results of analyses • Dates and times of analyses • Name(s) of analysis and sampling personnel
Sludge Laboratory Records
<ul style="list-style-type: none"> • Calibration and maintenance of equipment • Laboratory bench sheets or logs and calculations • Quality Assurance/Quality Control (QA/QC) records

Table 10-2. Operating Records for Specific Unit Processes

THICKENING PROCESSES		
Gravity Thickening	Dissolved Air Flotation	Centrifuge
<ul style="list-style-type: none"> • Overflow volume/rate • Influent flow • Percent solids <ul style="list-style-type: none"> – Sludge feed – Thickened sludge – Overflow • Sludge blanket depth 	<ul style="list-style-type: none"> • Sludge feed rate • Recycle flow • Daily operating time • Percent solids <ul style="list-style-type: none"> – Sludge feed – Thickened sludge – Subnatant • Floating sludge depth • Air flow rate • Retention tank pressure • Percent solids capture • Detention time • Air to solid ratio 	<ul style="list-style-type: none"> • Influent sludge flows • Volume cake produced • Percent solids <ul style="list-style-type: none"> – Sludge feed – Centrate – Sludge cake • Daily operating time
STABILIZATION PROCESSES (Pathogen and/or Vector Attraction Reduction)		
Aerobic Digestion	Anaerobic Digestion	Incineration
<ul style="list-style-type: none"> • Air supply • Solids retention time • Temperature • DO level • pH • Feed sludge <ul style="list-style-type: none"> – TS, TVS, and pH – Flow rate • Digested sludge <ul style="list-style-type: none"> – SOUR – TS, TVS, and pH – Flow rate • Supernatant <ul style="list-style-type: none"> – Flow rate and BOD – TSS and pH 	<ul style="list-style-type: none"> • Detention time • Temperature • pH and alkalinity • Gas production and quality • Volatile acids • Feed sludge <ul style="list-style-type: none"> – TS, TVS, and pH – Flow rate • Digested sludge <ul style="list-style-type: none"> – TS, TVS, and pH – Flow rate • Supernatant <ul style="list-style-type: none"> – Flow rate and BOD – TSS and pH • Cleaning frequency 	<ul style="list-style-type: none"> • Operating schedule • Sludge feed <ul style="list-style-type: none"> – Solids content – Feed rate – Volatile solids • Combustion temperature • Sludge residence time • Fuel flow • Off-gas oxygen content • Air feed rate • Emission control equipment <ul style="list-style-type: none"> – Pressure drop • Type of fuel • Volume of ash produced • Stack gas monitoring
Heat Temperature	Composting	Chemical Conditioning/Stabilization
<ul style="list-style-type: none"> • Temperature/time • Pressure • Detention time • Feed sludge <ul style="list-style-type: none"> – TS and TVS – Flow rate – Percent solids • End product volatile solids 	<ul style="list-style-type: none"> • Oxygen concentration • Temperature and time • Turning frequency • Percent sludge solids • Type and amount of bulking agent(s) • Header pressure 	<ul style="list-style-type: none"> • Chemical types and dosage • Mixing • pH • Temperature
Electron Irradiation	Gamma Irradiation	
<ul style="list-style-type: none"> • Sludge feed rate • Electron dosage • Temperature 	<ul style="list-style-type: none"> • Sludge feed rate • Gamma ray source strength 	
DEWATERING PROCESS		

Table 10-2. Operating Records for Specific Unit Processes

Vacuum Filter	Pressure Filter	Belt Filter Press
<ul style="list-style-type: none"> • Sludge feed <ul style="list-style-type: none"> – Total solids • Sludge cake <ul style="list-style-type: none"> – Total solids • Filtrate <ul style="list-style-type: none"> – Flow – BOD – TSS • Maintenance • Spare parts 	<ul style="list-style-type: none"> • Sludge feed percent solids • Sludge cake percent solids • Volume of sludge processed • Cycle length • Volume conditioning chemicals • Filtrate <ul style="list-style-type: none"> – Flow – BOD – TSS 	<ul style="list-style-type: none"> • Loading rate • Operating speed • Feed slurry <ul style="list-style-type: none"> – Total solids and flow • Dewatered sludge <ul style="list-style-type: none"> – Total solids – Flow • Filtrate and wash water <ul style="list-style-type: none"> – BOD and SS – TSS and flow • Preventive maintenance • Polymer
Drying Bed	Drying Lagoons	Heat Drying
<ul style="list-style-type: none"> • Sludge loading rate • Quantity in bed • Depth of sludge in bed • Date deposited • Detention time • Ambient temperature • Drying bed construction (i.e., lined) • Undertrain destination • Percent solids of the sludge feed and of the dewatered sludge 	<ul style="list-style-type: none"> • Sludge loading rate • Percent solids <ul style="list-style-type: none"> – Sludge – Decant • Quantity in lagoon • Depth in lagoon • Date deposited • Drying time • Rainfall 	<ul style="list-style-type: none"> • Operating schedule <ul style="list-style-type: none"> – Start-up – Shut down • Sludge feed rate • Percent solids <ul style="list-style-type: none"> – Sludge feed – Dried/Pelletized product • Fuel consumption • Air flow • Drying temperature • Detention time • Stack gas monitoring <ul style="list-style-type: none"> – Oxygen – Particulates – Carbon monoxide – Carbon dioxide

LEGEND:

DO = Dissolved Oxygen

TS = Total Solids

TVS = Total Volatile Solids

BOD = Biochemical Oxygen Demand

TSS = Total Suspended Solids

SS = Suspended Solids

SOUR = Specific Oxygen Uptake Rate

Sludge Type	Sampling Point
Anaerobically Digested	Sample from taps on the discharge side of positive displacement pumps.
Aerobically Digested	Sample from taps on the discharge lines from pumps. If batch digester is used, sample directly from the digester. Two cautionary notes regarding this practice: <ul style="list-style-type: none"> • If aerated during sampling, air entrains in the sample. Volatile organic compounds may purge with escaping air. • When aeration is shut off, solids separate rapidly in well-digested sludge.
Thickened	Sample from taps on the discharge side of positive displacement pumps.
Heat Treated	Sample from taps on the discharge side of positive displacement pumps after decanting. Be careful when sampling heat treatment sludge because of: <ul style="list-style-type: none"> • High tendency for solids separation. • High temperature of samples (frequently >60°C) can cause problems with certain sample containers due to cooling and subsequent contraction of entrained gases.
Dewatered by Belt Filter Press, Plate and Frame Press, Centrifuge, or Vacuum Filter Press	Sample from sludge cake discharge chute and conveyor. Alternatively, sample from collection container or storage bin for the dewatered sludge; sample from many locations within the storage bin and at various depths, collect equal samples from each point, and combine them to form one sample of the total storage bin.
Dewatered or Air Dried in Drying Beds, or Bin or Truck Bed	Divide bed into four quadrants, collect equal sample volume from the center of each quadrant, and combine them to form one sample of the total bed. Each grab sample should include the entire depth of the sludge (down to the sand).
Composted	Collect full core samples from randomly selected sites in the pile. Sample directly from front-end loader or other conveyance device as the sludge is being loaded into trucks to be hauled away.

- **Sample Collection Techniques.** Obtaining a representative sample of sludge is difficult when the sludge is not flowing through a pipe or along a conveyer. To obtain a representative sample of sludge from a sludge bed or lagoon, a compost pile, or a truck, several samples must be taken from various places in the pile and "combined" to make a representative sample.
- **Sample Preservation.** Samples of solid sludge are not usually preserved in the field because it is difficult to thoroughly mix the preservative throughout the sludge sample. It is best to preserve sludge samples that are high in solids at the laboratory. Use the appropriate field preservative to chill the sample to 4°C. Note, some exemptions do exist such as a sample for the Specific Oxygen Uptake Rate (SOUR), which should be

kept at the same temperature as the aerobic digester and analyzed within 30 minutes of sample collection.

Laboratory Analysis and Quality Assurance

During a PAI, the inspector is already conducting an in-depth evaluation of the permittee's laboratory analytical techniques and QA/QC procedures. The following elements are evaluated during this inspection:

- Permittee sample handling procedures in the laboratory.
- Laboratory analysis techniques:
 - Permittee laboratory analytical procedures (analytical methods specified by 40 CFR Part 503 or other methods established in the permit).
 - Laboratory services.
 - Instruments and equipment.
 - Supplies.
- QA/QC:
 - Precision and accuracy of the measurement process.
 - Data handling and reporting.
 - Sludge records retention (for 5 years).
 - Personnel qualifications.

Again, many of these elements are evaluated according to the same criteria regardless of the sample being analyzed. The inspector is referred to Chapter 7 and EPA's *NPDES Compliance Monitoring Inspector Training Module: Laboratory Analysis* (EPA, 1990a) for general guidance on inspecting the permittee's laboratory procedures. There are some differences in sample preparation and analytical techniques for sludge with which the inspector should be familiar.

In conducting the sludge component of the PAI, the inspector should closely evaluate the permittee's sample preparation procedures. The sludge matrix is more complex and variable than the wastewater matrix; therefore, the laboratory's development of sample preparation techniques is of particular concern.

The NPDES permit may require the permittee to analyze sludge for conventional pollutants, inorganic pollutants, metals, and pathogens (depending on the ultimate sludge disposal practice). For example, sludge that is going to be land applied will be analyzed for nine metals and nitrogen to determine the appropriate application rate. Table 10-8 lists the constituents required to be monitored by 40 CFR 503. The regulations at 40 CFR 503.8 contain a listing of approved analytical methods and volatile solids reduction calculations that must be used for monitoring sludge quality.

Lists of approved biosolids analytical methods, sample containers, preservation techniques, and holding times for biosolids samples can be found on EPA's website at:

<https://www.epa.gov/biosolids/additional-information-biosolids-managers#analytical>.

The inspector should keep the following points in mind when reviewing the permittee's lab and analytical results:

- The sewage sludge standards are expressed on a dry weight basis. Laboratory results for sludge are typically reported in one of two forms, wet weight (i.e., mg/L) or dry weight (i.e., mg/kg). Watch out for mg/kg units that are wet weight rather than dry weight. The laboratory should be providing the results on a dry weight basis. If the laboratory results are reported on a wet weight basis (i.e., in mg/L), the results for each pollutant in each sample must be recalculated to determine the dry weight concentration. To accomplish this conversion, the percent total solids in the sludge sample must be known. Thus, the lab must analyze the sample for percent solids using Method 2540G of *Standard Methods for the Examination of Water and Wastewater*, 22nd Edition (American Public Health Association (APHA), American Water Works Association (AWWA), and World Economic Forum (WEF), 2013) or by another approved method in 40 CFR Part 136.

The following equation can be used to determine the dry weight concentration because the equation uses the assumption that the specific gravity of water and sewage sludge are both equal to one. However, this assumption holds true only when the solids concentration in the sludge is low. The calculated dry weight concentration may vary slightly from the actual concentration as the solids content increases because the density of the sewage sludge may no longer be equal to that of water. This concern does not arise when the solids content of sludge is usually low. EPA is aware of this potential problem and may decide regarding this matter at a later date.

Determine the pollutant concentration on a dry weight basis using the following abbreviated conversion (EPA, 1988):

$$\text{PC (dry, mg/kg)} = \frac{\text{PC (wet, mg/L)}}{(\% \text{ total solids})}$$

In this formula, PC = Pollutant concentration, and % total solids is in decimal format.

A unit conversion is incorporated into the equation.

- For metals, a common analytical error is that labs conduct the metals analyses using analytical methods developed for water and wastewater. Analytical methods for water and wastewater are found in 40 CFR Part 136. Additional information can be found in *Standard Methods for the Examination of Water and Wastewater* (American Public Health Association (APHA), American Water Works Association (AWWA), and World Economic Forum (WEF), 2013), while the solid waste analytical methods are found in latest version of *Test Methods for Evaluating Solid Wastes: Physical/Chemical Methods* (EPA, 2014). If non-detects are found for the metal concentrations, it is likely that the laboratory is not following the method requirement of digesting equivalent to one gram of dry weight of solid.

- For sludge samples, all metals must be analyzed according to the methods presented in 40 CFR Part 136. Note that more than one method is provided for each pollutant. The difference between the methods is usually the equipment used (i.e., direct aspiration, furnace, or Inductively Coupled Plasma (ICP) scan) and the level of detection desired. Each of the methods is EPA-approved, but certain sample characteristics may require one to be used instead of another.
- Methods for analyzing additional inorganic parameters (e.g., nitrite, Total Kjeldahl Nitrogen (TKN)) are also found in 40 CFR Part 136, as well as in *Standard Methods for the Examination of Water and Wastewater*.

EPA's *Control of Pathogens and Vector Attraction in Sewage Sludge* (EPA, 2003) is a primary reference for regional, state, and local regulatory authorities and their constituents for successful compliance with 40 CFR Part 503, Subpart D requirements. Several new equivalencies have been recommended by the Pathogen Equivalency Committee (PEC) since the latest edition of EPA's *Control of Pathogens and Vector Attraction in Sewage Sludge* (EPA, 2003) and are updated at EPA's Principal Biosolids Guidance website for processes to significantly reduce pathogens (PSRPs) and processes to further reduce pathogens (PFRPs) (accessible at: <http://www.epa.gov/biosolids>). Also note that EPA finalized pathogen reduction methods for fecal coliform (EPA Methods 1680 or 1681) and *Salmonella* (EPA Method 1682) in June 2005. EPA recommends that facilities testing under 40 CFR Part 503 use the new methods; however, these methods are not required by federal regulations.

Table 10-4. Recordkeeping Requirements for Class A Pathogen Reduction Alternatives^a

Alternative A1—Time and Temperature
• Analytical results for density of <i>Salmonella sp.</i> bacteria or fecal coliform (most probable number).
• Sludge temperature at representative locations.
• Time (days, hours, minutes) temperature maintained.
Alternative A2—Alkaline Treatment
• Analytical results for density of <i>Salmonella sp.</i> bacteria or fecal coliform (most probable number).
• Sludge pH.
• Time (hours) pH maintained above 12 (at least 72 hours).
• Sludge temperature.
• Percent solids in sludge after drying (at least 50 percent).
Alternative A3—Analysis and Operation
• Analytical results for density of <i>Salmonella sp.</i> bacteria or fecal coliform (most probable number).
• Analytical results for density of enteric viruses (plaque forming unit/4 grams of total solids, on a dry weight basis) prior to pathogen reduction and, when appropriate, after treatment.
• Analytical results for density of viable helminth ova (number/4 grams of total solids, dry weight) prior to pathogen reduction and, when appropriate, after treatment.
• Values or ranges of values for operating parameters to indicate consistent pathogen reduction treatment.
Alternative A4—Analysis Only
• Analytical results for density of <i>Salmonella sp.</i> bacteria or fecal coliform (most probable number, dry weight basis).
• Analytical results for density of enteric viruses (plaque forming unit/4 grams of total solids, dry weight).

Table 10-4. Recordkeeping Requirements for Class A Pathogen Reduction Alternatives^a

<ul style="list-style-type: none"> Analytical results for density of viable helminth ova (number /4 grams of total solids, dry weight). 	
<p>Alternative A5—Processes to Further Reduce Pathogens (PFRP)</p>	
<ul style="list-style-type: none"> Heat Drying: <ul style="list-style-type: none"> Analytical results for density of <i>Salmonella sp.</i> bacteria or fecal coliform (most probable number). Moisture content of dried sludge <10 percent. Logs documenting temperature of sludge particles or wet bulb temperature of exit gas exceeding 80°C. Thermophilic Aerobic Digestion: <ul style="list-style-type: none"> Analytical results for density of <i>Salmonella sp.</i> bacteria or fecal coliform (most probable number). Dissolved oxygen concentration in digester \leq1 mg/L. Logs documenting temperature maintained at 55–60°C for 10 days. Heat Treatment: <ul style="list-style-type: none"> Analytical results for density of <i>Salmonella sp.</i> bacteria or fecal coliform (most probable number). Logs documenting sludge heated to temperatures > greater than 180°C for 30 minutes. Pasteurization: <ul style="list-style-type: none"> Analytical results for density of <i>Salmonella sp.</i> bacteria or fecal coliform (most probable number). Temperature maintained at or above 70°C for at least 30 minutes. 	<ul style="list-style-type: none"> Composting: <ul style="list-style-type: none"> Analytical results for density of <i>Salmonella sp.</i> bacteria or fecal coliform (most probable number). Description of composting method. Logs documenting temperature maintained at or above 55°C for 3 days if within vessel or static aerated pile composting method. Logs documenting temperature maintained at or above 55°C for 15 days if windrow compost method. Logs documenting compost pile turned at least five times per day during the 15day period, if windrow compost method. Gamma Ray Irradiation: <ul style="list-style-type: none"> Analytical results for density of <i>Salmonella sp.</i> bacteria or fecal coliform (most probable number). Gamma ray isotope used. Gamma ray dosage at least 1.0 megarad. Ambient room temperature log. Beta Ray Irradiation: <ul style="list-style-type: none"> Analytical results for density of <i>Salmonella spp.</i> bacteria or fecal coliform (most probable number). Beta ray dosage at least 1.0 megarad. Ambient room temperature log.
<p>Alternative A6—PFRP Equivalent</p>	
<ul style="list-style-type: none"> Operating parameters or pathogen levels as necessary to demonstrate equivalency to the PFRP. Analytical results for density of <i>Salmonella sp.</i> bacteria or fecal coliform (most probable number). 	

^a Note that several new equivalencies have been recommended by PEC since 2003, when EPA revised the principal biosolids guidance document. Also, EPA recommended new methods in 2005 for the analysis of fecal coliform and *Salmonella*.

Table 10-5. Recordkeeping Requirements for Class B Pathogen Reduction Alternatives^a

Alternative B1—Fecal Coliform Count	
<ul style="list-style-type: none"> • Number of samples collected during each monitoring event. • Analytical results for density of fecal coliform for each sample collected. 	
Alternative B2—Processes to Significantly Reduce Pathogens (PSRP)	
<ul style="list-style-type: none"> • Aerobic Digestion: <ul style="list-style-type: none"> – Dissolved oxygen concentration. – Volatile solids content before and after digestion. – Mean residence time of sludge in digester and the corresponding method used to calculate this value. – Logs showing temperature was maintained for sufficient period of time (ranging from 60 days at 15°C to 40 days at 20°C). 	
<ul style="list-style-type: none"> • Air Drying: <ul style="list-style-type: none"> – Description of drying bed design. – Depth of sludge on drying bed. – Drying time in days. – Daily average ambient temperature. 	
<ul style="list-style-type: none"> • Anaerobic Digestion: <ul style="list-style-type: none"> – Volatile solids content before and after digestion. – Mean residence time of sludge in digester and the corresponding method used to calculate this value. – Logs showing temperature was maintained for a sufficient period of time (ranging from 15 days at 35°C to 55°C and 60 days at 20°C). – Temperature logs of sludge in digester. 	
<ul style="list-style-type: none"> • Composting: <ul style="list-style-type: none"> – Description of composting method. – Daily temperature logs documenting sludge maintained at 40°C for 5 days. – Hourly readings showing temperature exceeded 55°C for 4 consecutive hours. 	
<ul style="list-style-type: none"> • Lime Stabilization: <ul style="list-style-type: none"> – pH of sludge immediately and then 2 hours after addition of lime, without any further addition of lime. 	
Alternative B3—PSRP Equivalent	
<ul style="list-style-type: none"> • Operating parameters or pathogen levels as necessary to demonstrate equivalency to PSRP. 	

^a Note that several new equivalencies have been recommended by PEC since 2003, when EPA revised the principal biosolids guidance document. Also, EPA recommended new methods in 2005 for the analysis of fecal coliform and *Salmonella*.

Table 10-6. Recordkeeping Requirements for Vector Attraction Reduction Sludge Processing Options

Option 1—Volatile Solids (VS) Reduction	Option 5—Aerobic Processing (Thermophilic Aerobic Digestion/Composting)
<ul style="list-style-type: none"> • Volatile solids concentration of raw and final sludge streams (mg/kg). • Calculations showing 38 percent reduction in volatile solids.^a 	<ul style="list-style-type: none"> • Sludge detention time in digester/composting. • Temperature logs showing average temperature above 45°C and minimum temperature above 40°C for 14 consecutive days.

Table 10-6. Recordkeeping Requirements for Vector Attraction Reduction Sludge Processing Options

<p>Options 2 and 3—Bench-Scale VS Reduction</p> <ul style="list-style-type: none"> • One-time description of bench-scale digester. • Time (days) that sample was further digested in bench-scale digester (30 days for aerobically and 40 days for anaerobically digested sludge). • Temperature logs showing temperature maintained at 20°C for aerobically or between 30°C and 37°C for anaerobically digested sludge. • Volatile solids concentration of sludge (mg/kg) before and after bench-scale digestion. 	<p>Options 6—Alkaline Treatment</p> <ul style="list-style-type: none"> • Logs demonstrating the hours that pH of sludge/alkaline mixture was maintained (12 for 2 hours and 11.5 for an additional 22 hours). • Amount of alkaline added to sludge (lbs. or gals). • Amount of sludge treated.
<p>Option 4—Specific Oxygen Uptake Rate for Aerobically Digested Sewage Sludge</p> <ul style="list-style-type: none"> • Dissolved oxygen readings for sludge sample over 15-minute intervals (mg/L). • Temperature logs showing test was corrected to conducted at 20°C. • Total solids for sludge sample (g/L). • SOUR calculations (mg/g). 	<p>Options 7 and 8—Drying</p> <ul style="list-style-type: none"> • Results of percent solids (dry weight) test. • Presence of unstabilized solids generated during primary treatment.

^a Methods for calculating VS reduction under Option 1 can be found in Appendix C of EPA’s *Control of Pathogens and Vector Attraction in Sewage Sludge*. EPA-625-R 92-013.

Table 10-7. Sludge Handling Process Evaluation

<p>General Indicators of Problems</p> <ul style="list-style-type: none"> • Inadequate sludge removal from clarifiers or thickeners. • Poor dewatering characteristics of thermal treated sludge. • Thickened sludge too thin. • Fouling of overflow weirs on gravity thickeners. • Air flotation skimmer blade binding on beaching plate. • Substantial downtime of sludge treatment units. • Sludge disposal inadequate to keep treatment system in balance. • Mass balance inappropriate (ratio of sludge wasted should be 0.65–0.85 lbs. of sludge per lb. of BOD removed). • Sludge decant or return flows high in solids.^a • Odors. • Improper loading rates.
<p>Anaerobic Digestion Problems</p>

Table 10-7. Sludge Handling Process Evaluation

<ul style="list-style-type: none"> • Inoperative mechanical or gas mixers. • Inoperative sludge heater or low temperature.^a • Floating cover of digester tilting. • Inadequate gas production.^a • Inoperative gas burner. • Supernatant exuding sour odor from either primary or secondary digester.^a • Excessive suspended solids in supernatant. • Supernatant recycle overloading the WWTP. • pH problems.^a
<p>Aerobic Digestion Problems</p> <ul style="list-style-type: none"> • Excessive foaming in tank.^a • Objectionable odor in aerobically digested sludge.^a • Insufficient dissolved oxygen in digester. • Digester overloaded. • Clogging of diffusers in digester. • Mechanical aerator failure in digester. • Inadequate supernatant removal from sludge lagoons. • Solids accumulation in tank.
<p>Sludge Dewatering Problems</p> <p><u>Drying Beds</u></p> <ul style="list-style-type: none"> • Poor sludge distribution on drying beds. • Vegetation in drying beds (unless reed design). • Dry sludge remaining on drying beds. • Inadequate drying time on drying beds.^a • Some unused drying beds. • Dry sludge stacked around drying beds where runoff may enter navigable waters. • Filtrate from sludge drying beds returned to front of plant. <p><u>Centrifuge</u></p> <ul style="list-style-type: none"> • Excessive solids in fluid phase of sample after centrifugation.^a • Inadequate dryness of centrifugal sludge cake.^a • Excessive vibration or other mechanical problems. <p><u>Filter Press</u></p> <ul style="list-style-type: none"> • High level of solids in filtrate from filter presses or vacuum filters.^a • Thin filter cake caused by poor dewatering. • Vacuum filter cloth binding. • Low vacuum on filter. • Improperly cleaned vacuum filter media. • Sludge buildup on belts and/or rollers of filter press. • Excessive moisture in belt filter press sludge cake.^a • Difficult cake discharge from filter presses. • Filter cake sticks to solids conveying equipment of filter press. • Frequent media binding of plate filter press. • Sludge blowing out of filter press. • Insufficient run time of sludge dewatering equipment.
<p>Sludge Stabilization Problems</p> <p><u>Lagoon</u></p>

Table 10-7. Sludge Handling Process Evaluation

- Objectionable odor from sludge lagoon.
- Damage to dikes around sludge drying lagoons.
- Unlined sludge lagoons.
- Sludge lagoons full, overflowing sludge back to plant or to natural drainage.
- Deep rooted vegetation on dikes or berms.

Composting

- Piles that give off foul odor.
- Inoperable blower.
- Temperature does not reach 122–140°F (50–60°C) or is above 158°F (70°C).
- Uncontrolled stormwater runoff.

Heat Drying/Pelletizing

- Excess moisture in sludge feed.
- Insufficient air flow or drying temperature achieved.
- Inadequate drying of final product (excess moisture in final product).
- Excess odors associated with treatment area.
- Excess odors associated with treated product.

Alkaline Stabilization

- Insufficient amount of lime (or other alkaline additive) used to assure pH is raised sufficiently.
- Inadequate mixing provided to assure good contact of lime (or other alkaline additive) with sludge solids.
- pH problems.^a
- Excess odors associated with treatment area.
- Excess odors associated with treated product.
- Excessive lime dust around treatment equipment.

Incineration

- Objectionable odors associated with treatment area.
- Evidence of excessive dust (ash) around unit.
- Visible smoke or dust exhaust from unit.
- Lack of compliance with air permit parameters.
- Spilling or leaking sludge from dewatered sludge transfer equipment.

Sludge Disposal Problems

- Sludge constituents not analyzed before disposal.
- Sludge not transported in appropriate and approved vehicle.
- Surface runoff of sludge at land application site.
- Liquid sludge (i.e., less than 10 percent solids) applied to landfill site.
- Sludge fails paint filter test.
- Inadequate coverage of sludge in subsurface plow injection system.
- Objectionable odors generated at land application site.^a
- Slow drying of soil-sludge mixture in subsurface injection system.
- Sludge ponding at land application sites.
- Flies breeding, vectors, and/or odors at landfill site.
- Inadequate burial of sludge at landfill site.
- Excessive erosion at sludge sites.
- Sludge disposed of in non-permitted sites.
- Disposal not in accordance with federal, state, or local regulations.
- Sludge lagoons full and overflowing.^a
- Inadequate runoff control at landfill or land application sites.

^a Indicates serious problems with the sludge handling process.

Table 10-8. Pollutants Monitored for Land Application, Surface Disposal, and Incineration

Pollutant	Land Application	Surface Disposal (Unlined Units)	Incineration
Arsenic	✓	✓	✓
Beryllium			✓
Cadmium	✓		✓
Chromium		✓	✓
Copper	✓		
Lead	✓		✓
Mercury	✓		✓
Molybdenum	✓		
Nickel	✓	✓	✓
Selenium	✓		
Zinc	✓		
Nitrogen series	✓		

Organism to Be Monitored	Allowable Level in Sludge
Fecal Coliform ^a	1,000 Most Probable Number (MPN) per gram (Class A) of total solids (dry weight).
<i>Salmonella sp.</i> ^a Bacteria (in lieu of fecal coliform)	3 MPN per 4 grams of total solids (dry weight).
Enteric Viruses ^b	Less than one plaque-forming unit per 4 grams of total solids (dry weight).
Viable Helminth ^b Ova	Less than one viable helminth ovum per 4 grams of total solids (dry weight).
Fecal Coliform ^c	Less than 2×10^6 MPN or less than 2×10^6 colony-forming units per gram of total solids (dry weight) (expressed as geometric mean of the results of 7 individual samples).

^a All Part 503 Class A Alternatives 1, 2, 3, 4, 5, 6.

^b Class A Alternatives 3 and 4 only.

^c Class B, Alternative 1.

C. REFERENCES

The following is a list of resources providing additional information on biosolids.

American Public Health Association (APHA), American Water Works Association (AWWA), and World Economic Forum (WEF). (2013). *Standard Methods for the Examination of Water and Wastewater*.

Clark, J.W., Wiessman, W., and Hammer, M. (1977) *Water Supply Pollution Control*. Harper and Row Publishers, 1977 *Code of Federal Regulations. Standards for the Use or Disposal of Sewage Sludge*. 40 CFR Part 503, 58 FR 9387.

- Culp, G.L., and Folks Heim, N. (1978). *Field Manual for Performance Evaluation and Troubleshooting at Municipal Wastewater Treatment Facilities*. U.S. Environmental Protection Agency, EPA 430/9-78-001.
- Hinrichs, D.J. (1979). *Inspectors Guide for Evaluation of Municipal Wastewater Treatment Plants*. U.S. Environmental Protection Agency, 430/9-79-010.
- Loeht, R.C. (1984). *Pollution Control for Agriculture*. Academic Press Inc.
- National Research Council. (2002). *Biosolids Applied to Land: Advancing Standards and Practices*.
- Metcalf and Eddy Inc. (2013). *Wastewater Engineering*. New York: McGraw-Hill Book Company.
- Steel, E.W., and McGhee, T.J. (1979). *Water Supply and Sewerage*. New York: McGraw-Hill Book Company.
- U.S. Congress. (1985). *Overview of Sewage Sludge and Effluent Management*. Office of Technology Assessment. C/R-36b/#10.
- U.S. Environmental Protection Agency. (1973a). *Pathogen Risk Assessment Feasibility Study*. Office of Research and Development. EPA 670/2-73/098.
- U.S. Environmental Protection Agency. (1973b). *Odors Emitted from Raw and Digested Sewage Sludge*. Office of Research and Development. EPA 670/2-73/098.
- U.S. Environmental Protection Agency. (1975). *Process Design Manual for Suspended Solids Removal*. EPA 625/1-75-0032.
- U.S. Environmental Protection Agency. (1976a). *Municipal Sludge Management: EPA Construction Grants Program*. Office of Water Program Operations. EPA 430/9-76/009.
- U.S. Environmental Protection Agency. (1976b). *Application of Sewage Sludge to Cropland; Appraisal of Potential Hazards of the Heavy Metals to Plants and Animals*. Office of Water Program Operations. EPA 430/9-76/013.
- U.S. Environmental Protection Agency. (1977). *Municipal Sludge Management: Environmental Factors*. Office of Water Program Operations. EPA 430/9-77/004.
- U.S. Environmental Protection Agency. (1978a). *Applications of Sludge on Agricultural Land*. Municipal Construction Division, Office of Research and Development. EPA 600/2-78/131b.
- U.S. Environmental Protection Agency. (1978b). *Sewage Disposal on Agricultural Soils: Chemical and Microbiological Implications*. Office of Research and Development. EPA 600/2-78/131b.

- U.S. Environmental Protection Agency. (1978c). *Operations Manual, Sludge Handling and Conditioning*. Office of Water Program Operations. EPA 430/9-78-002.
- U.S. Environmental Protection Agency. (1978d). *Municipal Sludge Landfills*. Environmental Research Information Center, Office of Solid Waste. EPA 625/1-78/010, SW-705.
- U.S. Environmental Protection Agency. (1979). *Process Design Manual for Sludge Treatment and Disposal*. Municipal Environmental Research Laboratory. EPA 625/1-79-011.
- U.S. Environmental Protection Agency. (1980a). *Test Methods for Evaluating Solid Waste, Physical/Chemical Methods (SW-846)*. 3rd ed.
- U.S. Environmental Protection Agency. (1980b). *Evaluation of Sludge Management Systems*. Office of Water Program Operations. EPA 430/9-80-001, MCD-61.
- U.S. Environmental Protection Agency. (1981a). *Land Treatment of Municipal Wastewater*. EPA Center for Environmental Research Information. EPA 625/1-81-013.
- U.S. Environmental Protection Agency. (1981b). *Composting Processes to Stabilize and Disinfect Municipal Sewage Sludge*. Office of Water Program Operations. EPA 430/9-81-011, MCD-79.
- U.S. Environmental Protection Agency. (1982). *Process Design Manual for Dewatering Municipal Wastewater Sludges*. Office of Research and Development. EPA 625/1-82-014.
- U.S. Environmental Protection Agency. (1983). *Land Application of Municipal Sludge*. Municipal Environmental Research Laboratory. EPA 625/1-83/016.
- U.S. Environmental Protection Agency. (1984). *Use and Disposal of Municipal Wastewater Sludge*. Intra-Agency Sludge Task Force. EPA 625/10-84-003.
- U.S. Environmental Protection Agency. (1985a). *Summary of Environmental Profiles and Hazard Indices for Constituents of Municipal Sludge*. Office of Water Regulations and Standards.
- U.S. Environmental Protection Agency. (1985b). *Composting of Municipal Wastewater Sludges*. EPA Center for Environmental Research Information. EPA 625/4-85-014.
- U.S. Environmental Protection Agency. (1985c). *Municipal Wastewater Sludge Combustion Technology*. EPA Center for Environmental Research Information, EPA 625/4-85-015.
- U.S. Environmental Protection Agency. (1986). *Radioactivity of Municipal Sludge*. Office of Water Regulations and Standards.
- U.S. Environmental Protection Agency. (1987a). *Dewatering Municipal Wastewater Sludges*, Office of Research and Development. EPA 625/1-87/014.

- U.S. Environmental Protection Agency. (1987b). *Advanced Waste Treatment — Field Study Training Program*.
- U.S. Environmental Protection Agency. (1988a). *Analytical Methods Used in the National Sewage Sludge Survey*.
- U.S. Environmental Protection Agency. (1988b). *Sampling Procedures and Protocols for the National Sewage Sludge Survey*. Office of Water Regulations and Standards.
- U.S. Environmental Protection Agency. (1989a). *POTW Sludge Sampling and Analysis Guidance Document*. Office of Water Enforcement and Permits. EPA 833-B-89-100.
- U.S. Environmental Protection Agency. (1989b). *Control of Pathogens in Municipal Wastewater Sludge*. Center for Environmental Research Information. EPA 625/10-89/006.
- U.S. Environmental Protection Agency. (1990a). *Analytical Methods for the National Sewage Sludge Survey*. Office of Water Regulations and Standards.
- U.S. Environmental Protection Agency. (1990b). *NPDES Compliance Monitoring Inspector Training Module: Laboratory Analysis*. EPA 833-R-90-103.
- U.S. Environmental Protection Agency. (1990c). *Test Methods for Evaluating Solid Waste, Physical/Chemical Methods*. EPA SW-846.
- U.S. Environmental Protection Agency. (1991a). *Guidance Manual for NPDES Compliance Inspector: Evaluation of Sludge Treatment Processes*. EPA 833/B-91-100.
- U.S. Environmental Protection Agency. (1991b). *Guidance Manual for NPDES Compliance Inspector: Verifying Compliance with Sludge Requirements*.
- U.S. Environmental Protection Agency. (1992). *A Guide to the Federal EPA Rule for Land Application of Domestic Septage to Non-Public Contact Sites*. (Agricultural Land, Forests, and Reclamation Sites) Discussed in Relationship to Existing State Rules and Other Federal Regulations of Septage. EPA 832-B-92-005.
- U.S. Environmental Protection Agency. (1993a). Video: *Sewage Sludge Sampling Techniques*.
- U.S. Environmental Protection Agency. (1993b). *Preparing Sewage Sludge for Land Application or Surface Disposal; A Guide for Preparers of Sewage Sludge on the Monitoring, Recordkeeping, and Reporting Requirements of the Federal Standards for the Use or Disposal of Sewage Sludge in 40 CFR Part 503*. Office of Water. EPA 831-B-93-002a.
- U.S. Environmental Protection Agency. (1994a). *Land Application of Sewage Sludge; A Guide for Land Appliers on the Recordkeeping and Reporting Requirements of the Federal Standards for the Use and Disposal of Sewage Sludge Management in 40 CFR Part 503*. EPA 831-B-93-002b.

U.S. Environmental Protection Agency. (1994b). *Surface Disposal of Sewage Sludge; A Guide for Owners/Operators of Surface Disposal Facilities on the Monitoring, Recordkeeping, and Reporting Requirements of the Federal Standards for the Use and Disposal of Sewage Sludge in 40 CFR Part 503*. EPA 831-B-93-002c.

U.S. Environmental Protection Agency. (1994c). *A Plain English Guide to the EPA Part 503 Biosolids Rule*. EPA 831-B-94-001.

U.S. Environmental Protection Agency. (1994d). *A Guide for Land Appliers on the Requirements of the Federal Standards for the Use or Disposal of Sewage Sludge, 40 CFR Part 503*. EPA/831-B-93-002b.

U.S. Environmental Protection Agency. (1995a). *Process Design Manual: Land Application of Sewage Sludge and Domestic Septage*. EPA/625/R-95/001.

U.S. Environmental Protection Agency. (1995b). *A Guide to the Biosolids Risk Assessments for the EPA Part 503 Rule*. EPA 832-B-93-005.

U.S. Environmental Protection Agency. (1999). *Proposed Rule Revising the Standards for Use and Disposal of Biosolids*. EPA 822-F-99-005.

U.S. Environmental Protection Agency. (2000a). *Biosolids Technology Fact Sheet Alkaline Stabilization of Biosolids*. EPA 832-F-00-052.

U.S. Environmental Protection Agency. (2000b). *Biosolids Technology Fact Sheet Centrifuge Thickening and Dewatering*. EPA 832-F-00-053.

U.S. Environmental Protection Agency. (2000c). *Biosolids Technology Fact Sheet Belt Filter Press*. EPA 832-F-00-057.

U.S. Environmental Protection Agency. (2000d). *Guide to Field Storage of Biosolids*. EPA 832-B-00-007.

U.S. Environmental Protection Agency. (2003). *Control of Pathogens and Vector Attraction in Sewage Sludge*. Office of Research and Development, EPA 625/R-92/013. Guidance updates accessible on Principal Biosolids Guidance website at:

<https://www.epa.gov/biosolids/control-pathogens-and-vector-attraction-sewage-sludge>

U.S. Environmental Protection Agency. (2014). *Test Methods for Evaluating Solid Wastes: Physical/Chemical Methods*. SW846 Update V.

CHAPTER 11 – STORMWATER

Contents

A. Background and History	236
Regulation Overview (40 CFR 122.26).....	236
B. Stormwater Discharges Associated with Industrial Activity (Not Including Construction).....	241
Applicability (Who is Covered)	241
Permit Applications for Stormwater Discharges Associated with Industrial Activity	244
Monitoring (including Self-Inspections)	249
C. Stormwater Discharges Associated with Construction Activity	254
Applicability (Who is Covered)	254
Permit Applications for Stormwater Discharges Associated With Construction Activity.....	256
Stormwater Pollution Prevention Plan Requirements.....	258
SWPPP Implementation/In the Field.....	264
D. Stormwater Discharges From Municipal Separate Storm Sewer Systems	266
Applicability (Who is Covered)	266
Permit Applications for Stormwater Discharges From Municipal Separate Storm Sewer Systems.....	267
Stormwater Management Program (SWMP) Development	269
SWMP Implementation/In the Field	273
E. References.....	274

List of Tables

Table 11-1. Summary of Stormwater Permitting Regulations.....	238
Table 11-2. Summary of Permit Requirements Under the NPDES Stormwater Program Regulations	240
Table 11-3. SIC Codes Regulated for Stormwater Discharges	250
Table 11-4. Industrial Categories Associated with Industrial Activity	252
Table 11-5. Examples of Site-Specific Industrial Stormwater Control Measures	253
Table 11-6. Site-Specific Construction Stormwater Control Measures	266

Associated Appendices

- Q. No Exposure Certification Form
- R. NPDES Industrial Stormwater Investigation and Case Development Worksheet (Industrial)
- S. Industrial Source Control BMP Questions
- T. Notice of Termination for Stormwater
- U. Typical “C” Coefficients
- V. Rain Zones of the United States
- W. NOAA Rainfall Worksheet
- X. NPDES Construction Stormwater Investigation and Case Development Worksheet (Construction)
- Y. Construction Control Source BMP Questions

A. BACKGROUND AND HISTORY

REGULATION OVERVIEW (40 CFR 122.26)

In addition to materials in this chapter, inspectors should be familiar with Chapter 1, “Introduction,” Chapter 2, “Inspection Procedures,” Chapter 12, “Combined Sewer Systems,” and Chapter 13, “Inspecting Green Infrastructure Controls.”

1987 Amendments to CWA	
Section 402(p) municipal and industrial stormwater discharges	
(1)	General Rule—prohibits permits for discharges composed entirely of stormwater prior to October 1, 1994 with some exceptions.
(2)	Exceptions—identifies five types of stormwater discharges that are to be permitted prior to October 1, 1994.
(3)	Permit Requirements—identifies permitting approach for industrial and municipal stormwater discharges.
(4)	Permit Application Requirements—identifies application requirements for industrial and municipal stormwater discharges.
(5)	Studies—identifies requirement for report to congress on other sources of stormwater discharges.
(6)	Regulations—requires regulations for permitting other types of stormwater discharges to protect water quality.

The 1972 amendments to the Clean Water Act (CWA) prohibited the discharge of any pollutants to navigable waters from a point source unless the discharge was authorized by a National Pollutant Discharge Elimination System (NPDES) permit. At the time of the 1972 amendments to the CWA, sewage treatment plant outfalls and industrial process wastewater were easily identified as point sources responsible for contributing to the degradation of water quality. However, as pollution control measures were instituted, it became evident that more diffuse sources, such as agricultural and urban stormwater runoff, were also contributing to the problem. In response to this concern, the Water Quality Act (WQA) of 1987 added section 402(p) to the CWA and required the Environmental Protection Agency (EPA) to establish a comprehensive two-phase approach to address stormwater discharges.

The 1987 WQA established new schedules for issuing NPDES permits to industrial and municipal stormwater dischargers. Industrial stormwater discharge permits must include requirements implementing Best Available Technology Economically Achievable (BAT) and Best Conventional Pollutant Control Technology (BCT) standards, as well as any more stringent requirements necessary to achieve water quality standards. Municipal separate storm sewer system (MS4) permits must require controls to reduce pollutant discharges to the maximum extent practicable (MEP), including management practices, control techniques and system design and engineering methods, and such other provisions as the Administrator deems appropriate for the control of such pollutants.

As required by section 402(p)(4) of the CWA, EPA promulgated Phase I Stormwater regulations on November 16, 1990 (Volume 55 *Federal Register* (FR) 47990). The regulations set forth permit application requirements, including definitions, for the five-point source stormwater

discharge categories subject to NPDES permit requirements under section 402(p)(2) of the CWA:

- A discharge subject to a NPDES permit before February 4, 1987.
- A discharge associated with industrial activity (including construction activities \geq 5 acres).
- A discharge from a municipal separate storm sewer system serving a population of 250,000 or more (large MS4s).
- A discharge from a municipal separate storm sewer system serving a population of 100,000 or more but less than 250,000 (medium MS4s).
- A discharge that an NPDES permitting authority determines to be contributing to a violation of a water quality standard or a significant contributor of pollutants to waters of the United States.

Pursuant to section 402(p)(6) of the CWA, EPA promulgated Phase II Stormwater regulations on December 8, 1999 (64 FR 68722). Section 402(p)(6) of the CWA required EPA to designate additional stormwater discharges not already covered by Phase I regulation, based on studies required under section 402(p)(5) of the CWA, to be regulated “to protect water quality.” The Phase II rule added certain small municipal separate storm sewers systems in urbanized areas (small MS4s) and small active construction sites (disturbing between 1 and 5 acres) as stormwater discharges subject to NPDES permitting requirements. The Phase II rule also established criteria for the permitting authority to designate additional small MS4s and previously unregulated stormwater discharges, and require NPDES permits for those discharges (residual designation authority).

The Phase I stormwater regulations are codified primarily in Title 40 of the *Code of Federal Regulations* (CFR) 122.26 and the Phase II regulations are primarily in 40 CFR 122.30-122.37. A summary of these sections is provided in Table 11-1. Stormwater discharged through combined sanitary and storm sewer systems are not covered by the stormwater regulations.

On November 25, 2014, EPA issued a memorandum noting revisions to the memorandum titled *Establishing Total Maximum Daily Load (TMDL) Wasteload Allocations (WLAs) for Storm Water Sources and NPDES Permit Requirements Based on Those WLAs* (EPA, 2014a). In the memorandum, EPA encouraged permit writers to include clear, specific, and measurable permit requirements and where feasible, numeric effluent limitations in NPDES permits for stormwater discharges. Additionally, permits should contain clear, specific, and measurable elements associated with the implementation of stormwater control measures (e.g., schedule for installation, frequency of a practice, or level of performance), as appropriate. The permit should be supported by documentation that implementation of selected stormwater control measures will result in achievement of water quality standards. Permitting authorities should also consider including numeric benchmarks for stormwater control measures and associated monitoring protocols for estimating stormwater control effectiveness in stormwater permits. Benchmarks can support an adaptive approach to meeting applicable water quality standards. While exceeding the benchmark is not generally a permit violation, exceeding the benchmark

would typically require the permittee to take additional action, such as evaluating the effectiveness of the stormwater control measures, implementing and/or modifying stormwater control measures, or providing additional measures to protect water quality.

Though industrial facilities, construction sites, and MS4s are distinct and are typically permitted separately, there is some crossover between these entities. Industrial facilities and construction sites often discharge to a regulated MS4 and are therefore subject to the local ordinances and requirements established by the MS4 pursuant to its NPDES permit, as well as the requirements of the specific facility or site's NPDES stormwater permit. Industrial facilities and construction sites that are regulated for stormwater are covered under their local MS4 and under either the EPA or state-issued Multi Sector General Permit (MSGP, for industrial) or the Construction General Permit (CGP). While the general permits issued by EPA can only apply to facilities in jurisdictions where EPA is the permitting authority, many states model their own general permits on EPA's general permits. For example, EPA's MSGP for industrial stormwater covers stormwater discharges associated with both industrial activity and some construction activity associated with certain mining and oil and gas facilities. For clarity, the remainder of this chapter discusses industrial, construction and municipal permitted entities separately. Table 11-2 contains a summary of Permitting Requirements under the NPDES Stormwater Program Regulations. EPA encourages inspectors to contact the permit writers and/or the permitting authority for clarification or concerns related to the permit specifications of sites being inspected.

Table 11-1. Summary of Stormwater Permitting Regulations

40 CFR Part 122—EPA Administered Permit Programs: The National Pollutant Discharge Elimination System	
122.1	Purpose and Scope
122.21	Application for a Permit
122.22	Signatories to Permit Applications and Reports
122.26(a)	Permit Requirements
122.26(b)	Definitions
122.26(c)	Application Requirements for Stormwater Discharges Associated with Industrial Activity and Stormwater Discharges Associated with Small Construction Activity
122.26(d)	Application Requirements for Large and Medium Municipal Separate Storm Sewer Discharges
122.26(e)	Application Deadlines
122.26(f)	Petitions
122.26(g)	Conditional Exclusion for "No Exposure" of Industrial Activities and Materials to Stormwater
122.28	General Permits
122.30	What are the objectives of the stormwater regulations for small MS4s?
122.31	As a tribe, what is my role under the NPDES stormwater program?

Table 11-1. Summary of Stormwater Permitting Regulations

40 CFR Part 122—EPA Administered Permit Programs: The National Pollutant Discharge Elimination System	
122.32	As an operator of a small MS4, am I regulated under the NPDES stormwater program?
122.33	If I am an operator of a regulated small MS4, how do I apply for an NPDES permit and when do I have to apply?
122.34	As an operator of a regulated small MS4, what will my NPDES MS4 stormwater permit require?
122.35	As an operator of a regulated small MS4, may I share the responsibility to implement the minimum control measures with other entities?
122.36	As an operator of a regulated small MS4, what happens if I don't comply with the application requirements in 122.33 through 122.35?
122.37	Will the small MS4 stormwater program regulations at 122.32 through 122.36 and 122.35 of this chapter change in the future?
122.42	Additional Conditions Applicable to Specified Categories of NPDES Permits
122.44	Establishing Limitations, Standards, and Other Permit Conditions
122.62	Modifications or Revocation and Reissuance of Permits
40 CFR Part 123—State Program Requirements	
123.25	Requirements for Permitting
123.35	As the NPDES permitting authority for regulated small MS4s, what is my role?
40 CFR Part 124—Procedures for Decision-making	
124.52	Permits Required on a Case-by-Case Basis
Appendix E	Rainfall Zones of the United States
Appendix F	Incorporated Places with Populations Greater Than 250,000 According to Latest Decennial Census by Bureau of Census
Appendix G	Incorporated Places with Populations Greater Than 100,000 and Less Than 250,000 According to Latest Decennial Census by Bureau of Census
Appendix H	Counties with Unincorporated Urbanized Areas with a Population of 250,000 or More According to the Latest Decennial Census by the Bureau of Census
Appendix I	Counties with Unincorporated Urbanized Areas Greater Than 100,000, but Less Than 250,000 According to the Latest Decennial Census by the Bureau of Census

Table 11-2. Summary of Permit Requirements Under the NPDES Stormwater Program Regulations

	Municipal Separate Storm Sewer Systems (MS4s) Regulations	Construction Activity General Permit	Industrial Activity General Permit
Phase I Requirements (November 16, 1990)	Medium and Large MS4s (122.26(d))	Category (x) Construction Activity (5+Acres)	Ten Categories of Industrial Activity (Categories (i)-(ix), (xi))
	<ul style="list-style-type: none"> • Establish adequate legal authority to control discharges to storm sewer, inspect, and enforcement. • Identify major stormwater sources and locations of outfalls, and provide characterization data of discharges. • Develop Stormwater Management Program: <ul style="list-style-type: none"> – Controls for residential and commercial activities. – Illicit discharge detection and elimination program. – Controls for municipal and industrial activities. – Construction site controls. • Assess controls and perform fiscal analysis. • Submit annual report. 	<p><u>CGP:</u></p> <ul style="list-style-type: none"> • Stormwater Pollution Prevention Plan (SWPPP): <ul style="list-style-type: none"> – Site description. – Description of control measures for erosion and sediment, post-construction stormwater management, and other controls. – Self-evaluation and recordkeeping. 	<p><u>MSGP:</u></p> <ul style="list-style-type: none"> • SWPPP: <ul style="list-style-type: none"> – Site evaluation. – Description of appropriate stormwater control measures. – Self-evaluation, monitoring, recordkeeping, and, in some circumstances, reporting. – If discharging into a medium or large MS4, notify the MS4 operator.
Phase II Requirements (December 8, 1999)	Regulated Small MS4	Small Construction Activity (≥ 1 and <5 acres)	Industrial
	<ul style="list-style-type: none"> • Stormwater Management Program: <ul style="list-style-type: none"> – Public education and outreach. – Public participation efforts. – Illicit discharge detection and elimination program. – Construction runoff control program for construction activity disturbing 1 acre or greater. 	<ul style="list-style-type: none"> • Generally similar to category (x) Construction Activity requirements above. • Small construction waivers requirement. 	Option for Conditional no exposure waiver if certain criteria are met.

Table 11-2. Summary of Permit Requirements Under the NPDES Stormwater Program Regulations

	Municipal Separate Storm Sewer Systems (MS4s) Regulations	Construction Activity General Permit	Industrial Activity General Permit
	<ul style="list-style-type: none"> – Post-construction runoff control program for construction activity disturbing 1 acre or greater. – Good housekeeping/pollution prevention for municipal operations. • Conduct assessment of identified stormwater control measures and measurable goals for each minimum control measure. • Submit periodic program assessment reports. 		

B. STORMWATER DISCHARGES ASSOCIATED WITH INDUSTRIAL ACTIVITY (NOT INCLUDING CONSTRUCTION)

APPLICABILITY (WHO IS COVERED)

The stormwater regulations identify 11 categories of industrial facilities that are engaging in industrial activity that is regulated under the stormwater program (40 CFR 122.26(b)(14)(i)–(xi)). EPA defines these categories of industrial facilities using a combination of standard industrial classification codes and descriptions of facility activities. A description of these 11 categories is provided in Table 11-5. One of the 11 categories, category (x), is construction activity disturbing 5 acres or more. This category is discussed separately in Section 11.C because of the significant differences in site activities and requirements at construction sites compared to the other 10 industrial categories.

EPA estimates that nationwide more than 150,000 industrial facilities are required to obtain NPDES permit coverage for stormwater discharges associated with industrial activity.

The NPDES regulations, at 40 CFR 122.26(b)(14), define “stormwater discharges associated with industrial activity.” Specifically, the phrase means “the discharge from any conveyance that is used for collecting and conveying stormwater and that is directly related to manufacturing, processing or raw materials storage areas at an industrial plant.” For the 10 categories of industries identified in 40 CFR 122.26(b)(14)(i)–(ix), and (xi), the term includes, but is not limited to, stormwater discharges from the following:

- Industrial plant yards.
- Immediate access roads and rail lines used or traveled by carriers of raw materials, manufactured products, waste material, or byproducts used or created by the facility.
- Material handling sites.
- Refuse sites.
- Sites used to apply or dispose of process waste waters (as defined at 40 CFR Part 401).
- Sites used for storage and maintenance of material handling equipment.
- Sites used for residual treatment, storage, or disposal.
- Shipping and receiving areas.
- Manufacturing buildings.
- Storage areas (including tank farms) for raw materials and intermediate and finished products.
- Areas where industrial activity has taken place in the past and significant materials remain and are exposed to stormwater.

Material handling activities include storage, loading and unloading, transportation, or conveyance of any raw material, intermediate product, final product, by-product, or waste product. The term excludes areas located on plant lands separate from the plant's industrial activities, such as the office buildings and accompanying parking lots as long as the drainage from the excluded areas is not mixed with stormwater drained from any of the above described areas (40 CFR 122.26(b)(14)).

One of the first questions a stormwater inspector must consider is the applicability of the stormwater permitting regulations to a specific facility. The inspector should determine what types of industrial activities are performed by the facility, and which SIC codes may apply to the facility. Industrial categories covered by 40 CFR 122.26(b)(14) include:

- Facilities subject to stormwater effluent limitation guidelines (40 CFR chapter I, subchapter N).
- Industries defined by certain Standard Industrial Classification (SIC) Codes (e.g., lumber and wood products, primary metal industry).
- Mineral Industry.
- Hazardous waste treatment, storage, or disposal facilities.
- Landfills, including land application sites and open dumps.
- Facilities that recycle, reclaim, or salvage materials including scrap material.
- Steam electric power facilities.
- Transportation facilities that have vehicle maintenance shops, equipment cleaning operations or airport deicing operations.
- Sewage treatment plants.
- Construction activities.
- Light Industry classified by SIC Code.

Facilities within these industrial categories require a stormwater permit whenever any of the listed activities occur on-site, regardless of the facility's SIC code or other types of activity. See Table 11-5 for a more detailed description of these categories. As mentioned above, some of the covered industrial categories are defined by SIC code. Where multiple industrial activities are conducted at a site, with each activity having a distinct SIC code, the facility's primary SIC code generally determines whether a facility is regulated pursuant to one of the listed SIC codes. The primary SIC code is based on the primary industrial activity occurring at the site (see Table 11-4 for a list of primary SIC codes covered by the stormwater permitting requirements). EPA recommends comparing the value of receipts or revenues and/or number of people employed for each industrial activity to identify the primary activity of the facility. If the SIC code for this primary activity is identified in 40 CFR 122.26(b)(14), then the facility is subject to the stormwater permitting requirements. However, if the facility's primary activity is not included in 40 CFR 122.26(b)(14), the facility is not subject to the permitting requirements even if the facility conducts secondary activities that are identified therein (unless otherwise designated by the Director as needing a permit).

Some of the industrial categories are defined using a narrative description rather than SIC codes. In these instances, any facility engaging in an industrial activity that meets a narrative description is required to obtain permit coverage for those specific activities regardless of the facility's SIC code(s).

Exemption for Mining or Oil and Gas Facilities

Federal regulations at 40 CFR 122.26(c)(1)(iii) specify that stormwater discharges from oil or gas exploration, production, processing, treatment operations, or transmission, do not require NPDES permit coverage unless the facility has had a stormwater discharge that contained a reportable quantity of a designated hazardous substance for which notification is or was required (pursuant to 40 CFR 117.21, 40 CFR 302.6 or 40 CFR 110.6), or has had a stormwater discharge that contributes to a violation of a water quality standard.

Consistent with 40 CFR 122.26(c)(1)(iv), a discharge composed entirely of stormwater from a mining operation associated with oil or gas is not required to submit a permit application unless the discharge has contacted any overburden, raw material, intermediate products, finished product, byproduct, or waste products located on the site of such operations.

For more information on the applicability of stormwater regulations to oil and gas facilities, please visit <http://www.epa.gov/npdes/oil-and-gas-stormwater-permitting#undefined>.

No Exposure Conditional Exclusion

The Phase II No Exposure Conditional Exclusion significantly expands the scope of the original no exposure exclusion eligibility requirements. Under 40 CFR 122.26(g), operators of regulated industrial facilities in any of 10 categories of "stormwater discharges associated with industrial activity," may qualify for the exclusion if none of the facility's industrial materials or activities are exposed to stormwater. See 40 CFR 122.26(g)(1) for a list of qualification criteria. As long as the condition of "no exposure" exists at a qualified facility, stormwater discharges from the facility are excluded from the definition of "stormwater discharges associated with industrial

activity.” The facility operator must submit a no exposure certification exclusion to the permitting authority, EPA or the authorized state, once every five years and is subject to periodic inspections to determine compliance with the “no exposure” conditions. The no exposure certification replaces the previous “light industry” no exposure exemption included under the Phase I Stormwater Program. A no exposure certification form can be found in Appendix Q.

No exposure means all industrial materials and activities are protected by a storm-resistant shelter to prevent exposure to rain, snow, snowmelt, and/or runoff. Industrial materials or activities include, but are not limited to, material handling equipment or activities, industrial machinery, raw materials, intermediate products, byproducts, final products, or waste products (40 CFR 122.26(g)).

PERMIT APPLICATIONS FOR STORMWATER DISCHARGES ASSOCIATED WITH INDUSTRIAL ACTIVITY

Industrial facilities have two NPDES permit options for stormwater discharges—coverage under 1) a general permit or 2) an individual permit. Most industrial facilities have permit coverage under a general permit, which is developed for facilities sharing similar discharge characteristics. Individual permits are developed when a facility requires permit coverage but either the facility or the permitting authority does not believe a general permit is appropriate based on the discharge characteristics. Where EPA is the NPDES permitting authority, the Multi-Sector General Permit (MSGP) issued on June 4, 2015 (80 FR 34403), is the most recent general permit available to industrial facility operators. A copy of the 2015 MSGP and related documents are available at <http://www.epa.gov/npdes/stormwater-discharges-industrial-activities#msgp>.

The EPA MSGP covers 29 industrial sectors. Standard Industrial Classification (SIC) codes and narrative descriptions identify the categories of industrial facilities within each of the 29 sectors. Though the EPA MSGP is applicable only in areas where EPA is the permitting authority, similar general permits may be available in NPDES-authorized states. Information related to the EPA MSGP and individual permits is presented below.

General Permit/Notice of Intent

To apply for permit coverage under EPA’s or a state’s MSGP, a facility operator must complete and submit an electronic Notice of Intent (eNOI) form, or the applicable form used by the state NPDES permitting authority. Those facilities already covered under the prior MSGP are required to submit a new eNOI each time the MSGP is re-issued. The eNOI requests a variety of basic facility information, including latitude/longitude of the facility, and information related to the Endangered Species Act and the National Historic Preservation Act. Permit applicants have the option of either providing an internet link to their stormwater pollution prevention plan (SWPPP) or providing compliance information directly on the eNOI form including a description of industrial activities exposed to stormwater, a list of pollutants associated with each industrial activity exposed to stormwater, a description of the control measure that will be employed, a schedule for good housekeeping and maintenance, and a schedule for all required inspections.

The deadline for submission of an NOI to be covered under the 2015 EPA MSGP was September 2, 2015 for most existing sources.

Under EPA's 2015 MSGP, new facilities and facilities that change ownership or operators must generally submit an NOI at least 30 days prior to the commencement of discharge or change in ownership/operator.

EPA has developed the eNOI for industrial facilities that seek coverage under EPA's MSGP, which can be found on EPA's Electronic Multi-Sector General Permit Notice of Intent (eNOI) home page (<http://www.epa.gov/npdes/stormwater-discharges-industrial-activities#overview>). For the 2015 MSGP, permittees submit Notices of Intent (NOIs)—as well as Notices of Termination (NOTs), Annual Reports, and No Exposure Certifications—using the NPDES eReporting Tool for the MSGP (NeT-NSGP). Permittees that are required to submit DMRs use NetDMR to submit them electronically.

In rare circumstances the EPA Regional Office may grant facility operators an electronic reporting waiver when needed. In such cases, the operator mails the paper forms provided in the 2015 MSGP.

Individual Permits

There are circumstances when a general permit is either not available or not applicable to a specific industrial facility. A facility operator may obtain coverage under an individual permit instead, developed by the NPDES permitting authority specifically for that facility. An individual permit may be the only option when:

- The NPDES permitting authority requires a facility operator to apply for individual permit coverage.
- The facility operator is unable to certify eligibility with the conditions of the general permit, because the general permit does not adequately cover the regulated facility, process or discharge.

A summary of the permit application deadlines is presented in Table 11-3. The Transportation Act of 1991 modified the application deadlines for industrial activities owned or operated by municipalities (i.e., types of industrial activities covered by MSGP). The Phase II Rule required industrial activities operated by municipalities with populations less than 100,000 to obtain permit coverage by no later than March 10, 2003, (unless the NPDES permitting authority chooses to phase-in permit coverage on a watershed basis and establishes other deadlines). As such, all industrial activities defined in 40 CFR 122.26(b)(14) are now required to obtain coverage, unless waived.

Stormwater Pollution Prevention Plan Requirements/Office Review

In most cases, operators must prepare a SWPPP for the industrial facility before submitting a Notice of Intent for permit coverage. The SWPPP must be signed by a responsible corporate official such as a president, vice president, or general partner as identified in the EPA MSGP. Under most permits, the SWPPP is to be kept at the facility at all times (or other local location

accessible to the EPA, a state, tribal, or territorial agency with jurisdiction over water quality protection; local government officials; or the operator of a MS4 receiving discharges from the site) and must be available for review when requested by EPA or by the operator of the MS4 when the facility discharges to a municipal separate storm sewer.

For large or complex facilities, it may be appropriate for the inspector to request a copy of the SWPPP prior to inspection to be more familiar with the facility during the inspection. Inspectors should check to see if the facility has posted their SWPPP on line. The eNOI for the 2015 MSGP gives permit applicants the option of either posting their SWPPP on line or providing additional information in their application, such as a description of industrial activities exposed to stormwater, a list of pollutants associated with each industrial activity exposed to stormwater, a description of the control measure that will be employed, a schedule for good housekeeping and maintenance, and a schedule for all required inspections. Otherwise, the inspector will need to obtain a copy of, and review, the SWPPP or at least parts of the SWPPP during the inspection. At a minimum, the inspector should review the site map prior to conducting the field inspection to understand the site and the existing/planned stormwater controls, and carry a copy of the site map during the inspection when possible. Depending on the time available for the inspection and the size of the SWPPP, the inspector may request a copy of the SWPPP for review after the inspection.

In reviewing the SWPPP, the inspector should evaluate whether it contains all the required elements specified in the applicable permit (e.g., the current EPA MSGP, the state General Permit in NPDES-authorized states, or an individual permit issued to the facility).

The 2015 EPA MSGP lists the following specific items that must be included in the SWPPP:

- **Stormwater Pollution Prevention Team** identifying individuals responsible for developing, implementing, maintaining, and revising the SWPPP.
- Description of industrial activities at the facility.
- General location map depicting the facility and location of receiving waters.
- Legible site map indicating:
 - Location of potential pollutant sources and significant materials exposed to precipitation.
 - Locations of all stormwater conveyances including ditches, pipes, and swales.
 - Direction of stormwater flow.
 - Location of existing control measures.
 - Location of all surface water bodies.
 - Location where major spills or leaks have occurred.
 - Locations of activity areas exposed to precipitation, including fueling stations, vehicle and equipment maintenance and/or cleaning areas, processing and storage areas, access roads, etc.
 - Locations of stormwater inlets, outfalls and outline of areas draining to such outfalls.

- Location and description of non-stormwater discharges.
- Location and source of runoff from adjacent property containing significant quantities of pollutants of concern.
- Summary of potential pollutant sources.
- Areas of spills and leaks during prior three-year period.
- Documentation of non-stormwater discharge evaluations.
- Location of salt storage areas.
- Summary of sampling data.
- **Stormwater controls** to include a description of existing and planned control measures.
- **Summary of schedules and procedures** pertaining to control measures, and monitoring and inspections.
- **Documentation to support eligibility considerations** for other federal laws such as those regarding endangered species or historic properties.

These items are detailed in Section 5 of the EPA’s 2015 MSGP, which covers the general requirements for a SWPPP. In addition, the EPA MSGP contains sector-specific SWPPP requirements, which are found in Section 8 of the EPA 2015 MSGP. Finally, a state general permit may contain different and/or additional required items. The inspector should have the applicable state general permit for stormwater discharges associated with industrial activities.

Additionally, regulated small MS4s require post-construction stormwater management in new development and redevelopment projects. Post-construction stormwater management is required on projects that disturb greater than or equal to one acre, including projects less than one acre that are part of a larger common plan of development or sale, that discharge into a regulated small MS4. The permittee is required to develop, implement, and enforce a program to address stormwater runoff, including the development, implementation, and long-term operation and maintenance of best management practices (BMPs) appropriate for the community. Such BMPs may include stormwater detention structures, infiltration measures, or velocity dissipation devices installed in outfall channels to prevent erosion. Each state has developed its own program listing the criteria for post-construction BMPs to ensure water quality is maintained after the construction project has been completed. For a list of state programs, visit: https://www3.epa.gov/npdes/pubs/sw_state_summary_standards.pdf.

NOTE: As defined in 40 CFR 122.26(b)(12), significant materials include, but are not limited to: raw materials; fuels; materials such as solvents, detergents, and plastic pellets; finished materials such as metallic products; raw materials used in food processing or production; hazardous substances designated under section 101(14) of the Comprehensive Environmental Response, Compensation, and Liability Act (CERCLA); any chemical the facility is required to report pursuant to section 313 of Title III of Superfund Amendments and Reauthorization Act (SARA) (<http://www2.epa.gov/epcra/consolidated-list-lists>); fertilizers; pesticides; and waste products such as ashes, slag, and sludge that have the potential to be released with stormwater discharges.

The SWPPP may incorporate or may be incorporated into other plans that the facility has prepared for other permits or programs, including spill prevention control and countermeasure (SPCC) Plans and BMP programs (specific practices or actions used to reduce or control impacts to water bodies).

SWPPP Implementation/In the Field

In the field, the inspector should verify that the map and description of potential pollutant sources in the SWPPP reflect current conditions. In addition, the inspector should verify that measures and controls described in the SWPPP are being implemented as described in the SWPPP. These measures and controls will include items such as:

- Good housekeeping or upkeep of industrial areas exposed to stormwater.
- Preventive maintenance of stormwater controls and other facility equipment.
- Spill prevention and response procedures to minimize the potential for and the impact of spills.
- Inspections of areas where industrial materials or activities are exposed to stormwater, including evaluation of existing control measures.
- Employee training on pollution prevention measures and controls and recordkeeping (described in detail below).
- Stabilization measures or structural controls to limit soil erosion.
- Traditional stormwater management measures (e.g., oil/water separators, vegetative swales, detention ponds) where they are appropriate for the site.

The inspector should ensure that, if corrective action is needed, the permittee immediately takes all reasonable steps necessary to minimize or prevent the discharge of pollutants until a permanent solution is installed and made operational, including cleaning up any contaminated surfaces so that the material will not discharge in subsequent storm events. Any corrective actions taken should be recorded and the documentation kept on-site with the SWPPP. Additionally, the inspector should verify that the permittee modifies the SWPPP as necessary, when a corrective action results in a change in the control measures implemented on-site.

The inspector should evaluate any SWPPP implementation schedules developed by the facility (e.g., dates for putting improved housekeeping measures into practice). The inspector should also determine whether appropriate individuals are assigned to implement the SWPPP and whether these individuals are aware of the implications of that designation. If the SWPPP calls for installation of structural controls, the inspector should verify that the controls are in place and in good working order, or that the facility is meeting its scheduled for installing control features. The inspector should ensure that facility management approves of the implementation schedule and strategy, and is aware of the SWPPP process. The inspector should document stormwater discharges observed during the inspection, taking photographs as necessary to record the observation. The inspector may use the NPDES Industrial Stormwater Investigation and Case Development Worksheet (Industrial), included in Appendix R, to record observations. The NPDES Industrial Stormwater Worksheet contains the components of the industrial stormwater program that should be evaluated during the inspection. The inspection

may use the Industrial Source Control BMP Questions sheet, located in Appendix S, as a resource for recording observations on the condition of on-site stormwater control measures.

In general, SWPPP implementation includes employee training on how to carry out the provisions of the SWPPP and how to implement control measures. In addition, employee training on the components and goals of the SWPPP must, if required by the permit, be performed at all levels of responsibility. The inspector should verify that there are training programs and that the training focuses on spill prevention and response, good housekeeping practices, materials management, and how to perform inspections. Site-specific control measures for industrial activities are summarized in Table 11-6.

MONITORING (INCLUDING SELF-INSPECTIONS)

Self-Inspections

Routine Facility Inspections

The SWPPP must, if required by the permit, have procedures for routine site inspections to be performed at least quarterly at the facility. These consist of examination of stormwater discharges and control measures, looking for indications of stormwater pollutants in the discharge and are intended to determine the need for additional maintenance, good housekeeping, or other control measures. During the quarterly site inspections, qualified personnel must examine the following:

- Industrial materials, residue, or trash that may have or could come into contact with stormwater.
- Leaks or spills from industrial equipment, drums, tanks and other containers.
- Off-site tracking of industrial or waste materials, or sediment where vehicles enter or exit the site.
- Tracking or blowing of raw, final, or waste materials from areas of no exposure to exposed areas.
- Control measures needing replacement, maintenance, or repair.

Quarterly Visual Assessment of Stormwater Discharges

In addition to routine inspections, the permittee must collect a stormwater sample from each outfall and conduct a visual assessment of each of the samples, looking for indications of stormwater pollutants in the outfall discharge. These samples must be collected in such a manner that the samples are representative of the stormwater discharge. During the quarterly visual assessment, qualified personnel must inspect the samples for:

- Color
- Odor
- Clarity (diminished)
- Floating solids
- Settled solids
- Suspended solids

- Foam
- Oil sheen
- Other obvious indicators of stormwater pollution

Both routine facility inspections and quarterly monitoring inspections must be documented and the documentation must be maintained on-site with the SWPPP.

Monitoring Requirements

There are several distinct categories of monitoring requirements and numeric effluent limitations that the facility may be subject to under the 2015 EPA MSGP: 1) quarterly benchmark monitoring, 2) annual effluent limitations guidelines monitoring, 3) state- or tribal-specific monitoring, 4) impaired waters monitoring, and 5) other monitoring required by the permit authority. The monitoring requirements, benchmark concentrations and numeric effluent limitations applicable to the facility depend on several factors, including 1) the type(s) of industrial activities generating stormwater runoff from the facility (i.e., the subsector); 2) the impairment status of the receiving waterbodies; and 3) the state, tribe, or territory where the facility is located. Depending on the facility's sector (identified in MSGP Section 1.1.2), different monitoring requirements and numeric limitations apply. The 2015 EPA MSGP includes specific benchmark monitoring requirements for certain classes of industrial sites based on the pollutants they potentially discharge. State NPDES permitting authorities may, if authorized by state law, include more stringent monitoring conditions (CWA section 510 preserves such authority). Therefore, the inspector should review the facility's permit to identify such requirements.

For specific monitoring requirements, the inspector should review EPA's most current MSGP (where applicable), the state NPDES permit, or the facility-specific individual permit. The permit will contain specific conditions as to the sample type, location, frequency, as well as the specific parameters that must be analyzed. If it is necessary for the inspector to collect samples, the inspector should refer to Chapter 5 of this manual and to EPA's *Industrial Stormwater Monitoring and Sampling Guide* (EPA, 2009) for specific details on sampling and analyses.

Table 11-3. SIC Codes Regulated for Stormwater Discharges	
SIC	Description
MINING	
10	Metal Mining
12	Coal Mining
13	Oil and Gas Extraction
14	Mining and Quarrying or Nonmetallic Minerals, Except Fuels
MANUFACTURING	
20	Food and Kindred Products
21	Tobacco Products
22	Textile Mill Products
23	Apparel and Other Finished Products Made from Fabrics and Similar Materials

Table 11-3. SIC Codes Regulated for Stormwater Discharges

SIC	Description
24	Lumber and Wood Products, Except Furniture
2434	Wood Kitchen Cabinets
25	Furniture and Fixtures
26	Paper and Allied Products
265	Paperboard Containers and Boxes
267	Converted Paper and Paperboard Products, Except Containers and Boxes
27	Printing, Publishing, and Allied Industries
28	Chemicals and Allied Products
283	Drugs
285	Paints, Varnishes, Lacquers, Enamels, and Allied Products
29	Petroleum Refining and Related Industries
30	Rubber and Miscellaneous Plastic Products
31	Leather and Leather Products
311	Leather Tanning and Finishing
32	Stone, Clay, Glass, and Concrete Products
323	Glass Products, Made of Purchased Glass
33	Primary Metals Industry
34	Fabricated Metal Products, Except Machinery and Transportation Equipment
3441	Fabricated Structural Metal
35	Industrial and Commercial Machinery and Computer Equipment
36	Electronic and Other Electrical Equipment and Components, Except Computer Equipment
37	Transportation Equipment
373	Ship and Boat Building and Repairing
38	Measuring, Analyzing, and Controlling Instruments; Photographic, Medical and Optical Goods; Watches and Clocks
39	Miscellaneous Manufacturing Industries
TRANSPORTATION, COMMUNICATIONS, ETC.	
40	Railroad Transportation
41	Local and Suburban Transit and Interurban Highway Passenger Transportation
42	Motor Freight Transportation and Warehousing
4221	Farm Product Warehousing and Storage
4222	Refrigerated Warehousing and Storage
4225	General Warehousing and Storage
43	United States Postal Service
44	Water Transportation
45	Transportation by Air
WHOLESALE TRADE	
50	Wholesale Trade—Durable Goods
5015	Motor Vehicle Parts, Used
5093	Scrap and Waste Material
51	Wholesale Trade—Nondurable Goods
5171	Petroleum Bulk Stations and Terminals

Table 11-4. Industrial Categories Associated with Industrial Activity

The 11 categories engaging in industrial activity are described below. Descriptions of SIC codes applicable to the stormwater regulations are provided in Table 11-4.

- (i) Facilities subject to stormwater effluent limitations guidelines, new source performance standards, or toxic pollutant effluent standards under 40 CFR chapter I, subchapter N (except facilities with toxic pollutant effluent standards that are exempted under category (xi) below.
- (ii) Facilities classified as SIC 24 (except 2434), 26 (except 265 and 267), 28 (except 283), 29, 311, 32 (except 323), 33, 3441, and 373.
- (iii) Facilities classified as SIC 10 through 14 (mineral industry) including active or inactive mining operations (except for areas of coal mining operations no longer meeting the definition of a reclamation area under 40 CFR 434.11(l) because the performance bond issued to the facility by the appropriate SMCRA authority has been released, or except for areas of non-coal mining operations that have been released from applicable state or federal reclamation requirements after December 17, 1990) and oil and gas exploration, production, processing, or treatment operations, or transmission facilities that discharge stormwater contaminated by contact with or that has come into contact with, any overburden, raw material, intermediate products, finished products, byproducts or waste products located on the site of such operations; (inactive mining operations are mining sites that are not being actively mined, but which have an identifiable owner/operator; inactive mining sites do not include sites where mining claims are being maintained prior to disturbances associated with the extraction, beneficiation, or processing of mined materials, nor sites where minimal activities are undertaken for the sole purpose of maintaining a mineral claim).
- (iv) Hazardous waste treatment, storage, or disposal facilities, including those that are operating under interim status or a permit under subtitle C of RCRA.
- (v) Landfills, land application sites, and open dumps that receive or have received any industrial wastes (waste that is received from any of the facilities described under this subsection) including those that are subject to regulation under subtitle D of RCRA.
- (vi) Facilities involved in the recycling of materials, including metal scrap yards, battery reclaimers, salvage yards, and automobile junkyards, including but not limited to those classified as SIC 5015 and 5093.
- (vii) Steam electric power generating facilities, including coal handling sites.
- (viii) Transportation facilities classified as SIC 40, 41, 42 (except 4221-25), 43, 44, 45, and 5171 that have vehicle maintenance shops, equipment cleaning operations, or airport deicing operations. Only those portions of the facility that are either involved in vehicle maintenance (including vehicle rehabilitation, mechanical repairs, painting, fueling, and lubrication), equipment cleaning operations, airport deicing operations, or that are otherwise identified under paragraphs (i)–(vii) or (ix)–(xi) of this section are associated with industrial activity.
- (ix) Treatment works treating domestic sewage or any other sewage sludge or wastewater treatment device or system, used in the storage, treatment, recycling, and reclamation of municipal or domestic sewage, including land dedicated to the disposal of sewage sludge that are located within the confines of the facility, with a design flow of 1.0 million gallons a day (MGD) or more, or required to have an approved pretreatment program under 40 CFR Part 403.

Table 11-4. Industrial Categories Associated with Industrial Activity

- Not included are farm lands, domestic gardens or lands used for sludge management where sludge is beneficially reused and that are not physically located in the confines of the facility, or areas that are in compliance with section 405 of the CWA.
- (x) Construction activity including clearing, grading and excavation activities except: operations that result in the disturbance of less than five acres of total land area that are not part of a larger common plan of development or sale. Note—this category of industrial activity is typically covered under a construction stormwater general permit, and not an industrial stormwater general permit.
 - (xi) Facilities under SIC 20, 21, 22, 23, 2434, 25, 265, 267, 27, 283, 285, 30, 31 (except 311), 323, 34 (except 3441), 35, 36, 37 (except 373), 38, 39, 4221–4225, (and which are not otherwise included within categories (i)–(x)).

Table 11-5. Examples of Site-Specific Industrial Stormwater Control Measures

Flow Diversion Practices: Flow diversion channels stormwater away from industrial activities to prevent stormwater contact with industrial pollutants. Additionally, flow diversion may be used to channel polluted stormwater directly to a treatment facility.

Flow diversion practices include stormwater conveyances (e.g., channels, gutters, drains, and sewers), diversion dikes, and graded areas and pavement.

Exposure Minimization Practices: Exposure minimization eliminates or minimizes the contact of stormwater with industrial activities and its pollutants. If contact of stormwater with pollutants can be minimized, the costs of collecting and treating and stormwater and the environmental releases that occur will be reduced.

Exposure minimization practices include containment diking, curbing, drip pans, collection basins, sumps, covering, vehicle positioning, and loading and unloading by air pressure or vacuum.

Mitigative Practices: Mitigation cleans up or recovers a substance (i.e., potential pollutant) before it contacts stormwater. Mitigation is a second step after pollution prevention.

Mitigative practices include sweeping, shoveling, excavation practices, vacuum and pump systems, sorbents, and gelling agents.

Other Preventative Practices: Other preventative practices can be taken to limit/prevent the exposure of stormwater to industrial activities. These practices may be either structural or procedural measures taken to reduce/eliminate exposure.

Other preventative practices include preventative monitoring practices, dust control (land disturbances and demolition areas), dust control (industrial activities), signs and labels, security, area control procedures, and vehicle washing.

Sediment and Erosion Prevention Practices: Sediment and erosion prevention can be accomplished using seven general practices: vegetate the site, minimize soil exposure to stormwater, keep runoff

Table 11-5. Examples of Site-Specific Industrial Stormwater Control Measures

from disturbed areas, stabilize disturbed soils, slow down runoff, provide drainage ways for runoff, and remove sediment from the runoff before it leaves the site.

Sediment and erosion prevention practices include vegetative practices, structural erosion prevention, and sediment control practices.

Infiltration Practices: Infiltration practices are measures that increase the infiltration of stormwater runoff into the ground using very porous soils. Infiltration practices may also reduce the velocity of stormwater, thereby minimizing erosion potential of the runoff.

Infiltration practices include vegetated filter strips, grassed swales, level spreaders, infiltration trenches, and porous pavements/concrete grids and modular pavements.

For more examples of industrial stormwater control measures, visit <https://www.epa.gov/npdes/stormwater-discharges-industrial-activities#overview>

C. STORMWATER DISCHARGES ASSOCIATED WITH CONSTRUCTION ACTIVITY

APPLICABILITY (WHO IS COVERED)

Stormwater discharged from construction sites is a significant contributor of sediment to our surface waters. Sediment-laden construction stormwater discharges can result in aquatic habitat destruction and detrimental changes to hydrologic patterns, including increased stream flows and flooding. Total suspended solids (TSS) concentrations from uncontrolled construction site discharges can be more than 150 times greater than the concentration of TSS from stormwater discharges on undeveloped land.

Large Construction Activity

As mentioned earlier, the Phase I Rule identifies eleven categories of industrial activity in the definition of “stormwater discharge associated with industrial activity” that must obtain a NPDES stormwater discharge permit (see Section 11.B). Category (x) of this definition includes construction activity (including clearing, grading, and excavation) that results in a total land disturbance of 5 acres or greater. Disturbances of less than 5 acres are also regulated under category (x) if they are part of a “larger common plan of development of sale” with a planned disturbance of 5 acres or greater. Phase I construction activity is commonly referred to as “large” construction activity. The Phase I rule requires all operators of large construction activity to obtain a NPDES stormwater discharge permit before discharging stormwater runoff to a municipal separate storm sewer system or waters of the United States.

Construction activities can include road building, construction of residential houses, office buildings, industrial sites, or demolition.

Land disturbance can include exposed soil due to clearing, grading, or excavation activities.

Larger common plan of development or sale describes a situation in which multiple construction activities occur in a contiguous area.

An operator is a person that has either operational control of construction project plans and specifications, or day-to-day operational control of activities necessary to ensure compliance with stormwater permit conditions.

Small Construction Activity

Under Phase II stormwater regulations, stormwater discharges from construction site activities that result in a land disturbance equal to or greater than 1 acre and less than 5 acres are regulated as “stormwater discharges associated with small construction activity” (see 40 CFR 122.26(b)(15)). Construction activities disturbing less than 1 acre are also included in Phase II of the NPDES stormwater program if they are part of a larger common plan of development or sale with a planned disturbance of equal to or greater than 1 acre and less than 5 acres, or if they are designated by the NPDES permitting authority.

Small Construction Waivers

Small construction activity does not require permit coverage when the construction operator can certify one of two waivers (see 40 CFR 122.26(b)(15)(i)(A) and (B)). Under the Phase II Rule, NPDES permitting authorities have the option to provide a waiver from Phase II coverage and requirements when the operator certifies to one of two conditions:

1. Low predicted rainfall potential (i.e., activity occurs during a negligible rainfall period), where the rainfall erosivity factor (“R” in the Revised Universal Soil Loss Equation (RUSLE) would be less than 5 during the period of construction activities).
2. A determination that stormwater controls are not necessary based on either:
 - a. A “total maximum daily load” (TMDL) that address the pollutant(s) of concern⁸ for construction activities.
 - b. An equivalent analysis for non-impaired waters that determines allocations are not needed to protect water quality based on consideration of in-stream concentrations, expected growth in pollutant concentrations from all sources, and a margin of safety.

To qualify for the Rainfall Erosivity Factor Waiver, the construction site operator must determine the value of the rainfall erosivity factor (R factor) in the RUSLE and then certify to the permitting authority that the factor is less than 5 during the period of construction. A construction site operator will need site-specific data to calculate the values for rainfall erosivity using RUSLE. Calculations may also be made online by going to the Low Erosivity

⁸ Pollutants of concern include sediment, parameters that address sediment (such as total suspended solids, turbidity, or siltation) and any other pollutant identified as a cause of impairment for a receiving waterbody.

Waiver (LEW) Calculator found at <https://www.epa.gov/npdes/rainfall-erosivity-factor-calculator-small-construction-sites>.

To qualify for the Water Quality Waiver, the operator of the construction site would need to certify that the facility's construction activity will take place, and the stormwater discharges will occur, within the area covered by the TMDLs or equivalent analysis. A certification form is provided by EPA or the NPDES permitting authority.

An inspector should verify that the construction project qualifies for a waiver. Small construction activities disturbing less than 1 acre previously designated by the permitting authority to need NPDES coverage are not eligible for these waivers.

PERMIT APPLICATIONS FOR STORMWATER DISCHARGES ASSOCIATED WITH CONSTRUCTION ACTIVITY

Operators of both small and large construction activities (with limited exceptions discussed above) must obtain coverage under a NPDES construction stormwater permit. Where EPA is the NPDES permitting authority, the EPA Construction General Permit (CGP), issued on February 16, 2017, was, at publication, the only general permit option available. The EPA CGP can be used for discharges from construction sites that will disturb one acre or more where EPA is the permitting authority. The permit and associated resources are located at <http://www.epa.gov/npdes/stormwater-discharges-construction-activities#overview>. In areas where a state is the NPDES permitting authority, construction site operators must obtain coverage under a state-issued permit. NPDES-authorized states typically issue their own CGPs. However, if an EPA or state-issued CGP is either not available or not applicable to a particular construction site, operators must apply for an individual permit. For a list of state construction general permits see <http://www.envcap.org/statetools/swrl/swrl.html> or <https://ofmpub.epa.gov/apex/aps/f?p=GPWI:HOME>.

General Permit/Notice of Intent

Much like the industrial facilities that apply for general permits, operators of construction sites that apply for permit coverage under an EPA or state-issued CGP must complete, certify, and submit to the appropriate NPDES permitting authority an NOI form or other applicable application form. The NOI requests a variety of information, including, for the EPA NOI form, information related to the Endangered Species Act and the National Historic Preservation Act (as described in the "NOI for Stormwater Discharges Associated with Industrial Activity" section earlier in this chapter). The key component of EPA and state-issued CGPs is the development and implementation of a construction SWPPP. For sites with multiple operators, EPA encourages but does not require these operators to develop one comprehensive SWPPP with specific requirements for each operator identified. Other requirements include conducting regular inspections and reporting releases of reportable quantities of hazardous substances. Operators may also be required to comply with local, state, or tribal construction runoff control programs as specified in the permit. To discontinue permit coverage, an operator of a construction activity must complete and submit to the appropriate NPDES permitting authority an NOT form upon satisfying the appropriate permit termination conditions described in the CGP. An example NOT form can be found in Appendix T.

NOIs must be submitted in the timeframe specified in the applicable general permit. For new projects and existing projects transferring to new operators covered under EPA's CGP, the deadline to submit an NOI is at least 14 days prior to commencement of construction. Electronic filing of NOI's (eNOI) is now available for operators where EPA is the permitting authority at <https://www.epa.gov/npdes/stormwater-discharges-construction-activities#ereporting>. The new project becomes covered under the permit 14 days after EPA acknowledges the receipt of the NOI.

EPA regulations allow permitting authorities to authorize discharges under a general permit for small construction sites without them submitting an NOI, when the permitting authority finds that NOIs would be inappropriate. While EPA does not currently implement this allowance, some states have opted to permit small construction that way (i.e., no NOI required to be covered under the state CGP). A brochure on stormwater pollution prevention for small construction sites can be found at <https://www.epa.gov/npdes/developing-stormwater-pollution-prevention-plan-swppp>

Individual Permit

In the event that an operator of a small or large construction activity chooses to apply for an individual permit, or if the NPDES permitting authority requires the operator to submit an individual NPDES permit application (based on information such as water quality data), or if any of the discharges of stormwater associated with small construction activity identified in 40 CFR 122.26(b)(15) are not authorized by the general permit, the operator is subject to the individual application requirements found at 40 CFR 122.26(c)(1)(ii).

Establishing Eligibility for Coverage under EPA's CGP

Endangered Species Act

EPA's CGP requires the construction site operator to certify their eligibility regarding the protection of threatened and endangered ("listed") species and their critical habitat. Permittees must meet the eligibility criteria that EPA developed in consultation under Section 7 of the Endangered Species Act (ESA) with the Fish and Wildlife Service (FWS) and the National Marine Fisheries Service (together, the Services). This certification is unique to EPA's NOI and is not a requirement of most NPDES-delegated states' NOIs. Permittees must follow the procedures in Appendix D of the 2017 CGP and should consult with the state or regional services offices when appropriate. Documentation supporting eligibility under this provision must be included in the facility's SWPPP.

NOIs require certification that the construction activity will not jeopardize endangered or threatened species protected under the ESA. As mentioned above, this NPDES certification requirement is unique to EPA's NOI. All dischargers applying for coverage must include in the application information on the NOI form: 1) whether listed species are in proximity to the stormwater or allowable non-stormwater discharges or discharge-related activity; 2) under which option of the CGP they claim eligibility for permit coverage, and 3) certification that their stormwater and allowable non-stormwater discharges and discharge related activities are not likely to jeopardize listed species, or are otherwise eligible for coverage due to a previous authorization under the ESA. The permittee should consult with applicable state or regional U.S.

Fish and Wildlife Service and/or National Marine Fisheries Service offices to make these determinations of eligibility.

National Historic Preservation Act

The National Historic Preservation Act (NHPA) requires federal agencies to consider the effects of federal undertakings, including EPA-issued NPDES general permits. Where operators install or modify control measures that involve subsurface disturbance, the area of potential effect (APE) for the activities performed to comply with the permit, for historic preservation purposes, is limited to the location and depth of the earth disturbance associated with the installation or modification of the stormwater control measures. NHPA eligibility procedures that permittees are required to follow are included in Appendix E of the 2017 CGP. Operators need only consider the APE when doing the historic properties screening procedures to determine their eligibility criteria in Appendix E. An electronic listing of the “National Register of Historic Places,” as maintained by the National Park Service, can be accessed at <http://www.nps.gov>.

Safe Drinking Water Act Underground Injection Control (UIC) Requirements for Certain Subsurface Stormwater Controls

The Safe Drinking Water Act (SDWA) requires that certain provisions be followed for the use of underground injection wells as a form of subsurface stormwater control. Such controls would generally be considered Class V UIC wells: Infiltration trenches (if stormwater is directed to any bored, drilled, driven shaft or dug hole that is deeper than its widest surface dimension, or has a subsurface fluid distribution system); Commercially manufactured pre-cast or pre-built proprietary subsurface detention vaults, chambers, or other devices designed to capture and infiltrate stormwater flow; and Drywells, seepage pits, or improved sinkholes (if stormwater is directed to any bored, drilled, driven shaft or dug hole that is deeper than its widest surface dimension, or has a subsurface fluid distribution system). The SWPPP must document any contact with the applicable state agency or EPA Regional Office responsible for implementing the requirements for underground injection wells in the Safe Drinking Water Act and EPA’s implementing regulations at 40 CFR Parts 144–147.

STORMWATER POLLUTION PREVENTION PLAN REQUIREMENTS

The SWPPP as required by the EPA or state-issued CGP must be prepared prior to submission of the NOI. The construction project should follow the provisions of the SWPPP throughout the construction period, as the SWPPP represents what the operator plans to do to meet the effluent limits in the permit. Under EPA’s 2017 CGP, the SWPPP must be signed by a responsible official such as the president, vice president, or general partner. The construction facility must keep the SWPPP on-site throughout the entire construction period or at an easily accessible location so that it can be made available at the time of an on-site inspection or upon request by EPA. The SWPPP must be submitted for review under EPA’s CGP only when requested by EPA, although some permitting authorities may require submission of the SWPPP along with the NOI.

For large or complex construction sites the inspector may want to request a copy of the SWPPP prior to inspection to ensure familiarity with the site during the inspection. Otherwise, the

inspector should obtain a copy of and review the SWPPP or at least parts of the SWPPP during the inspection. At a minimum, the inspector should review the site map prior to conducting the field inspection to understand the site and the existing/planned stormwater controls.

Depending on the time available for the inspection and the size of the SWPPP, the inspector may complete the remaining portion of the SWPPP review when he or she returns to the office.

In reviewing the SWPPP, the inspector should evaluate if it contains all the required elements specified in the permit (either the most current EPA CGP, the state CGP in NPDES-authorized states, or an individual permit issued for the site). The EPA CGP requires that the SWPPP identify potential sources of pollution that may reasonably be expected to affect the quality of stormwater discharges, and describe and ensure implementation of practices that the operator will use to reduce pollutants in its stormwater discharges. Reviewing the SWPPP implementation is covered in the next section. The following items, which are included in the EPA 2017 CGP, are typically required in all SWPPPs, although the inspector should always refer to the specific permit applicable to a particular construction site:

- **Identification of the stormwater team.**
- **A description of the nature of the construction activity.**
- **Emergency-related projects.**
- **Identification of other site operators.**
- **A sequence (schedule) of major construction activity.**
- **A site map** indicating construction area boundaries, locations of all surface waters, natural buffers, federally-listed critical habitat for endangered or threatened species, topography of site, existing vegetative cover, storm drain inlets, drainage patterns, discharge locations, potential pollutant-generating activities, stormwater control measures, and chemical use and storage areas.
- **Construction site pollutants.**
- **Non-stormwater discharges.**
- **Buffer documentation.**
- **Description of stormwater control measures** including the measures to be used, use of treatment chemicals, and stabilization practices.
- **Pollution prevention procedures** including spill prevention and response and waste management.
- **Procedures for inspection, maintenance, and corrective action.**
- **Staff training.**
- **Documentation of compliance with other federal requirements.**
- **SWPPP certification.**
- **Post-authorization additions to the SWPPP** including copies of the NOI, acknowledgement letter, and the permit.

Typically, measures and controls should include the following:

- **Install erosion and sediment controls**—The permittee is required to complete installation of stormwater controls by the time each phase of earth-disturbance has begun, unless infeasible, and to install these controls according to good engineering practices. The permittee must also ensure that all erosion and sediment controls remain in effective operating condition during permit coverage and are protected from activities that would reduce their effectiveness.
- **Provide natural buffers or equivalent sediment controls**—The permittee is required to ensure that any discharges to surface waters through the area between the disturbed portions of the property and any surface waters located within 50 feet of the construction site are treated by an area of undisturbed natural buffer and/or additional erosion and sediment controls to achieve a reduction in sediment load equivalent to that achieved by a 50-foot natural buffer. If it is infeasible for the construction site to maintain a 50-foot natural buffer between earth disturbances and surface waters, erosion and sediment controls may be used. In this case, the permittee must first determine the estimated sediment removal efficiency of a 50-foot natural buffer for the construction site. Appendix G of the CGP contains sediment removal efficiency tables, which may be used to locate the sediment removal efficiencies of various buffer vegetation. Once the removal efficiency of a 50-foot natural buffer is determined, then the permittee should select stormwater controls that will provide an equivalent sediment load reduction.
- **Install perimeter controls**—The permittee must install sediment controls along those perimeter areas of the construction site that will receive stormwater from earth-disturbing activities. Sediment must be removed before it has accumulated to one-half of the above-ground height of any perimeter control.
- **Minimize sediment track-out**—The permittee must minimize the track-out of sediment onto off-site streets, other paved areas, and sidewalks from vehicles exiting the construction site.
- **Control discharges from stockpiled sediment or soil**—For any stockpiles or land clearing debris composed, in whole or in part, of sediment or soil, the permittee is required to:
 - a) locate the piles outside of any natural buffers,
 - b) protect from contact with stormwater (including run-on) using a temporary perimeter sediment barrier,
 - c) where practicable, provide cover or appropriate temporary stabilization to avoid direct contact with precipitation or to minimize sediment discharge,
 - d) do not hose down or sweep soil or sediment accumulated on pavement or other impervious surfaces into any stormwater conveyance (unless connected to a sediment basin, sediment trap, or similarly effective control), storm drain inlet, or surface water, and,
 - e) unless infeasible, contain and securely protect from wind.
- **Minimize dust**—To avoid pollutants from being discharged into surface waters, to the extent feasible, the permittee must minimize the generation of dust through the appropriate application of water or other dust suppression techniques.
- **Minimize the disturbance of steep slopes.**

- **Preserve topsoil.**
- **Minimize soil compaction**—In areas of the construction site where final vegetative stabilization will occur or where infiltration practices will be installed, the permittee must either restrict vehicle/equipment use or use soil conditioning techniques.
- **Protect storm drain inlets**—The permittee, where applicable, must install inlet protection measures that remove sediment from the discharge prior to entry into the storm drain inlet. The permittee is required to clean, or remove and replace, the protection measures as sediment accumulates, the filter becomes clogged, and/or performance is compromised.
- **Requirements applicable only to sites using these specific stormwater controls:**
 - Constructed stormwater conveyance channels—The permittee should design stormwater conveyance channels to avoid unstabilized areas on the site and to reduce erosion, unless infeasible.
 - Sediment basins—The EPA CGP requires that when a temporary/permanent sediment basin is installed, it must provide storage for either the calculated volume of runoff from a 2-year, 24-hour storm or 3,600 cubic feet per acre drained.
 - Treatment chemicals—Water treatment chemicals, such as polymers and flocculants, may be used as a form of erosion and sediment control. However, cationic treatment chemicals may not be used under the CGP unless the EPA office authorizes coverage under this permit after appropriate controls and implementation procedures are developed. The permittee should use conventional erosion and sediment controls prior to and after the application of treatment chemicals. Chemicals may only be applied where treated stormwater is directed to a sediment control (e.g., sediment basin, perimeter control) prior to discharge. Chemicals must be selected that are appropriately suited to the types of soils likely to be exposed during construction and discharged to locations where chemicals will be applied, and to the expected turbidity, pH, and flow rate of stormwater flowing into the chemical treatment system or area. Treatment chemicals and chemical treatment systems should be used in accordance with dosing specifications and sediment removal design specifications provided by the provider/supplier of the applicable chemicals, or document specific departures from these practices or specifications and how they reflect good engineering practice.
 - Dewatering practices—The permittee is prohibited from discharging ground water or accumulated stormwater that is removed from excavations, trenches, foundations, vaults, or other similar points of accumulation, unless such waters are first effectively managed by appropriate controls.
- **Stabilization requirements**—Practices must be included for interim and permanent stabilization for the site, including a schedule of when the practices will be implemented. According to the EPA CGP, when construction activities temporarily or

permanently cease on a portion of the site, stabilization measures must be initiated immediately for erosion control.

- **Pollution prevention requirements**—The permittee is required to design, install, and maintain effective pollution prevention measures to prevent the discharge of pollutants. All pollution prevention controls installed must remain in effective operating condition and be protected from activities that would reduce their effectiveness. Certain discharges are prohibited, these include: wastewater from concrete washout, fuels, oils, soaps, solvents, detergents, and toxic or hazardous substances. The following activities require compliance with pollution prevention standards in accordance with CGP Part 2.3: fueling and maintenance of equipment or vehicles; washing of equipment and vehicles; storage, handling, and disposal of construction materials, products, and wastes; and, washing of applicators and containers used for paint, concrete, or other materials.
- **Emergency spill notification**—Where a leak, spill, or other release containing a hazardous substance or oil in an amount equal to or more than a reportable quantity established under either 40 CFR Part 110, 40 CFR Part 117, or 40 CFR Part 302 occurs during a 24-hour period, the permittee must notify the National Response Center (NRC).
- **Fertilizer discharge restrictions**—The permittee is required to minimize discharges of fertilizers containing nitrogen or phosphorus.

The Construction and Development Effluent Guidelines require that sediment controls be designed, installed and maintained to minimize the discharge of sediment from the site. Therefore, certain types of sediment controls such as sediment basins must be adequately sized to retain or detain the appropriate volume of stormwater runoff. The inspector should refer to the particular site's NPDES stormwater permit for specific design requirements related to capacity or volume, as well as any other design standards. For example, as noted above, EPA's 2017 CGP requires that sediment basins provide, at a minimum, storage for either the calculated volume of runoff from a 2-year, 24-hour storm or 3,600 cubic feet per acre drained. To determine whether stormwater controls at a construction site have been designed and installed with adequate capacity, the inspection should consider the following factors: the expected amount, frequency, intensity, and duration of precipitation; the nature of stormwater runoff and run-on at the site, including factors such as expected flow from impervious surfaces, slopes, and site drainage features; and, the range of soil particle sizes expected to be present on the site. These factors all affect the nature and quantity of runoff from the construction site. For instance, soils with a very small particle size (clay, silt) has a very low infiltration, meaning the site will likely experience a higher quantity runoff and a higher sediment load in the runoff compared to a site with higher infiltration (sandy soils). The inspector should consider these factors to determine if the stormwater controls implemented at a construction site are sufficient.

Appendix U, "Typical 'C' Coefficients," lists typical runoff coefficient values that may be used to determine the typical infiltration and runoff a certain area (residential, parks, streets, etc.). Additionally, the inspector may refer to Appendix V, "Rain Zones of the United States," to

determine the typical amount of rainfall a region receives, as an aid in evaluating stormwater control measure adequacy. Alternatively, the inspector may refer to EPA's National Stormwater Calculator (SWC), a desktop application, to estimate the annual amount of rainwater and frequency of runoff from a specific site anywhere in the United States. Estimates are based on local soil conditions, land cover, and historic rainfall records. The stormwater calculator may be found at <https://www.epa.gov/water-research/national-stormwater-calculator>.

The SWPPP must also specify the operator personnel who is responsible for inspecting the construction site and the frequency of the inspections. The EPA 2017 CGP requires that the operator inspect at least once every seven days regardless of rainfall, or at least every 14 days and within 24 hours of each rainfall of 0.25 inches or more. To determine if a storm event of 0.25 inches or greater has occurred at the construction site, the permittee must either keep a properly maintained rain gauge on-site, or obtain the storm event information from a weather station that is representative of the construction site location. The EPA inspector should determine how the permittee monitors and records rainfall and if this method is representative of the rainfall at the site and credible. One potential source of rainfall data that the EPA inspector can access in preparation for an inspection is provided by the National Oceanic and Atmospheric Administration (NOAA) and can be found through the National Climate Data Center's (NCDC's) online climate datasets. NCDC online climate datasets may be found at <https://www.ncdc.noaa.gov/cdo-web/>. The inspector should use appropriate rainfall data, either the data maintained by the permittee or provided by another acceptable source, to ensure that the permittee is in compliance with the required schedule for site inspections. Additionally, if rainfall occurred during or prior to an inspection, these datasets can be used to verify the amount of precipitation that has fallen. The NOAA rainfall worksheet, available in Appendix W, may be used to document rainfall.

Some permits may allow reduced monitoring frequencies for portions of sites that have achieved final stabilization (as defined by the applicable permit), or for sites that are in arid (defined as less than 10 inches of rain per year in the EPA 2017 CGP) or semi-arid (defined as 10 to 20 inches of rain per year in the EPA 2017 CGP) areas. EPA's 2017 CGP requires that these areas be inspected at least once a month. The inspector must prepare a report documenting his/her findings on the conditions of the controls and stabilized areas. The inspector should verify that documentation of the routine inspections is included in the SWPPP.

Some permits require an increase in inspection frequency for sites that discharge to a sediment of nutrient-impaired water or to a water that is identified by the state, tribe, or EPA as Tier 2, Tier 2.5, or Tier 3 for antidegradation purposes (see EPA 2017 CGP Part 4.3). For these sites, inspections should occur once every 7 calendar days and within 24 hours of a storm event of 0.25 inches or greater. Again, the inspector should verify that documentation of the routine inspections is included in the SWPPP.

The worksheet provided in Appendix X, "NPDES Industrial Storm Water Investigation and Case Development (Construction)," can be used to evaluate specific elements of the Stormwater Pollution Prevention Plan for construction activities.

SWPPP IMPLEMENTATION/IN THE FIELD

Are They Doing What the SWPPP Indicates?

When conducting the field inspection of a construction site, inspectors should note several items:

- A current copy of the SWPPP must be kept at the site or at an easily accessible location so that it can be made available at the time of an on-site inspection, or upon request by EPA. Significant delays in producing the SWPPP or finding knowledgeable stormwater personnel may indicate compliance problems.
- The opening conference with the owner/operator is extremely important. Often at larger residential construction sites, there will be multiple builders working together as co-permittees, each responsible for one or more aspects of SWPPP implementation. It is important to identify the permittee and/or co-permittees and their respective responsibilities under the permit.
- It is good practice to review the site map before conducting the inspection because if the inspector does not know the site boundaries, it is difficult to identify and evaluate the runoff potential. The inspector can download aerial photos prior to the inspection to use along with the site map.
- The SWPPP should reflect current conditions and provide a record of past conditions. The inspector should review the construction sequence and BMP sequence given in the SWPPP and evaluate whether these have been met.
- The closing conference provides an opportunity to describe deficiencies found and identify areas of concern (e.g., parts of a SWPPP missing, inspections not being done, silt fence not installed or not installed correctly, discharge of sediment or other pollutants to a storm drain). Given the transient nature of most construction sites, it is good practice to share information with the site owner/operator as quickly as possible (e.g., prior to issuance of final inspection report) so that any environmental harm can be minimized and corrections can be made prior to the next storm event.

In the field, the inspector should: verify that the SWPPP reflects current site conditions including identification of potential pollutant sources and control measures; verify whether structural control measures are properly installed, adequately maintained and in effective operating condition; verify whether nonstructural control measures such as stabilization and good housekeeping are being implemented as required by the SWPPP, are timely and are adequate and appropriate; document all discharges of stormwater observed by the inspector as well as evidence of previous discharges such as accumulation of sediment (whether off-site or in waters, or on-site in gutters, on the street, within storm drains, etc.); and document any evidence of the discharge of other pollutants such as concrete washout or paint.

The inspector should ensure that, if corrective action is needed, the permittee immediately takes all reasonable steps necessary to minimize or prevent the discharge of pollutants until a permanent solution is installed and made operational, including cleaning up any contaminated surfaces so that the material will not discharge in subsequent storm events. Any corrective

actions taken should be recorded and the documentation kept on-site with the SWPPP. Additionally, the inspector should verify that the permittee modifies the SWPPP as necessary, when a corrective action results in a change in the control measures implemented on-site.

EPA's 2017 CGP requires facilities to implement control measures and train employees on how to carry out the provisions of the SWPPP. The inspector should evaluate any implementation schedules developed by the facility for carrying out the SWPPP (e.g., dates for putting improved housekeeping measures into practice; installation of structural controls). The inspector should also determine whether appropriate individuals have been assigned to implement the specific aspects of the SWPPP, and whether these individuals are aware of the implications of that designation. At a minimum, the appropriate personnel must be trained to understand: the location of all stormwater controls on the site, how they are maintained; the proper procedures to follow with respect to the permit's pollution prevention requirements; and, when and how to conduct inspections, record applicable findings, and take corrective actions.

Examples of deficiencies an inspector may observe during a construction site inspection include:

- Silt fences that are improperly located or installed (e.g., bottom not buried), falling over, containing an excessive amount of accumulated sediment (e.g., EPA's 2012 requires that sediment be removed before it has accumulated to over one-half of the above-ground height of the perimeter control), or ripped so that the fence is not functioning properly.
- Poor housekeeping such as oil stains on soil; overturned drums; uncovered pails containing liquids; cluttered equipment storage with leaking fluids; fuel tanks with no containment; litter and debris scattered around the site; streets in need of sweeping.
- Storm drain inlet protection that is missing or ineffective such as inlets covered with sediment/debris; ruptured gravel bags with loss of gravel into drain; sediment accumulation resulting in clogging of the filter or otherwise compromising performance; improperly installed inlet protection that leaves gaps.
- Track-out controls that are missing or ineffective such as track-out pads filled with soil or not constructed to the length specified in the SWPPP; dirt being tracked out onto the road.
- Sediment not removed from sediment basins or sediment traps before accumulating to more than ½ the design capacity.
- Lack of proper recordkeeping.

Appendix Y, "Construction Source Control BMP Questions," contains a worksheet that the inspector can use to aid in the evaluation of stormwater control measures. Site-specific control measures for construction activities are summarized in Table 11-6.

Table 11-6. Site-Specific Construction Stormwater Control Measures

Stabilization Practices: Stabilization, which entails protecting bare earth, reduces erosion potential in four ways: 1) by shielding the soil surface from direct erosive impact of raindrops, 2) by improving the soil's water storage porosity and capacity, 3) by slowing the runoff and allowing the sediment to drop out or deposit; and 4) by physically holding the soil in place with plant roots. Vegetative (e.g., grasses, trees, or shrubs) covers are the most common type of stabilization.

Stabilization practices include temporary seeding, mulching, geotextiles, chemical stabilization, permanent seeding and planting, buffer zones, preservation of natural vegetation, sod stabilization, stream bank stabilization, soil retaining measures, and dust control.

Structural Erosion and Sediment Control Practices: Structural erosion and sediment controls divert stormwater flows away from exposed areas, convey runoff to a sediment basin or similarly effective control, capture sediment or otherwise prevent sediments from moving off-site, and reduce the erosive forces of runoff waters.

Structural erosion and sediment control practices include, but are not limited to, earth dikes, drainage swales, interceptor dikes and swales, temporary stream crossing, temporary storm drain diversion, pipe slope drains, subsurface drains, silt fence, gravel or stone filter berm, storm drain inlet protection, sediment trap, temporary and permanent sediment basins, outlet protection, check dams, surface roughening, and gradient terraces.

D. STORMWATER DISCHARGES FROM MUNICIPAL SEPARATE STORM SEWER SYSTEMS

APPLICABILITY (WHO IS COVERED)

Stormwater discharges from municipal separate storm sewer systems (MS4s) were initially regulated under the Phase I stormwater regulations, which were finalized in 1990. There is a two-part stormwater permit application process for medium (serving a population of 100,000 or more, but fewer than 250,000) and large (serving a population of more than 250,000) MS4s described in 40 CFR 122.26(d), pursuant to sections 402(p)(2)(C)–(D) of the CWA. The regulations define medium and large MS4s as those in the 220 cities listed in Appendix F and Appendix G or in the counties listed in Appendix H and Appendix I of 40 CFR Part 122. An MS4 may also be designated as a Phase I MS4 on a case-by-case basis (see 40 CFR 122.26(b)(4)(iii) and 122.26(b)(7)(iii)). In addition to the counties and cities listed in Appendices F – I, other smaller interrelated entities may be regulated under the Phase 1 program such as smaller municipalities, sewer districts or flood control districts that are physically connected to a Phase I MS4. In some states, only the urbanized portions of the state highway systems are regulated, but other states have issued state-wide permits to their Departments of Transportation (DOTs). To date, a total of approximately 1,000 entities (cities, counties, flood control districts etc.) are covered under 270 Phase I permits nationwide. The universe of Phase I MS4s was established under the 1990 Phase I stormwater regulations. Additional MS4 entities cannot be added to the Phase 1 universe but may be regulated under the Phase II regulations discussed below.

The Phase II Final Rule, which was finalized in 1999, requires NPDES permit coverage for stormwater discharges from certain small MS4s. Only a select subset of small MS4s, referred to as “regulated small MS4s,” require a NPDES stormwater permit. Small MS4s are defined as any MS4 that is not a medium or large MS4 covered by Phase I of the NPDES Stormwater Program. Regulated small MS4s are small MS4s located in “urbanized areas” (UAs) as defined by the Bureau of the Census and as determined by the latest Decennial Census, and those small MS4s located outside of a UA that are designated by NPDES permitting authorities. Small MS4s include publicly owned or operated separate storm sewer systems that are similar to such systems within municipalities, such as military bases, large hospital or prison complexes, and highways (40 CFR 122.26(b)(16)(iii)). A small MS4 can be designated by the permitting authority as a regulated small MS4 in one of two ways. One, the small MS4 located outside of a UA is designated as a regulated small MS4 by the NPDES permitting authority because its discharges cause, or have the potential to cause, an adverse impact on water quality. Two, the small MS4 located outside of a UA contributes substantially to the pollutant loadings of a physically interconnected MS4 regulated by the NPDES stormwater program. Note: In authorized states, the NPDES permitting authority was required to designate small MS4s meeting the designation criteria by December 9, 2002, or by December 8, 2004, if a watershed plan is in place (40 CFR 123.35(b)).

Waivers

Permitting authorities may waive permit coverage requirements for small MS4s otherwise regulated under the rule if the MS4s meet the necessary criteria set forth in the regulations. Waiver options are available to operators of small MS4s if discharges do not cause, or have the potential to cause water quality impairment. The state permitting authority is required to periodically review any waivers granted to MS4 operators to determine whether any information required for granting the waiver has changed. At a minimum, such a review needs to be conducted once every five years.

PERMIT APPLICATIONS FOR STORMWATER DISCHARGES FROM MUNICIPAL SEPARATE STORM SEWER SYSTEMS

Permits are required for discharges from regulated large, medium, and small municipal separate storm sewer systems. The permitting authority may also designate stormwater discharges via its residual designation authority. The permitting authority may issue one system-wide permit covering all discharges from multiple permittees within an interrelated municipal separate storm sewer system or issue individual permits to each MS4 on a jurisdictional basis.

Unlike the Phase I MS4 program that primarily utilizes individual permits, the Phase II approach allows operators of regulated small MS4s to choose from as many as three permitting options: 1) general permits (if available), 2) individual permits, or 3) modification of an existing Phase I Individual Permit (Co-Permittee Option). It must be noted that the NPDES permitting authority reserves the authority to determine which options are available to the regulated small MS4s. Where a general permit is available, operators of regulated small MS4s in urbanized areas seeking coverage under the general permit must submit their NOIs within 90 days of permit

issuance. Operators of small MS4s that have been designated by the permitting authority must submit their permit applications within 180 days of notice. Small MS4s must develop and fully implement an MS4 stormwater management program within five years of initial permit issuance.

In contrast to the Phase I MS4 program, the Phase II MS4 program has been designed specifically to accommodate a general permit approach. General permits prescribe one set of requirements for all permittees, though general permits can also include some specific requirements for specific permittees covered by the permit. General permits are drafted by the NPDES permitting authority, then published for public comment before being finalized and issued. A regulated small MS4 operator seeking coverage under a general permit must submit an NOI. The NOI fields are determined by the permitting authority, but generally ask the operator to describe its stormwater management program, including stormwater control measures and measurable goals. The MS4 owner/operator develops an individualized stormwater management program (SWMP) in accordance with the requirements of the permit that addresses the characteristics and needs of its system, subject to review by the permitting authority. Permittees also can choose to share responsibilities for meeting the Phase II program requirements, as provided in 40 CFR 122.35 and further explained below. Unless the permit specifies that another governmental entity is responsible to carry out one or more of the permit requirements, the permittee remains legally responsible for compliance with the permit.

As stated above, individual permits are mostly used for Phase I medium and large MS4s, while general permits are more common for Phase II program implementation. Individual permits prescribe a set of requirements for a permittee or a group of co-permittees. Individual permits require the submission of a permit application, while an NOI submitted for coverage under a general permit is usually less extensive. Once an application for an individual permit is received, the permit is drafted by the NPDES permitting authority, then published for public comment before being finalized and issued. The Phase II rule allows a regulated small MS4 to apply for an individual permit under either the Phase II MS4 program (see 40 CFR 122.34) or the Phase I MS4 program (see 40 CFR 122.26(d)). The NPDES permitting authority may allow more than one regulated entity to apply for one individual permit (i.e., co-permittees), as it may also do for Phase I MS4s.

Under the Phase II Rule, there are two permitting options tailored to minimize duplication of effort among co-permittees. These can be incorporated into both a general permit and an individual permit by the NPDES permitting authority. First, as mentioned above, under 40 CFR 122.35, the permitting authority can recognize in the permit that another governmental entity or the permitting authority itself is responsible under a NPDES permit for implementing any or all minimum measures. Responsibility for implementation of the measure(s) would rest with the other governmental entity, thereby relieving the permittee of its responsibility to implement that measure(s). Second, the permittee may rely on another entity to satisfy the permittee's obligations to implement one or more of the minimum control measures if the other entity agrees to implement the control measures on the permittee's behalf and in fact implements the requirement(s).

The operator of a regulated small MS4 could participate as a limited co-permittee in a neighboring Phase I MS4's stormwater management program by seeking a modification of the existing Phase I individual permit instead of seeking individual permit coverage under the Phase II rule. A list of Phase I medium and large MS4s can be obtained from the EPA Office of Wastewater Management (OWM), the EPA Region, or downloaded from the OWM web site at <http://www.epa.gov/npdes>. The MS4 must follow Phase I permit application requirements (with some exclusions).

STORMWATER MANAGEMENT PROGRAM (SWMP) DEVELOPMENT

Phase I MS4 SWMPs: Comprises Part of the Permit Application

Developing and implementing a stormwater management program (SWMP) is a key requirement of an MS4 permit. While existing structural and non-structural control measures for addressing discharges from MS4s must be described in Part 1 of the permit application, Part 2 of the application must set forth the proposed SWMP in accordance with 40 CFR 122.26(d)(2)(iv).

The discussion that follows provides a general description of SWMP requirements for MS4s. The inspector must review the MS4's permit for specific considerations. Each MS4 covered by a permit must develop a SWMP in accordance with the permit, tailored to system-specific conditions and designed to reduce the amount of pollutants in stormwater discharges from the system to the maximum extent practicable. The permitting authority has the right to review and request changes in the SWMP. Summaries of necessary components of these programs for MS4s are provided below for both large- and medium-size MS4s.

The SWMP must describe priorities for implementing controls and should be based on the following requirements:

1. Structural and source control measures to be implemented during the life of the permit to reduce pollutants from runoff from commercial and residential areas that are discharged from the MS4s. The SWMP must include an estimate of the expected reduction of pollutant loads and a proposed schedule for implementing such controls. At a minimum, the description in the SWMP must include:
 - Maintenance activities and a maintenance schedule for structural controls. The description should include priorities and procedures for inspections.
 - Planning procedures, including a comprehensive master plan, to develop, implement, and enforce controls to reduce discharges from areas of new development and significant redevelopment after construction is complete.
 - Practices for operating and maintaining public streets, roads, highways etc., and procedures for reducing the impact on receiving waters of discharges from MS4s, including pollutants discharged as a result of deicing activities.
 - Procedures to ensure that flood management projects assess the impacts on the water quality of receiving water bodies and that existing structural flood control

devices have been evaluated to determine if retrofitting is feasible for additional pollutant removal.

- Program to monitor pollutants in runoff from operating or closed municipal landfills or other treatment, storage, or disposal facilities for municipal waste, that identifies priorities and procedures for inspections and establishing and implementing control measures for such discharges.
 - Program to reduce, to the maximum extent practicable, pollutants in discharges from the application of pesticides, herbicides, and fertilizers. This may include educational activities, permits, certifications, and other measures for commercial applicators and distributors, and controls for application in public right-of-way and at municipal facilities.
2. A program to detect and remove (or to require the discharger to the MS4 to obtain a separate NPDES permit for) illicit discharges and improper disposal into the MS4, and to prevent such discharges. At a minimum, the proposed program must include descriptions of:
- Inspection procedures, to implement and enforce an ordinance, order, or similar means to prevent illicit discharges to the MS4 (note: there is a category of non-stormwater discharges or flows that shall be addressed where such discharges are identified by the owner/operator as sources of pollutants to waters of the United States (see 40 CFR 122.26(d)(2)(iv)(B)(1)).
 - Procedures to conduct ongoing field screening activities during the life of the permit.
 - Procedures to be followed to investigate where field screening or other information indicate a reasonable potential of illicit discharges or other sources of non-stormwater.⁹
 - Procedures to prevent, contain, and respond to spills that may discharge into the MS4.
 - Program to promote, publicize, and facilitate public reporting of the presence of illicit discharges or water quality impacts associated with discharges from MS4s.
 - Educational activities, public information activities, and other appropriate activities to facilitate the proper management and disposal of used oil and toxic materials.

⁹ For example, EPA has developed a draft New England Bacterial Source Tracking Protocol applicable to inspectors in Region 1. This protocol is appropriate under circumstances where the inspector suspects bacterial contamination. The protocol relies primarily on visual observations and the use of field test kits and portable instrumentation during dry and wet weather to complete a bacterial screening level investigation of stormwater outfall discharges or flows within the drainage system, in conjunction with sampling for pharmaceuticals and cosmetic to show a link with untreated illicit sewage discharges. The protocol can be found at: <https://www3.epa.gov/region1/npdes/stormwater/ma/2014AppendixI.pdf>

- Controls to limit infiltration of seepage from municipal sanitary sewers to MS4s where necessary.
3. Program to monitor and control pollutants in stormwater discharges to municipal systems from municipal landfills; hazardous waste treatment, disposal, and recovery facilities; industrial facilities that are subject to section 313 of SARA Title III; and industrial facilities that the municipal permit applicant determines are contributing a substantial pollutant loading to the MS4s. The program must include:
 - Priorities and procedures for inspections and establishing and implementing control measures for such discharges.
 - Monitoring program for stormwater discharges associated with industrial facilities identified above, to be implemented during the term of the permit, including the submission of quantitative data on constituents identified in 40 CFR 122.26(d)(2)(iv)(C)(2).
 4. Program to implement and maintain structural and non-structural best management practices to reduce pollutants in stormwater runoff from construction sites to the MS4. This program must include descriptions of:
 - Procedures for site planning that incorporate consideration of potential water quality impacts.
 - Requirements for non-structural and structural best management practices.
 - Procedures for identifying priorities for inspecting sites and enforcing control measures that consider the nature of the construction activity, the topography, and the characteristics of soils and receiving water quality.
 - Appropriate educational and training measures for construction site operators.

Phase II MS4 SWMP: Comprises Part of the Permit Application or Notice of Intent

The Phase II regulations require regulated small MS4s to develop SWMPs based on similar, but not identical, requirements as apply to medium/large MS4s. Small MS4 permits require at a minimum that the permittee develop, implement, and enforce a SWMP designed to reduce the discharge of pollutants from the MS4 to the maximum extent practicable, to protect water quality, and to satisfy the appropriate water quality requirements of the Clean Water Act. The Phase II requirements for SWMPs include the six minimum control measures described below:

1. Public education and outreach on stormwater impacts that distribute educational materials to the community or conduct equivalent outreach activities about the impacts of stormwater discharges on water bodies and the steps that the public can take to reduce pollutants in stormwater runoff.
2. Public involvement/participation on stormwater controls, at a minimum, complying with state, tribal and local public notice requirements.

3. Illicit discharge detection and elimination program that includes:
 - A storm sewer system map, showing the location of all outfalls and the names and location of all waters of the United States that receive discharges from those outfalls.
 - An ordinance or other regulatory mechanism (to the extent allowable under state law), that effectively prohibits non-stormwater discharges into the storm sewer system.
 - Appropriate enforcement procedures and actions.
 - A plan to detect and address non-stormwater discharges, including illegal dumping, to the system.
 - Outreach that informs public employees, businesses, and the general public of hazards associated with illegal discharges and improper disposal of waste.
4. Construction site stormwater runoff control program to reduce pollutants in any stormwater runoff to your small MS4 from construction activities that result in a land disturbance of greater than or equal to one acre (including construction activity disturbing less than one acre that is part of a larger common plan of development or sale that would disturb one acre or more). The program must include the development and implementation of, at a minimum:
 - An ordinance or other regulatory mechanism (to the extent allowable under state law) to require erosion and sediment controls, as well as sanctions to ensure compliance.
 - Requirements for construction site operators to implement appropriate erosion and sediment control best management practices.
 - Requirements for construction site operators to control waste such as discarded building materials, concrete truck washout, chemicals, litter, and sanitary waste at the construction site that may cause adverse impacts to water quality.
 - Procedures for site plan review that incorporate consideration of potential water quality impacts.
 - Procedures for receipt and consideration of information submitted by the public.
 - Procedures for site inspection and enforcement of control measures.
5. Post-construction stormwater management program in new development and redevelopment for projects that disturb greater than or equal to one acre, including projects less than one acre that are part of a larger common plan of development or sale, that discharge into the MS4. The controls must include strategies that include a combination of structural and/or non-structural best management practices (BMPs) appropriate for the community; use an ordinance or other regulatory mechanism to address

post-construction runoff from new development and redevelopment projects to the extent allowable under state, tribal or local law; and ensure adequate long-term operation and maintenance of control measures.

6. Pollution prevention/good housekeeping for municipal operations that includes a training component and has the ultimate goal of preventing or reducing pollutant runoff from municipal operations. Your program must include employee training to prevent and reduce stormwater pollution from activities such as park and open space maintenance, fleet and building maintenance, new construction and land disturbances, and stormwater system maintenance.

As part of the small MS4 NOI or individual permit application, the MS4 is required to identify the BMPs that will be implemented for each of the six minimum control measures listed above. In addition, the NOI or application must identify the measurable goals for each of the BMPs, including, as appropriate, the months and years in which the MS4 will take the required actions, including interim milestones, the frequency of the action, and the person or persons responsible for implementing or coordinating the SWMP.

SWMP IMPLEMENTATION/IN THE FIELD

The inspector should verify that the SWMP is being implemented as appropriate to meet the current circumstances in the municipality. Implementation of management programs requires the permittee to implement a variety of control measures, programs, and procedures that includes training of various individuals on how to carry out the goals of the program. The inspector should evaluate any implementation schedules specified in the permit or developed by the municipality for carrying out the program and determine whether appropriate individuals have been assigned to implement the specific aspects of the program and if these individuals are aware of the requirements of that designation. The inspector should evaluate the municipality's inspection and enforcement program for industrial facilities and construction sites. In addition, the inspector should verify whether the municipality's monitoring program and dry weather screening program is being implemented according to the permit schedule. If the program calls for the installation or maintenance of structural controls, the inspector should verify that the controls are in place and in good working order or that the facility is on an appropriate schedule for construction of the structural control measures. The inspector should ensure that the permittee is minimizing the discharge of pollutants in stormwater runoff. The inspector should document stormwater discharges and any dry weather discharges observed during the inspection, taking photographs as necessary to record the observation.

The inspection should consist of "in-office" and "in-field" activities. The purpose of the inspection is to evaluate the MS4's implementation of its permit and SWMP. In-office activities should include staff interviews and records review. Records review should be tailored to the MS4's permit and SWMP and can include review of annual reports, training materials, standard operating procedures for inspections and enforcement, inspection reports, and databases. Some of these records may be reviewed prior to or after the inspection. In-field activities should also be tailored to the MS4's permit and SWMP and can include visits to municipal facilities and yards, industrial facilities, municipal and private construction sites, and municipal

and private post-construction BMPs, as well as field screening. With the exception of municipal sites, the inspector should evaluate the effectiveness of the MS4 inspector, rather than leading the inspection during field activities. The inspector may refer to EPA's *MS4 Program Evaluation Guidance* (EPA, 2007) and EPA Region 3 Factsheet on *Evaluating the Effectiveness of Municipal Stormwater Programs* (EPA, 2008) for additional information on evaluating stormwater programs.

E. REFERENCES

The following is a list of resources providing additional information on stormwater.

- American Petroleum Institute (API). (1989). *Suggested Procedure for Development of Spill Prevention Control and Countermeasure Plans*. 2nd Edition. American Petroleum Institute Bulletin D16.
- American Public Works Association (APWA). (1989). *Urban Storm Water Management, Special Report No. 49*. APWA Research Foundation.
- Arapahoe County. (1988). *Erosion Control Standards*. Prepared by Kiowa Engineering Corporation.
- Commonwealth of Pennsylvania. (1990). *Erosion and Sediment Pollution Control Program Manual*. Pennsylvania Department of Environmental Resources, Bureau of Soil and Water Conservation.
- Commonwealth of Virginia. (1980). *Virginia Erosion and Sediment Control Handbook*. 2nd Edition. Virginia Department of Conservation and Historical Preservation, Division of Soil and Water Conservation.
- County of Fairfax. (1990 and 1987 Editions). "Check List for Erosion and Sediment Control Fairfax County, Virginia."
- Metropolitan Washington Council of Governments (MWCOG). (1987). *Controlling Urban Runoff: A Practical Manual for Planning and Designing Urban BMPs*. Department of Environmental Programs, Metropolitan Washington Council of Governments.
- National Research Council. (2008). *Urban Stormwater Management in the United States*. Washington, D.C.: The National Academic Press.
- Northern Virginia Planning District Commission. (1987). *BMP Handbook for the Occoquan Watershed*. Prepared for Occoquan Basin Nonpoint Pollution Management Program.
- Salt Institute. (1987). *The Salt Storage Handbook, A Practical Guide for Storing and Handling Deicing Salt*. Alexandria, Virginia.

Santa Clara Valley Nonpoint Source Pollution Control Program. (No Date). Automotive-Related Industries, BMPs for Industrial Sanitary Sewer Discharges and Storm Water Pollution Control.

State of Maryland. (1983). *Maryland Standards and Specifications for Soil and Erosion and Sediment Control*. Maryland Water Resources Administration, Soil Conservation Service, and State Soil Conservation Committee.

State of North Carolina. (1988). *Erosion and Sediment Control Planning and Design Manual*. North Carolina Sedimentation Control Commission, Department of Natural Resources and Community Development, and Agricultural Extension Service.

State of Wisconsin. (1990). *Wisconsin Construction Site Best Management Practice Handbook*. Wisconsin Department of Natural Resources, Bureau of Water Resources Management, Nonpoint Source and Land Management Section.

Thron, H. and Rogashewski, O.J. (1982). "Useful Tools for Cleaning Up." Hazardous Material & Spills Conference.

U.S. Environmental Protection Agency. (1973). *Process, Procedure, and Methods to Control Pollution Resulting from All Construction Activity*. EPA Office of Air and Water Programs, PB-257-318.

U.S. Environmental Protection Agency. (1979). *NPDES Best Management Practices Guidance Document*. Industrial Environmental Research Laboratory, Cincinnati, Ohio, prepared by Hydrosience, Inc. EPA 600/9-79-0451.

U.S. Environmental Protection Agency. (1987). *Draft Report on Best Management Practices for the Control of Storm Water from Urbanized Areas*. Science Applications International Corporation.

U.S. Environmental Protection Agency. (1988). *Waste Minimization Opportunity Assessment Manual*. Hazardous Waste Engineering Research Laboratory.

U.S. Environmental Protection Agency. (1989). *Pollution Prevention in Printing and Allied Industries: Saving Money Through Pollution Prevention*. Office of Research and Development, Pollution Prevention Office.

U.S. Environmental Protection Agency. (1990b). *Draft Sediment and Erosion Control, An Inventory of Current Practices*. EPA Office of Water Enforcement and Permits, prepared by Kamber Engineering. W-278.

U.S. Environmental Protection Agency. (1991a). *Draft - A Current Assessment of Urban Best Management Practices. Techniques for Reducing Non-point Source Pollution in the Coastal Zone*. EPA Office of Wetlands, Oceans and Watersheds, prepared by Metropolitan Washington Council of Governments.

- U.S. Environmental Protection Agency. (1991b). *Draft Construction Site Storm Water Discharge Control, An Inventory of Current Practices*. EPA Office of Water Enforcement and Permits, prepared by Kamber Engineering.
- U.S. Environmental Protection Agency. (1991c). *Guidance Manual for the Preparation of NPDES Permit Applications for Discharges Associated with Industrial Activity*. EPA-505/8-91-002.
- U.S. Environmental Protection Agency. (1991d). *Guidance Manual for the Preparation of NPDES Permit Applications for Discharges from Municipal Separate Storm Water Systems*. EPA-505/8-91-003A.
- U.S. Environmental Protection Agency. (1991e). *Staff Analysis, Storm Water Section*.
- U.S. Environmental Protection Agency. (1992b). *Pollution Prevention Training Opportunities in 1992*. EPA/560/8-92-002.
- U.S. Environmental Protection Agency. (1992c). *Storm Water Management for Industrial Activities, Developing Pollution Prevention Plans and Best Management Practices*. EPA-832-R-92-006.
- U.S. Environmental Protection Agency. (1992d). *Storm Water Management for Construction Activities, Developing Pollution Prevention Plans and Best Management Practices*. EPA-832-R-92-005.
- U.S. Environmental Protection Agency. (1992e). *Storm Water Sampling Guidance Document*. EPA 833-B-92-001.
- U.S. Environmental Protection Agency. (1993a). *Investigation of Inappropriate Pollutant Entries into Storm Drainage Systems, A User's Guide*. EPA/600/R-92/238.
- U.S. Environmental Protection Agency. (1993b). *NPDES Storm Water Program Question and Answer Document: Volume II*. Office of Wastewater Enforcement and Compliance, Permits Division.
- U.S. Environmental Protection Agency. (1993c). *Guidance Manual for Developing Best Management Practices (BMP)*. EPA 833-B-93-004.
- U.S. Environmental Protection Agency. (1997). *Checklist for No-Exposure certification for NPDES Stormwater Permitting*.
- U.S. Environmental Protection Agency. (1998). *Guidance Manual for Implementing Storm Water Management Programs - Volume I - Planning and Administration*. EPA 833-B-00-001.
- U.S. Environmental Protection Agency. (1999a). *Guidance Manual for the Monitoring and Reporting Requirements of the NPDES Storm Water Multi-Sector General Permit*. EPA 833-B-99-001.

- U.S. Environmental Protection Agency. (1999b). *Storm Water Management Fact Sheet Internal Reporting*. EPA 832-F-99-020.
- U.S. Environmental Protection Agency. (1999c). *Storm Water Management Fact Sheet Materials Inventory*. EPA 832-F-99-021.
- U.S. Environmental Protection Agency. (1999d). *Storm Water Management Fact Sheet Non-Storm Water Discharges*. EPA 832-F-99-022.
- U.S. Environmental Protection Agency. (1999e). *Storm Water O&M Fact Sheet Preventative Maintenance*. EPA 832-F-99-004.
- U.S. Environmental Protection Agency. (1999f). *Storm Water Management Fact Sheet Record Keeping*. EPA 832-F-99-005.
- U.S. Environmental Protection Agency. (1999g). *Storm Water Management Fact Sheet Spill Prevention Planning*. EPA 832-F-99-071.
- U.S. Environmental Protection Agency. (1999h). *Storm Water Management Fact Sheet Storm Water Contamination Assessment*. EPA 832-F-99-024.
- U.S. Environmental Protection Agency. (1999i). *Storm Water Management Fact Sheet Dust Control*. EPA 832-F-99-003.
- U.S. Environmental Protection Agency. (1999j). *Storm Water Management Fact Sheet Coverings*. EPA 832-F-99-009.
- U.S. Environmental Protection Agency. (1999k). *Storm Water O&M Fact Sheet Catch Basin Cleaning*. EPA 832-F-99-011.
- U.S. Environmental Protection Agency. (1999l). *Storm Water Technology Fact Sheet Bioretention*. EPA 832-F-99-012.
- U.S. Environmental Protection Agency. (1999m). *Storm Water Technology Fact Sheet Flow Diversion*. EPA 832-F-99-014.
- U.S. Environmental Protection Agency. (1999n). *Storm Water Technology Fact Sheet Hydrodynamic Separators*. EPA 832-F-99-017.
- U.S. Environmental Protection Agency. (2005a). *Storm Water Phase II Final Rule - An Overview*. EPA 833-F-00-001. Revised December 2005.
- U.S. Environmental Protection Agency. (2005b). *Storm Water Phase II Final Rule - Construction Site Runoff Control Minimum Control Measure*. EPA 833-F-00-008. Revised December 2005.

- U.S. Environmental Protection Agency. (2005c). *Storm Water Phase II Final Rule - Illicit Discharge Detection and Elimination Minimum Control Measure*. EPA 833-F-00-007. Revised December 2005.
- U.S. Environmental Protection Agency. (2005d). *Storm Water Phase II Final Rule - Low Rainfall Erosivity Waiver*. EPA 833-F-00-014. Revised December 2005.
- U.S. Environmental Protection Agency. (2005e). *Storm Water Phase II Final Rule - Permitting and Reporting: The Process and Requirements*. EPA 833-F-00-011. Revised December 2005.
- U.S. Environmental Protection Agency. (2005f). *Storm Water Phase II Final Rule - Pollution Prevention/Good Housekeeping Minimum Control Measure*. EPA 833-F-00-010. Revised December 2005.
- U.S. Environmental Protection Agency. (2005g). *Storm Water Phase II Final Rule - Post Construction Runoff Control Minimum Control Measure*. EPA 833-F-00-009. Revised December 2005.
- U.S. Environmental Protection Agency. (2005h). *Storm Water Phase II Final Rule - Public Participation/Involvement Minimum Control Measures*. EPA 833-F-00-006. Revised December 2005.
- U.S. Environmental Protection Agency. (2005i). *Storm Water Phase II Final Rule - Small Construction Program Overview*. EPA 833-F-00-013. Revised December 2005.
- U.S. Environmental Protection Agency. (2005j). *Storm Water Phase II - Compliance Assistance Guide*. EPA 833-R-00-002. Revised December 2005.
- U.S. Environmental Protection Agency. (2005k). *Guidance Manual for Conditional Exclusion from Storm Water Permitting Based On No Exposure of Industrial Activities to Storm Water*. EPA 833-B-00-001. Revised December 2005.
- U.S. Environmental Protection Agency. (2005l). *Storm Water Phase II Final Rule - Small MS4 Storm Water Program Overview*. EPA 833-F-00-002. Revised December 2005.
- U.S. Environmental Protection Agency. (2007). *MS4 Program Evaluation Guidance*. EPA 833-R-07-003.
- U.S. Environmental Protection Agency. (2008). *Evaluating the Effectiveness of Municipal Stormwater Programs*. EPA 833-F-07-010.
- U.S. Environmental Protection Agency. (2009). *Industrial Stormwater Monitoring and Sampling Guide*. EPA 832-B-09-003.
- U.S. Environmental Protection Agency. (2012a). *Storm Water Phase II Final Rule - Conditional No Exposure Exclusion for Industrial Activity*. EPA 833-F-00-015. Revised March 2012.

U.S. Environmental Protection Agency. (2012b). *Draft EPA New England Bacterial Source Tracking Protocol*.

U.S. Environmental Protection Agency. (2012c). *National Pollutant Discharge Elimination System General Permit for Discharges from Construction Activities*.

U.S. Environmental Protection Agency. (2014a). *Establishing Total Maximum Daily Load (TMDL) Wasteload Allocations (WLAs) for Stormwater Sources and NPDES Permit Requirements Based on those WLAs*. EPA Memorandum. Revised November 2014.

U.S. Environmental Protection Agency. (2014b). *Post-Construction Performance Standards & Water Quality-Based Requirements*. EPA 833-R-14-003.

U.S. Environmental Protection Agency. (No Date). "Coastal Zone Act Reauthorization Amendments (CZARA) Section 6217." Available at: <https://www.epa.gov/nps/coastal-zone-act-reauthorization-amendments-czara-section-6217>

Washington State Department of Ecology. (1991). *Standards for Storm Water Management for the Puget Sound Basin*. Chapter 173-275 WAC. Washington State Department of Ecology.

Washington State Department of Ecology. (1992). *Draft Storm Water Management Manual for the Puget Sound Basin*. Washington State Department of Ecology.

REGULATIONS/NOTICES

Federal Register (55 FR 47990). November 16, 1990. National Pollutant Discharge Elimination System (NPDES) Permit Application Requirements for Storm Water Discharges - Final Rule.

Federal Register (56 FR 40948). August 16, 1991. NPDES General Permits and Reporting Requirements for Storm Water Discharges Associated with Industrial Activity-Proposed Rule.

Federal Register (57 FR 11394). April 2, 1992. Application Deadlines, General Permit Requirements and Reporting Requirements-Final Rule.

Federal Register (57 FR 41236). September 9, 1992. Final NPDES General Permits for Storm Water Associated with Industrial Activity; Notice.

Federal Register (57 FR 44438). September 25, 1992. Final NPDES General Permits for Storm Water Associated with Industrial Activity; Notice.

Federal Register (57 FR 41344). September 9, 1992. National Pollutant Discharge Elimination System, Request for Comment on Alternative Approaches for Phase II Storm Water Program; Proposed Rule.

Federal Register (57 FR 60444). December 18, 1992. Permit Issuance and Permit Compliance Deadlines for Phase I Discharges; Final Rule.

Federal Register (64 FR 68721). December 8, 1999. NPDES Regulations for Revision of the Water Pollution Control Program Addressing Storm Water Discharges; Final Rule.

Federal Register (77 FR 47065). August 7, 2012. Final National Pollutant Discharge Elimination System (NPDES) General Permit for Stormwater Discharges from Construction Activities; Notice.

Federal Register (80 FR 34403). June 16, 2015. Final National Pollutant Discharge Elimination System (NPDES) General Permit for Stormwater Discharges from Industrial Activities; Notice.

CHAPTER 12 – COMBINED SEWER OVERFLOWS

Contents

A. Background and History of the CSO Policy	282
B. CSO Inspection Procedures.....	285
Preparation.....	285
On-site Records Review.....	287
Interviews.....	289
Facility Site Inspection.....	292
C. References.....	292
D. CSO Evaluation Checklist.....	294

List of Tables

Table 12-1. Nine Minimum CSO Controls	284
Table 12-2. Elements of the Long-Term CSO Control Plan	284
Table 12-3. CSO Records	288
Table 12-4. CSO Interview Questions	290

Related Websites

Office of Wastewater Management (OWM) home page: <http://www.epa.gov/owm>

Office of Enforcement and Compliance Assurance (OECA) home page:

<https://www.epa.gov/aboutepa/about-office-enforcement-and-compliance-assurance-oeca>

A. BACKGROUND AND HISTORY OF THE CSO POLICY

In addition to materials in this chapter, Inspectors must be familiar with Chapter 1, "Introduction," and Chapter 2, "Inspection Procedures."

EPA's 1994 Combined Sewer Overflow (CSO) Control Policy (Volume 59 of the *Federal Register* (FR) 18688 and 18689, April 19, 1994) defines a combined sewer system (CSS) as "a wastewater collection system owned by a state or municipality (as defined by section 502(4) of the Clean Water Act (CWA)) which conveys sanitary wastewaters (domestic, commercial and industrial wastewaters) and stormwater through a single-pipe system to a Publicly Owned Treatment Works (POTW) Treatment Plant (as defined in Title 40 of the *Code of Federal Regulations* (CFR) Part 403.3(p))." During precipitation events (e.g., rainfall or snowmelt), the volume of sanitary wastewater and stormwater runoff entering CSSs often exceeds the capacity of the treatment works to treat it or the sewer system to store it until it can be treated. When this happens, these systems are designed to overflow directly to surface waters. These overflows are combined sewer overflows (CSOs). The CSO Control Policy defines a CSO as "the discharge from a CSS at a point prior to the POTW Treatment Plant." Approximately 746 communities in the United States have CSSs that together have 9,348 permitted CSO outfalls (i.e., the points from which the discharge leaves the CSS) that are regulated by 859 NPDES permits.

Some CSOs occur infrequently; others, with every precipitation event. Because CSOs contain raw sewage, industrial discharges, and urban stormwater, and contribute pathogens, solids, debris, and toxic pollutants to receiving waters, CSOs can create serious public health and water quality concerns. CSOs have caused or contributed to beach closures, shellfish bed closures, contamination of drinking water supplies, and other environmental and public health problems.

The CSO Control Policy "represents a comprehensive national strategy to ensure that municipalities, permitting authorities, water quality standards authorities and the public engage in a comprehensive and coordinated planning effort to achieve cost-effective CSO controls that ultimately meet appropriate health and environmental objectives and requirements" 59 FR 18688). Under the Policy, CSO communities were expected, through requirements in their NPDES permit or enforceable mechanism, to:

- Implement nine minimum controls (NMC) that may be considered minimum best available technology (BAT), best conventional pollutant control technology (BCT), or best professional judgement (BPJ) by the permitting authority. These NMC are measures that can reduce CSO volumes and frequencies, and their water quality impacts, without significant engineering studies or major construction. CSO communities were expected to implement the NMC with appropriate documentation as soon as practicable but no later than January 1, 1997.
- Develop and submit the long-term CSO control plan (LTCP) as soon as practicable, but generally within two years after the date of the NPDES permit provision, CWA section 308 information request, or enforcement action requiring the permittee to develop the plan. Implement the LTCP. Implementation of the individual CSO controls may be phased based on the relative importance of adverse impacts of the CSOs on water

quality standards and designated uses, priority projects identified in the long-term plan, and on the permittee's financial capability.

Select CSO controls that include a post-construction water quality monitoring program adequate to verify compliance with water quality standards and protection of designated uses as well as to ascertain the effectiveness of CSO controls. Permitting and enforcement authorities are expected to take enforcement action against dry weather CSO discharges, which have always been prohibited by the NPDES program.

The CSO Policy outlines the NMCs and the minimum elements of an LTCP. Table 12-1 lists the NMCs, while Table 12-2 lists the elements of the LTCP. The key elements to CSO control is to:

- Eliminate or relocate overflows that discharge to sensitive areas wherever physically possible and economically achievable, and where not possible, provide treatment necessary to meet WQS for full protection of existing and designated uses.
- Coordinate the review and appropriate revision of water quality standards and implementation procedures on CSO-impacted waters with development of long-term CSO control plans.
- Evaluate a reasonable range of alternatives for the CSO control plan that could achieve the necessary level of control/treatment, and select the controls to be implemented based on cost/performance evaluations.
- Develop an implementation schedule based on the relative importance of adverse impacts on WQS and designated uses, priority projects identified in the long-term plan LTCP, and on the permittee's financial capability.
- Maximize treatment of wet weather flows at the existing POTW treatment plant.

Since the CSO Control Policy was published, EPA has released guidance documents on the following implementation areas: long-term control plans, the nine minimum controls, screening and ranking, funding options, permit writing, financial capability and schedule development, coordinating long-term planning with water quality standards reviews, monitoring and modeling, and Post Construction Compliance Monitoring (see the "References" section and/or the CSO website <https://www.epa.gov/npdes/combined-sewer-overflows-csos> for more information).

In the Consolidated Appropriations Act for Fiscal Year 2000, Public Law (P.L.) 106-554, Congress amended the Clean Water Act by adding section 402(q) to require, among other things, that all permits, orders, and decrees issued to control CSOs, after enactment of the Consolidated Appropriations Act, shall conform to EPA's 1994 CSO Control Policy. EPA and state NPDES permitting authorities should refer to Section IV, Expectations for Permitting Authorities, of the Policy (59 FR 16905–16996). This section of the policy presents the major elements that should be in NPDES permits to implement the Policy and ensure protection of water quality.

State and EPA NPDES permitting authorities continue to work with permittees to incorporate CSO conditions into NPDES permits and through other enforceable mechanisms, such as administrative or judicial orders.

Table 12-1. Nine Minimum CSO Controls

- Proper operation and regular maintenance programs for the sewer system and the CSOs.
- Maximum use of the collection system for storage.
- Review and modification of pretreatment requirements to ensure that CSO impacts are minimized.
- Maximization of flow to the POTW for treatment.
- Prohibition of CSOs during dry weather.
- Control of solid and floatable materials in CSOs.
- Establishment of pollution prevention programs.
- Public notification to ensure that the public receives adequate notification of CSO occurrences and CSO impacts.
- Monitoring to effectively characterize CSO impacts and the efficacy of CSO controls.

Table 12-2. Elements of the Long-Term CSO Control Plan

- Characterization, monitoring, and modeling of the Combined Sewer System
- Public Participation
- Consideration of Sensitive Areas
- Evaluation of Alternatives
- Cost/Performance Considerations
- Operational Plan
- Maximizing Treatment at the Existing POTW Treatment Plant
- Implementation Schedule
- Post-Construction Compliance Monitoring Program

B. CSO INSPECTION PROCEDURES

Each municipality's specific CSO requirements will be contained in a NPDES permit, an enforcement order, a consent decree, or combination of these documents. CSO conditions will be specific to that permittee. However, the inspection of one CSS may involve visits to more than one municipality, depending on the configuration and possible shared responsibility for the system. Moreover, a CSS may be subject to several NPDES permits and/or enforcement orders or consent decrees. Before conducting the inspection, the inspector should determine the authorities responsible for operation of the system and define the scope of the inspection. The inspector will obtain information to determine compliance in the following areas:

- CSO prevention during dry weather.
- Implementation of the nine minimum CSO controls.
- Adherence to a schedule for development, submission, and implementation of a LTCP, including any interim deliverables.
- Adherence to schedule for implementation of the CSO controls selected from the LTCP.
- Elimination or relocation of overflows from identified sensitive areas, as defined in the approved LTCP.
- Meeting narrative, performance-based, or numerical water quality-based effluent limitations.
- Monitoring program, including baseline information on frequency, duration, and impacts of CSOs.

PREPARATION

As stated above, the requirements for CSO control will be found in the NPDES permit, or in some cases, in an enforcement order, such as an administrative order or judicial order, or a consent decree. Inspectors should review the permit (and permit amendments) and other enforceable mechanisms (e.g., consent orders) issued to the permittee. The inspector should be aware that in some cases the CSSs and CSO structures (i.e., pump stations) may be permitted separately from the POTW. The inspector may find:

- Requirements to implement and document implementation of technology-based controls (at a minimum, the nine minimum controls) by the date specified in the permit or enforceable mechanism.
- A requirement to submit a report documenting the implementation of the nine minimum controls; the report will usually be required within 2 years of permit issuance.
- Requirements for implementation of the Long-Term CSO Control Plan. Since the CSO Policy has been in place since 1994, all CSO communities should be implementing their LTCPs. LTCP, should have narrative requirements pertaining to the implementation, operation, and maintenance of the selected CSO controls described in the LTCP. There

will also be an implementation schedule for CSO controls either in the permit or in an appropriate enforceable mechanism.

- Water quality-based effluent limits for CSOs. Numeric limits may not be found in the initial permits when the permittee is developing or implementing its LTCP, but may instead include a requirement to immediately comply with applicable WQSs expressed in the form of a narrative limitation. Permittees that have completed and are implementing their LTCPs may include water quality-based effluent limitations in the form of one or more of the following permit conditions for CSOs:
 - A maximum number of overflow events per year for specified design conditions.
 - Minimum percentage capture of combined sewage by volume for treatment under specified design conditions.
 - Minimum percentage reduction of the mass of pollutants discharged for specified design conditions.
 - Other performance-based standards and requirements.
- Requirements to implement a post-construction compliance monitoring program. This will be required for permittees that have completed implementation of their LTCPs.
- Requirement to re-assess overflows to sensitive areas. This will only be imposed in those cases where elimination or relocation of CSOs from sensitive areas were proven not to be physically possible and economically achievable.
- Conditions establishing requirements for maximizing the treatment of wet weather flows at the treatment plant.

The inspector should also review any CSO reports submitted by the permittee. The permittee may have submitted information in response to CWA section 308 information collection requests. The permittee may have submitted CSO monitoring plans or a report characterizing its combined sewer system, a report documenting implementation of the nine minimum CSO controls, or a Long-Term CSO Control Plan. Other documents and/or information that should be reviewed, if available, include:

- Discharge Monitoring Reports (DMRs).
- Citizen complaints.
- Correspondence.
- Notices of Violation.
- Annual reports (including annual capacity reports).
- Facility reports describing CSO discharge points and overflow problems.
- Inspection reports.
- Noncompliance notification reports describing overflows (usually attached to DMRs).
- Maps or reports detailing the proximity of overflows to drinking water sources.
- Reports that describe the potential for CSO impacts to human health or the environment.

Reviewing these permittee reports will help the inspector become knowledgeable about the permittee's specific CSO problems and existing CSO controls. The inspector should make copies of those documents that 1) establish enforceable CSO requirements, 2) provide evidence that an enforceable requirement has been violated or 3) provide evidence of environmental problems related to CSOs. When reviewing the permit, it is also important to review the narrative language that might contain additional non-numeric requirements that may be enforceable, such as: proper operation and maintenance of the system (including the collection system); CSO discharges being free from odors or floatable materials; and CSO discharge not causing or contributing to water quality impairments.

The inspector should make sure that EPA has a complete copy of noncompliance notification reports for the last five years, indicating the date, time, duration, flow rate, cause, and actions to correct, prevent, and mitigate each overflow from the facility. The inspector should also have a map or other document that provides the location of each CSO discharge point and identifies the receiving stream to which the overflow discharges.

ON-SITE RECORDS REVIEW

The inspector should review the following CSO records:

- Logbooks, internal electronic data systems (e.g., operating and maintenance activity data systems, SCADA control system data), reports, or internal memos describing maintenance and operation activities concerning the sewer system and CSO outfalls.
- CSO outfall flow records.
- Monitoring data on CSOs, collection system, or receiving stream.
- Records pertaining to installation of CSO controls.
- Feasibility studies.
- Capital project summaries (description and cost of each project).

Recordkeeping requirements vary by facility depending on the specific CSO controls the facility has selected and is implementing. If the permittee has submitted a report documenting implementation of the nine minimum CSO controls, the inspector should review appropriate records kept at the facility to verify the information in this report. Table 12-3 lists examples of possible records that might be kept to document the implementation of the nine minimum CSO controls. These examples are provided as illustrations and not requirements. The inspector should use the facility's permit or other enforceable document as a guide to determine what specific records the facility is required to keep and maintain. The facility's CSO operations and maintenance manual and CSO control plan can provide the inspector with insight into the specific types of records the facility would have. In addition, many permittees maintain electronic systems to track complaints, responses, and operation and maintenance activities. The inspector should review these systems and other available information sources to identify potential issues such as recurring complaints (indicating improper operation and maintenance) or potentially unreported dry weather overflows.

Table 12-3. CSO Records

Minimum CSO Controls	Examples of Records/Documentation
Proper Operation and Regular Maintenance Program	<ul style="list-style-type: none"> • Standard Operating Procedures, Operations and Maintenance Manual, or similar manual or plan. • Log of sewer system cleaning, flushing, or debris removal. • Log of repair or maintenance of regulators. • Log of lift station malfunctions and repairs made. • Log of preventive maintenance of interceptor lift stations and pumps. • Work orders for corrective activities. • Log of inspections of lift stations, sewer lines, and regulators.
Maximum Use of Collection System for Storage	<ul style="list-style-type: none"> • Hydraulic study of system and evaluation of alternatives to maximize wet weather flow storage capacity. • Records of installation of in-line devices such as dams, regulators, and gates to retard flow. • Installation of separate sanitary and stormwater lines. • Replacement of undersized pipes. • Adjustment of regulator settings or upgrading/adjusting pumping rates at lift stations. • Off-line temporary storage.
Review and Modification of the Pretreatment Program	<ul style="list-style-type: none"> • Inventory of nondomestic discharges. • Public Water Supply records of water usage for top nondomestic dischargers. • Assessment of significance of nondomestic discharges on CSO and receiving waters. • Pretreatment controls to reduce/eliminate industrial contaminants during wet weather.
Maximization of Flows to the POTW for Treatment	<ul style="list-style-type: none"> • Summary of analyses conducted. • Maximum wet weather flow Wastewater Treatment Plant (WWTP) can receive without pass-through or interference. • Description of modifications to be implemented.
Prohibition of Dry Weather Overflows (DWOs)	<ul style="list-style-type: none"> • Log of inspections of CSOs during dry weather and observations made during these inspections. • Log of Dry Weather Overflow (DWO) reports submitted.
Control of Solids and Floatable Materials in CSOS	<ul style="list-style-type: none"> • Installation of screens or booms. • Source control activities such as regular street cleaning, highly visible anti-litter programs. • MS4 stormwater annual report.
Pollution Prevention	<ul style="list-style-type: none"> • Documentation of street sweeping, anti-litter campaigns.
Public Notification	<ul style="list-style-type: none"> • CSO outfalls are posted with correct signage. • Date and proof of public notice, procedure (by newspaper, radio), public notice information.
Monitoring of CSOs	<ul style="list-style-type: none"> • Identification of outfall locations (i.e., latitude and longitude or street address).

Table 12-3. CSO Records

Minimum CSO Controls	Examples of Records/Documentation
	<ul style="list-style-type: none"> • Number and location of overflow events including duration, volume, and pollutant loadings. • Receiving stream data and impact (e.g., beach closings, fish kills). • Monitoring plan.

INTERVIEWS

As with all of the NPDES compliance inspections, interviews with appropriate personnel with firsthand knowledge of CSS/CSO activities can be useful in obtaining factual information. The inspector should interview the person in the highest position of authority responsible for the day-to-day development or implementation of the LTCP. Other personnel, such as the collection crew or others involved in inspecting, operating, and maintaining CSOs or CSO controls should also be interviewed. It is particularly important that the inspector obtain written statements (see Chapter 2) where personnel are providing information that is not or cannot be substantiated by the facility's records or the inspector's own observations.

If the facility is developing or implementing a LTCP, the inspector may want to interview those personnel responsible for that plan. Generally, the facility will be under a schedule with distinct activities and milestones established. This schedule may be in the permit, but will more likely be in an enforcement order. Other schedules, such as those submitted by the permittee in a report or in its LTCP are not enforceable schedules, and should only be referred to if an enforceable schedule does not exist. The inspector should focus on verifying the LTCP development or implementation activities that 1) the permittee has reported have been developed/implemented and 2) the permittee was required to have developed/implemented according to a schedule in the permit or enforcement order.

The following are examples of relevant questions that the inspector can use to obtain a general understanding of the facility. Other questions relevant to the specific NMCs are listed in Table 12-4. The inspector should add to these questions based on the specific requirements in the facility's permit. For example, if the permit requires submission of a "CSO Characterization Report" within 180 days of the permit issuance, the inspector should request the report and verify whether it was submitted within the established timeframe.

- What type of technology is used to control CSO discharges? Describe regulator mechanisms used, including size, type, presence or absence of backflow devices, and location.
- Describe the system, identifying the older and newer facilities that are used.
- Which areas and percentage of the collection system are combined and which areas contain separate storm and sanitary systems? What sewer systems/communities are served by the treatment plant? Is the collection system gravity fed or are pumps used? If pumping stations are used, how many are there and where are they located?

- What flows does the municipality receive from other municipalities? Are these upstream systems combined sewer systems or separate sanitary systems? What kinds of overflow problems have the upstream municipalities reported? What agreements are in place establishing which municipality has authority and duty to maintain various parts of the sewer system?
- How many overflows have occurred in the collection system, including contributing jurisdictions, within the last five years?
- What is the most common cause of overflows?
- What is an estimate of the amount of rainfall or snowmelt needed to cause CSOs?
- Where are the CSO outfalls located? Are any located at pump stations? What receiving stream does each CSO discharge to?
- What is a typical monthly rate of CSO events (including dry and wet weather events)?
- What samples have been taken of overflows? (Ask to see sample results.)
- What steps is the municipality taking to comply with the CSO requirements in its permit? If the municipality is planning to meet a different schedule than that required in the permit, what is its timeline?

Table 12-4. CSO Interview Questions

Minimum CSO Controls	Examples of Interview Questions
Proper Operations and Regular Maintenance Program	<ul style="list-style-type: none"> • How often are CSO discharge locations inspected? Who conducts the inspections? What records do they keep? How is corrective action assured when a problem is discovered? How are the operability and reliability of regulators verified? • Do the pump stations have backup power? Is any other type of redundancy built into the collection system to minimize the occurrence of overflows? • What is the municipality’s budget for collection system operation? For collection system maintenance? How much was spent last year on collection system operation and maintenance? What has been the trend in operation and maintenance budget over time? • How many people are dedicated to maintaining the collection system? What has been the staffing trend over time? • What improvements are planned? Are these projects funded? What is the process for funding capital improvements? • How are personnel trained? • How often is the Operations & Maintenance plan reviewed? When was the last revision? • If green infrastructure is used to reduce flow how are controls being maintained to ensure continued effectiveness? • Have O&M plans been updated to include GI maintenance?
Maximum Use of Collection System for Storage	<ul style="list-style-type: none"> • What steps are taken to maximize use of the collection system for storage? (e.g., install dams, weirs, and regulators)

Table 12-4. CSO Interview Questions

Minimum CSO Controls	Examples of Interview Questions
Review and Modification of the Pretreatment Program	<ul style="list-style-type: none"> • When were the pretreatment requirements last reviewed to ensure minimization of CSO impacts from upstream Industrial Users? What changes have been made to the program to accomplish this goal? What percentage of total flow comes from nondomestic sources?
Maximization of Flows to the POTW for Treatment	<ul style="list-style-type: none"> • What steps are taken to maximize flow to the POTW? • What are the bottlenecks in the sewer system? What facilities in the system are critical to the performance of the CSS? • What are the capabilities of major interceptors and pumping stations delivering flows to the treatment POTW? • How do wet weather flows to the POTW compare with dry weather flows? • How does the current total flow compare to the design capacity? • What, if any, unused treatment facilities are used to store wet weather flows?
Prohibition of Dry Weather Overflows (DWOs)	<ul style="list-style-type: none"> • What has the municipality done to eliminate dry weather overflows? • How does the municipality identify dry weather overflows? If inspections are used, how often are the inspections performed? What type of monitoring is performed to identify dry weather overflows? • Describe the most recent cleaning, sewer repair, or regulator repair performed to alleviate a dry weather overflow. • How does the municipality determine which dry weather overflows could endanger health or the environment?
Control of Solids and Floatable Materials in CSOS	<ul style="list-style-type: none"> • How does the municipality keep solids and floatables out of the CSO discharge? • If solids and floatables do reach the receiving waters, how does the municipality remove them?
Pollution Prevention	<ul style="list-style-type: none"> • What pollution prevention measures (e.g., street cleaning, public education, waste collection or recycling) does the municipality take to keep contaminants from entering the sewer system?
Public Notification	<ul style="list-style-type: none"> • How has the public been notified of the location of CSO discharge points? How does the municipality notify the public of overflow incidents? When was the last notification? • What is the internal mechanism for reporting sewage overflows? How does this information reach the permitting authority?
Monitoring of CSOs	<ul style="list-style-type: none"> • How does the municipality monitor CSOs? How does the municipality use this monitoring to characterize the impacts of CSOs? How does the municipality use this monitoring to evaluate the effectiveness of CSO controls? Does the municipality monitor CSO flow rates? • What information from other groups (e.g., Coast Guard or local volunteer groups) does the municipality collect on water quality or use of waters affected by CSOs (e.g., beach closings, fish kills)?

Table 12-4. CSO Interview Questions

Minimum CSO Controls	Examples of Interview Questions
	<ul style="list-style-type: none"> • Which CSO receiving waters are the most sensitive? Why? (e.g., proximity to drinking water sources)

FACILITY SITE INSPECTION

An inspection of the CSO outfalls should be included in a NPDES compliance inspection to get a complete picture of how the overall POTW (wastewater treatment plant and collection system) is performing. This is especially true if the inspection's focus or one of its objectives is to investigate compliance with CSO requirements. In such cases, an inspection of CSO structures, CSO treatment systems, or key areas of the collection system is necessary. If the intent of the inspection is to observe CSO discharges or treatment, it may be necessary to schedule this inspection during or immediately after a wet weather event. These outfalls would be located throughout the collection system and, therefore, may be several miles from the treatment facility.

It is not necessary to inspect all CSO outfalls. The inspector can select a few either randomly or can use several criteria to select which outfalls to inspect, including:

- Location (closest to the plant, or proximity to other outfalls).
- Size as measured by discharge volume (e.g., the largest discharge volumes).
- Frequency of discharge (during wet weather).
- Treatment of solids and floatables (if the inspector wishes to evaluate the operation and maintenance of such controls).
- Incidence of dry weather overflows (DWOs).
- Discharges to sensitive areas.
- Impact on water quality (those known to impact water quality).
- Lack of previous inspections by the permittee.

If the inspector observes any dry weather CSO discharges, the inspector should make a photographic record (see Chapter 2); note the appearance and approximate flow rate of the discharge; if possible, sample the discharge (assuming that adequate laboratories are available for the analysis); note the present and immediately preceding weather conditions; and conduct in-depth interviews and obtain statements from facility personnel.

C. REFERENCES

The following is a list of resources providing additional information on CSOs.

Federal Register. (1989). *National CSO Control Strategy: Notice*. Volume 54, No. 3737.0

Federal Register. (1994). *Combined Sewer Overflow Control Policy: Notice*. Volume 59, No. 75.

- U.S. Environmental Protection Agency. (1993). *Manual: Combined Sewer Overflow Control*. Washington, D.C. EPA 625/R-93-007
- U.S. Environmental Protection Agency. (1995a). *Combined Sewer Overflows Guidance for Long-Term Control Plan*. EPA 832-B-95-002.
- U.S. Environmental Protection Agency. (1995b). *Combined Sewer Overflows Guidance for Nine Minimum Control Measures*. EPA 832-B-95-003.
- U.S. Environmental Protection Agency. (1995c). *Combined Sewer Overflows Guidance for Permit Writers*. EPA 832-B-95-008
- U.S. Environmental Protection Agency. (1995d). *Combined Sewer Overflows Guidance for Screening and Ranking*. EPA 832-B-95-004
- U.S. Environmental Protection Agency. (1995e). *Combined Sewer Overflows Guidance for Funding Options*. EPA 832-B-95-007
- U.S. Environmental Protection Agency. (1996a). *The Enforcement Management System National Pollutant Discharge Elimination System (Clean Water Act) Chapter X: Setting Priorities for Addressing Discharges from Separate Sanitary Sewers*.
- U.S. Environmental Protection Agency. (1996b). *Sanitary Sewer Overflows: What are they and how can we reduce them?* EPA 832-K-96-001.
- U.S. Environmental Protection Agency. (1997). *Combined Sewer Overflows Guidance on Financial Capability and Schedule Development*. EPA 832-B-97-004
- U.S. Environmental Protection Agency. (1999). *Combined Sewer Overflows Guidance for Monitoring and Modeling*. EPA 832-B-99-002
- U.S. Environmental Protection Agency. (2000a). *Compliance and Enforcement Strategy for CSOs and SSOs*.
- U.S. Environmental Protection Agency. (2000b). *Benefits of Protecting Your Community from Sanitary Sewer Overflows*. EPA 832-F-00-005.
- U.S. Environmental Protection Agency. (2001a). *Evaluating POTW Capacity, Management, Operation, and Maintenance Programs*.
- U.S. Environmental Protection Agency. (2001b). *Guidance: Coordinating CSO Long-term Planning with Water Quality Standards Reviews*. EPA-833-R-01-002.
- U.S. Environmental Protection Agency. (2012). *Integrated Municipal Stormwater and Wastewater Planning Approach Framework*.

U.S. Environmental Protection Agency. (2014a). *Financial Capability Assessment Framework*.

U.S. Environmental Protection Agency. (2014b). *Greening CSO Plans: Planning and Modeling Green Infrastructure for Combined Sewer Overflow (CSO) Control*. EPA 832-R-14-001.

D. CSO EVALUATION CHECKLIST

A. IDENTIFICATION OF CSOs			
Yes	No	N/A	1. Are all CSO points identified?
Yes	No	N/A	2. Does facility have maps/schematics of Combined Sewer System (CSS) depicting location of all CSO discharge points?
Yes	No	N/A	3. Is each CSO discharge point located by longitude, latitude, and street address on appropriate maps?
B. DRY WEATHER OVERFLOWS			
Yes	No	N/A	1. Are the locations of all dry weather CSOs known by permittee?
Yes	No	N/A	2. Does permittee have records of quantitative loads and flows on all dry weather CSO events?
Yes	No	N/A	3. Has notification been given to EPA/state of all dry weather CSO discharges?
Yes	No	N/A	4. Are there any unreported dry weather CSOs?
C. RECORDS			
			1. Are the following records kept for CSO events?
Yes	No	N/A	• Location.
Yes	No	N/A	• Frequency of discharge.
Yes	No	N/A	• Flow magnitude.
Yes	No	N/A	• Discharge pattern.
Yes	No	N/A	• Total volume of discharge.
Yes	No	N/A	• Duration of the event.
Yes	No	N/A	• Pollutant characterization.
Yes	No	N/A	• Correlation with rainfall records.
Yes	No	N/A	• Specific causes of overflows.
Yes	No	N/A	• Flow collected/flow diverted?
Yes	No	N/A	2. Are records of CSO flows maintained?
Yes	No	N/A	3. Are records accurate?
D. OPERATION AND MAINTENANCE			
Yes	No	N/A	1. Is there a CSS O&M manual and does it address O&M of CSO structures?
Yes	No	N/A	2. Does the facility conduct inspections of the CSS and CSO structures?
Yes	No	N/A	3. Are these inspections documented? Does documentation include results of various types of inspections, dates and times, corrective action taken if problems were found?

Yes	No	N/A	4. Is a logbook of maintenance and repair on the CSS and CSO structures maintained? Does this note the type of problem (or indicate routine maintenance), repair made, or maintenance activity conducted, date?
E. COMPLIANCE SCHEDULES			
			1. Is permittee meeting CSO compliance schedule for:
Yes	No	N/A	<ul style="list-style-type: none"> Implementing nine minimum CSO controls?
Yes	No	N/A	<ul style="list-style-type: none"> Developing LTCP?
Yes	No	N/A	<ul style="list-style-type: none"> Implementing LTCP?
Yes	No	N/A	2. Has permittee requested an extension of time?

CHAPTER 13 – SANITARY SEWER OVERFLOWS

Contents

A. Overview of SSOs.....	297
B. SSO Inspection Procedures.....	299
Preparation.....	299
Records Review	301
Interviews.....	302
Facility Site Inspection.....	303
C. References.....	306

List of Tables

Table 13-1. Documents to Review	305
---------------------------------------	-----

Related Websites

Office of Wastewater Management (OWM) home page: <http://www.epa.gov/owm>

A. OVERVIEW OF SSOS

In addition to materials in this chapter, inspectors must be familiar with Chapter 1, "Introduction," and Chapter 2, "Inspection Procedures."

Sanitary sewer collection systems are designed to remove wastewater from homes and other buildings and convey it to a proper treatment facility and disposal location. The collection system is critical to successful performance of the wastewater treatment process. The Environmental Protection Agency (EPA) estimates that collection systems in the United States have a replacement value of \$1 to \$2 trillion. Under certain conditions, poorly designed, built, managed, operated, and/or maintained systems can pose risks to public health and the environment. These risks arise from sanitary sewer overflows (SSOs) from the collection system. SSOs are discharges of wastewater (including that combined with rainfall-induced infiltration/inflow) from a separate sanitary sewer prior to treatment at the wastewater treatment plant. SSOs typically release untreated sewage into basements or out of manholes and onto city streets, public spaces, and into streams.

Effective and continuous management, operation, and maintenance, as well as ensuring adequate capacity and performing rehabilitation, when necessary, are critical to maintaining collection system capacity and performance while extending the life of the system. Many sanitary sewer collection systems, however, have received minimal maintenance over the years resulting in deteriorated sewers with subsequent overflows, cave-ins, hydraulic overloads at treatment plants, and other safety, health, and environmental problems. As one of the most serious and environmentally threatening problems, sanitary sewer overflows are a frequent cause of water quality violations and are a threat to public health and the environment. Beach closings, flooded basements, closed shellfish beds and hydraulically overloaded wastewater treatment plants are some symptoms of collection systems with inadequate capacity and improper management, operations, and maintenance.

Even though separate sanitary sewer systems are designed to collect and transport all the sewage that flows into them, SSOs can still occur. Recurring SSOs typically indicate that something is wrong with the system. Problems contributing to SSOs include:

- **Deteriorating sewer system:** Many sewer authorities neglect to plan and fund long-term sewer rehabilitation and replacement projects.
- **Infiltration and inflow (I&I):** This involves too much rainfall or snowmelt infiltrating through the ground into leaky sanitary sewers, excess water inflowing through roof drains connected to sewers, broken pipes, or badly connected sewer service lines. Unlike combined sewers, sanitary sewers are not intended to collect or convey rainfall or to drain property.
- **Undersized systems:** Sewers and pumps are too small to carry sewage from newly developed subdivisions or commercial areas; this may be exacerbated by I&I.

- **Pipe failures:** Pipe failures result from blocked, broken or cracked pipes. Sections of pipe settle or shift so that pipe joints no longer align with one another, sediment and other material build up causing pipes to break or collapse.
- **Pump station failures:** This results from pump failures, power failures, and inadequate wet well capacity.
- **Sewer service connections:** Discharges occur at sewer service connections to houses and other buildings due to pipe blockages and/or failures.
- **Pipe blockages:** Grease and tree roots are the primary causes of sewer blockages.
- **Vandalism and construction-related spills:** While there are many causes for vandalism, they often result in blockages or failure of pumps. For construction, breaks in lines occur due to improperly marked lines, or errant excavation contractors.

From a compliance standpoint, Chapter X of the *Enforcement Management System (EMS): Setting Priorities for Addressing Discharges from Separate Sanitary Sewers* (EPA, 1996a), establishes a series of guiding principles and priorities for use by EPA Regions and National Pollutant Discharge Elimination System (NPDES) states in responding to separate sanitary sewer discharge violations. Chapter X states:

“For a person to be in violation of the Clean Water Act: 1) a person must own, operate, or have substantial control over the conveyance from which the discharge of pollutants occurs, 2) the discharge must be prohibited by a permit, be a violation of the permit language, or not be authorized by a permit, and 3) the discharge must reach waters of the United States. In addition, discharges that do not reach waters of the United States may nevertheless be in violation of Clean Water Act permit requirements, such as those requiring proper operation and maintenance (O&M), or may be in violation of State law.”

The exact use of language in a NPDES permit disallowing SSOs may vary from one facility to another (often depending on how a state NPDES permit authority contends with SSOs). Some permits explicitly prohibit overflows from the system and in other cases, where the permit may be silent, SSOs that discharge to waters of the United States are treated as unauthorized discharges and a violation of the CWA. In either circumstance, SSOs that discharge to waters of the United States are prohibited and illegal.

Systems have been found to be out of compliance because of overflows (even those that do not reach waters of the United States) that are the result of improper operation and maintenance. The regulations at Title 40 of the *Code of Federal Regulations (CFR) Part 122.41(e)* require, as a standard NPDES permit condition, that permitted wastewater owners or operators must “properly operate and maintain all facilities and systems of treatment and control (and related appurtenances) which are installed or used by the permittee to achieve compliance with the conditions of this permit.”

Another standard permit condition regarding the duty to mitigate states that “the permittee shall take all reasonable steps to minimize or prevent any discharge... in violation of [the]

permit which has a reasonable likelihood of adversely affecting human health or the environment” (40 CFR 122.41 (d)). This may be interpreted to include sanitary sewer overflow discharges.

Most permittees are required to report any noncompliance, including any overflows, regardless of volume, that result in a discharge or that are caused by improper operation and maintenance. Most permits also require that any noncompliance, including overflows which may endanger the health or the environment, be reported within 24 hours, and in writing within five days (40 CFR 122.41(l)(6)). Most permits also require notification to the public and other entities (Third Party Notice) of overflows that may endanger health due to a likelihood of human exposure.

Since there are minor variations among permits regarding how to deal with overflows (except for the standard permit conditions that appear in all permits), the NPDES inspector should rely on the guidance in Chapter X of the EMS (part of which has been summarized above), NPDES permit requirements for municipal sanitary sewer collection systems and SSOs, and the Publicly Owned Treatment Work (POTW) NPDES permit for standards for evaluating compliance.

B. SSO INSPECTION PROCEDURES

During an inspection of a sanitary sewer system, the inspector will obtain information indicating whether the sewer authority is properly managing, operating, and maintaining its collection system and taking all feasible steps to stop sanitary sewer overflows. The inspection of one sanitary sewer system may involve visits to more than one municipality, depending upon the configuration and possible shared responsibility for the system. Before conducting the inspection, the inspector should identify the authorities responsible for operation of the system and define the scope of the inspection.

PREPARATION

In evaluating either a system with a history of SSOs or a system in which overflows may not necessarily be documented, the compliance inspector will rely primarily on the permit¹⁰ as a starting point. The inspector should refer to standard permit language contained in the NPDES permit. The inspector should also review the permit for any overflow-related requirements specific to the system.

An enforcement order, consent decree, or other enforceable document might also indicate prohibition, notification, or special circumstance language. Often, the establishment of a sanitary sewer discharge control program is the result of an enforcement action against a

¹⁰ Municipal satellite collection systems are sanitary sewers owned or operated by a municipality that conveys sewage or industrial wastewater to a POTW that has a treatment plant owned or operated by a different municipality. These types of facilities do not typically have their own NPDES permit. Any discharge from a municipal satellite collection system without a permit would be a violation of the CWA and would be subject to potential enforcement.

system. The inspector should refer to the enforcement document (e.g., consent decree, order, or other settlement) for a compliance schedule for sanitary sewer discharge control programs.

The compliance inspector will be faced with obtaining information to determine compliance in the following areas:

NPDES Standard Conditions

- **Proper Operation and Maintenance**. Regulatory language at 40 Part 122.41(e) states that: “The permittee shall at all times properly operate and maintain all facilities and systems of treatment and control (and related appurtenances) which are installed or used by the permittee to achieve compliance with the conditions of this permit.” Poor operation and maintenance practices frequently lead to unpermitted discharges.
- **Duty to Mitigate**. Regulatory language at 40 CFR 122.41(d) states that: “The permittee shall take all reasonable steps to minimize or prevent any discharge... in violation of [the] permit which has a reasonable likelihood of adversely affecting human health or the environment.” These steps would include activities critical to the operation and maintenance of the system.
- **Non-compliance Reporting**. Regulatory language at 40 CFR 122.41(l)(6) states that: “The permittee shall report any noncompliance which may endanger health or the environment. Any information shall be provided orally within 24 hours from the time the permittee becomes aware of the circumstances.” Regulatory language at 40 CFR 122.41(l)(7) states that: “The permittee shall report all instances of noncompliance not reported under paragraphs (l)(4), (5), and (6) of this section, at the time monitoring reports are submitted.”

Notification Procedures

- In general, permits require that any noncompliance, including overflows that result in a discharge or that are caused by improper operation and maintenance, be reported at the end of each month with the DMR (see 40 CFR 122.41(l)(6) and (7)). At a minimum, permits typically require that overflow summaries include the date, time, duration, location, estimated volume, cause, as well as any observed environmental impacts, and what actions were taken or are being taken to address the overflow.
- Most permits also require that any noncompliance, including overflows, which may endanger the health or the environment be reported within 24 hours, and in writing within five days. Examples of overflows which may endanger health or the environment include major line breaks, overflow events that result in fish kills or other significant harm, and overflow events that occur in environmentally sensitive areas. Most permits also require notification to the public and other entities (Third Party Notice) of overflows that may endanger health due to a likelihood of human exposure.

Prohibition of Unpermitted Discharges

- Discharges to waters of the United States must be regulated by a NPDES permit. Any discharge from a location other than the effluent discharge point specified in the permit

constitutes an unpermitted discharge. This includes dry weather overflows and discharges from municipal satellite collection systems without permits.

RECORDS REVIEW

Prior to the inspection, the inspector should review the permittee's DMRs, SSO notification reports submitted by the permittee, sewer overflow service calls, and other documents that may have relevant information (e.g., annual reports). The permittee may have submitted information in response to EPA CWA section 308 information requests on SSOs. As required by an enforcement action, the permittee may have submitted plans or a report characterizing its program to eliminate SSOs or a report documenting progress of its sanitary sewer discharge control programs or describing SSO discharge points and overflow problems. Other documents and information that should be reviewed, if available, include:

- Citizen complaints
- Correspondence
- Notices of violation
- Annual capacity reports
- Inspection reports
- Maps illustrating the proximity of overflows to drinking water sources
- Depth of ground water
- Age of the city
- Extent of city ownership of service connection laterals
- Potential for impact to human health and the environment

Reviewing these reports in advance of the inspection will help the inspector become knowledgeable about the permittee's specific SSO problems, existing SSO controls, and/or plans to reduce or eliminate their SSO problems. The inspector should make copies of those documents that provide evidence of 1) any SSO occurring at the facility within the previous five years or 2) environmental problems related to SSOs at the facility. The inspector should make sure that EPA has a complete copy of the last five years of noncompliance notification reports, indicating the date, time, duration, flow rate, cause, and actions to correct, prevent, and mitigate each sewage overflow from the facility.

During the on-site records review, the types of records that the inspector should find at the facility include logs, reports, or internal memos describing maintenance and operation activities concerning the sanitary sewer system and SSOs. As in any NPDES evaluation, the inspector should review DMRs as well as monitoring results as reported by the laboratory that analyzed the data.

However, during inspections concerned with SSOs, the inspector might also request records pertaining to management, budget, and planning for sewer infrastructure improvements. The inspector might also want to review maps of the sanitary sewer system, indicating the locations of manholes, pump stations, etc. Table 13-1 contains a sample list of documents to review.

Items have been arranged under headings for each of the four major components: Capacity, Management, Operations, and Maintenance (CMOM). There is some overlap between the areas where an inspector would typically use some of the documents listed. For example, POTW flow records would be helpful in the section of the inspection report relating to operations and maintenance as well as capacity. As appropriate, the permittee should have as many of these records readily available as possible.

EPA has an inspection guide for CMOM programs at collection systems, the *Guide for Evaluating Capacity, Management, Operations, and Maintenance Programs at Sanitary Sewer Collection Systems* (EPA, 2005). This guide includes a detailed checklist for conducting evaluations of wastewater collection system CMOM programs. The guide also provides a form that provides examples of the types of information an inspector should attempt to obtain while on-site. In addition, EPA Region 4 has developed materials and guidance to help a municipality with its CMOM program (see references of this chapter).

INTERVIEWS

As with all NPDES compliance inspections, interviews with appropriate personnel are essential to understanding the context and meaning of the documents and records. In the case of SSO investigations, appropriate personnel would include people in the highest position of authority at the facility as well as those responsible for day-to-day operations, maintenance and/or oversight of crews such as the collection crew or others involved in inspecting, operating, and maintaining the system. It is particularly important that the inspector obtain written statements (see Chapter 2) where personnel are providing information that is not or cannot be substantiated by the facility's records or the inspector's own observations.

The following are examples of relevant questions that the inspector can use to obtain a general understanding of the facility.

- What is the capacity of the collection system? Is the capacity adequate? What measures have been taken to prevent SSOs?
- What flows does the municipality receive from other municipalities? What kinds of overflow problems have the upstream municipalities reported? What agreements exist to maintain various parts of the sewer systems?
- What are the causes of overflows, where do they occur, and how are they documented and reported?
- Where are the potential SSO point discharges located? Are any located at pump stations? What receiving stream does each SSO discharge to?
- How many SSOs have occurred in the past five years? What is the plan to reduce/eliminate SSOs?
- What are the SSO remediation policies and emergency Standard Operating Procedures (SOPs)?
- How does the authority identify and assess impact from non-municipally owned lateral lines?

- What preventive and response Best Management Practices (BMPs), such as containment, recovery, and minimization of impact to human health and the environment, are in place?
- How are personnel trained to manage and/or prevent SSOs, and what are current staffing levels?
- Are there any alarms or monitoring systems to alert you of an imminent SSO, and what are they?
- What are the goals of the authority's program for managing, operating, and maintaining the sanitary sewer conveyance system?
- What structural deficiencies have been identified in the system?
- What is the O&M schedule for replacement parts/equipment and collection system improvements?
- What studies have been performed of the authority's program for managing, operating, and maintaining the sanitary sewer collection system?

FACILITY SITE INSPECTION

Previous chapters of this manual provide guidance on general procedures for performing compliance inspections and are a valuable source of information on such topics as entry, legal authority and responsibilities of the inspector. However, there are some issues with entry that are specific to CMOM inspections. The inspector should be aware that some collection system components may be on private property, and they must gain entry properly through the property owner.

After reviewing records of SSO incidents, the inspector should visit previously identified SSO locations. The field inspection of the collection system should be directed by information gathered on prior SSOs, noncompliance notifications, citizen complaints, state reports, municipal studies, etc. Locations where large or representative SSOs have occurred or where SSOs occur more frequently should have higher priority for field inspection. The inspector should review causes (e.g., evidence of illicit connections) and determine whether the situation that led to the spill has been adequately addressed.

Field sampling must be conducted according to approved EPA methodology discussed in other chapters and may include sampling of the discharge and/or the receiving stream. Field sampling may be useful in developing enforcement actions to address chronic or acute violations, and as such, must be conducted with strict adherence to 40 CFR Part 136 and chain-of-custody protocol.

The inspector is reminded to take appropriate safety precautions. Collection systems may present physical, biological, chemical, and atmospheric hazards. Safety equipment should include a hard hat, steel-toed boots, safety glasses, gloves and for those with prescription eyeglasses, eyeglass straps are very important. A flashlight (and/or a small mirror) is also useful for collection system inspections. Collection system operators typically deal with manhole cover removal and other physical activities. The inspector should not enter confined spaces. In sewer collection systems, the two most common confined spaces are the underground pumping

station and manholes. The underground pumping station is typically entered through a relatively narrow metal or concrete shaft via a fixed ladder creating limited access and entry/exit.

Table 13-1. Documents to Review

Capacity	Management	Operations	Maintenance
<ul style="list-style-type: none"> • Information relating to system capacity. • Performance data. • POTW Flow Records. • Capital improvement projects (CIP) plan (including funding and planned improvements). • Collection system master plan. • Infiltration/Inflow studies. • I/I studies and evaluations (including programs for eliminating illegal connections). 	<ul style="list-style-type: none"> • Organization chart(s) and chain of communication for reporting SSOs. • Program goals. • Management policies and procedures. • Job descriptions. • Staffing plans, crew assignments and schedules. • Sewer Use Ordinance, Grease Control Ordinance. • Legal authority establishing control of system equipment and its maintenance. • O&M budget with cost centers for wastewater collection. • Recent annual report if available. • Procurement process. • Information systems. • Training plan. • Training and certification records. • Public education materials. • Policy and procedures for trenching, confined space, lockout tagout, PPE. • CMOM program audits. • Methods to extend good collection systems management to any satellite communities discharging to the central system. 	<ul style="list-style-type: none"> • Detailed maps/schematics of the collection system and pump stations. • O&M manuals. • Inspection strategy, forms, and records. • SSO reports detailing location, receiving water, volume, cause, start and stop date and time, system component, corrective action, and actions to mitigate impacts. • Safety manual. • Emergency response plan/SOP (awareness, notification, training, and emergency response). • SCADA and other alarm system information. • Materials management program. • Vehicle management. • Overall map of system showing facilities such as pump stations, treatment plants, major gravity. • Odor and corrosion control strategy. • Root control program. • Sampling procedures. • Industrial pretreatment oversight of the collection system. 	<ul style="list-style-type: none"> • Routine reports regarding system O&M activities. • Work order management system. • Maintenance tasks and frequencies. • Replacement parts inventory. • Performance measures for inspection, cleaning, repair, rehabilitation sewers, and force mains. • Preventive maintenance cleaning strategy. • Problem diagnosis records. • Repair, rehabilitation, replacement strategy for pipes and pump stations. • Record of citizen complaints and emergencies (normal hours and after hours). • Notifications to public health agencies, NPDES authority, and other entities.

C. REFERENCES

The following is a list of resources providing additional information on SSOs.

- U.S. Environmental Protection Agency. (1995). *Enforcement Efforts Addressing Sanitary Sewer Overflows*. EPA Memorandum.
- U.S. Environmental Protection Agency. (1996a). *The Enforcement Management System National Pollutant Discharge Elimination System (Clean Water Act) Chapter X: Setting Priorities for Addressing Discharges from Separate Sanitary Sewers*.
- U.S. Environmental Protection Agency. (1996b). *Sanitary Sewer Overflows: What are they and how can we reduce them?* EPA 832-K-96-001.
- U.S. Environmental Protection Agency. (1996c). *Sanitary Sewer Overflow and Sanitary Sewer Operation, Maintenance, and Management Draft Unified Paper*.
- U.S. Environmental Protection Agency. (2000a). *Compliance and Enforcement Strategy Addressing Combined Sewer Overflows and Sanitary Sewer Overflows*. EPA Memorandum.
- U.S. Environmental Protection Agency. (2000b). *Brochure: Benefits of Protection Your Community from Sanitary Sewer Overflows*. EPA 832-F-00-005.
- U.S. Environmental Protection Agency. (2001a). *Fact sheet: Why Control Sanitary Sewer Overflows?*
- U.S. Environmental Protection Agency. (2001b). *Benefits of Protecting Your Community From Sanitary Sewer Overflows*. EPA 832-F-00-005.
- U.S. Environmental Protection Agency. (2001c). *Evaluating POTW Capacity Management, Operation, and Maintenance Programs*. Office of Compliance and Region 4.
- U.S. Environmental Protection Agency. (2001d). *Fact sheet: Evaluating POTW Capacity, Management, Operation, and Maintenance Programs*. Office of Enforcement and Compliance Assistance & Region 4.
- U.S. Environmental Protection Agency. (2002a). *Case Study: Clearwater, Florida Abates Sanitary Sewer Overflows Using the EPA Region 4 Management, Operations and Maintenance Approach*. EPA 833-R-02-001.
- U.S. Environmental Protection Agency. (2002b). *Fact Sheet: Asset Management for Sewer Collection Systems*. EPA 833-F-02-001.
- U.S. Environmental Protection Agency. (2004). *Report to Congress: Impacts and Control of CSOs and SSOs*. EPA 833-R-04-001.

U.S. Environmental Protection Agency. (2005). *Guide for Evaluating Capacity, Management, Operation, and Maintenance (CMOM) Programs at Sanitary Sewer Collection Systems*. EPA 305-B-05-002.

U.S. Environmental Protection Agency. (2007a). *Fact Sheet: Draft NPDES Permit Requirements for Municipal Sanitary Sewer Collection Systems and SSOs*.

U.S. Environmental Protection Agency. (2007b). *Model NPDES Permit Language for Sanitary Sewer Overflows*.

U.S. Environmental Protection Agency. (2011). *Achieving Water Quality Through Integrated Municipal Stormwater and Wastewater Plans*. EPA Memorandum.

CHAPTER 14 – INSPECTING GREEN INFRASTRUCTURE CONTROLS

Contents

A. Introduction	310
Science of Green Infrastructure	310
Design and Inspection Preparation	311
Considerations on Inspection Timing	312
Types of Green Infrastructure Management Practices	313
B. Infiltration Controls	314
Description	314
Design of Infiltration Controls	316
Inspecting Infiltration Controls.....	317
Common Infiltration Control Issues	317
C. Permeable Pavement Controls	319
Description	319
Design of Permeable Pavements and Pavers	322
Inspecting Permeable Pavements	322
Common Permeable Pavement Issues.....	323
D. Rainwater Harvesting Systems	325
Description	325
Design of Rainwater Harvesting Systems.....	326
Inspecting Rainwater Harvesting Systems	329
Common Rainwater Harvesting Issues.....	329
E. Green Roofs.....	331
Description	331
Design of Green Roofs.....	332
Inspecting Green Roofs	334
Common Green Roof Issues	335
F. References.....	335

List of Tables

Table 14-1. Sample Design Management Practice Selection Matrix According to Site Characteristics (Source: Modified from Dorman et al., 2013).....	314
---	-----

List of Exhibits

Exhibit 14-1. Impacts of Urbanization (as impervious surfaces are added, less and less precipitation is absorbed, resulting in more runoff) (Source: EPA, 2005).....	311
Exhibit 14-2. Multiple Green Infrastructure Controls on a Developed Site (Source: Dorman et al., 2013)	313
Exhibit 14-3. Example Cross-section of Bioretention with Primary Design Elements (under-drain is optional) (Source: AHBL, 2012)	315
Exhibit 14-4. Example Primary Design Elements of a Bioretention Facility (Source: PGDER, 1999)	315
Exhibit 14-5. Example Pervious Concrete Cross-section (Source: EPA, 2009)	320
Exhibit 14-6. Example Porous Asphalt Cross-section (Source: EPA, 2009)	320
Exhibit 14-7. Example Permeable Paver Blocks Cross-section (Source: EPA, 2009).....	321
Exhibit 14-8. Grid Pavers—Concrete (left) and Plastic (right) (Credit: Tetra Tech)	321
Exhibit 14-9. Porous Asphalt Signage (Credit: Tetra Tech)	323
Exhibit 14-10. First Flush Diverter (Credit: NCSU BAE)	327
Exhibit 14-11. Roof Washer (Credit: NCSU BAE).....	328
Exhibit 14-12. Extensive Green Roof Illustration (Source: SEMCOG, 2008)	332

Associated Appendices

Z.	Infiltration Control Inspection Form
AA.	Permeable Pavements Inspection Form
AB.	Rainwater Harvest Inspection Form
AC.	Green Roof Inspection Form

A. INTRODUCTION

In addition to materials in this chapter, inspectors must be familiar with Chapter 1, “Introduction,” and Chapter 2, “Inspection Procedures.”

An increasing number of National Pollutant Discharge Elimination System (NPDES) permittees are implementing green infrastructure practices that mimic natural processes to infiltrate, evapotranspire, or use stormwater on or close to where it falls. This document is designed for United States Environmental Protection Agency (EPA), state, and local NPDES inspectors and provides background and suggested procedures for inspecting green infrastructure practices for proper installation, operation, and maintenance.

SCIENCE OF GREEN INFRASTRUCTURE

Green infrastructure systems are often designed using soil, vegetation and natural infiltration to more effectively manage urban stormwater and reduce impacts to receiving water. The hydraulic cycle is altered by the land use practices associated with human development, resulting in increased erosion and stream flooding during storms, reduced surface water base flow and interflow (shallow infiltration), groundwater recharge, and degraded water quality. Green infrastructure mimics pre-developed conditions by restoring the natural hydrology and enabling water to infiltrate instead of run off. This effects the timing of water release to rivers and streams, resulting in less flooding, and minimizing the quantity of water released into municipal separate storm sewer systems (MS4s) or combined sewer systems (CSSs). In the same way, green infrastructure can help reduce stormwater flow into combined sewer systems, thereby reducing combined sewer overflows and treatment requirements, which may result in fewer discharges of pollutants.

Green infrastructure can provide a wide variety of environmental, social, and economic benefits in addition to water quality improvements, including improved air quality, reduced urban heat island effect, reduced energy use, improved health, green jobs, recreational amenities, wildlife habitat, and increased property values. Green infrastructure is also an important tool for communities to increase their climate change resilience because it can help manage flooding, prepare for drought, and protect coasts by reducing coastal erosion and storm impacts.

Exhibit 14-1 depicts the impact of urbanization on water infiltration and evapotranspiration.

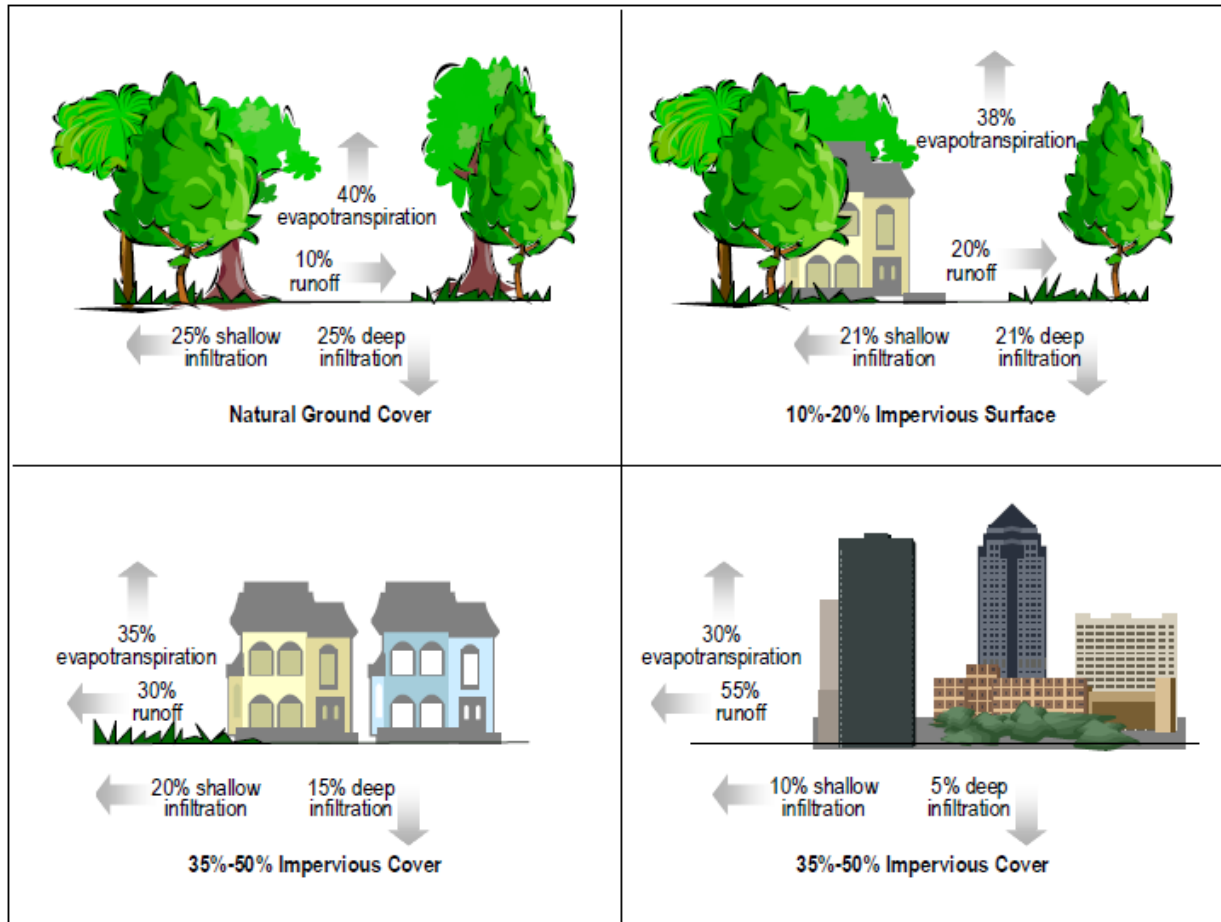

Exhibit 14-1. Impacts of Urbanization (as impervious surfaces are added, less and less precipitation is absorbed, resulting in more runoff) (Source: EPA, 2005)

Green infrastructure controls increase infiltration, filtration, storage, evaporation, transpiration, and rainwater capture and reuse. Green infrastructure can be used at varying landscape scales, including large regional treatment or watershed, as well as a neighborhood or small site in place of, or in addition to, more traditional stormwater controls. Small area stormwater infiltration practices (e.g., rain gardens, bioswales, infiltration planters, and tree plantings) can fit into individual site development or redevelopment sites, while larger area management strategies (e.g., riparian buffers, flood plain and wetland restoration, open space and forest preservation) systems are typically applied at the watershed level.

DESIGN AND INSPECTION PREPARATION

Design requirements for green infrastructure can vary by state and even by locality. Green infrastructure designs are based on a number of detailed design calculations and data (including geographic information system (GIS) data, modeling, soil tests, and other information). Also, many green infrastructure designs include significant components that are not easily visible to inspectors (e.g., soil media depth, underdrains). If as-built drawings are

available, they can be used to assess whether an inspected control still meets the approved design.

Inspection Preparation

To prepare for an inspection, inspectors should be familiar with the local requirements and design standards. Inspectors can review permits, legal agreements (e.g., consent agreements), state/local manuals for design specifications, operations and maintenance manuals, previous inspection reports, and enforcement orders. Though consent decrees and NPDES permits typically authorize the permit authority to access the subject facility, inspectors need to follow the entry procedures in this inspection manual.

On the day of the inspection, inspectors should bring inspection forms or checklists, site plans, maps, and a camera. In some cases, a soil probe to check soil compaction and composition may be useful. Document observations through photographs and using the appropriate inspection form or checklist. Additional information may be obtained from interviews of local residents and/or business owners (who may have observed how the green infrastructure control functions under various weather conditions).

The University of Minnesota has developed an online guidance (“Developing an Assessment Program,” a chapter in *Stormwater Treatment: Assessment and Maintenance*) to help inspectors assess the performance of and schedule maintenance for stormwater controls (Gulliver et al., 2010). This online manual can be found at <http://stormwaterbook.safl.umn.edu/>.

CONSIDERATIONS ON INSPECTION TIMING

When possible, inspectors should schedule green infrastructure inspections during the following timeframes to better observe performance:

During or immediately after a rain event. Conducting inspections during or right after a rain event (within 24 hours) will allow the inspector to view the green infrastructure control in operation, and make it easier to see if the control is functioning as designed. For example, inspections during a rain event allow an inspector to see where the stormwater flows and whether stormwater is bypassing controls. Most controls are designed to drain all stormwater within 24–72 hours, so standing water that has not drained three days after a rain event could indicate that maintenance is required for that infiltration control.

During spring, summer and fall. Spring, summer, and fall are probably the best times to inspect green infrastructure practices in most regions. Winter conditions can impact the vegetation in a green infrastructure control, which can look significantly different than during spring/summer. Also, snow cover in winter months in some areas can make inspecting green infrastructure controls very difficult.

After construction. Inspectors should be aware that vegetation in certain green infrastructure controls can take several years to become fully established. An inspection soon after installation is complete can allow an inspector to more easily see inlets, outlets and other

aspects of the control, but vegetation may be sparse while it becomes established. Therefore, depending on the control, it may be best to inspect green infrastructure practices multiple times, both soon after installation and once vegetation is well-established to get a full picture of how practices are performing.

TYPES OF GREEN INFRASTRUCTURE MANAGEMENT PRACTICES

This chapter details infiltration controls, permeable pavement controls, rainwater harvesting systems and green roofs, as these are the most common types of green infrastructure controls that an inspector would investigate. There are many other types of stormwater and green infrastructure controls that an inspector may see in the field, and the inspection techniques described in this chapter may be applied to many of these controls as well.

Many times, multiple controls are integrated into a site and designed synergistically. Exhibit 14-2 depicts a typical site plan with green infrastructure controls annotated.

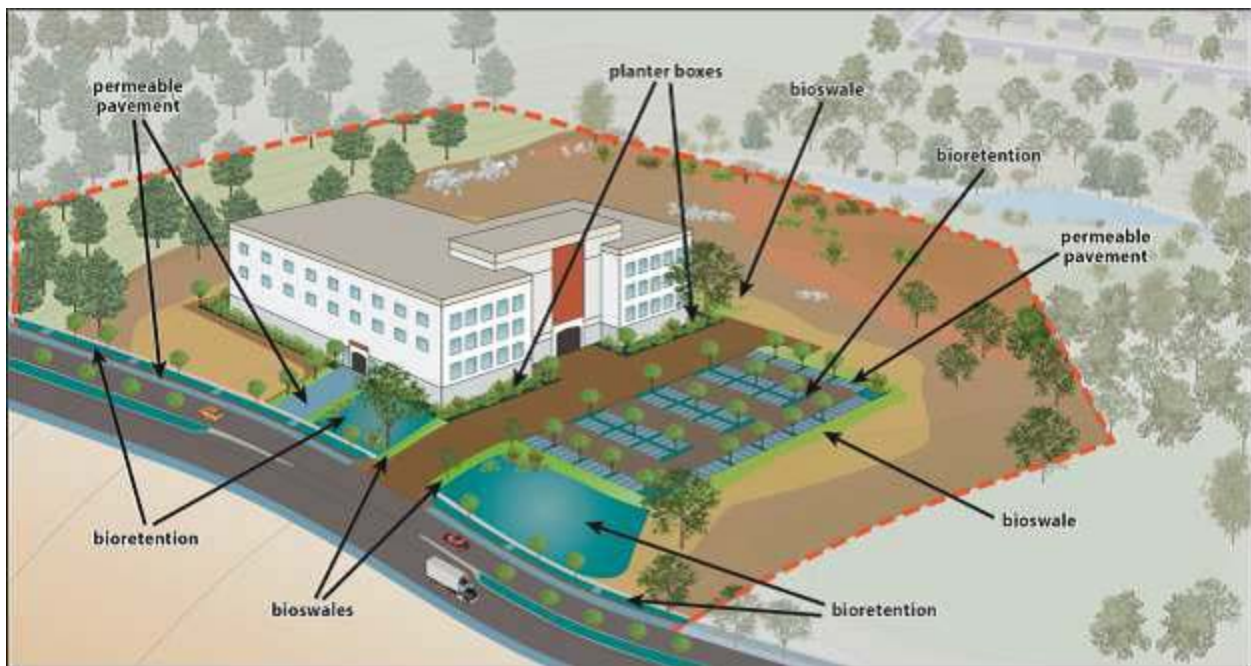

Exhibit 14-2. Multiple Green Infrastructure Controls on a Developed Site
(Source: Dorman et al., 2013)

To help educate inspectors on typical green infrastructure control performance, Table 14-1 provides a site selection matrix based on the desired function of the green infrastructure practice. It also includes pollutant reduction estimates and comparative costs.

Table 14-1. Sample Design Management Practice Selection Matrix According to Site Characteristics (Source: Modified from Dorman et al., 2013)

Attribute		Infiltration Control	Permeable Pavement	Rainwater Harvesting	Green Roof
Typical contributing drainage area (acres)		<5	varies	Rooftop	Rooftop
Practice slope		<2%	<2%	N/A	N/A
Pollutant Removal	Sediments	High	High	Pollutant removal provided by downstream BMP	Typically, water quality is not improved by green roofs (although volume reduction can reduce total loads).
	Nutrients	Medium	Low		
	Trash	High	High		
	Metals	High	High		
	Bacteria	High	Medium		
	Oil and Grease	High	Medium		
	Organics	High	Low		
Runoff volume reduction		High	High	Varies based on cistern size and water demand	High
Peak flow control		Medium	Medium		Medium
Construction costs		Low to medium	Medium to high	Low to medium	High
O&M costs		Low to medium	Medium	Low to medium	Low to medium

B. INFILTRATION CONTROLS

DESCRIPTION

Infiltration controls are engineered systems designed to use temporary surface and underground storage to capture and hold stormwater on-site for enough time to allow a designed stormwater volume to evapotranspire, percolate, and filter into the ground, reducing or eliminating surface runoff depending on the regulatory requirements at the site. Infiltration utilizing landscaped areas, including bioretention, rain gardens and bioswales, typically consists of a combination of some or all of the following elements: a flow-regulating structure (such as a level spreader that slows and spreads the flow out into a control), a pretreatment element (such as a vegetated filter strip), an engineered soil mix planting bed, vegetation, and an outflow-regulating structure. In some places, bioretention (Exhibit 14-3 and Exhibit 14-4) is defined as an engineered structure while rain gardens are simpler structures with no formal engineering and designed/installed by a homeowner. Infiltration controls are designed to hold water for a specific amount of time and remove many of the pollutants through a variety of chemical, physical and biological processes, in a manner similar to natural ecosystems.

Infiltration can occur at both large and small sites. In addition to providing temporary storage that delays the timing of stormwater to waterways, infiltration provides effective treatment/capture for such pollutants as sediments, nutrients, trash, metals, bacteria, oil and grease, and organics. Infiltration practices that include trees have the added benefits of greater

evapotranspiration and water uptake and reduction of energy demand by providing summer shade to buildings.

Infiltration systems are versatile stormwater management practices that can be readily adapted to parking lot islands; street medians; residential, commercial and industrial campus landscaping; and urban and suburban green spaces and corridors.

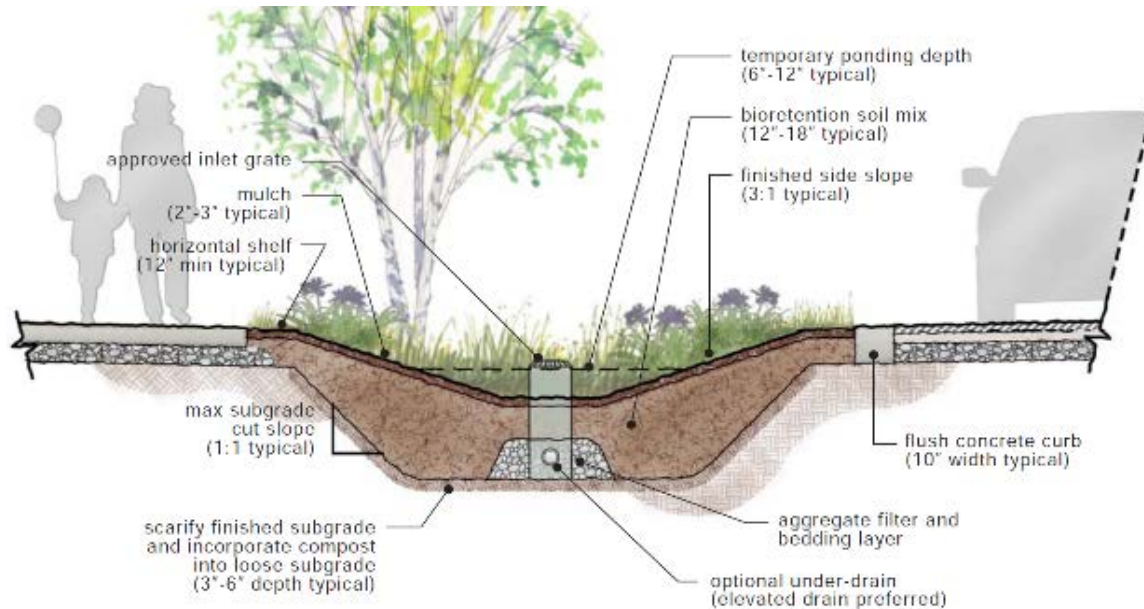

Exhibit 14-3. Example Cross-section of Bioretention with Primary Design Elements (under-drain is optional) (Source: AHBL, 2012)

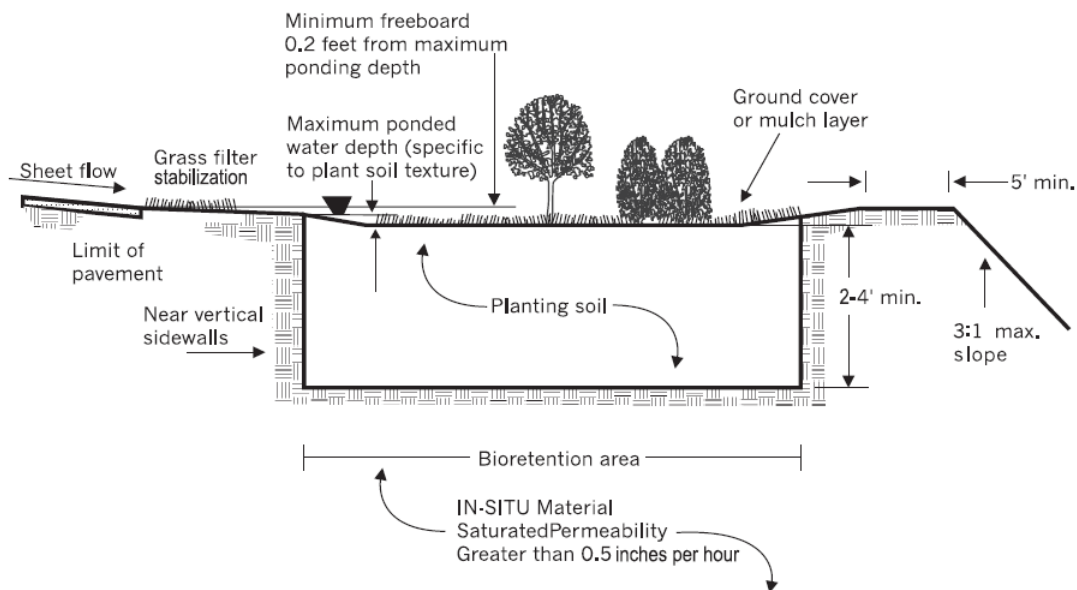

Exhibit 14-4. Example Primary Design Elements of a Bioretention Facility (Source: PGDER, 1999)

DESIGN OF INFILTRATION CONTROLS

Infiltration controls are designed to collect stormwater flows that temporarily collect on the surface in a ponding area. The stormwater then infiltrates or filters through a media layer where it either enters the subsurface soil over 24–72 hours, or is collected by an underdrain (perforated pipe below the media layer) for discharge to a storm drain or waterbody. Typical components of an infiltration control include:

Site applicability—Infiltration controls should generally be at least 10 feet away from any structure (e.g., buildings and parking lots), with a slope away from the structure.

Inlets—An inlet can consist of a curb cut, a flow spreading device such as a stone or gravel diaphragm that distributes stormwater runoff across the length of the control, a grass filter strip, or a similar device.

Outlet—An outlet can take many different forms, such as a riser structure or a curb cut/inlet that discharges stormwater once it exceeds the maximum ponding depth of the control. Controls can also be designed as a bypass system where flow does not enter the system once the maximum ponding depth is exceeded. It is important to review the site plans to determine if the controls are designed as a flow through or bypass system.

Pretreatment—To minimize clogging of the control device, infiltration controls need pretreatment, especially in drainage areas with excessive sediment (such as construction areas or unstabilized slopes). Pretreatment measures, if needed, can include sediment forebays, grass channels, level spreaders, or gravel diaphragms.

Soil media—Soil media mixes vary but generally include a mixture of largely course sand (~85 percent), fines (silt and clay ~10 percent), and organic media (~5 percent).

Vegetation—Infiltration controls can include a wide variety of suitable vegetation, from turf grass to shrubs or trees and should be based on the geographic location. Many jurisdictions recommend using hearty, drought-tolerant native plants to increase survival rates.

Underdrain—Consisting of perforated pipe beneath the media layer, underdrains convey excess stormwater that cannot be infiltrated into the soil within 24–72 hours, generally to the storm or combined sewer system or to a swale, stream or other surface water.

Mulch—Infiltration control designs often include specification for 1–2 inches of mulch to help retain soil moisture, provide a slow release of nutrients to plants, and shade out weed growth. Over mulching can “burn” vegetation and limit storage capacity.

Typical maintenance—The primary maintenance requirement for vegetated infiltration controls is regular plant, soil, and mulch layer maintenance to ensure a healthy vegetation system that promotes infiltration, storage, and pollutant removal. A healthy and densely vegetated system should be free of excess sediment and trash, and a typical system should drain within 72 hours after a storm event.

INSPECTING INFILTRATION CONTROLS

There are several issues that inspectors should look for when inspecting infiltration controls. These include:

Inlet—Improper grading at the inlet could impede flow to the control.

Vegetation/media/mulch—Controls that lack vegetation may indicate poor maintenance practices. Lack of mulch could allow erosion and too much mulch could inhibit plant growth.

Outlet—An outlet that is too low may allow the water to short-circuit the control and reduce its effectiveness.

Appendix Z, “Infiltration Control Inspection Form,” is a sample post-construction inspection form that could be used when inspecting infiltration controls. Inspections should include a review of any available operation logs and maintenance plans.

COMMON INFILTRATION CONTROL ISSUES

Common issues and challenges associated with infiltration controls include:

Poor design or placement of outlet



Photo 14-1. An infiltration basin may be poorly sited or poorly designed to the extent that it is unable to retain and infiltrate stormwater. In the photo above, the outlet is too low as evidenced by the scour path from the curb cut to the grate. This could indicate that sediment is being carried into the drain and that little water is being retained and absorbed. Possible solution: consider adding diffuser along scour path and/or raising the level of the grate. (Credit: EPA Region 5)

Management practice impeding function of infiltration control



Photo 14-2. Bioswale treated with herbicide accidentally. Vegetation is sparse, which may allow erosion. Consider reseeding or replanting and providing adequate signage in English and Spanish to ensure the practice is not continually treated with herbicide. (Credit: EPA Region 5)

Improper grading towards infiltration control



Photo 14-3. Inappropriate grading is another common design flaw in infiltration-based control practices. If a parking lot, street or other impervious surface is not properly graded *towards* the control or is *bypassing* the control, the BMP is not serving its intended purpose. In the photo above, the wet spot on the pavement indicates either poor grading in the installation or poor drainage by the control. Consider adjusting the grade. (Credit: EPA Region 5)

Outlet set too low



Photo 14-4. If the outlet is set too low, then stormwater will not pond and very little water will infiltrate, as it is designed to do. (Credit: John Kosco, Tetra Tech)

The City of Seattle has developed a *Green Stormwater Operations and Maintenance Manual* (Seattle, 2009) that provides photographs and level of service categories for different maintenance levels. These photographs and maintenance levels can educate inspectors on different infiltration control issues. Illustrated examples of problems associated with flow control structures can be found at https://www.seattle.gov/util/cs/groups/public/@spu/@usm/documents/webcontent/spu02_020023.pdf.

C. PERMEABLE PAVEMENT CONTROLS

DESCRIPTION

Permeable pavement combines stormwater infiltration, storage, and a structural pavement consisting of a permeable pavement layer underlain by a storage/infiltration bed. Permeable pavement has not been thoroughly tested on high speed roads in extreme weather conditions, although it has been successfully applied for low speed residential streets, parking lots, parking lanes and roadway shoulders (DDOE, 2013). The permeable pavement layer can consist of pervious concrete, porous asphalt, or various types of interlocking pavers, which are each summarized below (EPA, 2009):

Pervious concrete—Achieves porosity by reducing the number of fines in the mix, giving the concrete surface a much coarser appearance compared to standard impervious concrete.

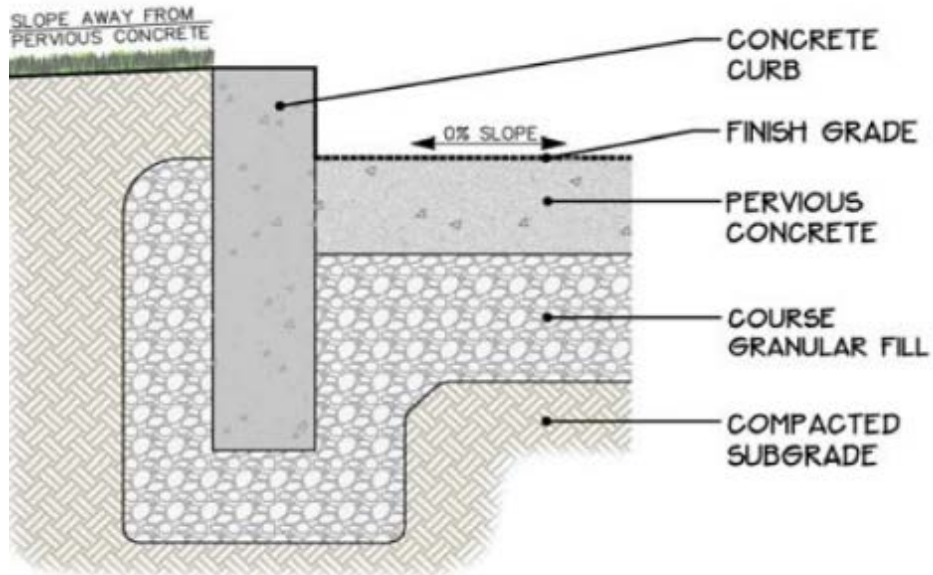

Exhibit 14-5. Example Pervious Concrete Cross-section (Source: EPA, 2009)

Porous asphalt—Like pervious concrete, achieves its porosity by eliminating the fine particles from its mix specification, allowing water to flow through it rather than over it.

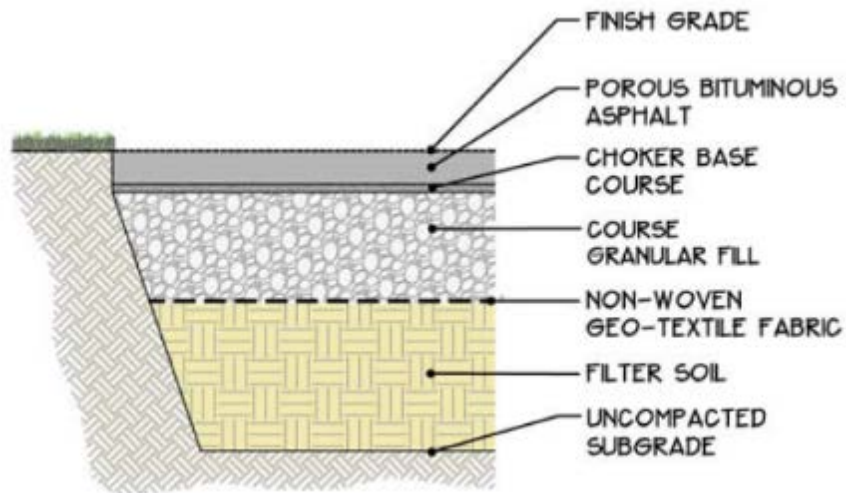

Exhibit 14-6. Example Porous Asphalt Cross-section (Source: EPA, 2009)

Permeable paver blocks—Manufactured units that interlock to create a durable pavement. Void spaces between units are filled with permeable materials such as pea gravel or sand to allow surface water to infiltrate.

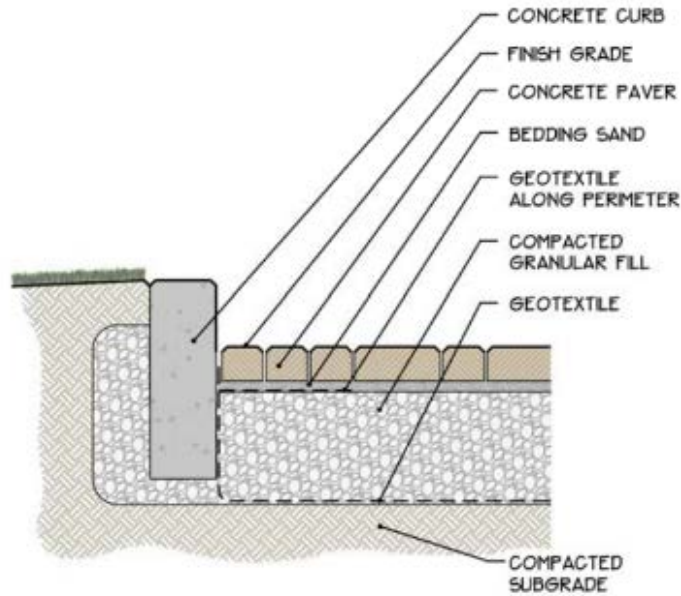

Exhibit 14-7. Example Permeable Paver Blocks Cross-section (Source: EPA, 2009)

Grid pavers—Concrete grid paver (CGP) systems are composed of concrete blocks made porous by eliminating finer particles in the concrete that creates voids inside the blocks; additionally, the blocks are arranged to create voids between blocks. Plastic turf reinforcing grids (PTRG) are plastic grids that add structural support to the topsoil and reduce compaction to maintain permeability. Grass is encouraged to grow in PTRG, so the roots will help improve permeability due to their root channels. Grid pavements provide a cool, green surface solution for vehicular access lanes, emergency access areas, and overflow parking areas, and even residential driveways.



Exhibit 14-8. Grid Pavers—Concrete (left) and Plastic (right) (Credit: Tetra Tech)

DESIGN OF PERMEABLE PAVEMENTS AND PAVERS

The design components of a typical permeable pavement are described below. Note that the specific design components can change based on the type of permeable pavement installed and the local design standard requirements:

Inflow/Surface materials

As described above, there are several different types of surface materials for permeable pavements, from pervious concrete to porous asphalt to grid pavers or paver blocks. Porous asphalt and concrete mixes are similar to their impervious counterparts, but do not include the finer grade particles. Interlocking pavers have openings that are filled with stone to create a porous surface. Permeable pavements can accept runoff from adjacent impervious surfaces, but the impervious area should not exceed three-to-five times the pervious area (some states limit even more or prohibit the impervious area that can discharge to permeable pavements).

Storage

In addition to distributing mechanical loads, coarse aggregate laid beneath porous surfaces is designed to store stormwater prior to infiltration into soils or discharging to a stormwater BMP. The aggregate is wrapped in a non-woven geotextile to prevent migration of soil into the storage bed and resultant clogging. In porous asphalt and porous paver applications, the storage bed also has a choker course of smaller aggregate to separate the storage bed from the surface course.

Infiltration/Outflow

Most of the stormwater that enters a permeable pavement system is infiltrated, however, these systems are often designed with an outflow to prevent flooding or standing water from larger storms. The outflow can be a perforated pipe system, or a positive outflow that consists of a stone buffer that connects to the stone sub-base under the permeable pavement and allows a path for excess water to flow out of the system.

INSPECTING PERMEABLE PAVEMENTS

The primary issue with permeable pavements and pavers is clogging, which can slow infiltration rates or even result in surface ponding. Permeable pavements should not receive runoff from disturbed or vegetated areas—the sediment can quickly clog the system.

Spills can be significant problems on permeable pavements because of the potential for groundwater contamination and the difficulty in cleaning up spills on permeable pavement (as opposed to cleaning up spills on impervious concrete or asphalt). Inspectors should always look for evidence of spills on or near permeable pavements.

Permeable pavements are designed to drain stormwater quickly—any standing water on a permeable pavement typically indicates a problem with the control. Also, permeable pavement should have signage (Exhibit 14-9) to ensure that maintenance staff do not spread chemicals and to help educate the public.



Exhibit 14-9. Porous Asphalt Signage (Credit: Tetra Tech)

Appendix AA provides a sample post-construction inspection form that could be used to inspect permeable pavement. Inspections should include a review of any available operation logs and maintenance plans.

COMMON PERMEABLE PAVEMENT ISSUES

Common issues and challenges associated with permeable pavements include:

Excess sediment on permeable pavement



Photo 14-5. Sediment from the impervious parking is entering the permeable pavement area. This photo also indicates improper grading, with the flow accumulating in one area. (Credit: Bill Hunt, NCSU)

Sediment accumulation between paver blocks

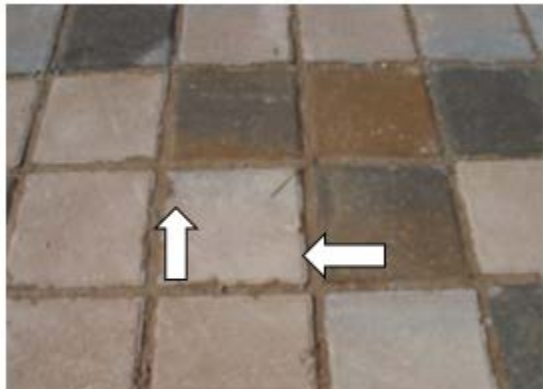

Photo 14-6. Fine mud and silt in between permeable pavers hindering rapid infiltration. (Credit: Bill Hunt, NCSU)

Excessive sediment on permeable pavement



Photo 14-7. Sediment on permeable pavement clogs void spaces thus slowing infiltration. Important to protect permeable pavement from construction stormwater run-off. (Credit: Bill Hunt, NCSU)

Sediment/poor grading



Photo 14-8. Visible silt on the permeable pavement surface, indicates that water is collecting before infiltrating. Maintenance, such as sweeping or vacuuming is needed. (Credit: EPA Region 5)

Vegetation between paver blocks



Photo 14-9. Weeds and moss between pavers may indicate a sediment problem. Herbicides should not be used on permeable pavement systems. (Credit: Bill Hunt, NCSU)

D. RAINWATER HARVESTING SYSTEMS

DESCRIPTION

Rainwater harvesting systems collect rainwater that falls on rooftops or other impervious surfaces and conveys it to above- or below-ground storage tanks, where it can be used between rain events as non-potable water for irrigation or other uses. This technology reduces potable water use while also reducing stormwater discharge off-site. Rain barrels are typically used in residential applications and connect to a rooftop downspout to collect rainwater for irrigation purposes. Cisterns are typically large containers or tanks that hold significantly more

stormwater volume than a rain barrel. Cisterns are more commonly used in commercial applications and can store stormwater for irrigation or a variety of other uses, including re-use inside the building.

Non-potable uses of harvested rainwater may include the following:

- Landscape irrigation
- Exterior washing (e.g., car washes, building facades, sidewalks, street sweepers, and fire trucks)
- Flushing of toilets and urinals
- Fire suppression (i.e., sprinkler systems)
- Supply for cooling towers, evaporative coolers, fluid coolers, and chillers
- Supplemental water for closed loop systems and steam boilers
- Replenishment of water features and water fountains
- Distribution to a green wall or living wall system
- Laundry

DESIGN OF RAINWATER HARVESTING SYSTEMS

There are seven primary design components of a rainwater harvesting system:

1. Contributing drainage area (CDA) or CDA surface
2. Collection and conveyance system (i.e., gutter and downspouts)
3. Pretreatment, including prescreening and first flush diverters
4. Storage system (cisterns)
5. Water quality treatment
6. Distribution systems
7. Overflow, filter path or secondary stormwater retention practice

Contributing Drainage Area (CDA) or CDA Surface

When considering CDA surfaces, note that smooth, non-porous materials will drain more efficiently. Slow drainage of the CDA leads to poor rinsing and a prolonged first flush, which can decrease water quality. Some roofing materials such as tar and gravel, asbestos shingle and treated cedar shakes may leach toxic chemicals and are not suitable CDA surfaces. Cedar shake and other wooden roofs are the least efficient surfaces in regards to rainwater harvesting because they are porous while metal roofs are the most efficient.

Collection and Conveyance System

The collection and conveyance system consists of the gutters, downspouts, and pipes that channel rainfall into cisterns. Gutters and downspouts should be designed as they would for a building without a rainwater harvesting system. Aluminum, round-bottom gutters and round

downspouts are generally recommended for rainwater harvesting. Gutters and downspouts should be kept clean and free of debris and rust.

Pretreatment

Pre-filtration is required to keep sediment, leaves, contaminants, and other debris from the system. Leaf screens and gutter guards are typically used for pre-filtration of small systems, although direct water filtration is preferred. The purpose of pre-filtration is to significantly cut down on maintenance by preventing organic buildup in the cistern, thereby decreasing microbial food sources.

Diverted flows (i.e., first flush diversion and/or overflow from the filter, if applicable) should be directed to an appropriate best management practice (BMP) or to a settling tank to remove sediment and pollutants prior to discharge from the site.

Various pretreatment devices are described below:

- **First Flush Diverters** direct the initial pulse of rainfall away from the cistern. While leaf screens effectively remove larger debris such as leaves, twigs, and blooms from harvested rainwater, first flush diverters can be used to remove smaller contaminants such as dust, pollen, and bird and rodent feces. First flush diverters are typically passive devices that retain a relatively small amount of stormwater that is first captured from the roof system before the remaining roof runoff is directed into the rainwater harvesting system.
- **Leaf screens** are mesh screens installed over either the gutter or downspout to separate leaves and other large debris from rooftop runoff. Leaf screens should be regularly cleaned to be effective; if not maintained, they can become clogged and prevent rainwater from flowing into the cisterns.



Exhibit 14-10. First Flush Diverter (Credit: NCSU BAE)

- **Roof washers** are placed just ahead of cisterns and are used to filter small debris from harvested rainwater. Roof washers consist of a cistern, usually between 25 and 50 gallons in size, with leaf strainers and a filter with openings as small as 30 microns. The filter functions to remove very small particulate matter from harvested rainwater. All roof washers should be cleaned on a regular basis.
- **Hydrodynamic Separator** can be used to filter rainwater from larger CDAs.



Exhibit 14-11. Roof Washer (Credit: NCSU BAE)

Storage System (Cisterns)

The cistern provides the storage for a rainwater harvesting system. Rain barrels typically hold about 55 gallons, but cistern capacities generally range from 250 to 30,000 gallons, but can be as large as 100,000 gallons or more for larger projects. Multiple cisterns can be placed adjacent to each other and connected with pipes to balance water levels and to tailor the storage volume needed. Typical rainwater harvesting system capacities for residential use range from 1,500 to 5,000 gallons. Cistern volumes are calculated to meet the water demand and stormwater storage volume retention objectives.

While the common cistern has a cylindrical shape, cisterns can be made of many materials and configured in various shapes, depending on the type used and the site conditions where the cisterns will be installed. For example, configurations can be rectangular, L-shaped, or step vertically to match the topography of a site.

Water Quality Treatment

Depending upon the collection surface, method of dispersal and proposed use for the harvested rainwater, a water quality treatment device may be necessary to clean the harvested rainwater.

Distribution Systems

Rain barrel systems and small cisterns can use a gravity fed distribution system. Most distribution systems for larger cisterns need a pump to convey harvested rainwater from the cistern to its final destination, whether inside the building, an automated irrigation system, or gradually discharged to a secondary stormwater treatment practice. The rainwater harvesting system should be equipped with an appropriately sized pump that produces sufficient pressure for all end-uses. A backflow preventer should be used to separate harvested rainwater from the main potable water distribution lines.

Overflow

An overflow mechanism is needed as a component of the rainwater harvesting system design to handle an individual storm event or multiple storms in succession that exceed the capacity of the cistern. Overflow pipe(s) should have a capacity equal to or greater than the inflow pipe(s) and have a diameter and slope sufficient to drain the cistern while maintaining an adequate freeboard height. The overflow pipe(s) should be screened to prevent access to the cistern by small mammals and birds. All overflows from the system should be directed to an acceptable flow path that will not cause erosion.

INSPECTING RAINWATER HARVESTING SYSTEMS

Inspectors should look for obvious defects with the rainwater harvesting system such as tanks that are leaking or cracked, inflow controls that are not working properly (such as downspouts not properly connected to the tank), and improper maintenance (including sediment in the tank or debris in the filters or screens).

If available, inspectors should also review maintenance and use records to determine if the rainwater harvesting system is being used properly. For example, is the system largely empty before large rain events? Is the water being used as soon as practical after rain events?

Appendix AB, “Rainwater Harvest Inspection Form,” provides a sample post-construction inspection form that could be used to inspect rainwater harvesting systems. Inspections should include a review of any available operation logs and maintenance plans.

COMMON RAINWATER HARVESTING ISSUES

Common issues and challenges associated with rainwater harvesting systems include:

Overflowing rain barrel



Overflowing rain barrel. Consider larger capacity cistern or higher volume overflow pipe. The overflow pipe may also be clogged. Overflow could cause water problems inside the adjacent building. (Credit: Innovative Water Solutions)

Improper maintenance of gutters



Gutters, which drain to cistern, in need of cleaning (Credit: Jason Wright, Tetra Tech)

Screen maintenance

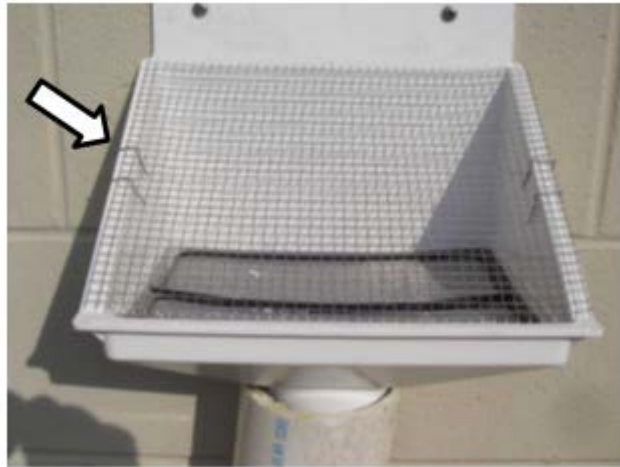

This screen is clear, but inspectors should check filters to determine if they are clogged (Credit: Tetra Tech)

Overflow devices is clogged or in need of repair



Check overflow features to determine if they are working (Credit: Tetra Tech)

E. GREEN ROOFS

DESCRIPTION

Green, living, or vegetated, roofs are alternative roof surfaces that typically consist of a layer of soil/media and vegetation over waterproofing and drainage materials on a conventional flat or pitched roof to absorb and retain water, like vegetation and soil on the ground.

Design variants include extensive and intensive green roofs. *Extensive* green roofs have a much shallower growing media layer that typically ranges from 3 to 6 inches thick. *Intensive* green

roofs have a growing media layer that ranges from 6 to 48 inches thick. Green roofs are typically not designed to provide stormwater detention of larger storms (e.g., 2-year, 15-year) although some intensive green roof systems may be designed to meet these criteria. Green roof designs may be combined with other green infrastructure practices elsewhere on-site to control large storms.

DESIGN OF GREEN ROOFS

Standard specifications for North American green roofs continue to evolve, and no universal material specifications exist that cover the wide range of available roof types and system components. The American Society for Testing and Materials (ASTM) has issued several overarching green roof standards, which should be consulted when assessing the design of green roofs. Designers and reviewers should also fully understand manufacturer specifications for each system component, particularly if they choose to install proprietary “complete” green roof systems or modules. Common components in a green roof are illustrated in Exhibit 14-12.

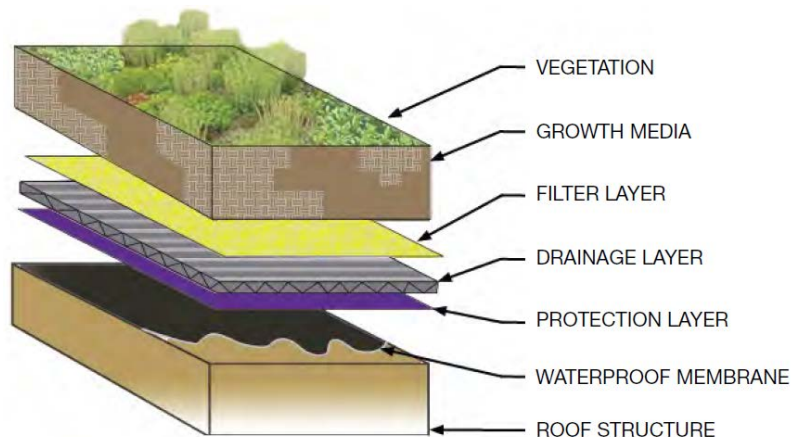

Exhibit 14-12. Extensive Green Roof Illustration (Source: SEMCOG, 2008)

Roof/Deck Layer

The roof deck layer is the foundation of a green roof. It may be composed of concrete, wood, metal, plastic, gypsum, or a composite material. The type of deck material determines the strength, load bearing capacity, longevity, and potential need for insulation in the green roof system.

Leak Detection System

The leak detection system is an optional system used to detect and locate leaks in the waterproof membrane. Leak detection systems are often installed above the deck layer to identify leaks, minimize leak damage through timely detection, and locate leak locations.

Waterproof Membrane

All green roof systems should include an effective and reliable waterproofing layer to prevent water damage through the deck layer. The membrane should be designed to convey water horizontally across the roof surface to drains or gutter and may also act as a root barrier. A wide range of waterproofing materials can be used, including hot applied rubberized asphalt,

built up bitumen, modified bitumen, thermoplastic membranes, polyvinyl chloride (PVC), thermoplastic olefin membrane (TPO), and elastomeric membranes (EPDM). The waterproofing layer needs to be 100 percent waterproof and have an expected life span as long as any other element of the green roof system. The waterproofing material may be loose laid or bonded (recommended). If loose laid, overlapping and additional construction techniques should be used to avoid water migration.

Insulation Layer

Many green roofs contain an insulation layer, usually located above, but sometimes below, the waterproofing layer. The insulation increases the energy efficiency of the building and/or protects the roof deck (particularly for metal roofs). According to *Green Roof Plants: A Resource and Planting Guide* (Snodgrass et al., 2006), the trend is to install insulation on the outside of the building, in part to avoid mildew problems. The designer should consider the use of open or closed cell insulation depending on whether the insulation layer is above or below the waterproofing layer (and thus exposed to wetness), with closed cell insulation recommended for use above the waterproofing layer.

Root Barrier

Another layer of a green roof system, which can be either above or below the insulation layer depending on the system, is a root barrier that protects the waterproofing membrane from root penetration. Chemical root barriers or physical root barriers that have been impregnated with pesticides, metals, or other chemicals that could leach into stormwater runoff, should be avoided in systems where the root barrier layer will contact water or allow water to pass through the barrier.

Drainage Layer

A drainage layer is then placed between the root barrier and the growing media to quickly remove excess water from the vegetation root zone. The selection and thickness of the drainage layer type is an important design decision that is governed by the desired stormwater storage capacity, the required conveyance capacity, and the structural capacity of the rooftop. Depth of the drainage layer is generally 0.25 to 1.5 inches thick for extensive designs. The drainage layer usually consists of synthetic or inorganic materials (e.g., gravel, high density polyethylene (HDPE)) that can retain water and provide efficient drainage. A wide range of prefabricated water cups or plastic modules can be used, as well as a traditional system of protected roof drains, conductors, and roof leaders.

Filter Fabric

A semi-permeable needled polypropylene filter fabric is normally placed between the drainage layer and the growing media to prevent the media from migrating into the drainage layer and clogging it. The filter fabric should not impede the downward migration of water into the drainage layer.

Growth Media

For an extensive green roof, the growing media is typically 3 to 6 inches deep (minimum 3 inches). The recommended growing media for extensive green roofs is typically composed of

approximately 70 to 80 percent lightweight inorganic materials, such as expanded slates, shales or clays; pumice; scoria; or other similar materials. The remaining media should contain no more than 30 percent organic matter. The percentage of organic matter should be limited, since it can leach nutrients into the runoff from the roof and clog the permeable filter fabric. Media should also provide sufficient nutrients and water holding capacity to support the proposed plant materials. The growing media typically has a maximum water retention of approximately 30 percent.

The composition of growing media for intensive green roofs may be different, and it is often much greater in depth (e.g., 6 to 48 inches). If trees are included in the green roof planting plan, the growing media should be sufficient to provide enough soil volume for the root structure of mature trees.

Plant Materials

The top layer of an extensive green roof typically consists of plants that are non-native, slow-growing, shallow-rooted, perennial, and succulent. These plants are chosen for their ability to withstand harsh conditions at the roof surface. A mix of base ground covers (usually Sedum species) and accent plants can be used to enhance the visual amenity value of a green roof. The design should provide for temporary, manual, and/or permanent irrigation or watering systems, depending on the green roof system and types of plants. For most application, some type of watering system should be accessible for initial establishment or drought periods. The use of water efficient designs and/or use of non-potable sources are strongly encouraged.

INSPECTING GREEN ROOFS

Inspectors of green roofs should look for the following issues:

- Dead or dying vegetation
- Roof drains, scuppers, and gutters are overgrown or have organic matter deposits
- Evidence of erosion or loss of media
- Standing water

Other issues with green roofs can be more difficult to assess on a typical NPDES inspection. For example, improper installation, excessive dead loads that exceed what the building can handle, root penetration and leaks can be difficult to detect without extensive knowledge of the approved design and construction. However, inspectors can review maintenance records, which may identify some of these issues.

Caution should be taken when inspecting green roofs that are sloped or are at high elevations. Necessary safety measures should be taken at all times.

Appendix AC, “Green Roof Inspection Form,” provides a sample post-construction inspection form that could be used to inspect green roofs. Inspections should include a review of any available operation logs and maintenance plans.

COMMON GREEN ROOF ISSUES

Common issues and challenges associated with green roofs include:

Poor vegetation on green roof



Roof in Florida with poorly maintained plants
(Credit: Kevin Songer)



Green roof with adequate vegetation (Credit: EPA Region 5)

F. REFERENCES

The following is a list of resources providing additional information on green infrastructure.

AHBL, Puget Sound Partnership, Washington State University Extension. (2012). *Low Impact Development: Technical Guidance Manual for Puget Sound*. Available at:

http://www.psp.wa.gov/downloads/LID/20121221_LIDmanual_FINAL_secure.pdf

City of Richmond Stormwater Utility. (1999). *Annual BMP Operation & Maintenance Inspection for Vegetated Roofs*. Available at:

http://www.richmondgov.com/DPU/DOCUMENTS/BMPQUANTITY_VEGETATED_ROOF_INSPECTION_CHECKLIST.PDF

City of Toronto. (2010). *Toronto Building Green Roof Inspection Report Checklist*. Available at: https://www1.toronto.ca/city_of_toronto/city_planning/zoning__environment/files/pdf/Green_Roof_Inspection_Report_Checklist.pdf

District Department of the Environment (DDOE). (2013). *2013 Stormwater Management Guidebook*. District of Columbia: Prepared by Center for Watershed Protection.

Dorman, T., M. Frey, J. Wright, B. Wardynski, J. Smith, B. Tucker, J. Riverson, A. Teague, and K. Bishop. (2013). *San Antonio River Basin Low Impact Development Technical Design Guidance Manual, Volume 1*. San Antonio, TX: San Antonio River Authority.

Gulliver, J.S., A.J. Erickson, and P.T. Weiss (editors). (2010). *Stormwater Treatment: Assessment and Maintenance*. Minneapolis, MN: University of Minnesota, St. Anthony Falls Laboratory.

Minnesota Pollution Control Agency (PCA). (Last modified 2015). *Green Roof Maintenance Inspection Checklist*. Available at: https://stormwater.pca.state.mn.us/index.php?title=Green_roof_maintenance_inspection_checklist

Prince George's County, Maryland Department of Environmental Resources (PGDER). (1999). *Low-Impact Development Design Strategies: An Integrated Design Approach*.

Seattle Public Utilities. (2009). *Green Stormwater Operations and Maintenance Manual*. Available at: https://www.seattle.gov/util/cs/groups/public/@spu/@usm/documents/webcontent/spu02_020023.pdf

Snodgrass, E.C. and L.L. Snodgrass. (2006). *Green Roof Plants: A Resource and Planting Guide*. Timber Press (1900).

Southeast Michigan Council of Governments (SEMCOG). (2008). *Low Impact Development Manual for Michigan: A Design Guide for Implementers and Reviewers*. Available at: <http://www.sem cog.org/desktopmodules/SEMCOG.Publications/GetFile.ashx?filename=LowImpactDevelopmentManualforMichiganSeptember2008.pdf>

U.S. Department of Agriculture (USDA). (2007). *Part 630 Hydrology: National Engineering Handbook, Chapter 7 Hydrologic Soil Groups*. USDA Natural Resources Conservation Service.

U.S. Department of Agriculture (USDA). (No Date). iTree Tools for Assessing and Managing Community Forests. Available at: <http://www.itreetools.org/>

U.S. Environmental Protection Agency. (1995). *Combined Sewer Overflows: Guidance for Long-Term Control Plan*. EPA 832-B-95-002. Office of Water.

U.S. Environmental Protection Agency. (2000). *Low-Impact Development Design Strategies: An Integrated Design Approach*. EPA 841-B-00-003.

- U.S. Environmental Protection Agency. (2005). *National Management Measures to Control Nonpoint Source Pollution from Urban Areas*. EPA-841-B-05-004. Office of Water, Nonpoint Source Control Branch.
- U.S. Environmental Protection Agency. (2007). *Reducing Stormwater Costs through Low Impact Development (LID) Strategies and Practices*. EPA 841-F-07-006. Office of Water, Nonpoint Source Control Branch.
- U.S. Environmental Protection Agency. (2009). *Green Streetscapes Study: Oakman Boulevard, Detroit, Michigan*. Office of Solid Waste and Emergency Response. Office of Brownfields and Land Revitalization.
- U.S. Environmental Protection Agency. (2013a). *Green Infrastructure Strategic Agenda 2013*.
- U.S. Environmental Protection Agency. (2013b). *Block-Scale Green Infrastructure Design for the Historic Northwest Quadrant, City of Beaufort*. 2012 Green Infrastructure Technical Assistance Program.
- U.S. Environmental Protection Agency. (2013c). *Stormwater to Street Trees – Engineering Urban Forests for Stormwater Management*. Office of Wetlands, Oceans and Watersheds. EPA 841-B-13-001.
- U.S. Environmental Protection Agency. (2014a). *Greening CSO Plans: Planning and Modeling Green Infrastructure for Combined Sewer Overflow Control*. Office of Water, Office of Research and Development, Office of Enforcement and Compliance Assurance, and Region 5. EPA 832-R-14-001.
- U.S. Environmental Protection Agency. (2014b). Green Infrastructure Website. Office of Water. Available at: <https://www.epa.gov/green-infrastructure>
- U.S. Environmental Protection Agency. (2014c). *Green Infrastructure for Climate Resiliency*. Office of Water.
- U.S. Environmental Protection Agency. (2015a). *Guidance for Reviewing Green Infrastructure Components in Development Project Plans: Plan Review Checklists*. 2014 Green Infrastructure Technical Assistance Program, City and County of Denver and Denver Urban Flood Control District.
- U.S. Environmental Protection Agency. (2015b). *Guidance for Inspecting and Maintaining Green Infrastructure Practices*. 2014 Green Infrastructure Technical Assistance Program, City and County of Denver and Denver Urban Flood Control District.
- Urban Drainage and Flood Control District (UDFCD). (2010). *Urban Storm Drainage Criteria Manual: Volume 3, Best Management Practices*. Denver, Colorado: Water Resources Publications, LLC.

CHAPTER 15– CAFO PROGRAM INSPECTIONS

Contents

A. Overview of NPDES CAFO Program	341
Introduction.....	341
Background and History of the CAFO Regulations	341
NPDES CAFO Permits.....	352
Operations Covered by Subpart C—Dairy Cows and Cattle Other than Veal Calves and by Subpart D—Swine, Poultry and Veal Calves.....	355
Best Professional Judgment (BPJ)	359
Other Technology-Based Limitations that Apply to Discharges from CAFOs.....	359
Water Quality-Based Effluent Limitations and Standards.....	360
Requirements for the Land Application Area of Permitted Large CAFOs	360
Monitoring, Recordkeeping, and Reporting Requirements of NPDES Permits for CAFOs	365
B. Preparing for the CAFO Or AFO Inspection	371
Selection of Facilities for Inspection.....	371
Compliance Determination Strategy	372
CAFO Inspector Responsibilities and Preparation Activities	374
CAFO Inspection Plan	386
C. The CAFO Inspection—Facility Tour	388
Arrival On-Site	388
Opening Conference.....	391
Record and On-Site Document Review	393
Facility Tour	394
D. The CAFO Inspection—Records Review and the NMP	411
Unpermitted Large CAFOs.....	411
Records for Permitted Large CAFOs	414
E. Closing Conference	424
F. After the CAFO or AFO Inspection	425
Communication With The CAFO Operator	426
G. References	428

List of Tables

Table 15-1. Large CAFOs	345
Table 15-2. Medium CAFOs	347
Table 15-3. Information Required on NPDES Application Forms 1 and 2B	352
Table 15-4. Effluent Limitation Summary	354
Table 15-5. Required Records for Permitted Large CAFOs	366
Table 15-6. Required Records for Permitted Small and Medium CAFOs.....	368
Table 15-7. Example Inspection Focus for Compliance Determination Strategy Based on Inspection Type.....	372
Table 15-8. Minimum Measures and Associated Records Applying to Unpermitted Large CAFOs.....	412
Table 15-9. Example Records and Potential Compliance Alerts Associated with NMP Minimum Measures i–v	416
Table 15-10. Example Records and Potential Compliance Alerts Associated with NMP Minimum Measures vi–viii	421

Associated Appendices

AD.	Animal Industry Overview
AE.	Management/Soil Science
AF.	Biosecurity SOP
AG.	Field and Personal Protective Equipment
AH.	Mapping Tool (Region 5)
AI.	Inspection Checklist
AJ.	Regional Inspection Checklists
AK.	Growth Stages of Field Crops
AL.	Inspection Introduction Letter
AM.	Sampling Procedures and Equipment
AN.	Sample Quality Assurance Project Plan (QAPP)
AO.	Detailed Review of Nutrient Management Plan Implementation
AP.	Inspection Report Template (R7)

A. OVERVIEW OF NPDES CAFO PROGRAM

INTRODUCTION

In addition to materials in this chapter, inspectors must be familiar with Chapter 1, “Introduction,” and Chapter 2, “Inspection Procedures.”

The National Pollutant Discharge Elimination System (NPDES) concentrated animal feeding operation (CAFO) inspector may encounter facilities with no NPDES permit, facilities with a state permit of some kind, and some facilities with NPDES permits. For facilities with NPDES permits, the inspector must be familiar with the requirements of a CAFO permit and know how to evaluate compliance. However, most facilities the inspector encounters will likely not have an NPDES permit.

Inspections of permitted and unpermitted CAFOs can have some similarities, but are generally very different. Throughout this chapter information relevant to each scenario is presented. If the facilities that you inspect do not have NPDES permits, you may want to focus most of your attention on the parts of the chapter dealing with unpermitted CAFOs. However, it is still important for all CAFO inspectors to have a working knowledge of NPDES CAFO permits.

BACKGROUND AND HISTORY OF THE CAFO REGULATIONS

EPA began regulating the discharges of wastewater and manure from CAFOs in the 1970s. In 2003, the Environmental Protection Agency (EPA) updated the original CAFO regulations to address changes in the animal agriculture industry sectors (Volume 68 of the *Federal Register* (FR) 7176). EPA subsequently published revisions to the CAFO Rule in 2008 to address a 2005 decision by the U.S. Court of Appeals (Waterkeeper Alliance et al. v. EPA, 2005) for the Second Circuit in litigation challenging the 2003 regulatory updates (73 FR 70418).

At the time of the 2003 revised regulations, EPA estimated that animal feeding operations (AFOs) annually produce more than 500 million tons of animal manure (U.S. DOA, 2007). The term manure as used here and throughout the Manual refers to manure, litter, and process wastewater. This manure can pose substantial risks to the environment and public health if managed improperly. EPA projected in 2003 that the revised rule would result in annual pollutant reductions of 56 million pounds of phosphorus (P), 110 million pounds of nitrogen (N), and two billion pounds of sediment.

Today, there are slightly more than one million farms with livestock in the United States.¹¹ EPA estimates that about 212,000 of those farms are likely to be AFOs—operations where animals are kept and raised in confinement. Although the number of AFOs has declined since 2003, the total number of animals housed at AFOs has continued to grow because of expansion and consolidation in the industry.

The NPDES regulations identify permitting requirements for AFOs that are classified as CAFOs and that discharge. If CAFOs do not seek NPDES permit coverage, discharges from their land

¹¹ The term manure as used here and throughout the Manual refers to manure, litter, and process wastewater.

application areas only qualify for the agricultural stormwater exemption if the CAFOs implement and document basic nutrient management practices; see Title 40 of the *Code of Federal Regulations* (CFR) Part 122.42(e)(1)(vi)–(ix). EPA generally expects that the nutrient management requirements are being followed when a CAFO has developed and is implementing a comprehensive nutrient management plan (CNMP) in accordance with the U.S. Department of Agriculture (USDA) guidance. For permitted CAFOs, nutrient management plans (NMPs) developed and implemented as a condition of an NPDES permit must be based on applicable technical standards for nutrient management established by the NPDES permitting authority (40 CFR 412.4(c)(2)).

Definition: Animal Feeding Operations (AFOs), Concentrated Animal Feeding Operations (CAFOs)

To determine if an animal facility falls under the purview of the NPDES program, it is essential to understand the definition of an AFO and a CAFO established in the regulations. This chapter reflects the current NPDES regulations and Effluent Limitation Guidelines (ELGs) applicable to CAFOs under the Clean Water Act (CWA), including revisions to the regulations that the U.S. Environmental Protection Agency (EPA) finalized and published in the *Federal Register* (FR) in 2008 (40 CFR 122.23; 73 FR 70418). As a result of a challenge to the 2008 and subsequent Fifth Circuit Court decision, EPA issued a “Compiled CAFO Final Rule” on July 30, 2012 to remove vacated elements and to consolidate the 2008 and 2003 final CAFO rules into a single document. Those requirements are collectively referred to in this chapter as *the CAFO regulations*.

This section explains the definitions of an AFO and CAFO, it describes how the NPDES regulations apply to permitted CAFOs and what those permits contain. In addition, the section explains aspects of the NPDES regulations that may apply to large CAFOs even if they do not have an NPDES permit.

When Congress passed the CWA in 1972, it specifically included the term *concentrated animal feeding operation* in the definition of *point source*. CWA section 502(14). Before EPA defined the CWA term *concentrated animal feeding operations* in the 1976 CAFO regulations, the 1974 ELGs for the Feedlots Point Source Category, formerly 40 CFR 412.11(b), defined a *feedlot* to mean “a concentrated, confined animal or poultry growing operation for meat, milk or egg production, or stabling, in pens or houses wherein the animals or poultry are fed at the place of confinement and crop or forage growth or production is not sustained in the area of confinement.” Similarly, the support documentation for the ELG (see, for example, EPA’s *Development Document for the Final Revisions to the National Pollutant Discharge Elimination System Regulation and the Effluent Guidelines for Concentrated Animal Feeding Operation* (EPA, 2002)) distinguished between animals grown in feedlots and those grown in non-feedlot situations. The development document defines feedlot using the following three conditions:

7. A high concentration of animals held in a small area for periods in conjunction with one of the following purposes:
 - a. Production of meat.
 - b. Production of milk.

- c. Production of eggs.
 - d. Production of breeding stock.
 - e. Stabling of horses.
8. The transportation of feed to animals for consumption.
9. By virtue of the confinement of animals or poultry, the land or area will neither sustain vegetation nor be available for crop or forage.

The 1976 rule defined which facilities were CAFOs, and therefore point sources under the CWA, and established permitting requirements for CAFOs. EPA's 1976 definition of CAFO draws on the definition of a CAFO from the 1974 feedlot definition. Although the definition of the term CAFO was further revised in the 2003 CAFO regulations, the types of facilities covered by the definition are nearly identical to those in the original definition of a feedlot.

A facility must first meet the definition of an AFO before it can be considered a CAFO. AFOs are defined as, "operations where animals have been, are, or will be stabled or confined and fed or maintained for a total of 45 days or more in any 12-month period and where vegetation is not sustained in the confinement area during the normal growing season." 40 CFR 122.23(b)(1). EPA interprets *maintained* to mean that the animals are confined in the same area where waste is generated or concentrated. Areas where animals are maintained can include areas where animals are fed and areas where they are watered, cleaned, groomed, milked, or medicated.

Regulatory Citation

Animal feeding operation (AFO) means a lot or facility (other than an aquatic animal production facility) where the following conditions are met:

Animals have been, are or will be stabled or confined and fed or maintained for a total of 45 days or more in any 12-month period.

AND

Crops, vegetation, forage growth, or post-harvest residues are not sustained in the normal growing season over any portion of the lot or facility.

40 CFR 122.23(b)(1)

The first part of the regulatory definition of an AFO means that animals must be kept on the lot or facility for a minimum of 45 days in a 12-month period. If an animal is confined for any portion of a day, it is considered to be on the facility for a full day. For example, dairy cows that are brought in from pasture for less than an hour to be milked are counted as being confined (i.e., on the lot or facility) for the day. In addition, the same animals are not required to remain on the lot for 45 days or more for the operation to be defined as an AFO. Rather, the first part of the regulatory definition is met if some animals are fed or maintained on the lot or facility for 45 days out of any 12-month period. The 45 days do not have to be consecutive, and the 12-month period does not have to correspond to the calendar year. For example, June 1 to the following May 31 would constitute a 12-month period. Therefore, animal operations such as stockyards, fairgrounds, and auction houses where animals may not be fed, but are confined temporarily, may be AFOs.

Definition: “Sustained in the normal growing season”

The second part of the regulatory definition of an AFO distinguishes confinement areas from pasture or grazing land. That part of the definition relates to the portion of the facility where animals are confined and where natural forage or planted vegetation does not occur during the normal growing season. Confinement areas might have some vegetative growth along the edges while animals are present or during months when animals are kept elsewhere. If a facility maintains animals in an area without vegetation, such as dirt lots with incidental vegetative growth, the facility meets the second part of the AFO definition.

True pasture and rangeland operations are not considered AFOs because animals at those operations are generally maintained in areas that sustain crops or forage growth during the normal growing season. In some pasture-based operations, animals can freely wander in and out of areas for food or shelter; that is not considered confinement. In general, an area is a pasture if vegetation is maintained during the normal growing season. However, pasture and grazing-based operations can also have confinement areas (e.g., feedlots, barns, milking parlors, pens) that meet the definition of an AFO.

Incidental vegetation in a clear area of confinement would not exclude an operation from meeting the definition of an AFO. In the case of a winter feedlot, the second part of the AFO definition (i.e., no vegetation) is meant to be evaluated during the winter, when the animals are confined. Animals from a grazing operation can be confined during winter months in a confinement area that had vegetation during other parts of the year. If the animals are confined for more than 45 days but not year-round and vegetation emerges in the spring when animals are removed, the presence of vegetation does not prevent that feedlot from being defined as an AFO because the vegetation is growing when animals are not present. In that example, the feedlot will not sustain the vegetation that had emerged in spring once the animals are moved back into the feedlot. Therefore, the facility in the example meets the definition of an AFO. See Chapter 2 of EPA’s *NPDES Permit Writers’ Manual for CAFOs* (EPA, 2012a) for more information and examples of animal feeding operations.

Definition: Concentrated Animal Feeding Operations (CAFOs)

An AFO is a CAFO if it meets the regulatory definition of a large or medium CAFO (40 CFR 122.23 (b)(4) or (6)) or has been designated as a CAFO (40 CFR 122.23(c)) by the NPDES permitting authority or by EPA. Note that some authorized states have adopted regulatory definitions for CAFOs that are more inclusive and, therefore, broader in scope than EPA’s regulations. Those facilities are subject to requirements under state law but not under federal law. See Chapter 2 of EPA’s *NPDES Permit Writers’ Manual for CAFOs* (EPA, 2012a) for more information and examples of concentrated animal feeding operations.

Types of Animal Operations Covered by CAFO Regulations

The CAFO regulations define a large CAFO based on the number of animals confined. Medium CAFOs are defined as meeting specific criteria in addition to the number of animals confined, and those criteria are discussed below. The animal types with specific threshold numbers for the Large and Medium size categories identified in the regulations are cattle, dairy cows, veal calves, swine, chickens, turkeys, ducks, horses, and sheep. An AFO that meets the small or

medium size thresholds can be designated as a CAFO by the permitting authority if certain criteria are met, including that the AFO is determined to be “a significant contributor of pollutants to waters of the United States” (40 CFR 122.23(c)).

Animal Types Not Listed in CAFO Regulations

An operation confining any animal type (e.g., geese, emus, ostriches, bison, mink, alligators) not explicitly mentioned in the NPDES regulations and for which there are no ELGs is subject to NPDES permitting requirements for CAFOs if 1) it meets the definition of an AFO, and 2) if the permitting authority designates it as a CAFO.

AFOs Defined as Large CAFOs

An AFO is a large CAFO if it stables or confines equal to or more than the number of animals specified in Table 15-1 for 45 days or more in a 12-month period. The definition of a large CAFO is based solely on the number of animals confined.

Table 15-1. Large CAFOs

Number of Animals	Type of Animal
700	Mature dairy cows, whether milked or dry
1,000	Veal calves
1,000	Cattle, other than mature dairy cows or veal calves (Cattle includes but is not limited to heifers, steers, bulls and cow/calf pairs.)
2,500	Swine, each weighing 55 pounds or more
10,000	Swine, each weighing less than 55 pounds
500	Horses
10,000	Sheep or lambs
55,000	Turkeys
30,000	Laying hens or broilers, if the AFO uses a liquid-manure handling system
125,000	Chickens (other than laying hens), if the AFO uses other than a liquid-manure handling system
82,000	Laying hens, if the AFO uses other than a liquid-manure handling system
30,000	Ducks, if the AFO uses other than a liquid-manure handling system
5,000	Ducks, if the AFO uses a liquid-manure handling system

Source: 40 CFR 122.23(b)(4)

In determining whether the applicable Large CAFO threshold is satisfied, the number of animals actually maintained is considered, not the capacity of the operation.

Practices Constituting Liquid-Manure Handling at Poultry Operations

The thresholds for chicken and duck AFOs in the CAFO definitions are based on the type of litter or manure handling system being used. The two systems are either a *liquid-manure handling system* or *other-than-a-liquid-manure handling system*. The animal number thresholds that determine whether the system is a CAFO for a chicken or duck AFO using a liquid-manure handling system are lower than the thresholds for CAFOs that use other-than-liquid-manure handling systems.

An AFO is considered to have a liquid-manure handling system if it uses pits, lagoons, flush systems (usually combined with lagoons), or holding ponds, or has systems such as continuous overflow watering, where the water contacts manure and litter. In addition, operations that stack or pile manure in areas exposed to precipitation are considered to have liquid-manure handling systems. That includes operations that remove litter from the confinement area and stockpile or store it uncovered in remote locations for even one day.

However, permitting authorities may authorize some limited period of temporary storage of litter of no more than 15 days that would not result in the facility meeting the definition of a liquid-manure handling system (e.g., where time is needed to allow for contract hauling arrangements and precipitation does not occur) (EPA, 2003). If litter is stockpiled beyond that temporary period, the uncovered stockpile would constitute a liquid-manure handling system, and the lower CAFO thresholds for chickens and ducks would apply (see Table 15-1 and Table 15-2).

Wet Lot and Dry Lot Duck Operations

Duck operations are considered to use a liquid-manure handling system if 1) the ducks are raised outside with swimming areas or ponds or with a stream running through an open lot, or 2) the ducks are raised in confinement buildings where fresh or recycled water is used to flush the manure to a lagoon, pond, or other storage structure. In addition, a duck operation that stacks manure or litter as described above for other dry poultry operations is considered to have a liquid-manure handling system.

Dry-lot duck operations include those that 1) use confinement buildings and handle manure and litter exclusively as dry material; 2) use a building with a mesh or slatted floor over a concrete pit from which manure is scraped into a solid manure storage structure; or 3) use dry bedding on a solid floor. Dry-lot duck operations are generally considered to be “operations that use other than a liquid-manure handling system.”

Definition: Production Area

Production area means that part of an AFO that includes the animal confinement area, the manure storage area, the raw materials storage area, and the waste containment areas. The animal confinement area includes but is not limited to open lots, housed lots, feedlots, confinement houses, stall barns, free stall barns, milk rooms, milking centers, cow yards, barnyards, medication pens, walkers, animal walkways, and stables. The manure storage area includes but is not limited to lagoons, run-off ponds, storage sheds, stockpiles, under house or pit storages, liquid impoundments, static piles, and composting piles. The raw materials storage area includes but is not limited to feed silos, silage bunkers, and bedding materials. The waste containment area includes but is not limited to settling basins, and areas within berms and diversions, which separate uncontaminated stormwater. Also included in the definition of production area is any egg-washing or egg-processing facility, and any area used in the storage, handling, treatment, or disposal of mortalities (40 CFR 122.23(b)(8)).

Definition: Land Application Area

The land application area means all land under the control of the CAFO owner or operator, including where the CAFO owns, rents, or leases the land to which manure from the production area is applied (40 CFR 122.23(e)(3)). It includes situations where a CAFO determines when and how much manure is applied to fields not owned, rented, or leased by the CAFO.

Definition: Process Wastewater

Process wastewater means water directly or indirectly used in the operation of the AFO for any or all of the following: spillage or overflow from animal or poultry watering systems; washing, cleaning, or flushing pens, barns, manure pits, or other AFO facilities; direct contact swimming, washing, or spray cooling of animals; or dust control. Process wastewater also includes any water that contacts any raw materials, products, or byproducts, including manure, litter, feed, milk, eggs, or bedding (40 CFR 122.23(b)(7)).

AFOs that Are Medium CAFOs

An AFO is a medium CAFO if it meets both parts of a two-part definition. The first part addresses the number of animals confined, and the second part includes specific discharge criteria. In addition, a medium-sized AFO can be designated a CAFO by the permitting authority or EPA. Table 15-2 lists the animal number ranges associated with the medium CAFO definition. If an AFO confines the number of animals listed in Table 15-2 for 45 days or more in a 12-month period, it meets the first part of the definition of a medium CAFO.

An AFO meets the discharge criteria for the second part of the medium CAFO definition if pollutants are discharged in one of the following ways:

- Into waters of the United States through a man-made ditch, flushing system, or another similar man-made device.
- Directly into waters of the United States that originate outside the facility and pass over, across, or through the facility or otherwise come into direct contact with the confined animals.

If the inspector identifies an unpermitted facility that is a medium CAFO, that CAFO is, by definition, discharging to a water of the United States and must either apply for an NPDES permit or permanently eliminate the source of the discharge (40 CFR 122.23(b)(6)).

Table 15-2. Medium CAFOs

Number of Animals	Type of Animal
200–699	Mature dairy cows, whether milked or dry
300–999	Veal calves
300–999	Cattle, other than mature dairy cows or veal calves (Cattle includes but is not limited to heifers, steers, bulls and cow/calf pairs.)
7502,499	Swine, each weighing 55 pounds or more

Table 15-2. Medium CAFOs

Number of Animals	Type of Animal
3,000–9,999	Swine, each weighing less than 55 pounds
150–499	Horses
3,000–9,999	Sheep or lambs
16,500–54,999	Turkeys
9,000–29,999	Laying hens or broilers, if the AFO uses a liquid-manure handling system
37,500–124,999	Chickens (other than laying hens), if the AFO uses other than a liquid-manure handling system
25,000–81,999	Laying hens, if the AFO uses other than a liquid-manure handling system
10,000–29,999	Ducks, if the AFO uses other than a liquid-manure handling system
1,500–4,999	Ducks, if the AFO uses a liquid-manure handling system

Source: 40 CFR 122.23(b)(6).

Definition: Man-Made Devices

The term *man-made device* means a conveyance constructed or caused by humans that transports wastes (manure, litter, or process wastewater) to waters of the United States (EPA, 1995). Man-made devices include, for example, pipes, ditches, and channels. If human action was involved in creating the conveyance, it is man-made even if natural materials were used to form it. A man-made channel or ditch that was not created specifically to carry animal wastes but nonetheless does so is considered a man-made device. To be defined as a medium CAFO, there must be an actual discharge of pollutants to waters of the United States. However, it is not necessary for the man-made device to extend the entire distance to waters of the United States. It is sufficient that the wastes being discharged flow through the man-made device. For example, a culvert could simply facilitate the flow of wastewater from one side of a road to another (and subsequently into a water of the United States) and is a man-made device for the purposes of this provision. Also, a flushing system is a man-made device that uses fresh or recycled water to move manure from the point of deposition or collection to another location.

Tile drains in the production area are another example of a man-made device. Tile drains are underground pipes that collect subsurface water for transport away from the site. If tile drains discharge manure to waters of the United States from the production area of a medium-sized AFO, the facility meets the discharge criterion for the medium CAFO definition and is a medium CAFO. An additional example would be the discharge to waters of the United States from a continuous-flow-through water trough system.

The medium CAFO definition addresses discharges directly into a water of the United States, which originate outside the facility and pass over, across, or through the facility or otherwise come into direct contact with the confined animals. The discharge criterion is met if animals in confinement at an AFO can come into direct contact with waters of the United States. Thus, a stream running through the area where animals are confined indicates that there is a direct

discharge of pollutants unless animals are prevented from any direct contact with waters of the United States.

Operations under Common Ownership

Under the CAFO regulations, two or more AFOs under common ownership are considered one operation if, among other things, they adjoin each other (including facilities that are separated only by a right-of-way or a public road) or if they use a common area or system for managing wastes (40 CFR 122.23(b)(2)). For example, operations generally meet the criterion where manure, litter, or process wastewater are commingled (e.g., stored in the same pond, lagoon, or pile) or are applied to the same cropland.

In determining whether two or more AFOs are under common ownership, the number of managers is not important. Two AFOs could be managed by different people but have a common owner (e.g., the same family or business entity owns both). For facilities under common ownership that either adjoin each other or use a common area or system for waste disposal, the cumulative number of animals confined is used to determine if the combined operation is a large CAFO and is used in conjunction with the discharge criteria to determine if the combined operation is a medium CAFO.

Operations with Multiple Animal Types

Under the CAFO regulations, multiple types of animals are not counted together to determine the type and size of a CAFO. However, once an operation is defined as a CAFO based on a single animal type, all the manure generated by all animals confined at the operation is subject to NPDES requirements. If wastestreams from multiple livestock species subject to different regulatory requirements are commingled at a CAFO, any NPDES permit for the facility must include the more stringent ELG requirements (2003 CAFO Rule—68 FR 7176 and 7195). In situations where immature animals (e.g., heifers and swine weighing less than 55 lbs.) are confined along with mature animals, the determination of whether the operation is defined as a CAFO depends on whether the mature or immature animals separately meet the applicable threshold. Operations that specialize in raising only immature animals (heifers, swine weighing less than 55 lbs., and veal calves) have specific thresholds under the regulations. However, once an AFO is defined as a CAFO, manure generated by all the animals in confinement would be addressed by the CAFO's NPDES permit if it is a permitted CAFO.

An operation that confines multiple animal types, where no one type meets the large or medium CAFO threshold, can be designated as a CAFO if it is found to be a significant contributor of pollutants to waters of the United States.

AFOs Designated as CAFOs

The CAFO regulations set the standards for the Director (either the Regional Administrator or the NPDES permitting authority) to designate any AFO as a CAFO if the AFO is a significant contributor of pollutants to waters of the United States (40 CFR 122.23(c)). The Director may designate any AFO as a CAFO on a case-by-case basis if he determines that the AFO is a significant contributor of pollutants to waters of the United States as specified in 40 CFR 122.23(c). AFO operations that may be considered for designation include the following:

- A medium-sized AFO that is not defined as a CAFO and is determined to be a significant contributor of pollutants to waters of the United States.
- A small AFO (i.e., confines fewer than the number of animals defined in Table 15-2) that meets one of the methods of discharge criteria in 40 CFR 122.23(c)(3)(i) and (ii) and is determined to be a significant contributor of pollutants to waters of the United States.
- An AFO that raises animals other than species identified in the regulatory definitions of large and medium CAFOs and is determined to be a significant contributor of pollutants to waters of the United States. Examples of such AFOs include geese, emus, ostriches, llamas, minks, bison, and alligators.

For an AFO to be designated as a CAFO, the Director must determine that the AFO is a significant contributor of pollutants to waters of the United States (40 CFR 122.23(c)). Once an operation is designated as a CAFO, it must seek coverage under an NPDES permit and, among other things, develop and implement an NMP.

Under the regulations at 40 CFR 122.23(c)(3), an AFO may not be designated as a CAFO until the NPDES permitting authority or EPA has determined that the operation should and could be regulated under the permit program and has conducted an inspection of the operation. In addition, a small AFO may not be designated as a CAFO unless it also meets the small AFO discharge criteria (40 CFR 122.23(c)(3)(i) and (ii)) and is determined to be a significant contributor of pollutants to waters of the United States.

CAFO Program as it Applies to Unpermitted CAFOs

When inspecting unpermitted facilities, the inspector should gather information to determine if the facility is a CAFO.¹² For a CAFO with no NPDES permit, any discharge of pollutants from a CAFO's production area to a water of the United States is a violation of the CWA, as is any discharge from the CAFO's land application areas that is not agricultural stormwater.

By definition, medium CAFOs and designated small CAFOs have discharges of pollutants to waters of the United States. These facilities must apply for an NPDES permit or eliminate the cause of the discharge.

Large Unpermitted CAFOs and the Agricultural Stormwater Exemption

Large unpermitted CAFOs may or may not have discharges to waters of the United States. If a large CAFO currently has or had in the past, discharges of pollutants from its production area to a water of the United States, those discharges are in violation of the CWA. Again, the large CAFO will need to apply for a permit or permanently remedy the cause of the discharge.

Section 502(14) of the CWA excludes from the definition of a point source **agricultural stormwater discharges**. A precipitation-related discharge of manure, litter, or process wastewater to waters of the United States from land application areas under the control of a

¹² Note that throughout this chapter, "unpermitted CAFO" refers to a CAFO without a Clean Water Act NPDES permit. This includes CAFOs that have a permit issued pursuant to state law that is not considered to be an NPDES permit.

Large **unpermitted** CAFO is a violation of the CWA **except** under certain conditions. The land application area means all land under the control of the CAFO owner or operator, including where the CAFO owns, rents, or leases the land to which manure from the production area is applied (40 CFR 122.23(e)(3)). It includes situations where a CAFO determines when and how much manure is applied to fields not owned, rented, or leased by the CAFO.

For a Large unpermitted CAFO's discharge to meet the definition of agricultural stormwater, the CAFO must land apply its manure in accordance with site-specific nutrient management practices that ensure appropriate agricultural utilization of the nutrients in the manure, litter, or process wastewater, as specified in Part 122.42(e)(1)(vi) through (ix). See Chapter 4 of EPA's *NPDES Permit Writers' Manual for CAFOs* (EPA, 2012a) for more information on the agricultural stormwater exemption.

The regulations at 40 CFR 122.42 (e)(1)(vi) through (ix) require the unpermitted large CAFO to:

- Implement appropriate site-specific conservation practices, including as appropriate buffers or equivalent practices, to control runoff of pollutants to waters of the United States.
- Follow protocols for appropriate testing of manure, litter, process wastewater, and soil.
- Follow protocols to land apply manure, litter or process wastewater in accordance with site-specific nutrient management practices that ensure appropriate agricultural utilization of the nutrients in the manure, litter or process wastewater.
- Maintain specific records that document the implementation and management of the minimum elements described above.

Inspectors should evaluate the protocols and practices implemented by the unpermitted large CAFO against all applicable state technical standards that are part of the authorized state NPDES program pursuant to 40 CFR 123.36. State technical standards may include sampling and analysis methods, prohibitions on land application during certain times of the year, or on frozen or saturated soils, etc. See Chapter 6 of the *NPDES Permit Writers' Manual for CAFOs* (EPA, 2012a) for more information on technical standards. Finally, the unpermitted large CAFO must maintain documentation of its manure land application practices either on-site or at a nearby office, and make these records available to the inspector upon request (40 CFR 122.42(e)(1)(ix)).

If a Large unpermitted CAFO does not meet these requirements it is not covered by the agriculture stormwater exemption and discharges to waters of the United States from the land application area are in violation of the Clean Water Act. Discharges occurring during dry weather can never be exempt as agricultural stormwater.

Large unpermitted CAFOs may have additional discharges not specifically addressed in the ELG or CAFO regulations, either from the production area or from outside the production area. They are also subject to industrial stormwater permitting requirements of 40 CFR 122.26. Large CAFOs, as defined in 40 CFR 122.23 and 412 are included in category (i) of facilities considered

to be engaging in industrial activity under 40 CFR 122.26 (b)(14). As a result, large CAFOs are subject to the requirements of 40 CFR 122.26 regardless of whether they are a permitted facility under 40 CFR 122.23. The requirements of 40 CFR 122.26 apply to any stormwater discharge from a large CAFO that is associated with industrial activity at a large CAFO that is not otherwise regulated under 40 CFR 122.23 and 412. CAFOs that are permitted to discharge pursuant to 40 CFR 122.23 and 122.26 may have both sets of requirements included in a single permit or in separate wastewater and stormwater permits. CAFOs subject to industrial stormwater requirements may qualify for the conditional exclusion provided in 40 CFR 122.26(g) for no exposure certifications for stormwater discharges. CAFOs may also be subject to stormwater permitting requirements for construction activity under 40 CFR 122.26(b)(14)(x) or (b)(15).

NPDES CAFO PERMITS

Applications and Notice of Intent

NPDES permitting authorities have two options for issuing NPDES permits to CAFOs: individual permits and general permits. CAFO owners and operators who seek permit coverage must either submit an application for an individual permit or submit a Notice of Intent (NOI) (or permitting authority's comparable form) for coverage under a general permit, if a general permit is available (40 CFR 122.23(d)(1)). EPA requires applicants who seek coverage under either individual or general CAFO permits to provide, at a minimum, the information listed in Table 15-3. The NPDES permitting authority may request additional information from the applicant and use other CWA information-gathering authorities, such as CWA section 308, to obtain such information.

Table 15-3. Information Required on NPDES Application Forms 1 and 2B

Form 1 (all NPDES individual permit applicants) 40 CFR 122.21 (f)
Activities conducted by the applicant that require an NPDES permit
Name, mailing address, and location of facility
Up to four Standard Industrial Classification codes that best reflect the principal products or services provided
Operator's name, address, and telephone number and ownership status
Whether the facility is on Indian lands
List of all other state or federal permits or construction approvals received or applied for under CWA, Resource Conservation and Recovery Act (RCRA), Safe Drinking Water Act (SDWA), etc.
Brief description of the nature of the business
Form 2B (CAFOs) 40 CFR 122.21 (i)
The name, address, and telephone number of the owner or operator
Whether the application is for an existing or proposed facility
Facility name, address, and telephone number
Latitude and longitude of the production area
Name and address of integrator for contract operations
Specific information about the number and type of animals, whether in open confinement or housed under roof
Total number of acres under control of the applicant available for land application of manure, litter, or process wastewater

Table 15-3. Information Required on NPDES Application Forms 1 and 2B

Estimated amounts of manure, litter, and process wastewater generated per year
Estimated amounts of manure, litter, and process wastewater transferred to other persons per year
Topographic map of the geographic area in which the CAFO is located showing the specific location of the production area
Containment and storage type and storage capacity for manure, litter, and process wastewater
A nutrient management plan that satisfies the requirements specified in 40 CFR 122.42(e), including, for all CAFOs subject to 40 CFR Part 412, Subpart C or Subpart B, the requirements of 40 CFR 412.4(c), as applicable
Indication of whether a nutrient management plan is being implemented
Date of last nutrient management plan review or revision
Description of alternative uses of manure, litter, and process wastewater
Identification of land application best management practices implemented

Source: Program Question and Answer Document Volume 1 (EPA, 1992).

Elements of a CAFO Permit

NPDES Effluent Limitations and Standards

Section 301(a) of the CWA prohibits the discharge of pollutants from a point source into waters of the United States unless the discharge complies with other provisions of the CWA, including the requirement for a discharge to be authorized under an NPDES permit. Effluent limitations serve as the primary mechanism in NPDES permits for minimizing discharges of pollutants to receiving waters. Technology-based effluent limits are included in NPDES permits to achieve a level of treatment of pollutants for point source discharges based on the applicable level of control according to technologies specific to that industry. If technology-based limits are insufficient to meet applicable water quality standards, more stringent water quality-based effluent limitations can be included in the permit (CWA section 301(b)(1)(C)).

Overview of Technology-Based Effluent Limitations and Standards

Technology-based effluent limitations and standards for CAFOs must address all discharges from a CAFO (40 CFR 122.42(e)). As discussed below, technology-based standards are established through a national ELG for some CAFO discharges. All other discharges must be addressed through technology-based effluent limitations developed on a case-by-case basis using best professional judgment, or a combination of the two methods (40 CFR 125.3). In general, CAFO permits will include limits for process wastewater discharges from the CAFO's production area and land application area.

The production area at a CAFO includes the animal confinement areas and other parts of the facility, including manure storage areas, raw materials storage areas, and waste containment areas (40 CFR 122.23(b)(8)). The land application area means all land under the control of the CAFO owner or operator, including where the CAFO owns, rents, or leases the land to which manure from the production area is applied (40 CFR 122.23(e)(3)). It includes situations where a CAFO determines when and how much manure is applied to fields not owned, rented, or leased by the CAFO. The regulation at 40 CFR 412 contains the ELG applicable to CAFOs. The CAFO ELG

establishes the technology-based effluent limitations and new source performance standards (NSPS) for those operations that meet the regulatory definition of a large CAFO.

ELG for Animal Sectors

The ELGs for CAFOs are broken into the following subparts addressing specific animal sectors shown in Table 15-4 below.

Table 15-4. Effluent Limitation Summary

Animal Sector	ELG Technology-based Limits
Large CAFOs	40 CFR Part 412
Subpart A—Horses and sheep	40 CFR 412.13
Subpart B—Ducks	40 CFR 412.22
Subpart C—Dairy cows and cattle other than veal calves	40 CFR 412.33, 412.37
Subpart D—Swine, poultry, and veal calves	40 CFR 412.45, 412.47

All four subparts include specific discharge limitations. Subparts A and B contain technology-based requirements for the production area only. Subparts C and D include technology-based requirements for both production areas and land application areas under the control of the CAFO owner or operator.

CAFOs That Are New Sources

The term *new source* is defined in 40 CFR 122.2, and the criteria for determining a new source is identified at 40 CFR 122.29(b). Only large CAFOs can be new sources subject to NSPS requirements promulgated in accordance with CWA section 306 (as provided in 40 CFR Part 412). The new source criteria in 40 CFR 122.29(b) are used to determine which large CAFOs are defined as new sources.

CAFOs That Are New Dischargers

An AFO that is 1) newly constructed; 2) implements changes so that it meets the definition of a CAFO; or 3) that is designated as a CAFO is a *new discharger* if it is not a new source. A new discharger is an AFO that becomes a CAFO either through definition or designation and is not a new source (i.e., subject to NSPS). Such operations could be a CAFO for one of the following reasons: 1) the facility is newly constructed (but not subject to NSPS and therefore not a *new source*); 2) the facility has changed some aspect of its operations such that it becomes defined as a medium CAFO or designated as a small or medium CAFO.

Technology-Based Requirements for the Production Area of Large CAFOs

Operations Covered by Subpart A—Horses and Sheep

The ELG requirements for Subpart A (40 CFR 412.10–15) address the production area only. Any additional technology-based requirements for discharges from the CAFO must be developed using BPJ.

Existing and new large CAFOs that confine horses and sheep may not discharge manure or process wastewater (which includes horse wash-down water) pollutants to waters of the United States from the CAFO (i.e., *no-discharge* standard). The only exception to the no-

discharge standard is an overflow that occurs because of a rainfall event from a permitted facility that is designed, constructed, operated, and maintained to contain all process wastewater plus the runoff from a 25-year, 24-hour rainfall event for the location of the CAFO (40 CFR 412.13 and 412.15).

Operations Covered by Subpart B—Ducks

The ELG requirements for Subpart B (40 CFR 412.20–26) address the production area only. The ELG distinguishes between two types of manure handling systems in the production area of duck operations (*wet lot* and *dry lot*). Any additional technology-based requirements for discharges from the CAFO must be developed on a BPJ basis (40 CFR 125.3(a)).

All duck operations constructed before 1974 subject to the ELG must meet specific discharge limitations established by 40 CFR 412.22. Those are the only numeric limitations in the CAFO ELGs.

OPERATIONS COVERED BY SUBPART C—DAIRY COWS AND CATTLE OTHER THAN VEAL CALVES AND BY SUBPART D—SWINE, POULTRY AND VEAL CALVES

Existing Sources—Subparts C and D

The ELG requirements for subparts C and D (40 CFR 412.30–37 and 412.40–47) address both the production area and the land application area. This section addresses the technology-based requirements associated with the production area. Subpart C includes requirements for large CAFOs that confine dairy cattle and cattle other than veal calves, and Subpart D includes large CAFOs that confine swine, poultry and veal calves. The requirements in Subpart C are identical for existing sources and new sources. The requirements in Subpart D differ for existing and new sources. The new source requirements for Subpart D are addressed below.

Existing sources subject to Subparts C and D and new sources subject to Subpart C are subject to a no-discharge requirement. Those operations may not discharge manure into waters of the United States from the production area (Subpart C—40 CFR 412.31(a), 412.32(a), and 412.33(a); Subpart D—40 CFR 412.43(a), 412.44(a), and 412.45(a)). The only exception to that no-discharge standard is when precipitation causes an overflow, provided that the production area is designed, constructed, operated, and maintained to contain all manure, litter, and process wastewater including the runoff and direct precipitation from a 25-year, 24-hour rainfall event.

To ensure that a facility meets the no-discharge standard, the CAFO must ensure that the production area has adequate storage structures that are designed, constructed, operated, and maintained to contain all manure, litter, and process wastewater including the runoff and direct precipitation from a 25-year, 24-hour rainfall event. An important consideration of whether the CAFO meets the ELG requirements is whether it has adequate storage or treatment structure capable of containing all manure, litter, and process wastewater that accumulate during the critical storage period. To comply with the ELG, the storage volume in the production area must contain all those wastes.

To meet the no-discharge requirement, the CAFO must operate the production area in accordance with additional measures and recordkeeping requirements specified in 40 CFR 412.37(a)–(b) and 412.47(a)–(b). Those include requirements for routine visual inspections of the production area, the use of depth markers for liquid impoundments, corrective action when deficiencies are identified, and mortality handling. Records must be maintained on-site, including records for each of the above measures, and records documenting the design of storage structures and any overflows that occur.

Voluntary Performance Standards

The voluntary alternative performance standards provisions in 40 CFR 412.31(a)(2) apply to existing sources subject to Subpart C and D and new sources subject to Subpart C. This provision applies only to discharges from the production area. The provision for alternative performance standards allows a CAFO owner or operator to request from the Director NPDES permit effluent limitations according to site-specific alternative technologies where the CAFO can establish that the alternative technologies will achieve a quantity of pollutants discharged from the production area equal to or less than the quantity of pollutants that would be discharged under applicable baseline effluent guidelines performance standards.

New Source Performance Standards—Subparts C and D

As discussed in the previous section, Large Subpart C beef and dairy CAFOs that are new sources have the same production area requirements as existing Subpart C operations. Large Subpart D swine, poultry, and veal calf CAFOs that are new sources are subject to the NSPS (40 CFR 412.46).

Like existing sources subject to Subpart D, new sources under Subpart D may not discharge manure, litter, or process wastewater into waters of the United States from the production area and are required to comply with the additional measures and recordkeeping requirements at 40 CFR 412.47(a) and (b).

Unlike the requirements for existing sources, 40 CFR 412.46 does not allow an exception for new sources to the no discharge requirement. Rather, a CAFO subject to the requirements of 40 CFR 412.46 must either 1) have an absolute prohibition of any discharge from its production area as a condition of its permit, or 2) request the permitting authority to “establish NPDES best management practice effluent limitations designed to ensure no discharge...” whereby the facility can satisfy the no discharge effluent limitation (40 CFR 412.46(a)(1)). See Chapter 4 in the *NPDES Permit Writers’ Manual for CAFOs* (EPA, 2012a) for more information.

New sources subject to Subpart D using an open storage structure must have a depth marker to indicate the maximum volume of manure and process wastewater the structure is designed to contain (whereas existing sources and new sources subject to Subpart C must use a depth marker that indicates the 25-year, 24-hour storm event).

An important consideration of whether a CAFO meets the NSPS alternative is if it has an adequate storage or treatment structure capable of containing all manure that accumulates

during the critical storage period. To comply with the NSPS, the storage volume in the production area must contain all wastes.

The definition of a New Source and the requirements for New Sources and their applicability may be complex, depending on the circumstances at an individual facility. Refer to Chapter 4 of the *NPDES Permit Writers' Manual for CAFOs* (EPA, 2012a) for more detailed information.

Requirements for the Production Area of Large CAFOs

Even for CAFOs subject to a no-discharge, technology-based standard for the production area, situations could arise where the permit imposes more stringent requirements for allowable discharges. Specifically, more stringent discharge limitations are necessary in instances where CAFOs discharge from a production area to a waterbody listed under CWA section 303(d) as impaired due to nutrients, dissolved oxygen or bacteria, or where an analysis of frequency, duration and magnitude of the anticipated discharge (consisting of potential overflows of manure, litter, or process wastewater) indicates the reasonable potential to violate applicable water quality standards.

Technology-Based Requirements for the Land Application Area of Large CAFOs

Each CAFO subject to the ELG requirements in subparts C and D that land applies manure must do so in accordance with certain practices that constitute the technology-based effluent limitations for the land application area (40 CFR 412.4 and 412.37(c)).

A general description of the practices required by 40 CFR 412.4 follows.

- Develop and implement a field-specific NMP that fully incorporates the other requirements of 40 CFR 412.4 concerning land application.
- Land apply manure at application rates that minimize nitrogen and phosphorus transport from the field to waters of the United States in compliance with the technical standards for nutrient management established by the permitting authority. The technical standard for nutrient management must include a field-specific assessment of the potential for nitrogen and phosphorus transport from the field to waters of the United States and address the form, source, amount, timing, and method of application of nutrients on each field to achieve realistic production goals while minimizing nitrogen and phosphorus movement to waters of the United States. The standard must also include appropriate flexibility for any CAFO to implement nutrient management practices to comply with the standard such as consideration of multiyear phosphorus applications to fields that do not have a high potential for phosphorus runoff to waters of the United States and phased implementation of phosphorus-based nutrient management, as determined appropriate by the Director.
- Analyze manure at least once a year for nitrogen and phosphorus content, and analyze soil at least once every five years for phosphorus content. The results of the analyses are to be used in determining application rates for manure, litter, and other process wastewater.

- Periodically inspect equipment used for land application of manure for leaks (before each application is recommended to ensure the manure is delivered at the proper rate of application).
- Implement a minimum setback for manure application of 100 feet from surface waters and conduits to surface waters; or substitute with a 35-foot vegetated buffer, or other alternatives where the CAFO demonstrates equivalent pollutant reductions.
- Complete on-site records documenting implementation of all required best management practices (BMPs) and any additional records specified by the permitting authority.

Many states have unique requirements for developing an NMP. The EPA regulations establish the minimum requirements for NPDES permitted CAFOs. States may require more stringent requirements, and in many instances states have established additional requirements to address land application. For example, many states require more frequent soil analysis than is required by 40 CFR 412.4(c)(3). In recognition of that, 40 CFR 412.4(c)(2) requires application rates for land application of manure, litter, and process wastewater to be in compliance with technical standards for nutrient management established by the Director. The regulations at 40 CFR 123.36 require that the state's technical standards be a part of every approved state's NPDES program.

EPA has encouraged states to address water quality protection issues when determining appropriate land application practices as part of their technical standards for nutrient management. At a minimum, the permitting authority must include in the technical standard the following components:

- A field-specific assessment of the potential for nitrogen and phosphorus transport from the field to waters of the United States.
- The form, source, amount, timing, and method of application of nutrients on each field to achieve realistic production goals, while minimizing nitrogen and phosphorus movement to waters of the United States.
- Appropriate flexibility for CAFOs to implement the standard (e.g., multiyear phosphorus banking).

The state technical standards will provide additional specificity to key nutrient management provisions in the ELG. The standards should include additional information, such as soil and manure sampling and analysis protocols, application methods, and plan content requirements. The state technical standards are also considered to determine if a facility meets the requirements to be covered by the agriculture stormwater exemption. To meet the exemption requirements, a facility's nutrient management planning must meet all appropriate state technical standards (e.g., use correct sampling and analysis methods). CAFOs that land apply using nutrient management practices based on standards other than the technical standards established by the Director would have to demonstrate that such practices ensure the

appropriate agricultural utilization of the nutrients in the manure, litter, or process wastewater as specified in 40 CFR 122.42(e)(1)(viii).

Requirements for the Land Application Area of Large CAFOs

As discussed, all permitted CAFOs are required to develop and implement an NMP. When a permitted CAFO implements an NMP in accordance with its permit requirements, any remaining precipitation related discharges of manure are considered agricultural stormwater. For large CAFOs subject to the ELG, that also means that the NMP must comply with permit requirements that implement the ELG, including technical standards established by the Director for nutrient management. For facilities not subject to the ELG, it means that the NMP must comply with permit requirements that implement 40 CFR 122.42(e) and any additional nutrient management requirements developed by BPJ. As previously mentioned, by definition, the agricultural stormwater exemption applies only to precipitation-related discharges.

BEST PROFESSIONAL JUDGMENT (BPJ)

NPDES permit limitations are based on BPJ when national ELGs have not been issued pertaining to an industrial category or process. Specifically, the NPDES regulations require a permit writer to establish permit limitations on a case-by-case BPJ basis when ELGs are inapplicable, or in combination with the effluent guidelines, where the ELG apply to only certain aspects of the operation or certain pollutants (CWA section 402(a)(1); 40 CFR 122.44(k)). As explained, ELGs have been promulgated for only those operations that meet the regulatory definition of a large CAFO, and apply to the production area for subparts A, B, C, and D, and land application area for subparts C and D. For example, there is no ELG for small or medium CAFOs or for exotic animal species. Exotic animal species are those not specifically identified in the ELG, for example: llamas, geese, or ostriches. Nonetheless, just as for any other permitted facility, the CWA requires that an NPDES permit for small, medium, and exotic animal CAFOs include technology-based effluent limitations.

OTHER TECHNOLOGY-BASED LIMITATIONS THAT APPLY TO DISCHARGES FROM CAFOS

CAFOs may have additional discharges not specifically addressed in the ELG or CAFO regulations, either from the production area or from outside the production area. Those include but are not limited to the following:

- Process wastewater discharges from outside the production area, such as wash-down of equipment that has been in contact with manure, raw materials, products or by-products that occurs outside the production area.
- Discharges that do not meet the definition of process wastewater, such as domestic wastewater discharges; chiller water; discharges associated with feed, fuel, chemical, or oil spills, and equipment repair.
- Discharges of pollutants from poultry, swine, and veal calf animal confinement houses that are not covered by the ELG. Those include removal of animals and cleaning out houses, and runoff associated with fan exhaust deposits outside the houses.

A CAFO permit should address discharges such as those above and establish BAT/BCT limits developed on a BPJ basis. The determination of whether to apply the no-discharge standard to areas other than those that are covered by the ELG (animal confinement area, manure storage area, waste containment area, and so on) is a site-specific determination that must be made by the permitting authority. EPA and states can begin the BPJ analysis with an evaluation based on the no-discharge standard, because that is the applicable standard most closely related to those facilities (see discussion of BPJ-based limits in Chapter 4.1.4. of EPA's *NPDES Permit Writers' Manual for CAFOs* (EPA, 2012a)).

WATER QUALITY-BASED EFFLUENT LIMITATIONS AND STANDARDS

All NPDES permits must include technology-based effluent limitations. However, a permit must also include more stringent water quality-based limitations when such limitations are necessary to meet water quality standards (CWA sections 402(a) and 301(b)(1)(C)).

REQUIREMENTS FOR THE LAND APPLICATION AREA OF PERMITTED LARGE CAFOS

As discussed, all permitted CAFOs are required to develop and implement an NMP. When a permitted CAFO implements an NMP in accordance with its permit requirements, any remaining precipitation related discharges of manure are considered agricultural stormwater. For large CAFOs subject to the ELG, that also means that the NMP must comply with permit requirements that implement the ELG, including technical standards established by the Director for nutrient management. For facilities not subject to the ELG, it means that the NMP must comply with permit requirements that implement 40 CFR 122.42(e) and any additional nutrient management requirements developed by BPJ. As previously mentioned, by definition, the agricultural stormwater exemption applies only to precipitation-related discharges.

An NMP is a detailed planning document that identifies conservation practices and management activities that, when implemented, help to ensure that both production and natural resource protection goals are achieved. The objective of an NMP is to document those practices and activities that will help achieve the goals of the producer and protect or improve water quality.

Permitted CAFOs must comply with the terms of their NMP. As discussed above, the ELGs establish more specific nutrient management requirements for Large dairy, cattle, swine, poultry, and veal calf CAFOs. One of those requirements is that the manure application rates in those CAFOs' NMPs must minimize phosphorus and nitrogen transport to surface waters in compliance with technical standards for nutrient management established by the Director.

The CAFO regulations at 40 CFR 123.36 require states to establish technical standards for nutrient management that are consistent with 40 CFR 412.4(c)(2). The regulations include basic requirements for elements that each state's technical standards for nutrient management must include.

- The state technical standards will provide additional specificity to key nutrient management provisions in the ELG. The standards should include additional

information, such as soil and manure sampling and analysis protocols, application methods, and plan content requirements.

EPA's *NPDES Permit Writers' Manual for CAFOs* (EPA, 2012a) provides more detail on EPA's expectations for the content of state technical standards for nutrient management. It is important for inspectors to be familiar with the applicable technical standards for each inspected CAFO. The CAFO's permit will include terms of the NMP, which have been reviewed by the permit writer to ensure the NMP and associated terms are consistent with the state's technical standards for nutrient management. However, inspectors will need to understand the scope and content of the technical standards to adequately evaluate NMP implementation. In addition, for Large unpermitted CAFOs, the inspector needs to understand the state's technical standards to determine if the CAFO's nutrient management practices meet the standards and thus if the CAFO qualifies for the agricultural stormwater exemption.

Soil science and Soil Fertility

To fully understand nutrient management at a CAFO, the CAFO inspector should be aware of the basic principles of soil science and soil fertility. Key concepts include nutrient cycling in soils, the factors that influence plant availability of nutrients and crop uptake, as well as the mechanisms and factors that affect nutrient loss from agricultural soils. These concepts are used to develop and implement an NMP and some familiarity with the concepts will allow the CAFO inspector to understand and evaluate NMP implementation. See Appendix AE, "Management/Soil Science," which describes basic nutrient management and soil science concepts for CAFO inspectors. CAFO inspectors may also refer to Appendix A of EPA's *NPDES Permit Writers' Manual for CAFOs* (EPA, 2012a), which provides a more thorough introduction to basic soil science and soil fertility.

Minimum Measures that Must Be Terms and Conditions of the NPDES Permit

Certain elements of a permitted CAFO's site-specific NMP are identified as "terms of the permit." Those site-specific terms of the permit are defined as "the information, protocols, [BMPs], and other conditions" identified in a CAFO's NMP and determined by the permitting authority to be necessary to meet the requirements of 40 CFR 122.42(e)(1) (40 CFR 122.42(e)(5)). For CAFOs subject to subparts C and D of the ELG (Large dairy, beef, poultry, swine, and veal calf CAFOs), the terms of the NMP must also include the BMPs necessary to meet the land application requirements identified in 40 CFR 412.4(c). The NMP terms must be included by the permit writer in a CAFO's NPDES permit as enforceable terms and conditions of the permit. CAFO inspectors will assess whether CAFO operations are addressing these conditions and implementing the terms of their NPDES permit.

With respect to protocols for land application of manure, the NPDES regulations identify the specific information that is (and is not) considered to be terms of the NMP. CAFO inspectors should be familiar with the approach (linear or narrative rate) used to develop the terms of a CAFO's NMP as well as the terms that have been identified as enforceable permit conditions.

Many states have unique requirements for developing an NMP. The requirements of EPA regulations establish the minimum requirements for permitted CAFOs. States may require more

stringent requirements, and in many instances states have established additional requirements to address land application.

The NPDES regulations establish minimum requirements—the nine minimum measures—that must be addressed in every CAFO’s NMP. As discussed above, the ELGs and the state technical standards for nutrient management include more specific requirements for some of the minimum measures that apply to certain CAFOs. The nine minimum measures that must be included, as applicable, in each CAFO’s NMP are listed below (40 CFR 122.42(e)(1)(i)–(ix)). The list also identifies the more specific requirements found in the ELG for certain CAFOs.

Minimum Measures:

- Ensure adequate storage of manure, litter, and process wastewater, including procedures to ensure proper operation and maintenance of the storage facilities.
 - CAFOs subject to the ELG must meet the storage requirements associated with the applicable subpart.
 - CAFOs subject to subparts C and D of the ELG must implement additional measures and recordkeeping for the production area.
- Ensure proper management of mortalities (i.e., dead animals) to ensure that they are not disposed of in a liquid manure, stormwater, or process wastewater storage or treatment system that is not specifically designed to treat animal mortalities.
 - CAFOs subject to subparts C and D of the ELG must also handle mortalities to prevent pollutant discharges to surface water.
- Ensure that clean water is diverted, as appropriate, from the production area.
- Prevent direct contact of confined animals with waters of the United States.
- Ensure that chemicals and other contaminants handled on-site are not disposed of in any manure, litter, process wastewater, or stormwater storage or treatment system unless specifically designed to treat such chemicals and other contaminants.
- Identify appropriate site-specific conservation practices to be implemented, including as appropriate buffers or equivalent practices, to control runoff of pollutants to waters of the United States.
 - CAFOs subject to subparts C and D of the ELG must also implement 100-foot land application setbacks from down gradient surface waters or conduits to surface waters, or 35-foot vegetated buffers, or a compliance alternative.
 - The state technical standards for nutrient management may also require conservation practices to be implemented under certain land application scenarios.
- Identify protocols for appropriate testing of manure, litter, process wastewater, and soil.
 - CAFOs subject to subparts C and D of the ELG must sample soils for phosphorus at least every 5 years and manure for nitrogen and phosphorus annually.

- Establish protocols to land apply manure, litter or process wastewater in accordance with site-specific nutrient management practices that ensure appropriate agricultural utilization of the nutrients in the manure, litter or process wastewater.
 - The ELG establishes specific requirements for developing land application rates for CAFOs subject to subparts C and D, including the requirement that those CAFOs use the state technical standards for nutrient management when developing land application rates.
- Identify specific records that will be maintained to document the implementation and management of the minimum elements described above and in 40 CFR 122.42 (e)(1)(i)–(viii).
 - The ELG establishes specific recordkeeping requirements for CAFOs subject to subparts C and D.

Information on how to evaluate performance of the nine minimum measures is included in Section C, “The CAFO Inspection—Facility Tour,” and Section D, “The CAFO Inspection—Record Review and the NMP.”

For large CAFOs subject to the land application requirements of the ELG, in addition to the requirements of 40 CFR Part 122, the terms of the NMP must also include the BMPs necessary to meet the requirements of 40 CFR 412.4(c).

Part 412.4 requires that the NMP address the form, source, amount, timing and method of application and include a field-specific assessment of the potential for nitrogen and phosphorus transport from the field to surface waters. The Director may also allow appropriate flexibilities to implement nutrient management practices.

Part 122.42(e)(5) further elaborates on the terms of the NMP associated with protocols for land application. Those must include the fields available for land application, field-specific rates of application, and any timing limitations on when manure can be land applied. The terms for rates of application must follow one of two approaches that the regulation identifies as the linear approach and the narrative rate approach.

Changes to a Permitted CAFO’s NMP

Agricultural operations modify their nutrient management and farming practices during the normal course of their operations. Such alterations might require changes to a permitted CAFO’s NMP during the period of permit coverage.

Because of the way NMPs are developed and the flexibility provided by the two options for developing the terms of the NMP at 40 CFR 122.42(e)(5), most routine changes at a facility should not require changes to the permit itself. To minimize the need for revision, NMPs should account for and accommodate routine variations inherent in agricultural operations such as anticipated changes in crop rotation, and changes in numbers of animals and volume of manure resulting from normal fluctuations or a facility’s planned expansion.

Typically, an NMP is developed to reflect the maximum number of animals confined at the facility; the maximum capacity for manure storage; the total number of fields available for land application and their maximum capacity for nutrient applications. Fluctuations under those maximum amounts would not necessitate changes to NMPs. EPA encourages operators to develop an NMP that includes reasonably predictable alternatives that a CAFO may implement during the period of permit coverage. However, unanticipated changes to an NMP and in some cases, permit terms, might nevertheless be necessary. In the course of the NMP review, an inspector may identify instances where a CAFO may not have complied with a permit requirement to notify the permitting authority of a change to its NMP during the period of permit coverage. The regulations at 40 CFR 122.42(e)(6) identify requirements that should be incorporated into each CAFO's permit regarding providing the permitting authority with the most current version of the NMP.

Agricultural Stormwater Exemption for Permitted CAFOs

Permitted CAFOs that land apply manure must implement practices to ensure that all precipitation-related discharges from land application are composed entirely of agricultural stormwater. Section 502(14) of the CWA excludes from the definition of a point source agricultural stormwater discharges. The CAFO regulations establish when a discharge from a land application area under the control of a CAFO is considered to be exempt agricultural stormwater, as opposed to a point source discharge from the CAFO. A precipitation-related discharge from a CAFO's land application areas is considered agricultural stormwater only when the manure was applied in accordance with site-specific nutrient management practices that "ensure appropriate agricultural utilization of the nutrients" in the manure to be applied (40 CFR 122.23(e)). For CAFOs, the agricultural stormwater exemption applies only to discharges from land application areas. Discharges occurring during dry weather can never be discharges of agricultural stormwater.

Criteria for site-specific nutrient management practices for land application are specified in 40 CFR 122.42(e)(1)(vi)–(ix). For permitted CAFOs, the permit should set forth the, "site-specific nutrient management practices" that will be implemented for each requirement of 40 CFR 122.42(e)(1)(vi)–(ix). Under 40 CFR 122.42(e)(1)(vii), all permitted CAFOs must establish field-specific application rates for manure. The site-specific land application rates must be established as enforceable terms in the facility's NPDES permit following either the linear approach described in 40 CFR 122.42(e)(5)(i), or the narrative rate approach described in 40 CFR 122.42(e)(5)(ii).

In addition to the requirements described above, permitted large CAFOs subject to the requirements of Subpart C and D of Part 412 must also meet the requirement of 40 CFR 412.4(c) to qualify for the agricultural stormwater exemption (40 CFR 122.23(e)(1) and 122.42(e)(1)). The ELG specifies requirements for implementing site-specific application rates, manure and soil sampling, and setback requirements. Additionally, it provides protocols for inspecting the land application equipment.

The site-specific application rates for manure must be developed in accordance with technical standards established by the Director (40 CFR 412.4(c)(2)). The rates must also be identified in

the facility's NPDES permit as enforceable terms following either the linear approach or narrative rate approach (73 FR 70420).

Land Application at Permitted Small and Medium CAFOs

For precipitation-related discharges from the land application area of a medium or small CAFO to qualify for the agricultural stormwater exemption, the owner or operator of the CAFO must implement an NMP that includes the practices and protocols specified in 40 CFR 122.42(e)(1)(vii)–(ix).

Effluent limitations for medium and small CAFOs are based on BPJ and could be the same as, or similar to, the effluent limitations established in the ELG for large CAFOs. Thus, a medium or small CAFO might be required to develop protocols for land application in accordance with the state technical standards for nutrient management and comply with the requirement for a 100-foot setback or a 35-foot vegetated buffer between land application areas and any down gradient surface waters or conduits to surface waters. Because the practices for ensuring appropriate agricultural utilization of the nutrients in land-applied manure at large CAFOs do not differ significantly for medium and small CAFOs, the permit may apply the requirements established in the state technical standards to land application sites at all permitted CAFOs.

MONITORING, RECORDKEEPING, AND REPORTING REQUIREMENTS OF NPDES PERMITS FOR CAFOs

The NPDES regulations identify recordkeeping, monitoring, and reporting requirements that are applicable to all CAFOs (40 CFR 122.41, 122.42(e)(2)–(4)). The CAFO ELG identify additional recordkeeping and monitoring requirements that are applicable only to large CAFOs. The recordkeeping requirements associated with the off-site transfer of manure are applicable to large CAFOs. For CAFOs not subject to the ELG, additional monitoring and recordkeeping requirements may be established as technology-based limits by the permitting authority on a case-by-case basis using BPJ.

Monitoring Requirements

NPDES permits should include monitoring requirements that address the routine operational characteristics of the facility and the minimum reporting requirements at 40 CFR 122.41(l). The ELG includes specific monitoring requirements for daily and weekly visual inspections of specific aspects of the production area and monitoring requirements associated with land application, including manure and soil analysis and land application equipment inspection (40 CFR 412.37, 412.47).

The permit may also include monitoring requirements that address non-routine activities. For example, discharges at a CAFO can occur because of an overflow during a catastrophic storm event (which may be an allowable discharge under the terms of the permit) or a leak, breach, overflow, or other structural failure of a storage facility because of improper operation, design, or maintenance (which would be an unauthorized discharge). Unauthorized discharges could also occur because of manure releases related to the improper storage or handling of liquid or solid manure, or improper land application. Where there is a discharge from the production

area to an impaired water, a permit may include more restrictive water quality-based effluent limitations and additional monitoring requirements.

Recordkeeping Requirements

Permitted CAFOs must retain copies of all required documentation. In addition, permits should require that the records be organized in a manner that inspectors can easily review during a compliance inspection, such as the use of a dedicated logbook. The required records for large CAFOs are listed in Table 15-5 and for small and medium CAFOs in Table 15-6. Records must be maintained for five years.

Table 15-5. Required Records for Permitted Large CAFOs

Regulatory Requirement for Recordkeeping	Records Required
Requirements to maintain records for the nine minimum terms of the NMP. 40 CFR 122.42(e)(2)	
Adequate storage capacity	Satisfied by requirements of 40 CFR 412.37(b) (below).
Mortality management	Satisfied by requirements of 40 CFR 412.37(b) (below).
Divert clean water	Satisfied by requirements of 40 CFR 412.37(b) (below).
Prevent direct contact with waters of United States	Identify what waters of the United States, if any, exist within the animal confinement areas and the measures, including operation, and maintenance procedures and associated records, that are implemented to prevent animals from contacting waters of the United States.
Chemical disposal	Identify chemicals used or stored (or both) on-site and document appropriate disposal methods.
Conservation practices to control runoff to waters of the United States	Identify the conservation practices used to control pollutant runoff, including location, and the protocols and procedures, including installation, operation, and maintenance, and associated records, that are implemented to ensure the practices function to control pollutant runoff.
Manure and soil testing	Satisfied by requirements of 40 CFR 412.37(c) (below).
Protocols for land application	Satisfied by requirement of 40 CFR 122.42(e)(2)(ii) and 412.37(c) requirement to maintain on-site a site-specific NMP.
Requirements to maintain records for the production area. 40 CFR 412.37(b)	
A complete copy of the information required by 40 CFR 122.21(i)(1)	The name and owner or operator.
	The facility location and mailing address.
	Latitude and longitude of the entrance of the production area.
	A topographic map of the geographic area in which the CAFO is located showing the location of the production area.
	Specific information about the number and type of animals.
	Type of confinement animals are in (open confinement or housed under a roof).
	The type of containment and storage (anaerobic lagoon, roofed storage shed, storage ponds, under floor pits, aboveground storage tanks, belowground storage tanks, concrete pad, impervious soil pad, other).
	The total capacity for manure, litter, and process wastewater storage (tons/gallons).

Table 15-5. Required Records for Permitted Large CAFOs

Regulatory Requirement for Recordkeeping	Records Required
	The total number of acres under control of the applicant available for land application of manure, litter, or process wastewater.
	Estimated amounts of manure, litter, and process wastewater generated per year (tons/gallons).
	Estimated amounts of manure, litter, and process wastewater transferred to other persons per year (tons/gallons).
	The site-specific NMP.
Requirements to maintain records for the production area. 40 CFR 412.37(b)	
Records documenting the inspections 40 CFR 412.37(a)(1)	Necessary documentation for inspections of the production area.
	Records documenting weekly inspections of all stormwater diversion devices, runoff diversion structures, and devices channeling contaminated stormwater to the wastewater and manure storage and containment structure.
	Records documenting daily inspection of water lines, including drinking water or cooling water lines.
	Records documenting weekly inspections of the manure, litter, and process wastewater impoundments.
Wastewater levels 40 CFR 412.37(b)(2)	Weekly records of the manure and wastewater level in liquid impoundments as indicated by the required depth marker.
Corrective actions 40 CFR 412.37(b)(3)	Records of any actions taken to correct deficiencies found in the visual inspections of the production area.
	An explanation of the factors preventing immediate correction of any deficiencies identified in the visual inspections of the production area that are not corrected within 30 days.
Mortality management required 40 CFR 412.37(b)(4), (a)(4)	Records must identify that mortalities were not disposed of in any liquid manure or process wastewater system. They must also identify that mortalities were handled in such a way as to prevent the discharge of pollutants to surface water, unless alternative technologies pursuant to 40 CFR 412.31(a)(2) and approved by the Director are designed to handle mortalities.
Storage structure design 40 CFR 412.37(b)(5)	Current design of any manure or litter storage structures, including volume for solids accumulation, design treatment volume, total design volume, and approximate number of days of storage capacity.
Overflows 40 CFR 412.37(b)(6)	The date, time, and estimated volume of any overflow.
Requirements to maintain records for the land application area. 40 CFR 412.37(c)	
	Expected crop yields.
	Weather conditions 24 hours before application, at time of application, and 24 hours after application.
	Explanation of the basis for determining manure application rates, as provided in the technical standards established by the Director.
	Calculations showing the total nitrogen and phosphorus to be applied to each field, including sources other than manure, litter, or process wastewater.
	Total amount of nitrogen and phosphorus applied to each field, including documentation of calculations for the total amount applied.

Table 15-5. Required Records for Permitted Large CAFOs

Regulatory Requirement for Recordkeeping	Records Required
	The method used to apply the manure, litter, or process wastewater.
	Test methods used to sample and analyze manure, litter, process wastewater, and soil (40 CFR 412.37(c), 47(c)).
	Results from manure, litter, process wastewater, and soil sampling (40 CFR 412.37(c)).
	Date(s) of manure application equipment inspection.
40 CFR Part 412.37(c)	At the discretion of the permitting authority.

Table 15-6. Required Records for Permitted Small and Medium CAFOs

Regulatory Requirement for Recordkeeping	Responsive Records or Documentation
Requirements to maintain records for nine minimum terms of the NMP. 40 CFR 122.42(e)(1)(ix)	
Adequate storage capacity	Documentation of the storage capacity required to meet permit requirements and the storage capacity available.
Mortality management	Records of practices implemented to meet the mortality disposal or management practices (or both) of the permit.
Divert clean water	Document implementation of any operation and maintenance practices used to ensure that clean water is diverted as appropriate.
Prevent direct contact with waters of the United States.	Identify what waters of the United States, if any, exist within the animal confinement areas and the measures, including operation and maintenance procedures and associated records, that are implemented to prevent animals from contacting waters of the United States.
Chemical disposal	Identify chemicals used or stored (or both) on-site and document appropriate disposal methods.
Conservation practices to control runoff to waters of the United States	Identify the conservation practices used to control pollutant runoff, including location, and the protocols and procedures, including installation, operation, and maintenance, and associated records, that are implemented to ensure the practices function to control pollutant runoff.
Manure and soil testing	Results of manure and soil tests taken to meet the requirements of the permit and NMP.
Protocols for land application	Satisfied by requirement of 40 CFR 122.42(e)(2)(ii) requirement to maintain a site-specific NMP on-site.
Additional recordkeeping requirement to satisfy the effluent limitations	
Determined by the permitting authority on a case-by-case basis.	

Reporting Requirements

Reporting requirements are generally linked to monitoring requirements and can include periodic reports, emergency reports for overflow events, and special reports. An NPDES permit will often include monitoring requirements for routine operational characteristics of the facility, including the required annual report, and the minimum reporting requirements at 40 CFR 122.41(l). The permit may also include reporting requirements that address non-routine

activities such as discharge notification (for both authorized and unauthorized discharges). In case of a discharge, the CAFO is required to provide immediate notification of the permitting authority and a follow-up report describing the specific data collection activities required for discharges (40 CFR 122.41(l)(6)). The permittee must provide a description of the discharge, describe the time and duration of the event, identify the cause(s) of the discharge, and provide the result of any required analysis(es) to the permitting authority (40 CFR 122.41(l)(6) and 122.44(g)).

Annual Reports

All NPDES permits for CAFOs must include a requirement that the permittee submit an annual report with specific information defined in the regulation (40 CFR 122.42(e)(4)). In addition to the information required by the NPDES regulations, state permitting authorities can require additional information to be included with the annual report. The 2015 Final NPDES Electronic Reporting Rule requires that NPDES regulated entities, electronically submit certain permit and compliance monitoring information instead of using paper reports. Permitted CAFOs will need to electronically submit any general permit reports (e.g., Notice of Intent (NOI)) and their Annual Reports after December 21, 2020, unless they seek and have obtained an electronic reporting waiver from the NPDES permitting authority (40 CFR 127.15).

The annual report must include the following (40 CFR 122.42(e)(4)):

- The number and type of animals confined at the CAFO.
- Estimated total amount of manure, litter, and process wastewater generated by the CAFO in the previous 12 months (tons/gallons).
- Estimated total amount of manure, litter, and process wastewater transferred to other persons by the CAFO in the previous 12 months (tons/gallons).
- Total number of acres for land application covered by the NMP.
- Total number of acres under control of the CAFO that were used for land application of manure, litter, and process wastewater in the previous 12 months.
- Summary of all manure, litter, and process wastewater discharges from the production area that have occurred in the previous 12 months, including the date, time, and approximate volume of the discharge.
- A statement indicating whether the current version of the CAFO's NMP was developed or approved by a certified nutrient management planner.
- The actual crop(s) planted and actual yield(s) for each field.
- The nitrogen and phosphorus content of the manure, litter, and process wastewater as reported on the laboratory report for the required analyses (lbs./ton, g/Kg, pounds/1,000 gallons, mg/L, ppm).
- The results of calculations conducted in accordance with the approved NMP to determine the amount of manure, litter, or process wastewater to apply.

- The amount of manure, litter, and process wastewater applied to each field during the previous 12 months.
- For any CAFO that implements an NMP that addresses rates of application in accordance with the narrative rate approach:
- The results of any soil testing for nitrogen and phosphorus conducted during the previous 12 months.
- The data used in calculations conducted in accordance with the methodology in the approved NMP to determine rates of nitrogen and phosphorus application from manure, litter, and process wastewater.
- The amount of any supplemental fertilizer applied during the previous 12 months.
- The actual crop(s) planted and actual yield(s) for each field, the actual nitrogen and phosphorus content of the manure, litter, and process wastewater, and the amount of manure, litter, or process wastewater applied to each field during the previous 12 months.

CAFOs that follow the narrative rate approach for describing rates of application in the NMP must also submit as part of their annual report:

- The results of all soil testing and concurrent calculations to account for residual nitrogen and phosphorus in the soil, all recalculations, and the new data from which they are derived.
- The amounts of manure and the amount of chemical fertilizer applied to each field during the preceding 12 months. Together with the total amount of plant-available nitrogen and phosphorus from all sources, the information that is required to be included in the annual report provides the information necessary to determine that the CAFO was adhering to the terms of its permit when calculating amounts of manure to apply.
- The narrative rate approach requires the CAFO to recalculate the projected amount of manure, to be land applied, using the methodology in the NMP, at least once a year, throughout the period of permit coverage. The recalculations and the new data from which they are derived are required to be reported in the CAFO's annual report (40 CFR 122.42(e)(5)(ii)).

The annual report requirements should reflect implementation of existing NMP provisions and changes to the NMP contemplated through flexibilities built into the NMP during the initial planning process or later modifications in accordance with 40 CFR 122.42(e)(6). Because the terms of the NMP are incorporated as enforceable terms and conditions of the permit, any change that results in a change to the terms of the NMP constitutes a change to the permit and therefore must be processed in accordance with 40 CFR 122.42(e)(6).

EPA's *NPDES Permit Writers' Manual for CAFOs* (EPA, 2012a), Appendix D, "Example Nutrient Management Plan Record Keeping Forms," and Appendix M, "Nutrient Management

Recordkeeping Calendar,” includes some examples of recordkeeping forms. Those forms can help the operation meet some of the recordkeeping requirements specified in the regulations.

B. PREPARING FOR THE CAFO OR AFO INSPECTION

The primary goals of the CAFO inspection are gathering information to identify and document threats to water quality; determine status as a CAFO or AFO, determine compliance status with the statute, regulations, permit conditions and other program requirements; and verifying the accuracy of information submitted by the CAFO. Other goals of a CAFO inspection might include investigating a citizen tip or complaint, gathering evidence to support enforcement actions, collecting information to support NPDES permit development, and assessing compliance with orders or consent decrees. In addition, providing feedback to the producer on where discharge vulnerabilities may exist is important. Some problems can be remedied quickly once identified, and preventing pollutant discharges is the best outcome for water quality. Information collected depends on the type of CAFO inspection being conducted. Information collected and operational aspects evaluated during the inspection will vary by inspection type. A CAFO inspection is often categorized as a Status Determination Inspection, Permit Compliance Inspection, Reconnaissance, Settlement Agreement Inspection, or Complaint Inspection and may include sampling elements.

SELECTION OF FACILITIES FOR INSPECTION

Although specific procedures to select facilities for inspection will vary by EPA Region and by authorized state, the basic approach is similar. Some facilities are selected for inspection based on probable cause, which means that the regulatory agency has obtained specific evidence of a possible existing violation at a facility. Inspections are conducted in response to citizen complaints about a specific facility, emergency situations such as reports of ongoing spills, information about specific water quality problems or fish kills, referrals from a state, to assist a state inspection effort, or as a follow-up to prior inspections indicating violations at the same facility or at other facilities owned or operated by the same entity. Facilities are also selected through the Neutral Administrative Inspection Scheme, in which the regulatory agency does not have any prior information indicating that there are existing violations. These are routine inspections to evaluate compliance. Within the neutral scheme, priority may be given to facilities that meet one or more of the following criteria:

- Are large CAFOs.
- Are in priority watersheds impaired by runoff from AFOs or high water quality watersheds that are priorities for protection.
- Are in watersheds with high AFO or CAFO density.
- Are near surface waters.
- Have the potential for large amounts of animal waste to reach surface water.
- Are near sources of drinking water.

The NPDES Compliance Monitoring Strategy calls for the following inspection frequencies:

- CAFOs with NPDES permits should be inspected by states and regions at least once every five years to determine compliance with the permit.
- Large CAFOs without NPDES permit coverage should be inspected to determine if the facility discharges. After a determination is made, future inspections occur on an as needed basis, (e.g., to see if the facility has made changes to its operation).
- Medium AFOs should be “assessed” one-time initially to determine if the facility is discharging and is a medium CAFO.
- Small AFOs should be inspected as needed based on complaints or other information.

COMPLIANCE DETERMINATION STRATEGY

The primary role of a CAFO inspector is to gather information that can be used to determine if an AFO or CAFO is in violation of NPDES and CWA requirements. If the CAFO has an NPDES permit the inspector will evaluate compliance with permit conditions, applicable regulations, and other requirements. Because most CAFOs do not have NPDES permit coverage, the CAFO inspector will often be collecting information to determine whether an unpermitted AFO or CAFO is discharging pollutants to a water of the United States and has a duty to apply for a permit. The CAFO inspector also plays an important role in enforcement case development and support. To fulfill these roles, a CAFO inspector must know before the inspection how compliance will be evaluated and what documentation will be necessary to make and support compliance determinations. If the CAFO inspector does not know what documentation to collect, the inspection may not provide appropriate and sufficient information. A compliance determination strategy is a formal or informal plan for the information and operational characteristics that an inspector will evaluate at a facility. The compliance determination strategy should reflect the type of inspection being conducted (see the examples in Table 15-7). The inspector should have a clear idea of the purpose of the inspection and the information that will be useful in evaluating compliance. The compliance determination strategy could be a ranking of preference in terms of documents, photographs, statements, and other materials to be evaluated and used to effectively demonstrate that the facility is or is not complying with applicable requirements. The compliance determination strategy will form the basis of the CAFO Inspection Plan, discussed at the end of this section.

Table 15-7. Example Inspection Focus for Compliance Determination Strategy Based on Inspection Type

Inspection Type	Inspection Focus for Compliance Determination Strategy
Status Determination Inspection	Information needed to determine whether the facility is a CAFO; for example: <ul style="list-style-type: none"> • Number of animals confined • Confinement period

Table 15-7. Example Inspection Focus for Compliance Determination Strategy Based on Inspection Type

Inspection Type	Inspection Focus for Compliance Determination Strategy
	Information needed to determine if the facility is discharging or has discharged; for example: <ul style="list-style-type: none"> • Quantity of waste generated • Storage capacity • Potential discharge locations • Records or other evidence of discharges • Proximity to waters of the United States
Permit Compliance Inspection	All information needed to evaluate permit compliance; for example: <ul style="list-style-type: none"> • Evidence of discharges or water quality impacts to the receiving water(s). • Documentation of required visual inspections. • Evaluation of impoundment operation and maintenance. • Documentation of mortality management or disposal. • Land application records. • Animal feed storage and runoff management. • Evaluation of conservation practice operation and maintenance. • Documentation of compliance with all NMP nine minimum measures and associated NMP terms.
Settlement Agreement Inspection	Any information relevant to the terms of the Settlement Agreement
Complaint Inspection	Documentation and evaluation of site conditions related to the complaint

Documentation provides a snapshot in time of the actual conditions existing at the time of inspection so that evidence can be examined objectively by compliance personnel.

Documentation is a general term used here to refer to all printed information and electronic media produced, copied, or created by an inspector to provide evidence of suspected violations. Forms of documentation include the inspector's field notebook or inspection checklist, verbal statements documented by the inspector, photographs, videotapes, drawings, maps, printed matter, electronic recordings, and photocopies or photographs of on-site records. Of these, verbal

statements are the least desirable as they are the easiest to refute. Documentation may also include sampling of manure, litter, and process wastewater as well as soils, surface waters or discharges and the necessary labeling and chain of custody documents associated with the samples.

Documentation Tips

- ✓ Include a distinguishing characteristic like a unique depth marker or buildings in the background of photos.
- ✓ Impermanent items, such as vegetation, do not make good reference points as they can be easily removed.
- ✓ Photos should include an accurate date/time stamp that shows it was taken during the time period of the inspection.
- ✓ Some digital cameras include built-in global positioning system (GPS) tagging that allows an inspector to associate each photo with the geographic location where it was created.

EPA or state attorneys will be able to provide compliance determination strategies and documentation requirements based on prior case law and experience presenting evidence in court. For example, the inspector may want to include an obvious reference point in photographs that clearly ties the image to a specific CAFO. Documents should, ideally, have dated signatures or certification stamps (e.g., professional engineers stamp, where appropriate).

CAFO INSPECTOR RESPONSIBILITIES AND PREPARATION ACTIVITIES

In addition to the responsibilities described in EPA's *NPDES Compliance Inspection Manual* (EPA, 2016), there are a number of other items that the CAFO inspector needs to do or consider before entering the CAFO facility. The CAFO inspector needs to understand his or her role in the inspection process, determine the type of inspection to be performed and become familiar with the facility location and its geographic features. The CAFO inspector should consider his or her responsibilities prior to the CAFO inspection:

1. Professional Attitude
2. Animal Safety and Biosecurity
3. Inspector Safety and Personal Protection Equipment (PPE)
4. General Facility Information
5. Review of Permit and Facility Files
6. Facility Compliance and Enforcement History

Professional Attitude

The CAFO inspector is often the first or only contact a CAFO operator has with the EPA. In dealing with facility representatives and employees, CAFO inspectors should be professional, tactful, courteous, and diplomatic. A firm but responsive attitude will encourage cooperation and initiate professional working relationships. CAFO inspectors should always speak respectfully of any product, manufacturer, or person but not endorse anything.

Many CAFO operators reside on-site, and their office may be in their residence. As a result, portions of a CAFO inspection may take place in a non-neutral location such as the operator's residence or vehicle or in the presence of the operator's family. The CAFO inspector should be polite and respectful of the operator, family members or other facility employees, and the operator's home, vehicle, or office. Inspectors may also encounter the owner's or operator's pets and should resist the urge to touch or pet these animals. To the extent practicable, scrape mud and manure from boots (or remove boots) prior to entering buildings and vehicles, drive and park carefully, and behave in a non-confrontational manner as appropriate to the situation.

Another professional consideration unique to CAFO inspections is timing of the inspection so the operator is available. The CAFO inspector should be aware that some farm operations will take precedence over the inspection, especially animal emergencies. Dairies, for example, have established milking schedules and the operator may not be available to meet if you arrive when cows are being milked. Seasonal considerations, such as planting or harvest time, may also

determine the availability of the CAFO operator or other knowledgeable employee to participate in the inspection. Since inspectors often have to travel long distances to reach remote facilities, it may be beneficial to contact the facility operator ahead of time to schedule the inspection, if allowed by your regional or state policies. Also refer to the “Inspection Notification” section of this chapter.

Animal Safety and Biosecurity

The CAFO inspector should be familiar with all safety obligations and practices regarding basic inspections, including regional and state policies or requirements. Inspectors should ask about and follow any facility-specific safety requirements in place. In addition to the basic health and safety risks associated with inspecting facilities, CAFO inspectors have the added responsibility to avoid transporting livestock diseases between facilities. Livestock animals are susceptible to diseases from other facilities and human carriers are a risk to livestock operations. Failure to follow proper biosecurity precautions could spread livestock illnesses like foot-and-mouth disease (*Aphthae epizooticae*) or avian influenza. Without the proper precautions, CAFO inspectors might unintentionally transport diseases between facilities on contaminated clothing, equipment, or vehicles. To minimize the risk that a CAFO inspector will carry diseases or infections into or between livestock facilities, CAFO inspectors should always follow EPA’s biosecurity procedures (Appendix AF, “Standard Operating Procedure (SOP): Biosecurity Procedures for Visits to Livestock and Poultry Facilities”). CAFO owners or operators may or may not ask visitors to abide by their site-specific biosecurity measures. Regardless of whether the producer makes the request, EPA inspectors should follow the Biosecurity SOP at all livestock and poultry facilities. If the visited operation has additional measures, the inspector is strongly encouraged to follow them, as appropriate, at that specific facility.

Swine and poultry are typically most susceptible to diseases as the animals have limited contact with the natural environment and humans who do not work at the facility. Swine and poultry CAFOs may operate under the authority of an Integrator that oversees numerous facility operations, with different levels of biosecurity. When visiting a facility with various age groups of one species in one day, visit the youngest animal group first. Poultry is an exception. Poultry breeding stock should be visited before other commercial birds. Be aware that most swine facilities do not allow access to any person who has been to another swine operation within the past 72 hours. In addition, many swine operations do not allow access to anyone who has visited another livestock operation of any type within the past 24 hours. Poultry operations often will deny access to anyone who has had contact with other birds, even pet birds, within the past 48 hours.

CAFO inspectors must be aware of each facility’s biosecurity requirements to plan multiple inspections appropriately. Therefore, contacting the Integrator before making swine or poultry farm inspections may be helpful if the inspection plan involves making several different site inspections. The CAFO inspector might need to call in advance so that the biosecurity measures are known before the inspection and the information is accessible along with other pre-inspection information. At a minimum, inspectors should have biosecurity equipment in their vehicle should it be needed. Many CAFOs do provide biosecurity equipment for visitors but inspectors must have their own available to avoid being denied access for a lack of protective

equipment. Consult the Biosecurity SOP for a full list of personal protective equipment and supplies. If inspectors are denied access for biosecurity or any other reason, it should be noted in the inspector logbook/notes, along with the name of the facility contact who denied the access. Equipment and supplies are included in the Biosecurity SOP as well as procedures to follow (see Appendix AF, “Standard Operating Procedure (SOP): Biosecurity Procedures for Visits to Livestock and Poultry Facilities”).

Some highlights of the Biosecurity SOP are included below, but these are NOT a substitute for the procedures in the Biosecurity SOP.

- When EPA personnel are planning to visit a livestock or poultry facility, they should first contact USDA’s Animal and Plant Health Inspection Service (APHIS) or the state veterinarian to identify any areas with outbreaks of animal disease, where travel should be avoided.
- As a general rule, EPA will **not** conduct inspections on livestock or poultry facilities in areas with ongoing emergency foreign animal disease response activities (e.g., vaccination program, depopulation, disposal, or virus elimination).
- Do not make on-site visits to livestock operations if you have visited a foreign country and were exposed to or had contact with farm animals (with or without a known contagious disease) within 5 days before the site visit. Also, clothing and equipment (including shoes) worn or used on foreign farm visits should be cleaned before use on U.S. facilities. If appropriate cleaning is not possible, alternative clothing or equipment should be used.
- Some facilities have an established policy of requiring that their own vehicles be used for transportation purposes within the facility. An Integrator may also want to drive the inspectors from one farm to another, rather than allowing the inspector to take his or her vehicle. Inspectors may accept offers of facility-provided transportation within a facility if the total value of the transportation is \$20 or less. Consult with your ethics counselor if the total value of the transportation exceeds \$20, or you will be transported in non-ground transportation (e.g., aircraft or helicopter) or transported across more than one facility. For other situations, consult with your ethics counselor.
- On entering a facility, acknowledge any and all other livestock facilities visited within the previous 48 hours, including whether EPA entered any animal confinement or waste storage areas.
- EPA should only enter animal production buildings if it is essential to complete the goals of the visit, and should avoid contact with livestock, poultry or other animals (wild or domestic) on any facility.
- Use disinfectants that have been registered (or exempted) by EPA for the intended use. EPA’s pesticide registration program maintains information on EPA registered disinfectants. Information can be found at <https://www.epa.gov/pesticide-registration/selected-epa-registered-disinfectants>.

- Keep a copy of the label and the Safety Data Sheet (SDS) for any registered disinfectant used and make both available to the facility operator upon request. Follow all label safety precautions and dispose of empty containers, unused disinfectant solution, and used disinfectant in accordance with label instructions.
- In consultation with Health and Safety staff, identify an appropriate location such as an EPA or state laboratory, or office, for disposal of soiled disposable items in case the owner/operator will not allow the waste to remain on-site.

Inspector Safety and Personal Protective Equipment (PPE)

In addition to animal safety and biosecurity, CAFO inspectors must also be aware of specific safety risks that may be encountered during a CAFO inspection. The CAFO inspector should be familiar with all safety obligations and practices, both EPA's and the facility's, to avoid unnecessary risks. Safety equipment and procedures required for a facility will be based on EPA's standard safety procedures or if used, by the CAFO's response to the 308 Letter. See Appendix AG, "Field and Personal Protective Equipment," for additional safety information. Safety requirements must be met, not only for safety reasons, but to ensure that the CAFO inspector is not denied entry to the facility or parts of it. Below are several safety issues that an inspector might encounter at a CAFO.

- **Pesticide spraying and storage.** CAFOs might store pesticides in both concentrated and dilute form. CAFO inspectors should never enter an area where pesticides are being applied. The CAFO inspector should be able to recognize a pesticide sign, and before entering an area where pesticides have been applied the inspector should determine the type of pesticide applied, the time and date of application, and whether the area is safe to enter.
- **Confined spaces.** Gases such as hydrogen sulfide, carbon dioxide, ammonia, and methane are present in all stored manure, and if not properly ventilated, can reach concentrations dangerous to humans. Covered or enclosed tanks present the greatest danger, especially when manure is being agitated or pumped out of the structures. CAFO inspectors should not enter confined spaces used to store manure or silage. If entering a confined space is necessary, the inspector must be certified for confined space entry.
- **Drowning** is a possibility where semisolid, slurry, and liquid manures are stored. Liquid or slurry manure stored in an open impoundment often forms a surface crust. The thickness of the crust depends on the moisture content and consistency of the manure. However, under no conditions is the crust solid enough to support a human being. CAFO inspectors should never step on any crusted surfaces during an inspection. Also, look out for open trenches or sumps in barns or other structures; the drop off may not be immediately visible if the storage is full or the floor is covered with bedding, litter or other wastes.



- **Electrocution.** Some CAFO operators use tractors to power pumps when transferring waste out of storage lagoons. The power sources (takeoffs) present both electrical hazards and physical hazards for CAFO inspectors wearing loose-fitting clothing. Facilities being washed present an electrocution hazard to the CAFO inspector. Wash water might conduct electricity from wiring, connections, or equipment to persons in contact with that water. CAFO inspectors are advised to stay out of facilities during wash down. Electric fencing may be in place to keep animals in designated grazing areas or exercise lots, or to keep animals out of waterways. Inspectors should avoid touching or climbing over or under a “live” wire fence to avoid an electric shock. Facility operators can usually open or disable a live fence so that inspectors can access areas as needed.
- **Equipment used for handling, transporting, and applying manure** can be hazardous to the operator and to others close by. The operator’s manual for the equipment should document the potential hazards for that equipment. Common hazards include getting clothing or limbs caught in moving equipment parts; injury from escaping hydraulic fluid; and slippage of tractors, loaders, and spreaders. CAFO inspectors should exercise appropriate caution (e.g., not wearing loose-fitting clothing) around any machinery encountered during an inspection. Inspectors should also take care to alert truck drivers and equipment to their presence to prevent accidents.
- **Disease and Illness.** Very few animal diseases are of concern to humans. However, persons with low immunity can contract a specific respiratory illness from poultry called histoplasmosis. Livestock can carry bacteria, fungi, and parasites that cause illnesses such as cryptosporidiosis, ringworm, salmonella, giardiasis, leptospirosis, and complications from exposure to *E. coli*. Other illnesses, such as Q fever, anthrax, pseudocowpox, and rabies are less common, but can result from close contact with livestock. Pregnant women are at increased risk from some of these diseases (cryptosporidiosis, listeriosis, and Q fever) (Pelzer and Currin, 2009; Adams, 2012). Fortunately, many of these diseases are rare. Nevertheless, CAFO inspectors should avoid entering animal confinement areas unless necessary to adequately assess compliance. In addition, the inspector should never touch an animal at a CAFO and should follow all the biosecurity precautions in the previous section to minimize risk and exposure.

For any safety- or health-related issues not covered in this manual, CAFO inspectors should consult with their Health and Safety staff.

Health and Safety Tips for CAFO Inspections

- Always wear appropriate PPE; this includes long pants and safety boots (reinforced toe and at least ankle height), sunscreen, and mosquito repellent (containing DEET or Picaridin), as appropriate. A dust mask may be appropriate during windy or excessively dry weather. A safety vest may improve visibility to equipment operators.
- Maintain a safe distance from wastewater lagoon edges and observe from upwind, whenever possible.
- Do not enter confined or enclosed spaces where manure is being stored. Methane released by manure can be lethal. Inspectors must not enter any confined spaces without proper certification.

Health and Safety Tips for CAFO Inspections

- Do not enter fenced-in areas unless you are accompanied by the operator or can observe the entire enclosure to ensure no animals or other hazards exist.
- Be aware of snakes while walking around a CAFO. Avoid walking through areas of heavy brush where you could startle a snake and provoke a strike. Wear boots at all times. If a snake is encountered remain silent, step away slowly, and otherwise remain motionless.
- Be aware of dogs while approaching CAFOs and during your inspection. If a dog is preventing entry to the CAFO, telephone the facility contact and ask that the dog be restrained. As with all animals at a CAFO, do not pet or touch dogs.
- Keep anti-bacterial hand wash or wipes in your vehicle. Clean hands frequently and after each inspection.
- Other types of standard safety equipment may also be warranted, e. g., a hard hat if the facility has active construction underway, or ear protection where exhaust fans may be in use.

General Facility Information

Prior to the inspection, it is good practice to locate the CAFO on a topographic map and the inspector may want to obtain aerial imagery of the facility. A variety of free Internet-based tools can provide topographic maps and aerial imagery for a specific address or GPS coordinates. EPA Regions may have subscriptions to additional mapping resources, such as TerraServer, or have an in-house GIS team or contacts. Note that in rural areas the CAFO's mapped address may not correspond with the production area, for example, it may correspond to the owner's home address. In addition, older imagery may show newer operations. If the facility's production area is not specifically identifiable on aerial imagery, the CAFO inspector should print out several larger scale images that show areas near the address. The facility representative may need to identify the operation's location on these aerial images, in addition to satellite locations such as heifer farms.

The aerial image can be used to locate CAFO production areas, land application areas, and nearby surface waters. A facility diagram or aerial image should be reviewed with the CAFO representative during the inspection to label structures, storage areas, property boundaries, land application fields, and other facility characteristics. The annotated diagrams and aerial image(s) should be attached to the inspection report for reference (See Appendix AH, "Mapping Tool (Region 5)").

Facility Information That Should Be Gathered Before a CAFO Inspection

- ✓ Maps and aerial photographs of the CAFO.
- ✓ Facility's site plan.
- ✓ Names, titles, and telephone numbers of responsible CAFO officials.
- ✓ Description of animal types and agricultural processes.
- ✓ Typical livestock population and maximum capacity.
- ✓ Approximate distance to nearest surface water(s).
- ✓ Water quality/impairment status of the surface water(s).
- ✓ Closest floodplain, if available.
- ✓ Changes in CAFO conditions since previous inspection/permit application.
- ✓ Any known safety and biosecurity requirements.

Facility Information That Should Be Gathered Before a CAFO Inspection

- ✓ Permit, if the facility has permit coverage, or state requirements, including state technical standards, if the facility is unpermitted and land applies manure.
- ✓ Nutrient Management Plan, if the facility has one, or whatever nutrient management planning has been submitted if the facility is unpermitted.
- ✓ Identify any missing or incomplete information.

Locating the target facility on a topographic map is useful for measuring distances and potential flow paths to waters of the United States. The topographic map will show the natural gradient around the facility. This can be used to determine areas where stormwater may flow overland on to the site, areas that may require clean water diversions, and areas where water may drain from the site. Once the names of nearby surface waters are identified, the CAFO inspector should refer to the state's Clean Water Act section 303(d) list of impaired waters to determine if surface water segments adjacent to or downstream of the facility are impaired for nutrients, sediment, or other potential pollutants that could be discharged from the CAFO.

Useful mapping resources include:

- NRCS' Web Soil Survey maps (<http://websoilsurvey.nrcs.usda.gov/app/WebSoilSurvey.aspx>) can be used to identify soil types expected under the CAFO's production area and their characteristics.
- Federal Emergency Management Agency (FEMA) flood maps (<https://msc.fema.gov/portal/howto>) can be used to estimate if the facility is in a mapped flood zone.
- EPA's Watershed Assessment, Tracking and Environmental Results System (WATERS) (<https://www.epa.gov/waterdata/waters-watershed-assessment-tracking-environmental-results-system>) can be used to identify impaired waters, TMDLs, provide maps of surface waters, etc.

Review of Permit and Facility Files

Collection and analysis of available facility background information are essential to the effective planning and overall success of a compliance inspection. Materials from available files and other information sources will enable CAFO inspectors to familiarize themselves with facility operations; conduct a timely, thorough and efficient inspection; clarify technical and legal issues before entry; and develop a sound and factual inspection report. The types of information that may be available for review are listed below and discussed in detail in the following sections. The CAFO inspector is responsible for determining the amount of background information necessary for the inspection and in collecting this information should focus on the characteristics unique to the permittee: site-specific NPDES permit requirements, historical wastewater and manure management practices, nutrient management, proximity to waters of the United States, compliance history, etc.

The CAFO inspector may not have much facility-specific information available prior to the inspection of an unpermitted facility. The CAFO inspector is expected to review the permit and

compliance file in advance of an inspection at a permitted CAFO. If the inspector suspects that an unpermitted CAFO or AFO may meet the criteria for permit coverage, familiarity with an available general permit, or an individual permit for a similar type of facility in that state, will be helpful in assessing conditions at the facility.

Some states may have state-issued CAFO permits that are *not* NPDES permits, though many of the objectives and provisions are similar. In addition, some states issue permits that do fulfill NPDES requirements, but may also include “above and beyond” provisions stipulated by state regulations (e.g., groundwater protection). EPA does not conduct compliance inspections for non-NPDES permits, or the non-NPDES provisions of “dual purpose” permits.

A facility with a non-NPDES state issued permit may still need NPDES coverage; for purposes of the inspection these facilities can be considered unpermitted facilities. If conducting a joint inspection with a state inspector on a “dual purpose” permit, the state inspector should take the lead on questions and discussions about provisions and issues that are not required by the NPDES regulations.

Files Checklist

- ✓ Conditions and requirements of the permit.
- ✓ Nutrient management plans/practices, NMP terms.
- ✓ Inspection notes and issues, along with any previous site entry problems.
- ✓ Prior compliance problems, enforcement actions, and correspondence.
- ✓ Prior complaints.
- ✓ Most recent and any previous annual reports.

Conditions and Requirements of the Permit

Reviewing a CAFO’s NPDES permit and nutrient management plan (NMP) is useful for finding site-specific information such as facility size, number and type of animals, and manure and wastewater management practices. CAFOs covered under a general permit will also have a site-specific nutrient management plan.

While reviewing the permit, the CAFO inspector should pay special attention to the permit requirements, nutrient management plans/practices, NMP terms, including identification of site-specific records to be maintained and annual reports. If a facility has had previous individual permits, it can be useful to review them, if available, to see if there has been any operational changes or changes to the number of animals confined over time.

The inspector should give special consideration to permit requirements that are unique to that operation. CAFO general permits stipulate the same provisions for every operation, perhaps with some sector-specific or region-specific provisions; the nutrient management plans for each facility will be site-specific. Individual permits are tailored for each specific operation and may include compliance schedules that extend deadlines for the CAFO to meet certain requirements. The inspector should determine how he or she will evaluate compliance with both general and site-specific requirements before conducting the inspection.

To become familiar with a CAFO permit and NMP terms, CAFO inspectors should review the example CAFO General Permit provided in Appendix O and the example NMP in Appendix P of EPA's *NPDES Permit Writers' Manual for CAFOs* (EPA, 2012a).

Requirements, Regulations, and Limitations

In addition to the CAFO permit, the CAFO inspector should review in detail the applicable EPA and state regulations and effluent limitation guidelines (ELGs). If the facility to be inspected is an unpermitted CAFO, state regulations may establish the bulk of the applicable requirements. For unpermitted large CAFOs the federal NPDES regulations prohibit discharges from the production area and establish certain nutrient management requirements for the land application area (See the "Overview of the NPDES Program for CAFOs" in Section A).

For unpermitted large CAFOs, the inspector will review the facility's documentation and implementation of nutrient management practices to determine if the land application areas qualify for the agricultural stormwater exemption (see Section A for information on land application requirements). A large CAFO's nutrient management planning must account for appropriate site-specific best management practices, protocols for appropriate manure and soil testing, appropriate protocols for land application, and maintenance of records to document the implementation of those BMPs.

In these cases, the inspector should gather records and make observations regarding:

- Nutrient recommendations and average yields for prevalent crops.
- Implementation of the permitting authority's technical standards for nutrient management such as requirements for soil and manure testing, development of manure application rates and timing restrictions on land application (e.g., prohibition on applying manure on snow covered or saturated ground).
- Standards or other guidelines for installation, operation, and maintenance of common best management practices, including for the required setbacks or vegetated buffers.

Annual Reports

All NPDES permits for CAFOs must include a requirement that the permittee submit an annual report with specific information defined in the regulation (40 CFR 122.42(e)(4)). Refer to Appendix C of EPA's *NPDES Permit Writers' Manual for CAFOs* (EPA, 2012a) for an example annual report. The CAFO's annual reports will include the following required information:

Permit Conditions and Requirements Checklist

- ✓ General and site-specific or BPJ effluent limitations.
- ✓ Monitoring and reporting requirements.
- ✓ NMP terms and the NMP.
- ✓ Special exemptions, compliance schedules, and waivers, if any.
- ✓ Changes in site conditions (when compared with previous permits).

Requirements, Regulations, and Limitations Checklist

- ✓ Copies of regulations, requirements, and restrictions placed on CAFO discharges.
- ✓ Monitoring and reporting requirements (if not reflected in a permit).
- ✓ Special exemptions and waivers, if any.

- The number and type of animals confined at the CAFO.
- Estimated total amount of manure, litter, and process wastewater generated by the CAFO in the previous 12 months (tons/gallons).
- Estimated total amount of manure, litter, and process wastewater transferred to other persons by the CAFO in the previous 12 months (tons/gallons).
- Total number of acres for land application covered by the NMP.
- Total number of acres under control of the CAFO that were used for land application of manure, litter, and process wastewater in the previous 12 months.
- Summary of all manure, litter, and process wastewater discharges from the production area that have occurred in the previous 12 months, including the date, time, and approximate volume of the discharge.
- A statement indicating whether the current version of the CAFO's NMP was developed or approved by a certified nutrient management planner. The CAFO inspector should check with the issuing agency on the status of the certification.
- The actual crop(s) planted and actual yield(s) for each field.
- The nitrogen and phosphorus content of the manure, litter, and process wastewater as reported on the laboratory report for the required analyses (lbs./ton, g/Kg, pounds/1,000 gallons, mg/L, ppm).
- The results of calculations conducted in accordance with the approved NMP to determine the amount of manure, litter, or process wastewater to apply.
- The amount of manure, litter, and process wastewater applied to each field during the previous 12 months.
- For any CAFO that implements an NMP that addresses rates of application in accordance with the narrative rate approach:
 - The results of any soil testing for nitrogen and phosphorus conducted during the previous 12 months.
 - The data used in calculations conducted in accordance with the methodology in the approved NMP to determine rates of nitrogen and phosphorus application from manure, litter, and process wastewater.
 - The amount of any supplemental fertilizer applied during the previous 12 months.
- All required records for manure transferred off-site to another entity.

Reviewing consecutive years of annual reports can reveal whether a CAFO is increasing production or changing nutrient management practices.

Discharge and Monitoring Reports

Permitted CAFOs are required to report certain information associated with discharges. CAFO permits might also include ambient stream monitoring, or other special monitoring requirements. State regulations might establish similar discharge reporting and other monitoring requirements for unpermitted CAFOs. The CAFO inspector should review all monitoring and discharge information in the facility file to get an idea of the nature and frequency of facility discharges, if any.

Facility Compliance and Enforcement History

Previous inspection reports will document general CAFO information and site photos, as well as problems or concerns. Inspectors who have visited the CAFO for NPDES or other regulatory programs may also be contacted to provide additional information or answer questions about the facility. The CAFO inspector will find it useful to have a copy of photos from past inspections to see how the CAFO has changed and if photo-documented compliance issues have been resolved.

Other EPA staff and state personnel should be consulted regarding correspondence, inspection reports, permits, and permit applications for individual facilities. They can provide compliance, enforcement, and litigation history; special exemptions and waivers applied for and granted or denied; citizen complaints and action taken; process operational problems and solutions; pollution problems and solutions; and, other proposed or historical remedial actions.

The CAFO's history of enforcement actions and its response to them tell a story about the operator and production practices. For example, inspecting a CAFO with a history of production area discharges will likely involve extensive review of manure management records, depth marker logs, and corrective actions. The CAFO inspector will want to examine manure storage structures, the production area, and flow paths for evidence of discharge. The CAFO inspector

Considerations When Reviewing Annual Reports

- ✓ Are the reports complete? If not what information is missing?
- ✓ Have there been any significant operational changes at the CAFO over time (i.e., new construction at the facility)?
- ✓ Does reported annual manure production seem reasonable for the number of reported animals and does the CAFO use the same manure production factors each year (e.g., weight or volume of manure per animal)?
- ✓ Is the amount of manure land applied or transferred similar to the amount of manure generated?
- ✓ Does the amount of acreage available seem adequate for the amount of manure land applied?
- ✓ Are nutrient calculations consistent with the approved NMP?

Facility Compliance and Enforcement History Checklist

- ✓ Previous inspection reports.
- ✓ Documentation of past compliance violations and the status of requested regulatory corrective action, if any.
- ✓ Enforcement actions such as compliance schedules and consent orders.
- ✓ Status of current and pending litigation against facility.
- ✓ Previous deficiency notices issued to facility.
- ✓ Complaints and reports, follow-up studies, findings, and remedial action.
- ✓ Correspondence between the CAFO and local, state, and federal agencies.

might also consider conducting this inspection during a storm event or at the end of a wet weather period, including snowmelt.

Sampling

If sampling is to be performed, part of the pre-inspection process will involve collecting, organizing, and preparing sampling equipment. The inspector's CAFO Inspection Plan should include whether sampling is expected and, if so, what types of sampling will be performed. The inspector should also prepare a sampling and analysis plan (SAP) or a quality assurance project plan (QAPP).

Sampling equipment will vary according to the media sampled, manure type (liquid, slurry, dry) if manure will be sampled, chemical parameters, and inspection type. Appendix AM, "Sampling Procedures and Equipment," includes a comprehensive list of field sampling equipment; the inspector should evaluate the equipment planned for use against documented sampling protocol. All equipment must be checked, calibrated, tested, logged, and packed for the inspection.

The inspector must plan for the proper preservatives and/or preservation methods (e.g., coolers with cold packs). In addition, if certain types of samples have holding times (i.e., a certain period of time that must not be exceeded before delivering the sample to the laboratory), the inspector should ensure that inspection time plus travel time do not exceed this threshold. For this reason, sampling may need to be scheduled towards the end of the inspection, and a time buffer built into the schedule to account for unanticipated delays. The inspector may have to pre-arrange to have samples delivered and analyzed at a local laboratory (near the facility) if samples cannot be delivered to an EPA laboratory within sample holding times. The inspector should also be prepared to follow the appropriate chain-of-custody procedures and provide the necessary documentation to ensure the results can be used in enforcement or other actions, as necessary. Refer to Basic Inspector Training or NPDES Inspection Manual for more information on chain-of-custody and documentation.

Quality Assurance Project Plan (QAPP)

EPA developed the QAPP as a tool for project managers and planners to document the type and quality of data needed for the agency to make environmental decisions and to describe the methods for collecting and assessing those data. The QAPP is required for all EPA projects resulting in the generation, collection, and use of primary environmental data such as water quality monitoring data. The QAPP ensures that the needed management and technical practices are in place so that environmental data used to support agency decisions are of adequate quality and usability for their intended purpose.

Prior to the start of data collection, a QAPP defining the goals and scope of the project, the need for sample collection, a description of the data quality objectives and quality assurance/quality control (QA/QC) activities to ensure data validity and usability must be developed by the project officer. Thereafter, a review by all parties to the sampling effort, such as a Quality Assurance (QA) Officer, must be conducted. Also, EPA laboratories will require a copy of an approved QAPP prior to conducting any sample analysis. This QAPP requirement

applies to both EPA staff and outside contractors. The process for approval of the QAPP and other documents related to the data collection activity should be outlined in the lead organization's Quality Management Plan (QMP) (see Appendix AN, "Sample Quality Assurance Project Plan (QAPP)").

Inspection Notification

EPA conducts both announced and unannounced inspections. Depending upon the specific circumstances and regional compliance strategies, the CAFO operator may or may not be notified in advance of the inspection. When EPA is leading the inspection, some regions notify the permittee in advance with a letter issued pursuant to Clean Water Act section 308, or "308 Letter," that the CAFO is scheduled for an inspection (see Appendix E, "Sample CWA Section 308 Information Collection Request Letter (308 Letter)"). The 308 Letter notifies the permittee that an inspection is imminent and usually requests information regarding on-site safety and biosecurity requirements. The 308 Letter may specify the exact date of the inspection, if coordination with the permittee is required. The 308 Letter also is used to inform the permittee of the right to assert a claim of confidentiality. The 308 Letter may be issued in conjunction with verbal communication with the CAFO operator to schedule an appropriate meeting time and location and to discuss biosecurity and safety procedures. The 308 Letter can also be used to obtain information prior to the inspection regarding manure storage and handling practices, not otherwise available. The CAFO inspector should consult with regional management regarding the process for developing and issuing these letters.

The CAFO inspector may also notify the appropriate state regulatory agency that an inspection will be conducted, and typically must notify an Indian country regulatory agency in advance of inspections to be conducted in their jurisdictions. The CAFO inspector should be prepared to respond to requests from state or Indian country agency staff to ride-along or participate in the inspection, whether for information exchange or training purposes. EPA policy with respect to Indian country inspections and notifying state agencies is addressed in the *NPDES Inspection Manual*; EPA Regions may have additional guidance with respect to pre-inspection notification.

CAFO INSPECTION PLAN

Developing a CAFO Inspection Plan is the final step of the pre-inspection process and will assist the CAFO inspector in performing the actual CAFO inspection. The CAFO inspector should develop a comprehensive inspection plan to define the inspection type, objectives, tasks and procedures, resources required to fulfill the objectives, tentative inspection schedule, and reporting deadlines. The following items need to be considered relative to the type of inspection (e.g., status determination, permit compliance, follow-up, settlement, or complaint inspection).

- Objectives (depends on inspection type):
 - What is the purpose of the inspection?
 - What is the compliance determination strategy?
 - What is to be accomplished on-site?
 - What is to be accomplished after leaving the site?

- Tasks (depends on purpose of inspection):
 - What specific tasks will be conducted?
 - What records will be reviewed?
 - What information must be collected (photocopies, samples, etc.)?
- Procedures (depends on activities anticipated):
 - What procedures are to be used?
 - Will the inspection require special procedures?
- Resources:
 - What personnel will be required?
 - What equipment will be required?
- Schedule:
 - What will be the time requirements and order of inspection activities?
 - When will the inspection report be sent to the facility?
- Pre-notification/coordination:
 - Will the facility be notified in advance of the inspection? If so, how many days in advance and by what method (phone, mail, email, fax, or some combination of these)?
 - Does the inspection need to be coordinated with EPA attorneys or other EPA compliance staff or regulatory programs?
 - Which other federal and state agencies need advance notice of the inspection?
 - If not done in advance, how and when will the facility be notified of the inspection?

The outline of tentative inspection objectives and records that will be reviewed should be prepared in advance and can be presented to the CAFO representative(s) during the opening conference.

Review Checklists

In addition to the specific items mentioned in this chapter, to facilitate the CAFO inspection process, a detailed National CAFO checklist based on the NPDES CAFO regulations and CAFO ELG requirements has been developed. The checklist is useful in collecting information associated with the NMP and the minimum practices. EPA Regions have developed similar checklists particular to regional issues and some have prepared sector-specific checklists (see Appendix AI, “Inspection Checklist,” and Appendix AJ, “Regional Inspection Checklists”). The CAFO inspector should select or develop a checklist appropriate to the CAFO: permitted, unpermitted, or sector-specific.

The CAFO inspector should photocopy appropriate checklist(s) to be used during the inspection and consider bringing extra copies in case the facility requests a copy during the inspection. The CAFO inspector should also consult this checklist when reviewing the CAFO's facility files.

C. THE CAFO INSPECTION—FACILITY TOUR

This section covers the CAFO site inspection facility tour including entry activities, the opening conference, limited on-site records and document review, the facility tour, and the closing conference. Section 4, “The CAFO Inspection—Records Review and the NMP,” will cover how to evaluate the facility's records and implementation of the terms of the NMP.

The information presented in this section is intended to be comprehensive and broadly applicable to the majority of EPA inspections at permitted and unpermitted CAFOs; however, there will always be situations that require inspectors to rely on their best professional judgment, knowledge of the regulations, and familiarity with EPA Region-specific policies. As such, the inspector should recognize that each inspection is different and will generally involve the activities discussed below; the amount of time dedicated to each may vary. In addition, an inspection might only include a subset of the elements below as dictated by the compliance determination strategy and the CAFO Inspection Plan. Nevertheless, all inspections do share common components and the general structure and approach to an inspection will not vary significantly across facilities and inspection types.

ARRIVAL ON-SITE

CAFO inspections may be announced or unannounced; entry procedures are similar for both. However, during an announced inspection the inspector may have an easier time locating the responsible facility representative. As described in Section B, a 308 Letter may be used to notify the CAFO of an upcoming inspection. See an example 308 Letter in Appendix E. A 308 Letter can also be used to gather information important to the inspection prior to the actual announced or unannounced inspection.

The inspector should arrive at the CAFO at the scheduled time, if announced, or during normal working hours if unannounced. The owner, operator, foreman, or other responsible person should be located as soon as the inspector arrives on the premises. The inspector may want to present the CAFO representative with an official inspection introduction letter identifying the purpose of the inspection, inspection authority and contact phone numbers. See Appendix AL, “Inspection Introduction Letter.” As previously mentioned, the inspector should recognize that the CAFO may be a small business with a minimal number of employees. The inspection may have to wait until a livestock truck is loaded or unloaded, cows are milked, or other routine activities are finished. In addition, the inspector may have to knock on the door of the on-site residence to locate the responsible individual, especially if the inspection is unannounced.

Credentials

When a knowledgeable CAFO representative(s) has been located, the inspectors must introduce themselves as EPA inspectors and present official EPA credentials. Inspectors should also provide a business card with contact information to the CAFO representative. The

credentials identify the holder as a lawful representative of the regulatory agency and authorized person to perform CAFO inspections. **The inspector's credential must be presented regardless of whether identification is requested.** If any EPA staff members accompanying the inspector do not have credentials, they must have their EPA identification readily available.

If the CAFO representative(s) question the inspector's credentials after the credentials have been reviewed, those individuals should telephone the appropriate state or EPA Regional Office for verification of the inspector's identification. The inspector should keep possession of the credentials at all times; credentials must never leave the sight of the inspector or be photo-copied.

Consent

Consent to inspect the premises must be given by the owner or operator at the time of the inspection. Expressed consent is not necessary; absence of an expressed denial constitutes consent. As long as the inspector is allowed to enter the CAFO, entry is considered voluntary and consensual, unless the inspector is expressly told to leave the premises.

Reluctance to Give Consent

Some CAFO representatives will be agreeable to the inspection, but others will require additional explanation and/or clarification regarding EPA's authority to inspect their operation. Inspectors may want to share EPA's fact sheet with answers to commonly asked questions to help livestock and poultry operation owners and operators understand what to expect from EPA NPDES inspections (EPA, 2014). The factsheet is available at <https://www.epa.gov/compliance/fact-sheet-livestock-and-poultry-operation-inspections>. Examples where entry or consent may require more time and explanation include areas with newly issued NPDES CAFO permits, CAFOs that have not previously been inspected, and inspections following well-publicized compliance settlements. In some cases, representatives may be reluctant to give entry consent because of misunderstood responsibilities, inconvenience, or other reasons that may be overcome by diplomacy and discussion. If consent to enter is denied, the inspector should follow denial of entry procedures detailed in the section below.

Whenever there is a difficulty in gaining consent to enter, inspectors should tactfully probe the reasons and work with the CAFO representative to overcome the problems. Care should be taken, however, to avoid threats of any kind, inflammatory discussions, or deepening of misunderstandings. If the situation is beyond the authority or ability of the inspector to manage, the inspector should follow contingency plans identified before the inspection. Typically, those plans include contacting the inspector's supervisor and/or the Office of Regional Counsel for further direction.

Denial of Entry or Consent

If the CAFO representative considers the inspection to be an adversarial proceeding, the legal authority, techniques, and inspector's competency may be challenged. CAFO representatives may also display antagonism toward EPA personnel. In all cases, the inspector must cordially explain the inspection authorities and the protocols followed. If explanations are not

satisfactory or disagreements cannot be resolved, the inspectors should leave and obtain further direction from their EPA supervisor or EPA's Office of Regional Counsel. Professionalism and politeness must prevail at all times.

Entry Tip

The inspector should maintain a neutral tone throughout the inspection and avoid confrontational subjects, particularly politics, animal welfare, environmental issues and livestock agriculture.

Under no circumstances should the inspector discuss potential penalties or do anything that may be construed by the facility representative as coercive or threatening.

Inspectors should use discretion and avoid potentially threatening or inflammatory situations. If inspectors are threatened or otherwise uncomfortable, they should leave the facility immediately, document the

confrontation, and report it immediately to their EPA supervisor or EPA staff attorney. If feasible, statements from witnesses should be obtained and included in the documentation.

If the facility representative asks the inspector to leave the premises after the inspection has begun, the inspector should leave as quickly as possible following the procedures discussed previously for denial of entry. All activities and evidence obtained before the withdrawal of consent are valid so the inspector should carefully document the time the inspection ended. The inspector is expected to act professionally, adhere to all biosecurity requirements, and collect all personal and government equipment before leaving the facility.

If, during the inspection, the CAFO representative denies or revokes access to parts of the facility integral to evaluating compliance with the regulations, the inspector should record the circumstances surrounding the denial of access and of the portion of the inspection that could not be completed. The inspector should then complete the rest of the inspection. After leaving the CAFO, the inspectors should contact their EPA supervisor or staff attorney to determine whether a warrant should be obtained to complete the entire inspection.

Authority to Conduct Inspections

EPA has the authority to regulate and inspect CAFOs through requirements established in the CWA and its implementing regulations:

- Section 301 of the CWA prohibits the discharge of pollutants to waters of the US unless in compliance with an NPDES permit or other provisions of the CWA.
- Section 502(12) of the CWA defines “discharge of pollutants” to mean the addition of a pollutant to navigable waters from a “point source.” The term “point source,” in turn, specifically includes CAFOs. Section 502(14).
- Section 308 of the CWA authorizes EPA to enter any premises in which an effluent source is located. This broad authority allows EPA to inspect operations where discharges from point sources such as CAFOs are suspected or located. It also allows EPA to review and copy records and collect discharge samples or other information from effluent sources, as required, to carry out the objectives of the CWA, which includes determining whether NPDES permit conditions are being met or whether an operation is discharging without a permit.

- Section 402 of the CWA requires NPDES permittees to comply with the terms of the permit, including any specific discharge limits and operating requirements.
- The regulations at 40 CFR 122.23 and 122.42 establish the NPDES permitting requirements for CAFOs.
- The regulations at 40 CFR 123.26 establish procedures and objectives for routine inspections of NPDES-permitted facilities by state programs.

Claims of Confidentiality

The inspector should explain the permittee's right to claim material as confidential and that the inspector may examine areas related to waste production or storage even if the permittee has asserted claims of confidentiality. See the *NPDES Compliance Inspection Manual* (EPA 2016) for details on how to handle claims of confidential business information.

Waivers, Releases, and Sign-In Logs

The CAFO operator may provide the inspector with a blank sign-in sheet, log, or visitor register. The inspector should clarify what they can and cannot sign with EPA Regional Counsel prior to the inspection. However, **EPA inspectors or other EPA representatives are prohibited from signing any type of "waiver" or "visitor release" that relieves the CAFO of responsibility for injury or that would limit the rights of EPA to use data obtained from the facility.** If such a waiver or release is presented, the inspectors should politely explain that they cannot sign. They may request and sign a blank sign-in sheet.

Explaining the CAFO operator's right to claim confidentiality for certain types of information may help to alleviate concerns about use of data. If inspectors are refused entry because they do not sign the release, they should leave and immediately report all pertinent facts to the appropriate supervisor and/or legal staff. All events surrounding the refused entry should be fully documented. Problems should be discussed cordially and professionally.

OPENING CONFERENCE

Once credentials have been presented and legal entry established, the inspector can proceed to outline inspection plans with the CAFO representative(s). At the opening conference, the inspector provides names of the inspectors, the purpose of the inspection, authorities under which the inspection is being conducted, provides a copy of the NPDES regulations or other fact sheets concerning the regulation of CAFOs, and procedures to be followed. EPA encourages cooperation between the inspectors and CAFO representative to ensure that the inspection is efficient, professional, and successful.

The inspector will explain the order of activities during the inspection; records review followed by facility tour or vice versa. The inspectors should tell the operator how long they expect to be on-site. This will help to eliminate wasted time by allowing representatives to make records and personnel available. The inspector may have to be flexible to accommodate previously scheduled farm activities like milking, feeding, or unforeseen emergencies.

If not provided in advance, a written list of CAFO records needed for the inspection should be provided to the CAFO representatives. This will help the representatives to gather the records and make them available for the inspector. Commonly required records include, but are not limited to:

- NPDES permit.
- Nutrient management plan.
- Visual inspection logs (e.g., inspection of water lines, wastewater impoundments, lagoon depth recording).
- Manure transfer records.
- Laboratory soil and manure test results.
- Operator identified deficiencies and corrective actions.
- Calibration records for nutrient application equipment.
- Discharge monitoring records.
- Records of inspecting nutrient application equipment for leaks.
- Nutrient application records.
- Mortality management records.

Records Tip

Sending the CAFO a list in advance of records that may be reviewed during the inspection will expedite the on-site records review. Notifying the CAFO officials prior to the inspection will enable them to assemble the appropriate records as well as give them an idea of what to expect from the inspection.

The inspector should also identify structures and activities that need to be evaluated during the facility tour. The inspector should be prepared to answer questions about the relevancy of activities and buildings to regulatory compliance. At this point in the opening conference the inspector should ask about site-specific biosecurity equipment and procedures that need to be followed during the inspection, if the topic has not already been discussed. The biosecurity discussion should include:

- Site specific protocols that must be observed by the inspector (e.g., shower in/shower out, booties or foot wash, gloves).
- Biosecurity concerns that may dictate the order of areas visited, or areas that are accessible to the inspector. See Section B for a more detailed discussion of biosecurity.

Finally, the inspector will provide an overview of general inspection follow-up procedures. This information will be repeated at the end of the inspection. Inspectors should check with their state or EPA Regional contacts for any state or region-specific protocols.

The inspector will then turn the opening conference over to the CAFO representative(s) for an overview of the operation with a focus on manure/nutrient

Ask Basic Facility Information During the Opening Conference

- Verification of the name, address, and telephone number of the facility.
- Who is the authorized representative for the facility?
- Is the facility leased, along with contact information for lessor and lessee?
- Questions concerning the facility's history, including any discharges.

management and any questions the representative(s) may have about the inspection or the inspection process.

Before the record and document review begins, the inspector and CAFO representative(s) may review facility diagrams, maps or aerial images (e.g., Google Earth, TerraServer, or similar) and label significant structures such as the production area, feed and manure storage areas, land application areas, flow paths, property boundaries, drinking water wells, and other facility features. If aerial images are used it may be helpful to provide one close view of the production area and at least one larger scale view of the entire operation. These images can be scanned and attached to the inspection report.

RECORD AND ON-SITE DOCUMENT REVIEW

Federal CAFO regulations require both permitted and unpermitted large CAFOs to maintain records. Unpermitted large CAFOs that land apply manure are required to keep records to demonstrate that they only discharge agricultural stormwater from land application areas. See Chapter 4.1.8. of the *NPDES Permit Writers' Manual for CAFOs* (EPA, 2012a) for a detailed discussion of the agricultural stormwater exemption. Permitted CAFOs must maintain records to demonstrate compliance with their NPDES permit.

Regardless of the CAFOs permit status, the inspector should first verify basic information about the facility to identify changes in ownership or operational characteristics.

- ✓ Do EPA records correctly identify the CAFO owner, operator, and contact information?
- ✓ What is the size of the facility, both acreage (production area and non-production area) and number and type of animals?
- ✓ How does the CAFO handle and store manure?
- ✓ What are the current nutrient management practices, cropping, and location of land application sites?

The inspector should review CAFO records to see if recordkeeping requirements are being met. The review of available records and reports should answer the following questions:

- ✓ Is the CAFO collecting the required data?
- ✓ Is all the required information available?
- ✓ Is the information current?
- ✓ Is the information being maintained for the required time period?
- ✓ Do the records reviewed indicate areas needing further investigation?
- ✓ Are the records organized?
- ✓ Do the records demonstrate compliance with the CAFO's NPDES permit status (e.g., if permitted, has the CAFO submitted Annual Reports)?

Records specific to land application requirements are covered in Section D.

FACILITY TOUR

The inspector will ask the facility representative to accompany him or her on a tour of the facility. The purpose of the facility tour is to assess existing conditions, gather information to determine if the CAFO is operating in compliance with the CAFO's NPDES permit, or if the facility needs to submit a permit application or notice of intent (NOI) for NPDES permit coverage. During this phase of the inspection, the inspector will observe and photo document activities, structures and processes used to maintain the compliance with the CWA and/or the CAFO's NPDES permit. During the facility tour, the inspector should visit the following areas of the CAFO:

- Animal housing, feeding, feed storage, mortality management and maintenance areas.
- Manure and process wastewater collection, transport, storage, and treatment areas.
- Manure and process wastewater land application areas.

The inspector needs to carefully document the visual inspection with notes, photographs and/or videos. Occasionally the CAFO representative will take duplicate photos for their records. If the CAFO is discharging

during the inspection or there is evidence that the facility has recently discharged, the inspector might also take samples. See Appendix AM, "Sampling Procedures and Equipment" for more information on sampling. During the facility tour, the inspector might determine that additional records or documents need review. The inspector should inform the facility representative as soon as this has been determined to facilitate the retrieval of the needed information.

CAFO Operational Overview

Many details of how CAFOs are operated are provided in Appendix AD, "Animal Industry Overview." Refer to that section for details on sector-specific confinement facilities, as well as typical manure and mortality management practices.

Identification of Discharges

Basic considerations that can lead to discharges of manure, litter and process wastewater from the production area and land application areas are included here. See additional detail below.

Production Area Discharges

Production area discharges most commonly occur at spillways, man-made ditches or pipes designed to allow overflows during storm events. These overflow features are often located on the berms of a CAFO's wastewater impoundments or in and around animal feed storage areas, such as silage bunkers. Wastewater may also exit the facility at low lying areas where there is

Documentation Tips

- ✓ Make sure photos contain a distinguishing characteristic like a unique depth marker or buildings in the background.
- ✓ Impermanent items, such as vegetation, do not make good reference points as they can be easily removed.
- ✓ Photos should include an accurate date/time stamp that shows it was taken during the time period of the inspection.
- ✓ Some digital cameras include built-in global positioning system (GPS) tagging that allows an inspector to associate each photo with the geographic location where it was created.

no berm. Additional discharge locations may include rodent holes and open tile drains that are designed to carry wastewater away from the production area. Common scenarios that may lead to wastewater discharges from the production area include:

- Undersized or no feed, manure, or mortality storage capacity.
- Poor feed, manure, mortality storage structure operation and maintenance.
- No or undersized diversion structures.
- Poorly located waste and/or material storage areas (i.e., too close to drainage ditches or waterways).
- Insufficient dewatering.
- Clogged and/or broken water lines.

Land Application Area Discharges

Common scenarios that may lead to wastewater discharges from the land application areas include:

- Clogged and/or broken manure transportation lines/hoses.
- Over-application of manure, litter or process wastewater.
- Land applying manure, litter, or process wastewater to saturated, frozen or snow-covered ground (Note: Some states have manure spreading bans in winter months; check state technical standard).
- Type, size, location and maintenance of buffers.

Note that a CAFO's land application discharges that meet the definition of "agricultural stormwater" do not require an NPDES permit.

The following list provides example factors affecting the likelihood or frequency of discharges of manure, litter, and process wastewater:

- Slope of feedlot and surrounding land
- Feedlot surfacing (e.g., concrete or soil)
- Climate (e.g., arid or wet)
- Type and condition of soils (e.g., sand, karst)
- Amount and duration of rainfall
- Volume and quantity of runoff
- High water table

The inspector should look for evidence of actual or past discharges. Moist soil or ponded water located outside of the production area may be indicative of a recent discharge. More obvious evidence that a discharge has occurred may include erosive channels and/or dead vegetation from nitrogen burns leading from the production area and/or land application areas. In addition, wastewater discharges can carry debris and deposit them on the ground. Manure

located in a water or outside the production area and eutrophication in waters adjacent to the CAFO are other signs that might indicate recent or regular discharges.

CAFO Discharges to a Water of the United States

Where evidence of an actual or past overflow or spill is observed, it is important to find out whether it enters a water of the United States. It only becomes an unauthorized discharge if it enters a water of the United States. A water of the United States determination can be a complex process and involves consideration of both facts and legal standards. The inspector should consult with regional or state program and legal experts. The inspector's role is not to make waters of the United States determinations, but to collect the evidence needed for the state or regional experts to make the determinations if point source discharges reach waters of the United States. Inspectors should contact state or EPA experts for additional information or for training opportunities.

A short review of key points relevant to discharges from CAFOs follows.

- **A permit is required for a discharge of pollutants from a CAFO to waters of the United States.** A CAFO may not discharge without an NPDES permit. NPDES permits authorize CAFOs to discharge pollutants to waters of the United States when they are in compliance with permit conditions. Enforcement actions may be taken for any discharge to waters of the United States that occurs without an NPDES permit or for violations of permit conditions.
- **Discharges from CAFOs to waters of the United States are point source discharges subject to NPDES permit requirements.** Any discharge to a water of the United States from a CAFO is a discharge from a point source and must be authorized by an NPDES permit
- **Only CAFOs that discharge pollutants to waters of the United States need NPDES permits.** Coverage under an NPDES permit is not required for a CAFO that does not discharge pollutants to waters of the United States.
- **Unexpected discharges are not exempt from permit requirements.** The CWA does not distinguish between intentional and unintentional discharges in determining whether a permit is required. The fact that an unpermitted discharge was unexpected is not a defense to an enforcement action.
- **Discharges are not limited to manure, litter or process wastewater.** CAFO discharges subject to permitting requirements include discharges of any pollutant, including but not limited to manure, litter and process wastewater, silage/feed and bedding pollutants.
- **Discharges resulting from land application of manure, litter or process wastewater require a permit, unless they qualify as agricultural stormwater.** Discharges from the land application area are exempt from NPDES permitting requirements if they consist only of agricultural stormwater discharges. Section A describes the CWA "agricultural stormwater exemption."

Discharge Pathways at CAFOs

Discharges from a CAFO to waters of the United States may originate in the CAFO's production area, land application area(s), or other parts of the CAFO not specifically included in either of those definitions. For example, discharges of process wastewater could occur when equipment used to spread manure or clean out poultry houses is rinsed at a CAFO's truck wash facility.

To identify discharges, it is necessary to look at the operation as a whole and the variety of ways in which pollutants may be discharged looking at man-made components, operational features of the CAFO, as well as natural characteristics that can cause a CAFO to discharge. Note that a CAFO itself is a point source; a discharge to a water of the United States from a CAFO must be authorized by an NPDES permit regardless of whether the discharge occurs through an additional discrete conveyance (*Waterkeeper Alliance, Inc. v. EPA, 2005*) or if the discharge is to land not owned by the CAFO, and then to a water of the U.S, the CAFO is discharging pollutants to waters of the United States (*Sierra Club v. Abston Constr. Co., 1980*).

Production Area Discharges

This section focuses on the design, construction, operation, and maintenance aspects of CAFO production areas. Characteristics of the facility's production area may significantly influence its likelihood of discharging pollutants to waters of the United States. Examining these features of a CAFO's operation will help in identifying discharge pathways.

As defined by the EPA regulations, a CAFO's production area includes the animal confinement area, the manure storage area, the raw materials storage area, and waste containment areas, as well as areas for egg washing and mortality management (40 CFR 122.23(b)(8)). Because discharges can arise from any of part of the production area, the entire production area should be evaluated when determining whether a CAFO discharges from its production area.

When evaluating whether a CAFO discharges, certain considerations are applicable to many CAFOs in any animal sector, while others may be specific to a certain type of facility. The sections below include both general considerations and those that may not be broadly applicable.

However, the following sections are not intended to be an exhaustive discussion of every possible mechanism for production area discharges. Instead, the sections below highlight the range of potential discharge pathways to consider when evaluating whether an individual CAFO discharges from its production area.

Production area means that part of an AFO (including CAFOs) that includes the *animal confinement area*, the *manure storage area*, the *raw materials storage area*, and the *waste containment areas*.

- The animal confinement area includes but is not limited to open lots, housed lots, feedlots, confinement houses, stall barns, free stall barns, milk rooms, milking centers, cowyards, barnyards, medication pens, walkers, animal walkways, and stables.
- The manure storage area includes but is not limited to lagoons, runoff ponds, storage sheds, stockpiles, under house or pit storages, liquid impoundments, static piles, and composting piles.
- The raw materials storage area includes but is not limited to feed silos, silage bunkers, and bedding materials.
- The waste containment area includes but is not limited to settling basins, and areas within berms and diversions which separate uncontaminated storm water.

Also included in the definition of production area is any egg washing or egg processing facility, and any area used in the storage, handling, treatment, or disposal of mortalities. 40 CFR 122.23(b)(8).

Discharges from the Production Area: All Animal Sectors

This section describes factors relevant to determining whether a CAFO discharges that apply to all types of livestock, including animal types not specifically discussed in this guidance, such as veal calves, turkeys, ducks, horses, and goats.

The Animal Confinement Area

The animal confinement area includes but is not limited to open lots, housed lots, feedlots, confinement houses, stall barns, free stall barns, milk rooms, milking centers, cow yards, barnyards, medication pens, walkers, animal walkways and stables (40 CFR 122.23(b)(8)).

A CAFO's animal confinement area should be designed, constructed, operated, and maintained in a way that clean water diversion mechanisms, if any, are fully functional, and all process wastewater is collected and stored. Water that contacts any raw materials, products, or byproducts including manure, litter, feed, milk, eggs or bedding is process wastewater (40 CFR 122.23(b)(7)) and cannot be discharged unless authorized by an NPDES permit. Note that a discharge from animal watering systems is a discharge from the CAFO. Direct contact between confined animals and surface water flowing through the production area, often for drinking or cooling, is a discharge from the CAFO.

Process wastewater means water directly or indirectly used in the operation of the AFO for any or all of the following: spillage or overflow from animal or poultry watering systems; washing, cleaning, or flushing pens, barns, manure pits, or other AFO facilities; direct contact swimming, washing, or spray cooling of animals; or dust control. Process wastewater also includes any water that contacts any raw materials, products, or byproducts including manure, litter, feed, milk, eggs or bedding (40 CFR 122.23(b)(7)).

The relevant minimum measure is to prevent direct contact of confined animals with waters of the United States (40 CFR 122.42(e)(1)(iv)).

Manure Storage and Handling

During the tour of a CAFO's production area, the inspector should visually check and note any failures to follow Minimum Measure 1: Ensure adequate storage of manure, litter, and process wastewater, including procedures to ensure proper operation and maintenance of the storage facilities (40 CFR 122.42(e)(1)(i)).

Siting, design, construction, and maintenance of storage structures are important considerations when determining whether a CAFO has an adequate waste storage and handling system in place. In addition, the number of animals and the amount of manure, litter, or process wastewater anticipated to be generated during the critical storage period¹³ should be considered. All process wastewater generated at the site should be considered when determining the adequacy of the CAFO's storage capacity. Operation and maintenance factors include the frequency of regular inspections of all storage structures to ensure integrity of

¹³ This term means the storage period that provides the capacity to store the maximum amount of manure and process wastewater plus precipitation events less evaporation that will be generated until optimal land application or other drawdown of storage (e.g., for transfer off-site). See also Page 2-12 of EPA's *Managing Manure Nutrients at Concentrated Animal Feeding Operations* (EPA, 2004).

berms, valves, and other control devices, and to determine the fill level of liquid impoundments.

Manure storage and handling practices differ depending on whether the CAFO operates a system for handling manure in liquid or dry form, or a combination of the two.

For liquid manure handling systems, it is important to consider whether manure storage structures are designed and constructed to eliminate the possibility of overflow and/or managed in a manner to prevent any overflow from reaching a water of the United States. Proper maintenance includes maintaining capacity for freeboard and direct precipitation and preserving the structural integrity of the pond or lagoon by managing levels of manure, wastewater and sludge appropriately. Photo 17-1 illustrates a lagoon with vegetation growing in it. Growth of vegetation on the manure inside a storage structure decreases the capacity of the system and, may be an indication that manure solids have not been removed at appropriate intervals to maintain adequate storage capacity. Factors that may lead to structural failure include erosion, growth of trees or shrubs on berms, large animals walking on lagoon berms, and burrowing wildlife. A proper maintenance plan should address those factors. Embankments of any manure storage structure should have protective vegetation such as grass, be well compacted, intact, dry, show no signs of erosion, and have sufficient access for equipment such as pumps and agitators. Pooling on the side of the pond or lagoon could be indicative of leaking. Ask the facility representative if the manure structure is lined with any material to prevent leaking such as concrete, clay, plastic, etc.



Photo 17-1. This lagoon at a dairy CAFO is upslope from a water of the United States and overflowing. In addition, cows stand on the embankments of the far side of the lagoon, which may degrade the embankments over time, and vegetation is growing in the lagoon, which indicates poor maintenance. (Source: EPA Region 6.)

Although the design of a liquid manure storage structure is critical in determining the capacity of that structure to contain manure so that a discharge will not occur, the design standard alone does not necessarily guarantee that no discharge will occur. For example, a CAFO with a liquid storage structure designed for the 25-year, 24-hour storm is not categorically excluded

from the requirement to seek permit coverage based on this design standard.¹⁴ Larger storms and chronic rainfall events do occur, and production areas built to the 25-year, 24-hour storm design standard can and do discharge during such precipitation events. A permit is required to authorize a discharge under these circumstances. Proper operation and maintenance of the structure should also be considered as part of the objective assessment, such as steps to ensure there are no leaks or other system failures unrelated to storm events.

For permitted CAFOs, a liquid storage structure designed for the 25-year, 24-hour storm can discharge (because of overflows) during a storm event of any size so long as the facility is designed, constructed, operated, and maintained in compliance with the facility's permit terms and conditions. Further, certain other discharges may be allowed for permitted CAFOs, which are not covered by the CAFO effluent guidelines (ELGs). Such discharges are typically managed by treatment systems or best management practices (BMPs), as determined by the permit writer's best professional judgment (CWA section 402(a)(1); 40 CFR 122.44(a),(k)). For example, a CAFO's permit might allow discharges from equipment washdown facilities, chilling systems, boiler systems, and from other areas not covered by the ELGs, such as areas outside houses at total confinement facilities. For additional details on discharges from areas not covered by the effluent limitation guidelines for CAFOs, see Chapters 4.1.4, 4.1.5, and 4.1.6 of EPA's *NPDES Permit Writers' Manual for CAFOs*

(EPA, 2012a). However, there are no such provisions for unpermitted CAFOs. Therefore, it is important that CAFOs whose owners or operators choose not to have an NPDES permit be designed, constructed, operated, and maintained so they do not discharge during any size precipitation event.

For dry manure handling systems, it is important to consider the practices for moving manure or litter from animal confinement areas to storage areas and whether the CAFO has sufficient capacity to store dry manure or litter in covered buildings or otherwise manage it to keep it dry or contain all runoff.



Photo 17-2. This storage structure might have inadequate capacity for the amount of litter being stored. The area around the storage shed drains to a water of the U.S. and does not have any runoff controls. (Source: EPA Region 3)

¹⁴ In many cases the BMPs implemented by an unpermitted CAFO to ensure that it does not discharge will be more rigorous than those required for permitted CAFOs, because the operator of an unpermitted CAFO is never authorized to discharge under CWA section 301(a). Permitted CAFOs have greater flexibility because, in addition to being authorized to discharge under the circumstances prescribed by the permit, other discharges can be excused when the conditions contained in EPA's upset and/or bypass regulations are met (40 CFR 122.41(m) and (n); 73 FR 70,425).

Stockpiles of dry manure or litter are part of the production area, regardless of where they are located (40 CFR 122.23(b)(8)). Small and medium farms occasionally field-stack manure stockpiles in nearby crop or grazing fields, outside of the main production area. Discharges could occur from such stockpiles of manure or litter, whether solid or semi-solid, depending on the location of the stockpile (i.e., proximity of the stockpile to waters of the United States, and slope of land), exposure to precipitation, and presence of structural controls such as pads, berms or covers, duration of storage, and management of pile removal. Even temporary stockpiles could lead to an unauthorized discharge from an unpermitted CAFO if precipitation that contacts stockpiled manure or litter is subsequently discharged to waters of the United States.¹⁵ Covered storage areas and concrete pads are good management practices that can reduce contact between precipitation and the stockpile, and thus prevent discharges from occurring. It is also important to prevent any discharges associated with spillage of manure or litter. Photos 17-2 and 17-3 illustrate situations where storage practices can lead to discharges to waters of the United States.

Raw Materials Storage Area

The CAFO's raw materials storage area includes but is not limited to feed silos, silage bunkers, and bedding materials (40 CFR 122.23(b)(8)). As indicated above, the definition of process wastewater includes water that contacts raw materials including feed and bedding at the CAFO. Therefore, an evaluation of whether a CAFO discharges must consider whether water from feed, silage and bedding storage areas, if that water has contacted raw materials, will be discharged to a water of the United States. The inspector should note whether raw materials are covered and evaluate storage structures for breaks, leakage and spills. In the case of silage, the evaluation should also include consideration of any leachate resulting from the stored silage.



Photo 17-3. This stockpile is up to 8 feet tall and 60 feet long without cover or containment. A creek runs through the wooded area behind the pile. Any runoff from the stockpile to waters of the U.S. would be a discharge from the CAFO. (Source: EPA Region 7)

¹⁵ EPA has allowed poultry facilities to qualify for the higher numeric thresholds for dry manure handling systems when they have exposed stockpiles for no more than 15 days (the numeric thresholds for poultry with liquid manure handling systems are lower, and thus would cover more facilities). However, this 15 day "grace period" does not apply to whether or not a facility that is defined as a CAFO based on the dry litter numeric thresholds discharges. Regardless of whether an exposed stockpile is maintained for more than or few than 15 days, any discharge from manure or litter stockpiles is a discharge from the production area of a CAFO.

CAFOs should have adequate structures and protocols in place to ensure that any water that has contacted raw materials like feed and bedding will not be discharged to a water of the United States. Structures to prevent discharges from the raw materials storage area could include diversion structures to direct runoff or leachate to the CAFO's wastewater storage structures, or to vegetated treatment areas (VTAs), provided those areas are accounted for in the design, construction, operation, and maintenance of the structures. Where appropriate, the inspection should include evaluating the adequacy of silage leachate runoff collection and treatment. Silage management may be in the form of low flow leachate collection and land application or high flow runoff treatment in a vegetated treatment area. If a VTA system is used, it must be adequately maintained with consistent coverage of vegetation and be free of pooling liquids and kill zones.

Commodity and byproduct feed materials are stored in covered structures at many CAFOs. When handling those materials, CAFO operators should ensure that raw materials are not spilled in uncovered areas where they could be carried in runoff to a water of the United States.

Clean Water Diversion

Diverting clean water away from the production area minimizes the creation of process wastewater making it easier for a CAFO to properly manage manure, litter, and process wastewater. Diversions used to separate uncontaminated stormwater can include berms, swales, channels, ditches, barn roof drains with diversion structures or French drains around barns, or even natural topography. Berms and diversions used to prevent uncontaminated stormwater from entering a waste containment area should be designed and constructed so that they are large enough to ensure separation of clean stormwater.

During the tour of a permitted CAFO's production area, the inspector should visually check and note any failures to follow Minimum Measure 3: Ensure that clean water is diverted, as appropriate, from the production area (40 CFR 122.42(e)(1)(iii)).

Waste Containment

The waste containment area includes but is not limited to settling basins, and areas within berms and diversions which separate uncontaminated stormwater (40 CFR 122.23(b)(8)). For example, waste containment areas include areas where diversion structures are used to prevent clean stormwater from entering the containment area and contacting the waste or to keep contaminated runoff from exiting the containment area. Settling basins are also waste containment areas since they are not designed for long-term storage of manure.

Like manure storage areas, any area that is designed or operated to contain waste must be sized adequately to contain the volume of waste anticipated, thus ensuring waste will not be discharged from that area. For unpermitted CAFOs, such structures must be sized to ensure separation of uncontaminated stormwater to prevent discharge of contaminated stormwater under all conditions.

Some CAFO operators choose to use berms or other containment structures to contain accidental spills or overflows from primary storage structures in other parts of the production

area. For example, some operators may use secondary containment berms around liquid manure storage structures to prevent a discharge to waters of the United States, even in the event of an overflow from the primary storage structure. Such secondary containment areas are waste containment areas since they are not primarily intended for long-term storage of manure. Secondary containment areas help to provide additional protection against discharges to waters of the United States, particularly for unpermitted CAFOs subject to a no discharge standard.

Chemical Storage

During the tour of a permitted CAFO's production area, the inspector should visually check and note any failures to follow Minimum Measure 5: Ensure that chemicals and other contaminants handled on-site are not disposed of in any manure, litter, process wastewater, or stormwater storage or treatment system unless specifically designed to treat such chemicals and other contaminants (40 CFR 122.42(e)(1)(v)).

- ✓ Verify the description of practices implemented to ensure that chemicals and other contaminants are disposed of properly, as described during the records review portion of the inspection.
- ✓ What types (organic and inorganic) and quantities of chemicals are used and stored at the CAFO, (including pesticides, herbicides, oils, etc.)?
- ✓ Are there floor drains in the milk parlor or other areas that generate process wastewater that could be used for chemical disposal? Is wastewater collected in these drains directed to a manure storage impoundment? Is the storage structure designed to accept these wastes?
- ✓ Are chemical footbaths located by floor drains?
- ✓ Does the CAFO have a designated area for chemical storage and mixing? Are floor drains present in the chemical storage and mixing area?
- ✓ Is there a designated area for accumulating spent chemicals and other like motor oils, hydraulic fluid, etc.?
- ✓ Are chemicals labeled with accumulation dates, disposal methods, and other required information?
- ✓ Are chemical bottles out of place (e.g., around the lagoon instead of in chemical storage area)?

Mortality Management

The CAFO's production area also includes "any area used in the storage, handling, treatment, or disposal of mortalities" (40 CFR 122.23(b)(8)). Relevant factors to consider in assessing whether the CAFO discharges in connection with mortality management include the methods and locations for handling and disposal of animal mortalities, mortality rate, storage capabilities and other site-specific factors. For example, if a CAFO relies on a rendering facility to pick up carcasses, the CAFO should consider whether there is adequate storage to accommodate all

mortalities between pick-ups and whether the storage method ensures that all clean water remains clean, or captures all process wastewater generated from water coming into contact with the carcasses (i.e., nothing reaches waters of the United States). Facilities that dispose of dead animals on-site need to ensure that there are no discharges from the areas where, for example, animals are composted or buried. This may include burying carcasses immediately and making sure runoff from composting areas is contained in a proper storage structure. If composting is used, the inspector should look for any indicators of improper compost management including the presence of black leachate, exposed bones, feathers, carcasses, etc. and to see if the compost area is in an appropriate location to avoid any possible discharges to a water of the United States. Contact the state university agriculture extension office for information on composting methods for the area of the inspection. CAFOs should have a plan for dealing with catastrophic mortality events.

During the tour of a permitted CAFO's production area, the inspector should visually check and note any failures to follow Minimum Measure 2: Ensure proper management of mortalities (i.e., dead animals) to ensure that they are not disposed of in a liquid manure, stormwater, or process wastewater storage or treatment system that is not specifically designed to treat animal mortalities (40 CFR 122.42(e)(1)(ii)).

Other Factors Related to the Production Area

Similar considerations apply to other parts of the production area. Key factors that might affect whether a discharge occurs from the production area of any type of CAFO include the following:

- Exposure of animal waste and feed to precipitation or other water that is subsequently discharged to waters of the United States.
- Adequacy of structural controls to divert clean water.
- Sufficiency of inspection and maintenance schedules for clean water diversion controls, such as berms, gutters, and channels.
- Design and maintenance of pumps, pipes, valves, ditches, and drains associated with the collection of manure and wastewater from the animal confinement area.
- Design, operation, and maintenance of secondary containment, if applicable.
- Type of waste storage system, and the capacity, design, construction, and maintenance of the system.
- Implementation of standard operating procedures and quality of maintenance protocols (e.g., for equipment, infrastructure, and practices associated with animal management



Photo 17-4. This CAFO is discharging by disposing of mortalities in a conveyance that drains to a water of the United States (Source: EPA Region 4).

and waste handling), including contingency plans for extreme events (e.g., for equipment loss or failure).

- Drainage of production area and proximity to waters of the United States.
- Whether the animal confinement area prevents direct contact between animals and waters of the United States.

Land Application Area Discharges

All Animal Sectors

Inspectors at both permitted and unpermitted CAFOs with land application should identify the distance and direction from the fields used for land application to the nearest waters of the United States and look for any evidence of manure runoff from application fields towards waters of the United States.

During the tour of a permitted CAFO's land application areas, the inspector should visually check and note the following related to Minimum Measure 6: Identify appropriate site-specific conservation practices to be implemented, including as appropriate buffers or equivalent practices, to control runoff of pollutants to waters of the United States (40 CFR 122.42(e)(1)(vi)). Note Minimum measures 7 and 8 dealing with testing of manure, litter, process wastewater, and soil, and protocols for land application of manure, litter, or process wastewater are covered in Section D, "The CAFO Inspection—Records Review and the NMP."

The inspector should verify that any conservation practices such as NRCS conservation practice codes, buffers, berms, identified during the records review portion of the inspection are properly implemented on-site. The list below contains some factors an inspector might want to evaluate to determine whether a facility is implementing appropriate site-specific conservation practices:

- ✓ Is tail water from flood or furrow irrigation captured and pumped back to the head of the field or otherwise contained?
- ✓ Is wastewater ponding or infiltrating around irrigation sprinklers? Ponding could indicate over-application or leaks.
- ✓ Is manure applied to frozen, snow covered, or saturated ground or is manure land applied during a precipitation event?
- ✓ Is manure incorporated or injected?
- ✓ Is manure mechanically applied within 100 feet of waters of the United States?
- ✓ Is there evidence of manure runoff from application fields towards waters of the United States? Do any land application fields have steep slopes that might cause manure to more easily runoff from the field to waters of the United States?
- ✓ Are there no grassed, vegetated, or forested buffers between land application sites and waters of the United States? Is there evidence of manure application within the 35-foot vegetated buffer?

- ✓ Does land application equipment appear well-maintained? Are there leaks from permanently installed manure application and handling equipment, risers, or pipes?

Sector-Specific Factors Relevant to Production Area and Land Application Areas

See Appendix AD, “Animal Industry Overview,” for information on typical production methods and manure management practices.

Dairy Sector

Dairy operations are complex, with various types of covered and uncovered locations for confining, housing, and milking cows, and have sector-specific design and construction considerations that are relevant to determining whether the CAFO discharges. Inspectors should be aware that dairy operations often include both dry manure handling from calves and heifers, and wet manure handling from the mature milking cows. It is important to determine whether a dairy directs wastestreams to a proper containment structure or if waste is managed in a manner causing it to be discharged from the production area, to a water of the United States. These wastestreams include wastewater from commodity barns, silage bunkers, and milking parlors. Inspectors should also consider the possibility of discharges from portions of the production area that may be uncovered, such as feed storage areas, barnyards, exercise lots, animal walkways and animal pens, including uncovered portions of calf hutches and loafing areas (See Photo 17-5).



Photo 17-5. The dairy CAFO pictured above has had discharges from the confinement area (noted by the red dashed line) to a water of the United States bypassing the waste containment storage structure. (Source: EPA Region 4)

Dairy operations in warm climates might have cooling ponds designed to cool lactating cows. A cooling pond for dairy cattle will have a means for fresh water to enter, unlike a stagnant pond, lagoon, wallow, or mud hole. Any cooling pond that is or has been in use contains process wastewater because of animal contact (40 CFR 122.23(b)(7)).¹⁶ Relevant factors to consider in determining the likelihood of a cooling pond discharging pollutants to waters of the United States include the location of the pond relative to waters of the United States, the design of the pond, and how water removed from the pond is managed (e.g., pumped to a proper containment structure).

¹⁶ As applicable here, process wastewater means water directly or indirectly used in the operation of the AFO for direct contact swimming, washing, or spray cooling of animals. Process wastewater also includes any water which comes into contact with manure.

For other design, construction, operation, and maintenance factors specific to dairy cattle operations, see the table titled “Summary of Sector-Specific Considerations,” below and See Appendix AD, “Animal Industry Overview,” for information on typical production methods and manure management practices.

Beef Cattle Sector

While some cattle are kept in confinement buildings, most beef operations are on outdoor feedlots and might have open sheds, windbreaks, or shades. When evaluating whether a beef cattle operation discharges, an important consideration is whether the feedlot has sufficient containment for all manure, wastewater and direct precipitation for the critical storage period. Because the animals and manure are typically not housed under roof at beef cattle operations, local climate and proximity to waters of the United States should be considered when evaluating whether beef cattle operations discharge, as well as the design of the animal pens. Where operations are sloped for drainage, the inspector should determine if drainage results in a discharge to waters of United States (See Photo 17-6).

Other factors that may be important to consider in this animal sector include the following:

- Management of trough water overflow.
- Management of uncovered feed/silage.
- Manure stockpiling and composting.
- Whether animals have direct contact with waters of the United States.
- Systems to manage process wastewater generated from all uncovered areas to which animals have access.



Photo 17-6. This section of the beef feedlot production area has an outlet for manure and process wastewater to a roadside ditch. If the ditch conveys process wastewater to a water of the United States, the CAFO discharges.

(Source: EPA Region 7)

For other design, construction, operation, and maintenance factors specific to beef cattle operations, see the table titled “Summary of Sector-Specific Considerations,” below and Appendix AD “Animal Industry Overview,” for information on typical production methods and manure management practices.

Swine Sector

In evaluating whether a swine operation discharges, relevant factors include considerations specifically related to manure handling systems that are common at these types of operations.

Some swine operations have in-house manure pits (i.e., where manure is collected in a pit below the animal confinement house) that are designed with sufficient capacity to contain all manure and wastewater generated in the house until it is pumped out to another storage

structure or for land application. This pump-out may occur between groups, when the barns are empty of animals, as swine operations rotate animals by groups until they are sent to another finisher or the processing plant.

Some operations also have pumps to help distribute manure from one section to another, for example, if the operator notices that the solids level is higher in one section. These are commonly referred to as deep-pit systems. Relevant factors to consider for CAFOs with such systems include management of wastewater and manure slurry removal from the pit, including whether the CAFO has appropriate pump-out schedules and maintenance of hoses or underground distribution lines, which can run from the pit to the land application areas. The capacity of a deep-pit system should be evaluated to ensure it can contain all manure and process wastewater between land application events.

Other swine operations have in-house pits that provide only temporary containment before removal of the manure and wastewater to a pond, lagoon, or above-ground storage tank. Operations with these smaller in-house manure pits generally pump out manure more frequently. Therefore, systems at these swine operations typically rely more heavily on pumps and pipes than at other swine operations. Some of the problems associated with these types of operations that can lead to discharges and therefore should be considered when conducting a site-specific evaluation include: pipe or hose ruptures; overflows from open channels or collection pits; and direct discharges from a waste storage structure such as a lagoon.

To prevent discharges from occurring, some swine operations construct a secondary containment system designed to capture any unanticipated pipe or hose ruptures or overflows from deep pit manure storage structures or from the confinement houses themselves. The inspector should consider how the design, operation, and maintenance of such containment systems could contribute to a discharge as the result of accumulated wastes and precipitation.

For other design, construction, operation, and maintenance factors specific to swine operations, see the table titled “Summary of Sector-Specific Considerations,” below, and Appendix AD: “Overview of the Animal Industry,” for information on typical production methods and manure management practices.

Poultry Sector

The definition of a CAFO explicitly includes four different types of poultry operations: chickens (other than laying hens), laying hens, turkeys, and ducks. Most modern CAFOs that raise poultry for meat production use predominantly “dry” manure handling systems. As a result, discharges to waters of the United States from production areas at those poultry operations generally are caused by rainfall coming in contact with dry manure (i.e., poultry litter) in exposed areas, poor housekeeping around the bird houses or litter storage areas, or poor mortality management practices. Egg production facilities typically handle larger volumes of water as a result of egg washing. Some facilities also use bird cooling spray systems and the condensate can co-mingle with manure, litter, and process wastewater. Therefore, in addition to potential discharges from litter handling practices and mortality management, laying hen CAFOs also have the potential to discharge to waters of the United States as the result of overflows from process

wastewater storage and handling structures. Moreover, poultry operations frequently have smaller “footprints,” in comparison to some other livestock sectors, which may lead to large amounts of litter being generated relative to the availability of land for manure spreading. Some poultry facilities may send manure off-site by truck to an outside party for spreading or composting; these manure transfer areas should be evaluated (for example, are there storm drains in these areas?). Therefore, relevant factors to consider in assessing the likelihood of a poultry operation discharging include the following:

- Whether the operation has sufficient storage capacity to accommodate litter removed from houses between flocks and during whole-house cleanouts.
- Whether management of cleanouts, stockpiles, and litter storage sheds is done in such a way that contaminated runoff will not reach waters of the United States.
- For operations with liquid manure handling systems, whether the operation has adequate storage capacity for all egg wash water and cooling spray condensate generated, considering the facility’s maximum egg production, wastewater handling capabilities, and expected dewatering frequency.
- Whether the operation has adequate available acreage for land application to use the nutrients generated at the facility or other arrangements in place (such as third-party haulers).



Photo 17-7. A poultry operation designed to have precipitation drain away from houses would discharge if contaminated runoff enters a water of the United States. (Source: EPA Region 3)

For CAFO operations with ventilated confinement houses inspectors should consider a number of relevant factors, such as the way water is drained from the site and proximity to waters of the United States, when assessing whether they discharge pollutants to waters of the United States. Some poultry facilities are designed to channel precipitation runoff from the houses away from the confinement area in a manner that may result in discharges to waters of the United States (see Photo 17-7). Although such discharges may be allowed for permitted CAFOs subject to conditions specified in the permit, for unpermitted CAFOs, these discharges would violate the CWA. For other design, construction, operation, and maintenance factors specific to poultry operations, see the table titled “Summary of Sector-Specific Considerations,” below and Appendix AD, “Overview of the Animal Industry” for information on typical production methods and manure management practices.

Summary of Sector-Specific Considerations

When evaluating sources of pollutant discharges and pathways for pollutants to reach waters of the United States, EPA recommends considering the following site-specific factors:

ALL ANIMAL SECTORS

- Facility location, such as whether in a floodplain, proximity to waters of the United States, and if the CAFO is upslope from waters of the United States.
- Local climatic conditions, including whether precipitation exceeds evaporation.
- Discharge history.
- Volume of manure, litter, or process wastewater generated.
- Management of manure, litter, and process wastewater.
- Management of storage, treatment, and disposal of mortalities.
- Amount of acreage to land-apply manure, litter, or process wastewater in accordance with appropriate practices or other means of managing nutrients that prevent discharges, such as off-site transfer to other entities.
- Type and collective effect of conservation practices (e.g., setbacks and buffers employed near surface waters, ditches, and other conduits to surface waters to control the runoff of pollutants from land application areas).
- Resources and protocols for proper operation and maintenance of land application equipment (e.g., inspecting hoses and overseeing automatic shutoff valves).
- Management of feed and silage, including management/capture of silage leachate and runoff from feed and silage storage areas.

DAIRY SECTOR

- Whether animals are housed under roofs at all times, and if not, management of manure and wastewater generated in loafing areas and other outdoor areas with animal access.
- The capacity for manure and wastewater storage, including consideration of siting and management of stockpiles to avoid discharges to waters of the United States and capacity of solid settling basins to hold direct precipitation.
- Management of the calving area.
- Management of milk bottle wash water.
- Management of cooling water and footbath water.
- Storage or disposal of waste from milking parlors and milk tank cleaning.
- Management of bedding material.
- Management of manure composting areas.
- Cattle access to surface water.

BEEF CATTLE SECTOR

- The capacity for manure and wastewater storage, including consideration of siting and management of stockpiles to avoid discharges to waters of the United States and capacity of solid settling basins to hold direct precipitation.
- The capacity, siting, and operation and maintenance practices for a vegetated treatment system, where applicable.
- Management of manure composting areas.
- Cattle access to surface water.

SWINE SECTOR

- Management of pollutants from confinement houses, including conveyances designed to drain runoff from confinement areas.

Summary of Sector-Specific Considerations

- How manure and wastewater is collected and stored, such as in a deep pit under the confinement house or by a containment structure like a lagoon.
- Identification of pollutant sources, such as storage facilities, and consideration of whether pollutants from those sources contact precipitation or other water to generate process wastewater.

POULTRY SECTOR

- Identification of sources of pollutants, such as storage facilities, litter handling activities (e.g., cake-outs, crust-outs, whole house clean-outs), poultry handling, and confinement house ventilation systems, and consideration of whether pollutants from those sources contact precipitation or other water to generate process wastewater.
- For layer facilities, management of egg production and egg wash water.
- Management of pollutants generated by confinement areas, including pollutants expelled from the ventilation system and conveyances designed to drain runoff from those areas.

D. THE CAFO INSPECTION—RECORDS REVIEW AND THE NMP

Maintaining complete, current and accurate records is important for permitted CAFOs to show compliance with recordkeeping requirements and for unpermitted large CAFOs that land apply manure to qualify for the stormwater exemption. Inspectors should review relevant records for both permitted CAFOs and unpermitted large CAFOs. Records may be maintained on-site at the CAFO, or may be located off-site at a nearby location.

This section explains what types of records CAFOs must maintain relating to the production area and land application, some key compliance elements that can be reviewed quickly and alerts to possible compliance issues. For more information on crops production, nutrient management and soils, refer to Appendix AE, “Nutrient Management/Soil Science” and Appendix AK, “Growth Stages of Field Crops.”

The approach described in this section does not include a complete, in-depth analysis of NMP implementation. If the CAFO inspector intends to conduct such an analysis, refer to Appendix AO, “Detailed Review of Nutrient Management Plan Implementation,” and Chapter 5 of EPA’s *NPDES Permit Writers’ Manual for CAFOs* (2012a).

UNPERMITTED LARGE CAFOS

Production Area

There are no specific recordkeeping requirements for unpermitted large CAFOs related to the production area. However, the CAFO may want to maintain records to establish and document that there have been no discharges from the production area. Section C describes what the inspector should examine to identify evidence of discharges.

Land Application Areas

As CAFOs are only required to have an NPDES permit if they are discharging to waters of the United States, non-discharging CAFOs may choose not to apply for a permit. **However, precipitation-related discharges of manure, litter or process wastewater from land areas under the control of a CAFO, such as crop fields, are subject to NPDES permitting *unless* the**

CAFOs (including unpermitted CAFOs) maintain records documenting that they have land applied in accordance with appropriate nutrient management practices. If an unpermitted CAFO does not maintain that documentation, discharges from its land application area do not qualify for the agricultural stormwater exemption from NPDES requirements. Unpermitted large CAFOs must have records indicating that they are implementing 40 CFR 122.42(e)(1)(vi)–(ix) on their land application sites to ensure appropriate agricultural utilization of land applied nutrients. These practices ensure that precipitation-related discharges from the land application areas qualify for the agricultural stormwater exemption.

Table 15-8 below, shows the types of records unpermitted large CAFOs must keep to meet the requirements of measures vi through viii dealing with land application (ix is the requirement to keep records for vi through viii).

Table 15-8. Minimum Measures and Associated Records Applying to Unpermitted Large CAFOs

Minimum Measure	Example Records	Potential Compliance Alerts
<ul style="list-style-type: none"> ✓ Identify site-specific conservation practices to be implemented, including buffers or equivalent practices, to control runoff of pollutants to waters of the United States (40 CFR 122.42(e)(1)(vi)). 	<ul style="list-style-type: none"> ✓ NMP or CNMP. ✓ Engineering drawings or as built drawings showing the location and dimension of berms, buffers, setbacks, and other conservation practices between land application fields or production areas and WOUS. ✓ Narrative descriptions of conservation practices implemented to control pollutant runoff, such as NRCS conservation practice standards. 	<ul style="list-style-type: none"> ✓ The CAFO does not have documentation of buffers, setbacks, or other conservation practices to minimize nutrient runoff to nearby WOUS. ✓ Conservation practices are identified but do not include operation and maintenance protocols to ensure long-term effectiveness to control pollutant runoff.
<ul style="list-style-type: none"> ✓ Identify protocols for appropriate testing of manure, litter, process wastewater, and soil (40 CFR 122.42(e)(1)(vii)). 	<ul style="list-style-type: none"> ✓ NMP or CNMP. ✓ A facility sampling plan that identifies sampling locations, sampling frequency, analytical methods, and laboratories for manure, litter, process wastewater, and soil analysis. ✓ Laboratory reports that identify testing procedures and results for manure, litter, process wastewater, and soil. 	<ul style="list-style-type: none"> ✓ The CAFO land applies manure or wastewater without sampling the nutrient content of manure and soil. ✓ Soil and manure analyses are not current. ✓ Manure and process wastewater analysis are not representative of all sources that are land applied. ✓ Soil analyses are not available for all fields used for land application. ✓ Soil or manure analytical results are not consistent with those used to calculate land application rates.
<ul style="list-style-type: none"> ✓ Establish protocols to land apply manure, litter or process wastewater to ensure appropriate agricultural utilization of the nutrients in the 	<ul style="list-style-type: none"> ✓ Site map showing land application fields. ✓ NMP or CNMP. ✓ Manure spreading agreements. 	<ul style="list-style-type: none"> ✓ No documentation of manure application rates, protocols, or schedules. ✓ The CAFO land applies manure and/or wastewater without

**Table 15-8. Minimum Measures and Associated Records
Applying to Unpermitted Large CAFOs**

Minimum Measure	Example Records	Potential Compliance Alerts
manure, litter or process wastewater (40 CFR 122.42(e)(1)(viii)).	<ul style="list-style-type: none"> ✓ Manure application rate calculations in accordance with the methodology in the NMP. ✓ Land application records. ✓ Application equipment inspection logs. 	<ul style="list-style-type: none"> agronomic rate calculations supporting the application. ✓ Manure application at rates higher than the rates calculated in accordance with the NMP. ✓ Manure is applied at a constant rate across all fields and crop types. ✓ Land application records are incomplete (e.g., do not specify manure source, amount, dates, application method). ✓ Actual amount of nutrients applied is calculated at the end of the season rather than tracked for each application event. ✓ Manure is applied to fields that are not identified in the NMP. ✓ Manure is imported to, or exported from, the CAFO for land application, and this is not documented in the NMP, (or the amounts not noted).

Permitted CAFOs

The inspector can visually observe some aspects of the permitted CAFO's implementation of its NMP during the facility tour, as described in Section C, however, the inspector may also need to review calculations, application records, laboratory test results, and other quantitative data after the inspection. To avoid a lengthy post-inspection review, if possible inspectors should familiarize themselves with the CAFO's NMP in advance of the inspection. If the inspection is announced the inspector may want to request a copy from the operator. If the NMP is not available for review prior to visiting the facility, the regulations require that a copy of the site-specific NMP be maintained and available on-site for review.

Generally, these documents do not contain trade secrets but the inspector should reaffirm the CAFO's right to identify documents as confidential business information. Depending on the CAFO staffing level, the inspector may be able to flag particular documents with sticky notes to be copied during the facility tour. The inspector should make copies of any documents that cannot be thoroughly evaluated during the site inspection for later evaluation. The inspector should create a list of documents and materials obtained during the inspection. The inspector should sign and date a copy and give the copy to the CAFO site representative. The inspector can also attach copied documents to the inspection report as reference material. It is highly recommended, regardless of the time allotted to the records review portion of the inspection, that the inspector asks the CAFO representative for copies of the following documents for

detailed review after the on-site inspection. This documentation will aid the inspector in evaluating the CAFO's NMP compliance:

- Phosphorus/Nitrogen risk assessment documentation/calculations
- Soil test results
- Manure/wastewater test results
- Nutrient application rate calculations
- Nutrient application records (organic and commercial)
- Dewatering logs
- Manure transfer records
- Others (specific to NMP terms)
 - Land application dates
 - Precipitation records
 - Timing limitations
 - Soil test P result
 - P Index calculations
 - Description and location of buffers

Substantial Changes to NMP that Require Permit Modification

- Addition of new land application areas **not** previously included in NMP
- Changes to maximum field-specific annual rates of application or to maximum amounts of N and P derived from all sources for each crop
- Addition of any crop not previously included in NMP
- Changes that increase the risk of N and P transport to Waters of the U.S.

On occasion, the CAFO may not have a photocopier, fax machine, or printer that makes useable copies. The inspector can consider taking photographs of the documents; some smartphones have applications for document scanning. Photos should be taken using EPA or state equipment, not personal cell phones. However, the inspector should identify the specific documents they are photographing to the CAFO representative to allow them to claim confidentiality if applicable. Finally, the inspector should leave the CAFO's documents in an organized manner, preferably in the same order provided to the inspector.

RECORDS FOR PERMITTED LARGE CAFOS

Pursuant to the 2008 CAFO Final Rule, all permits issued after December 22, 2008 must require a CAFO to submit its NMP to the permitting authority with its application for permit coverage. This applies to both individual permits and general permits. Since NPDES permits are issued for 5-year permit terms, most CAFO permits should currently reflect the 2008 CAFO rule revisions. In fact, there still exist some permits issued prior to 2008 that have been administratively continued. Pursuant to those 2008 regulation revisions, by the time the CAFO inspector sees the NMP, the permit writer probably will have reviewed the plan to ensure it is consistent with the state technical standards for nutrient management and to identify site-specific terms of the NMP to be incorporated into the permit. For permitted CAFOs, the inspector's job focuses on verifying that the NMP is being updated, implemented, and documented as required. The specific records that a particular CAFO will maintain to document NMP implementation should be identified in the NMP or in the permit, or both.

Permitted CAFOs are required to submit NMP revisions to the permitting authority. The first step in NMP evaluation is to check the NMP found on-site at the CAFO against the most recent version submitted to the permitting authority. Differences could indicate that NMP revisions are not being submitted as required.

If the on-site NMP has been revised from the version that was submitted to the permitting authority, the inspector should ascertain the nature of the non-reported NMP revisions. Certain types of revisions trigger a permit modification. For those revisions, the inspector should notify the permit writer. In any case, the most recent version of the NMP should be included in the permit file. If the inspector did not obtain a copy of the entire NMP, it should be requested from the operator.

Records and documentation associated with the NMP will be referenced throughout the entire inspection. The CAFO's NMP should include documentation and records showing implementation of the nine minimum measures, in addition to any applicable records and practices required by the ELG.

Production Area

Table 15-9 provides examples of the types of records that a CAFO might keep to document implementation of the first six required NMP minimum measures that deal with the production area. Table 15-9 also describes potential compliance alerts that may suggest non-compliance with those minimum measures. Please keep in mind that these are example records and compliance alerts and are not complete lists of all possible records and potential compliance problems for each measure.

The recordkeeping requirements for the nine minimum measures apply to all permitted CAFOs. Some CAFOs also must maintain additional records associated with the production and land application areas: Subpart C CAFOs (dairy and beef cattle other than veal calves) and Subpart D CAFOs (swine, poultry and veal calves) (40 CFR 122.42(e)(2)(B)). As described in Section A, these additional requirements are implemented through the documentation and maintenance of records of the minimum NMP measures. These records must be maintained on-site for a period of five years from the date they are created. The additional production area records for Subpart C and D CAFOs are also included in Table 15-9 below.

If time constraints prevent the inspector from conducting a detailed records analysis of the CAFO's implementation of its NMP, there are some aspects that can often be quickly verified. A complete list of possible documents and compliance alerts is included in Table 15-9 below. If the inspector intends to do an in-depth analysis of NMP implementation, refer to Appendix AO, "Detailed Review of Nutrient Management Plan Implementation," and Chapter 5 of *EPA's NPDES Permit Writers' Manual for CAFOs* (EPA, 2012a).

Table 15-9. Example Records and Potential Compliance Alerts Associated with NMP Minimum Measures i-v

Minimum Measure	Example Records	Potential Compliance Alerts
Ensure adequate storage of manure, litter, and process wastewater, including procedures to ensure proper operation and maintenance of the storage facilities (40 CFR 122.42(e)(1)(i)).	<ul style="list-style-type: none"> ✓ NMP or CNMP. ✓ Engineering calculations. ✓ Engineering drawings, including as built drawings. ✓ Construction certifications. ✓ Invoices from manure or wastewater haulers. ✓ Wastewater pumping logs. 	<ul style="list-style-type: none"> ✓ No records of dewatering storage structures or protocols to pump down storage structures after a significant precipitation event or before an extended wet weather period (i.e., winter or rainy season). ✓ No drawings, calculations, or other evidence that storage structures were designed and constructed to contain wastewater and stormwater runoff over a design storage period (e.g., 6 months' storage capacity), including normal precipitation; the 25-year, 24-hour storm event; and accumulated solids.
For Subpart C and D CAFOs: Records documenting required visual inspections	<ul style="list-style-type: none"> ✓ Weekly records identifying the impoundments, storage structures, diversion structures, channels, etc. inspected. ✓ Records identifying the water lines that were inspected daily (may be documented weekly). ✓ Description of any problems identified. 	<ul style="list-style-type: none"> ✓ Records do not identify the specific structures, water lines, etc. that are inspected. ✓ Inspections are not documented at least weekly. ✓ Operation and maintenance issues are not documented (e.g., problems identified during site tour are not reflected in records).
For Subpart C and D CAFOs: Weekly records of the depth of manure and wastewater in liquid impoundments	<ul style="list-style-type: none"> ✓ Weekly depth records for every impoundment required to have a depth marker, including: ✓ Name of impoundment. ✓ Units (inches, feet, etc.). ✓ Pumping level (level needed to maintain storage for design storm event (e.g., 25-year, 24-hour storm)). 	<ul style="list-style-type: none"> ✓ Wastewater levels are not recorded weekly for all impoundments. ✓ Records show wastewater levels routinely above pumping level (i.e., storage capacity for design storm event not maintained). ✓ Records indicated impoundments are not dewatered in a timely manner after large storm events. ✓ Operator is not aware of impoundment pumping levels.
For Subpart C and D CAFOs: Records documenting actions taken to correct deficiencies identified during visual inspections	<ul style="list-style-type: none"> ✓ Description and date of corrective actions. ✓ For corrective actions not completed within 30 days, explanation of the factors preventing immediate correction. 	<ul style="list-style-type: none"> ✓ Records do not document corrective actions. ✓ Corrective actions are not timely.
For Subpart C and D CAFOs: Records documenting the current design of any manure or litter storage structures, including volume for solids accumulation,	<ul style="list-style-type: none"> ✓ NMP or CNMP. ✓ Engineering calculations, including estimates for each component of the required storage volume. 	<ul style="list-style-type: none"> ✓ Design documentation does not include both 1) operating volume (e.g., wastewater produced from facility operations and runoff from "normal" precipitation); and 2) emergency storage volume (e.g.,

Table 15-9. Example Records and Potential Compliance Alerts Associated with NMP Minimum Measures i-v

Minimum Measure	Example Records	Potential Compliance Alerts
design treatment volume, total design volume, and approximate number of days of storage capacity	<ul style="list-style-type: none"> ✓ Engineering drawings, including as built drawings. ✓ Construction certifications. 	<p>runoff and precipitation from 25-year, 24-hour storm).</p> <ul style="list-style-type: none"> ✓ Design documentation for new source swine, poultry, or veal calf CAFOs do not identify or account for the design storm to ensure zero discharge.
For Subpart C and D CAFOs: Records of the date, time and estimated volume of any overflow	<ul style="list-style-type: none"> ✓ Records of overflows (not limited to discharges). ✓ Description of the cause of the overflow and corrective actions. ✓ For overflows resulting in a discharge, records of all required sampling and notification. ✓ * It is recommended that the inspector obtain copies of records showing overflows from the production area and any corrective actions. 	<ul style="list-style-type: none"> ✓ Records of discharges that were not sampled or reported. ✓ Frequent overflows. ✓ No records of corrective actions to prevent future overflows.
Ensure proper management of mortalities (i.e., dead animals) to ensure that they are not disposed of in a liquid manure, stormwater, or process wastewater storage or treatment system that is not specifically designed to treat animal mortalities (40 CFR 122.42(e)(1)(ii)).	<ul style="list-style-type: none"> ✓ Description of mortality disposal practices, including compost, incineration, or burial locations. ✓ Periodic certification that documented procedures are followed. ✓ Mortality logs. ✓ Invoices from mortality haulers and renderers. 	<ul style="list-style-type: none"> ✓ No written description of mortality disposal procedures. ✓ No records that written procedures are followed. ✓ Facility representative unable to confirm that runoff from mortality disposal area is contained.
For Subpart C and D CAFOs: Records of mortality management	<ul style="list-style-type: none"> ✓ Description of mortality management practices, including storage, handling, and disposal locations and containment of runoff from those locations. ✓ Periodic certifications that documented procedures are followed. 	<ul style="list-style-type: none"> ✓ Facility representative unable to confirm that runoff from on-site mortality handling, storage, or disposal areas is contained.
Ensure that clean water is diverted, as appropriate, from the production area (40 CFR 122.42(e)(1)(iii)).	<ul style="list-style-type: none"> ✓ Description of practices and structures to divert clean water from the production area. ✓ Topographic maps showing the production area to be at a higher elevation than the surrounding land (water drains away rather than toward the production area). ✓ Federal Emergency Management Agency (FEMA) floodplain maps 	<ul style="list-style-type: none"> ✓ The CAFO is unable to produce documentation that roof gutters and downspouts, engineered berms, and/or topography divert clean water around the production area AND wastewater storage structure calculations do not include stormwater runoff from roofs and areas outside the production area. ✓ The production area is constructed inside a delineated FEMA floodplain

Table 15-9. Example Records and Potential Compliance Alerts Associated with NMP Minimum Measures i-v

Minimum Measure	Example Records	Potential Compliance Alerts
	<p>showing that the production area is outside of a delineated floodplain.</p> <ul style="list-style-type: none"> ✓ Engineering plans for constructing adequately sized berms around the production area. ✓ Engineering drawings or NRCS conservation practice agreements to install roof gutters with downspouts draining away from the production area. 	<p>and facility records do not demonstrate that the production areas are protected from flood inundation and washout.</p>
Prevent direct contact of confined animals with WOUS (40 CFR 122.42(e)(1)(iv)).	<ul style="list-style-type: none"> ✓ Topographic maps that show WOUS do flow through the production area. ✓ Descriptions of practices implemented to prevent direct contact. ✓ Engineering drawings of bridges, culverts, or other structures that allow livestock to cross WOUS with coming into direct contact. 	<ul style="list-style-type: none"> ✓ Topographic maps show surface waters flowing through the production area AND the CAFO representatives are unable to discuss or produce documentation of practices to prevent direct contact of confined animals with WOUS.
Ensure that chemicals and other contaminants handled on-site are not disposed of in any manure, litter, process wastewater, or stormwater storage or treatment system unless specifically designed to treat such chemicals and other contaminants (40 CFR 122.42(e)(1)(v)).	<ul style="list-style-type: none"> ✓ Descriptions of chemical storage areas and handling and disposal practices demonstrating that chemicals and other contaminants are not improperly disposed. ✓ Logs or invoices from chemical recycling and disposal companies. 	<ul style="list-style-type: none"> ✓ No documentation of chemical disposal practices. ✓ Facility might need a need a Spill Prevention, Control, and Countermeasure (SPCC) plan depending on quantities. ✓ Facility should have a Material Safety Data Sheet (MSDS) for all stored chemicals.

Land Application Areas

Fields Available for Land Application

The NMP will identify each field where land application is planned. The inspector should compare the land application records with the fields identified in the NMP to ensure manure, litter, or process wastewater were not applied to fields that are not covered by the plan. Use of a land application site that is not identified in the NMP constitutes non-compliance with a permit term. Also, addition of a land application site not covered by an approved NMP constitutes a substantial change to the NMP that requires a permit modification with associated permitting authority review and public notice.

Timing Limitations for Land Application

As described in Chapter 6.5.1 of EPA's *NPDES Permit Writers' Manual for CAFOs* (EPA, 2012a), this term refers to limitations described in the technical standards for when manure applications should be prohibited or delayed. The inspector should check land application records to see if the applicable timing limitations are being followed. In some cases, this will be a straightforward evaluation (e.g., prohibition on land application during specific months). Often, however, evaluating compliance will require the inspector and case officer to use professional judgment and diverse resources (e.g., prohibition on land application on "saturated soils"). For additional information and examples, refer to Appendix AO, "Detailed Review of Nutrient Management Plan Implementation."

To determine whether manure or wastewater was applied during rainfall events the inspector can compare land application dates with local precipitation records. CAFOs often maintain daily precipitation logs. Alternatively, Internet resources such as The Weather Underground

(www.weatherunderground.com) and Utah Climate Center

(<http://climate.usurf.usu.edu/products/data.php>)

can be used to determine whether a rainfall event occurred, at least at a nearby weather station, on a specific date. Unless the data document the time of application and precipitation, it might not be possible to positively determine whether the two events were concurrent, but the inspector and case officer can use information such as the magnitude of the rainfall, whether rainfall occurred on the previous and/or subsequent days, the amount of manure or wastewater applied, and other circumstantial data to assess the likelihood that manure or wastewater was applied during a rainfall event.

Evaluating whether wastewater was applied on frozen or saturated ground is more complex.

Many variables such as season, latitude, altitude, proximity of lakes and rivers, and local landscape, can affect when soils freeze and thaw. To predict soil saturation, the inspector and case officer would need information on soil types including antecedent soil moisture, hydraulic conductivity, infiltration rate, and precipitation and irrigation history. Here again, the evaluation is time-consuming and the absence of direct observation may pose challenges to determining non-compliance. If the land application records for a facility suggest the CAFO operator is applying wastewater to frozen or snow-covered ground, it may be more effective for an inspector to visit CAFOs under those conditions to observe whether land application is occurring.

Document Review Tip:

Spot Check Records for a Single Field

- ✓ Did the CAFO apply manure to the correct field identified in the NMP?
- ✓ Was the crop planned for the field actually the crop that was planted?
- ✓ Were the form and source of the manure applied to the field the same as those identified in the NMP (e.g., the plan called for solid manure from the settling basin to be applied)?
- ✓ Did the CAFO follow timing restrictions when applying the manure (e.g., no application between December and March)?
- ✓ Did the CAFO use the method of application identified in the NMP (e.g., injection)?

It is usually easiest and least expensive for a CAFO to apply manure to the field nearest the manure storage structures. The inspector should consider checking records for that field.

Planned Crop or Other Use

The rate calculations in the NMP are based on the crop or crop rotation planned for each field. The inspector should evaluate land application records to ensure the crops grown in the field are the same as the crops that were planned for that field during that year. The only exception would be for the use of alternative crops included in the NMP.

Form and Source of Manure that Is Land Applied

The inspector should compare the form and source of manure to be applied to each field and crop, identified in permit terms, with the land application records to see if the planned form(s) and source(s) were used.

Timing and Method of Land Application

The inspector should compare methods and timing of manure application to the terms of the permit. The specificity of the terms will be guided by the state technical standards for nutrient management and, largely, the nitrogen availability factors that are required. For example, many states provide a single availability factor or mineralization rate for seasonal (i.e., fall or spring) application. In those states, the permit term might simply specify fall or spring application. In some cases, a permit term might be as specific as “within two weeks before planting.” While the CAFO’s NMP may include specific dates for planned applications (most nutrient management planning programs require specific dates) the inspector must make sure the actual nutrient applications identified in the facility records are consistent with the permit term.

The permit term for method of application will specify at least whether the surface or subsurface application is planned and may be as specific as identifying the type of equipment that will be used. The term should also reflect whether the manure is to be incorporated within a certain timeframe. The CAFO inspector should evaluate land application records to see if the actual method of application, including time to incorporation, is consistent with the planned method reflected in the permit term.

Table 15-10 provides examples of the types of records that a CAFO might keep to document implementation of minimum measures vi through viii dealing with land application. The ninth minimum measure is the requirement to keep records documenting the implementation and management of measures one through eight. Some records may be available electronically, for example, it may be possible to obtain a summary table from the CAFO’s NMP planner that includes data for hundreds of fields. Table 15-10 also describes potential compliance alerts that may suggest non-compliance with those minimum measures. Please keep in mind that these are example records and compliance alerts and are not complete lists of all possible records and potential compliance problems for each measure. Inspectors should be well-versed in the common types of nutrient management practices and protocols used in their region to facilitate

Document Review Tip

Keep a notebook with book values for annual manure production by animal type, typical crop nutrient uptake rates, and other information to informally verify numbers used in CAFO nutrient management plans. The CAFO’s input values may be different but would not be expected to differ significantly from land grant university book values. Find information on manure generation and management from the land grant universities at http://articles.extension.org/animal_manure_management or contact your state university extension office.

the evaluation of the adequacy of NMP implementation as applied to the unique circumstances at each individual CAFO.

In addition to the recordkeeping requirements for the nine minimum measures, which apply to all permitted CAFOs, Large beef, dairy, veal calf, swine and poultry CAFOs also must maintain additional records associated with the production and land application areas. As described in Section A, these additional requirements are implemented through the documentation and maintenance of records of the minimum NMP measures. These records must be maintained on-site for a period of five years from the date they are created. The additional land application records for Subpart C and D CAFOs are also included in Table 15-10 below.

Table 15-10. Example Records and Potential Compliance Alerts Associated with NMP Minimum Measures vi–viii

Minimum Measure	Example Records	Potential Compliance Alerts
<p>1. Identify site-specific conservation practices to be implemented, including buffers or equivalent practices, to control runoff of pollutants to waters of the United States (40 CFR 122.42(e)(1)(vi)).</p>	<ul style="list-style-type: none"> ✓ NMP or CNMP. ✓ Engineering drawings or as built drawings showing the location and dimension of berms, buffers, setbacks, and other conservation practices between land application fields or production areas and WOUS. ✓ Narrative descriptions of conservation practices implemented to control pollutant runoff, such as NRCS conservation practice standards. 	<ul style="list-style-type: none"> ✓ Subpart C and D CAFOs cannot document a 100-foot setback from any down-gradient surface waters, open tile intake structures, sinkholes, agricultural well heads, or other conduits to surface waters where manure, litter, and process wastewater are not applied or a 35-foot vegetated buffer where manure, litter or process wastewater is not applied. ✓ The CAFO does not have documentation of buffers, setbacks, or other conservation practices to minimize nutrient runoff to nearby WOUS. ✓ Conservation practices are identified but do not include operation and maintenance protocols to ensure long-term effectiveness to control pollutant runoff.
<p>2. Identify protocols for appropriate testing of manure, litter, process wastewater, and soil (40 CFR 122.42(e)(1)(vii)).</p>	<ul style="list-style-type: none"> ✓ NMP or CNMP. ✓ A facility sampling plan that identifies sampling locations, sampling frequency, analytical methods, and laboratories for manure, litter, process wastewater, and soil analysis. ✓ Laboratory reports that identify testing procedures and results for manure, litter, process wastewater, and soil. Note for large facilities this information may be available electronically from the CAFO's NMP planner. 	<ul style="list-style-type: none"> ✓ The CAFO land applies manure or wastewater without sampling the nutrient content of manure and soil. ✓ Soil and manure analyses are not current (according to the required testing frequency). ✓ Manure and process wastewater analysis are not representative of all sources that are land applied. ✓ Soil analyses are not available for all fields used for land application. ✓ Soil or manure analytical results are not consistent with those used to calculate land application rates.

Table 15-10. Example Records and Potential Compliance Alerts Associated with NMP Minimum Measures vi–viii

Minimum Measure	Example Records	Potential Compliance Alerts
<p>For Subpart C and D CAFOs: Manure and Soil Testing Protocols</p>	<ul style="list-style-type: none"> ✓ Laboratory reports that indicate manure was analyzed a minimum of once annually for nitrogen and phosphorus. ✓ Laboratory reports that indicate soil was analyzed a minimum of once every five years for phosphorus. ✓ Rate calculations that include results from laboratory. 	<ul style="list-style-type: none"> ✓ Manure not analyzed annually. ✓ Manure not analyzed for both nitrogen and phosphorus. ✓ Soil not analyzed once every five years for phosphorus. ✓ Results not used in determining application rates for manure, litter, and process wastewater.
<p>3. Establish protocols to land apply manure, litter or process wastewater in accordance with site-specific NMP that ensure appropriate agricultural utilization of the nutrients in the manure, litter or process wastewater (40 CFR 122.42(e)(1)(viii)).</p>	<ul style="list-style-type: none"> ✓ Site map showing land application fields. ✓ NMP or CNMP. ✓ Manure spreading agreements. ✓ Manure application rate calculations in accordance with the methodology in the NMP. ✓ Land application records. ✓ Application equipment inspection logs. 	<ul style="list-style-type: none"> ✓ No documentation of manure application rates, protocols, or schedules. ✓ The CAFO land applies manure and/or wastewater AND commercial fertilizer without agronomic rate calculations supporting the application of both types. ✓ Manure application at rates higher than the rates calculated in accordance with the NMP methodology. ✓ Nutrient credits from irrigation water, previous legume crops, and mineralization from previous manure applications are not included in manure application rate calculations. ✓ Manure is applied at a constant rate across all fields and crop types. ✓ Land application records are incomplete (e.g., do not specify manure source, amount, dates, application method). ✓ Actual amount of nutrients applied is calculated at the end of the season rather than tracked for each application event. ✓ Manure is applied to fields that are not identified in the NMP. ✓ Manure is imported to, or exported from, the CAFO for land application, and this is not documented in the NMP, (or the amounts not noted).

Table 15-10. Example Records and Potential Compliance Alerts Associated with NMP Minimum Measures vi–viii

Minimum Measure	Example Records	Potential Compliance Alerts
For Subpart C and D CAFOs: Land application equipment inspections for leaks	<ul style="list-style-type: none"> ✓ Application equipment inspection logs. 	<ul style="list-style-type: none"> ✓ Application equipment inspection logs do not include a section to record leak inspection information. ✓ Facility representative unable to confirm that land application equipment is periodically inspected for leaks.
For Subpart C and D CAFOs: Specific land application area recordkeeping requirements	<ul style="list-style-type: none"> ✓ Expected crop yields. ✓ Date(s) manure, litter, or process wastewater is applied to each field. ✓ Recorded weather conditions starting 24 hours before land application and ending 24 hours after land application is finished. ✓ Test methods used to sample and analyze manure, litter, process wastewater and soil. ✓ Results from manure, litter, process wastewater, and soil sampling. ✓ Explanation of the basis for determining manure application rates, as provided in the technical standards established by the Director. ✓ Calculations showing the total nitrogen and phosphorus to be applied to each field, including sources other than manure, litter, or process wastewater. ✓ Total amount of nitrogen and phosphorus applied to each field, including documentation of calculations for the total amount applied. ✓ Method used to apply the manure, litter, or process wastewater. ✓ Date(s) and results of manure application equipment inspection. 	<ul style="list-style-type: none"> ✓ CAFO does not have records for land application fields and activities.

In addition to the above records, permitted large CAFOs, regardless of animal sector, must keep records of all manure transfers. Prior to transferring manure, litter or process wastewater to other persons, the CAFO must provide the recipient of the manure, litter or process wastewater with the most current nutrient analysis. The CAFO must also retain records of the date of the

transfer, the name and address of the recipient, and the approximate amount of manure, litter, or process wastewater transferred (tons/gallons). These records must be maintained for 5 years from the date the manure, litter, or process wastewater is transferred.

Records for Permitted Medium and Small CAFOs

Permitted medium and small CAFOs are subject to the same requirements as a Large Permitted CAFO, with the exception of the ELG. Permitted medium and small CAFOs must maintain records to document NMP development and implementation, but are not subject to the ELG (40 CFR Part 122.42(e)). Any technology-based requirements and associated records will be specified in the permit for a medium or small CAFO and may be similar to the ELG requirements for large CAFOs.

E. CLOSING CONFERENCE

CAFO representatives are usually anxious to hear and discuss the inspection findings before the inspector departs. The inspector should hold a closing meeting or conference to present and discuss preliminary inspection findings (e.g., CAFO is not recording weekly depth marker readings, impoundments had less than 1 foot of freeboard, inspections not being done, confined livestock not kept out of waters of the United States). The inspector does not make a determination of an operation's CWA compliance or noncompliance status at the time of the inspection. The inspector should characterize the post inspection closing conference feedback as preliminary, acknowledging that the inspector may identify additional issues or concerns while going through records and notes after the inspection and that compliance will be determined by the case review officer with input from the inspector after a review of all information obtained. The inspector may find it helpful to tie inspection feedback to specific regulatory requirements.

The closing conference is also an excellent time to provide the producer with compliance assistance information or refer the producer to sources of additional information. The inspector is often the only contact between EPA and the regulated industries; be aware of opportunities to promote compliance with EPA regulations. During an inspection, the inspector has first-hand knowledge of the inspection site, as well as knowledge of any specific questions or problems the site officials may have. Use this time to answer those questions and/or convey information that will move the site toward improving compliance and acting in an environmentally responsible manner. There are some limitations on the types of compliance assistance that are appropriate. The inspector should follow the guidelines described in EPA's *Final National Policy: Role of the EPA Inspector in Providing Compliance Assistance During Inspections* (EPA, 2003a).

EPA has put together a series of answers to commonly asked questions to help livestock and poultry operation owners and operators understand what to expect from EPA National Pollutant Discharge Elimination System (NPDES) inspections (EPA, 2014), available at <https://www.epa.gov/compliance/fact-sheet-livestock-and-poultry-operation-inspections>. Other examples of appropriate compliance assistance to a facility include:

- Providing copies of statutes, regulations, or fact sheets

- Providing guidance manuals or technical documents
- Distributing the small business information sheet
- Providing facilities with related websites
- Mentioning that state requirements may apply

Inspectors should visit EPA's Ag Center website at <https://www.epa.gov/agriculture> for **compliance assistance** resources that may help the CAFO facilities they inspect. Other CAFO compliance assistance resources include:

- EPA's Compliance Assistance Centers website:
<https://www.epa.gov/compliance/compliance-assistance-centers>
- USDA Cooperative Extension Service's "eXtension" animal manure management site:
http://extension.org/animal_manure_management

During this meeting or conference, the inspector should also answer final questions, prepare necessary document receipts, provide any additional information about the NPDES program, and request the compilation of data that were not available at the time of the inspection.

Inspectors should be prepared to discuss follow-up procedures, such as how results of the inspection will be used and what further communications the region, state, tribe, or locality may have with the facility.

F. AFTER THE CAFO OR AFO INSPECTION

Post-inspection activities begin when the inspector departs the facility. This includes delivering samples to the laboratory in accordance with the protocols outlined in the QAPP (see Appendix AN, "Sample Quality Assurance Project Plan (QAPP)") and any needed post-inspection biosecurity measures. This section may be brief, but the activities covered are critical to ensure that information and data collected during the inspection are accurately documented and presented in the written inspection report. The written report, along with photographs and other evidence collected during the inspection, will be used by EPA attorneys and senior compliance and enforcement managers to make legal decisions pertaining to the facility's compliance status and potential enforcement responses. The report might also document that the facility was in compliance with its NPDES permit at the time of the inspection, which could be an important factor in determining whether any future discharges are allowable, in accordance with the permit conditions (see Appendix AP, "Inspection Report Template (R7)").

Given the importance of the inspection report the inspector is strongly encouraged to begin the inspection report as soon as possible following the inspection. Particular activities that should be accomplished on the day or days following the inspection include:

- Review inspection notes and document any details that were discussed during the inspection but not recorded in the notes, particularly compliance concerns. These items should be annotated to make clear that they were added after the inspection.

- Document or highlight the potential compliance issues identified during the closing conference with the facility representative.
- Identify missing information on the checklist and contact the operator for this information.
- Download, organize and add descriptions to inspection photos, or have inspection film developed. Follow the Digital Camera Guidance for EPA Civil Inspections and Investigations.
- Place documents claimed as confidential business information (CBI) in a secure location (this must occur as soon as the inspector returns to the office).

Generally, the accuracy and quality of the inspection report is highest when the report is completed promptly.

COMMUNICATION WITH THE CAFO OPERATOR

It may be necessary to follow up with an operator after the inspection if additional information is needed or to clarify certain information obtained during the inspection. As it can be difficult to reach an operator who is busy, the inspector should use the closing conference to establish the best times and approach for post-inspection communication (e.g., mobile phone, office phone, email, or fax). Any information obtained from the operator after the inspection should be identified in the inspection notes and report.

Post Inspection NMP Records Evaluation

The records and document review portion of the CAFO inspection should provide the inspector with an opportunity to review required documentation. However, the inspector may not have adequate time to review laboratory reports, rate calculations, and land application records. As a result, the inspector may need to complete the records review back in the office. Refer to Section B for a list of records to photocopy for post inspection evaluation. Appendix AO, “Detailed Review of Nutrient Management Plan Implementation” provides more detail on reviewing NMPs and land application records.

Inspection Report Generation

After the inspector has reviewed all the information obtained during the inspection and contacted the operator, if needed for any clarifying information, an inspection report should be prepared. The inspection report will generally include the inspection checklist, documentation copied during the inspection, an explanation of findings, and supporting photographs. See NPDES Inspection Manual for detailed information on preparation of an NPDES inspection report. The inspector should follow EPA quality control/quality assurance procedures for inspection reports.

Compliance Determination and Follow-Up Action

Senior EPA compliance personnel will review the completed inspection report and evaluate whether the facility is in compliance and what type of follow-up action is appropriate. EPA

responds to noncompliance in several different ways, depending upon the nature and circumstances of the violation(s):

- No follow-up needed
- Letter notifying the facility of violation(s) (e.g., NOVs) or compliance assistance
- Administrative compliance order
- Administrative compliance order plus administrative penalty
- Civil judicial enforcement action (penalties and/or injunctive relief)
- Criminal enforcement investigation

Compliance decisions will be based on observations, data, and other evidence collected during the inspection. Thus, it is the inspector's responsibility to carefully document all aspects of the inspection process so senior compliance personnel can make an informed legal decision about the facility's compliance status and to ensure that any required follow-up action is based on sound, factual evidence.

Once finalized, EPA should send a copy of the report to the inspected facility. If it is not a region's practice to send the report to the facility, there should be some communication with the facility to transmit the results of the inspection. Note that the inspection report may be addressed to a responsible official who is different from the facility representative who participated in the inspection. The responsible official will typically be an individual authorized to make management and financial decisions which govern operation of the facility (40 CFR 122.22(a)(1)).

File Maintenance

It is important once the inspection report is complete to ensure all documents associated with the inspection, including all field notes and photographs, are properly filed in a readily identified location that corresponds with the currently used filing system (e.g., facility name, permit number). The inspector should mark all information claimed to be CBI and place it in a locked filing cabinet or a safe immediately after the inspection is completed. CBI includes information considered to be trade secrets (including chemical identity, processes, or formulation) that could damage a company's competitive position if they became publicly known. The facility representative is responsible for identifying CBI during the inspection; the inspector will have discussed this during the opening conference.

As previously mentioned, the information presented in this chapter is intended to be comprehensive and broadly applicable to the majority of EPA inspections at permitted and unpermitted CAFOs; however, there will always be situations that require the inspector to rely on their best professional judgment, knowledge of the regulations, and familiarity with EPA Region-specific policies. As such, the inspector is encouraged to periodically review the NPDES Compliance Inspection Manual and other resources referenced in this manual to remain up to date on national and regional EPA compliance inspection policies and procedures.

G. REFERENCES

The following is a list of resources providing additional information on CAFOs.

- Adams, T. (2012). "What does a cattle disease look like in a human?" *Farm & Ranch Guide*. Available at: http://www.farmandranchguide.com/news/livestock/what-does-a-cattle-disease-look-like-in-a-human/article_41f0aeac-4b80-11e1-a531-0019bb2963f4.html
- Pelzer, K.D. and N. Currin. (2009). *Zoonotic Diseases of Cattle*. Blacksburg, Virginia: Virginia Cooperative Extension, Virginia Polytechnic Institute and State University. Available at: <http://pubs.ext.vt.edu/400/400-460/400-460.html>
- Sierra Club v. Abston Constr. Co. (5th Cir. 1980). 620 F.2d 41, 45-46.
- U.S. Department of Agriculture. (2007). U.S. Department of Agriculture Census of Agriculture.
- U.S. Department of Agriculture, Natural Resources Conservation Service (NRCS). (2009). *Part 304 – Comprehensive Nutrient Management Plan Technical Criteria*. Available at: <http://directives.sc.egov.usda.gov/viewerFS.aspx?hid=25686>.
- U.S. Environmental Protection Agency. (1984). *EPA Policy for the Administration of Environmental Programs on Indian Reservations*. Available at: <https://www.epa.gov/tribal/epa-policy-administration-environmental-programs-indian-reservations-1984-indian-policy>
- U.S. Environmental Protection Agency. (1992). *NPDES Storm Water Program Question and Answer Document, Volume 1*. EPA 833-F-93-002.
- U.S. Environmental Protection Agency. (1995). *Guide Manual on NPDES Regulations for Concentrated Animal Feeding Operations*. EPA-833-B-95-001.
- U.S. Environmental Protection Agency. (2001a). *Final Guidance on the Enforcement Principles Outlined in the 1984 Indian Policy*. Available at: <https://www.epa.gov/enforcement/transmittal-final-guidance-enforcement-principles-outlined-1984-indian-policy-january-17>
- U.S. Environmental Protection Agency. (2002). *Development Document for the Final Revisions to the National Pollutant Discharge Elimination System Regulation and the Effluent Guidelines for Concentrated Animal Feeding Operation*. EPA-821-R-03-001.
- U.S. Environmental Protection Agency. (2003a). *Final National Policy: Role of the EPA Inspector in Providing Compliance Assistance During Inspections*. Available at: <https://www.epa.gov/compliance/policy-role-epa-inspector-providing-compliance-assistance-during-inspections>

- U.S. Environmental Protection Agency. (2003b). *NPDES Permit Writers' Guidance Manual and Example Permit for Concentrated Animal Feeding Operations*. EPA-833-B-04-001
- U.S. Environmental Protection Agency. (2004). *Managing Manure Nutrients at Concentrated Animal Feeding Operations*. EPA 821-B-09-009.
- U.S. Environmental Protection Agency. (2012a). *NPDES Permit Writers' Manual for Concentrated Animal Feeding Operations*. Office of Water, Office of Wastewater Management. EPA 833-F-12-001.
- U.S. Environmental Protection Agency. (2012b). *National Pollutant Discharge Elimination System Permit Regulation for Concentrated Animal Feeding Operations: Removal of Vacated Elements in Response to 2011 Court Decision, Final Rule*. EPA-HQ-OW-2012-0142; FRL-9705-6.
- U.S. Environmental Protection Agency. (2014). *Fact Sheet: Livestock and Poultry Operation Inspections*. EPA 305-F-14-0.
- U.S. Environmental Protection Agency. (2016). *Biosecurity Procedures for Visits to Livestock and Poultry Facilities*. OECA-PROC-2016-010-R0. Available at:
<https://www.epa.gov/compliance/guidance-biosecurity-procedures-visits-livestock-and-poultry-facilities>
- U.S. Environmental Protection Agency. (2016). *NPDES Compliance Inspection Manual*. Office of Enforcement and Compliance Assurance. EPA 305-X-04-001.
- Waterkeeper Alliance, Inc. v. EPA. (2d Cir. 2005). 399 F.3d 486, 510-11.

CHAPTER 16– VESSEL GENERAL PERMIT (VGP)

A. Background and Overview	431
Background and History of the VGP	431
VGP Overview.....	431
B. Permits.....	434
Authorization under the VGP	434
Discharge Types Specifically Not Authorized By the VGP	435
Technology-Based Effluent Limits and related requirements Applicable to All Vessels.....	435
Effluent Limits and Related Requirements For Specific Discharge Categories	438
Vessel Class-Specific Requirements	443
Additional Water Quality-Based Effluent Limits	445
C. Permit Inspections and Monitoring	446
Self Inspections and Monitoring	446
Permit Recordkeeping.....	449
Additional Recordkeeping for vessels Equipped with Ballast Tanks	451
Permit Reporting	452
Vessel Inspection Overview.....	454
VGP Inspection Procedures	455
D. Safety Hazards	465
Expected Hazards	465
Physical Hazards	465
Thermal Hazards.....	465
Chemical Hazards	465
Biological Hazards.....	466
Personal Protective Equipment (PPE)	466
E. Violations and Examples	466
Common VGP Violations and Examples of Good and Bad Practices.....	466
Good and Bad Practices.....	467
F. References.....	470

Tables

Table 16-1. Vessel Discharge Descriptions.....	461
--	-----

Related Websites

Vessel General Permit webpage: <https://www.epa.gov/npdes/vessels-incident-discharge-permitting-3>.
 Vessels Notice of Intent (eNOI) webpage: <https://ofmpub.epa.gov/apex/vgpenoi/f?p=102:101>.
 Vessels One-Time Report webpage: https://ofmpub.epa.gov/apex/aps/f?p=VGP_2008:HOME:::

A. BACKGROUND AND OVERVIEW

BACKGROUND AND HISTORY OF THE VGP

In addition to materials in this chapter, inspectors must be familiar with Chapter 1, “Introduction,” and Chapter 2, “Inspection Procedures.”

In December 2003, a long-standing exclusion of discharges incidental to the normal operation of vessels¹⁷ from the NPDES program became the subject of a lawsuit in the U.S. District Court for the Northern District of California (Northwest Env'tl. Advocates et al. v. United States EPA, 2005). On March 30, 2005, the U.S. District Court for the Northern District of California determined that the exclusion exceeded the Environmental Protection Agency's (EPA's) authority under the Clean Water Act (CWA) and in September 2006 issued a final order stating:

- The blanket exemption for discharges incidental to the normal operation of a vessel, contained in Title 40 of the *Code of Federal Regulations* (CFR) Part 122.3(a), shall be vacated as of September 30, 2008.
- Northwest Env'tl. Advocates et al. v. United States EPA, 2006 U.S. Dist. LEXIS 69476 (N.D. Cal., 2006).

EPA appealed the District Court's decision to the Ninth Circuit, and on July 23, 2008, the Court upheld the decision (Northwest Env'tl. Advocates v. EPA, 2008).

This meant that, effective December 19, 2008, except for those vessels exempted from National Pollutant Discharge Elimination System (NPDES) permitting by Congressional legislation, discharges incidental to the normal operation of vessels which were excluded from NPDES permitting by 40 CFR 122.3(a), were subject to CWA section 301's prohibition against discharging, unless covered under an NPDES permit. The CWA authorizes civil and criminal enforcement for violations of that prohibition and allows for citizen suits against violators.

In response to the court decisions, the EPA issued the first Vessel General Permit (VGP) in December 2008, which expired on December 19, 2013. On April 12, 2013, EPA issued the final 2013 NPDES VGP, which replaces the 2008 NPDES VGP at expiration and extends to December 19, 2018.

VGP OVERVIEW

Eligibility and Limitation on Coverage

The VGP is applicable to discharges incidental to the normal operation of non-recreational, non-military vessels into waters subject to the permit. The permit applies to all vessels operating in a capacity as a means of transportation that have discharges incidental to their normal operations into waters subject to the permit, with some exceptions.

¹⁷ “Vessel” means every description of watercraft or other artificial contrivance being used as a means of transportation on “Waters Subject to this Permit” (modified from CWA section 312(a)).

Operating in a Capacity as a Means of Transportation

Vessels that are NOT being operated in a capacity as a means of transportation as set out in 40 CFR 122.3(a) (and whose discharges are accordingly NOT applicable to the VGP) include vessels being used as energy or mining facilities, storage facilities, seafood processing facilities, or vessels that are secured to a storage facility or a seafood processing facility, or when secured to the bed of the ocean, contiguous zone, or water of the United States for the purpose of mineral or oil exploration or development.

Similarly, vessels in drydock and “floating” craft that are permanently moored to piers (e.g., “floating” casinos, hotels, restaurants, and bars) are not covered by the VGP, as they are not operating in a capacity as a means of transportation.

With respect to vessels under construction, when the vessel is engaged in sea trials that result in operational discharges, because testing is a critical part of vessel operation, such discharges would be incidental to the normal operation of a vessel, and thus eligible for coverage under the VGP; however, any discharges resulting from construction activities are not covered by the VGP as they are incidental to vessel construction, not vessel operation.

Generally, except as provided for above, a vessel is operating in the capacity as a means of transportation while underway (in transit), temporarily moored to a pier or other mooring device, performing cargo loading/off-loading operations, fueling or defueling, during tug or tow operations, or while performing maintenance outside of a drydock while temporarily moored.

Discharges Incidental to the Normal Operation of Vessels

The discharges eligible for coverage under the VGP are those discharges incidental to the normal operation of a vessel covered by the exclusion in 40 CFR 122.3(a) prior to any vacatur of that exclusion. Discharges incidental to normal operation include deck runoff from routine deck cleaning, bilgewater from properly functioning oily water separators, and ballast water. Some potential discharges are not incidental to the normal operation of a vessel. For example, intentionally adding used motor oil to the bilge tank will result in a discharge that is not incidental to the normal operation of a vessel. Furthermore, any discharge that results from a failure to properly maintain the vessel and equipment, even if the discharge is of a type that is otherwise covered by the permit, is not eligible for permit coverage. Discharges that are neither covered by the VGP nor exempt from section 402 of the CWA must be covered under a separate individual or general permit.

The list below identifies each of the 27 effluent streams eligible for coverage under the permit (listed in the same order as Part 2.2 of the permit):

- Deck washdown and runoff and above water line hull cleaning.
- Bilgewater/oily water separator effluent.
- Ballast water.
- Anti-fouling hull coatings/hull coating leachate.
- Aqueous Film Forming Foam (AFFF).
- Boiler/economizer blowdown.

- Cathodic protection.
- Chain locker effluent.
- Controllable pitch propeller and thruster hydraulic fluid and other oil-to-sea interfaces including lubrication discharges from paddle wheel propulsion, stern tubes, thruster bearings, stabilizers, rudder bearings, azimuth thrusters, propulsion pod lubrication, and wire rope and mechanical equipment subject to immersion.
- Distillation and reverse osmosis brine.
- Elevator pit effluent.
- Firemain systems.
- Freshwater layup.
- Gas turbine washwater.
- Graywater (except that graywater from commercial vessels operating in the Great Lakes within the meaning of CWA section 312 is excluded from the requirement to obtain a NPDES permit (see CWA section 502(6)), and thus is not within the scope of the VGP);
- Motor gasoline and compensating discharge.
- Non-oily machinery wastewater.
- Refrigeration and air condensate discharge.
- Seawater cooling overboard discharge (including non-contact engine cooling water, hydraulic system cooling water, refrigeration cooling water).
- Seawater piping biofouling protection.
- Boat engine wet exhaust.
- Sonar dome discharge.
- Underwater ship husbandry and hull fouling discharges.
- Weldeck discharges.
- Graywater mixed with sewage from vessels.
- Exhaust gas scrubber washwater discharge.
- Fish hold effluent.

Waters Subject to the VGP

Waters subject to the VGP are “waters of the United States” as defined in 40 CFR Part 122.2 (extending to the outer reach of the 3-mile territorial sea as defined in section 502(8) of the CWA). This includes all navigable waters of the Great Lakes subject to the jurisdiction of the United States. The permit does not apply to discharges beyond the 3-mile territorial sea.

The general permit covers vessel discharges into the waters of the United States in all states, tribes and territories, regardless of whether a state or territory is authorized to implement other aspects of the NPDES permit program within its jurisdiction, except as otherwise excluded by Part 6 of the permit (Specific Requirements for Individual States or Indian Country Lands).

Vessel Universe Affected by the VGP

Vessels covered under the VGP include, cruise ships, ferries, barges, mobile offshore drilling units, oil tankers or petroleum tankers, bulk carriers, cargo ships, container ships, other cargo freighters, refrigerant ships, research vessels, emergency response vessels, including firefighting and police vessels, and any other non-military, non-recreational vessel that is greater than or equal to 79 feet in length and operating in a capacity of transportation. EPA estimates that there are approximately 61,000 U.S. flagged vessels that may be eligible for coverage under the permit. Additionally, EPA estimates that there are up to 8,000 additional foreign flagged vessels that may need coverage under the permit.

With respect to commercial fishing vessels of any size as defined in Title 46 of the *United States Code* (USC) section 2101, and non-recreational vessels that are less than 79 feet in length, the coverage of the VGP is limited to ballast water discharges only. Public Law (P.L.) 110-299 (July 31, 2008) provided for a temporary two-year moratorium on NPDES permitting of discharges incidental to normal operation of all commercial fishing vessels (except ballast water) and non-recreational vessels less than 79 feet in length. This moratorium was extended multiple times, with the current moratorium lasting until to December 18, 2018 as of this publication. After December 18, 2018, these vessels will be covered by the VGP, unless Congress takes further action.

Recreational vessels as defined in CWA section 502(25) are not subject to the VGP. Recreational vessels are not subject to NPDES permitting under CWA section 402, and are instead subject to regulation under CWA section 312(o).

Vessels of the Armed Forces as defined in CWA section 312(a)(14) are also not subject to the VGP.

B. PERMITS

AUTHORIZATION UNDER THE VGP

To obtain authorization to discharge under the VGP, vessel operators/owners must meet the Part 1.2 eligibility requirements. If the vessel meets the requirements under Part 1.5.1.1, and was authorized to discharge under the 2008 VGP, the vessel operator/owner must submit an NOI to receive permit coverage seven days before the effective date of the VGP to continue uninterrupted coverage.

Vessels authorized to discharge under the 2008 VGP were vessels that had submitted an NOI or were not subject to the NOI requirement by Part 1.5.1.2 of the 2008 VGP. If the vessel was not authorized to discharge under the 2008 VGP and meets the requirements under Part 1.5.1.1, the vessel operator/owner must submit an NOI to receive permit coverage at least 7 days or more than 30 days (as applicable) before discharging into waters subject to the VGP.

Owner/operators of vessels that meet the requirements under Part 1.5.1.2 are not required to submit NOIs. Instead these owner/operators must sign and maintain a copy of the Permit Authorization and Record of Inspection (PARI) form onboard at all times. Vessels in this category are still subject to all applicable VGP requirements.

If the vessel is greater than or equal to 300 gross tons or the vessel has the capacity to hold or discharge more than 8 cubic meters (2,113 gallons) of ballast water, the vessel operator/owner must submit a signed and certified, complete and accurate NOI in accordance with the requirements.

If the vessel is less than 300 gross tons and the vessel does not have the capacity to hold or discharge more than 8 cubic meters (2113 gallons) of ballast water, the vessel owner/operator does not need to submit an NOI; however, they must complete the PARI form.

DISCHARGE TYPES SPECIFICALLY NOT AUTHORIZED BY THE VGP

EPA has identified several discharge types not authorized by the VGP because, among other things, the discharge is not within the scope of the current 40 CFR 122.3(a) exclusion or not within the scope of EPA's NPDES permitting authority (see Part 1.2.3 of the permit). These discharges include:

- Discharges not subject to former NPDES permit exclusion.
- Discharges generated from vessels when they are operated in a capacity other than as a means of transportation.
- Sewage as defined at CWA section 502(6) and 40 CFR 122.2 (sewage is instead regulated under CWA section 312 and 40 CFR Part 140 and 33 CFR Part 159).
- Used or spent oil.
- Garbage or trash (including discharges of bulk dry cargo residues as defined at 33 CFR 151.66(b) and agricultural cargo residues) (discharges of garbage continue to be subject to regulation under 33 CFR Part 151, Subpart A).
- Photo-processing effluent.
- Effluent from dry cleaning operations.
- Discharges of medical waste and related materials.
- Discharges of noxious liquid substance residues.
- Tetrachloroethylene (perchloroethylene) and trichloroethylene degreasers.
- Discharges currently or previously covered by NPDES permits.

TECHNOLOGY-BASED EFFLUENT LIMITS AND RELATED REQUIREMENTS APPLICABLE TO ALL VESSELS

The following effluent limits are required by the VGP, regardless of the type of vessel owned or operated.

Material Storage

For cargoes or other onboard materials that might wash overboard or dissolve because of contact with precipitation or surface water spray, or which may be blown overboard by air currents, minimize the amount of time these items are exposed to such conditions. Locate storage areas on the vessel for such items in covered areas where feasible and consistent with

any applicable regulations promulgated by the Secretary of the Department in which the Coast Guard is operating that establish specifications for safe transportation, handling, carriage, and storage of pollutants (see Part 2.1.5 of the permit). If water draining from storage areas contacts oily materials, vessel owners/operators must:

- Use dry cleanup methods or absorbents to clean up the wastewater.
- Store the water for onshore disposal.
- Run the water through an oily water separator when so required by Coast Guard regulations, or if not subject to such requirement, use other effective methods to comply with Part 2.1.4 of the permit to prevent the discharge into waters subject to the permit of any oils, including oily materials, in quantities which may be harmful as defined in 40 CFR Part 110.

Toxic and Hazardous Materials

Where consistent with vessel design and construction, vessel owners/operators must locate toxic and hazardous materials in protected areas of the vessel unless the master determines this would interfere with essential vessel operations or safety of the vessel, or doing so would violate any applicable regulations promulgated by the Secretary of the Department in which the Coast Guard is operating that establish specifications for safe transportation, handling, carriage, and storage of pollutants (see Part 2.1.5 of the permit). Any discharge that is made for safety reasons must be documented as part of the requirements in Part 4.2 of the permit. This includes ensuring that toxic and hazardous materials are in appropriate sealed containers constructed of a suitable material, labeled, and secured. Containers must not be overfilled and incompatible wastes should not be mixed. Exposure of containers to ocean spray or precipitation must be minimized. Jettisoning of containers holding toxic or hazardous material is not authorized by the VGP.

Fuel Spills/Overflows

Fuel spills or overflows must not result in a discharge of oil in quantities that may be harmful, pursuant to 40 CFR Part 110. Vessel owners/operators must conduct all fueling operations using control measures and practices designed to minimize spills and overflows and ensure prompt containment and cleanup if they occur. Vessel operators must not overfill fuel tanks. For vessels with interconnected fuel tanks, fueling must be conducted in a manner that prevents overfilling and release from the system to the environment.

Vessels with air vents from fuel tanks must use spill containment or other methods to prevent or contain any fuel or oil spills. Large scale fuel spills or overflows are not incidental to the normal operation of the vessel and are not authorized by the VGP.

The following requirements apply to fueling of auxiliary vessels such as lifeboats, tenders or rescue boats deployed from “host” vessels subject to the VGP:

- While fueling, examine the surrounding water for the presence of a visible sheen. If a visible sheen is observed as a result of fueling, it must be cleaned up immediately.

- It is important to know the capacity of the fuel tanks before fueling begins to prevent unintentionally overfilling the tank.
- Prevent overfilling and do not top off fuel tanks.
- When possible, fill fuel tanks while boat is on shore or recovered from the water.
- When possible, fill portable tanks on shore or on the host vessel, not on the auxiliary vessel.
- Use an oil absorbent material or other appropriate device while fueling the auxiliary vessel to catch drips from the vent overflow and fuel intake.
- Regularly inspect the fuel and hydraulic systems for any damage or leaks.

Owner/operators shall ensure that all crew responsible for conducting fueling operations are trained in methods to minimize spills caused by human error and/or the improper use of equipment.

Discharges of Oil Including Oily Mixtures

All discharges of oil, including oily mixtures, from ships subject to Annex I of the International Convention for the Prevention of Pollution from Ships as implemented by the CWA to Prevent Pollution from Ships and U.S. Coast Guard regulations found in 33 CFR 151.09 (hereinafter referred to as “MARPOL vessels”) must have concentrations of oil less than 15 parts per million (ppm) (as measured by EPA Method 1664 or other appropriate method for determination of oil content as accepted by the International Maritime Organization (IMO) (e.g., ISO Method 9377) or U.S. Coast Guard) before discharge. All MARPOL vessels must have a current International Oil Pollution Prevention Certificate (IOPP) issued in accordance with 33 CFR 151.19 or 151.21. All other discharges of oil including oily mixtures must not contain oil in quantities that may be harmful, pursuant to 40 CFR Part 110.

Compliance with Other Statutes and Regulations

As required by 40 CFR 122.44(p), vessel owners/operators must comply with any applicable regulations promulgated by the Secretary of the Department in which the Coast Guard is operating, that establish specifications for safe transportation, handling, carriage, and storage of pollutants.

Any discharge from vessels must comply with: section 311 (40 CFR Part 110) of the CWA; regulations requiring prevention of pollution from ships (40 CFR Part 1043); the National Marine Sanctuaries Act and implementing regulations (15 CFR Part 922 and 50 CFR Part 404); the Federal Insecticide, Fungicide, and Rodenticide Act (FIFRA, 40 CFR Part 152); and, the Oil Pollution Control Act (OPA of 1990, 40 CFR Part 112).

General Training

All owner/operators of vessels must ensure that the master, operator, person-in-charge, and crew members who actively take part in the management of incidental discharges or who may affect those discharges are adequately trained in implementing the terms of the VGP. In addition, all owner/operators of vessels must ensure appropriate vessel personnel be trained in the procedures for responding to fuel spills and overflows, including notification of appropriate

vessel personnel, emergency response agencies, and regulatory agencies. This training need not be formal or accredited courses; however, it is the vessel owners/operators' responsibility to ensure the staff are given the necessary information to conduct shipboard activities in accordance with the terms of the VGP.

Vessel owners/operators must also meet all training-related recordkeeping requirements of Part 4.2 of the VGP.

EFFLUENT LIMITS AND RELATED REQUIREMENTS FOR SPECIFIC DISCHARGE CATEGORIES

EPA's discharge-specific permit requirements applicable to all covered vessels that discharge them are provided in Part 2.2 of the permit by discharge. Below are examples of key permit requirements for several discharge types covered in the permit. The inspector should refer to the full list of permit requirements for all 27 discharge types in Part 2.2 of the permit.

Deck Washdown and Runoff and Above Water Line Hull Cleaning

Vessel owners/operators must minimize deck washdowns while in port. Vessel owner/operators must also minimize the introduction of on-deck debris, garbage, residue, and spill into deck washdown and runoff discharges. Deck washdowns should have minimal presence of floating solids, visible foam, halogenated phenol compounds, and dispersants, or surfactants.

Vessel owners/operators must maintain their topside surface and other above water line portions of the vessel to minimize the discharge of rust (and other corrosion byproducts), cleaning compounds, paint chips, non-skid material fragments, and other materials associated with exterior topside surface preservation.

Measures that may be implemented by the operator/owner to minimize deck washdown or above water line hull cleaning include:

- Using perimeter spill rails and scuppers to collect the runoff for treatment.
- Using coamings and drip pans for machinery on deck to collect and properly dispose of any oily discharge that may leak from machinery and prevent spills.
- Using minimally toxic and phosphate-free cleaners and detergents.
- Avoiding spray applications in windy conditions or avoiding over application.

Bilgewater/Oil Water Separator Effluent

All bilgewater discharges must be in compliance with the regulations in 40 CFR Parts 110 (Discharge of Oil), 116 (Designation of Hazardous Substances), and 117 (Determination of Reportable Quantities for Hazardous Substances) and 33 CFR 151.10 (Control of Oil Discharges). In addition:

- Vessel operators may not use dispersants, detergents, emulsifiers, chemicals, or other substances that remove the appearance of a visible sheen in their bilgewater discharges.

- Vessel operators may not add substances that drain to the bilgewater that are not produced in the normal operation of a vessel (except for additives used to enhance oil/water separation during processing). Routine cleaning and maintenance activities associated with vessel equipment and structures are considered to be normal operation of a vessel if those practices fall within normal marine practice.

Vessels must minimize the discharge of bilgewater into waters subject to the VGP by minimizing production, disposing near adequate treatment facilities, or discharging into waters not subject to the VGP (i.e., more than 3 nautical miles (nm) from shore) for vessels that regularly travel into such waters.

Vessels greater than 400 gross tons shall not:

- Discharge untreated bilgewater into waters subject to the VGP.
- Discharge treated bilgewater into federally protected waters unless the discharge is necessary to maintain the safety and stability of the ship (any discharge of bilgewater must be documented as part of the recordkeeping requirements in Part 4.2 of the VGP).
- Discharge treated bilgewater within 1 nm of shore if technically feasible or discharge into waters subject to the VGP unless the vessel is underway (any discharge that is made for safety reasons must be documented as part of the requirements in Part 4.2 of the VGP and reported in the vessel's annual report).

“New Build” vessels built after December 19, 2013 greater than 400 gross tons that may discharge bilgewater into waters subject to the VGP must monitor (i.e., sample and analyze) their bilgewater effluent at least once a year for oil and grease content. To demonstrate compliance with the permit, the bilgewater sample must be analyzed for oil. Subsequent sampling is not required if oil and grease concentrations are less than 5 ppm and the vessel meets the following conditions:

- Vessel uses an oily water separator capable of meeting a 5-ppm oil and grease limit, or has an alarm that prevents discharge of oil and grease at concentrations above 5 ppm.
- Oil content meter is calibrated at least annually.
- Oil content meter never reads above 5 ppm during discharges into waters subject to the VGP.

Records of monitoring must be retained onboard for at least 3 years in the vessel's recordkeeping documentation.

Ballast Water

All owner/operators of vessels equipped with ballast water tanks must maintain a ballast water management plan developed specifically for the vessel and train the master, operator, person-in-charge, and crew members who actively take part in the management of the discharge, or who may affect the discharge, on the application of ballast water and sediment management and treatment procedures as outlined in Parts 2.2.3.1 and 2.2.3.2 of the permit.

Ballast water management practices must comply with the requirements described in Part 2.2.3.3 of the permit to avoid or minimize uptake and discharge of ballast water and associated sediments during vessel operations. Avoid the discharge of ballast water into waters subject to the VGP that are within or that may directly affect marine sanctuaries, marine preserves, marine parks, shellfish beds, or coral reefs or other waters listed as federally protected waters. Clean ballast tanks to remove sediment in mid-ocean or under controlled arrangements in port or at drydock. As a condition of the VGP, all discharges of ballast water must also comply with applicable U.S. Coast Guard regulations found in 33 CFR Part 151.

Additionally, “Lakers” are subject to mandatory best management practices (BMPs) described in Part 2.2.3.4 of the VGP to reduce ballast water uptake and to implement sediment removal policies, including ballast water exchange and saltwater flushing.

All discharges of ballast water may not contain oil, noxious liquid substances (NLSs), or hazardous substances in a manner prohibited by U.S. laws, including section 311 of the CWA. Vessel operators/owners can meet the numeric limits listed in Part 2.2.3.5 by using any of the following water management measures:¹⁸

- Use a ballast water treatment system
- Send ballast water to onshore treatment facilities
- Use public water supply
- Do not discharge ballast water

If a vessel is subject to ballast water discharge limits and uses a ballast water treatment system (BWTS), then Part 2.2.3.5 of the VGP applies to the vessel and describes the monitoring requirements, in three components. The first component, in Part 2.2.3.5.1.1.2 generally requires monitoring equipment performance to assure the system is fully functional. Vessels conducting this monitoring also must adequately calibrate their equipment as required in Part 2.2.3.5.1.1.3. The second component, in Part 2.2.3.5.1.1.4, requires monitoring from all ballast water systems for selected biological indicators. The third component, in Part 2.2.3.5.1.1.5, requires monitoring of the ballast water discharge itself for biocides and residuals to assure compliance with the effluent limitations established in Part 2.2.3.5 of the permit, as applicable. Records of sampling and testing results required under Part 2.2.3.5.1.1 must be retained onboard for a period of three years in the vessel’s recordkeeping documentation.

Vessels must meet the requirements in Part 2.2.3.5.1 of the permit according to the following schedule, at which point the BWTS will become the Best Available Technology Economically Achievable (BAT):

¹⁸ EPA issued an Enforcement Response Policy on December 27, 2013 for EPA’s 2013 VGP: Ballast Water Dischargers and U.S. Coast Guard Extensions under 33 CFR Part 151. On a case-by-case basis, the U.S. Coast Guard may grant a schedule extension request pursuant to 33 CFR Part 151.2036 to a vessel to implement the required technology to meet the ballast water discharge standard requirements under the U.S. Coast Guard Regulations (33 CFR Part 151). EPA will consider this grant for extension when evaluating the enforcement priority for a vessel that has not complied with the numeric ballast water discharge limits in Part 2.2.3.5 of the 2013 VGP.

- New vessels (constructed after December 1, 2013) must comply on delivery.
- Existing vessels less than 1,500 m³ (constructed prior to December 1, 2013) must be drydocked after January 1, 2016.
- Existing vessels 1,500–5,000 m³ (constructed prior to December 1, 2013) must be drydocked after January 1, 2014.
- Existing vessels greater than 5,000 m³ (constructed prior to December 1, 2013) must be drydocked after January 1, 2016.

Vessel owners not subject to the requirements of Part 2.2.3.5 of the permit must meet the exchange and flushing requirements of Part 2.2.3.6. Ballast water exchange may not be used in lieu of meeting effluent limits in Part 2.2.3.5 of the permit once it becomes required to meet these limits. Part 2.2.3.6 outlines interim requirements for the following vessels:

- Vessels on oceangoing voyages (where ballast water was taken on in areas less than 200 nm from any shore that will subsequently operate beyond the Exclusive Economic Zone (EEZ) and in areas more than 200 nm from any shore).
- Vessels engaged in Pacific Nearshore Voyages (where ballast water was taken on in areas less than 50 nm from any shore) and travels through more than one Captain of the Port (COTP) zone or crosses international boundaries.
- Vessels traveling between more than one COTP zone without ballast water on board (or un-pumpable residual ballast water).
- Vessels engaged in Pacific nearshore voyages with un-pumpable ballast water and residual sediment.

These vessels are also prohibited from discharging unexchanged or untreated ballast water or sediment in federally protected waters.

Controllable Pitch Propeller and Thruster Hydraulic Fluid and Other Oil-to-Sea Interfaces Including Lubrication Discharges from Paddle Wheel Propulsion, Stern Tubes, Thruster Bearings, Stabilizers, Rudder Bearings, Azimuth Thrusters, Propulsion Pod Lubrication, and Wire Rope and Mechanical Equipment Subject to Immersion

The vessel owner/operator must not discharge oil in quantities that may be harmful as defined in 40 CFR Part 110 from any oil-to-sea interface. If possible, maintenance activities on controllable pitch propellers, thrusters, and other oil-to-sea interfaces should be conducted when a vessel is in drydock.

All vessels must use an environmentally acceptable lubricant (EAL) in all oil to sea interfaces, unless technically infeasible. For purposes of requirements related to EALs, technically infeasible means that no EAL products are approved for use in a given application that meet manufacturer specifications for that equipment, products which come pre-lubricated (e.g., wire ropes) have no available alternatives manufactured with EALs, products meeting a manufacturer's specifications are not available within any port in which the vessel calls, or changeover and use of an EAL must wait until the vessel's next drydocking. If a vessel is unable to use an EAL, the vessel owner/operator must document in their recordkeeping

documentation consistent with Part 4.2 why the vessel operator/owner are unable to do so, and must report the use of a non-environmentally acceptable lubricant to EPA in the Annual Report. Use of an EAL does not authorize the discharge of any lubricant in a quantity that may be harmful as defined in 40 CFR Part 110.

Graywater

All vessels that have the capacity to store graywater shall not discharge that graywater in port or in federally protected waters. For vessels that cannot store graywater, vessel operators must minimize the production of graywater while in port and in federally protected waters.

Vessel owners/operators must use phosphate-free and minimally toxic soaps and detergents, as defined in Appendix A of the permit, for any purpose if graywater will be discharged into waters subject to the VGP. Soaps and detergents must be free from toxic or bioaccumulative compounds and not lead to extreme shifts in receiving water pH.

Graywater for new build vessels and vessels operating in the Great Lakes must meet one of the following requirements for graywater management:

- Vessel must hold all graywater for onshore discharge to an appropriate shore-side facility.
- The graywater discharge must not exceed 200 fecal coliform forming units per 100 milliliters and contain no more than 150 milligrams per liter of suspended solids.

The following monitoring requirements are applicable to vessels that discharge graywater into waters subject to the VGP and meet one of the following conditions:

- The vessel is a new build vessel constructed on or after December 19, 2013, has a maximum crew capacity greater or equal to 15, and provides overnight accommodations to those crew.
- The vessel is subject to Part 2.2.15.1 (Certain VGP Vessels Operating in the Great Lakes) of the VGP.

Vessel owners/operators must collect and analyze two samples per year, collected at least 14 days apart, and report the results of those samples as part of their Annual Report. Samples must be taken for Biochemical Oxygen Demand (BOD), fecal coliform, suspended solids, pH, and total residual chlorine. Vessel owner/operators may choose to conduct monitoring for *e. coli* in lieu of fecal coliform. Fecal Coliform or *E. coli* must only be analyzed once per year if vessels have difficulty analyzing the results within recommended holding times.

Records of the sampling and testing results must be retained onboard for at least 3 years in the vessel's recordkeeping documentation consistent with Part 4.2 of the permit.

Underwater Ship Husbandry and Hull Fouling Discharges

Vessel owners/operators must minimize the transport of attached living organisms when traveling into U.S. waters from outside the U.S. economic zone or between COTP zones. Management measures to minimize the transport of attached living organisms include selecting

an appropriate antifoulant management system and maintaining that system, in water inspection, cleaning, and maintenance of hulls, and thorough hull and other niche area cleaning when a vessel is in drydock.

Rigorous hull-cleaning activities should take place in dry dock where removal of organisms and paint can be contained and disposed of properly. The operator/owner should take measures to treat washwater (if generated) prior to discharging to waters subject to the VGP.

Vessel owners/operators who remove fouling organisms from hulls while the vessel is waterborne must employ methods that minimize the discharge of fouling organisms and antifouling hull coatings. These include:

- Use of appropriate cleaning brush or sponge rigidity to minimize removal of antifouling coatings and biocide releases into the water column.
- Limiting use of hard brushes and surfaces to the removal of hard growth.
- When available and feasible, use of vacuum or other control technologies to minimize the release or dispersion of antifouling hull coatings and fouling organisms into the water column.

Vessel owners/operators must minimize the release of copper-based antifoulant paints during vessel cleaning operations. Vessels that use copper-based anti-fouling paint must not clean the hull in copper-impaired waters (listed at <https://www.epa.gov/vessels-marinas-and-ports/vessel-sewage-discharges-homepage>) within the first 365 days after paint application unless there is a significant visible indication of hull fouling. If the operator/owner cleans the vessel before 365 days after paint application in copper-impaired waters, the operator/owner must document why this early cleaning was necessary.

VESSEL CLASS-SPECIFIC REQUIREMENTS

EPA's vessel class-specific permit requirements applicable to all covered vessels in those vessel classes are provided in Part 5 of the permit by vessel class. Examples of vessel class-specific requirements for large and medium cruise ships are presented below. The inspector should refer to Part 5 of the VGP to get a comprehensive list of permit requirements for all vessel classes.

Large and Medium Cruise Ships

While operating within 3 nm from shore, discharges of graywater are prohibited unless they meet the effluent standards in Parts 5.1.1.1.2 and 5.2.1.1.2¹⁹ of the VGP for large and medium cruise ships, respectively. Parts 5.1.1.1.2 and 5.2.1.1.2 graywater treatment standards are:

- The discharge must satisfy the minimum level of effluent quality specified in 40 CFR 133.102 (secondary treatment requirements).

¹⁹ The effluent standards listed in Parts 5.1.1.1.2 and 5.2.1.1.2 of the VGP are secondary limits set for graywater discharges.

- The geometric mean of the samples from the discharge during any 30-day period may not exceed 20 fecal coliform/100 milliliters (ml) and not more than 10 percent of the samples exceed 40 fecal coliform/100 ml.
- Concentrations of total residual chlorine may not exceed 10.0 micrograms per liter ($\mu\text{g/l}$).

Medium cruise ships are held to the same standards for graywater management as large cruise ships, unless they are a vessel unable to voyage more than 1 nm from shore and were constructed before December 19, 2008. For medium vessels built before December 19, 2008, onshore facilities for graywater discharges must be used if available. If such facilities are not available and the vessel does not have the capacity to treat graywater to meet the standards in Part 5.2.1.1.2 of the VGP, the vessel must hold the graywater unless it is underway and sailing at a speed of at least 6 knots in a water that is not federally protected waters.

When operating in nutrient impaired waters subject to the VGP, large and medium cruise ship vessels must not discharge any graywater unless the length of voyage in that water exceeds the vessel's holding capacity for graywater, and must minimize the discharge of any graywater into nutrient-impaired waters subject to the VGP, which may require minimizing the production of graywater.

Vessel operators must demonstrate through initial and maintenance monitoring (as described in Parts 5.1.2.2 and 5.2.2.2 of the VGP) that an effective treatment system is in place to comply with the discharge standards for treated graywater identified in Parts 5.1.1.1.2 and 5.2.1.1.2 of the VGP. For large cruise ships, monitoring is required if the ship will discharge graywater within 3 nm of shore. For medium cruise ships, monitoring is required if the ship will discharge within 1 nm of shore. The owner/operator must submit data to EPA showing that the graywater standards are achieved by their treatment system.

Cruise ship owners/operators must use soaps and detergents that are phosphate-free, minimally toxic, and biodegradable. Degreasers must be minimally toxic if they will be discharged as part of any wastestream.

Waste from mercury-containing products, dry cleaners or dry cleaner condensate, photo processing labs, medical sinks or floor drains, chemical storage areas, and print shops using traditional or non-soy-based inks and chlorinated solvents must be prevented from entering the ship's graywater, blackwater, or bilgewater systems if water from these systems will be discharged into waters subject to the VGP.

Vessel owners/operators must not discharge any toxic materials, including products containing acetone, benzene, or formaldehyde into salon and day spa sinks or floor drains if those sinks or floor drains lead to any system that will be discharged into waters subject to the VGP.

Vessel owners/operators must monitor chlorine or bromine concentrations (as applicable) in pool or spa water before every discharge event if they will discharge these streams in to waters subject to the permit.

Operators must provide educational and training programs to inform crew members on the appropriate management of ship discharges.

Permit Requirements for Individual States or Indian Country Lands

Part 6 of the VGP identifies provisions provided to EPA by states and tribes in their CWA section 401 certifications that the states and tribes deemed necessary to assure compliance with applicable provisions of the CWA and any other appropriate requirements of state and tribal law. Pursuant to CWA section 401(d), EPA has attached those state and tribal provisions to the VGP.

Permit Requirements for Waters Federally Protected Wholly or in Part for Conservation Purposes

Several of the discharge-specific and vessel class-specific permit requirements prohibit or limit various discharges in “waters federally protected in whole or in part for conservation purposes.” (Refer to Appendix G of the VGP for a complete list of federally protected waters.) These waters include:

- Marine Sanctuaries designated under the National Marine Sanctuaries Act and implementing regulations found at 15 CFR Part 922 and 50 CFR Part 404 or Marine national monuments designated under the Antiquities Act of 1906.
- A unit of the National Park System, including National Preserves and National Monuments.
- A unit of the National Wildlife Refuge System, including Wetland Management Districts, Waterfowl Production Areas, National Game Preserves, Wildlife Management Area, and National Fish and Wildlife Refuges.
- National Wilderness Areas and any component designated under the National Wild and Scenic Rivers System.
- Any waterbody designated as an Outstanding National Resource Water (ONRW) by a state or tribe.

Because it is possible to limit discharges to certain times, but not to limit those discharges indefinitely, EPA developed additional permit requirements for these waters likely to be of high quality and consist of unique ecosystems that may include distinctive species of aquatic animals and plants. Furthermore, as protected areas, these waters are more likely to have a greater abundance of sensitive species of plants and animals that may have trouble surviving in areas with greater anthropogenic impact.

ADDITIONAL WATER QUALITY-BASED EFFLUENT LIMITS

Water Quality-Based Effluent Limitations

The vessel’s discharge must be controlled as necessary to meet applicable water quality standards in the receiving water body or another water body impacted by the vessel’s discharges. EPA may impose additional water quality-based limitations on a site-specific basis, or require the operator/owner to obtain coverage under an individual permit, if information in the NOI (if applicable), required reports, or from other sources indicates that, after meeting the

water quality-based limitations in this part, the vessel's discharges are not controlled as necessary to meet applicable water quality standards, either in the receiving water body or another water body impacted by the vessel's discharges.

Discharges to Water Quality Impaired Waters

Impaired waters or "water quality limited segment[s]" are those which have been identified by a state or EPA pursuant to section 303(d) of the CWA as not meeting applicable state water quality standards. Impaired waters may include either waters with EPA-approved or EPA-established Total Maximum Daily Loads (TMDLs), and those for which EPA has not yet approved or established a TMDL. If the vessel discharges to an impaired water without an EPA-approved or established TMDL, the vessel operator/owner is required to comply with the requirements in Part 2.3.1, including any additional requirements that EPA may impose pursuant to that part.

If the vessel discharges to an impaired water with an EPA-approved or established TMDL and EPA or state TMDL authorities have informed the operator/owner that a Waste Load Allocation (WLA) has been established that applies specifically to the vessel's discharges, to discharges from vessels in the operator/owner's vessel class or type, or to discharges from vessels in general, the vessel's discharge must be consistent with the assumptions and requirements of that WLA.

C. PERMIT INSPECTIONS AND MONITORING

The VGP requires vessel operators to conduct self-inspections and monitoring, comprehensive annual vessel inspections, and drydock inspections.

SELF INSPECTIONS AND MONITORING

Routine Visual Inspections

Conduct routine visual inspections of all areas addressed in the VGP, including, but not limited to cargo holds, boiler areas, machinery storage areas, weldecks, and other deck areas. Ensure these areas are clear of garbage, exposed raw materials, oil, any visible pollutant or constituent of concern that could be discharged in any wastestream, and that pollution prevention mechanisms are in proper working order. At a minimum, the routine inspection must verify that requirements of Part 2.1 of the VGP (Technology-Based Effluent Limits and related requirements Applicable to All Vessels) are being met and document any instances of noncompliance. Routine inspections should be conducted on a schedule that coincides with other routine vessel inspections if feasible. Conduct a visual inspection of safely accessible deck and cargo areas and all accessible areas where chemicals, oils, dry cargo, or other materials are stored, mixed, and used—regardless of whether the areas have been used since the last inspection—at least once per week or per voyage, whichever is more frequent. If operators engage in multiple voyages per day, they need not conduct inspections on every voyage, but must conduct inspections at least once per day. Furthermore, the inspection should verify whether all monitoring, training, and inspections are logged according to permit requirements. A ship's watch must include visual monitoring of the water around and behind the vessel for visible sheens, dust, chemicals, abnormal discoloration or foaming, and other indicators of

pollutants or constituents of concern originating from the vessel. Particular attention should be paid to deck runoff, ballast water, and bilgewater. If vessel owners/operators identify or are made aware that pollutants or constituents of concern are originating from their vessel, they must initiate corrective actions in Part 3 of the VGP. Vessel owner/operators may conduct these inspections as part of meeting their existing (or updated) international safety management code (ISM) safety management system (SMS) plan obligations, if those inspections meet the minimum requirements discussed above.

In situations where multiple voyages occur within a one-week period, the operator/owner may choose to conduct a limited visual inspection addressing only those areas that may have been affected by activities related to the docking and cargo operations conducted during each voyage instead of conducting a full routine visual inspection per voyage (or per day, if there are multiple voyages in one day). If the operator/owner employs such an approach, they must conduct a full visual inspection of the vessel at least once per week.

The findings of each routine vessel inspection must be documented in the official ship logbook or as a component of other recordkeeping documentation referenced in Part 4.2 of the VGP (described below). The date and time of inspection, ship locations inspected, personnel conducting the inspection, location of any visual sampling and observations, and potential problems and sources of contamination must be documented and signed by the person conducting the inspection, if not the Master. The person conducting the inspection must be a signatory under 40 CFR 122.22. A signatory includes the person in charge (e.g., the Master), or his duly authorized representative. The records of routine visual inspections must be made available to EPA or its authorized representative upon request. Vessel operators must initiate corrective actions, as required under Part 3 of the VGP, for problems noted in their inspections.

Extended Unmanned Period (EUP) Inspections

A vessel is considered to be in an extended unmanned period (EUP) if the vessel is temporarily (e.g., for storage or repair) unmanned, fleeted, jacked-up, or otherwise has its navigation systems and main propulsion shut down (e.g., a vessel in drydock or extended lay-up) for 13 days or greater. Immediately before a vessel is placed in an EUP, the vessel operator must conduct a pre-lay-up inspection. During an EUP, a vessel owner/operator may elect to either continue conducting routine inspections of the vessel consistent with Part 4.1.1 of the VGP, or he or she may conduct an EUP Inspection. The EUP inspection is an alternative inspection for fleeted, jacked-up, or similarly situated vessels, which routinely go into temporary or extended periods of lay-up. Vessel owners/operators may conduct EUP inspections in lieu of routine visual inspections if they are up-to-date with all other inspection and reporting requirements found in Part 4 of the permit.

While a vessel is in EUP, the owner/operator or an authorized representative must examine the outside of the vessel and surrounding waters at least once every two weeks for any evidence of leaks, loss of cargo, or any other spills that might result in an unauthorized discharge. If any deficiencies are observed while the vessel is in EUP, the vessel owner/operator must document those deficiencies and the corrective actions taken to resolve those deficiencies. If a visible sheen is noted on the surface of the surrounding water, the source of the oil must be identified

and corrective action must be taken immediately. Furthermore, EPA must be notified of the visible sheen in accordance with Part 4.4 of the VGP.

Analytical Monitoring

Analytical monitoring requirements for specific discharge types are identified in Parts 2.2.2, 2.2.3, 2.2.15, and 2.2.26 of the VGP, and for specific vessel types in Part 5 of the VGP.

Comprehensive Annual Vessel Inspections

Comprehensive vessel inspections must be conducted by qualified personnel at least once every 12 months. Qualified personnel include the master or owner/operator of the vessel, if appropriately trained, or appropriately trained marine or environmental engineers or technicians or an appropriately trained representative of a vessel's class society acting on behalf of the owner/operator.

Comprehensive annual inspections must cover all areas of the vessel affected by the requirements in the VGP that can be inspected without forcing a vessel into drydock. Special attention should be paid to those areas most likely to result in a discharge likely to cause or contribute to exceedances of water quality standards or violate effluent limits established in the VGP. Areas that inspectors must examine include, but are not limited to:

- Vessel hull for attached living organisms, flaking antifoulant paint, exposed TBT or other organotin surfaces.
- Ballast water tanks, as applicable.
- Bilges, pumps, and oily water separator sensors, as applicable.
- Protective seals for lubrication and hydraulic oil leaks.
- Oil and chemical storage areas, cargo areas, and waste storage areas.
- All visible pollution control measures to ensure that they are functioning properly.

If any of these portions of the vessel are not inspectable without the vessel entering drydock, the vessel owner/operator must inspect these areas during their drydock inspection and their results must be documented in their drydock inspection reports. Furthermore, vessel owner/operators must document which portions of the vessel are not inspectable for the annual inspection in their recordkeeping documentation.

The annual inspections must also include a review of monitoring data collected in accordance with Part 5 of the VGP if applicable, and routine maintenance records to ensure that required maintenance is being performed (e.g., annual tune-ups for small boats that have wet exhaust). Inspectors must also consider the results of the past year's visual and analytical monitoring when planning and conducting inspections.

When comprehensive vessel inspection schedules overlap with routine vessel inspections required under Part 4.1.1 of the VGP, the annual comprehensive vessel inspection may also be used as one of the routine inspections, as long as components of both types of inspections are included.

If inspections revealed flaws that would result in a violation of the effluent limits in Parts 2 and 5 of the VGP, or that indicated that control measures are not functioning as anticipated or are in need of repair or upgrade, corrective action must be taken to resolve such flaws in accordance with Part 3 of the VGP. All results from the annual inspection must be recorded in the vessel's recordkeeping documentation or logbook.

Drydock Inspection Reports

Vessel owner/operators must make any drydock reports prepared by the class society or their flag administrations available to EPA or an authorized representative of EPA upon request. If drydock reports are not available from either of these entities, vessels must prepare their own drydock report and it must be made available to EPA or an authorized representative of EPA upon request. The drydock report must note that:

- The chain locker has been cleaned for both sediment and living organisms.
- The vessel hull, propeller, rudder, thruster gratings, sea chest, and other surface areas of the vessel have been inspected for attached living organisms and those organisms have been removed or neutralized.
- Any antifouling hull coatings have been applied, maintained and removed consistent with the FIFRA label if applicable; any exposed existing or any new coating does not contain biocides or toxics that are banned for use in the United States.
- All cathodic protection, anodes or dialectic coatings have been cleaned and/or replaced to reduce flaking.
- All pollution control equipment is properly functioning.

PERMIT RECORDKEEPING

All vessels covered by the VGP permit must keep written records on the vessel or accompanying tug that include the following information:

- Owner/vessel information:
 - Name.
 - International Maritime Organization (IMO) number (official number if IMO number not issued).
 - Vessel type.
 - Owner or operator company name.
 - Owner or operator certifying official's name.
 - Address of owner/operator.
 - Gross tonnage.
 - Call sign.
 - Port of registry (flag).

- Voyage Log. Include the dates and ports of arrival, vessel agent(s), last port and country of call, and next port and country of call (when known).
- Documentation and records of any and all violations of the effluent limit including:
 - A description of the violation.
 - Date of the violation.
 - Name, title and signature of the person who identified the violation.
 - Name, title and signature of the person who is recording the violation (if different from the person who identified the violation).
 - If a Corrective Action Assessment pursuant to Part 3.2 of the VGP is needed, attach a copy or indicate where the corrective action assessment is stored.
 - If a Corrective Action Assessment was previously conducted pursuant to Part 3.2 of the VGP (and revisions are not needed for this violation of the effluent limit), a reference to that previous corrective action assessment.
- Log of deficiencies and problems found during routine inspections, including a discussion of any corrective actions required by Part 3 of the VGP if applicable. Include date, inspector's name, findings, and corrective actions planned or taken. If no deficiencies or problems are found during a routine inspection, record that the inspection was completed with the inspector's name and date. Routine visual inspections must be recorded as completed according to Part 4.1.1 of the VGP.
- Log of findings from drydock inspections conducted under Part 4.1.4 including a discussion of any corrective actions planned or taken as required by Part 3 of the VGP. Include date, inspector's name, findings, and a description of the corrective actions taken.
- Analytical results of all monitoring conducted under Part 4.1.2 of the VGP, including sample documentation, results, and laboratory QA documentation.
- Log of findings from annual inspections conducted under Part 4.1.3 of the VGP, including a discussion of any corrective actions planned or taken required by Part 3 of the VGP. Include date, inspector's name, findings, and corrective actions taken.
- Record of any specific requirements in Part 2.3 of the VGP given to the vessel by EPA, or clearly posted by state agencies and how the vessel has met those requirements.
- Additional maintenance and discharge information to be recorded and kept in a log on the vessel:
 - Deck maintenance. Record dates, materials used, application process, etc. for any significant maintenance of the deck surface(s) (e.g., more than routine, daily cleaning activities, such as sweeping).
 - Bilgewater. Record dates, location, oil concentration (for MARPOL vessels) or visible sheen observation (non-MARPOL vessels), and estimated volume of bilgewater

discharges. Record the same information for bilgewater disposed at onshore locations.

- Paint application. Record dates, materials used, application process, etc. for any antifouling paint applied to the vessel.
- AFFF. Record dates, estimated volumes, and constituents of any discharges of AFFF.
- Chain locker inspections. Dates of inspections and any rinsing conducted within waters subject to the VGP.
- Controllable pitch propeller, stern tube, and other oil-to-sea interface maintenance. Record dates and locations of any maintenance of controllable pitch propellers that occurs while the vessel is in waters subject to the VGP.
- Any emergencies requiring discharges otherwise prohibited to federally protected waters.
- Gas Turbine Water Wash. Record date and estimated volume of any discharge of gas turbine wash water within waters subject to the VGP. If hauled or disposed onshore, record log hauler and volume.
- Estimated volume and location of graywater discharged while in waters subject to the VGP.
- All other documentation requirements stated in the VGP.
- Record of training completed as required by the VGP.

For purposes of the VGP, records may be kept electronically if the records are:

- In a format that can be read in a similar manner as a paper record.
- Legally dependable with no less evidentiary value than their paper equivalent.
- Accessible to the inspector during an inspection to the same extent as a paper copy stored on the vessel would be, if the records were stored in paper form.

ADDITIONAL RECORDKEEPING FOR VESSELS EQUIPPED WITH BALLAST TANKS

Except for vessels operating exclusively within one Captain of the Port Zone (COTP zone), vessels equipped with ballast tanks that are bound for a port or place in the United States must meet the recordkeeping requirements of 33 CFR Part 151.

The master, owner, operator, or person in charge of a vessel bound for a port or place in the United States must keep written records that include the following information:

- Total ballast water information. Include the total ballast water capacity, total volume of ballast water on board, total number of ballast water tanks, and total number of ballast water tanks in ballast. Use units of measurement such as metric tons (MT), cubic meters (m³), long tons (LT), and short tons (ST).
- Ballast water management. Include the total number of ballast tanks/holds that are to be discharged into the waters of the United States or to a reception facility. If an alternative ballast water management method is used, note the number of tanks that

were managed using an alternative method, as well as the type of method used. Indicate whether the vessel has a ballast water management plan and IMO guidelines on board, and whether the ballast water management plan is used.

- Information on ballast water tanks that are to be discharged into waters subject to the VGP or to a reception facility. Include the following:
 - The origin of ballast water. This includes date(s); location(s), including latitude and longitude and port (if relevant); volume(s); and temperature(s). If a tank has been exchanged, list the loading port of the ballast water that was discharged during the exchange.
 - The date(s), location(s) (including latitude and longitude), volume(s), method, thoroughness (percentage exchanged if exchange conducted), sea height at time of exchange if exchange conducted, of any ballast water exchanged or otherwise managed.
 - The expected date, location, volume, and salinity of any ballast water to be discharged into waters of the United States or a reception facility.
- Discharge of sediment. If sediment is to be discharged into a facility within the jurisdiction of the United States include the location of the facility where the disposal will take place.

The ballast water reporting forms must be kept on board the vessel and must be submitted to the National Ballast Information Clearinghouse before arriving to US ports if required by the US Coast Guard. In addition, all vessels which conduct saltwater flushing as required by Part 2.2.3.7 and Part 2.2.3.8 of the VGP, but do not report saltwater flushing to the NBIC, must instead keep a record of saltwater flushing to meet the requirements of the permit.

PERMIT REPORTING

Annual Reports

For each vessel, owners/operators are required to submit an Annual Report for each year that they have active permit coverage. For vessels that must file NOIs, this means for as long as they have an active NOI. For vessels that need not file an NOI, they maintain active coverage as long as they are operating in waters subject to the VGP, provided they have signed and maintain a copy of the PARI form. Annual Reports must be completed each calendar year and submitted by February 28 of the following year (e.g., the 2014 annual report is due by February 28, 2015).

All analytical monitoring results must be submitted to EPA as part of the Annual Report.

The vessel owner/operator shall complete the Annual Report form provided in Appendix H of the permit and submit it to EPA electronically. It can be completed online by accessing EPA's main NPDES vessel webpage (available at <https://www.epa.gov/npdes/vessels-vgp> or through EPA's eNOI system <https://ofmpub.epa.gov/apex/vgpenoi/f?p=102:101>).

The vessel owner/operator shall respond to all questions accurately and completely, and provide the necessary information and/or data to support each response. Unless one of the

exceptions in Part 1.14 of the VGP is met, the vessel owner/operator must submit each Annual Report electronically in accordance with the procedures described in Part 1.14 of the VGP.

If the operator/owner is required to submit a hard copy of the Annual Report, they must send the completed annual report to EPA HQ (Attn: Vessel Annual Report, Mail Code 4203M, 1200 Pennsylvania Ave. NW, Washington, DC 20460). Hard copy reports must be postmarked by February 21 of the following calendar year (i.e., the 2014 annual report must be postmarked by February 21, 2015).

The Annual Report replaces the annual noncompliance report and one-time report requirements found in the 2008 VGP. All instances of noncompliance must be reported as part of the Annual Report.

Combined Annual Reports for Unmanned, Unpowered Barges or Vessels less than 300 Gross Tons

Operators of unmanned, unpowered barges or other vessels less than 300 gross tons (e.g., small tug boats) may submit a single annual report (referred to as the Combined Annual Report) for multiple vessels and/or barges if all of the following conditions are met:

- The answers for each barge or vessel for which the report is to be submitted are the same.
- Each barge or vessel was not required to conduct any analytical monitoring.
- The Combined Annual Report is submitted electronically.
- There were no instances of noncompliance for any barge or vessel and no instances of identified deficiencies by EPA or its authorized representatives during any inspections during the previous 12 months.
- Each barge or vessel has an NOI permit number or, if not required to submit an NOI, a commonly used unique identifier (e.g., registration number) so EPA can identify the vessel. For vessels less than 300 gross tons that have not submitted an NOI, the unique identifier numbers must be entered on the combined annual report.

Vessel owners/operators of unmanned, unpowered barges or vessels less than 300 gross tons may submit a Combined Annual Report for some or most of their fleet, or submit individual Annual Reports if they prefer. Individual Annual Reports are required for any barges or other vessels that are not eligible for the Combined Annual Report, as specified above.

Reporting Quantities of Hazardous Substances or Oil

Although not a requirement of the VGP, if a discharge contains a hazardous substance or oil in an amount equal to or more than a reportable quantity established under 40 CFR Part 110, 40 CFR Part 117, or 40 CFR Part 302, during a 24-hour period, the National Response Center (NRC) must be notified (dial 800-424-8802 or 202-426-2675 in the Washington, DC area). Also, within 14 calendar days of knowledge of the release, the date and description of the release, the circumstances leading to the release, responses to be employed for such releases, and measures to prevent reoccurrence of such releases must be recorded in recordkeeping documentation consistent with Part 4.2 of the VGP.

Where a discharge of hazardous substances or oil exceeding reportable quantities occurs, such discharge is not authorized by the VGP and may also be a violation of section 311 of the CWA. Note that these spills must be reported as described above. Also applicable are section 311 of the CWA and certain provisions of sections 301 and 402 of the CWA.

Additional Reporting

Vessels are also subject to the standard permit reporting provisions referenced in Part 1.13 of the VGP (standard permit reporting provisions published at 40 CFR 122.41).

Where applicable, vessels must submit the following reports to the appropriate EPA Regional Office listed in Part 8 of the VGP as applicable:

- 24-hour reporting. Report any noncompliance that may endanger health or the environment. Any information must be provided orally within 24 hours from the time the vessel owners/operators becomes aware of the circumstances.
- 5-day follow-up reporting to the 24-hour reporting. A written submission must also be provided within five days of the time the vessel owner/operator becomes aware of the circumstances.

If the operator/owner reports to the NRC as referenced in Part 4.4.3 of the permit, they do not need to complete reporting under this part.

VESSEL INSPECTION OVERVIEW

Purpose of VGP Inspections

On February 11, 2011, EPA and the US Coast Guard (USCG) signed a Memorandum of Understanding (MOU) to establish cooperation and coordination in implementing and enforcing the national VGP. Under the MOU, USCG has agreed to incorporate components of EPA's VGP program into its existing inspection protocols and procedures to help the United States address vessel pollution in U.S. waters. The MOU creates a framework for improving EPA and USCG cooperation on data tracking, training, monitoring, enforcement and industry outreach. The agencies have also agreed to improve existing data requirements so that information on potential violations observed during inspections can be sent to EPA for evaluation and follow-up.

Although the USCG will conduct most inspections, there are some universes of vessels for which they do not have jurisdiction. EPA and/or states that are authorized to enforce the VGP will need to conduct inspections to take enforcement actions against such vessels.

EPA Authority for VGP Inspections

EPA has the authority to regulate and inspect vessels through statutory requirements established in the CWA:

- EPA's long-standing exclusion of discharges incidental to the normal operation of vessels from the NPDES program at 40 CFR 122.3(a) was vacated as of September 30, 2008,

making these discharges subject to CWA section 301 regulation's prohibition against discharges unless covered under an NPDES permit.

- The regulations at 40 CFR 122.28 establish procedures for issuing a general permit to cover categories of point sources having common elements, such as facilities that involve the same or substantially similar types of operations, that discharge the same types of wastes, or that are more appropriately regulated by general permit. 40 CFR 123.25 provides State Programs the legal authority to implement and administer general permits issued under 40 CFR 122.28.
- CWA section 402 states that permittees issued permits for point source discharges of pollutants must meet specific discharge limits and operating conditions.
- CWA section 308 authorizes inspections and monitoring to determine whether NPDES permit conditions are being met.
- Under the CWA, EPA may conduct an inspection wherever there is an existing NPDES permit, where a discharge exists or might exist, and where no permit has been issued. The CWA established enforcement authorities. EPA retains independent authority to take enforcement actions in both authorized and unauthorized states.
- CWA section 309(a) allows EPA to administer administrative compliance orders for persons violating the CWA and to set a reasonable schedule for compliance (violation notice).
- CWA section 309(b), section 309(d), and section 404 provide for injunctive relief and civil penalties of up to \$25,000 per day for each violation of the act.
- CWA section 309(c)(4) provides that falsifying, tampering with, or knowingly rendering inaccurate any monitoring device or method required to be maintained is punishable by a fine of not more than \$10,000, or by imprisonment for not more than 2 years, or both.
- CWA section 309(c) provides for criminal penalties of a fine of \$2,500 to \$25,000 per day, or up to 1 year of imprisonment, or both, for negligent violations of the act (for subsequent convictions, fines of up to \$50,000 per day or 2 years of imprisonment, or both, may be called for).
- CWA section 309(g) allows EPA to assess administrative penalties of two classes.
- Administrative actions may preclude other civil action penalties or citizen suits.
 - Class I, with an informal hearing process, can carry penalties of up to \$25,000.
 - Class II involves formal administrative procedure hearings with penalties of up to \$125,000.

VGP INSPECTION PROCEDURES

Pre-Inspection Activities

The primary role of the inspector is to gather information that can be used to evaluate compliance with permit conditions, applicable regulations, and other requirements. Inspectors should be familiar with the conditions of the specific permit and with all applicable statutes and

regulations. Prior to conducting a VGP inspection, the inspector should complete the following pre-inspection preparation activities listed below. Careful and thorough preparation is critical for conducting a professional and efficient inspection.

- Become familiar with the vessel and the types of discharges associated with the vessel type. Review the “Vessel Discharge Description” subsection below for summary information.
- Review the conditions of the permit.
- Collect as much paperwork as possible regarding the vessel before conducting the inspection (e.g., ballast management plan, discharge paperwork, prior inspection reports). EPA has posted on its website all vessel NOIs submitted by vessel owners. You can use this public EPA webpage to search, sort, and view these NOIs: <https://ofmpub.epa.gov/apex/vgpenoi/f?p=vgp:Search>. Search results reflect real time data. (Note, however, that only vessels greater than or equal to 300 gross tons, or vessels with the capacity to hold or discharge more than 8 cubic meters (2,113 gallons) of ballast water, are required to submit a NOI.) Annual Reports, including any applicable monitoring results submitted as part of a vessel’s reporting requirements, will be publicly available on EPA’s webpage at <https://ofmpub.epa.gov/apex/vgpenoi/f?p=vgp:Search>. The first reports for the 2013 VGP were due to EPA by February 28, 2015. In addition, the One-time reports, submitted as part of the 2008 VGP, are searchable via EPA’s VGP webpage at https://ofmpub.epa.gov/apex/aps/f?p=VOTR_2008:HOME:.....
- To facilitate the VGP inspection process, prepare your inspection procedure in written form and make a form or a checklist for use in documenting the inspection. See the Coast Guard CG-543 Policy Letter 11-01 or numerous trade association checklists for examples of these tools.
- If possible, conduct one or more joint inspections with the USCG to obtain on-the-job training, especially for inspecting deep draft vessels. Inspectors should be familiar with CG-840 inspection books used by the USCG for vessel inspections.

On-site Activities

To conduct the inspection, the inspector should use a notebook for field notes, personal protection equipment (PPE), and a camera to take photographs. Before boarding the vessel, conduct the following visual inspection activities:

- Observe the water line and waters surrounding the vessel for:
 - Traces of oil or an oily sheen, especially the areas of the vessel stern (where the screw and stern tube would be located), locations of thrusters, and other areas of expected oil to sea interfaces.
 - Look for fish kills and any other signs of pollution.
 - Excessive hull fouling.

- Check for evidence of use of prohibited antifoulant coatings containing TBT, and check the condition of any TBT overcoating.

After completing the preliminary visual inspection, board the vessel via the gangway and meet the vessel's Watch Officer. Introduce yourself and ask to meet with the Chief Engineer.²⁰ Inspectors should use a respectful tone when speaking with vessel personnel, as they are, at a minimum, representing the EPA when boarding a U.S. flagged vessel, and, at a maximum, representing the United States when boarding a foreign-flagged vessel.

Vessel security is an important consideration; therefore, inspectors lacking military or other authorized identification should anticipate resistance, and possibly lengthy delays, prior to boarding. Inspectors lacking a Transportation Work Identification Credential (TWIC) may require an escort at all times. Additional authorization may be required to take photos. Foreign-flagged vessels may request that a representative from their class society or other agent be present for the inspection.

After boarding the vessel, you will likely be escorted to a conference room or Captain's quarters. The typical inspection sequence includes:

- Entry interview
- Record and document review
- Visual inspection
- Exit interview
- Inspection report

Entry Interview

The inspector should request the presence of the Chief Engineer as well as the Master to conduct the entry interview. During the entry interview the inspector should:

- Present credentials authorizing the inspection.
- Seek consent for an on-site inspection.
- Inform the vessel owner or operator of the scope and purpose of the inspection.
- Reference the VGP and VGP Fact Sheet concerning the regulation of vessel discharges, and have access to these resources during the inspection, if possible.
- Confirm basic information about the vessel collected during pre-inspection activities:
 - If applicable, verify permit number, vessel owner/operator name, operator IMO number, and vessel information such as vessel name, IMO number, call sign, flag state, vessel type, vessel dimensions, ballast water capacity, etc.
 - Identify the authorized representative of the vessel.

²⁰ Vessels such as large cruise ships may also have an Environmental Officer, while barges may be manned by only a Tanker Man; therefore, avoid boarding during cargo transfer.

- Identify applicable vessel discharges and ask questions regarding discharge-specific permit requirements. For example, ask the Master and Chief Engineer about the following discharges:
 - AFFF.
 - Bilgewater (e.g., How is bilgewater managed? Are bilgewater discharges documented in the oil record logbook?).
 - Ballast water (e.g., How is ballast water managed, where is it discharged?).
 - Graywater (e.g., How is graywater managed while the vessel is pier-side? Is it discharged pier-side? How is graywater minimized while operating in waters subject to the permit?).
- Request copies of specific records that might be required by the permit.
- Ask questions concerning the history of the vessel, including any discharge violations that have occurred.
- Determine vessel conditions as they exist at the time of the inspection.
- If desired, inform the operator what information, if any, will be available after the inspection.

Record and Document Review

The inspector should also ask to see the records required to be kept by the vessel's permit, management plans, and records documenting vessel compliance with the terms and conditions of its permit. Records must be kept onboard or electronically (see EPA's FAQ at <https://www.epa.gov/npdes/vessels-frequent-questions>). Records from the last 3 years are required to be onboard the vessel. The inspector may ask for certification of the accuracy of the data contained in these records. Typical records that the inspector may ask the facility to produce include:

- VGP compliance binder (if available)
- NOI (if applicable)
- One-time report (if applicable)
- Comprehensive annual vessel inspection report (if applicable)
- Drydock inspection report (if applicable)
- Analytical monitoring results (if applicable)
- Voyage log
- Oil record logbook
- Ballast water management plan
- Maintenance and discharge information paperwork
- Emergency discharge logs and associated corrective action forms
- Routine and quarterly inspection logs (or self-inspection forms)
- Annual inspection report

As needed, the inspector should request photocopies of documents that will assist in preparing the inspection report.

Visual Inspection

After reviewing the records and documents, the inspector should ask for an escort to accompany him or her on a tour of the vessel. The purpose of the vessel tour is to assess existing conditions and confirm that the vessel conforms to the description of the permit. During this phase of the inspection, the inspector will want to observe the following portions of the vessel:

- **Deck**. While on deck, ask questions such as what is done with chain locker sediment, and when chain locker cleaning is performed. Visually inspect the deck for cleanliness and for the presence of cargos or materials that might wash overboard, dissolve with precipitation or surface water spray, or blow overboard. Observe the condition of the topside surface and above water line hull (presence of rust, paint chips, etc.). Visually inspect the presence and cleanliness of deck machinery coamings or drip pans to collect any oily water and to prevent spills. Ask questions regarding good housekeeping practices for the deck and above water line hull.
- **Engine room**. Inspect the cleanliness of the bilge and observe the presence of visibly oily bilgewater. Ask questions regarding the bilge good housekeeping practices and about the management and discharge of bilgewater. Observe any evidence of use of dispersants, detergents, or other materials to remove the appearance of visible sheen in bilgewater.
- **Galley and scullery**. While in the galley, ask the chief cook questions such as what is done with used/excess cooking oil, and operation of the garbage grinder or food pulping system. Ask about use of soaps and detergents and consider requesting their Material Safety Data Sheets (MSDS).
- **Toxic and hazardous material storage areas**. Inspect areas such as paint storage area(s), laundry room(s), cleaning supply storage area(s), photography room(s), etc. to ensure materials are appropriately stored, labeled and secured. Consider requesting MSDSs for any soaps and detergents.

To document observations or areas of potential concern during the inspection, the inspector should take photographs. If the vessel is discharging during the inspection, the inspector might also consider collecting samples of the discharge.²¹ During the visual inspection, the inspector might determine that additional records or documents are needed for review. The inspector should ask the Master or Chief Engineer for these additional records as soon as they are identified to facilitate retrieval of the needed information.

²¹ Samples should only be collected if appropriate sampling equipment (e.g., sample bottles, gloves, labels, custody records, etc.) brought aboard by the inspector are appropriate for the specific discharge.

Note that there are areas of vessels that environmental inspectors should not enter for reasons of safety (e.g., cargo pump control room). See Section D, “

Safety,” below.

Exit Interview

Following the visual inspection, the inspector conducts a debriefing or exit interview with the Master or Chief Engineer. This phase of the inspection allows both parties to clarify issues that arose during the inspection. If any records or documents were obtained during the inspection, the inspector prepares a Receipt for Documents and Samples. The inspector also gives the vessel operator/owner the opportunity to claim that some or all the information provided during the inspection is confidential business information (CBI).

The inspector may relay basic observations or areas of concern of the inspection. The inspector does not make the determinations of compliance or noncompliance of the vessel during the inspection; that determination is made when the inspection report is prepared using information obtained during the inspection.

Inspection Report

The inspection report includes the inspection checklist (if used), documentation copied during the inspection, an explanation of findings, and supporting photographs. In some cases, the inspector might need to contact the vessel if additional information is needed or issues require clarification.

Compliance personnel for the regulatory authority review the inspection report and evaluate whether the vessel is in noncompliance. They will determine what type of follow-up action, if any, is appropriate. Copies of the report are sent to the inspected vessel. EPA responds to noncompliance in several different ways, depending on the nature and circumstances of the violation:

- No follow-up needed
- Letter notifying the facility of violations or compliance assistance
- Administrative compliance order
- Administrative compliance order plus administrative penalty
- Civil judicial enforcement action (penalties and/or injunctive relief)
- Criminal enforcement

Vessel Discharge Description

The inspector should understand the types of discharges expected on different vessel types before conducting an inspection. See Table 16-1 for descriptions of the various discharges and the vessel types likely to discharge them. Refer to Section 3.5.1 of the VGP Fact Sheet for more detailed descriptions of the vessel discharges.

Table 16-1. Vessel Discharge Descriptions

Vessel Discharge	Description
Anti-Fouling Hull Coatings	Anti-fouling coatings are applied to the vessel hull and sea water piping systems to limit attachment of aquatic species. Virtually all vessels that are permanently kept in saltwater use antifouling coatings. Biocides such as copper contained in anti-fouling coatings continuously leach into surrounding waters.
Aqueous Film Forming Foam (AFFF)	Firefighting agent added to fire suppression systems on some vessels to create foam. Used infrequently (annually or semi-annually) to test equipment for maintenance, certification, or training. Constituents include fluorosurfactants and/or fluoroproteins.
Ballast Water	Ballast water is water taken onboard in large volumes on large numbers of commercial vessels to assist with vessel draft, buoyancy, and stability. Ballast capacities vary by vessel type, for example more than 20 million gallons for container ships. Ballast water is a known transport vector for aquatic nuisance species and can also contain metals and suspended solids.
Bilgewater	Bilgewater is generated by all vessels and consists of water and other residue that accumulates in a compartment of the vessel's hull. The source of bilgewater is typically drainage from interior machinery, engine rooms, and from deck drainage. Bilgewater typically contains seawater, oil, grease, nutrients, volatile and semi-volatile organic compounds, inorganic salts, and metals.
Boat Engine Wet Exhaust	Engine wet exhaust effluent is generated when engine cooling water (both propulsion engines and generators) is injected into the engine exhaust. The engine cooling water decreases the exhaust temperature, reduces engine noise and reduces exhaust emissions. Engine wet exhaust discharge rates can range from 5 to 10 gallons per minute to more than 100 gallons per minute on larger diesel engines operating at high inputs. Large commercial vessels occasionally operate small auxiliary craft that discharge engine wet exhaust (e.g., life boats on cruise ships); however, discharge volumes for these vessels are negligible as they are typically seldom used. Pollutants in the engine wet exhaust can include oil and grease, metals, volatile organic compounds and semivolatile organic compounds.
Boiler/Economizer Blowdown	Boiler blowdown occurs on vessels with steam propulsion or a steam generator and is used to control the concentration of scaling constituents in boiler systems. Boiler blowdown are infrequent, of short duration (seconds), in small volumes, and at high pressure. The blowdown can contain water and steam or sludge-bearing water at elevated temperatures (above 325°F). The discharge can contain metals or boiler water treatment chemicals.
Cathodic Protection	Nearly all vessels having steel hulls or metal hull appendages use cathodic protection systems to prevent corrosion. Based on underwater hull inspections and maintenance records, one-half of an anode is consumed after three years. The primary pollutant released from cathodic protection is zinc. Average pier-side and underway zinc generation rates are 1.3×10^{-6} and 5.1×10^{-6} (lb. zinc/square foot of underwater surface area)/hr., respectively.

Table 16-1. Vessel Discharge Descriptions

Vessel Discharge	Description
Chain Locker Effluent	Chain locker effluent is water that drips from the anchor chain and anchor during anchor retrieval. Discharge volumes are small and chain locker effluent is expected to contain sediment, some marine organisms, zinc, rust, paint, grease, and any constituents from the fire main water. The small volume of chain locker effluent results in small mass loadings and provides little opportunity for the transfer of non-indigenous species.
Deck Washdown and Runoff and Above the Water Line Hull Cleaning ^a	Deck washdown and runoff occurs from all vessels as a result of deck cleaning and precipitation. Constituents in the discharge can include detergent, soap, deck surface components (e.g., rust, paint chips) and anything dropped, spilled, dripped, or scattered onto the deck surface.
Distillation and Reverse Osmosis Brine	Discharges of brine can occur on vessels that do not bunker potable water but instead use onboard plants to distill seawater or desalinate seawater using reverse osmosis (RO) to generate fresh water. Distillation units generate brine at a rate of 17 gallons of brine for every gallon of fresh water produced. RO units generate approximately 4 gallons of brine for every gallon of fresh water produced. The three sources of the constituents of water purification plant discharge are: 1) influent seawater; 2) anti-scaling treatment chemicals; and 3) the purification plant components, including heat exchangers, casings, pumps, piping and fittings. The primary constituents of the brine discharge are identical to those in seawater; however, they are more concentrated due to volume reduction.
Elevator Pit Effluent	Large vessels with multiple decks are equipped with elevators to facilitate the transportation of maintenance equipment, people, and cargo between decks. A pit at the bottom of the elevator shaft collects small amounts of liquids and debris from elevator operations and deck washdown and runoff depending on the elevator configuration. Water entering the elevator pit can contain materials that were on the deck, including fuel, hydraulic fluid, lubricating oil, residual water, and AFFF. The runoff may also include lubricant applied to the elevator doors, door tracks, and other moving elevator parts. Residue in the elevator car from the transport of materials may also be washed into the elevator pit. The cleaning solvent used during maintenance cleaning operations as well as liquid wastes generated by the cleaning process drain into the elevator pit sump.
Exhaust Gas Scrubber Washwater Discharge	Exhaust gas scrubber washwater discharge occurs as a result of cleaning the exhaust gas system on marine diesel engines. The washwater discharge can be highly acidic, and can also contain traces of oil, polycyclic aromatic hydrocarbons (PAHs), heavy metals and nitrogen. Washwater volumes of 2.8 million gallons per day are estimated from a 10 MWh engine.
Fire main Systems	Fire main systems are found on many vessels and draw in water through the sea chest to supply water for fire hose stations and sprinkler systems. Systems are activated during testing or during an actual fire. Small amounts of metals may be added to the fire water from the vessel piping system.

Table 16-1. Vessel Discharge Descriptions

Vessel Discharge	Description
Freshwater Layup	Freshwater layup is generated when a vessel is pier side or in port for more than a few days, the main steam plant is shut down, and the condensers do not circulate. A freshwater layup includes replacing the seawater in the system with potable or surrounding freshwater (e.g., lake water). Freshwater layup discharges can be as large as 6,000 gallons per evolution and can contain residual saltwater, freshwater, tap water, and possibly metals leached from the pipes or machinery.
Gas Turbine Wash Water	Gas turbines are used for propulsion and electricity generation on some vessels. Occasionally, they must be cleaned to remove byproducts that can accumulate and affect their operation. Large naval vessels can generate up to 244 gallons of washwater per day. Wash water can include salts, lubricants, and combustion residuals.
Graywater and Graywater Mixed with Sewage	Nearly all commercial vessels generate some form of graywater. Graywater is water from showers, baths, sinks, galleys, and laundry facilities. Graywater volumes vary depending on the number of passengers on board and can range from a few gallons per day on tug boats to tens of thousands of gallons per day on large cruise ships. Graywater can contain high levels of pathogens, nutrients, soaps and detergents, and organics.
Graywater Mixed with Sewage	
Motor Gasoline and Compensating Discharge	Motor gasoline is transported on vessels to operate vehicles and other machinery. As the fuel is used, ambient water is added to the fuel tanks to replace the weight. This ambient water is discharged when the vessel refills the tanks with gasoline or when performing maintenance. Most vessels are designed not to have motor gasoline and compensating discharge. The volume of the compensating discharge is expected to range from less than 50 gallons to up a few hundred gallons. The discharge can contain small amounts of fuel and other fuel-related pollutants.
Non-oily Machinery Wastewater	Some larger vessels are expected to have some non-oily machinery discharges, such as distilling plants start-up discharge, chilled water condensate drains, fresh- and saltwater pump drains, and potable water tank overflows. These flows are generally low in volume and are not expected to contain significant amounts of pollutants.
Refrigeration and Air Condensate Discharge	Condensation from cold refrigeration or evaporator coils of air conditioning systems drips from the coils and collects in drip troughs which typically empty to a drainage system. Large numbers of vessels are equipped with refrigeration systems to keep food and other perishable items from spoiling. Air conditioning systems are also found on many vessels for passenger and crew comfort. Condensates may contain very small amounts of pollutants such as metals derived from vessel piping systems.
Seawater Cooling Overboard Discharge ^b	Seawater cooling systems use ambient water to absorb the heat from heat exchangers, propulsion systems, and mechanical auxiliary systems. The water is typically circulated through an enclosed system that does not come in direct contact with machinery, but still may contain sediment from water intake, traces of hydraulic or lubricating oils, and trace metals leached or eroded from the pipes within the system. Additionally, because it is used for cooling, the effluent will have an increased temperature.

Table 16-1. Vessel Discharge Descriptions

Vessel Discharge	Description
Seawater Piping Biofouling Prevention ^c	Some vessels that use seawater cooling systems introduce anti-fouling compounds (e.g., sodium hypochlorite) in their interior piping and component surfaces to inhibit the growth of fouling organisms. These anti-fouling compounds are then typically discharged overboard. Most vessels that have seawater piping systems are expected to use piping materials such as copper to prevent biofouling rather than injecting high concentrations of anti-fouling compounds into their piping systems.
Sonar Dome Discharge	Water is used to maintain the shape and pressure of domes that house sonar detection, navigation, and ranging equipment on large vessels. Discharges occasionally occur when the water must be drained for maintenance or repair or from the exterior of the sonar dome. Sonar dome discharge volumes on Naval vessels can range from 300 gallons per event up to 74,000 gallons per event. Pollutant levels are expected to be low due to the ban on the use of tributyltin.
Stern Tube Packing Gland Effluent and Other Oil to Sea Interfaces	Nearly all commercial vessels with in-board engines have stern tube packing gland surrounding the propeller shaft. The stern tube packing gland is designed to leak a few drops per minute of ambient water (4 to 8 gallons per day) to cool the gland when the vessel is underway. Pollutants in the stern tube packing gland effluent include metals, oil and grease, suspended solids, organics, and phthalates. Oil to sea interfaces include any mechanical or other equipment where seals or surfaces may release small quantities of oil and grease into the sea. Examples include controllable pitch propellers, rudder bearings and wire ropes and cables that have lubricated (greased) surfaces that are submerged in seawater during use.
Underwater Ship Husbandry Discharges	Underwater ship husbandry is grooming, maintenance, and repair activities of hulls or hull appendages performed while the vessel is in the water. Underwater ship husbandry discharges can contain aquatic organisms and residue such as rust and biocide from anti-fouling coating. Underwater ship husbandry is typically performed only when excessive biological growth is causing vessel drag and excessive fuel consumption outside of regular dry dock inspections.
Welldeck Discharges	The welldeck is a floodable platform used for launching or loading small satellite vessels, vehicles, and cargo from select vessels. Welldeck discharges may include water from precipitation, welldeck and storage area washdowns, equipment and engine washdowns, and leaks and spills from stored machinery. Potential constituents of welldeck discharges include fresh water, distilled water, fire main water, graywater, air-conditioning condensate, sea-salt residues, paint chips, wood splinters, dirt, sand, organic debris and marine organisms, oil, grease, fuel, detergents, combustion byproducts, and lumber treatment chemicals.

^a Wet-type fire main systems are commonly used to provide a water source for deck washing.

^b Discharge is for non-contact cooling only and does not include engine wet exhaust.

^c Discharge does not include anti-fouling coatings used to inhibit biogrowth; such discharges are considered anti-fouling leachate.

D. SAFETY HAZARDS

EXPECTED HAZARDS

The following sections list hazards inspectors can expect to encounter during vessel inspections. The hazards fall into the following categories: physical, thermal, chemical and biological.

PHYSICAL HAZARDS

Inspectors should be aware of and alert for all physical hazards. The use of narrow walkways or steep stairs may be necessary to access certain areas. Inspectors should keep one hand free to hold the railing when using narrow stairways.

Inspectors should also be aware of working surface hazards, which may include slippery piers and decks, low doorways, and trip hazards associated with steep narrow stairwells used to enter and exit certain vessel areas. Inspectors should avoid boarding barges or tankers during loading operations, as these operations may be dangerous. Inspectors must be familiar with the location of floatable life rings and other flotation devices.

Noise will be a hazard on certain areas of the ship (e.g., the engine room). Hearing protection should be used by inspectors where required by the ship, when crew members are having trouble hearing or being heard when standing 3 feet or less away from another person.

Extreme caution is required to access certain vessels, particularly barges and tugboats. These vessels may have narrow and dangerous gangways, or may require crossing multiple vessels tied abreast at the pier by climbing over tires used as dock and vessel fenders.

THERMAL HAZARDS

The potential to encounter thermal hazards during inspections are significant as wastewater from dishwashers and laundry is typically between 160°F to 180°F. Also, graywater pipes may become heated when they run next to steam pipes. Inspectors must be aware of potential thermal hazards from indirect contact caused by exposure due to proximity to a ship's equipment (e.g., steam pipes, steam traps). Inspectors should note thermal hazard warning signs from the ship's crew.

Inspectors may be exposed to hot environments for extended periods of time. Appropriate clothing (i.e., clothing allowing free movement of cool dry air over skin) should be worn so as to minimize the heat stress. Inspectors should be aware of abatement procedures for dealing with a heat related illness.

CHEMICAL HAZARDS

MSDSs for each hazardous chemical used or stored onboard should be available for review during an inspection.

Certain areas of the ship may have noxious fumes, such as paint storage and chemical storage areas, or unsafe environments, such as the rope storage and chain lockers. Allow these areas to

air out before entering during an inspection. A gas meter may be required to assure a safe environment for entry.

The inspector should not go into the cargo pump control room during an inspection for safety reasons.

BIOLOGICAL HAZARDS

Graywater mixed with sewage may potentially contain blood or other potentially infectious material defined under OSHA's blood born pathogen regulations (29 CFR 1910.1030). Typically, blood will not be present in domestic sewage unless it comes directly from the infirmary area of the ship. OSHA recognizes that contact with raw sewage poses many health risks, but does not consider contact with diluted raw sewage as an exposure route for blood-borne pathogens. Nonetheless, inspectors who contact the domestic sewage portion of the wastewater treatment system are to be aware of the potential danger and will be outfitted with proper personal protective equipment (PPE) (i.e., nitrile gloves, Tyvek suites, splash goggles) to minimize the chance for exposure. Inspectors are also recommended to have current Tetanus and Hepatitis A and B immunizations to protect themselves against potential biological hazards.

PERSONAL PROTECTIVE EQUIPMENT (PPE)

While conducting vessel inspections, inspectors should wear appropriate protective attire including:

- Non-skid shoes.
- Long sleeve coveralls, or long sleeve cotton shirt and long pants.
- Hearing protection in hearing conservation zones (e.g., the vessel's engine room).
- If visiting the vessel at drydock, additional PPE such as steel-toed shoes and hard hat may be required.

E. VIOLATIONS AND EXAMPLES

COMMON VGP VIOLATIONS AND EXAMPLES OF GOOD AND BAD PRACTICES

Common VGP Violations

The most common violations inspectors can expect to encounter are paperwork-related, including:

- Failure to submit an NOI (approximately half of all violations) or an annual report.
- Failure to perform routine, quarterly, and annual inspections and/or failure to document these inspections (approximately 40 percent of violations).
- Failure to document oily water and ballast discharges (or ballast discharge report submitted to EPA does not match ballast discharge records onboard the vessel).
- Failure to complete and/or maintain a copy of the PARI form onboard (for vessels subject to VGP that are less than 300 gross tons and do not have the capacity to discharge more than 8 cubic meters)

The VGP has many requirements for documentation that must be maintained in the ship's logbook or other recordkeeping tool. However, there is no standardized recordkeeping format. Some owners/operators prepare corporate VGP compliance manuals with inspection forms that are used on all their vessels. Other owner/operators may use existing USCG forms or forms required by their classification society for VGP recordkeeping. Inspectors need to be familiar with permit requirements so they can assess whether the recordkeeping format and content used by individual vessels meet requirements.

Certain types of vessels may be more likely to have permit violations than others. For example, older vessels are more likely to have poor maintenance and poor housekeeping practices compared to newer vessels. Bulk carriers tend to be older. Their engine rooms may have poor housekeeping and are more likely to have oily water compliance issues. Their decks could be disordered as a result of transporting unpackaged bulk cargos.

Most Important Discharges for Most Vessel Types

Certain discharges authorized by the permit are of greater concern than others for several reasons. First, certain discharges generated in small quantities by relatively few vessels (e.g., exhaust gas scrubber washwater effluent, gas turbine water wash, and freshwater layup) are of lesser concern. Second, some discharges contain few pollutants of concern at low concentrations and have correspondingly few permit requirements, even if they are possibly generated in large quantities, (e.g., distillation and reverse osmosis brine, non-oily machinery, refrigeration and air condensate, seawater cooling overboard discharge, and sonar dome discharge). As a result, inspectors are likely to focus most of their time on the following subset of discharges:

- Deck washdown
- Bilgewater
- Ballast water
- Graywater

GOOD AND BAD PRACTICES

Note that many permit requirements include terms such as “minimize” pollutant discharges. The term “minimize” means to reduce and/or eliminate to the extent achievable using control measures (including best management practices) that are technologically available and economically practicable and achievable in light of best marine practice. Unfortunately for inspectors, measures and practices that “minimize” pollutant discharges vary widely by vessel type and individual vessels and are highly dependent on a vessel's purpose, service, and operations. Therefore, what may represent good measures and practices onboard one vessel may not represent good measures and practices onboard another. As mentioned previously, vessels may have VGP compliance guides that specify the measures and practices to be used to comply with the permit. However, it is not a requirement of the permit.

Below are examples of general good and bad practices for the most important discharges on most vessels. Use of the good practices does not ensure compliance with the permit. Similarly, used of bad practice does not necessarily constitute a permit violation.

Deck Washdown

Good practices include use of drip pans under deck machinery such as winches and generators where feasible. Such drip pans should be emptied and cleaned to reduce the risk for pan contents to wash overboard via precipitation, seaspray, or vessel movement. Deck surfaces and above water line hull surfaces should be free from rust, paint chips, spilled cargos and other materials, and debris. Deck washdowns should be performed according to standard industry practices (e.g., broom clean followed by cleaning using hoses and non-toxic, phosphate-free, and biodegradable soaps and detergents, followed by rinsing using hoses). Examples of bad practices include lack of drip pans if it is clearly feasible that drip pans could be placed under machinery to collect oily water; spills on the deck and other evidence of poor housekeeping; peeling deck surfaces and paint; rust; abrasive power cleaning, resulting in stripping of paint chips and then discharging them into receiving waters; and use of prohibited soaps and detergents. Large vessels that regularly sail outside the territorial sea should not need to wash their decks with fire hoses while pier-side.

Bilgewater

Good practices include a clean bilge, which indicates prompt clean-up of any oily drips and spills (drums containing oily rags for proper shore-side disposal are further evidence of these good practices). Other good practices include thorough documentation of bilgewater discharges in the oil record logbook, routine calibration of the oil content meter, physically securing the bilgewater discharge valve or disabling automatic bilge pumps while pier-side. Examples of bad practices include a dirty bilge, use of “magic pipes” to bypass the oily water separator and oil content meter, oil sheen in receiving waters following bilgewater discharge, and evidence of use of dispersants/detergents to remove bilgewater sheen.

Ballast Water





Good practices include a ballast water management plan (if required) and maintenance of a thorough ballast water discharge log. An example of a bad practice is if the ballast discharge report submitted to EPA does not match ballast discharge records onboard the vessel. Additionally, vessels with ballast water treatment systems that discharge into waters subject to the VGP must monitor for biological indicator organisms and biocides or biocide derivatives. Records of the sampling and testing results from the last 3 years must be onboard.

Graywater

Graywater is of most concern on cruise ships. Good practices include limiting graywater generation from activities such as showering, dishwashing and laundry while pier-side, or using a graywater storage tank to hold these wastewaters for later discharge if feasible. Other examples include use of non-toxic, phosphate-free, and biodegradable soaps and detergents for general cleaning, laundry, and dishwashing. Examples of bad practices include obvious disregard of permit requirements to minimize the discharge of graywater while in port. Other examples of bad practices are operating the food grinder while pier-side, and using soaps

and/or detergents that are NOT considered non-toxic, phosphate-free, and biodegradable. These types of soaps should only originate from shower and lavatory use, or it could indicate a permit violation. Medium and large cruise ships are required to maintain records estimating all discharges of treated graywater into waters subject to the VGP and initial and maintenance monitoring as required by the permit.

Photo examples of good and bad management practices:

Good practices	
<p data-bbox="203 535 803 567">Photo 19-1. Use of oil-absorbing pads for bilge water.</p> 	<p data-bbox="836 535 1412 567">Photo 19-2. Properly maintaining equipment.</p> 
Bad practices	
<p data-bbox="203 1102 803 1134">Photo 19-3. Poor storage of hazardous waste.</p> 	<p data-bbox="836 1102 1412 1134">Photo 19-4. Continuing to operate without corrective action when there is a visible oily sheen.</p> 

F. REFERENCES

The following is a list of resources providing additional information on vessels.

Abt Associates. (2008). *Economic and Benefits Analysis of the Final Vessel General Permit (VGP)*. Available at: http://www.epa.gov/npdes/pubs/vessel_vgp_economicanalysis.pdf

Battelle. (2007). *Technical Support for EPA Development of a Permitting Framework to Address the Vacatur of the NPDES Vessel Exclusion*. Prepared for U.S. Environmental Protection Agency. EPA-HQ-OW-2011-0141.

Northwest Env'tl. Advocates et al. v. United States EPA. (N.D. Cal., 2005). 2005 U.S. Dist. LEXIS 5373.

Northwest Env'tl. Advocates et al. v. United States EPA, 2006 U.S. Dist. LEXIS 69476 (N.D. Cal., 2006).

Northwest Env'tl. Advocates v. EPA. (9th Cir., 2008). 537 F.3d 1006.

U.S. Coast Guard (USCG). (2011). *Guidelines for Coast Guard Evaluations of Compliance with the U.S. Environmental Protection Agency's (EPA) Vessel General Permit (VGP) for Discharges Incidental to the Normal Operation of Vessels*. CG-543 Policy Letter 11-01. Available at: <http://www.uscg.mil/hq/cg5/lgcncoe/docs/EPA%20VGP.pdf>

U.S. Environmental Protection Agency. (2013a). Available at: <https://www.regulations.gov/#!documentDetail;D=EPA-HQ-OW-2011-0141-0949>.

U.S. Environmental Protection Agency. (2008a). *National Pollutant Discharge Elimination System (NPDES) Vessel General Permit (VGP) for Discharges Incidental to the Normal Operation of Vessels Fact Sheet*. Available at: http://www.epa.gov/npdes/pubs/vessel_vgp_factsheet.pdf

U.S. Environmental Protection Agency. (2008b). *Proposed VGP: EPA's Response to Public Comments*. Document No. EPA-HQ-OW-2011-438.

U.S. Environmental Protection Agency. (2009). *National Pollutant Discharge Elimination System (NPDES) Vessel General Permit for Discharges Incidental to the Normal Operation of Vessels (VGP)*. Available at: <https://www.regulations.gov/#!documentDetail;D=EPA-HQ-OW-2008-0055-0436>

U.S. Environmental Protection Agency and U.S. Coast Guard (USCG). (2011). *Understanding Between the U.S. Environmental Protection Agency, Office of Enforcement and Compliance Assurance and the U.S. Coast Guard, Office of Marine Safety, Security and Stewardship for Collaboration on Compliance Assistance, Compliance Monitoring, and Enforcement of Vessel General Permit requirements on Vessels*. EPA Memorandum. Available at: http://www.uscg.mil/hq/cgcvc/cvc1/general/vgp/CG_EPA_MOU.pdf

U.S. Environmental Protection Agency. (2013b). *National Pollutant Discharge Elimination System (NPDES) Vessel General Permit (VGP) for Discharges Incidental to the Normal Operation of Vessels Fact Sheet*. Available at:
<https://www.regulations.gov/#!documentDetail;D=EPA-HQ-OW-2011-0141-0950>

CHAPTER 17 – POLLUTION PREVENTION

Contents

A. Overview of Pollution Prevention.....	473
Pollution Prevention Goals.....	473
Waste Management Hierarchy	473
Pollution Prevention Benefits.....	475
B. Pollution Prevention Opportunity Assessment Procedures for Industrial Facilities	478
Preparation.....	479
Interview.....	480
Facility Site Visit.....	480
C. Pollution Prevention Opportunity Assessment Procedures For Municipal wastewater treatment plants	484
D. References.....	486

List of Tables

Table 17-1. Useful Facility Information to Conduct a Pollution Prevention Opportunity Assessment	484
--	-----

List of Exhibits

Exhibit 17-1. Waste Management Hierarchy.....	477
Exhibit 17-2. Benefits of Pollution Prevention.....	477
Exhibit 17-3. Pollution Prevention Opportunity Assessment	483

Related Websites

Pollution Prevention (P2) home page: <https://www.epa.gov/p2>
Pollution Prevention Information Clearinghouse (PPIC): <https://www.epa.gov/p2/pollution-prevention-resources#ppic>
Pollution Prevention Case Studies: <https://www.epa.gov/p2/pollution-prevention-case-studies>
Pollution Prevention Resource Exchange: <http://www.p2rx.org/programs/>

A. OVERVIEW OF POLLUTION PREVENTION

Pollution prevention is a proactive environmental management approach for minimizing material and resource losses during production. Pollution prevention addresses all aspects of production processes from raw material usage and inventory procedures to waste management and utilities conservation. Management techniques that incorporate pollution prevention reduce or eliminate the generation of pollutants, wastes, and adverse ecological impacts through new approaches, material substitutions, and optimizing processes and operating procedures.

POLLUTION PREVENTION GOALS

The goal of pollution prevention is to reduce pollution by eliminating or reducing waste. Pollution prevention is a multimedia approach that minimizes or eliminates pollutants released to land, air, and/or water without shifting pollutants from one medium to another. The Pollution Prevention Act of 1990 defines source reduction as:

...any practice which reduces the amount of a hazardous substance, pollutant, or contaminant entering any wastestream or otherwise released into the environment (including fugitive emissions) prior to recycling, treatment, or disposal; and any practice which reduces the hazards to public health and the environment associated with the release of such substances, pollutants, or contaminants.

Pollution prevention, therefore, represents a fundamental shift in approach away from the conventional reliance on waste treatment/disposal or "end-of-pipe" treatment to the active investigation of prevention techniques. Facilities can implement pollution prevention by:

- Modifying equipment or technology
- Modifying process or procedure
- Reformulating or redesigning products
- Substituting of raw materials
- Improvements in housekeeping, maintenance, training, and/or inventory control

WASTE MANAGEMENT HIERARCHY

A facilities pollution prevention program should eliminate or reduce the generation of pollutants and wastes at the source by carefully considering material usage, production processes, and waste management practices. The facility's pollution prevention program should identify opportunities for reducing the use of hazardous materials and waste generation or releases, as well as opportunities to protect natural resources by conserving and efficiently using energy and water.

The Pollution Prevention Act of 1990 includes a Waste Management Hierarchy that describes a comprehensive waste management program. The hierarchy assigns the highest priority to source reduction and places a decreasing level of preference on recycling, treatment, and disposal. To be most effective, a facility's pollution prevention program should focus on

implementing source reduction. Where source reduction cannot be achieved, reuse and recycling projects should be implemented. If there is no feasible pollution prevention alternative, treatment and disposal should be used as a last resort. Exhibit 17-1 is a graphic representation of the waste management hierarchy. Each level of the hierarchy is described below.

Source Reduction

Source reduction refers to the use of materials, processes, or practices that reduce or eliminate the quantity and toxicity of wastes at the point of generation. By preventing waste, the need for costly treatment and disposal is decreased. Source reduction can be achieved by substituting raw materials improving operating practices and changing processes and equipment.

- **Substituting raw material:** Replacing hazardous materials with less hazardous (or less toxic) alternatives reduces releases to the environment of hazardous materials and wastes resulting from routine production processes and accidental spills. Examples of material substitutions include, but are not limited to, 1) substituting soy-based or water-based ink to replace solvent-based ink for printing, 2) using recycled paper instead of virgin stock, 3) replacing Styrofoam packing materials with re-usable hard-pack plastic materials for shipping products, 4) eliminating trichloroethylene as a cleaning agent by substituting a caustic cleaner such as potassium hydroxide or sodium hydroxide, and 5) eliminating Freon[®] use.
- **Improving operating practices:** Improved operating practices can reduce waste generated from poorly developed standard operating procedures, inadequate training, and inefficient production scheduling. In the past, facilities developed operating practices that maximized production without considering factors such as raw material usage, waste disposal costs, and environmental impacts. Examples of improved operating practices include, but are not limited to, segregating waste, improving housekeeping, and establishing preventive maintenance, training, and outreach programs.
- **Modifying processes and equipment modifications:** In the long run, one of the most effective source reduction techniques may involve process and equipment modifications. Changes to processes and equipment present significant opportunities for source reduction and pollution prevention. Such modifications include using newer or more efficient equipment or redesigning a process so that less raw material is required, yet product quality is maintained.

Recycling

While source reduction prevents wastes from being generated, recycling turns byproducts and wastes into reusable products. Recycling includes such practices as on-site or off-site recycling, materials exchange or reuse, and raw materials recovery.

- **On-site/off-site recycling:** Both on-site and off-site recycling can help reduce dependence on expensive virgin materials by reusing spent materials.

- **Materials exchange or reuse:** A materials exchange system maximizes the use of a facility's excess raw materials and equipment. A system generally consists of a database for tracking the availability of excess materials by department (or whatever organizational unit is appropriate). In addition, a materials exchange system may include a communication link with the facility's supply system to alert stock clerks that excess items are on hand and should be used prior to purchasing new stock.
- **Materials recovery:** Some of the byproducts and wastes generated during production can be recovered and sold as commodities. For example, waste acids that no longer meet the requirements of a final, critical cleaning process can be used in a secondary process that does not require the same level of cleanliness. Other examples of materials recovery as part of waste treatment are discussed below.

Waste Treatment

Unlike source reduction, waste treatment applies to wastes after generation. The goals of waste treatment technologies are to neutralize the waste, to recover energy or material resources, to render the waste nonhazardous, or to reduce the volume. Treatment technologies that enable material to be recovered include ion exchange, reverse osmosis, electrolytic metal recovery, and electro dialysis. Volume reduction through evaporation is an example of treatment. Although volume reduction decreases the amount of wastewater, the absolute quantity of hazardous or toxic waste released to the environment is not reduced. In addition, equipment for volume reduction requires a capital cost and energy costs.

Waste Disposal

Disposal should be considered only when all other options are exhausted. Disposal is considered the least favored waste management method because of the associated costs, liability, and environmental impacts. In addition, a limited number of permitted waste sites are available for disposing hazardous material, and many of these sites are approaching capacity. Also, waste transportation may pose hazards. Finally, recordkeeping and reporting requirements associated with disposing hazardous wastes are an additional burden that can be avoided through preventive measures, such as source reduction.

POLLUTION PREVENTION BENEFITS

Exhibit 17-2 summarizes the direct benefits of pollution prevention practices for facilities. Source reduction improves the potential for environmental compliance. Because penalties for environmental compliance are becoming increasingly severe, compliance is a top priority.

Implementing source reduction measures can also reduce costs associated with waste management. Costs reductions may be experienced in expenditures for raw materials, waste disposal, transportation, handling and storage, training, management overhead, and emergency response. By decreasing the amount of hazardous waste shipped off-site for disposal, the facility may also reduce the costs associated with tracking and filing paperwork required for hazardous waste manifests. Future costs, such as remediation activities, can also be avoided with source reduction activities.

In addition, source reduction will produce positive health and environmental benefits. By maintaining fewer hazardous or toxic materials on-site, facilities reduce occupational hazards, and, therefore, improve worker health and safety. Creating a safer workplace may reduce the need for expensive health and safety protection devices. Also, insurance cost may be lowered. A safer workplace will also improve employee job satisfaction. Reducing hazardous materials usage also decreases the volume of toxic substances released to the environment from spills, leaks, and air emissions.

The indirect benefits of pollution prevention may be equally significant. One indirect benefit is reduced liability. The Resource Conservation and Recovery Act (RCRA) and Comprehensive Environmental Response, Compensation, and Liability Act (CERCLA) "cradle-to-grave" provisions stipulate that a generator remains responsible for all environmental damage resulting from its waste including damage that occurs after disposal. A pollution prevention program can generate goodwill in the community and workplace, enhance the facility's public image, and foster environmental awareness among employees.

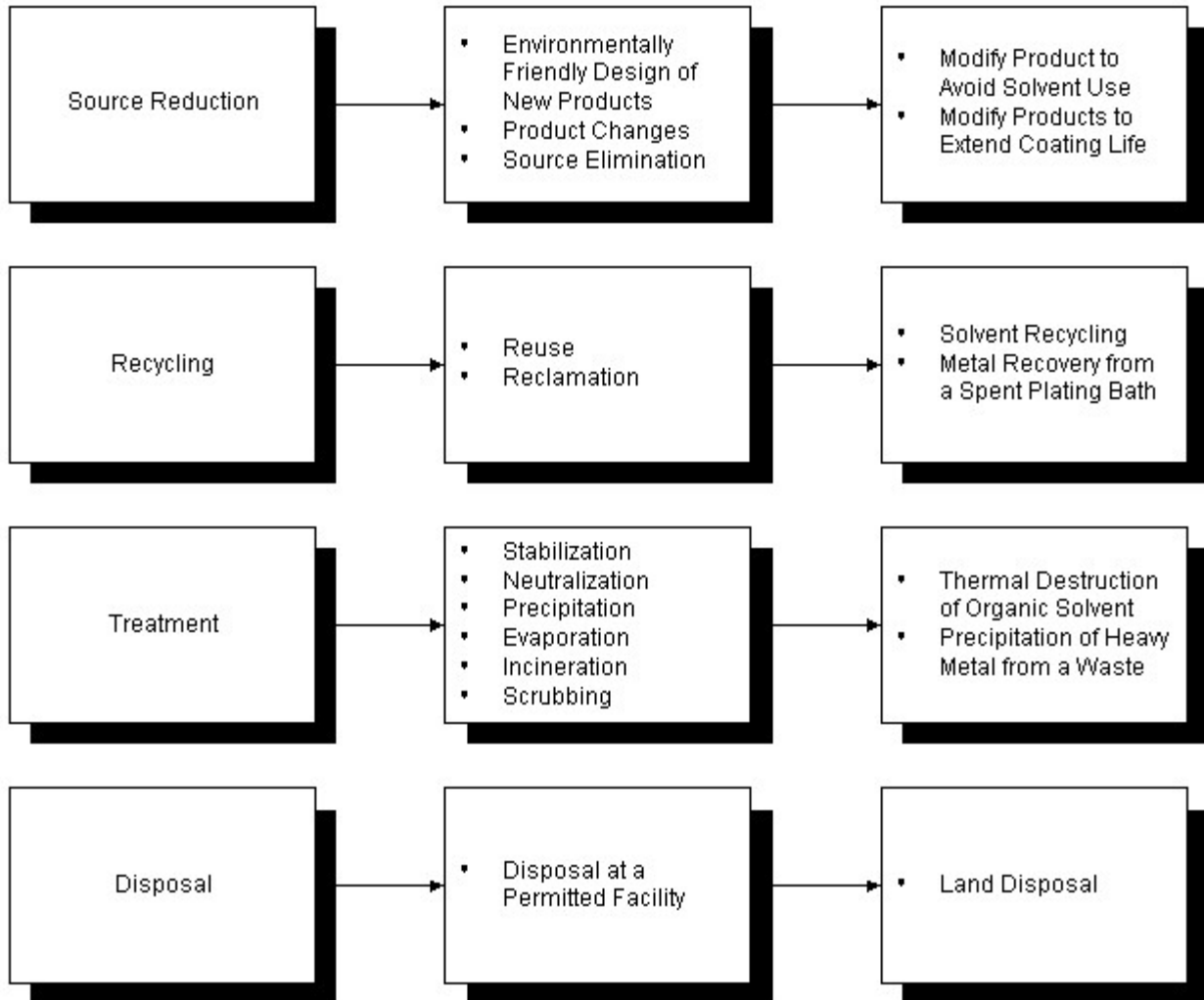

Exhibit 17-1. Waste Management Hierarchy

- Significantly reduces the amount of pollution released to the environment.
- Improves the potential for environmental and safety compliance.
- Improves worker health and safety by reducing occupational hazards.
- Provides the flexibility to choose cost-effective and environmentally sound solutions that will also result in improved efficiency and increased profit margins.
- Provides public recognition of a facility's efforts.
- Saves capital because of reductions in waste sent for costly treatment and disposal and because of decreased raw materials and energy usage.

Exhibit 17-2. Benefits of Pollution Prevention

B. POLLUTION PREVENTION OPPORTUNITY ASSESSMENT PROCEDURES FOR INDUSTRIAL FACILITIES

Because the primary objective of a routine National Pollutant Discharge Elimination System (NPDES) compliance inspection is to evaluate the facility's compliance with its NPDES permit requirements, a pollution prevention assessment incorporated into a compliance assessment may, by necessity, be limited. Nevertheless, the inspector can use these routine NPDES compliance inspections to identify pollution prevention options, particularly those options that would improve compliance. Alternatively, a facility visit may be conducted solely to evaluate the facility. In this instance, the general procedure for a facility visit is the same as that for any inspection (e.g., preparation, entry, opening conference, facility tour), but the specific focus is on identifying pollution prevention opportunities for the facility to investigate. Two reference documents the inspector may find useful are EPA's *Waste Minimization Opportunity Assessment Manual* (EPA, 1998) and EPA's *Facility Pollution Prevention Guide* (EPA, 1992a). These documents contain procedures for conducting a pollution prevention opportunity assessment. Pollution prevention opportunity assessments have four phases: 1) planning and organization, 2) assessment, 3) feasibility analysis, and 4) implementation. The four phases are summarized in Exhibit 17-3.

The inspector cannot perform all the steps in the type of pollution prevention assessment described in the *Waste Minimization Opportunity Assessment Manual* (EPA, 1998) and in the *Facility Pollution Prevention Guide* (EPA, 1992a). These documents were developed as guides for waste generators who want to implement a pollution prevention program. The feasibility analysis and implementation phases require development of criteria to screen and rank the options, conduct an in-depth technical assessment of options that can be successfully applied at that facility, conduct an economic evaluation, and the develop an implementation plan and schedule, which only the facility can determine. However, the inspector can evaluate whether the facility has conducted such an assessment and whether there are obvious pollution prevention opportunities. The inspector may also find useful EPA's *2010-2014 Pollution Prevention Program Strategic Plan* (EPA, 2010), which identifies opportunities for waste reduction.

It will be impossible, and unnecessary, for the inspector to have in-depth knowledge and understanding of all production processes and facility activities. However, as part of the entire pollution prevention assessment, whether during the preparation, interview, or facility site visit, the inspector should strive to become familiar with the facility layout, equipment and processes, points of potential waste generation, types of waste generated, and waste handling and disposal practices. If possible, the inspector should collect sufficient detailed information to develop a general flow diagram or material balance for each process step. The inspector should know the source, type, quantity, and concentration of each identified wastestream to identify data gaps, problem areas, and data conflicts.

As the assessment is conducted, the inspector should keep the pollution prevention principles in mind:

- Multimedia focus looking at all environmental media as a unified whole to avoid transfers from one medium to another; and
- Comprehensive evaluation of the total environmental impacts over the life cycle of the product, from raw materials through manufacturing (including energy use) to use and ultimate disposal.

PREPARATION

The inspector should prepare for the assessment by examining information about the processes, operations, and waste management practices at the facility. Any background material should be reviewed in the facility's file. If the inspection is planned to focus on pollution prevention assessment, the inspector should contact the facility to inform plant officials of this objective. During this initial contact, the inspector should ask for information that will help identify potential pollution prevention options. Table 17-1 provides a list of useful information for this assessment.

As the inspector reviews facility information, he or she should develop a list of questions specific to the facility. The inspector should be seeking, through the facility-specific questions, information to answer the following general questions:

- What significant wastestreams are generated by the plant? How much waste is generated?
- Why are these considered "waste"?
- From which processes or operations do these wastestreams originate?
- What is the production rate of each wastestream?
- Which wastes are hazardous and which are not? What makes them hazardous?
- How are the wastes managed at present?
- What are the input materials used that generate the wastestreams of a process or plant area?
- How efficient is the process? How much input material is:
 - Used in a process?
 - Released to water or air, or disposed of on land?
 - Destroyed or unaccounted for?
- What types of process controls are used to improve process efficiency?
- Are unnecessary wastes generated by mixing otherwise recyclable or recoverable hazardous wastes with other process wastes?
- What types of housekeeping practices are used to limit the quantity of wastes generated?
- Has the plant developed a Pollution Prevention Plan or strategy?

There are numerous resources that identify pollution prevention techniques for specific types of industry, such as the metal finishing industry, the fabricated metal products industry, and the pharmaceutical industry. This pollution prevention information can be obtained from:

- Pollution Prevention Information Clearinghouse (PPIC)
- Pollution Prevention Case Studies
- Pollution Prevention Resource Exchange

INTERVIEW

Just as with a routine NPDES compliance inspection, plant personnel should be interviewed when the inspector first arrives at the facility. The inspector should target personnel from the following areas:

- Management
- Environmental waste management
- Process engineering
- Facility maintenance
- Operation and production
- Safety and health
- Research and development
- Quality control
- Purchasing/inventory
- Shipping/receiving
- Storage

From the interviews, the inspector should develop (or verify) a list of all waste minimization practices already in place. The inspector should also ask plant personnel for the plant's Pollution Prevention Plan or strategy and any suggested pollution prevention opportunities in the operations and processes and discuss with the plant personnel any pollution prevention opportunities that were identified during preparations for the site visit or during the on-site interviews.

FACILITY SITE VISIT

Again, as with a routine compliance inspection, the inspector should conduct a tour of the facility with plant personnel after the interview. The same areas of the manufacturing facility, materials and waste storage, loading and unloading, and treatment system should be reviewed. At each process area, the plant personnel most knowledgeable about the activity should describe the process or should answer any questions the inspector may have.

The inspector should make personal observations, seek confirmation of the interpretation of an activity that is occurring, and investigate any information plant personnel provide that appears to contradict what is being observed. The inspector should focus on:

- Loading and unloading operations
- In-plant transfers (raw materials handling)
- Process operations
- Housekeeping practices
- Maintenance activities
- Waste management operations

The inspector should also check for signs of spills or leaks and assess overall cleanliness of the site. Throughout all the areas visited, the following wastestreams should be evaluated:

- Wastewater
- Air emissions, including stack and fugitive emissions (e.g., detectable odors and fumes)
- Hazardous wastes
- Nonhazardous solid wastes

Each wastestream should be reviewed to:

- Determine whether the wastes are hazardous or nonhazardous
- Determine other physical and chemical characteristics of wastes and emissions
- Determine actual points of generation
- Determine quantities including variations
- Identify all handling, treatment, and storage procedures on-site

Based on activities described above during a facility tour, the inspector should look for pollution prevention opportunities in the general areas listed below.

- Substituting less hazardous materials such as:
 - Using latex or water-based paints, rather than oil-based
 - Eliminating organic solvent cleaners and replacing with aqueous cleaners
- Limiting the amount of hazardous materials disposed of by:
 - Buying only the amount of material the facility needs
 - Using all materials before their expiration date
 - Using only the amount of material needed
 - Sharing materials or donating extra materials to community organizations
- Using and storing products carefully to prevent:
 - Accidents and spills
 - Mixtures of incompatible materials that can react, ignite, or explode
- Recycling wastes, such as:
 - Used oil

- Plastics, glass, paper, and metals
- Spent solvents
- Generating less pollution by:
 - Automating and improving process controls to optimize production operations
 - Allowing products to fully drain process chemicals before rinsing
 - Using less toxic materials (e.g., printing inks, dyes)
 - Adjusting production schedules to minimize cleanup operations
 - Sealing floor drains (permanently or temporarily) to prevent spills
 - Segregating wastes to support recycling (e.g., scrap metals, solvents)
- Turning waste products into new materials by:
 - Treating and recycling rinse waters
 - Recovering metals such as silver from waste materials
 - Recycling waste lubricants and coolants
- Using fewer resources by:
 - Installing flow restrictors on rinse waters
 - Installing high efficiency boilers and furnaces
 - Using heat exchangers to heat process water supplies
- Educating employees on the:
 - Goals of pollution prevention and waste management
 - Procedures to follow for waste disposal and pollution prevention
 - Accomplishments for the pollution prevention program being implemented

Before leaving the facility, the inspector should meet with plant personnel. A list of pollution prevention options identified during the site visit should be prepared and discussed with plant personnel. Inspectors can discuss a pollution prevention technology or refer the facility representatives to EPA or state pollution prevention technical assistance offices. However, the inspector should not recommend specific measures to implement. Nor should the inspector suggest products or imply that a certain pollution prevention measure will enable the facility to achieve compliance.

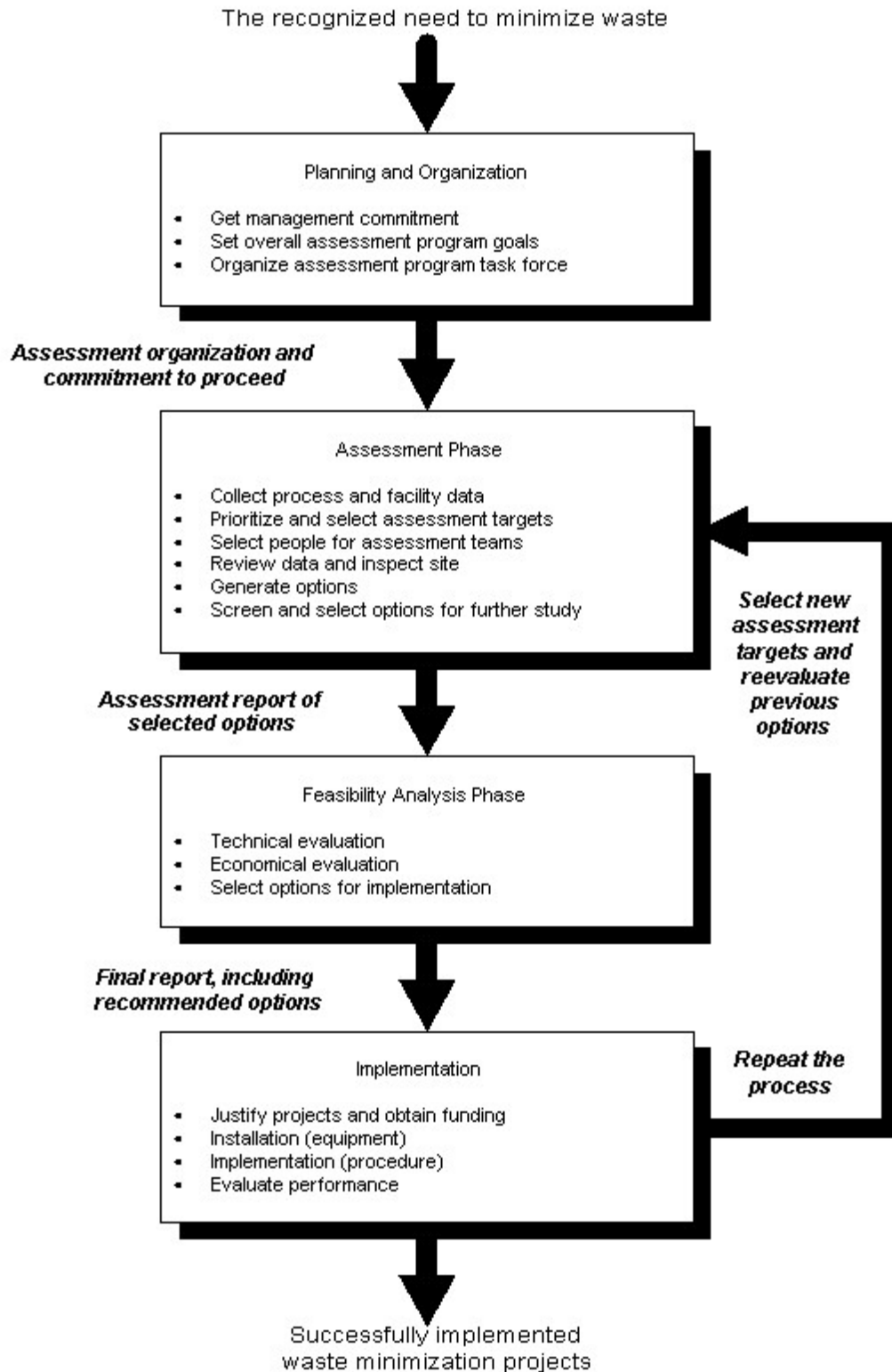

Exhibit 17-3. Pollution Prevention Opportunity Assessment

Table 17-1. Useful Facility Information to Conduct a Pollution Prevention Opportunity Assessment

RAW MATERIALS INFORMATION	• Product composition
	• Material Safety Data Sheets
	• Product and raw material inventory and purchasing records
	• Operator data logs
	• Production schedules and records
MANUFACTURING PROCESS INFORMATION	• Process flow diagrams
	• Material and heat balances for production
	• Manufacturing and pollution control processes
	• Operating manuals and process descriptions
	• Water usage rates
	• Equipment and equipment specifications
	• Piping and instrument diagrams
	• Sewer layout diagrams
	• Facility layout and elevation plans
• Equipment layouts and work flow diagrams	
WASTE GENERATION AND DISPOSAL INFORMATION	• Environmental permits—air emissions, solid waste, hazardous waste, NPDES, pretreatment
	• RCRA information—manifests, annual reports
	• Location of all wastewater, solid and hazardous waste collection, treatment, and storage points
	• Diagram of air, wastewater, and/or hazardous waste treatment units
	• Operating manuals for treatment units
	• Emissions inventories (air, NPDES Discharge Monitoring Reports (DMRs), etc.)
	• SARA Title III—Section 313 release reports
• Previous regulatory violations	

C. POLLUTION PREVENTION OPPORTUNITY ASSESSMENT PROCEDURES FOR MUNICIPAL WASTEWATER TREATMENT PLANTS

The Municipal Water Pollution Prevention (MWPP) program promotes the application of pollution prevention concepts of the Pollution Prevention Act to Publicly Owned Treatment Works (POTWs). Pollution prevention can reduce the need for substantial capital investment in new infrastructure, enhance worker safety, improve the usability of sludge, and reduce operation and maintenance costs. Practices that stress a preventive approach to water pollution abatement include the following:

- Mechanisms for routine assessments of the compliance status of POTWs. This mechanism should include an early warning system based on periodic self-audits and quantitative techniques for assessing the condition of municipal wastewater treatment systems.
- Reporting processes on the capability of POTWs to sustain compliance.
- Processes for identifying, implementing, and tracking corrective actions to prevent pollution and maintain compliance.
- Program that will encourage POTWs to develop pollution prevention projects.

Pollution prevention practices POTWs can adopt could focus in the areas of:

- Improved operation and maintenance.
- Projects that reduce wastewater flows and pollutant loadings.
- Energy and water conservation.
- Timely planning and financing for future needs and economic growth prior to occurrence of wastewater permit violations.
- Toxicity reductions at the source (industrial pretreatment, commercial and residential source reduction programs).
- Recycling.
- Proper treatment of wastes.
- Beneficial uses of sludge.

Specific opportunities for optimizing each unit operation to maximize removal efficiency may include unit modifications to improve performance. For example:

- Clarifiers—Baffle installations and weir modifications to improve hydraulics and limit short circuiting.
- Aeration basins—Baffles to limit short circuiting. Fine bubble diffusers to improve aeration. Use of automatic controls to optimize aeration and limit over-aeration.
- Aerobic digester—Recover energy from gas. Insulate digester.

At any time, but especially during upgrading and expansion, the following pollution prevention projects could be considered:

- Install high efficiency pumps, motors and drives.
- Use biological- rather than chemical-based treatment.
- Install equalization basins to improve efficient operation of downstream units and minimize the need for oversize units.
- Design plant layout to minimize the need for intermediate pumping.
- Consider ultraviolet or ozone disinfection instead of chlorine.
- Digest residuals rather than heat or chemical treat.

- Select dewatering equipment not only to maximize solids but to minimize the need for chemical feeds that increase the volume of residuals.
- Evaluate toxicity of all lubricants, solvents, or cleaners, and replace them with less toxic alternatives such as citrus-based cleaners wherever possible.
- Reduce infiltration/inflow, which will result in several benefits:
 - Reduces plant expansion needs.
 - Improves performance efficiency.
 - Reduces grit (which increases equipment wear and breakage and is a disposal problem).

The Industrial Pretreatment Program is one of the best opportunities to achieve pollution prevention. It represents source control. Pollution prevention programs or projects aimed at residential and commercial users can also reduce loadings. Such pollution prevention programs could:

- Encourage water conservation.
- Provide information on compatible or biodegradable cleaners to replace more toxic cleaners (for example, identify an alternative to chlorine-based "hang-in" type toilet bowl cleaners).
- Encourage composting instead of garbage grinders.
- Enforce a commercial oil and grease ordinance requiring installation, operation, and maintenance of grease traps and recovery and recycle of oil and grease.
- Discourage oil and grease dumping.
- Prohibit disposable diaper flushing.

The POTW could also work with water utilities or agencies involved in establishing plumbing codes to reduce the metals (zinc, copper, and lead) found in drinking water supplies. These metals may be present because the water is corrosive to the pipes and leaches the metals from copper tubing, zinc-coated iron and steel pipes, and lead solder. The water utility may also be using water conditioning chemicals that contain metal salts.

The protocols for conducting a pollution prevention assessment at municipal wastewater treatment plants are similar to those for an industrial facility. The protocols of a Compliance Evaluation Inspection (CEI) are also appropriate, except that the focus during the interview, file review, and site visit is on identifying pollution prevention opportunities.

D. REFERENCES

The following is a list of resources providing additional information on pollution prevention.

U.S. Environmental Protection Agency. (1988). *Waste Minimization Opportunity Assessment Manual*. EPA/625/7-88/003.

U.S. Environmental Protection Agency. (1991). *Municipal Water Pollution Prevention Program*. 21W-7002.

U.S. Environmental Protection Agency. (1992a). *Facility Pollution Prevention Guide*. EPA/600/R92/088.

U.S. Environmental Protection Agency. (1992b). *RCRA Waste Minimization Action Plan*. EPA/530/R92/020.

U.S. Environmental Protection Agency. (2010). *2010-2014 Pollution Prevention (P2) Program Strategic Plan*.

University of Tennessee. (1989). *Waste Reduction Assessment and Technology Transfer (WRATT) Training Manual, 2nd Edition*. Knoxville, Tennessee: The University of Tennessee, Center for Industrial Services.

E. CHECKLISTS

Pollution Prevention Checklist for Industry

Yes	No	N/A	1. Are there designated material storage areas?
Yes	No	N/A	2. Are storage areas clean and organized?
Yes	No	N/A	3. Are containers stored in such a way as to allow for visual inspection for corrosion and/or leaks?
Yes	No	N/A	4. Are containers stacked in a way to minimize the chance of tipping, puncturing, or breaking?
Yes	No	N/A	5. Are there adequate distances from incompatible chemicals and different types of chemicals to prevent cross-contamination?
Yes	No	N/A	6. Is one person responsible for maintaining storage areas?
Yes	No	N/A	7. Does the layout of the facility result in minimizing traffic through material storage areas?
Yes	No	N/A	8. Are stored items protected from damage, contamination, and exposure to weather?
Yes	No	N/A	9. Are all storage tanks routinely monitored for leaks?
Yes	No	N/A	10. Is containment, such as a curb or dike, installed in storage areas to contain leakage and to minimize the area contaminated by a spill?
A. GENERAL			
Yes	No	N/A	1. Is there a written facility policy regarding pollution prevention?
Yes	No	N/A	2. Is there a pollution prevention program currently in place?
Yes	No	N/A	3. Is there a specific person assigned to oversee the success of the program?
Yes	No	N/A	4. Are there management/employee initiatives and incentive programs related to pollution prevention?
Yes	No	N/A	Quality circles (free forums between employees and supervisors) to identify pollution prevention options?
Yes	No	N/A	Opportunities for employee suggestions on pollution prevention options?
Yes	No	N/A	5. Has the facility previously conducted a pollution prevention assessment?
Yes	No	N/A	6. Has the facility used better cost accounting and cost allocation to provide incentives to reduce wastes or resource consumption?
Yes	No	N/A	Is cost accounting performed accurately for all process areas and wastestreams?
Yes	No	N/A	Are utility costs (energy, water) and waste treatment and disposal costs allocated to the operations that generate the waste?
B. STORAGE AREAS			
Yes	No	N/A	11. Are leak detection systems installed for underground storage tanks?
Yes	No	N/A	12. Are floating-roof tanks used for VOC control?
Yes	No	N/A	13. Are conservation vents used on fixed roof tanks?
Yes	No	N/A	14. Does the facility use vapor recovery systems?

Pollution Prevention Checklist for Industry

C. MATERIALS INVENTORY			
Yes	No	N/A	1. Is there an inventory control system designed to prevent materials from deteriorating in storage (first in, first out to prevent expiration)?
Yes	No	N/A	2. Is obsolete raw material returned to the supplier?
Yes	No	N/A	3. Does the facility try to order smaller containers of infrequently used materials to avoid disposing of large quantities of unused obsolete materials?
Yes	No	N/A	4. Has the facility tried to order larger containers of frequently used materials to reduce the number of small containers that must be cleaned and disposed of?
			5. Does the facility use or maintain:
Yes	No	N/A	Hazardous chemicals inventory lists?
Yes	No	N/A	Material safety data sheet files?
			6. Are all in-plant containers of hazardous chemicals labeled, tagged, or marked with:
Yes	No	N/A	Identity of the hazardous chemical(s)?
Yes	No	N/A	Appropriate hazard warnings?
Yes	No	N/A	7. Has the facility reexamined its need for each raw material?
Yes	No	N/A	8. Does the facility have a way to use off-spec material, where possible?
D. MATERIAL HANDLING			
Yes	No	N/A	1. Are raw materials tested for quality before being accepted from suppliers?
Yes	No	N/A	2. Does the facility follow proper procedures when transferring materials?
Yes	No	N/A	3. Are expired materials tested for effectiveness before being disposed of?
Yes	No	N/A	4. Are drums, packages, and containers inspected for damage before being accepted?
Yes	No	N/A	5. Are containers properly resealed after use?
Yes	No	N/A	6. Are containers emptied thoroughly before cleaning or disposal?
			7. Does the facility segregate its wastes as much as possible?
Yes	No	N/A	Solid wastes from aqueous wastes?
Yes	No	N/A	Nonhazardous from hazardous?
Yes	No	N/A	Segregated according to type of contaminant?
Yes	No	N/A	Different types of solid waste to improve recycling/reuse?
Yes	No	N/A	Different types of solvents, cleaner wastes, and lubricants (e.g., organic solvents from mineral oils)?
E. PROCESS OPERATIONS			
Yes	No	N/A	1. Are water conservation measures, recycling, and reuse techniques practiced in processes that use water or generate a wastewater (e.g., cleaning and rinsing operations)?
Yes	No	N/A	2. Has material substitution been tried for any hazardous materials used in process?

Pollution Prevention Checklist for Industry

Yes	No	N/A	3. Have any techniques been used to increase the life of any process baths?
Yes	No	N/A	4. Are any wastes being recycled, reused, or recovered in some manner?
Yes	No	N/A	5. Have any equipment or process modifications been made to increase material use efficiency and thus reduce material waste generation?
Yes	No	N/A	6. Do processes employ any detectors to alert personnel of malfunctions that could produce/generate excessive wastes?
F. SPILLS AND LEAKS			
Yes	No	N/A	1. When a spill occurs, what cleanup methods are employed?
Yes	No	N/A	2. Would different cleaning methods allow for direct reuse or recycling of the water?
Yes	No	N/A	3. Are there preventive maintenance procedures designed to reduce incidents of equipment breakdowns, inefficiency, spills, or leaks?
G. MATERIAL SUBSTITUTION			
Yes	No	N/A	1. Could the facility modify or completely change a given process to use water-based coolants and fluids instead of oil-based fluids?
H. SOLVENT USE			
			1. Can solvent cleaning be replaced with less toxic cleaning, such as:
Yes	No	N/A	A dry process (e.g., bead or sand blasting or other abrasives)?
Yes	No	N/A	Steam cleaning?
Yes	No	N/A	Caustic cleaning?
Yes	No	N/A	2. Are non-chlorinated solvents substituted for chlorinated solvents?
Yes	No	N/A	3. Are parts wiped to remove oil and dirt prior to solvent cleaning?
Yes	No	N/A	4. Is the loss of cleaning ability of the solvent monitored before the solvent is replaced?
Yes	No	N/A	5. Are chemicals reused or recycled?
Yes	No	N/A	6. Is an on-site distillation unit for solvent recovery and reuse installed?
Yes	No	N/A	7. Is solvent use standardized?
I. RINSE WATERS			
Yes	No	N/A	1. Have excessive rinses been evaluated and eliminated?
Yes	No	N/A	2. Is rinse water reclaimed, pretreated, and reused?
Yes	No	N/A	3. Are water softeners used only where necessary?
J. TRAINING			
Yes	No	N/A	1. Are there formal personnel training programs on raw material handling, spill prevention, proper storage techniques, and waste handling procedures?
Yes	No	N/A	2. Are employees trained in pollution prevention techniques?
Yes	No	N/A	3. How often is training given and by whom?

Pollution Prevention Checklist for Industry

K. GOOD OPERATING PRACTICES			
Yes	No	N/A	1. Are plant material balances performed routinely?
Yes	No	N/A	2. Are they performed separately for each material of concern?
Yes	No	N/A	3. Are records kept for each waste, documenting sources of origin and eventual disposal?
Yes	No	N/A	4. Are operators provided with detailed operating manuals or instruction sets?
Yes	No	N/A	5. Are all operator job functions well defined?
Yes	No	N/A	6. Are regularly scheduled training programs offered to operators?
			7. Has the facility integrated pollution prevention into supervision and management by:
Yes	No	N/A	Closer supervision to improve production efficiency and reduce inadvertent waste generation (increased opportunity for early detection of mistakes)?
Yes	No	N/A	Management by Objectives (MBO) with defined and achievable goals for waste minimization (better coordination among the various parts of an overall operation)?
Yes	No	N/A	Scheduling production to minimize cleaning frequency?
			8. Has the facility improved production scheduling and planning to include:
Yes	No	N/A	Maximizing batch sizes?
Yes	No	N/A	Dedicating equipment to a single product?
Yes	No	N/A	Altering batch sequencing to minimize cleaning frequency?
Yes	No	N/A	9. Is corrective maintenance practiced, such as resetting control valves or adjusting process temperatures, to increase efficiency and to prevent raw material loss through wastestreams?
Yes	No	N/A	10. Does the facility forbid operators to bypass interlocks and alarms, or to significantly alter set points without authorization?
Yes	No	N/A	11. Are overflow or malfunction alarms installed on tanks and equipment?
L. HOUSEKEEPING PRACTICES			
			1. Good housekeeping is the maintenance of a clean, orderly work environment. Does the facility:
Yes	No	N/A	Maintain neat and orderly storage of chemicals?
Yes	No	N/A	Promptly remove spillage?
Yes	No	N/A	Maintain dry and clean floors by use of brooms and/or vacuum cleaners?
Yes	No	N/A	Provide proper walkways with no containers protruding into walkways?
Yes	No	N/A	Minimize the accumulation of liquid and solid chemicals on the ground or floor?
Yes	No	N/A	Stimulate employee interest in good housekeeping

Checklist derived from Waste Reduction Assessment and Technology Transfer (WRATT) Training Manual, 2nd Edition, University of Tennessee

Pollution Prevention Checklist for Municipal Wastewater Treatment Plants

A. AGE			
Yes	No	N/A	1. What year was the wastewater treatment plant constructed or the last major expansion to increase the capacity of the plant completed?
Yes	No	N/A	2. What sewer system improvements does the municipality have under consideration for the next 10 years?
Yes	No	N/A	3. What is the expected community and industrial growth?
Yes	No	N/A	4. Is there any major development (industrial, commercial, or residential) anticipated in the next 2 to 3 years, such that either the flow or pollutant loadings could significantly increase?
B. TREATMENT EFFICIENCY			
Yes	No	N/A	1. Compare influent actual flow to influent design flow. When will actual hydraulic loading exceed design?
Yes	No	N/A	Has the plant initiated expansion plans and financing sufficiently in advance to avoid overloading?
Yes	No	N/A	Has the plant investigated measures for reducing flow?
Yes	No	N/A	2. Compare conventional pollutant loadings (BOD, TSS, ammonia, phosphorus) to design loadings. When will actual loadings exceed design?
Yes	No	N/A	Has the plant initiated expansion plans and financing sufficiently in advance to avoid overloading?
Yes	No	N/A	Has the plant investigated measures for reducing loadings?
Yes	No	N/A	3. Review operating records. How many months were the effluent concentrations or loadings above 90 percent of the permit limits?
Mo.	_____		BOD?
Mo.	_____		COD?
Mo.	_____		Fecal coliform?
Mo.	_____		Other conventional pollutants limited by permit (ammonia, phosphorus)?
Mo.	_____		Metals or other toxics?
Yes	No	N/A	4. How many times were permit limits violated (in the last year)?
Yes	No	N/A	5. What types of violations have occurred in the last 5 years?
Yes	No	N/A	Are any of a recurrent nature? What were the causes?
Yes	No	N/A	Have effective solutions been implemented to prevent future recurrence?
Yes	No	N/A	6. How many bypasses have occurred? What were the causes?
Yes	No	N/A	Have effective solutions been implemented to prevent future recurrence?
Yes	No	N/A	7. What are the future regulatory or permit requirements that may require modifications to the plant or its operations?

Pollution Prevention Checklist for Municipal Wastewater Treatment Plants

Yes	No	N/A	Can the facility currently meet any future anticipated water quality standards or effluent discharge limits?
Yes	No	N/A	8. Has the plant investigated ways to maximize operating efficiency?
Yes	No	N/A	9. Has the plant investigated improvements to the chlorination system to decrease chlorine usage?
Yes	No	N/A	10. Does the plant have a written preventive maintenance program on major equipment items and the sewer collection system?
Yes	No	N/A	11. Does the preventive maintenance program depict frequency of intervals, types of lubrication, types of repair and other preventive maintenance tasks necessary for each piece of equipment or each section of the sewer?
C. SLUDGE			
Yes	No	N/A	1. Does the plant have sufficient sludge treatment, storage, and disposal capacity?
Yes	No	N/A	2. What percentage of the methane gas is captured and used? Has the plant investigated ways to increase the amount of gas captured and used?
Yes	No	N/A	3. Has the plant investigated ways to decrease the number of dewatering chemicals used?
D. COLLECTION SYSTEM			
Yes	No	N/A	1. How many overflows within the collection system have occurred?
Yes	No	N/A	2. How many backups at any point in the collection system have occurred for any reason? What were the causes? Have effective solutions been implemented to prevent future recurrence?
Yes	No	N/A	3. Has the plant investigated ways to decrease infiltration/inflow?
E. PREVENTIVE MAINTENANCE PROGRAM			
Yes	No	N/A	3. Are these preventive maintenance tasks, as well as equipment and sewer collection problems being recorded, filed, and reviewed so future maintenance problems can be assessed properly?
F. MATERIALS USAGE			
Yes	No	N/A	1. Has the plant identified all supplies used in the operation and maintenance of the plant?
Yes	No	N/A	2. Has the plant identified materials that could be substituted for less toxic materials?
Yes	No	N/A	3. Does the plant reuse or recycle any materials used?
Yes	No	N/A	4. Has the plant investigated ways to reduce chemical usage without compromising preventive maintenance or treatment?
G. PERSONNEL RESOURCES			
Yes	No	N/A	1. Review personnel resources, training, and certifications.
Yes	No	N/A	Are there sufficient numbers?

Pollution Prevention Checklist for Municipal Wastewater Treatment Plants

Yes	No	N/A	Do all have appropriate certifications and periodic training?
Yes	No	N/A	Do all personnel certifications meet or exceed required levels?
Yes	No	N/A	How many are below the required level?
Yes	No	N/A	Is staffing level equal to or does it exceed O&M Manual recommendations?
Yes	No	N/A	2 What percentage of the wastewater budget is dedicated for training?
H. FINANCIAL			
Yes	No	N/A	1. Are the funds for the plant separate from other municipal funds?
Yes	No	N/A	2. Are funds sufficient for adequate operations?
Yes	No	N/A	3. Are funds sufficient for adequate preventive maintenance?
Yes	No	N/A	4. Are funds available for necessary improvements, expansion?
Yes	No	N/A	5. Is there a capital improvement fund?
Yes	No	N/A	6. Is the equipment replacement fund in a segregated account?
Yes	No	N/A	7. What financial resources are available to pay for improvements/expansion/reconstruction?
I. MUNICIPAL POLLUTION PREVENTION PROJECTS			
Yes	No	N/A	1. Does the plant have a pollution prevention program or strategy?
Yes	No	N/A	2. Has the plant conducted a self-audit on the adequacy of its maintenance, operation, funding, and operator training?
Yes	No	N/A	3. Does the pretreatment program include a pollution prevention component or specific pollution prevention projects?
Yes	No	N/A	4. Does the municipality have any pollution prevention projects aimed at reducing toxic/hazardous waste discharges, conventional loadings, or flow (e.g., water conservation) from:
Yes	No	N/A	Households?
Yes	No	N/A	Commercial businesses?
Yes	No	N/A	Industries?

CHAPTER 18 – MULTIMEDIA CONCERNS

Contents

A. Introduction	496
B. Overview of the Multimedia Approach to Inspections	496
C. Multimedia Concerns at NPDES Facilities and the Multimedia Screening Program.....	498
Hazardous Waste.....	498
Hazardous Waste Cleanup Actions Under RCRA/CERCLA	499
Nonhazardous Sludge.....	499
Air	500
Multimedia Screening	500
D. NPDES Inspectors and Multimedia Inspections	501
Description of a Multimedia Inspection.....	501
The NPDES Inspector's Role in a Multimedia Inspection	502
E. References.....	503

Associated Appendices

- AQ. Media-Specific Inspection Components
- AR. National Multimedia Screening Inspection Worksheet

A. INTRODUCTION

This chapter is intended as a guide for National Pollutant Discharge Elimination System (NPDES) inspectors who conduct single media and/or multimedia compliance inspections. Inspections help determine a facility's status of compliance with applicable laws, regulations, and permits for one media or multimedia. Specifically, multimedia compliance investigations determine a facility's compliance status in more than one media. NPDES inspectors should be familiar with multiple regulatory programs in order to identify other potential environmental violations during a multimedia inspection. Additionally, the inspector should be able to identify possible media-related concerns on inspections that are not necessarily targeted towards multimedia compliance.

This chapter and Appendix AQ, "Media-Specific Inspection Components," include a significant amount of material drawn directly from the National Enforcement Investigations Center's (NEIC's) *Multimedia Investigation Manual* (EPA, 1992) and EPA's *Process-Based Inspections Guide* (EPA, 1997). NPDES inspectors participating in multimedia inspections should refer to these documents for further guidance.

Additional training available for each media is listed in the EPA Order 3500.1 Program-Specific Training Requirements, which is included as Appendix A.

B. OVERVIEW OF THE MULTIMEDIA APPROACH TO INSPECTIONS

Most inspections can be grouped into four categories of increasing complexity, moving from Category A (program-specific compliance inspections) to Category D (complex multimedia investigations) depending upon the complexity of the facility and the objectives of the investigation. The four general categories of investigations are described below:

- Category A: Program-specific compliance inspections conducted by one or more inspectors. The objective is to determine facility compliance status for regulations specific to a single program, such as NPDES program requirements.
- Category B: Program-specific compliance inspections conducted by one or more inspectors in which the inspector(s) screen for and report on obvious, key indicators of possible noncompliance in multiple program areas. For example, an inspection may be aimed at determining compliance with NPDES program requirements, but screening for indicators of possible noncompliance for both NPDES and FIFRA requirements is performed.
- Category C: Several concurrent and coordinated program-specific compliance investigations conducted by a team of investigators representing two or more environmental and/or statutory program offices. The team, which is headed by a team leader, conducts a detailed compliance evaluation for each of the target programs. Category C inspections entail a more detailed compliance evaluation of each

target program than the general screening-level evaluation performed in a Category B inspection. The objective is to determine compliance for several targeted program-specific areas. Reports on obvious, key indicators of possible noncompliance in other environmental program areas are also made.

Category D: Comprehensive facility multimedia evaluations that not only address compliance in targeted program-specific regulations, but also try to identify environmental problems that might otherwise be overlooked. The initial focus is normally on facility processes to identify potentially regulated activities (e.g., new chemical manufacturing from raw material management through final manufacturing and processing) and byproducts/wastestreams generated, especially those that may not have been accurately reported to the regulators. When potentially regulated activities or wastestreams are identified, a compliance evaluation is made with respect to applicable requirements and subsequent compliance status. Special attention is often given to pollutants that “change media” (such as air pollutants that are scrubbed into wastewaters).

The investigation team, headed by a team leader, comprises staff thoroughly trained in different program areas. The on-site investigation is conducted during one or more site visits and involves intense concurrent program-specific compliance evaluations, often by the same cross-trained personnel.

Category D multimedia investigations are thorough and, consequently, resource intensive. They are appropriate for intermediate-to-large, complex facilities that are subject to a variety of environmental laws. Compliance determinations are made for several program-specific areas, and reports on possible noncompliance are prepared, based on the evaluation of the facility’s activities and wastestreams

Generally, all investigations will include pre-inspection planning, use of a project plan, sampling, inspection procedures, and a final report. The major difference will be in the number of different regulations addressed during Categories C and D investigations.

The multimedia approach to investigations has advantages over program-specific inspections. Multimedia inspections provide:

- A more comprehensive assessment of a facility's compliance status.
- Improved leveraging of compliance monitoring and enforcement resources.
- The ability to respond more effectively to cross-media complaints, issues, or needs and to develop a better understanding of cross-media problems and issues, such as waste minimization.
- The ability to conserve resources and yield more thorough results than numerous single media investigations.

- A higher probability of identifying cross-media issues, such as pollutants that can be “lost” as they change media.
- The opportunity to identify weaknesses in a facility’s Environmental Management Systems.
- Larger facility impact, which may enhance deterrent effect on facility corporate management.

The success of a multimedia investigation program is contingent upon a good managerial system and the support of upper management. Since these investigations will often be conducted at larger facilities, adequate resources (time and personnel) must be provided. Good communication among all team members during the planning phase is essential to define the scope of the inspection, as well as each team member's role. Communications could also include state officials since state inspectors might also participate as team members. Because of the extent of the state's knowledge of the facility and its problems, state involvement is often critical to the success of the investigation. Similarly, coordination with other federal or local agencies needs to be addressed, as necessary.

C. MULTIMEDIA CONCERNS AT NPDES FACILITIES AND THE MULTIMEDIA SCREENING PROGRAM

HAZARDOUS WASTE

Many NPDES-regulated facilities are also subject to requirements of the Resource Conservation and Recovery Act (RCRA). RCRA regulates the generation, transportation, treatment, storage, and disposal of hazardous wastes. NPDES permit writers and inspectors may learn whether the facility conducts RCRA regulated activities, and the nature of those activities, from state or EPA RCRA authorities, data platforms such as EPA’s Enforcement and Compliance History Online (ECHO), or while discussing facility industrial processes during the initial stages of a compliance investigation.

Industrial facilities can use or generate solid, liquid, or gaseous hazardous waste. These wastes may be generated from raw materials, off-specification products, or residuals or emissions from the process operations. In addition, waste oils used by process equipment, solvents used in cleaning operations, or sludges from treatment of process wastewaters can be hazardous wastes.

RCRA defers the control of hazardous wastes to the Clean Water Act (CWA) when those wastes are either directly discharged to surface waters under an NPDES permit (the direct discharge exclusion) or indirectly discharged to a wastewater treatment plant (the domestic sewage exclusion). Industrial facilities may use the direct discharge and domestic sewage exclusions as preferred disposal methods. Since many of the 126 priority pollutants listed in the CWA would be considered hazardous waste constituents under RCRA, the discharge of these pollutants should concern the inspectors and operators of wastewater treatment plants. Potential RCRA issues to consider in a NPDES inspection include:

- Hazardous wastes may pass through to surface waters unless incidentally removed in sludge, degraded, or "lost" through volatilization or exfiltration during the wastewater collection and treatment process.
- The Universal Treatment Standards under the Land Disposal Restrictions help determine when a hazardous waste has been treated sufficiently for land disposal.
- The RCRA waste may inhibit or reduce the effectiveness of the wastewater treatment processes potentially resulting in lower quality effluent discharges.
- RCRA-regulated hazardous wastes introduced into wastewater treatment facilities with surface impoundments could cause groundwater contamination issues.
- Sludges resulting from the treatment of a hazardous waste may become a regulated waste under RCRA.

Publicly Owned Treatment Works (POTWs) receiving hazardous wastes by truck, rail, or dedicated pipeline are subject to RCRA permit by rule requirements. If the material does not pass through a sewer system prior to arriving at a POTW, it is deemed to be a solid waste and, if appropriate, a hazardous waste. Consequently, POTWs that manage wastes that have not passed through the sewer system and mixed with domestic sewage would be subject to all applicable hazardous waste regulations. Included among these requirements is the provision that corrective action must be taken to remedy any contamination that may have resulted from a release of hazardous waste or hazardous constituents from solid waste management units, such as surface impoundments, to the environment. For example, if a POTW that is subject to these RCRA requirements contaminates groundwater through leaching or exfiltration, the permittee might be required to investigate the nature and extent of those releases and, where appropriate, implement corrective measures.

HAZARDOUS WASTE CLEANUP ACTIONS UNDER RCRA/CERCLA

Another source of contaminated wastewater is hazardous waste cleanup actions. Under RCRA and the Comprehensive Environmental Response, Compensation, and Liability Act (CERCLA), EPA, states, and private parties remediate contaminated sites. Much of the waste found at these sites is in liquid form, either as leachate or contaminated groundwater. The treatment of contaminated wastewaters from these sources will likely generate complex mixtures, requiring careful examination of their composition to determine appropriate treatment and disposal techniques.

NONHAZARDOUS SLUDGE

Wastewater treatment generates nonhazardous sludges. Several statutes and regulations, including the CWA, are charged with managing these nonhazardous sludges. NPDES and state permits include disposal limitations for municipal sewage sludge as specified in Title 40 of the *Code of Federal Regulations* (CFR) Part 503 (see Chapter 10 for detailed information on the 40 CFR Part 503 requirements). Many states already impose such requirements. NPDES inspectors should become familiar with state sewage sludge requirements and federal sewage sludge management and disposal requirements under the CWA and those imposed by other statutes

and regulations, particularly RCRA and the Clean Air Act (CAA). For example, the CAA controls air emissions from co-incinerating municipal sewage sludge with other wastes. Municipal sewage sludge that is co-disposed with other waste in a municipal solid waste landfill is regulated by 40 CFR Part 258. Industrial sludges are regulated by 40 CFR Part 257 if land applied and by 40 CFR Part 258 if disposed of in a nonhazardous landfill.

AIR

Air emissions from wastewater treatment units may be subject to CAA regulations. For some industries (e.g., synthetic organic chemical manufacturing industry (SOCMI), petroleum refineries), EPA has developed CAA regulations that limit the amount of volatile hazardous air pollutants that can be contained in process wastewaters. The purpose of these regulations is to minimize the amount of pollutants transferred from wastewater to the atmosphere through volatilization. In general, facilities are required to treat wastewater streams that contain volatile hazardous air pollutants before the streams are exposed to the atmosphere. It is important to be aware of what chemical constituents are in the wastewater and what impact this may have on a facility's compliance with CAA regulations. Air emissions from authorized RCRA Treatment, Storage, and Disposal Facilities (TSDFs) are regulated under RCRA. As a result, wastewater treatment facilities at RCRA TSDFs are now being investigated by RCRA program personnel. In addition, EPA's Greenhouse Gas Reporting Program requires certain wastewater treatment plants to submit annual greenhouse gas (GHG) emissions reports. The GHG Reporting Program impacts suppliers of certain products that would result in GHG emissions if released, combusted or oxidized; direct emitting source categories; and facilities that inject CO₂ underground for geologic sequestration or any purpose other than geologic sequestration. Facilities that emit 25,000 metric tons or more per year of GHGs are required to submit annual reports to EPA. Information about the GHG Reporting Program and covered reporters can be found at <https://www.epa.gov/ghgreporting/ghg-reporters>.

Additionally, it is important to investigate use of air pollution control devices or other waste management activities that remove pollutants from one media (such as air) but generate a wastewater stream. These wastewaters may not have been accurately reported in CWA permit applications and may not be properly managed.

MULTIMEDIA SCREENING

Regions and states are encouraged to incorporate multimedia screening into as many single media inspections as possible (i.e., conduct Category B inspections in lieu of Category A inspections). Obtaining multimedia screening information earlier in the process will help leverage inspection resources and ensure that all noncompliance issues are included in any facility-specific compliance status evaluation strategy. The compliance inspector will use a multimedia screening checklist as a guide for making and recording observations and pertinent information.

The Environmental Services Division Field Branch Chiefs and NEIC have led the development and implementation of EPA's multimedia inspection program, including screening inspections. The National Multimedia Screening Inspection Worksheet, dated May 12, 1993, was developed

as a general guideline by a regional work group led by Region 3. A copy of this worksheet is included in Appendix AR, "National Multimedia Screening Inspection Worksheet." Regions and states have adapted and customized checklists such as this for their own use.

D. NPDES INSPECTORS AND MULTIMEDIA INSPECTIONS

DESCRIPTION OF A MULTIMEDIA INSPECTION

The strategy developed for multimedia inspections usually involves prioritizing the processes and waste management activities, followed by systematically moving from the beginning to the end of a process with emphasis on regulated wastestream generation and final wastestream management and disposition. The strategy should be somewhat flexible so that "mid-course corrections" can be made.

The compliance evaluations for each media should be coordinated among all the investigators and scheduled to make the most effective use of the inspector's on-site time and facility contact resources. This schedule should provide an approximate schedule for each media investigator to review documents, interview facility personnel, conduct on-site observations, and conduct sampling as appropriate. This schedule must be flexible and may be modified throughout the on-site investigation to effectively use the limited available time. Daily meetings between team members to discuss progress and needs are recommended to help modify this schedule to meet the team and the facility personnel needs. Personnel availability and other logistical factors may result in a combining of compliance evaluations. RCRA issues may be evaluated concurrently with NPDES requirements because of the close relationship between process evaluations and wastewater generation and disposal requirements. Compliance with regulatory programs that principally involve records reviews, such as the Toxic Substances Control Act (TSCA), Emergency Planning and Community Right to Know Act (EPCRA), and CAA could be scheduled later in the inspection, as time permits.

The strategy for process and compliance evaluations should be developed by the inspection team coordinator and discussed with inspection team members. This will serve as the basis for explaining inspection activities and scheduling to the company during the opening conference.

The strategy should include checklists that address potential process wastestreams to be examined and help identify media-specific compliance issues. Checklists can be a vital component of a compliance investigation to help ensure that an investigator does not overlook anything important. Checklists serve as a reminder of what needs to be asked or examined and provide the basic regulatory requirements. However, checklists should not be a replacement for observations, curiosity, and common sense.

In larger facilities, multiple site visits coordinated by the team leader may be necessary and desirable for completing the inspection and following up on issues identified during earlier site visits. This approach can lead to a better overall site compliance determination inspection because of the opportunity to thoroughly review the information obtained during the inspection upon return to the office, refine the inspection strategy to fill in the gaps and resolve questions, and conduct a subsequent site visit to obtain the required information.

THE NPDES INSPECTOR'S ROLE IN A MULTIMEDIA INSPECTION

Each multimedia investigation team member should bring special program expertise and experience and must be trained in conducting a field investigation, including sampling. Most of the investigators on the team, including the team leader, should be current field investigators who already possess most of the necessary skills and qualifications. EPA Order 3500.1 sets forth specific training requirements for any EPA investigator who is leading a single media investigation. These training requirements include both general inspection procedures and media-specific procedures. While an individual leading a multimedia investigation may not have had the media-specific training for each media covered during that multimedia investigation, the team leader should have completed media-specific training for at least two of the media. At least one team member should be trained in each area that is to be addressed in the multimedia inspection.

The team leader has the overall responsibility for the successful completion of the multimedia investigation. In addition, other investigators may be designated as leads for each of the specific media/programs that will be addressed. These individuals may work alone or have one or more inspectors/samplers as assistants, depending on workload and objectives. However, all investigation team members should report directly to, and be accountable to, the team leader.

The following are some of the more important skills and qualifications that are necessary for team members:

- Ability to work effectively as a member of a diverse team.
- Knowledge of the EPA's policies and procedures regarding inspection authority, entry procedures/problems, enforcement actions, legal issues, and safety.
- Thorough understanding of sampling equipment; quality assurance (QA) requirements for sample collection, identification, and preservation; and chain-of-custody procedures.
- Knowledge of manufacturing/waste producing processes, pollution control technology, principles of waste management, flow measurement theory and procedures, and waste monitoring techniques/equipment.
- Investigation skills including the ability to gather evidence through good interviewing techniques and astute observations.
- Ability to convey information gathered during the inspection into clear, understandable investigation reports.
- Up-to-date experience in conducting compliance inspections.
- Good communication skills.
- Basic understanding of the procedures of obtaining administrative warrants, including preparation of affidavits, technical content of the warrant application, and warrant and procedures for serving a warrant.

- At least one team member should have considerable knowledge of laboratory standard operating procedures (SOPs), analytical test methods, and QA requirements, if a laboratory evaluation is to be conducted.

Investigators should conduct themselves in a professional manner and maintain credibility. A cooperative spirit should be cultivated within the inspection team and with facility representatives, including conducting on-site activities during normal working hours of the facility, as much as possible. Inspection team members should discuss their observations/findings relating to one or more programs with each other. The investigation team should also implement appropriate documentation procedures as described in Chapter 2. Investigators must ensure that important documents (e.g., project plan, safety plan, and logbooks) are not left unattended at the facility and sensitive discussions should not take place in front of facility personnel or on company telephones.

E. REFERENCES

The following is a list of resources providing additional information on multimedia.

- U.S. Environmental Protection Agency. (1992). *Multimedia Investigation Manual*. EPA-330/9-89-003-R. National Enforcement Investigations Center (NEIC).
- U.S. Environmental Protection Agency. (1997). *Process-Based Investigations Guide*. EPA-330/9-97-001.
- U.S. Environmental Protection Agency. (2016). *Best Practices for NPDES Permit Writers and Pretreatment Coordinators to Address Toxic and Hazardous Chemical Discharges to POTWs*. EPA-830-B-16-001.

CHAPTER 19 – APPEARING AS A WITNESS

Contents

A. Introduction	506
B. Pre-Testimony Matters	506
Preparation.....	506
Legal Etiquette, Appearance, and Demeanor	507
C. Giving Testimony	508
General Considerations.....	508
Pre-Trial Testimony: Depositions	509
Trial Testimony: Direct Examination	509
Trial Testimony: Cross-Examination	510
D. Special Considerations	511
Technical Testimony.....	511
Expert Witness.....	512

A. INTRODUCTION

Inspectors perform a vital role throughout the regulatory enforcement process. An enforcement action begins with the inspector collecting and documenting on-site evidence. This chapter deals with the inspector's responsibility to present evidence in formal legal proceedings.

Due in large part to the high-quality work that inspectors produce, EPA files strong cases. Nearly all these cases result in out-of-court settlements that will not usually require the inspector's testimony. Of the cases that do not settle, a substantial majority of the legal actions take place in the EPA administrative law system rather than in federal courts. Major differences distinguish administrative from federal courts, such as rapid processing and the absence of a jury. Despite the differences between these two legal proceedings, the inspector's role as a witness will remain predominantly the same.

Under most circumstances an inspector will be called as a "fact witness." A fact witness describes personal knowledge obtained through one of the five senses. Throughout the enforcement process, everything an inspector hears, sees, samples, or records may become evidence about which he or she may be questioned. Many cases are tried years after the field and laboratory activities have been conducted. Thus, the inspection report and field notebook should be sufficiently detailed and legible to allow the inspector to reconstruct the inspection "on the record."

B. PRE-TESTIMONY MATTERS

PREPARATION

Preparation is the key to giving accurate and effective testimony. Successful preparation requires a substantial time commitment. Attorneys and witnesses work together in two types of preparation: factual and procedural.

The inspector will complete most of the factual preparation by writing the inspection report as described in this manual. The witness and the attorney will meet to discuss details from this report. Other items should also be discussed, including the field notebook, photographs, and the inspector's qualifications. Qualifications include the inspector's educational degree, professional accreditations, inspector training as required by EPA Order 3500.1, and on the job experience. The inspector's qualifications must never be exaggerated. Even a small exaggeration may cause the inspector's testimony to lack credibility.

The inspector should inform the EPA attorney of any problems, questions, or concerns regarding the case as early as possible. An example of one such concern is the confidential business information (CBI) procedures inspectors must adhere to. CBI procedures that bind inspectors during inspections also have implications for the legal proceeding.

The attorney has primary responsibility over procedural preparation, which includes assembling the facts for presentation in a formal legal setting. In addition to one-on-one preparation, the

attorney may consider whether the inspector should participate in a mock trial or visit a hearing to observe other witnesses' testimony. During one-on-one preparation, the attorney and the inspector should discuss:

- Times and dates that require the inspector's attendance
- Legal etiquette and procedure
- General legal framework of the case
- Significance of the inspector's testimony in this framework
- Probable areas of questioning, including direct and cross-examination
- What documents, if any, will be used by the inspector during testimony

Before giving testimony, the witness should review inspection documents, his or her professional qualifications, and information provided by the attorney. This review should be repeated until the witness has thoroughly refreshed himself of the details of the facts relating to the case. Testimony should appear genuine, not contrived as if a script were being followed. Additionally, the attorney should prepare the witness as if he is testifying in court before the witness testifies in court. The witness may ask the attorney to prepare a mock trial to better understand and be comfortable with the process before the actual trial.

An inspector may be subpoenaed to give testimony by the opposing attorney or even by the EPA attorney. A subpoena is a mandatory Court Order to appear in court if an inspector is subpoenaed, the appropriate EPA attorney should be contacted immediately. Time will be short to prepare to give testimony or to respond to the subpoena.

LEGAL ETIQUETTE, APPEARANCE, AND DEMEANOR

A witness's conduct should reflect the solemn nature of the administrative or judicial proceeding. To act in accordance with required legal etiquette, a witness should:

- Dress conservatively following the advice of the EPA attorney.
- Arrive early and be available immediately when called to testify.
- Address the judge as "your honor."
- Treat an administrative proceeding as seriously as a federal court trial.

A witness should **not**:

- Whisper, talk, or make jokes in the hearing room. If necessary, a note may be passed.
- Bring magazines or newspapers into the hearing room.
- Discuss the case within earshot of anyone but the EPA attorney.

Posture, speech, appearance and attitude influence a witness's credibility. An inspector is a professional who collects, preserves, and presents evidence. To convey a professional demeanor, an inspector should:

- Respectfully respond to questions posed by the opposing attorney on cross-examination.
- Remain natural and animated, but not impatient or overly anxious to testify.
- Minimize nervous tendencies.
- Remain calm.
- Refrain from showing hostility toward the opposing counsel, the specific defendant, or the regulated community as a whole.

C. GIVING TESTIMONY

GENERAL CONSIDERATIONS

A witness gives testimony to create a legal record of the facts. Before giving testimony, a witness will take an oath that he or she will tell the truth. Failure to tell the truth is actionable as perjury. A witness may give pre-trial testimony in a deposition or trial testimony under direct examination or cross-examination.

To give effective testimony, a witness should 1) listen, 2) pause, and then 3) answer if possible. Listening carefully to the wording and implications of an attorney's questions requires significant effort. If the witness does not understand the question, he or she should stop to think, ask to have the question repeated, or ask to have the questions clarified or explained.

A witness should pause before answering. Pausing provides time to think, makes the response more considered and deliberate, and gives the attorney time to object if necessary. When pausing, the witness should not use words such as "um." These types of words may incorrectly indicate hesitation when later read from the written record.

When answering, a witness should:

- Reply with a "Yes" or "No" when appropriate.
- Speak in complete sentences when answering more fully.
- Be as descriptive as possible in referring to exhibits or photographs. For example, "In the upper right hand corner, we see..." rather than "Here, we see..."
- Stop immediately if the judge or either of the lawyers begins to speak.
- Avoid memorizing answers to potential questions.
- Never manipulate an answer to benefit one side.

A witness's credibility is defined as the degree of confidence that the judge or jury gives to the witness's testimony. The opposing attorney will try to "impeach" a witness's credibility by suggesting the following: bias, inaccuracy, inability to recollect, false testimony, or even corruption. To minimize the opposing attorney's efforts to discredit the witness's testimony, the witness should:

- Always tell the truth.
- Answer only the question asked, without volunteering additional information.

- Explain answers fully. If the opposing attorney does not allow a full explanation, the EPA attorney can choose to give the witness an opportunity to explain the answer fully on redirect examination.
- Answer within the limits of the facts.
- Don't hesitate to say, "I don't know," or "I don't remember," if that is the case.
- Correct any mistakes in the testimony as soon as mistakes are identified.
- Carefully identify estimates.
- Never exaggerate.
- Never guess.
- Avoid absolutes, like "I always..." or "I never..."

PRE-TRIAL TESTIMONY: DEPOSITIONS

In a federal court trial, an inspector may be subpoenaed to give a deposition, which is pre-trial questioning under oath by the opposing attorney. Depositions are not often conducted in administrative hearings. Participants include the attorneys for each side, a court reporter, and the witness. Most importantly, a judge will have no role in deposition testimony unless one side abuses the process and the other side seeks relief.

The attorney may use a deposition to "discover" information or to contradict a witness's testimony at trial. In most cases, deposition testimony cannot be used as a substitute for live testimony. To properly prepare for and give deposition testimony, an inspector should:

- Read the notice of deposition.
- Consult with the EPA attorney to determine what preparation and review of documentation will be necessary.
- Realize that he or she is not "off the record" until completely away from the deposition setting.
- Request a break whenever needed.

After the deposition is transcribed, the witness can read it to make any appropriate corrections. Small errors always exist, but some transcripts contain absolute disasters. Errors in technical details, such as numbers and units, can have a large impact. A witness should never waive the right to read and sign the finished deposition.

TRIAL TESTIMONY: DIRECT EXAMINATION

The EPA attorney will question the inspector during direct examination to put the facts known by the inspector on the record in a well-organized and logical manner.

A good direct examination leads the inspector through his or her entire testimony using a dialogue of short questions and answers. The attorney is responsible for asking appropriate questions in the correct order and ensuring that nothing important is omitted. The witness is only responsible for answering the attorney's questions completely and truthfully.

To avoid legally objectionable or tactically unwise remarks, the witness should trust the EPA attorney's final decision concerning what questions to ask at the hearing. The attorney's reasoning behind the questioning may be limited, but the witness should trust that the attorney is asking the questions necessary to convey the story behind the violations. If the inspector has forgotten a fact, the attorney may refresh the inspector's recollection with documents, such as the inspection report. The EPA attorney might also ask, "Is there anything else?" to signal to the inspector that something has been left out.

Redirect examination is a round of questioning only concerning issues raised during cross-examination. Redirect will give the EPA attorney an opportunity to reduce any damage done to the credibility of the inspector's testimony during cross-examination.

TRIAL TESTIMONY: CROSS-EXAMINATION

Cross-examination, questioning by the opposing attorney, will subject the witness to a more difficult interrogation than direct examination. The opposing attorney will try to cast doubt on the credibility of the witness's testimony. Many witnesses fear counsel techniques such as leading questioning and twisting interpretation. The EPA attorney will try to protect the witness from abusive uses of these techniques.

The witness can also protect the credibility of his or her testimony by 1) answering briefly, 2) answering accurately, and 3) remaining calm. Answering briefly consists of being responsive to the question, but not volunteering extra information. Avoid rambling, even if the opposing counsel remains silent.

In addition to the recommendations in the section "Giving Testimony," answering accurately requires listening carefully for the following types of questions:

- Questions that inaccurately paraphrase the witness's previous testimony. The error should be corrected or the previous answer restated in full.
- Hypothetical questions or questions requiring a "Yes" or "No" answer. If these questions may compel a misleading or incomplete answer, the witness should explain the answer fully at that time or later during redirect if cut short by the opposing attorney.
- Two-part questions. The inspector should ask the attorney to restate the question or carefully answer each part separately.

Even when a witness's truthfulness, occupational competence, or professional conclusions are challenged, he or she should remain calm. An angry, sarcastic, or argumentative answer is inconsistent with the inspector's role as a neutral government witness. Remaining calm will add credibility to the inspector's testimony. Becoming familiar with the process, including participation in a mock trial can help reduce the stress of cross-examination.

D. SPECIAL CONSIDERATIONS

TECHNICAL TESTIMONY

An inspector frequently presents technical facts. The inspector must balance the need to be technically accurate with the need to reduce scientific issues to simple terms and concepts.

The first barrier to communicating technical information is the use of jargon. The inspector should prepare carefully to simplify his or her language without over-simplifying the scientific concepts. The inspector should:

- Speak as clearly as possible. The court reporter may have difficulty recognizing numbers and unfamiliar technical terms.
- Ask your attorney to provide a glossary of technical terms, including acronyms, to the court reporter.
- Review the meaning of frequently used acronyms, such as explaining that “OECA” is an acronym for “the Office of Enforcement and Compliance Assurance.”

Even after the witness explains the definitions of the technical language, the underlying concepts may still be difficult to understand. To teach the necessary technical concepts, the inspector and attorney should consider using:

- Short answers in a logical progression of questions
- Well-paced questioning to avoid information overload
- Diagrams and pictures
- Appropriate analogies

Finally, the inspector should not try to outdo the opposing attorney on technical issues. Not only may the inspector confuse the judge or jury in the process, but also a well-prepared attorney will have thoroughly studied the subject before trial and will have a large advantage in legal debate. Inspectors should walk the judge or jury through a technical analysis using plain language and help them understand why EPA needs to take a particular action to protect public health or collect economic benefit to discourage further violations.

To successfully answer questions regarding technical information, an inspector should:

- Examine questions and answers for assumptions and exceptions.
- Look for inaccurate paraphrasing of the inspector’s previous testimony and politely correct them. An opposing attorney may try to restate your testimony with an inaccurate perspective to benefit the defendant.
- Always identify estimates.
- Use references in cases of complicated details. For example, the inspection report could be consulted before testifying about the characteristics of a specific sample.

EXPERT WITNESS

Expert witnesses give opinions on the record. An expert witness has technical or other specialized knowledge that helps the judge or jury better understand the case. To prove a witness' expertise, his or her qualifications are introduced by one side and cross-examined by the other side. Only those opinions that the witness is qualified to express through special training or expertise will be admissible.

An expert is not necessarily someone from outside the agency with particular academic or research credentials. Due to the inspector's professional expertise, he or she might be asked specific questions that require an opinion or might even be called as an expert witness. The EPA attorney will object if the opposing counsel asks inappropriate questions and will decide whether to use the inspector as an expert witness. The inspector should stay carefully within his or her limits of expertise and knowledge whenever asked a question requiring an opinion.

Appendix A –
EPA Order 3500.1, Training and Development for
Individuals who lead Compliance
Inspections/Field Investigations



Classification No.: 3500.1

Approval Date: 06/19/2014

TRAINING REQUIREMENTS FOR EPA PERSONNEL WHO ARE AUTHORIZED TO CONDUCT CIVIL COMPLIANCE INSPECTIONS/FIELD INVESTIGATIONS AND EPA INSPECTOR SUPERVISORS

1. **PURPOSE.** This order establishes minimum training requirements for U. S. Environmental Protection Agency employees to obtain and maintain the EPA authorization to conduct civil compliance inspections/field investigations or collect compliance samples under federal environmental statutes. It also addresses the inclusion of certain requirements in agency administered contracts and Senior Environmental Employment Program cooperative agreements if individuals are to be authorized to conduct inspections on behalf of the agency. This order also requires that first-line supervisors of compliance inspectors/field investigators complete minimum training. Finally, Item 3 of this order references state and tribal inspector training and credential issuance requirements.
2. **POLICY.** Prior to conducting environmental compliance inspections/field investigations, individuals must complete training as required by Item 4 of this order; in addition, the decision as to whether it is appropriate to issue a credential to the individual resides with the individual's supervisor, and is based on the supervisor's assessment of the employee's ability to conduct inspections and represent the agency. Supervisors of compliance inspectors/field investigators and compliance sampling specialists must complete and document completion of training requirements, even if they do not receive a credential or conduct compliance inspections/field investigations.
3. **APPLICABILITY.** This order applies to all agency personnel who are authorized or seeking authorization to conduct civil compliance inspections/field investigations or to collect compliance samples under any of the agency's statutes and their supervisors; in addition, the order requires that assistant administrators and regional administrators are responsible for ensuring that the training requirements found in Item 4 of this order are met by the agency employees affected by this order. All agency administered contract statements of work and SEE program cooperative agreements, which govern the activities of contractor employees and SEE enrollees conducting compliance

inspections or civil investigations. Training requirements for employees of state and tribal governments who are authorized to conduct compliance inspections/field investigations on behalf of the agency are established in the agency's *Guidance for Issuing Federal EPA Inspector Credentials to Authorize Employees of State/Tribal Governments to Conduct Inspections on Behalf of EPA* issued September 30, 2004 and any subsequent updates. This order does not apply to credentials issued by the Office of Inspector General, or those issued to agency criminal investigators/special agents.

4. **TRAINING REQUIREMENTS.** The agency's training program for persons being authorized to conduct compliance inspections/field investigations consists of four parts: occupational health and safety curriculum, basic inspector curriculum, program-specific curriculum and annual refresher course requirements. Note: For agency employees seeking authorization as compliance sampling specialists, abbreviated training requirements are defined in the memorandum entitled *Guidance for Documenting Required Inspector Training for EPA Employees Prior to Issuing Credentials (pursuant to EPA Order 3500.1 and 3510) If Training Certificates Are Not Available* issued by Lisa Lund, Director, Office of Compliance, on December 2, 2009.
 - a. **Occupational health & safety curriculum:** All agency employees are required to complete applicable occupational health and safety training as required by Order 1440.2, *Safety and Health Environmental Management Guidelines* 51 and 56, and associated guidance²² before engaging in any field activities. The agency's Safety, Health and Environmental Management Program defined in Order 1440.1, establishes basic, intermediate, advanced and refresher level training requirements for compliance inspectors/field investigators in its directives and guidelines. Note: Separate from this training requirement, Order 1440.2 requires occupational medical monitoring for certain field activities.
 - b. **Basic inspector curriculum:** This training provides a comprehensive overview of the knowledge and skills needed to conduct compliance inspections/field investigations under agency statutes. It consists of the basic inspector-training course, which integrates legal, technical, and administrative subjects with communication skills. The basic inspector curriculum also includes a requirement for reading and being aware of compliance monitoring policies that apply to all individuals who conduct inspections/field investigations including Department of Transportation Hazardous Materials Training Requirements, Small Business Regulatory Enforcement Fairness Act information sheet requirements, routine agricultural biosecurity procedures and training on data collection and reporting procedures and regional quality assurance plans.

²² Flexibility in the requirements of Order 1440.2 can be found in the July 19, 2009 memorandum from Howard O. Wilson to Phyllis Flaherty entitled "Safety and Health Training Requirements for EPA Compliance Inspectors and Field Investigators" and the December 4, 2009 memorandum from Wesley J. Carpenter to Phyllis Flaherty entitled "Update on Safety and Health Training Requirements." For more information, see the agency's [Safety, Health, and Environmental Management website](#).

- c. Program-specific curriculum: This curriculum establishes the required and recommended training in legal, programmatic and technical subjects for each major media program or specific program compliance inspection/field investigation activity. If the program-specific curriculum for each major media program or specific program compliance inspection/field investigation activity is not specified, e.g., new statutes, then a minimum of 24 hours of appropriate and relevant program-specific training and completion of a minimum of two (8 hour) days of on-the-job training or two compliance inspections/field investigations (whichever is longer) must be completed. The supervisor shall determine the appropriateness and relevance of the training based on the type and nature of work to be performed. Additional program-specific specialized training is recommended to further develop inspection skills.
- d. Refresher course requirements: All individuals who are authorized to conduct compliance inspections/field investigations on behalf of the agency (which may include first-line supervisors or team leaders) must complete annual refresher training as follows:
 - i. Occupational health and safety training as established by SHEMP. Existing requirements include a minimum of eight hours of refresher hours annually for compliance inspectors/field investigators, as found in SHEMP directives and guidelines;
 - ii. Basic inspector and program-specific curriculum identified by first-line supervisors as relevant to their compliance inspectors/field investigators and training identified in the mandatory refresher training section for each media; and
 - iii. Additional training identified by first-line supervisors to improve proficiency in specialized areas. This includes training necessary for the inspector to become more proficient in a specific media program, qualified in additional regulations, qualified for inspecting additional industries or to become proficient in multi-media work.
- e. Exceptions to the training requirement:
 - i. Occupational health & safety courses: Any exceptions to the required occupational health and safety curriculum must be in accordance with SHEMP requirements.
 - ii. Basic inspector and program-specific curricula: Any exceptions to the basic inspector or program-specific curricula must be approved in writing by the appropriate assistant administrator or regional administrator based on an evaluation by the first-line supervisor or team leader of the compliance inspector/field investigator's knowledge, experience and relevant training. Exceptions should be given only in unusual circumstances, and copies of the approval should be maintained.

5. **RESPONSIBILITIES.** This section lists the primary responsibilities for implementing this order.
- a. **Compliance inspectors/field investigators:** Any individuals who are authorized or seeking authorization to conduct compliance inspections/field investigations on a full or part-time basis are responsible for:
 - i. Completing all applicable training listed in Item 4 of this order before applying for a new or renewal credential, or conducting an inspection in a specific media. (Note: The process for applying for and issuing credentials is detailed in Order 3510: *EPA Federal Credentials for Inspections and Enforcement of Federal Environmental Statutes.*) Prior completion of on-the-job training is not required to apply for an inspector-in-training credential (agency employees only) or a Temporary Letter of Authorization. Individuals who have not completed the media specific training for the specific program under which a compliance inspection/field investigation is being conducted and who are using an inspector-in-training credential or Temporary Letters of Authorization must be accompanied by a credentialed inspector who has completed the required training for the program under which they will be conducting their compliance inspection/field investigation;
 - ii. Providing documentation to their first-line supervisor of completion of relevant training, including dates completed;
 - iii. As needed, assisting in the preparation of an individual development plan or other training plan, which addresses training necessary to continue to meet the requirements of this order; and
 - iv. Applying and maintaining the knowledge, skills, and techniques acquired through training to ensure that compliance inspections/field investigations are accomplished in a technically and legally sound manner.
 - b. **Compliance sampling personnel:** Any individuals who are authorized or seeking authorization to collect samples during a compliance inspection/field investigation are responsible for:
 - i. Completing all applicable training for compliance sampling personnel as defined in the memorandum entitled *Guidance for Documenting Required Inspector Training for EPA Employees Prior to Issuing Credentials (pursuant to Order 3500.1 and 3510) If Training Certificates Are Not Available* issued by Lisa Lund, Director, Office of Compliance on December 2, 2009;
 - ii. Providing certificates or appropriate documentation in accordance with the December 2, 2009 memorandum to their first-line supervisor of completion of required training, including dates completed;
 - iii. Assisting, as needed, in the preparation of an IDP which addresses training necessary to continue to meet the requirements of this order; and

- iv. Applying and maintaining the knowledge, skills, and techniques acquired through training to ensure that compliance samples are collected in a technically and legally sound manner.
- c. First-line supervisors or team leaders: All first-line supervisors or team leaders of compliance inspectors/field investigators and of compliance sampling specialists are responsible for:
 - i. Completing the following minimum training requirements within one year of assuming a first-line supervisor or team leader position:
 - (i) Health and safety requirements (knowledge and understanding), unless performing any field activities. If any agency employee including a first-line supervisor or team leader engages in field activities, they are required to complete applicable occupational health and safety training as defined in SHEMP directives and guidelines under Orders 1440.1 and 1440.2;
 - (ii) Basic inspector curriculum, Item 4(b) of this order;
 - (iii) Environmental Statute Review course or equivalent training course on environmental statutes;
 - (iv) Documented self-study (such as participating in on-the-job training) of the media they are responsible for, resulting in development of a “working knowledge,” as defined in Item 6(h) of this order;
 - (v) Self-study to ensure knowledge of Order 3510: *EPA Federal Credentials for Inspections and Enforcement of Federal Environmental Statutes and Other Compliance Responsibilities*;
 - (vi) *Self-study of the Supervisor’s Guide to Order 3500.1*; and
 - (vii) Training to ensure knowledge of the region’s data collection/reporting procedures for inspection information, including the Inspection Conclusion Data Sheet;
 - ii. Obtaining knowledge and understanding of multi-media regional specific procedures and criminal environmental issues;
 - iii. Completing all applicable training listed in Item 4 of this order if first-line supervisors or team leaders are also responsible for conducting compliance inspections/field investigations;
 - iv. Providing oversight, quality assurance, and quality control of inspection/field reports, including sampling information. This responsibility may be delegated to a senior inspector with significant experience in that same program;
 - v. Ensuring quality compliance inspections/field investigations by using performance standards, periodic appraisals and appropriate assignments to

- provide for the development and recognition of personnel engaged in the compliance monitoring function;
- vi. Identifying employees who require training, ensuring that employees comply with the requirements of this order, and maintaining applicable records;
 - vii. Identifying additional program-specific training as appropriate for the type of work that is being conducted;
 - viii. Reviewing and evaluating previously trained credentialed inspectors/field investigators and compliance sampling specialists, on an annual basis, to determine if they are in need of additional training for professional skills development, including training in new or revised policies, guidelines or legislation;
 - ix. Documenting and placing in the compliance inspector/field investigator or compliance sampling specialist's personnel file any approved exceptions, signed by the regional or assistant administrator, to this order;
 - x. Requiring compliance inspectors/field investigators provide documentation of completed training to their first-line supervisor/team leader for approval prior to entry into a data tracking system that meets the requirements in 5(f)(8)(i-v) of this order;
 - xi. Documenting and maintaining a list of authorized compliance inspectors/field investigators and compliance sampling specialists;
 - xii. Ensuring that compliance inspector/field investigator or compliance sampling specialists credentials are only requested for personnel whose first-line supervisors have determined there is a need for a credential, have completed their necessary training requirements, have documentation of training completion and are deemed qualified by their first-line supervisor to conduct quality compliance inspections/field investigations or collect compliance samples on behalf of the agency. (Note: Prior completion of on-the-job training is not required to request an inspector-in-training credential (agency employees only) or a Temporary Letter of Authorization, but training must be completed prior to requesting a compliance inspector/field investigator credential.);
 - xiii. Ensuring that compliance inspectors/field investigators and compliance sampling specialists have the appropriate credential and have documented completion of program-specific training for the program in which they will be conducting their inspection/field investigation or collecting compliance samples;
 - xiv. Ensuring that individuals who have not completed the training requirements, but for whom their first-line supervisor has determined there is a need to participate in a compliance inspection/field investigation, for such purposes as on-the-job training or providing specialized expertise:

- (viii) Only conduct inspections when accompanied by a credentialed inspector who has completed the required training for the program; and
- (ix) Have either:
 - (a) A Temporary Letter of Authorization, as defined in Item 6(d), signed by the appropriate assistant administrator or regional administrator or their appropriate delegated authority;
 - (b) An inspector-in-training credential (agency employees only), as defined in Item 6(e), for the program in which they will be conducting their compliance inspections/field investigations; or
 - (c) A current credential (agency employees only) issued based on completion of training for another media program;
- xv. Ensuring when the first-line supervisor has determined there is a critical need in emergency situations, individuals who have completed the training requirements, but have not received an agency credential, have a Temporary Letter of Authorization, as defined in Item 6(d), signed by their assistant administrator or regional administrator, or their appropriate delegated authority before conducting all or part of a compliance inspection/field investigation; and
- xvi. Ensuring that compliance inspectors/field investigators and compliance sampling specialists are knowledgeable in the region's data collection and reporting procedures for inspection information.
- d. Assistant administrator for Enforcement and Compliance Assurance: The assistant administrator for OECA is responsible for:
 - i. Updating this order, overseeing and evaluating implementation of the overall program requirements, including updating the training requirements required by this order, as needed;
 - ii. Developing, updating and disseminating student materials and instructor guides for the basic inspector curriculum to the regions and coordinating the selection of and maintaining a list of instructors from the regions and headquarters through the National Enforcement Training Institute e-Learning Center; and
 - iii. Identifying and approving data systems for headquarters and the regions that will enable first-line supervisors, team leaders, and compliance inspectors/field investigators to track annual training accomplishments in order to meet the requirements of this order.
- e. Assistant administrator for Administration and Resources Management: The assistant administrator for OARM is responsible for:

- i. Updating and providing sufficient materials for occupational health and safety training or approving non-agency courses to meet the requirements of SHEMP and reviewing program-specific health and safety training;
 - ii. Training and evaluating agency personnel designated as instructors for delivering the occupational health and safety training; and
 - iii. Coordinating and disseminating a timely schedule of occupational health and safety classes, in consultation with OECA, program offices and the regions.
- f. Assistant administrators: The assistant administrators of offices which engage in compliance monitoring are responsible for:
- i. Developing, updating, and disseminating materials and schedules for classes under the program-specific curriculum, in consultation with regions and the States;
 - ii. Implementing the requirements of this order within their areas of jurisdiction, including periodically evaluating implementation;
 - iii. Responding to individual requests for training exceptions. (Note: This can only be delegated to the deputy assistant administrator);
 - iv. Ensuring that agency administered contracts and SEE Program cooperative agreements, involving compliance inspections/civil investigations that the completion of training, as required by this order, is incorporated into the appropriate contract statements of work or SEE program cooperative agreements and enrollee position descriptions;
 - v. Collaborating with the regions and OECA in the development and update of program-specific curriculum requirements;
 - vi. Requesting credentials from OARM for personnel whose supervisors have determined there is a need for a credential, have completed their necessary training requirements, have documentation of training completion, and are deemed qualified by their first-line supervisor to conduct quality compliance inspections/field investigations on behalf of the agency and ensuring that individuals conducting compliance inspections/field investigations have the appropriate credentials;
 - vii. Identifying a single point-of-contact responsible for auditing the office to ensure the requirements of this order are being met, for coordinating with OECA;
 - viii. Maintaining training information in a data system that can:
 - (i) Track names of compliance inspectors/field investigators and their supervisors;
 - (ii) Maintain a list of courses and other training with course names, hours, required frequency of completion, and descriptions;

- (iii) Record completion dates and due dates for required courses and other training for inspectors;
 - (iv) Produce reports that list due dates for required refresher training for compliance inspectors/field investigators within user defined time periods; and
 - (v) Provide e-mail alerts to supervisors that inform them of when their staff's refresher training is due;
- ix. Requesting inspector-in-training credentials, as defined in Item 6(e), from OARM for those personnel whose supervisors have determined there is a need for a credential to complete on-the-job training requirements; and
- x. Providing Temporary Letters of Authorization, as defined in 6(d), on an as-needed basis, and ensuring that records of such authorization are maintained, if issued.
- g. Regional administrators: The regional administrators are responsible for:
 - i. Implementing the requirements of this order within their areas of jurisdiction, including periodically evaluating implementation;
 - ii. Responding to individual requests for training exceptions. (Note: This can only be delegated to the deputy regional administrator);
 - iii. Ensuring that agency administered contracts and cooperative agreements awarded under the SEE program, involving compliance inspections/civil investigations that the completion of training, as required by this order is incorporated into appropriate contract statements of work or SEE program cooperative agreements and enrollee position descriptions;
 - iv. Supporting in-house instruction for the basic inspector curriculum by working with OECA to identify regional personnel to serve as classroom instructors;
 - v. Requesting credentials from OARM for personnel whose supervisors have determined there is a need for a credential, have completed their necessary training requirements, have documentation of training completion, and are deemed qualified by their first-line supervisor to conduct quality compliance inspections/field investigations on behalf of the agency and ensuring that individuals conducting compliance inspections/field investigations have the appropriate credentials;
 - vi. Identifying a single point-of-contact responsible for auditing the region to ensure the requirements of this order are being met, for coordinating with OECA, and for maintaining information in a tracking system that meets the requirements in 5(f)(8)(i-v) of this order;
 - vii. Requesting inspector-in-training credentials, as defined in Item 6(e), from OARM for those agency employees whose supervisors have determined

there is a need for a credential to complete on-the-job training requirements; and

- viii. Providing Temporary Letters of Authorization, as defined in 6(d), on an as-needed basis and ensuring that records of such authorization are maintained, if issued.

6. DEFINITIONS

- a. Compliance inspector/field investigator: Any individual authorized, through the issuance of a credential, to conduct or oversee for the purpose of investigating and documenting the compliance status of facilities or sites with applicable laws, standards, regulations, permits, and/or of supporting appropriate enforcement action (administrative, civil judicial or criminal).

Any credentialed agency employee performing these activities regardless of job or credential title or program shall be considered a compliance inspector/field investigator for the purpose of this order. The terms compliance inspector/field investigator will be used throughout this order. This does not include individuals who engage in field activities or investigations for purposes such as observing the inspection, research and development or programmatic activities unrelated to compliance monitoring or enforcement, or investigations that do not involve field work. This also does not include individuals who receive credentials issued by OIG or to agency criminal investigators/special agents.

Individuals performing work as on-scene coordinators and remedial project managers under the Comprehensive Environmental Response Compensation and Liability Act program who do not conduct inspections/field investigations as part of their job function, are not covered by the definition of the compliance inspection/field investigator. Those on-scene coordinators and remedial project managers will receive credentials that authorize them to carry out the functions of their position; however, on-scene coordinators and remedial project managers who do conduct field inspections/field investigations are covered by this definition and are subject to this order. Additional program guidance has been developed to assist regions in distinguishing these functions from other programmatic responsibilities.

- b. Compliance sampling specialist: Any individual authorized and issued a credential to collect samples for the purpose of documenting compliance with applicable laws, standards, regulations, permits, and/or of supporting appropriate enforcement action (administrative, civil judicial or criminal). The situations under which an agency employee may receive credentials as a compliance sampling specialist are defined in the memorandum entitled *Guidance for Documenting Required Inspector Training for EPA Employees Prior to Issuing Credentials (pursuant to EPA Order 3500.1 and 3510) If Training Certificates Are Not Available* issued by Lisa Lund, Director, Office of Compliance on December 2, 2009.
- c. First-line supervisors of inspectors: This includes:

- i. An individual who is the immediate supervisor of the day-to-day work of personnel authorized to conduct civil compliance inspections/field investigations.
 - ii. An individual in a team leader position, if they perform similar functions as a first-line supervisor.
- d. Temporary Letter Credential (also known as a Temporary Letter of Authorization):²³ A letter credential signed by an assistant administrator or regional administrator or their appropriate delegated authority that authorizes an individual to conduct all or part of a compliance inspection/field investigation under a specific statute. Temporary Letters of Authorization will only be issued for the purposes of obtaining on-the-job training, providing specialized expertise in the program area or for emergency situations. When a Temporary Letter of Authorization is issued to an individual who has not completed the required training, that individual must be accompanied by a credentialed compliance inspector/field investigator who has completed the required training for the program in which they will be conducting their inspection/field investigation. The letters will not be used for individuals who conduct inspections on a routine basis. The letters will be valid for the time period outlined in Order 3510, and are not renewable.
- e. Inspector-in-training credential: A credential issued to agency employees only by OARM that authorizes an individual to conduct all or part of a compliance inspection/field investigation under specific statutes in order to complete on-the-job training requirements. When an individual issued an inspector-in-training, credential participates in an inspection, that individual must be accompanied by a credentialed compliance inspector/field investigator who has completed the required training for the program in which they will be conducting their inspection/field investigation on all inspections. Inspector-in-training credentials will be valid for a maximum of one year.
- f. Curriculum: The defined content presented in a sequence of supervised self-study, formal on-the-job and/or classroom training:
 - i. Supervised self-study: Knowledge gained through independent, personal study (such as computer-based training or web-based training) with oversight by a first-line supervisor, team leader, and/or an experienced inspector/investigator.
 - ii. On-the-job training: Structured training that relates to principles, theories or work-related skills which are demonstrated and applied in the field environment during an actual compliance inspection/field investigation.

²³ A Temporary Letter Credential is also known, and commonly referred to, as a Temporary Letter of Authorization or Letter of Authorization.

- iii. Classroom/classes: Any form of instruction, (flexible in format and size to include seminars, workshops, lecture-type or video-assisted classes, or question-and-answer sessions following prior independent self- study) that foster group interaction with an instructor or an experienced inspector/investigator.
- iv. e-Learning: Comprises all forms of electronically supported learning and teaching, including but not limited to training found on the NETI e-Learning Center.
- g. Completing required training: Satisfactorily completing all training, as defined in Item 4 of this order.
- h. Working knowledge: A sufficient knowledge of statutory/regulatory requirements, field inspection methods, and some experience accompanying an inspector/investigator for a particular program. This knowledge would be required as the minimum needed to be able to evaluate the completeness and quality and sign-off on inspection reports.

7. REFERENCES

- a. Order 1440.2, *Health and Safety Requirements for Employees Engaged in Field Activities* issued April 23, 2013.
- b. Order 1440.1, *Safety, Health and Environmental Management Program (SHEMP)* issued November 20, 2012.
- c. Safety, Health, and Environmental Management Guidelines 51: Safety, Health and Environmental Management Training, and 56: Job Hazard Analysis.
- d. *Guidance for Documenting Required Inspector Training for EPA Employees Prior to Issuing Credentials (pursuant to Order 3500.1 and 3510) If Training Certificates Are Not Available*, memorandum from Lisa Lund, Director, Office of Compliance, issued December 2, 2009.
- e. *EPA Credential and Inspector Training Policy Compendium*, Office of Enforcement and Compliance Assurance, Office of Compliance. Contact: Compliance Policy Staff, 202-564-7002.
- f. Order 3510, *EPA Federal Credentials for Inspections and Enforcement of Federal Environmental Statutes and Other Compliance Responsibilities* revised October 31, 2012.
- g. [Guidance for Issuing Federal EPA Inspector Credentials to Authorize Employees of State/Tribal Governments to Conduct Inspections on Behalf of EPA](#) issued September 2004.

- h. *Guidance for Issuing Federal EPA Inspector Credentials to Employees of Contractors to Conduct Inspections on Behalf of EPA* issued May 31, 2013.
- i. *Guidance for Issuing Federal EPA Inspector Credentials to Senior Environmental Employment Program Enrollees to Conduct Inspections on Behalf of EPA* issued September 30, 2013.
- j. *Supervisor's Guide to Order 3500.1*, issued October 2003.

Appendix B – EPA Order 3510, EPA Federal Credentials for Inspections and Enforcement of Environmental Statutes

This document is relevant only to inspectors who are EPA employees and other inspectors who have EPA credentials to conduct inspections on behalf of EPA. You can request access to the document by emailing the Office of Compliance at NPDESCompliance@epa.gov.

Appendix C –
EPA Order 1440.2,
Health and Safety Requirements for Employees
Engaged in Field Activities



Classification Number: 1440.2
Approval Date: 01/10/2011
Administrative Change: 04/23/2013

EPA ORDER

SAFETY AND HEALTH TRAINING REQUIREMENT FOR AGENCY EMPLOYEES

1. **PURPOSE**

This Environmental Protection Agency (EPA) Order establishes policy, responsibilities and mandatory requirements for occupational safety and health training and certification of Agency employees.

2. **OBJECTIVES**

The objectives of the safety and health training and certification programs for Agency employees are:

- a. To ensure that all EPA employees are aware of the potential hazards they may encounter during the performance of general and job-specific work activities;
- b. To provide the knowledge and skills necessary to perform the work with the least possible risk to personal safety and health;
- c. To ensure that Agency program goals are accomplished in a safe and healthful manner as feasible; and
- d. To ensure that EPA employees can safely disengage themselves from an actual hazardous situation that may occur during general and job-specific work activities.

3. **BACKGROUND**

Agency employees engage in a broad range of activities including routine administrative tasks in office settings, materials handling operations in warehouses, facility and equipment maintenance, environmental sampling, inspections and criminal investigations, analysis and monitoring, training and exercises, and emergency response activities.

Many of these activities involve entering and working in environments with known and unknown hazards. Protection cannot be engineered into all situations, and protection of personnel involves training employees in safe operational procedures that may also include the proper use of appropriate personal protective clothing and equipment.

4. **POLICY**

It is EPA policy to carry out its activities in a manner that ensures the protection of its employees and compliance with regulations. All EPA Program Offices and Regions must support a comprehensive safety, health and environmental training program. Such programs provide knowledge and skills necessary to perform job-related tasks with the least possible risk. Training is necessary for preventing or minimizing injuries and illnesses in the workplace and is required under numerous safety, occupational health and environmental standards.

5. **APPLICABILITY**

This Order applies to all EPA organizational units and locations that have Agency employees.

6. **DEFINITIONS**

- a. The term “certification” means that the employee has successfully completed the minimum classroom and hands-on training requirements for the specified need, and the appropriate local and/or programmatic health and safety official has certified or attested that the employee met these requirements.
- b. The term “employee” is defined as any full, part-time, temporary, or permanent EPA employee; a detailee to EPA from another government agency; an individual enrolled in the EPA Senior Environmental Employment Program; a student assigned to EPA; an EPA stay-in-school program participant; an intern or fellow assigned to EPA; or any other individual who is designated on a case-by-case basis by the Director of the Safety, Health, and Environmental Management Division (SHEMD) or senior Agency officials. Furthermore, this term includes EPA top management officials, supervisors, safety and health personnel, safety committee members, and employees who are representatives of employee groups.
- c. The term “field activities” means EPA program activities that are conducted by EPA employees outside of EPA administered facilities. These activities include, but are not limited to, criminal investigations, compliance inspections and sampling conducted under all EPA statutes, hazardous material spill and waste site investigations, and field duties with EPA’s Response Support Corps or Incident Management Teams.
- d. “Job Hazard Analysis (JHA)” is a systematic technique to identify, characterize, and evaluate the demands, potential health, and physical hazards or risks

associated with an employee's job description and tasks. The purpose of JHA is to ultimately develop and confirm recommended safe work procedures and controls to eliminate/control the associated hazards.

- e. The term "laboratory activities" means EPA activities that are conducted in a mobile or fixed laboratory workplace by EPA employees who may be exposed to hazardous chemicals or agents in the course of his or her assignments.
- f. The term "other activities" means all EPA activities where additional safety and health training or awareness needs are identified beyond traditional field or laboratory settings. Examples include those involving repetitive motion in office settings, warehouse and materials handling activities, grounds and equipment maintenance activities, or other activities where safety and health training or awareness is required for employees to meet operational needs.
- g. The term "safety and health training" means scheduled training approved and sponsored by EPA and conducted by Agency employees or contractors that is designed to develop, improve or upgrade the safety and health knowledge of EPA employees. For the purposes of this Order, various types of training include:
 - i. Orientation. Fundamental safety and health training on subject areas that all employees receive during their orientation period.
 - ii. Initial. Training in addition to the subject areas covered during the employee orientation period that meets a particular need identified through a JHA, a specific authority, EPA guidance, local policy, etc., prior to assignment or before the employee performs the affected work.
 - iii. Refresher. Training that may be provided on a routine basis (e.g., annually) to build upon previous knowledge or training in a specific subject and to keep skills up to date. The requirements for refresher training are usually specified under a specific authority, JHA, EPA Guidance, local policy, etc.

7. RESPONSIBILITIES

- a. Administrator. The Administrator is responsible for establishing and maintaining the Agency's Safety, Health, and Environmental Management Program (SHEMP).
- b. Assistant Administrator (AA), Office of Administration and Resources Management (OARM). The AA-OARM serves as EPA's Designated Agency Safety and Health Official with responsibility for establishing EPA's occupational safety and health policies and programs.
- c. Director, SHEMD. The SHEMD Director is responsible for establishing policy and guidance for training and certification programs for Agency activities, approving safety and health training and certification programs for employees, and evaluating the results of these training and certification programs.

- d. Assistant Administrators and Regional Administrators. These officials are responsible within their jurisdictions for implementing the provisions of this Order and for providing the necessary funds for employee training and certification.
- e. Supervisors. Supervisors are responsible for complying with the requirements of this Order for employee training and certification. Supervisors will identify those employees who require job-specific safety and health training and certification in conjunction with the local SHEMP manager, will ensure they receive training in compliance with the provisions of this Order, and will ensure these requirements are properly contained in position descriptions and job postings.
- f. Safety, Health and Environmental Management Program Officials (e.g., the local SHEMP Manager/Specialist). The SHEMP managers are responsible for identifying program areas that require training and certification and recommending or providing training and certification resources to meet the requirements of this Order. Additionally, SHEMP managers certify or attest on behalf of the Agency, that the employee has successfully completed the minimum classroom and hands-on training requirements specified for the needed training and maintain records of persons receiving training and certification.
- g. Employees. Employees are responsible for knowing the extent of their individual occupational safety and health training. Employees should notify their supervisor of any hazardous work situation and make suggestions for corrective measures. Employees are responsible for applying the knowledge, skills, and techniques acquired through training in a manner that will help ensure their safety and health and that of fellow workers, and they must participate in safety and health training provided by the Agency.

8. TRAINING AND CERTIFICATION REQUIREMENTS

- a. This Order establishes general orientation and job-specific safety and health training requirements for the following groups of EPA employees:
 - i. Management. Managers shall receive orientation to assist in managing the occupational safety and health programs of SHEMD.
 - ii. Supervisors. First-line supervisors shall receive introductory and specialized courses to recognize and eliminate occupational safety and health hazards in the workplace. The training shall cover procedures for reporting and investigating workplace hazards and motivating subordinates toward ensuring safe and healthful work practices.
 - iii. Safety, Health and Environmental Management Program Officials. SHEMP managers/specialists shall receive occupational safety and health training to understand the basic elements related to hazard recognition, hazard

evaluation and control, workplace inspection, equipment and facility design, and injury and illness data, as applicable to operations within their respective reporting units.

- iv. Collateral Duty Safety and Health Personnel. Collateral duty safety and health employees (e.g., incident management team safety officers and other employees who perform this function as an additional duty) shall be provided training commensurate with their assigned duties and shall have an understanding of SHEMD's occupational safety and health program.
- v. Employees and Employee Representatives. Employees shall be provided with general and job-specific safety and health training appropriate to the operational needs within the Agency and to the work they perform. Employee representatives (such as union officials, safety committee representatives and others) shall be provided training to assist in workplace inspections and gain an understanding of their basic duties as employee representatives.

b. General and job-specific training for EPA employees is defined as follows:

- i. General Safety and Health Orientation Training. All employees shall be provided with core safety and health training at the time of employment during their orientation period. The training shall include, but not be limited to, subject areas identified in SHEM Guideline 51.
- ii. Job-Specific Safety and Health Training. All employees shall be provided with additional job-specific safety and health training before the employee actually performs work. Job-specific training is described in SHEM Guideline 51, which provides methods and checklists to identify job-specific training needs.

Additional job-specific training needs may be identified in a JHA for an employee's position. Detailed information regarding JHAs is provided in SHEM Guideline 56.

Supervisors shall work collaboratively with safety and health officials to implement the training requirements in SHEM Guideline 51, the requirements of any associated JHA, and any regulatory requirements (e.g., hazardous waste operations and emergency response training required under 29 Code of Federal Regulations (CFR) 1910.120).

c. Job-specific safety and health training shall meet the following minimum requirements for field, laboratory and other specialized activities. (*Note: The SHEMP manager may certify employees based on an evaluation of previous training, education and experience. Recommendations for this type of certification should be made to the SHEMP manager at the reporting unit.*)

- i. Field Activities. All employees that engage in field activities shall be provided a minimum of 24 hours of safety and health training prior to becoming

involved in normal, routine field activities. Eight hours of annual refresher training is also required. The 24-hour training shall include, but not be limited to, instruction in all of the following subject areas:

- Nature of anticipated hazards
- Emergency help and self-rescue (i.e., emergency planning in remote locations)
- Safe use of field equipment
- Use, handling, storage and transportation of hazardous materials
Personal protective equipment/clothing, use and maintenance
Safe sampling techniques
- First aid

Within six months of receiving instruction, the employee shall accompany another employee experienced in field activities and perform actual field tasks with supervision for a minimum of three days. Employees satisfactorily completing these requirements will be considered certified for field activities by the SHEMP manager at the reporting unit.

- ii. Laboratory Activities. All employees that engage in laboratory activities shall be provided a minimum of 24 hours of safety and health training prior to becoming involved in normal, routine laboratory activities. Four hours of annual refresher training is also required. The 24-hour training shall include, but not be limited to, instruction in all of the following subject areas:

- Engineering controls, administrative/work practice controls, and personal protective equipment
- EPA Medical Surveillance Program
- Safety, health, and environmental management plans
- Signs and symptoms of chemical, physical, and biological exposures
Locations and uses of emergency equipment
- Waste management program
- Labeling, storage, and handling of chemicals
- Chemical inventory and management program
Material safety data sheets
- Emergency procedures
- Fire and life safety

Within six months of receiving instruction, the employee shall accompany another experienced employee and perform actual laboratory activities and tasks with supervision for a minimum of three days. Employees satisfactorily completing these requirements will be considered certified for laboratory activities by the SHEMP manager at the reporting unit.

iii. **Other Specialized Activities.** All EPA employees that supervise or participate in specialized or unique activities that are not covered elsewhere in this Order must be provided with safety and health training that is commensurate with anticipated hazards. Depending on specific duties or tasks, training requirements for employees engaged in these activities may involve up to 40 hours or more of training. The levels of training will be established by the SHEMP manager and employees' supervisors in accordance with SHEM Guidelines 51 and 56 and other applicable requirements. Examples of specialized activities where this may apply include, but are not limited to:

- Boating and marine operations EPA diving operations
- Trailer loading and towing
- Mobile equipment transportation, set-up and operation (e.g., command posts, mobile laboratories, etc.)
- Aerial operations, surveillance, and reconnaissance
- Off-road, self-propelled, all-terrain vehicle (ATV) operations Powered tool and equipment operations (e.g., table saw, portable drill, stationary drill press, welding equipment, etc.)
- Firearms and powder activated devices
- Facility operations, equipment, and maintenance Materials handling, storage, and transport
- Medical response operations (e.g., first aid, CPR, AED, EMT, oxygen administration, etc.)
- Regulated activities (e.g., hazardous waste operations and emergency response, use of respiratory protection equipment, lead or asbestos abatement, formaldehyde, ethylene oxide, arsenic, blood borne pathogens, chemical warfare agents, nanomaterials, construction areas, confined spaces, etc.)
- Commercial driving
- Other specialized or unique activities that are not covered elsewhere in this Order yet require additional safety and health training

Employees shall be provided with a combination of virtual, classroom, and hands-on training prior to becoming involved in specialized activities.

Employees satisfactorily completing specific training requirements for other specialized activities shall be provided corresponding certifications from the SHEMP manager at the reporting unit.

9. **FREQUENCY OF TRAINING**

Safety and health training should begin at the time of employment or prior to assignment, before the employee actually begins performing particular job duties.

Employees engaged in field or laboratory activities shall complete a minimum of 24 hours respectively of initial safety and health training prior to assignment. Employees engaged in field activities shall complete a minimum of eight hours of refresher instruction annually. Employees engaged in laboratory activities shall complete a minimum of four hours of refresher instruction annually. Where this or additional requirements for refresher training have been identified, instruction shall include a review of all relevant subject areas in order to maintain certification. Training requirements are identified in SHEM Guideline 51, JHAs, EPA Orders, mandatory training requirements, regulatory requirements and other sources.

SHEMP managers, in coordination with supervisors, will determine if the employee's training is consistent with the requirements of this Order. For example, in cases where employees have lapsed certifications or resume certain activities after an extended time gap, the SHEMP manager will determine if initial or refresher training must be completed.

10. **RECORD OF TRAINING**

- a. A record of the training and certification shall be maintained by the appropriate local and/or programmatic health and safety official. Records, at a minimum, shall identify the trainee by name, the training topic and course title, the training date, and the name of the training source, where applicable.
- b. The SHEMP manager shall maintain a recordkeeping system to document the training topics and certification levels for each employee at the reporting unit.
- c. The SHEMP manager shall monitor training and certification records to establish schedules for appropriate refresher training.
- d. The SHEMP manager shall ensure employees and supervisors have access to their safety and health training and certification records.
- e. Nationally consistent titles for training topics and certifications as established in EPA SHEM Guideline 51 shall be used to record and communicate the receipt of training.

11. **AUTHORITIES**

- a. Occupational Safety and Health Act of 1970
- b. Executive Order 12196, *Occupational Health and Safety Programs for Federal Employees*
- c. 29 CFR Part 1910, *Occupational Safety and Health Standards*
- d. 29 CFR Part 1960, *Basic Program Elements for Federal Employees*
- e. 40 CFR Part 311, *Worker Protection*

- f. EPA Order 1440.1, *Safety, Health and Environmental Management*
- g. EPA Order 1440.3, *Respiratory Protection*
- h. EPA Order 1000.18, *Transportation of Hazardous Materials*
- i. EPA Order 1440.5A, *Qualifications and Training Requirement for Occupational Health and Safety Program Personnel*
- j. EPA Order 1440.7, *Hazard Communications*
- k. EPA Order 1460.1, *Occupational Medical Surveillance Program*
- l. EPA Order 2072, *Response Support Corps*
- m. EPA Order 3500.1 A1, *Training and Development for Compliance Inspectors/Field Investigators*
- n. 29 CFR Part 1926, *Safety and Health Standards for Construction*
- o. Government Employees Training Act of 1958, as amended in 1994
- p. Title 5 of the United States Code 4101, et seq.
- q. 5 CFR Part 410, Training
- r. Other federal, state, and local code training requirements as applicable

12. **REFERENCES**

SHEMD Intranet site

SHEM Guideline 38: Radiation Safety and Health Protection Program

SHEM Guideline 50: Federal Employee Occupational Health and Safety Program

SHEM Guideline 51: Mandatory Health and Safety Training

SHEM Guideline 56: Job Hazard Analysis

Office of Solid Waste and Emergency Response Directive 9285.3-12, Emergency Responder Health and Safety Manual

13. **PERIODIC REVIEW**

SHEMD will periodically review EPA Order 1440.2 to ensure its continued effectiveness and adherence with applicable rules and regulations.

This Order supersedes Order 1440.2, which was approved on July 12, 1981.

Appendix D – EPA’s Memorandum on Practices to Follow and Avoid when Requesting Information



UNITED STATES ENVIRONMENTAL PROTECTION AGENCY
WASHINGTON, D.C. 20460

APR 18 2002

OFFICE OF
ENFORCEMENT AND
COMPLIANCE ASSURANCE

MEMORANDUM

SUBJECT: Practices to Follow and Avoid When Conducting Compliance Inspections:
Requesting Information

FROM: Michael S. Alushin, Director *M.S. Alushin*
Compliance Assessment and Media Programs Division

TO: Addressees

This memorandum transmits a list of practices which are recommended to be followed and avoided when requesting information during compliance inspections. This list was prepared in consultation with staff from the Office of Regulatory Enforcement to address concerns expressed by Congress with regard to overly burdensome requests for information by EPA compliance inspectors. It is recommended that all EPA compliance inspectors follow or avoid these practices, as appropriate. Please distribute this list to the inspectors in your respective organization.

Thank you for your attention. We hope this guidance improves the understanding of procedures to follow when requesting any information while conducting compliance inspections. We encourage all EPA Compliance Inspectors to follow these good practices.

If you have any questions, please contact Julie Tankersley at (202) 564-7002, or email at tankersley.julie@epa.gov. This list of good practices will also be posted on the EPA Inspector website at <http://intranet.epa.gov/oeca/oc/metd/inspector/>.

Attachment

List of Addressees:

Regional Enforcement Division Directors, Regions 1-10
Regional Media Division Directors, Regions 1-10
Regional Science and Technology Division Directors, Regions 1-10
Regional Enforcement Coordinators, Regions 1-10
Michael Stahl, Director, Office of Compliance
Lisa Lund, Acting Deputy Director, Office of Compliance
OC Division Directors
Connie Musgrove, Acting Director, Office of Regulatory Enforcement
George Lawrence, Acting Deputy Director, Office of Regulatory Enforcement
ORE Division Directors
Leo D'Amico, Director, Office of Criminal Enforcement, Forensics & Training
OCEFT Division Directors
Mary Kay Lynch, Director, Office of Planning, Policy Analysis, & Communications
Diana Love, Director, National Enforcement Investigations Center
David Lopez, Director, Oil Program Center
Gary Jones

Privileged – For internal use only – Do not release under FOIA
Practices to Follow and Avoid When Conducting Compliance Inspections

January 22, 2002

Purpose of Document

A number of recent Congressional inquiries into the EPA's authority to request information to determine compliance prompted OECA to develop the following "Practices To Follow and Avoid When Conducting Compliance Inspections".

The Practices are designed to comply with legal and policy guidance. First, they ask that a case file be opened prior to conducting an inspection, which should include any research on potential violations at the facility. Second, they minimize the possibility inspectors will request information **not** considered part of a routine compliance inspection. Inspectors should **not** request information that should be collected under a formal information request using the authorities in each of the environmental statutes (i.e., CAA Section 114, RCRA Section 3007, CWA Section 308, TSCA Section 11, FIFRA Sections 8 and 9, SDWA Section 3001, OPA Section 311, CERCLA Section 104). These information requests are formal documents that can result in the commencement of an enforcement action by EPA pursuant to the enforcement sections of the statute.

OECA expects EPA inspectors to follow the good practices and those to avoid listed below.

Good Practices to Follow When Conducting Compliance Inspections

- Conduct research on the potential for violations before conducting inspections
- Open an individual enforcement case file (a physical or electronic file with the facility name, location, previous inspections, etc.) prior to conducting inspections
- Use inspection checklists only as a guide. Don't follow the checklist blindly. Tailor your questions to the individual facility. It is generally not required to ask every question on the checklist at every facility.
- Use of an inspection checklist should be used for the purpose of determining compliance or supporting an active or planned enforcement action.
- Additional questions asked of facility personnel should be related to the direct observations noted during the field portion of the inspection or based on prior research.
- Basic questions such as number of employees, engineering drawings, hours of operation are allowed to be asked even if they are not specifically "required by regulations"

Practices to Avoid When Conducting Inspections

- × Avoid asking questions as a general survey of the facility or class of facilities
- × Avoid asking questions which are unrelated to the purpose of the site visit
- × Avoid asking for information from the facility during the inspection that is onerous and may take more than a few days to provide.
- × Avoid asking questions that are typically included in a statutory "information request" (e.g., CAA 114 requests or RCRA 3007 request)

Appendix E –
Sample CWA Section 308 Information Collection
Request Letter (308 Letter)

CERTIFIED MAIL–RETURN RECEIPT REQUESTED

Date

Name
Address

Dear Name:

Enclosed is an Information Request (Request) issued to (company name), pursuant to Section 308(a) of the Clean Water Act, 33 U.S.C. Part 1318(a), which authorizes the U.S. Environmental Protection Agency (EPA) to request information required to carry-out the objectives of the CWA. The Request relates to waterbodies in your vicinity that are impaired by pollutants frequently associated with discharges from animal feeding operations. EPA needs to ensure that your facility is operating properly to protect water quality. Only one response is required from (company name) and your response to the Request must be post-marked no later than thirty (30) days from your receipt of this letter.

Please be advised that failure to respond to the Request within the thirty (30)-day period or provide full, complete, true and correct responses, may result in additional action requiring you to properly respond to the Request.

EPA urges you to give this matter your immediate attention and respond to this Request in a timely manner. Your response must be signed by an authorized official and should be mailed to (appropriate designated official) at the address above.

If you have any questions regarding this Request, you may contact (appropriate designated official).

Sincerely,

Director
Compliance Assurance and
Enforcement Division

CERTIFIED MAIL – RETURN RECEIPT REQUESTED

Article Number: (#)

(Contact Name)

(Company)

(Address)

Re: **Request for Information Pursuant to Section 308 of the Clean Water Act**
CWA-IR-15-025
(Company Name)
EPA ICIS NPDES Tracking No. (#)
(state)PDES General Permit No. (#)

Dear (contact name):

Section 308(a) of the Clean Water Act (“CWA”), 33 U.S.C. Part 1318(a), provides that whenever it is necessary to carry out the objectives of the CWA, including determining whether or not a person/agency is in violation of Section 301 of the CWA, 33 U.S.C. Part 1311, the United States Environmental Protection Agency (“EPA”) shall require the submission of any information reasonably necessary to make such a determination. Under the authority of Section 308 of the CWA, EPA may require the submission of information necessary to assess the compliance status of any facility and its related appurtenances.

(Company name) obtained coverage under the (appropriate state program) Construction Activity Storm Water General Permit (“Construction General Permit” or “CGP”), (state program) Permit No., on or about (date) for the site. The CGP regulates storm water discharges to surface waters from construction activities, including clearing, grading and excavation, which disturb one (1) acre or more of land. The effective CGPs for the past 5 years were the February 28, 2007 renewal, with a minor modification on August 17, 2009 (“2009 CGP”) and the current March 1, 2012 renewal (“2012 CGP”).

On (date), representatives of the EPA conducted a Reconnaissance Inspection (“RI” or “Inspection”) of the (site name) and identified violations of the CGP, as detailed in the attached RI report.

A. Pursuant to Section 308 of the Clean Water Act, (company name) shall submit, for the (site name), to EPA Region (#) the following:

1. within **thirty (30) calendar days** of the date of receipt of this Request for Information, submit in writing, the actions (including schedules) that the facility has taken to address the Potential Noncompliance Items in the RI report.
2. within **forty-five (45) calendar days** of the date of receipt of this Request for Information:
 - a. the Storm Water Pollution Prevention Plan(s) (“SPPP”) that were in place for the period January 2011 to Present as required by Part E.1 and Attachment B of the CGP (which includes both the Erosion and Sediment Control component and the Construction Site Waste Control component);
 - b. weekly routine inspection reports required by Part I.E.3 of the CGP for the period January 2011 to the present;
 - c. for the period January 2011 to the Present, as applicable, submit, all Annual Reports required by

Part I.E.4 of the 2009 CGP through February 28, 2012 and Reports of Noncompliance required by Part I.E.4 of the 2012 CGP and I.E.5 of the 2009 CGP;

- d. for the period January 2011 to present, if (company name) does not have any of the information required above, then identify the dates of the unavailable reports and identify why such reports were not completed;
 - e. the date when excavation and construction activity began at the (site name);
 - f. the date when excavation and construction activity will be, or is expected to be, completed at the (site name); and
 - g. a report containing the costs associated with storm water management controls including labor, operations and maintenance, installation, etc. which were required to achieve compliance for the period June 11, 2015 to present. These costs should include:
 - i. updating the SPPP as site conditions require;
 - ii. fully implementing the SPPP; and
 - iii. installation of stormwater best management practices
- B. Within **ninety (90) calendar days** of the date of receipt of this Request for Information submit a complete listing and required information for all sites one (1) acre or greater, owned or operated by (company name), parent companies and/or subsidiaries, or any other entity under the general management of (company name) that are either under construction, have not undergone final stabilization, or that are under contract for construction. The response list and information must include:
- a. the site name, street/location, city, and zip code (including Latitude and Longitude information);
 - b. the area of the site (in acres);
 - c. the number of disturbed acres (or acres that will be disturbed);
 - d. a copy of the approved Request for Authorization;
 - e. a copy of the Letter of Acknowledgement or Authorization to Discharge, if applicable;
 - f. the name(s), address, telephone number and contact person name for each of the operators or owners of the construction site including a list of subcontractors at each site who are responsible for clearing grading and/or excavating;
 - g. the date that the construction began or is scheduled to begin and the date that construction is expected to be completed;
 - h. the name of the receiving body or bodies of water for the storm water discharges;
 - i. the Storm Water Pollution Prevention Plan(s) ("SPPP") that were in place for the period January 2012 to the present as required by Part E.1 and Attachment B of the CGP, which includes both the Erosion and Sediment Control component and the Construction Site Waste Control component;
 - j. weekly routine inspection reports required by Part I.E.3 of the CGP for the period January 2012 to the present; and

- k. for the period January 2012 to the present, the Reports of Noncompliance required by Part I.E.4 of the 2012 CGP and I.E.5 of the 2009 CGP.

CERTIFICATION

Any documents to be submitted by (company name) shall be sent by certified mail or its equivalent and shall be signed by an authorized representative of the respective entity (see 40 CFR Part 122.22), and shall include the following certification:

"I certify under penalty of law that this document and all attachments were prepared under my direction or supervision in accordance with a system designed to assure that qualified personnel properly gathered and evaluated the information submitted. Based on my inquiry of the person or persons who manage the system, or those persons directly responsible for gathering the information, the information submitted is, to the best of my knowledge and belief, true, accurate, and complete. I am aware that there are significant penalties for submitting false information, including the possibility of fine and imprisonment for knowing violations."

All information required to be submitted pursuant to this Request for Information shall be sent by certified mail or its equivalent to the following addresses:

**Chief, Water Compliance Branch
Division of Enforcement and Compliance Assistance
U.S. Environmental Protection Agency - Region (#)
(address)**

**(name), Administrator
Water and Land Use Enforcement
(state department)
(address)**

For further information on EPA's Storm Water Program such as Best Management Practices and Storm Water Controls see EPA's web site at: <http://cicacenter.org/bmps.html>
(appropriate state website)

If you have any questions regarding this Request for Information, please contact (appropriate designated official).

Sincerely,

Chief
Water Compliance Branch

Enclosures

CERTIFIED MAIL - RETURN RECEIPT REQUESTED

Article Number: (#)

(Name)

**Assistant Commissioner
Bureau of Water and Sewer Operations
New York City Department of Environmental Protection
96-05 Horace Harding Expressway, 2nd Floor
Corona, New York 11368**

**Re: Request for Information Pursuant to Section 308 of the Clean Water Act
(33 U.S.C. Part 1318)
Docket No. (#)
SDPES Permit Nos. (#)**

Dear (name):

This letter concerns discharges of pollutants into waters of the United States from facilities associated with the New York City Department of Environmental Protection (“NYCDEP”).

Section 301 of the Federal Clean Water Act (“CWA”), 33 U.S.C. Part 1251, *et seq.*, prohibits the discharge of pollutants into waters of the United States except as authorized by a permit issued pursuant to Section 402 of the CWA, 33 U.S.C. Part 1342. Each discharge of pollutants from a point source that is not authorized by such a permit constitutes a violation of Section 301(a) of the CWA, 33 U.S.C. Part 1311(a).

This letter and the enclosures are a request for information issued pursuant to Section 308(a) of the CWA, 33 U.S.C. 1318(a). Section 308 of the CWA authorizes the Administrator of Environmental Protection Agency (“EPA”) to require those subject to the CWA to furnish information, conduct monitoring, provide entry to the Administrator or authorized representatives and make reports as may be necessary to carry out the objectives of the CWA. The enclosures, which are hereby made part of this letter, details the information NYCDEP must provide to EPA relating to its wastewater collection system and its treatment plants.

Section 308(a) of the CWA, 33 U.S.C. Part 1318(a) authorizes EPA to require any person to provide information required to carry out the objectives of the CWA including to determine whether there has been a violation of the CWA. Accordingly, you are requested to respond to the enclosed Information Request (Enclosure 1). Please read the instructions and definitions in the enclosure carefully before preparing your response. Answer each question as clearly and completely as possible. To the extent that NYCDEP has any of the requested data currently on file, that data may be submitted in the requested format as part of your response. Your response to this request must be accompanied by a certificate that is signed and dated by you or the person who is authorized by you to respond to the request. The certification must state that the response is complete and contains all information and documentation available to you pursuant to the request. A Statement of Certification is enclosed with this letter (Enclosure 2).

Please submit your written responses in accordance with the deadlines set forth in the request to:

**(Name), Chief
Municipal Enforcement Branch
Office of Civil Enforcement
U.S. Environmental Protection Agency
1200 Pennsylvania Avenue NW (Room 3111B)
Washington, DC 20460
Email:
Telephone:
Fax:**

**(Name), Chief
Water Compliance Branch
Division of Enforcement and Compliance Assistance
290 Broadway, 20th Floor
New York, NY 10007
Email:
Telephone:
Fax:**

Although the information requested must be submitted to EPA, you are entitled to assert a business confidentiality claim pursuant to the regulations set forth in 40 CFR Part 2, Subpart B. If EPA determines the information you have designated meets the criteria in 40 CFR Part 2.208, the information will be disclosed only to the extent and by means of the procedures specified in Subpart B. Unless a confidentiality claim is asserted at the time the requested information is submitted, EPA may make the information available to the public without further notice to you.

Compliance with the provisions of this letter is mandatory. If you do not respond fully and truthfully to this Information Request or adequately justify your failure to do so, you may be subject to civil penalties or criminal fines under Section 309 of the CWA, 33 U.S.C. Part 1319, under which injunctive relief and penalties may be sought. Such an enforcement action may include the assessment of penalties of up to \$37,500 per violation, for each day of continued non-compliance.

We appreciate your cooperation and prompt attention to this matter. If you or your staff would like an opportunity to confer, have any questions, or would like to schedule a meeting relating to this information request, please contact (appropriate designated official). Thank you for your cooperation in this matter.

Sincerely,

Chief
Water Compliance Branch
USEPA Region 2

Enclosures

- (1) Information Request
- (2) Statement of Certification

Appendix F – Final Fact Sheet: The Do's and Don'ts of Using U.S. EPA Credentials

DATED: JUNE 1, 2000; SIGNED: MICHAEL STAHL

MEMORANDUM

SUBJECT: Final Fact Sheet:
The United States Environmental Protection Agency Credentials Fact Sheet

FROM: Michael Stahl, Acting Directors/ MICHAEL STAHL
Office of Compliance

TO: See Attached List

Purpose The purpose of this memo is to transmit the final fact sheet on the United States Environmental Protection Agency (U.S. EPA) credentials. The fact sheet does not change existing EPA policies on credentials. The fact sheet is designed to inform EPA managers, supervisors, and employees of the overall process regarding U.S. EPA credentials. The fact sheet pertains only to EPA employees. The fact sheet contains information on the definition, policy, authority, language, issuing procedures, accountability, renewal, potential penalties for improper use, and specific do's and don'ts.

Process A draft fact sheet was transmitted for your review on April 14, 2000. The Office of Compliance (OC) received comments on the draft fact sheet from Regions 2, 3, 4, 6, 7 and 8, and from the Office of General Counsel (OGC), the Office of Environmental Justice (OEJ), the Office of Regulatory Enforcement (ORE), and the Office of Administration and Resource Management (OARM). The fact sheet was revised based on the comments.

Request Please distribute a copy of the fact sheet to all EPA employees holding EPA credentials. The fact sheet will also be posted on the OC Compliance Inspector Web Site. (<http://intranet.epa.gov/oeca/oc/metd/inspector>)

Future Procedure OARM will include a copy of the fact sheet with the credentials when they are renewed every three (3 years).

Thank you for your attention to this request.

Addressees:

Eric Schaeffer, Director, ORE
Leo D'Amico, Director, OCEFT
Barry Breen, Director, OSRE
James C. Nelson, Associate General Counsel, Cross-Cutting Issues Law Office
Barry Hill, Director, Office of Environmental Justice
John Fogarty, Acting Director, Office of Planning and Policy Analysis
Craig Hooks, Director, Federal Facilities Enforcement Office
Rich Lemley, Director, Facilities Management and Services Division
Steve Zeigler, Chief, Security and Property Management Branch
Regional Enforcement Division Directors, Regions I-X
Regional Science and Technology Division Directors, Regions I-X
Regional Enforcement Coordinators, Regions I-X
Regional Security Managers, Regions I-X
ORE Division Directors
OC Division Directors
OSRE Division Directors
Louis Halkias, Acting Director, Criminal Investigations Division
Jonathan Cole, Director, Legal Counsel and Resource Management Division
Diana A. Love, Director, NEIC
Gerald Bryan, Director, NETI
Yvette Jackson, OARM
Ken Gigliello, OC

The Do's and Don'ts of Using U.S. EPA Credentials

These do's and don'ts are established based on good management practices for ensuring the proper use of EPA credentials by *EPA employees*. The practical purpose of the do's and don'ts is to make EPA employees aware of the importance to safeguard credentials, and limit their use to ONLY enforcement functions.

DO'S	DON'TS
Do use for official duties described in the credentials	Do NOT use for non-enforcement government business
Do use to conduct compliance inspections	Do NOT allow anyone to hold or take possession of your credentials
Do use to conduct compliance investigations	Do NOT loan the credentials to anyone. This includes other EPA employees.
Do use when responding to environmental complaints and/or spills	Do NOT photocopy the credentials
Do use to conduct facility audits	Do NOT fail to report a lost or stolen credentials to your supervisor
Do use to verify status as an EPA official when interviewing witnesses in the field	Do NOT allow anyone else to photocopy or use the credentials
Do use as identification for entry into facilities regulated under federal environmental laws and regulations	
Do safeguard storage of credentials	
Do always immediately report if the EPA credentials is lost or stolen to your immediate supervisor	

FACT SHEET ON CREDENTIALS ISSUED TO EPA EMPLOYEES DO'S AND DON'TS

5/23/00

Source: EPA Security Manual, Physical Security Section, Volume 4850-1, dated 7/16/84

DEFINITION

The 1984 Security Manual defines an EPA credential as: “An EPA credential is a pocket warrant authorized by the Administrator, Assistant Administrator, or Regional Administrator that identifies the bearer as having the authority to act in an enforcement, inspection, survey, or investigation capacity.” However, the EPA’s legal authority to perform the enforcement, inspection, survey, or investigation functions is based on the applicable federal environmental statutes passed by the United States Congress and signed by the President of the United States. **The credential evidences the proper delegation of this authority and does not provide independently the authority to undertake these activities.**

POLICY

EPA credentials should be issued only to those officers and employees who routinely need them to actively perform official enforcement, inspection, survey or investigative functions. EPA credentials generally are not issued to non-EPA employees, but in certain situations may be issued to State or tribal personnel, contractors, or grantees. In the event that non-EPA employees are authorized by the Administrator, Regional Administrator, or Assistant Administrator to possess EPA credentials, the credentials will be issued by the Regional Office, Lab, or other organization which has responsibility for overseeing the duties of the credentialed non-EPA employee.

LANGUAGE

The language on the EPA credential states:

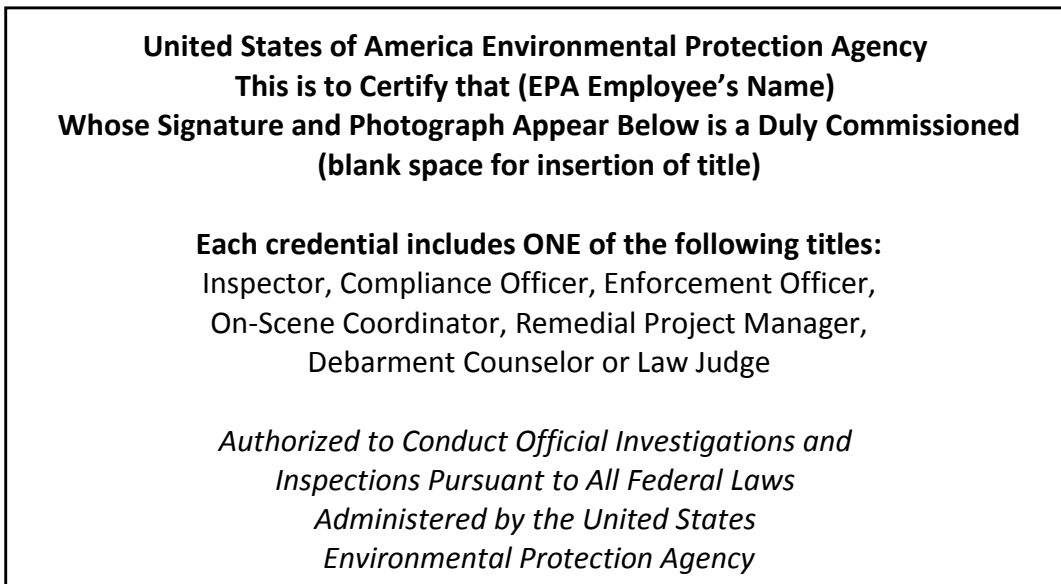

ISSUANCE

The requesting Headquarters program, media office, Regional office or Lab, should transmit a brief memorandum of justification to the Headquarters Office of Administration and Resources Management (OARM) requesting credentials to be issued to specific EPA employees. The memo should include the names, titles, organization, official duties, date of request, and the signature of requesting official. The requesting party is responsible for ensuring that the bearer has met applicable training requirements (e.g., EPA Order 3500.1). OARM (Security Management) will issue the federal credentials to the named employees after review of the information.

ACCOUNTABILITY

Since credentials are issued only to assist the bearer in the performance of official duties, the credentials should be returned to OARM when the bearer leaves the position requiring the EPA credentials. The employee's office should send OARM a brief note explaining the reason the credentials are being returned (e.g., retirement, employee reassigned to a position not requiring a credential)

If the EPA credentials are lost or stolen, the bearer should promptly notify his or her immediate supervisor, in writing, and a copy should be sent to OARM. A brief report of the circumstances surrounding the loss or theft should be forwarded to the Security Management Staff along with the new request. If a new set of credentials is required, the above procedures will be followed.

Failure to promptly notify the supervisor of a lost or stolen credential could result in disciplinary action against the bearer.

RENEWAL

EPA credentials will be renewed every three (3) years by OARM. The Security Management Official will transmit a list of Regional employees whose credentials will expire to the Security Representative in each Region for review. The Security representative is responsible for

ensuring that all listed personnel still have a need for the credential and applicable training is up-to-date. Once the list has been updated and returned to the HQ Security Management Official, OARM will renew the Regional credentials. All credentials are reissued on a rolling monthly basis to each Region (e.g., January for Region I, February for Region II, etc.)

Each Headquarters Office will receive a listing of employees whose credentials will expire. The Office Director is responsible for ensuring that all listed personnel still have a need for the credential and applicable training is up-to-date. OARM will renew these credentials on a first-come, first-served basis. All Headquarters credentials expire in December of the calendar year.

Appendix G – EPA's Memorandum On Entry Procedures

UNITED STATES ENVIRONMENTAL PROTECTION AGENCY
WASHINGTON, D.C. 20460

MEMORANDUM

OFFICE OF ENFORCEMENT

TO: Regional Administrators
Surveillance and Analysis Division Directors
Enforcement Division Directors

FROM: Assistant Administrator for Enforcement

SUBJECT: Conduct of Inspections After the Barlow's Decision

I. Summary

This document is intended to provide guidance to the Regions in the conduct of inspections in light of the recent Supreme Court decision in *Marshall v. Barlow's, Inc.*, U.S., 98 S. Ct. 1816 (1978). The decision bears upon the need to obtain warrants or other process for inspections pursuant to EPA-administered Acts.

In Barlow's, the Supreme Court held that an OSHA inspector was not entitled to enter the non-public portions of a work site without either (1) the owner's consent, or (2) a warrant. The decision protects the owner against any penalty or other punishment for insisting upon a warrant.

In summary, Barlow's should only have a limited effect on EPA enforcement inspections:

- Inspections will generally continue as usual;
- Where an inspector is refused entry, EPA will seek a warrant through the U.S. Attorney;
- Sanctions will not be imposed upon owners of establishments who insist on a warrant before allowing inspections of the non-public portions of an establishment.

The scope of the Barlow's decision is broad. It affects all current inspection programs of EPA, including inspections conducted by State personnel and by contractors. The Agency's procedures for inspections, particularly where entry is denied, were largely in accord with the provisions of Barlow's before the Supreme Court issued its ruling. Nevertheless, a number of changes in Agency procedure are warranted. Thus, it is important that all personnel involved in the inspection process be familiar with the procedural guidelines contained in this document.

This document focuses on the preparation for and conduct of inspections, including (1) how to proceed when entry is denied, (2) under what circumstances a warrant is necessary, and (3) what showing is necessary to obtain a warrant.

II. Conduct of Inspections

The following material examines the procedural aspects of conducting inspections under EPA-administered Acts. Inspections are considered in three stages: (1) preparation for inspection of premises, (2) entry onto premises, and (3) procedures to be followed where entry is refused.

A. Preparation

Adequate preparation should include consideration of the following factors concerning the general nature of warrants and the role of personnel conducting inspections.

(1) Seeking a Warrant Before Inspection

The Barlow's decision recognized that, on occasion, the Agency may wish to obtain a warrant to conduct an inspection even before there has been any refusal to allow entry. Such a warrant may be necessary when surprise is particularly crucial to the inspection, or when a company's prior bad conduct and prior refusals make it likely that warrantless entry will be refused. Pre-inspection warrants may also be obtained where the distance to a U.S. Attorney or a magistrate is considerable so that excessive travel time would not be wasted if entry were denied. At present, the seeking of such a warrant prior to an initial inspection should be an exceptional circumstance, and should be cleared through Headquarters. If refusals to allow entry without a warrant increase, such warrants may be sought more frequently. (For specific instructions on how to obtain a warrant, see Part D.)

(2) Administrative Inspections v. Criminal Investigations

It is particularly important for both inspectors and attorneys to be aware of the extent to which evidence sought in a civil inspection can be used in a criminal matter, and to know when it is necessary to secure a criminal rather than a civil search warrant. There are three basic rules to remember in this regard: (1) If the purpose of the inspection is to discover and correct, through civil procedures, noncompliance with regulatory requirements, and administrative inspection (civil) warrant may be used; (2) if the inspection is in fact intended, in whole or in part, to gather evidence for a possible criminal prosecution, a criminal search warrant must be obtained under Rule 41 of the Federal Rules of Criminal Procedure; and (3) evidence obtained during a valid civil inspection is generally admissible in criminal proceedings. These principles arise from the recent Supreme Court cases of Marshall v. Barlow's, Inc., *supra*; Michigan v. Tyler, U.S. 98 S.Ct. 1942 (1978); and U.S. v. LaSalle National Bank, U.S., 57 L. Ed: 2d 221 (1978). It is not completely clear whether a combined investigation for civil and criminal violations may be properly conducted under civil or "administrative" warrant, but we believe a civil warrant can properly be used unless the intention is clearly to conduct a criminal investigation.

(3) The Use of Contractors to Conduct Inspections

Several programs utilize private contractors to aid in the conduct of inspections. Since, for the purpose of inspections, these contractors are agents of the Federal government, the restrictions of the Barlow's decision also apply to them. If contractors are to be conducting inspections without the presence of actual EPA inspectors, these contractors should be given training in how to conduct themselves when entry is refused. With respect to obtaining or

executing a warrant, an EPA inspector should always participate in the process, even if he was not at the inspection where entry was refused.

(4) Inspections Conducted by State Personnel

The Barlow's holding applies to inspections conducted by State personnel and to joint Federal/State inspections. Because some EPA programs are largely implemented through the States, it is essential that the Regions assure that State-conducted inspections are conducted in compliance with the Barlow's decision, and encourage the State inspectors to consult with their legal advisors when there is a refusal to allow entry for inspection purposes. State personnel should be encouraged to contact the EPA Regional Enforcement Office when any questions concerning compliance with Barlow's arise.

With regard to specific procedures for States to follow, the important points to remember are: (1) The State should not seek forcible entry without a warrant or penalize an owner for insisting upon a warrant, and (2) the State legal system should provide a mechanism for issuance of civil administrative inspection warrants. If a State is enforcing an EPA program through a State statute, the warrant process should be conducted through the State judicial system. Where a State inspector is acting as a contractor to the Agency, any refusal to allow entry should be handled as would a refusal to an Agency inspector as described in section II.B.3. Where a State inspector is acting as a State employee with both Federal and State credentials, he would utilize State procedures unless the Federal warrant procedures are more advantageous, in which case, the warrant should be sought under the general procedures described below. The Regions should also assure that all States which enforce EPA programs report any denials of entry to the appropriate Headquarters Enforcement Attorney for the reasons discussed in section II.B.4.

B. Entry

(1) Consensual Entry

One of the assumptions underlying the Court's decision is that most inspections will be consensual and that the administrative inspection framework will thus not be severely disrupted. Consequently, inspections will normally continue as before the Barlow's decision was issued. This means that the inspector will not normally secure a warrant before undertaking an inspection but, in an attempt to gain admittance, will present his credentials and issue a notice of inspection where required. The establishment owner may complain about allowing an inspector to enter or otherwise express his displeasure with EPA or the Federal government. However, as long as he allows the inspector to enter, the entry is voluntary and consensual unless the inspector is expressly told to leave the premises. On the other hand, if the inspector has gained entry in a coercive manner (either in a verbal or physical sense), the entry would not be consensual.

Consent must be given by the owner of the premises or the person in charge of the premises at the time of the inspection. In the absence of the owner, the inspector should make a good faith effort to determine who is in charge of the establishment and present his credentials to that person. Consent is generally needed only to inspect the non-public portions of an establishment i.e., any evidence that an inspector obtains while in an area open to the public is admissible in an enforcement proceeding.

(2) Withdrawal of Consent

The owner may withdraw his consent to the inspector at any time. The inspection is valid to the extent to which it has progressed before consent was withdrawn. Thus, observations by the inspector, including samples and photographs, obtained before consent was withdrawn, would be admissible in any subsequent enforcement action. Withdrawal of consent is tantamount to a refusal to allow entry and should be treated as discussed in section II.B.3. below, unless the inspection had progressed far enough to accomplish its purposes.

(3) When Entry is Refused

Barlow's clearly establishes that the owner does have the right to ask for a warrant under normal circumstances.²⁴ Therefore, refusal to allow entry for inspection purposes will not lead to civil or criminal penalties if the refusal is based on the inspector's lack of warrant and one of the exemptions discussed in Part C does not apply. If the owner were to allow the inspector to enter his establishment only in response to a threat of enforcement liability, it is quite possible that any evidence obtained in such an inspection would be inadmissible. An inspector may, however, inform the owner who refused entry that he intends to seek a warrant to compel the inspection. In any event, when entry is refused, the inspector should leave the premises immediately and telephone the designated Regional Enforcement Attorney as soon as possible for further instructions. The Regional Enforcement Attorney should contact the U.S. Attorney's Office for the district in which the establishment desired to be inspected is located and explain to the appropriate Assistant United States Attorney the need for a warrant to conduct the particular inspection. The Regional Attorney should arrange for the United States Attorney to meet with the inspector as soon as possible. The inspector should bring a copy of the appropriate draft warrant and affidavits. Samples are provided in the appendix to this document.

(4) Headquarters Notification

It is essential that the Regions keep Headquarters informed of all refusals to allow entry. The Regional Attorney should inform the appropriate Headquarters Enforcement Attorney of any refusals to enter and should send a copy of all papers filed to Headquarters. It is necessary for Headquarters to monitor refusals and Regional success in obtaining warrants to evaluate the need for improved procedures and to assess the impact of Barlow's on our compliance monitoring progress.

C. Areas Where a Right of Warrantless Entry Still Exists

(1) Emergency Situations

In an emergency, where there is no time to get a warrant, a warrantless inspection is permissible. In Camara v. Municipal Court, 387 U.S. 523 (1967), the Supreme Court states that "nothing we say today is intended to foreclose prompt inspections, even without a warrant, that the law has traditionally upheld in emergency situations." Nothing stated in Barlow's indicates any intention by the court to retreat from this position. The Regions will always have

²⁴ FIFRA inspections are arguably not subject to this aspect of Barlow's. See discussion, p. 5 and 6.

to exercise considerable judgement concerning whether to secure a warrant when dealing with an emergency situation. However, if entry is refused during an emergency, the Agency would need the assistance of the U.S. Marshal to gain entry, and a warrant could probably be obtained during the time necessary to secure that Marshal's assistance.

An emergency situation would include potential imminent hazard situations, as well as situations where there is potential for destruction of evidence or where evidence of a suspected violation may disappear during the time that a warrant is being obtained.

(2) FIFRA Inspection

There are some grounds for interpreting Barlow's as not being applicable to FIFRA inspections. The Barlow's restrictions do not apply to areas that have been subject to a long standing and pervasive history of government regulation. An Agency administrative law judge held recently that even after the Barlow's decision, refusal to allow a warrantless inspection of a FIFRA regulated establishment properly subjected the owner to civil penalty. N. Jones & Co., Inc., I.F. & R Docket No. III-121C (July 27, 1978). For the present, however, FIFRA inspections should be conducted under the same requirements applicable to other enforcement programs.

(3) "Open Fields" and "In Plain View" Situations

Observation by inspectors of things that are in plain view, (i.e., of things that a member of the public could be in a position to observe) does not require a warrant. Thus, an inspector's observations from the public area of a plant or even from certain private property not closed to the public are admissible. Observations made even before presentation of credentials while on private property which is not normally closed to the public are admissible.

D. Securing a Warrant

There are several general rules for securing warrants. Three documents have to be drafted: (a) an application for a warrant, (b) an accompanying affidavit, and (c) the warrant itself. Each document should be captioned with the District Court of jurisdiction, the title of the action, and the title of the particular document.

The application for a warrant should generally identify the statutes and regulations under which the Agency is seeking the warrant, and should clearly identify the site or establishment desired to be inspected (including, if possible, the owner and/or operator of the site). The application can be a one or two-page document if all of the factual background for seeking the warrant is stated in the affidavit, and the application so states. The application should be signed by the U.S. Attorney or by his Assistant U.S. Attorney.

The affidavits in support of the warrant application are crucial documents. Each affidavit should consist of consecutively numbered paragraphs, which describe all of the facts that support warrant issuance. If the warrant is sought in the absence of probable cause, it should recite or incorporate the neutral administrative scheme which is the basis for inspecting the particular establishment. Each affidavit should be signed by someone with personal knowledge of all the facts stated. In cases where entry has been denied, this person would most likely be the

inspector who was denied entry. Note that an affidavit is a sworn statement that must either be notarized or personally sworn to before the magistrate.

The warrant is a direction to an appropriate official (an EPA inspector, U.S. Marshal or other Federal officer) to enter a specifically described location and perform specifically described inspection functions. Since the inspection is limited by the terms of the warrant, it is important to specify to the broadest extent possible the areas that are intended to be inspected, any records to be inspected, any samples to be taken, and any articles to be seized, etc. While a broad warrant may be permissible in civil administrative inspections, a vague or overly broad warrant will probably not be signed by the magistrate and may prove susceptible to constitutional challenge. The draft warrant should be ready for the magistrate's signature at the time of submission via a motion to quash and suppress evidence in Federal District court. Once the magistrate signs the draft warrant, it is an enforceable document. Either following the magistrate's signature or on a separate page, the draft warrant should contain a "return of service" or "certificate of service". This portion of the warrant should indicate upon whom the warrant was personally served and should be signed and dated by the inspector. As they are developed, more specific warrant issuance documents will be drafted and submitted to the Regions.

E. Standards or Bases for the Issuance of Administrative Warrants

The Barlow's decision establishes three standards or bases for the issuance of administrative warrants. Accordingly, warrants may be obtained upon a showing: 1) of traditional criminal probable cause, 2) of civil probable cause, or 3) that the establishment was selected for inspection pursuant to a neutral administrative inspection scheme.

(1) Civil Specific Probable Cause Warrant

Where there is some specific probable cause for issuance of a warrant such as an employee complaint or competitor's tip, the inspector should be prepared to describe to the U.S. Attorney in detail the basis for this probable cause.

The basis for probable cause will be stated in the affidavit in support of the warrant. This warrant should be used when the suspected violation is one that would result in a civil penalty or other civil action.

(2) Civil Probable Cause Based on a Neutral Administrative Inspection Scheme

Where there is no specific reason to think that a violation has been committed, a warrant may still be issued if they Agency can show that the establishment is being inspected pursuant to a neutral administrative scheme. As the Supreme Court stated in Barlow's:

"Probable cause in the criminal law sense is not required. For purposes of an administrative search, such as this, probable cause justifying the issuance of a warrant may be based not only on specific evidence of an existing violation, but also on a showing that "reasonable legislative or administrative standards for conducting an . . . inspection are satisfied with respect to a particular (establishment)." A warrant showing that a specific business has been chosen for an OSHA search on the basis of a general administrative plan for the enforcement of the act derived from neutral sources such as, for example, dispersion of employees in various type of industries across a given area, and the desired frequency of searches in any of the lesser divisions of the area, would protect an employer's Fourth Amendment rights.

Every program enforced by the Agency has such a scheme by which it prioritizes and schedules its inspections. For example, a scheme under which every permit holder in a given program is inspected on an annual basis is a satisfactory neutral administrative scheme. Also, a scheme in which one out of every three known PCB transformer repair shops is inspected on an annual basis is satisfactory, as long as neutral criteria such as random selection are used to select the individual establishment to be inspected. Headquarters will prepare and transmit to the Regions the particular neutral administrative scheme under which each program's inspections are to be conducted. Inspections not based on specific probable cause must be based on neutral administrative schemes for a warrant to be issued. Examples of two neutral administrative schemes are provided in the appendix. (Attachments II and III)

The Assistant U.S. Attorney will request the inspector to prepare and sign an affidavit that states the facts as he knows them. The statement should include the sequence of events culminating in the refusal to allow entry and a recitation of either the specific probable cause or the neutral administrative scheme which led to the particular establishment's selection for inspection. The Assistant U.S. Attorney will then present a request for an inspection warrant, a suggested warrant, and the inspector's affidavit to a magistrate or Federal district court judge.²⁵

²⁵ The Barlow's decision states that imposing the warrant requirement on OSHA would not invalidate warrantless search provisions in other regulatory statutes since many such statutes already "envison resort to Federal court enforcement when entry is refused". There is thus some question as to whether the existence of a non-warrant Federal court enforcement mechanism in a statute requires the use of that mechanism rather than warrant issuance. We believe that the Barlow's decision gives the Agency the choice of whether to proceed through warrant issuance or through an application for an injunction, since the decision is largely based on the fact that a warrant procedure imposes virtually no burden on the inspecting Agency. In addition, any Agency could attempt to secure a warrant prior to inspection on an ex parte basis, something not available under normal injunction proceedings. Several of the acts enforced by the EPA have provisions allowing the Administrator to seek injunctive relief to assure compliance with the various parts of a particular statute. There may be instances where it would be more appropriate to seek injunctive relief to gain entry to a facility than to attempt to secure a warrant for inspection, although

(3) Criminal Warrants

Where the purpose of the inspection is to gather evidence for a criminal prosecution, the inspector and the Regional Attorney should request that the U.S. Attorney seek a criminal warrant under Rule 41 of the Federal Rules of Criminal Procedure. This requires a specific showing of probable cause to believe that evidence of a crime will be discovered. Agency policy on the seeking of criminal warrants has not been affected by Barlow's. The distinction between administrative inspections and criminal warrant situations is discussed in Section II.A.2.

F. Inspecting with a Warrant

Once the warrant has been issued by the magistrate or judge, the inspector may proceed to the establishment to commence or continue the inspection. Where there is a high probability that entry will be refused even with a warrant or where there are threats of violence, the inspector should be accompanied by a U.S. Marshal when he goes to serve the warrant on the recalcitrant owner. The inspector should never himself attempt to make any forceful entry of the establishment. If the owner refuses entry to an inspector holding a warrant but not accompanied by a U.S. Marshal, the inspector should leave the establishment and inform the Assistant to the U.S. Attorney and the designated Regional Attorney. They will take appropriate action such as seeking a citation for contempt. Where the inspector is accompanied by a U.S. Marshal, the Marshal is principally charged with executing the warrant. Thus, if refusal or threat to refuse occurs, the inspector should abide by the U.S. Marshal's decision whether it is to leave, to seek forcible entry, or otherwise.

The inspector should conduct the inspection strictly in accordance with the warrant. If sampling is authorized, the inspector must be sure to carefully follow all procedures, including the presentation of receipts for all samples taken. If records or other property are authorized to be taken, the inspector must receipt the property taken and maintain an inventory of anything taken from the premises. This inventory will be examined by the magistrate to assure that the warrant's authority has not been exceeded.

G. Returning the Warrant

After the inspection has been completed, the warrant must be returned to the magistrate. Whoever executes the warrant, (i.e., whoever performs the inspection), must sign the return of service form indicating to whom the warrant was served and the date of service. He should then return the executed warrant to the U.S. Attorney who will formally return it to the magistrate or judge. If anything has been physically taken from the premises, such as records or samples, an inventory of such items must be submitted to the court, and the inspector must be present to certify that the inventory is accurate and complete.

at this point we cannot think of any. However, since the warrant process will be far more expeditious than the seeking of an injunction, any decision to seek such an injunction for inspection purposes should be cleared through appropriate Headquarters staff.

III. Conclusion

Except for requiring the Agency to formalize its neutral inspection schemes, and for generally ending the Agency's authority for initiating civil and/or criminal actions for refusal to allow warrantless inspections, Barlow's should not interfere with EPA enforcement inspections.

Where there is doubt as to how to proceed in any entry case, do not hesitate to call the respective Headquarters program contact for assistance.

Marvin B. Durning

Appendix H – EPA’s Policy on the Use of Digital Cameras for Inspections

*EPA’s Policy on the Use of Digital Cameras for Inspections can be found at
[https://www.epa.gov/compliance/guidance-digital-camera-guidance-epa-civil-
inspections-and-investigations](https://www.epa.gov/compliance/guidance-digital-camera-guidance-epa-civil-inspections-and-investigations)*

Appendix I – EPA's Memorandum On Deficiency Notice Guidance

UNITED STATES ENVIRONMENTAL PROTECTION AGENCY

WASHINGTON, D.C. 20460

MEMORANDUM

OFFICE OF ENFORCEMENT

SUBJECT: "Deficiency Notice" Implementation to Improve Quality Assurance in NPDES Permittee Self-Monitoring Activities

FROM: Director, Enforcement Division (EN-338)

TO: Enforcement Division Directors, Regions I - X
Surveillance and Analysis Division Directors, Regions I - X
Director, National Enforcement Investigations Center, Denver

The Enforcement Divisions and the Surveillance and Analysis Divisions in several Regions have developed a form, called a Deficiency Notice, which their inspectors issue at the end of compliance inspections. This Deficiency Notice alerts NPDES permittees to problems in their routine self-monitoring activities. On June 11, 1979, the Office of Water Enforcement proposed that all the Regional offices adopt this form along with the Guidance for its use, and asked for your comments on this proposal. The Deficiency Notice and Guidance, which are attached, reflect your comments.

We have ordered the Deficiency Notice Forms, which will be printed on no-carbon-required paper and will be color coded in pads to correlate with the NPDES Compliance Inspection Form (EPA 3560-3). You may reproduce the attached form for use until you receive these forms.

The Deficiency Notice was designed so that State NPDES programs might easily use it. However, EPA cannot now sanction its use by the States since the Office of Management and Budget (OMB) has not authorized the form for non-Federal use. We will attempt to get OMB approval.

Since the Deficiency Notice provides a swift and simple mechanism for responding to deficiencies in self-monitoring data, I believe that its use will substantially improve the performance of wastewater treatment facilities without creating additional resource burdens or enforcement problems. If you have any questions about the Deficiency Notice or its use, please do not hesitate to call Gary Polvi of my staff at 755-0994.

J. Brian Molloy

Attachments

DEFICIENCY NOTICE GUIDANCE

Purpose

The purpose for using the Deficiency Notice is to provide a swift and simple method for improving the quality of data from NPDES self-monitoring activities. Since an inspector may issue a Deficiency Notice during any NPDES compliance inspection to alert the permittee to either existing or potential problems in self-monitoring, its receipt prompts the permittee to quickly take corrective action, as close as possible to the time the inspector perceives the problem.

Scope

The Deficiency Notice is a tool for use in conjunction with any type of EPA NPDES compliance inspection (i.e., compliance evaluation, sampling, performance audit, biomonitoring, etc.), during which the inspector identifies problems with self-monitoring that warrant response.

The Deficiency Notice and Guidance were designed so that State NPDES compliance monitoring programs could also easily use them. (Note the use of the term "regulatory authority" throughout this guidance.) However, EPA cannot yet sanction the States' use of this form because the Office of Management and Budget (OMB) has not yet approved the form for non-Federal use.

Use of the Deficiency Notice does not apply to a wide range of possible permit violations. It is to be used by the inspector to alert permittees to deficiencies in their self-monitoring activities only. The enforcement office of the regulatory authority (i.e., the EPA Regional Enforcement Division or its State counterpart), not the inspector, will continue to handle violations relative to compliance schedules or effluent limitations.

Form Description

The Deficiency Notice (see attachment) is one page long and is for use in conjunction with the standard EPA Compliance Inspection Form (EPA 3560-3 September, 1977). The reverse side of the Notice contains general instructions to inspectors for completing the form. The regulatory authority using the form may add other specific instructions that do not conflict with this guidance.

The form has four sections: (1) basic facility data, (2) deficiencies, (3) comments, and (4) inspector identification. These sections contain individual spaces where the inspector during an inspection can log deficiencies in the following self-monitoring activities: (1) monitoring location, (2) flow measurement, (3) sample collection/holding time, (4) sample preservation, (5) test procedures, (6) record keeping, (7) other self-monitoring deficiencies (i.e., sampling frequency, instrument calibration, etc.). Since the existing Compliance Inspection Form (which inspectors now complete) includes questions and answers relating to the above seven activities, inspectors should not need much additional time to complete this Deficiency Notice.

Administrative Procedures

With few exceptions (see March 7, 1977 [EMS Guide](#)), the handling and tracking of Deficiency Notices will follow the normal EPA Enforcement Management System (EMS) procedures. Inspectors can issue the Deficiency Notice to a permittee immediately following a compliance inspection if they discover any permit deficiencies which the Notice includes. Under unusual circumstances inspectors may delay issuing a Deficiency Notice until after conferring with other officials of the regulatory authority.

EMS requires the offices responsible for inspections and for NPDES enforcement to jointly establish a policy delineating the procedure for the permittee to appropriately respond to the Deficiency Notice. In the EPA Regions, the Directors of the Enforcement Division and the Surveillance and Analysis (S&A) Division will develop this policy. If the offices agree to allow the permittee to submit a separate written response rather than to include the response as part of a regular Discharge Monitoring Report (DMR) submission, they will require the inspector to record the necessary mailing instructions and deadline for response under the additional comment section of the Deficiency Notice. The inspector indicates the appropriate method for the permittee's response in the "requested action" section of the Deficiency Notice. Due to the nature of most self-monitoring problems it is reasonable for the regulatory authority to ask that the permittee submit a written description of any corrective actions within 15 work days after receiving the Notice. Where the permittee is asked to respond as part of a regular DMR submission, a similar reporting time allowance should be allotted. In either response option, the inspector should always indicate in the Deficiency Notice the requested date for permittee response.

Having the permittee document Deficiency Notice corrective actions as part of a regular DMR submission establishes accountability for the compliance inspection in the official NPDES permit compliance file even before a compliance review is undertaken. This is a resource efficient method of documenting the minimum benefit from performing inspections.

The issuance of a Deficiency Notice is not a formal enforcement action. It is not intended and must not be construed as an administrative or legal order to the permittee. Therefore, the action by the permittee to respond is voluntary, but incentive for such response comes from the positive consideration it may have on further formal enforcement follow-up of the inspection.

When the regulatory authority receives the permittee's response to the Deficiency Notice, they will review the inspection data and the permittee's response according to EMS procedures. If during routine reviews of inspection data, the authorities note deficiencies in self-monitoring data and note that the inspector did not issue a Deficiency Notice, they may issue one at any time.

The responsibility for all enforcement activity shall always remain in the enforcement/compliance review office of the regulatory authority. After agreement between the Directors of the Regional Enforcement Division and the S&A Division, these offices should incorporate details for insuring which office retains which responsibility into the Regional EMS. Whether or not a Deficiency Notice has been issued, the enforcement office of the regulatory

authority can take administrative or legal action at any time. Also, a Deficiency Notice may not be appropriate in those cases where additional enforcement action is expected or litigation against the permittee is already underway.

EPA Deficiency Notice Form

DEFICIENCY NOTICE NATIONAL POLLUTANT DISCHARGE ELIMINATION SYSTEM (NPDES)	PERMITTEE (<i>Facility</i>) NAME AND ADDRESS		
PERMITTEE REPRESENTATIVE (<i>Receiving this Notice</i>)/Title		NPDES PERMIT NO.	
During the compliance inspection carried out on (<i>Date</i>) the deficiencies noted below were found. Additional areas of deficiency may be brought to your attention following a complete review of the Inspection Report and other in-formation on file with the REGULATORY AUTHORITY administering your NPDES PERMIT.			
DEFICIENCIES			
MONITORING LOCATION (<i>Describe</i>)			
FLOW MEASUREMENT (<i>Describe</i>)			
SAMPLE COLLECTION / HOLDING TIME (<i>Describe</i>)			
SAMPLE PRESERVATION (<i>Describe</i>)			
TEST PROCEDURES SECTION 304(h), 40 CFR Part 136 (<i>Describe</i>)			
RECORD KEEPING (<i>Describe</i>)			
OTHER SELF-MONITORING DEFICIENCIES (<i>Describe</i>)			
ADDITIONAL COMMENTS			
REQUESTED ACTION—Your attention to the correction of the deficiencies noted above is requested. Receipt of a description of the corrective actions taken will be considered in the determination of the need for further Administrative or Legal Action. Your response is to be (Inspector line out inappropriate response method) : (1) Include with your next <i>NPDES Discharge Monitoring Report (DMR)</i> or (2) submitted as directed by the <i>inspector</i> . Questions regarding possible follow-up action can be answered by the REGULATORY AUTHORITY to which your DMRs are submitted and which administers your NPDES Permit.			
INSPECTOR'S SIGNATURE	INSPECTOR'S ADDRESS/PHONE NO.	REGULATORY AUTHORITY/ADDRESS	DATE
INSPECTOR'S PRINTED NAME			

Appendix J – Inspection Conclusion Data Summary (ICDS)

EPA MANUAL INSPECTION CONCLUSION DATA SHEET (ICDS) FORM

1. **Region:** _____ **Facility Name/Location:** _____

2. **General Facility Permit ID or Media-Specific Permit ID number (e.g. NPDES permit #):**

3. **SIC (4-digit):** □□□□ OR **NAICS Code (5-digit):** □□□□□

4. **Date of Inspection:** _____ (mm/dd/yyyy)

5. **Media Type (check one only)**

CAA-Stationary CWA-NPDES GLP TSCA Lead Paint CAA 112r

CAA-Mobile Sources RCRA UST TSCA core, PCBs, asbestos

6. **Deficiencies:** Did you observe deficiencies during inspection? Yes No [N/A is not allowed]

a. *If YES, go to #7*

b. *If NO, go to #9*

7. **If YES:** Did you communicate the deficiencies to the facility during the inspection? Yes No

8. **Actions Taken:** Did you observe or see the facility take any actions during the inspection to address the deficiencies communicated? Yes No [N/A is not allowed]

a. *If NO, go to #9*

b. *If YES, check the action(s) taken, or describe any other actions taken. (Check all that apply)*

Action(s) taken

____ Verified compliance with previously issued enforcement action -part or all conditions

____ Corrected recordkeeping deficiencies

____ Corrected monitoring deficiencies

____ Completed a notification or a report

____ Requested a permit application

____ Implemented new or improved management practices or procedures

____ Improved pollutant identification (e.g., labeling, manifesting, storage, etc.)

____ Reduced pollution (e.g., use reduction, industrial process change, emissions or discharge change, etc.). **Specify the pollutant(s) reduced only if this action is checked.**

Water: Ammonia BOD COD TSS O/G TC DO Metals CN

Air: NOx SO2 PM VOC Metals HAPs CO

List other actions observed or other pollutants reduced: _____

9. **Assistance:** Did you provide *general* assistance based on national policy? Yes No

Did you provide *site-specific* assistance based on national policy? Yes No

Note: EPA inspectors are **not required** to provide compliance assistance.

Optional Information: Describe actions taken or assistance provided to assist the facility.

Appendix K – Draft Guidance for Releasing Civil Inspection Reports

[Appendix K: Draft Guidance for Releasing Civil Inspection Reports]

Appendix L – Sample Discharge Monitoring Report (DMR) Form

DMR Copy of Record

Permit
 Permit #: _____ Permittee: _____ Facility: _____
 Major: _____ Permittee Address: _____ Facility Location: _____
 Permitted Feature: 101 Intake Structure Discharge: 101-1 HYDRAULICALLY DREDGED MATERIAL
Report Dates & Status
 Monitoring Period: From 03/01/15 to 03/31/15 DMR Due Date: 04/30/15 Status: NetDMR Validated
 Considerations for Form Completion

Principal Executive Officer
 First Name: _____ Title: _____ Telephone: _____
 Last Name: _____
 No Date Indicator (NODI)
 Form NODI: --

Code	Parameter Name	Monitoring Location	Season #	Param. NODI	Quantity or Loading					Quality or Concentration					# of Ex.	Frequency of Analysis	Sample Type	
					Qualifier 1	Value 1	Qualifier 2	Value 2	Units	Qualifier 1	Value 1	Qualifier 2	Value 2	Units				
00011	Temperature, water deg. fahrenheit	7 - Intake from Stream	0	--	Sample													
					Permit Req.													
					Value NODI													
00056	Flow rate	7 - Intake from Stream	0	--	Sample	=	438650		07 - gal/d									
					Permit Req.													
					Value NODI													
00400	pH	7 - Intake from Stream	0	--	Sample				=	6.4				=	7.2		12 - SU	02/30 - Twice Per Month
					Permit Req.												12 - SU	01/30 - Monthly
					Value NODI													
00500	Solids, total	7 - Intake from Stream	0	--	Sample									=	6680		19 - mg/L	01/30 - Monthly
					Permit Req.												19 - mg/L	01/30 - Monthly
					Value NODI													
01032	Chromium, hexavalent [as Cr]	7 - Intake from Stream	0	--	Sample									<	0.01		19 - mg/L	01/30 - Monthly
					Permit Req.												19 - mg/L	01/30 - Monthly
					Value NODI													
01034	Chromium, total [as Cr]	7 - Intake from Stream	0	--	Sample									=	4.31		19 - mg/L	01/30 - Monthly
					Permit Req.												19 - mg/L	01/30 - Monthly
					Value NODI													
01051	Lead, total [as Pb]	7 - Intake from Stream	0	--	Sample									=	15.1		19 - mg/L	01/30 - Monthly
					Permit Req.												19 - mg/L	01/30 - Monthly
					Value NODI													
22456	Polynuclear Aromatic Hydrocarbons (PAHs)	7 - Intake from Stream	0	--	Sample									<	5.41		28 - ug/L	01/30 - Monthly
					Permit Req.												28 - ug/L	01/30 - Monthly
					Value NODI													
50047	Flow, maximum during 24 hr period	7 - Intake from Stream	0	--	Sample				=	758250							07 - gal/d	01/01 - Daily
					Permit Req.												07 - gal/d	01/01 - Daily
					Value NODI													

Submission Note
 If a parameter row does not contain any values for the Sample nor Effluent Trading, then none of the following fields will be submitted for that row: Units, Number of Excursions, Frequency of Analysis, and Sample Type.

Edit Check Errors
 No errors.

Comments
 The NetDMR parameter is listed as "Temperature, water deg. Fahrenheit" (code 00011) and the NetDMR requires the "monthly average" and "daily maximum." These two reporting requirements (between NetDMR and the NPDES permit) are not the same, so based on our understanding, we are providing the information required by the NPDES permit as an attachment.

Attachments

Name	Type	Size
Mar2015InfAttachment.pdf	pdf	80692

Report Last Saved By

User: _____ Date/Time: 2015-04-28 08:34 (Time Zone: -04:00)
 Name: _____
 E-Mail: _____

Appendix M – Example Chain-of-Custody Form

U.S. ENVIRONMENTAL PROTECTION AGENCY
Environmental Services Division

CHAIN OF CUSTODY RECORD

REGION VIII, ONE DENVER PLACE
999 18TH STREET
DENVER, CO 80202-2413

SAMPLERS: <i>(Signature)</i>						NO OF CON- TAINERS														
STAT. NO	DATE	TIME	C O M P	G R A B	STATION LOCATION															
Relinquished by: <i>(Signature)</i>			Date/Time		Received by: <i>(Signature)</i>			Relinquished by: <i>(Signature)</i>			Date/Time		Received by: <i>(Signature)</i>							
Relinquished by: <i>(Signature)</i>			Date/Time		Received by: <i>(Signature)</i>			Relinquished by: <i>(Signature)</i>			Date/Time		Received by: <i>(Signature)</i>							
Relinquished by: <i>(Signature)</i>			Date/Time		Received for Laboratory by: <i>(Signature)</i>			Date/Time		Remarks										
Distribution Original Accompanies Shipment First Copy to Coordinator Field File Second Copy to Representative of Inspected Facility										Split Samples <input type="checkbox"/> Accepted <input type="checkbox"/>		Signature _____								

Appendix N – Updated Fact Sheet: Department of Transportation Hazardous Materials

DEPARTMENT OF TRANSPORTATION HAZARDOUS MATERIALS TRAINING

What are DOT training requirements?

DOT's training requirements can be found at 49 CFR Part 172, Subpart H. In general, any employee who has a responsibility working with hazardous materials (hazmat) that is placed in commerce must have hazmat training. The employee must be familiar or aware of the requirements enabling the employee to recognize and identify hazardous materials, i.e., hazardous samples vs. non-hazardous samples, consistent with the hazard communication standards. The training must be commensurate with functions and responsibilities of the employee.

Why does hazmat training apply to me?

As an inspector, you are likely to be a hazmat employee because you collect samples during an inspection and prepare the hazmat samples for transportation. The EPA is a hazmat employer because the Agency causes hazmat to be transported or shipped in commerce through its employees. DOT defines "hazmat employer" to include any department, agency, or instrumentality of the United States, a State, a political subdivision of a State, or an Indian Nation. Administrative and secretarial staff are also subject to DOT training if their responsibilities cause hazmat materials to be placed into commerce, i.e., preparing shipping papers.

Does my EPA training substitute for DOT training requirements?

The EPA Health & Safety course provides the inspector with information on protecting oneself for on-the-job hazards and would meet DOT's Safety training requirement. It does **not** meet the General awareness/familiarization requirement. See DOT's training requirements.

What type of DOT training do I need?

DOT hazmat training is function-specific. For most inspectors, the general awareness hazardous materials training course found on the DOT's website will be sufficient to meet the DOT training requirements. Alternatively, the employer can provide function specific training from other sources. (see below).

What are DOT's training requirements for hazardous materials?

DOT's hazmat training, 49 CFR Part 172.704, focuses on three requirements applicable to inspectors and administrative staff:

- General awareness/familiarization
 - ✓ Each hazmat employee shall be provided general awareness/familiarization training designed to provide familiarity with the hazmat requirements and to enable the employee to recognize and identify hazardous materials consistent with the hazard communication standards.

What are DOT's requirements for hazardous materials?

- Function-specific

- ✓ Each hazmat employee shall be provided function-specific training as it applies to the employee's job responsibilities.
- Safety
 - ✓ Emergency response information required by part 172, subpart G, i.e., information that can be used in the mitigation of an incident involving hazardous materials; Measures to protect the employee from the hazards associated with hazardous materials to which they may be exposed in the work place, including specific measures the hazmat employer has implemented to protect employees from exposure; and Methods and procedures for avoiding accidents, such as the proper procedures for handling packages containing hazardous materials.

Where can I find training opportunities?

A good training resource is DOT's hazmat page, hazmat.dot.gov/training. You can download the instructor's and student's training manual for in-house use. The training manual does include test questions. Self-training is acceptable by DOT so long as 49 CFR Part 172.704 training requirements are met. The DOT's Transportation Safety Institute in Oklahoma City, OK offers training on-site. Course dates are available from the website.

In addition to DOT's hazmat site, this web link, hazmat.dot.gov/thirdpty.htm identifies third party providers who offer a variety of hazmat training courses.

How long does the certification last?

The hazardous materials training is required to be completed within the first 90 days of employment. The certification period is good for three years and then the hazardous materials training program must be retaken. If your job responsibilities change, your training needs may change.

Who is responsible for training?

The employer is responsible. DOT's definition of employer is not clear in terms of EPA's administrative structure. "Employer" could be defined as the Administrator or any other manager in direct supervisory line of the employee.

Who is responsible for keeping the training record?

The employer is responsible for keeping the employee's records.

What should be in the training record?

Documentation that shows the employee has completed the necessary training, and has been tested and certified.

Specifically, what documents need to be retained?

A record of current training, inclusive of the preceding three years must be retained for as long as the employee is employed by that employer as a hazmat employee and for 90 days thereafter. The record shall include the following information:

- (1) The inspector's name;
- (2) The most recent training completion date of the inspector's training;

- (3) A description, copy, or the location of the training materials used to meet the requirements;
- (4) The name and address of the person providing the training; and
- (5) Certification that the hazmat employee has been **trained and tested**.

Does the employee have to “pass” the test?

The requirements do not state that the employee must "pass" a test; however, an employee may only be certified in areas in which he/she can successfully perform their hazmat duties.

Know Your Shipper’s Requirements!

Before collecting samples, know which shipping company you will be using to ship your samples. Some require additional training and certification beyond the basic DOT requirements. Here are three common carriers with some of their requirements for shipping hazmat materials.

Federal Express (FedEx)

The shipping method you select determines what type of training FedEx expects you to have completed. If you plan to ship samples by ground, the DOT training requirements are sufficient. If you plan to ship the samples by air, then you must be trained according to International Air Transport Association (IATA) regulations. Successful completion of the IATA requirements will meet DOT’s hazard communications requirements. IATA training and information can be found at: www.iata.org.

United Postal Service (UPS)

Documentation that shows the employee has awareness training is acceptable by UPS for ground shipments. Shipments by air require IATA training.

United States Postal Service (USPS)

DOT’s general awareness training and testing is acceptable by USPS for both shipping by ground and air. However, the Postal Service does have limits which are more stringent than DOT’s regulations. Check this website for further details - <http://pe.usps.gov/text/dmm/c023.htm>

Before shipping, you should inquire with the shipping company if they have additional requirements for handling, packaging and shipment limitations for the hazmat materials.

Here are a few issues an inspector may face with the different shippers:

- Do you want them to meet you at the site? You may need to call ahead to schedule the pickup before you arrive at the site to collect samples.
- Do you plan on dropping the shipment off? Not all offices can accept dangerous goods and hazmat.
- Shipping papers may need to be typed, not handwritten. Do you bring a portable typewriter with you or type the shipping papers before leaving the office?

Appendix O – Supplemental Flow Measurement Information

SUPPLEMENTAL FLOW MEASUREMENT INFORMATION

Basic Hydraulic Calculations

The relationship between the flow rate (Q), the average velocity (V), and the cross-sectional area of the flow (A) is given by the following equation:

$$Q = VA$$

where Q = flow in cubic feet per second
 V = velocity in feet per second
 A = area in square feet.

To convert flow in cubic feet of water per second to flow in gallons of water per minute, the following proportionality is used:

$$\frac{\text{cubic feet}}{\text{second}} \times \frac{7.48 \text{ gallons water}}{\text{cubic foot of water}} \times \frac{60 \text{ seconds}}{\text{minute}} = \frac{\text{gallons}}{\text{minute}}$$

To convert from cubic feet per second to million gallons per day, multiply the number of cubic feet per second by 0.6463.

The cross-sectional area (A) of a pipe is described by:

$$A = 0.785d^2$$

where d = diameter of the pipe in feet.

Flow Measurement Devices

Flow data may be collected instantaneously or continuously. Instantaneous flows must be measured when samples are taken so that the pollutant concentrations can be correlated to flow data. In a continuous flow measurement system, flow measurements are summed to obtain a value for the total flow to verify NPDES permit compliance.

A typical continuous flow measurement system consists of a flow device, a flow sensor, transmitting equipment, a recorder, and a totalizer.

Instantaneous flow data can be obtained without using such a system. The primary flow device is constructed to yield predictable hydraulic responses related to the rate of wastewater or

water flowing through the device. As previously mentioned, examples of such devices include weirs and flumes, which relate water depth (head) to flow; Venturi meters, which relate differential pressure to flow; and electromagnetic flowmeters, which relate induced electric voltage to flow. In most cases, a standard primary flow device has undergone detailed testing and experimentation and its accuracy has been verified.

Flow is measured by many methods; some are designed to measure open channel flows, and others are designed to measure flows in pipelines. A complete discussion of all available flow measurement methods, their supporting theories, and the devices used are beyond the scope of this manual. The most commonly used flow measurement devices and procedures for inspecting them will be described briefly in the following paragraphs. For more detail, inspectors should consult the publications listed in References at the end of this chapter.

Primary Devices

Weirs. A weir consists of a thin vertical plate with a sharp crest that is placed in a stream, channel, or partly filled pipe. Figure O-1 shows a profile of a sharp-crested weir and indicates the appropriate nomenclature. Four common types of sharp-crested weirs are shown in Figure O-2. This figure illustrates the difference between suppressed and contracted rectangular weirs and illustrates Cipolletti (trapezoidal) and V-notch (triangular) weirs.

To determine the flow rate, it is necessary to measure the hydraulic head (height) of water above the crest of the weir. For accurate flow measurements, the crest must be clean, sharp, and level. The edge of the crest must not be thicker than 1/8 inch.

The rate of flow over a weir is directly related to the height of the water (head) above the crest at a point upstream of the weir where the water surface is level. To calculate the discharge over a weir, the head must first be measured by placing a measuring device upstream of the weir, at a distance of at least 4 times an approximate measurement of the head. A measurement can be taken at the weir plate to approximate the head. However, if this measurement is used to calculate the discharge, this value will provide only a rough estimate of the discharge.

The head-discharge relationship formulas for nonsubmerged contracted and suppressed rectangular weirs, Cipolletti weirs, and V-notch weirs are provided in Table O-1. Discharge rates for the 90-degree V-notch weir (when the head is measured at the weir plate) are included in Table O-2. Flow rates for 60- and 90-degree V-notch weirs can be determined from the graph in Figure O-3. Minimum and maximum recommended flow rates for Cipolletti weirs are provided in Table O-3. Figure O-4 is a nomograph for flow rates for rectangular weirs using the Francis formulas.

Parshall Flume. The Parshall flume is composed of three sections: a converging upstream section, a throat or contracted section, and a diverging or dropping downstream section. When there is free fall out of the throat of a Parshall flume, no diverging downstream section is required. It operates on the principle that when open channel water flows through a constriction in the channel, it produces a hydraulic head at a certain point upstream of the constriction that is proportional to the flow. The hydraulic head is used to calculate the flow.

Flow curves are shown in Figure O-5 to determine free flow through 3 inches to 50 feet Parshall flumes.

The Parshall flume is good for measuring open channel waste flow because it is self-cleaning; therefore, sand or suspended solids are unlikely to affect the operation of the device. The flume is both simple and accurate.

The flume size is given by the width of the throat section. Parshall flumes have been developed with throat widths from 1 inch to 50 feet. The configuration and standard nomenclature for Parshall flumes are provided in Figure O-6. Strict adherence to all dimensions is necessary to achieve accurate flow measurements. Figure O-6 provides Parshall flume dimensions for various throat widths, and Table O-4 provides the minimum and maximum flow rates for free flow through Parshall flumes.

For free nonsubmerged flow in a Parshall flume of throat and upstream head (H_a in feet), the discharge relationship for flumes of 8 feet or less is given by the general equation $Q = CWH_n$, where Q = flow.

Table O-5 provides the values of C , n , and Q for different sizes (widths) of the Parshall flumes. Nomographs, curves, or tables are readily available to determine the discharge from head observations.

Flow through a Parshall flume may also be submerged. The degree of submergence is indicated by the ratio of the downstream head to the upstream head (H_b/H_a), which is the submergence ratio. H_b is the height of water measured above the crest. The flow is submerged if the submerged ratio is:

- Greater than 0.5 for flumes under 3 inches
- Greater than 0.6 for flumes 6 to 9 inches
- Greater than 0.7 for flumes 1 to 8 feet
- Greater than 0.8 for flumes larger than 8 feet.

If submerged conditions exist, the inspector should apply a correction factor to the free flow determined using the relationship $Q = CWH_n$. These correction factors are shown in Figure O-7 for different sizes of the Parshall flume.

Palmer-Bowlus Flume. The Palmer-Bowlus flume is also composed of three sections: a converging upstream section, a contracted section or throat, and a diverging downstream section (Figure O-8). The upstream depth of the water (head) above the raised step in the throat is related to the discharge rate. The head should be measured at a distance $d/2$ upstream of the throat where d is the size (width) of the flume. The height of the step is usually unknown until the manufacturer's data are consulted, it is difficult to manually measure the height of water above the step at an upstream point. The dimensions for Palmer-Bowlus flumes are not standardized as they are for Parshall flumes. Therefore, no standard flow equation exists. Instead, rating curves are provided by manufacturers of Palmer-Bowlus flumes to relate the head to the discharge rate.

The flume must be installed with a minimum channel slope downstream to maintain critical flow through the flume and prevent the flume from becoming submerged. A small jump or rise in the water surface below the throat indicates that critical flow through the flume has probably occurred and submerged conditions do not exist. Accurate flow measurements can usually be obtained with upstream depths that are up to 95 percent of the pipe diameter. Table O-6 provides a table of the maximum slopes recommended for installation of Palmer-Bowlus flumes. Advantages of this type of flow measurement device are the following:

- It is easily installed in existing systems.
- Head loss is insignificant.
- Unit is self-cleaning.

Venturi Meter. The Venturi (differential pressure) meter is one of the most accurate primary devices for measuring flow rates in pipes. The Venturi meter is basically a pipe segment consisting of an inlet section, a converging section, and a throat, along with a diverging outlet section as illustrated in Figure O-9. The water velocity is increased in the constricted portion of the inlet section resulting in a decrease in the static pressure. The pressure difference between the inlet pipe and the throat is proportional to the square of the flow. The pressure difference can easily be measured very accurately, resulting in an accurate flow measurement. An advantage of the Venturi meter is that it causes little pressure (head) loss. The formula for calculating the flow in a Venturi meter is as follows:

$$Q = cKd_2^2 \sqrt{h_1 - h_2} \quad (\text{King1963})$$

where

Q	=	volume of water, in cubic feet per second
c	=	discharge coefficient, obtain from Table O-7. C varies with Reynold's number, meter surfaces, and installation
h1	=	pressure head at center of pipe at inlet section, in feet of water
h2	=	pressure head at throat, in feet of water
K	=	constant which relates d2 to d1 for Venturi meters. Obtain values of K from Table O-8 or calculate according to the formula

$$K = \frac{1}{4} \sqrt{\frac{2g}{1 - \left(\frac{d_2}{d_1}\right)^4}}$$

where

d ₂	=	throat diameter, in feet
d ₁	=	diameter of inlet pipe, in feet

Electromagnetic Flowmeter. The electromagnetic flowmeter operates according to Faraday's Law of Induction: the voltage induced by a conductor moving at right angles through a

magnetic field will be proportional to the velocity of the conductor through the field. In the electromagnetic flowmeter, the conductor is the liquid stream to be measured and the field is produced by a set of electromagnetic coils. A typical electromagnetic flowmeter is shown in Figure O-10. The induced voltage is transmitted to a converter for signal conditioning. The meter may be provided with recorder and totalizer using electric or pneumatic transmission systems. This type of flowmeter is useful at sewage lift stations and for measuring total raw wastewater flow or raw or recirculated sludge flow.

Electromagnetic flowmeters are used in full pipes and have many advantages, including: accuracies of +1 percent, a wide flow measurement range, a negligible pressure loss, no moving parts, and rapid response time. However, they are expensive and buildup of grease deposits or pitting by abrasive wastewaters can cause error. Regular checking and cleaning of the electrodes is necessary. The meter electronics can be checked for proper operation with devices specially made for this purpose. The meter should be checked at least annually. The calibration of an electromagnetic flowmeter cannot be verified except by returning it to the factory or by the dye dilution method.

Propeller Meter. The propeller meter (Figure O-11) operates on the principle that liquid hitting the propeller will cause the propeller to rotate at a speed proportional to the flow rate. The meter is self-contained and requires no energy or equipment other than a mechanical totalizer to obtain a cumulative flow reading. Equipment may be added to the meter to produce a flow reading, to pace chemical feed equipment, and to control telemetering equipment for remote readout. The calibration of a propeller meter can be checked by returning it to the factory, by comparing its readings to another meter measuring the same flow, or by using the dye dilution method.

Secondary Devices

Secondary devices are the devices in the flow measurement system that translate the interaction of primary devices in contact with the fluid into the desired records or readout. They can be organized into two broad classes:

- Nonrecording type with direct readout (e.g., a staff gauge) or indirect readout from fixed points (e.g., a chain, wire weight, float)
- Recording type with either digital or graphic recorders (e.g., float in well, float in flow, bubbler, electrical, acoustic).

The advantages and disadvantages of various secondary devices are provided in Table O-9.

Transit-Time Flowmeter. The transit-time flowmeter (Figure O-12) is a new ultrasonic technology that can be used as a secondary device. As a secondary device, the transit-time flowmeter must be used in conjunction with one of the primary devices described above. The transit-time flowmeter utilizes a minimum of one pair of transducers that alternately transmit and receive an ultrasonic signal. The transducers are placed on or in the pipe at a defined spacing based on a predetermined angle. The signal between the pair of transducers is alternately transmitted, first upstream and then downstream. At a zero flow condition, the time for the two signals to be transmitted and received are equal. However, as flow begins, the

liquid's flow velocity speeds up the signal in the up to downstream direction while slowing the signal in the down to upstream direction. The difference in time between the two signals is proportional to the liquid's velocity. Knowing the liquid's flow velocity and the pipe inner diameter area provides the instantaneous flow rate. The flowmeter provides analog and discrete outputs for remote recorder and totalization of flow.

Transit-time flowmeters are suitable for the typical range of liquids found in full pipe applications. The clamp-on nature of the meter allows for its installation without the need to shut down the existing line. Transit-time flowmeters are available in both permanent and portable configurations.

Pumps

Some wastewater facilities may need to measure flow by means of pumps in which discharge-versus-power relationships have been determined from measurements of the average output or input during a period in which discharge measurements were made. Suitable curves may be developed from these test data. When readily available from the manufacturer, pump curves may be used by the inspector to estimate flow.

Because of wear on pumps and uncertainty regarding actual discharge heads, pump curves at best only provide an estimate of the flow. Pump curves are not normally accurate enough to be used for NPDES permit discharge flow measurements. Pump curves have been used for determining large flows, such as the cooling water discharge from large steam electric power plants, where a high degree of accuracy was not necessary.

Table O-1

Head-Discharge Relationship Formulas for Nonsubmerged Weirs*

Weir Type	Contracted	Suppressed	Remarks	Reference
<u>Rectangular</u>				
Francis formulas	$Q = 3.33 (L - 0.1 nH)H^{1.5}$	$Q = 3.33 L H^{1.5}$	Approach velocity neglected	King 1963
	$Q = 3.33 ((H + h)^{1.5} - h^{1.5})(L - 0.1nH)$	$Q = 3.33 L((H + h)^{1.5} - h^{1.5})$	Approach velocity considered	King 1963
<u>Cipolletti</u>	$Q = 3.367 L H^{1.5}$	NA	Approach velocity neglected	King 1963
	$Q = 3.367 L (H + h)^{1.5} - h^{1.5}$	NA	Approach velocity considered	EPA 1973
<u>V-notch</u>				
Formula for 90° V-notch only	$Q = 2.50 H^{2.5}$	NA	Not appreciably affected by approach velocity	King 1963
	$Q = 3.01 H_w^{2.48}$	NA	Head measured at weir plate	Eli and Peterson 1979 (EPA-61809A-2B)
Q = discharge in cubic feet H = head in feet NA = not applicable H _w = head in feet at weir plate n = number of end contractions		L = crest length in feet h = head in feet due to the approach velocity = $v^2/2g$ V = approach velocity g = gravity (32.2 ft/sec ²)		
*Selection of a formula depends on its suitability and parameters under consideration.				

Table O-2

Discharge of 90° V-Notch Weir—Head Measured at Weir Plate

Head@ Weir in Feet	Flow Rate in CFS	Head@ Weir in Feet	Flow Rate in CFS	Head@ Weir in Feet	Flow Rate in CFS
0.06	0.003	0.46	0.439	0.86	2.071
0.07	0.004	0.47	0.463	0.87	2.140
0.08	0.006	0.48	0.488	0.88	2.192
0.09	0.008	0.49	0.513	0.89	2.255
0.10	0.010	0.50	0.540	0.90	2.318
0.11	0.013	0.51	0.567	0.91	2.382
0.12	0.016	0.52	0.595	0.92	2.448
0.13	0.019	0.53	0.623	0.93	2.514
0.14	0.023	0.54	0.653	0.94	2.582
0.15	0.027	0.55	0.683	0.95	2.650
0.16	0.032	0.56	0.715	0.96	2.720
0.17	0.037	0.57	0.747	0.97	2.791
0.18	0.043	0.58	0.780	0.98	2.863
0.19	0.049	0.59	0.813	0.99	2.936
0.20	0.056	0.60	0.848	1.00	3.010
0.21	0.063	0.61	0.883	1.01	3.085
0.22	0.070	0.62	0.920	1.02	3.162
0.23	0.079	0.63	0.957	1.03	3.239
0.24	0.087	0.64	0.995	1.04	3.317
0.25	0.097	0.65	1.034	1.05	3.397
0.26	0.107	0.66	1.074	1.06	3.478
0.27	0.117	0.67	1.115	1.07	3.556
0.28	0.128	0.68	1.157	1.08	3.643
0.29	0.140	0.69	1.199	1.09	3.727
0.30	0.152	0.70	1.243	1.10	3.813
0.31	0.165	0.71	1.287	1.11	3.889
0.32	0.178	0.72	1.333	1.12	3.987
0.33	0.193	0.73	1.379	1.13	4.076
0.34	0.207	0.74	1.426	1.14	4.166
0.35	0.223	0.75	1.475	1.15	4.257
0.36	0.239	0.76	1.524	1.16	4.349
0.37	0.256	0.77	1.574	1.17	4.443
0.38	0.273	0.78	1.625	1.18	4.538
0.39	0.291	0.79	1.678	1.19	4.634
0.40	0.310	0.80	1.730	1.20	4.731
0.41	0.330	0.81	1.785	1.21	4.829
0.42	0.350	0.82	1.840	1.22	4.929
0.43	0.371	0.83	1.896	1.23	5.030
0.44	0.393	0.84	1.953	1.24	5.132
0.45	0.415	0.85	2.012	1.25	5.235

Equation $Q = 3.01 H_w^{2.48}$, where H_w , head, is in feet at the weir and Q is in cubic feet per second.

Table O-3

**Minimum and Maximum Recommended Flow Rates
for Cipolletti Weirs**

Crest Length, ft.	Minimum Head, ft.	Minimum Flow Rate		Maximum Head, ft.	Maximum Flow Rate	
		MGD	CFS		MGD	CFS
1	0.2	0.195	0.301	0.5	0.769	1.19
1.5	0.2	0.292	0.452	0.75	2.12	3.28
2	0.2	0.389	0.602	1.0	4.35	6.73
2.5	0.2	0.487	0.753	1.25	7.60	11.8
3	0.2	0.584	0.903	1.5	12.0	18.6
4	0.2	0.778	1.20	2.0	24.6	38.1
5	0.2	0.973	1.51	2.5	43.0	66.5
6	0.2	0.17	1.81	3.0	67.8	105.0
8	0.2	0.56	2.413.01	4.0	139.0	214.0
10	0.2	1.95		5.0	243.0	375.0

Table O-4

**Minimum and Maximum Recommended Flow Rates
for Free Flow Through Parshall Flumes**

Throat Width, W	Minimum Head, ft.	Minimum Flow Rate		Maximum Head, ft.	Maximum Flow Rate	
		MGD	CFS		MGD	CFS
1 in.	0.07	0.003	0.005	0.60	0.099	0.153
2 in.	0.07	0.007	0.011	0.60	0.198	0.306
3 in.	0.10	0.018	0.028	1.5	1.20	1.86
6 in.	0.10	0.035	0.054	1.5	2.53	3.91
9 in.	0.10	0.05	0.091	2.0	5.73	8.87
1 ft.	0.10	0.078	0.120	2.5	10.4	16.1
1.5 ft.	0.10	0.112	0.174	2.5	15.9	24.6
2 ft.	0.15	0.273	0.423	2.5	21.4	33.1
3 ft.	0.15	0.397	0.615	2.5	32.6	50.4
4 ft.	0.20	0.816	1.26	2.5	43.9	67.9
5 ft.	0.20	1.00	1.55	2.5	55.3	85.6
6 ft.	0.25	1.70	2.63	2.5	66.9	103
8 ft.	0.25	2.23	3.45	2.5	90.1	139
10 ft.	0.30	3.71	5.74	3.5	189	292
12 ft.	0.33	5.13	7.93	4.5	335	519

Table O-5

Free-Flow Values of C and N for Parshall Flumes

**Based on the Relationship $Q = CWH^n$
(American Petroleum Institute 1969)**

Flume Throat, W		C	n	Max. Q CFS
1	in.	0.338	1.55	0.15
2	in.	0.676	1.55	0.30
3	in.	0.992	1.55	1.8
6	in.	2.06	1.58	3.9
9	in.	3.07	1.53	8.9
1	ft.	4W*	$1.522W^{0.026}$	16.1
1.5	ft.	4W*	$1.522W^{0.026}$	24.6
2	ft.	4W*	$1.522W^{0.026}$	33.1
3	ft.	4W*	$1.522W^{0.026}$	50.4
4	ft.	4W*	$1.522W^{0.026}$	67.9
5	ft.	4W*	$1.522W^{0.026}$	85.6
6	ft.	4W*	$1.522W^{0.026}$	103.5
7	ft.	4W*	$1.522W^{0.026}$	121.4
8	ft.	4W*	$1.522W^{0.026}$	139.5

Where, W = Flume throat width
 Q = Flow (CFS)
 C = Constant
 N = Constant
 H = Head upstream of the flume throat (feet)
 * = W should be represented in feet to calculate C

Table O-6

**Minimum and Maximum Recommended Flow Rates for
Free Flow Through Plasti-Fab Palmer-Bowlus Flumes**

D Flume Size (in.)	Maximum Slope for Upstream (%)	Minimum Head (ft.)	Minimum Flow Rate		Maximum Head (ft.)	Maximum Flow Rate	
			MGD	CFS		MGD	CFS
6	2.2	0.11	0.023	0.035	0.36	0.203	0.315
8	2.0	0.15	0.048	0.074	0.49	0.433	0.670
10	1.8	0.18	0.079	0.122	0.61	0.752	1.16
12	1.6	0.22	0.128	0.198	0.73	1.18	1.83
15	1.5	0.27	0.216	0.334	0.91	2.06	3.18
18	1.4	0.33	0.355	0.549	1.09	3.24	5.01
21	1.4	0.38	0.504	0.780	1.28	4.81	7.44
24	1.3	0.44	0.721	1.12	1.46	6.70	10.4
27	1.3	0.49	0.945	1.46	1.64	8.95	13.8
30	1.3	0.55	1.26	1.95	1.82	11.6	18.0

Table O-7

**Coefficients of Discharge c for Venturi Meters
(King 1963)**

Diameter of Throat, in.	Throat Velocity, ft. per sec.								
	3	4	5	10	15	20	30	40	50
1	0.935	0.945	0.949	0.958	0.963	0.966	0.969	0.970	0.972
2	0.939	0.948	0.953	0.965	0.970	0.973	0.974	0.975	0.977
4	0.943	0.952	0.957	0.970	0.975	0.977	0.978	0.979	0.980
8	0.948	0.957	0.962	0.974	0.978	0.980	0.981	0.982	0.983
12	0.955	0.962	0.967	0.978	0.981	0.982	0.983	0.984	0.985
18	0.963	0.969	0.973	0.981	0.983	0.984	0.985	0.986	0.986
48	0.970	0.977	0.980	0.984	0.985	0.986	0.987	0.988	0.988

Table O-8
Values of K in Formula for Venturi Meters
(King 1963)

$\frac{d^2}{d^1}$	K	$\frac{d^2}{d^1}$	K	$\frac{d^2}{d^1}$	K	$\frac{d^2}{d^1}$	K	$\frac{d^2}{d^1}$	K
0.20	6.31	0.33	6.34	0.46	6.45	0.59	6.72	0.72	7.37
0.21	6.31	0.34	6.34	0.47	6.46	0.60	6.75	0.73	7.45
0.22	6.31	0.35	6.35	0.48	6.47	0.61	6.79	0.74	7.53
0.23	6.31	0.36	6.35	0.49	6.49	0.62	6.82	0.75	7.62
0.24	6.31	0.37	6.36	0.50	6.51	0.63	6.86	0.76	7.72
0.25	6.31	0.38	6.37	0.51	6.52	0.64	6.91	0.77	7.82
0.26	6.31	0.39	6.37	0.52	6.54	0.65	6.95	0.78	7.94
0.27	6.32	0.40	6.38	0.53	6.54	0.66	7.00	0.79	8.06
0.28	6.32	0.41	6.39	0.54	6.59	0.67	7.05	0.80	8.20
0.29	6.32	0.42	6.40	0.55	6.61	0.68	7.11	0.81	8.35
0.30	6.33	0.43	6.41	0.56	6.64	0.69	7.17	0.82	8.51
0.31	6.33	0.44	6.42	0.57	6.66	0.70	7.23	0.83	8.69
0.32	6.33	0.45	6.43	0.58	6.69	0.71	7.30	0.84	8.89

Table O-9

Advantages and Disadvantages of Secondary Devices

Device	Advantages	Disadvantages
Hook Gauge	Common	Requires training to use, easily damaged
Stage Board	Common	Needs regular cleaning, difficult to read top of meniscus
Pressure Measurement		
a. Pressure Bulb	Since no compressed air is used, source can be linked directly to sampler	Openings can clog, expensive
b. Bubbler Tube	Self-cleaning, less expensive, reliable	Needs compressed air or another air source
Float	Inexpensive, reliable	Catches debris, requires frequent cleaning to prevent sticking and changing buoyancy, and corroding hinges
Dipper	Quite reliable, easy to operate	Oil and grease foul probe, causing possible sensor loss
Ultrasonic	No electrical or mechanical contact	Errors from heavy turbulence and foam, calibration procedure is more involved than for other devices

Figure O-1.

**Profile and Nomenclature of Sharp-Crested Weirs
(Associated Water and Air Resource Engineers, Inc., 1973)**

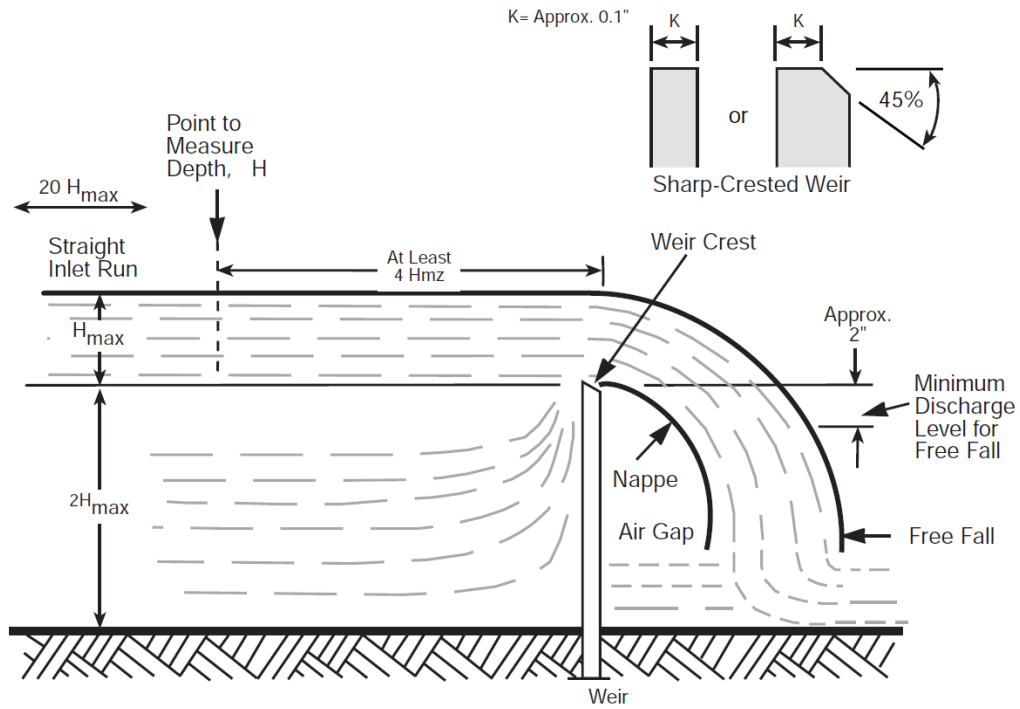

461B-05

Figure O-2.

Three Common Types of Sharp-Crested Weirs (Associated Water and Air Resource Engineers, Inc., 1973)

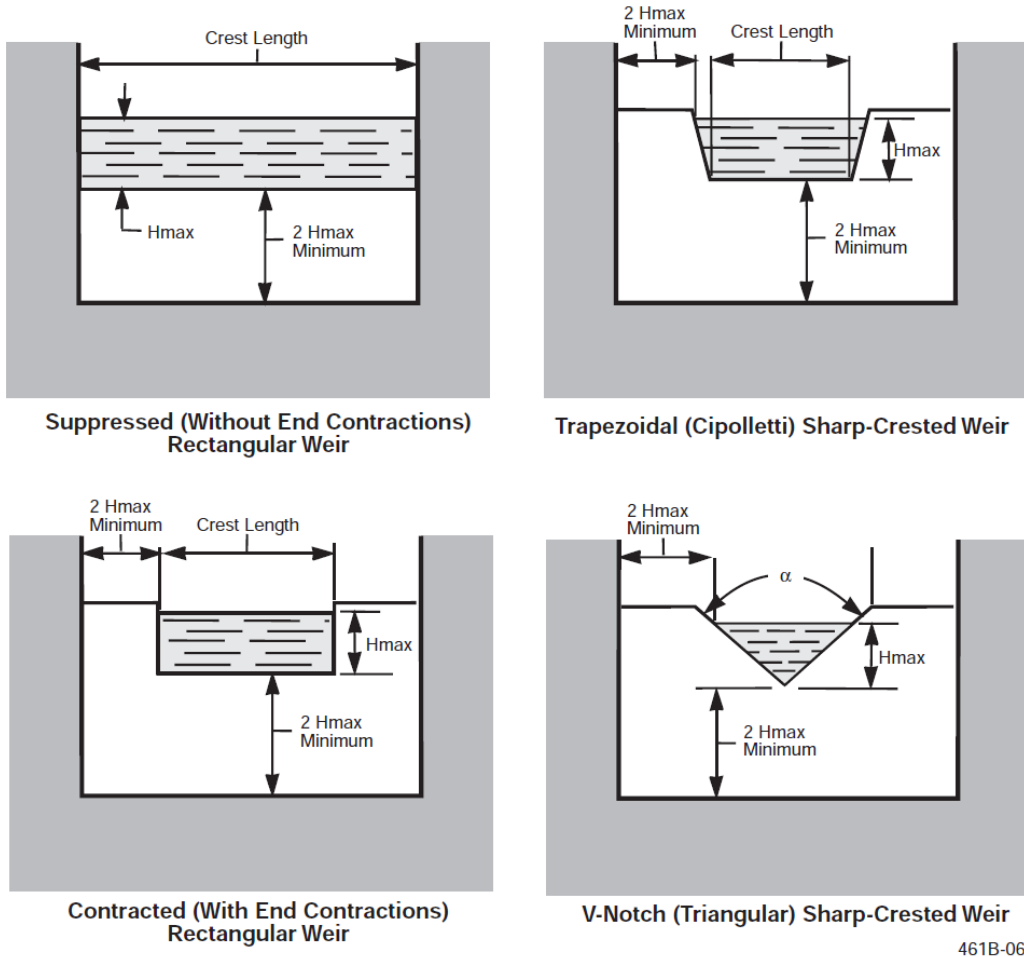

Figure O-3.

Flow Rates for 60° and 90° V-Notch Weirs (Associated Water and Resource Engineers, Inc., 1973)

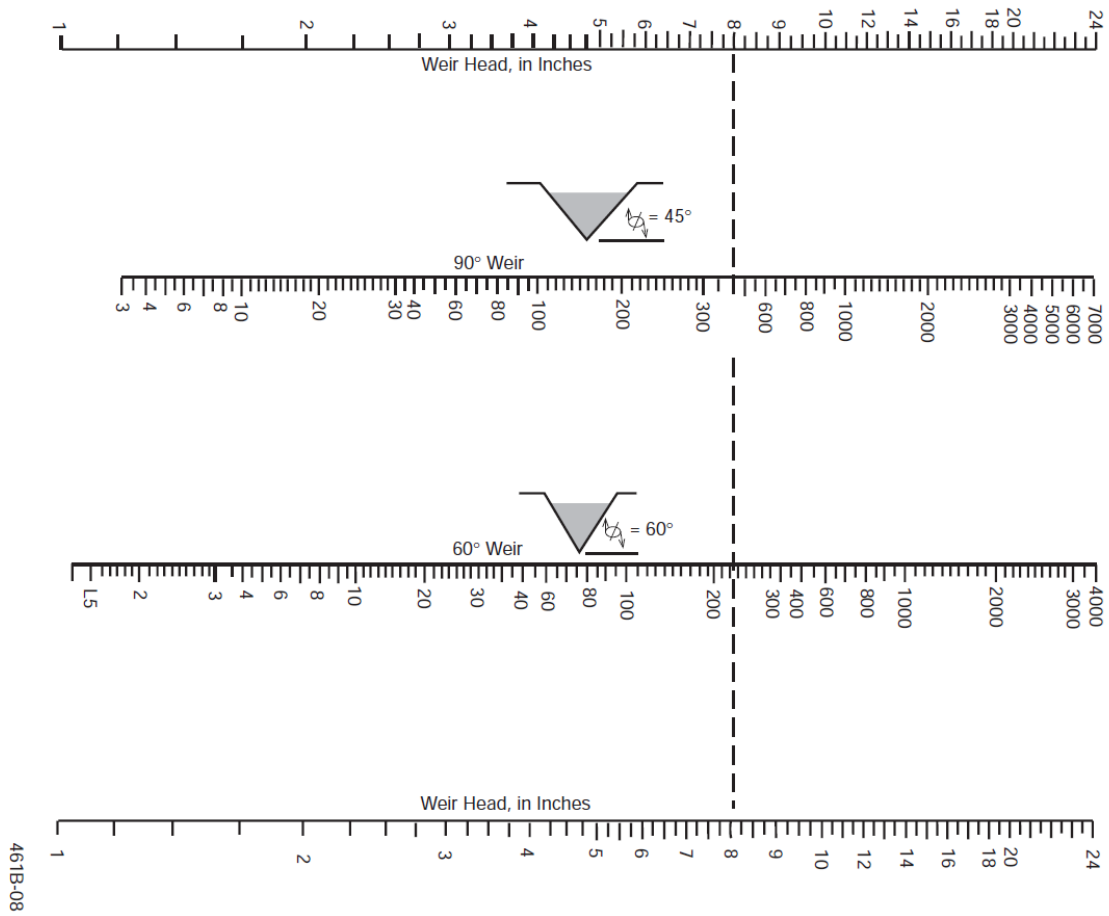
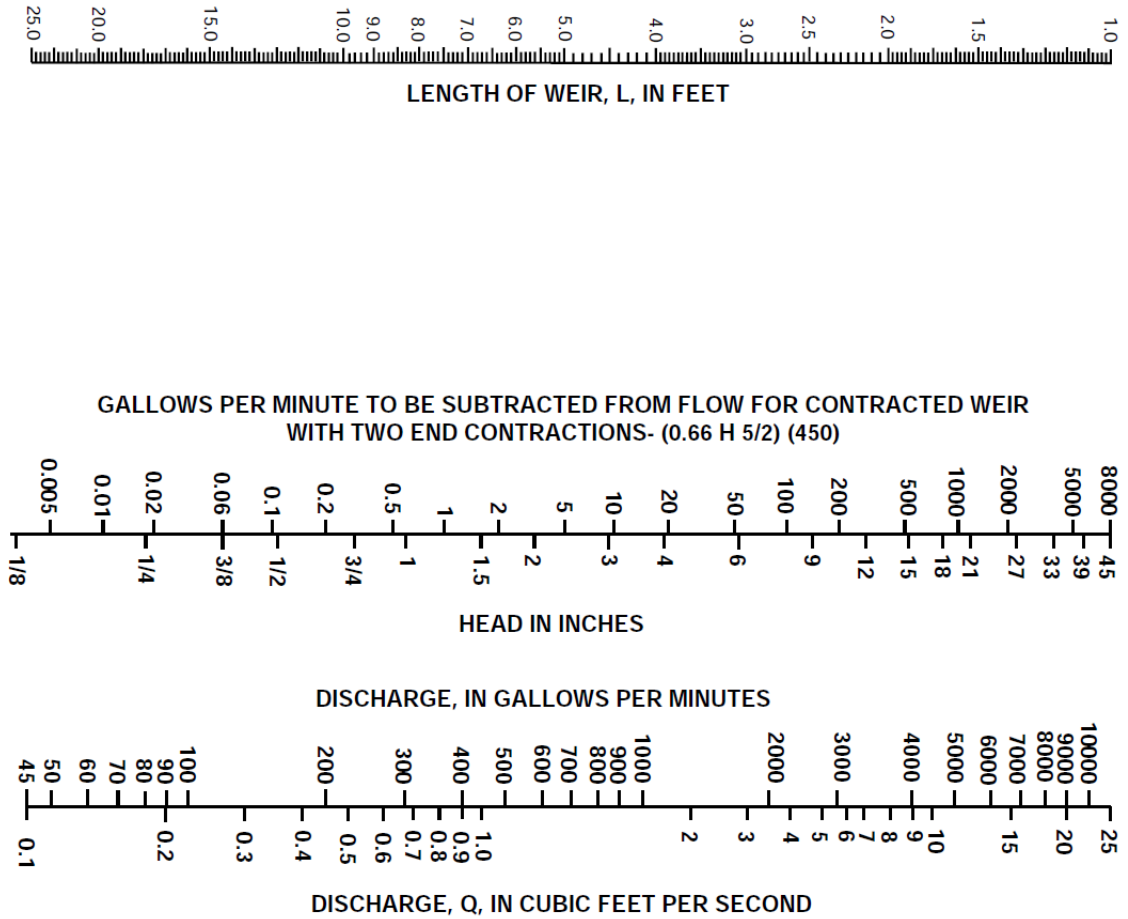

Figure O-4.

Nomograph for Capacity of Rectangular Weirs (Associated Water and Air Resource Engineers, Inc., 1973)



461B-09

Figure O-5.

**Flow Curves for Parshall Flumes
(Associated Water and Air Resource Engineers, Inc., 1973)**

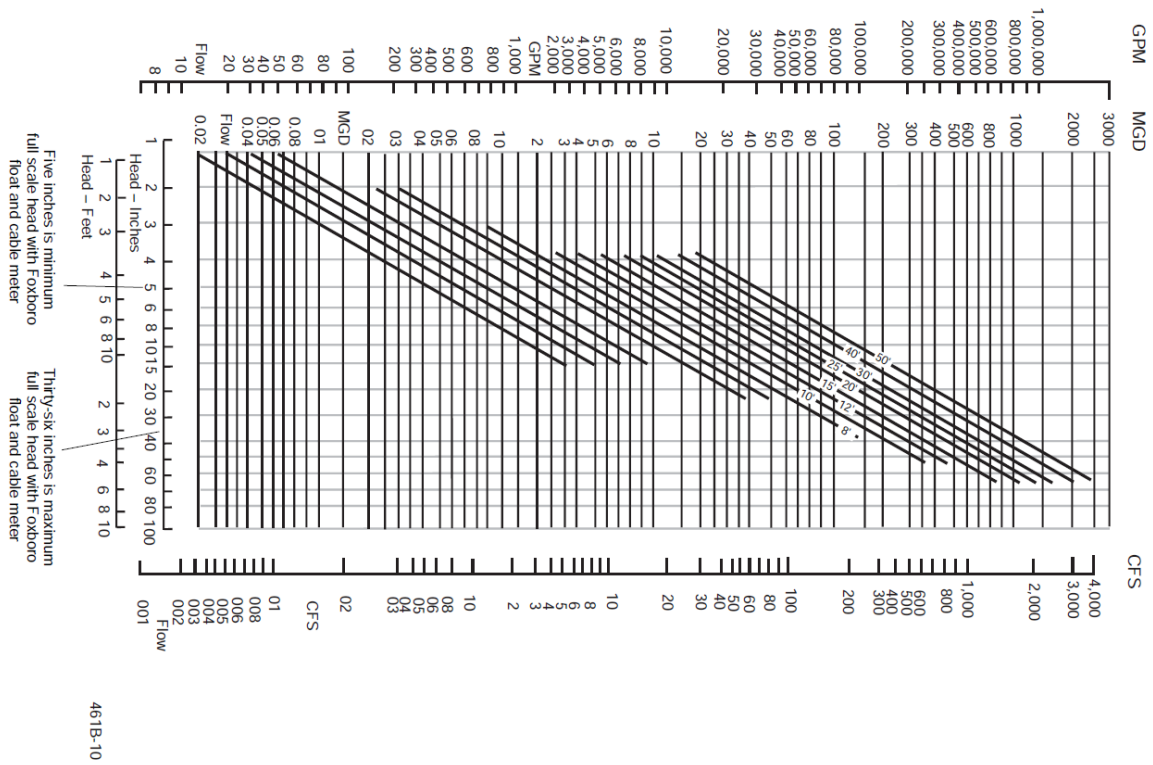
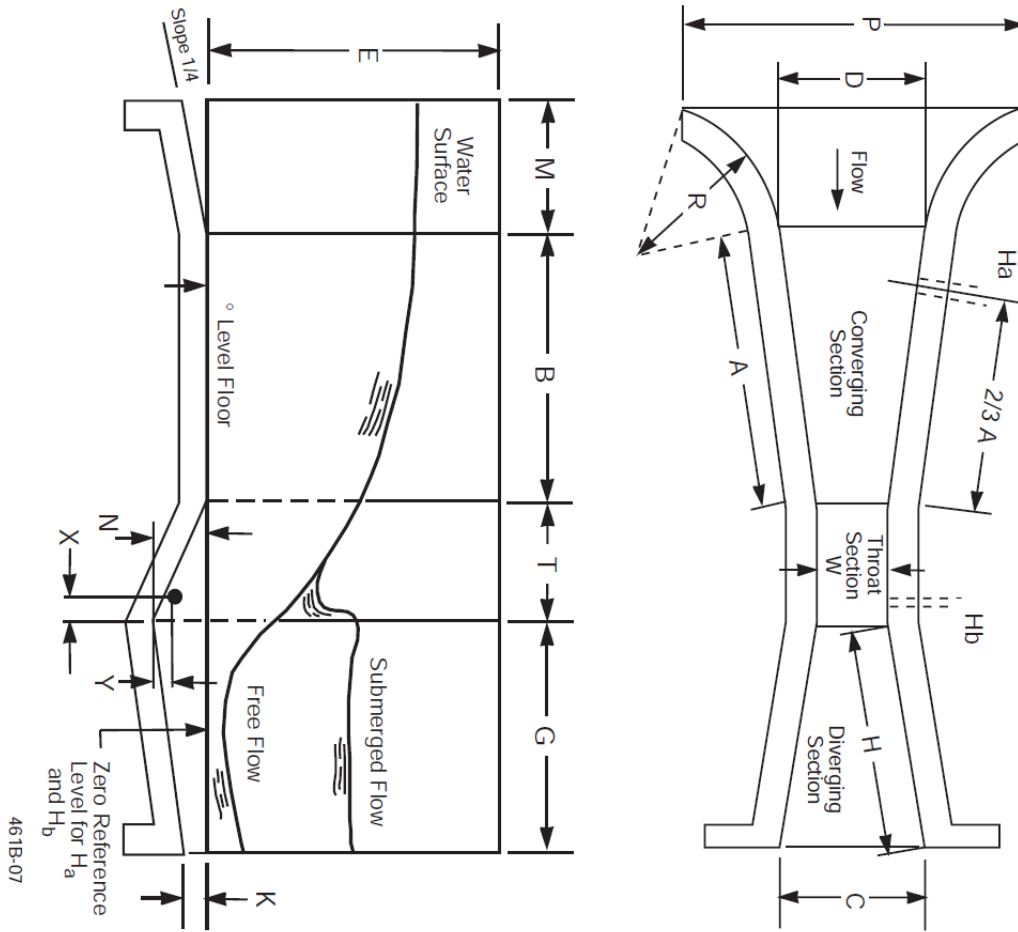

Figure O-6.

**Dimensions and Capacities of Parshall Measuring Flumes for Various Throat Widths
(Associated Water and Air Resource Engineers, Inc., 1973)**



**Figure O-6.
Dimensions and Capacities of Parshall Measuring Flumes for Various Throat Widths
(continued)**

Ft.	In.	Ft.	In.	Ft.	In.	Ft.	In.	Ft.	In.	Ft.	In.	Ft.	In.	Ft.	In.	Ft.	In.	Ft.	In.	Ft.	In.	Ft.	In.	Ft.	In.	Ft.	In.	Ft.	In.	Ft.	In.	Ft.	In.	Ft.	In.	Free-Flow Capacity (Second-Foot*)	
																																				Mini-mum	Maxi-mum
0	3	1	6%	1	¼	1	6	0	7	0	10 ¹ / ₁₆	1-1½	0	0	6	1	0	1	½	1	0	0	2¼	0	0	0	0	1	1½	0.03	1.9						
0	6	2	7 ¹ / ₁₆	1	4 ⁵ / ₁₆	2	0	1	3½	1	3%	2	0	1	0	2	0	0	0	3	1	0	4½	2	11½	1	4	2	3	0.05	3.9						
0	9	2	10%	1	11 ¹ / ₈	2	10	1	3	1	10%	2	6	1	0	1	6	0	0	3	1	0	4½	3	6½	1	4	2	3	0.09	8.9						
1	0	4	6	3	0	4	4%	2	0	2	9¼	3	0	2	0	3	0	0	0	3	1	3	9	4	10¼	1	8	2	3	0.11	16.1						
1	6	4	9	3	2	4	7%	2	6	3	4%	3	0	2	0	3	0	0	0	3	1	3	9	5	6	1	8	2	3	0.15	24.6						
2	0	5	0	3	4	4	10%	3	0	3	11½	3	0	2	0	3	0	0	0	3	1	3	9	6	1	1	8	2	3	0.42	33.1						
3	0	5	6	3	8	5	4%	4	0	5	1%	3	0	2	0	3	0	0	0	3	1	3	9	7	3½	1	8	2	3	0.61	50.4						
4	0	6	0	4	0	5	10%	5	0	6	4%	3	0	2	0	3	0	0	0	3	1	6	9	8	10¼	2	0	2	3	1.30	67.9						
5	0	6	6	4	4	6	4½	6	0	7	6%	3	0	2	0	3	0	0	0	3	1	6	9	10	1¼	2	0	2	3	1.60	85.6						
6	0	7	0	4	8	6	10%	7	0	8	9	3	0	2	0	3	0	0	0	3	1	6	9	11	3½	2	0	2	3	2.60	103.5						
7	0	7	6	5	0	7	4%	8	0	9	11%	3	0	2	0	3	0	0	0	3	1	6	9	12	6	2	0	2	3	3.00	121.4						
8	0	8	0	5	4	7	10%	9	0	11	1¼	3	0	2	0	3	0	0	0	3	1	6	9	13	8¼	2	0	2	3	3.50	139.5						

*Equals 1 cu. ft. per sec.

LEGEND:

- W Width of flume throat.
- A Length of side wall of converging section.
- ¾A Distance back from end of crest to gauge point.
- B Axial length of converging section.
- C Width of downstream end of flume.
- D Width of upstream end of flume.
- E Depth of flume.
- T Length of flume throat.

- G Axial length of diverging section.
- H Length of side wall of the diverging section.
- K Difference in elevation between lower end of flume and crest.
- M Length of approach floor.
- N Depth of depression in throat below crest.
- P Width between ends of curved wing walls.
- R Radius of curved wing wall.
- X Horizontal distance to H₀ gauge point from low point in throat.
- Y Vertical distance to H₀ gauge point from low point in throat.

Figure O-7.

Effect of Submergence on Parshall Flume Free Discharge (Civil Engineering, ASCE)

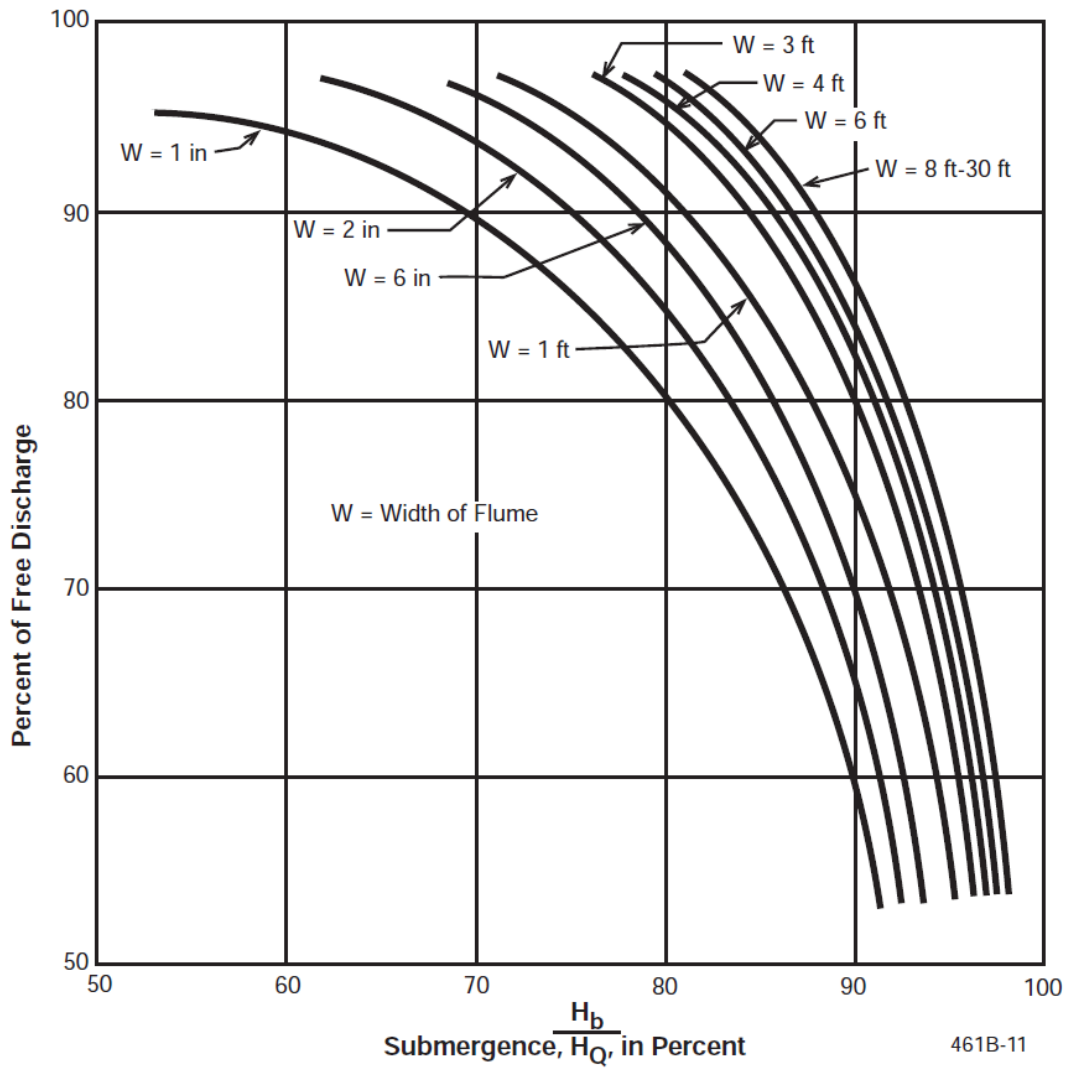

Figure O-8.

Free-Flowing Palmer-Bowlus Flume

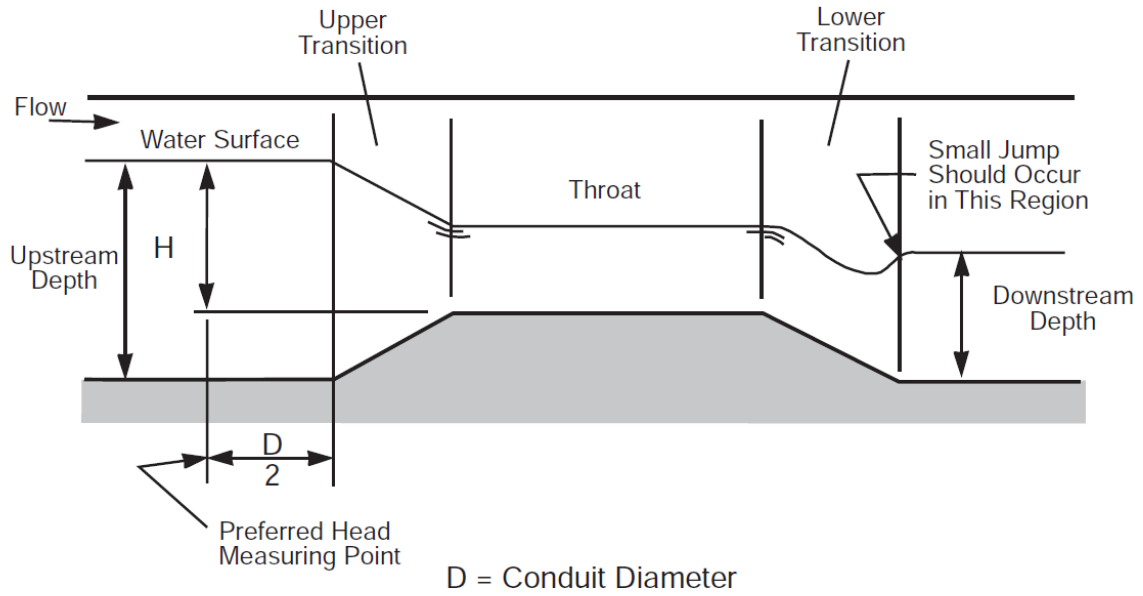

Figure O-9.
Configuration and Nomenclature of Venturi Meter

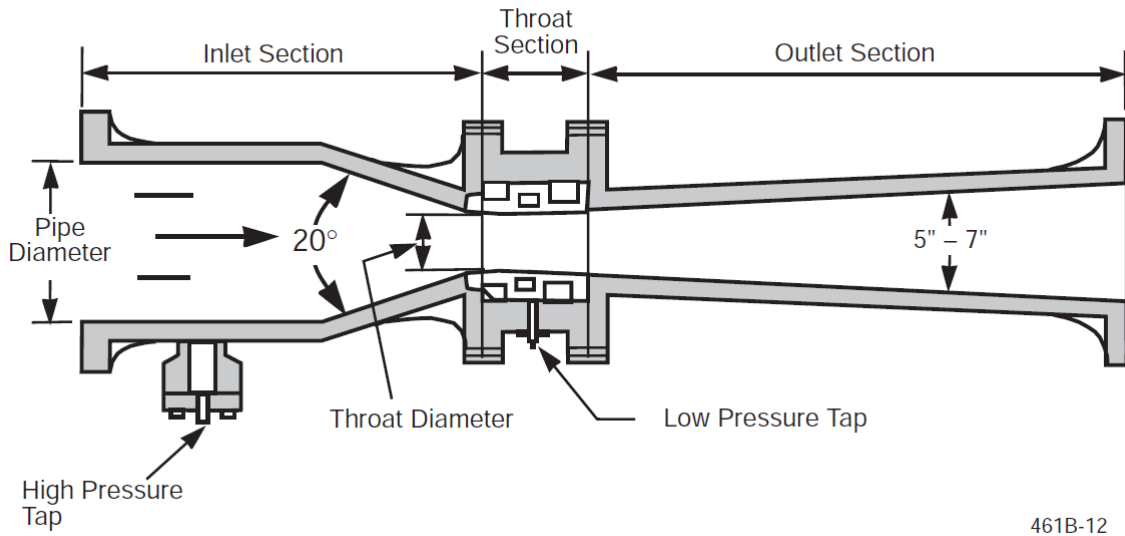

Figure O-10.
Electromagnetic Flowmeter

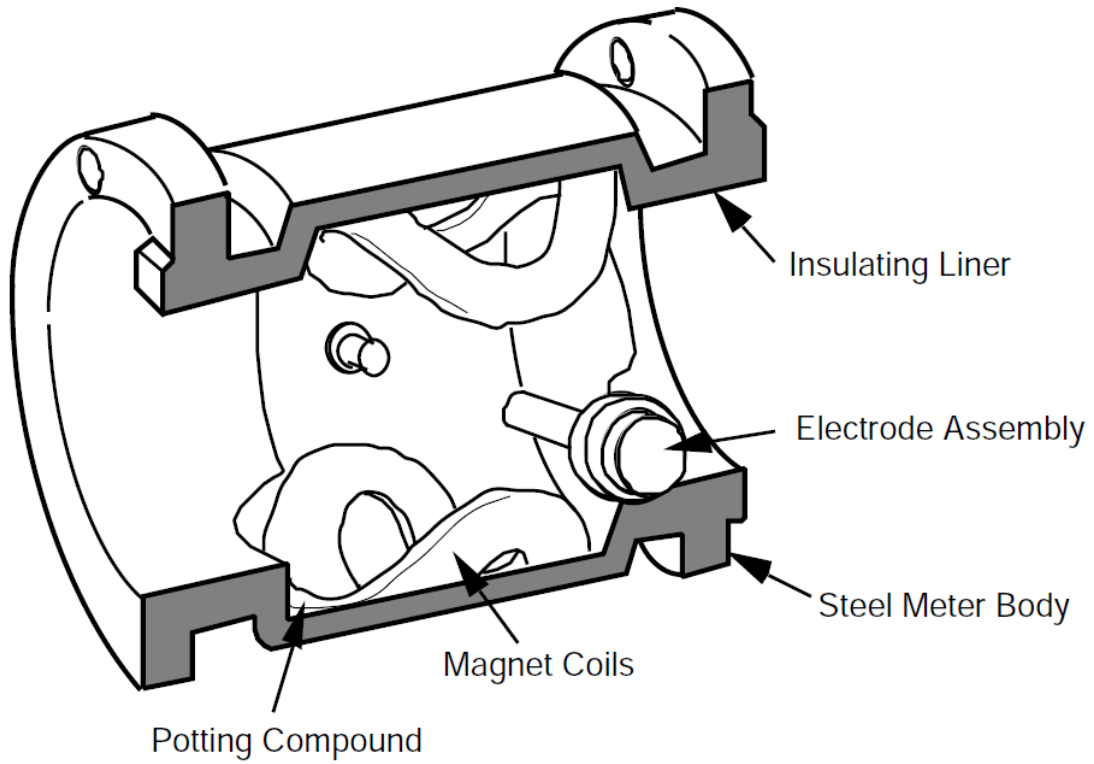
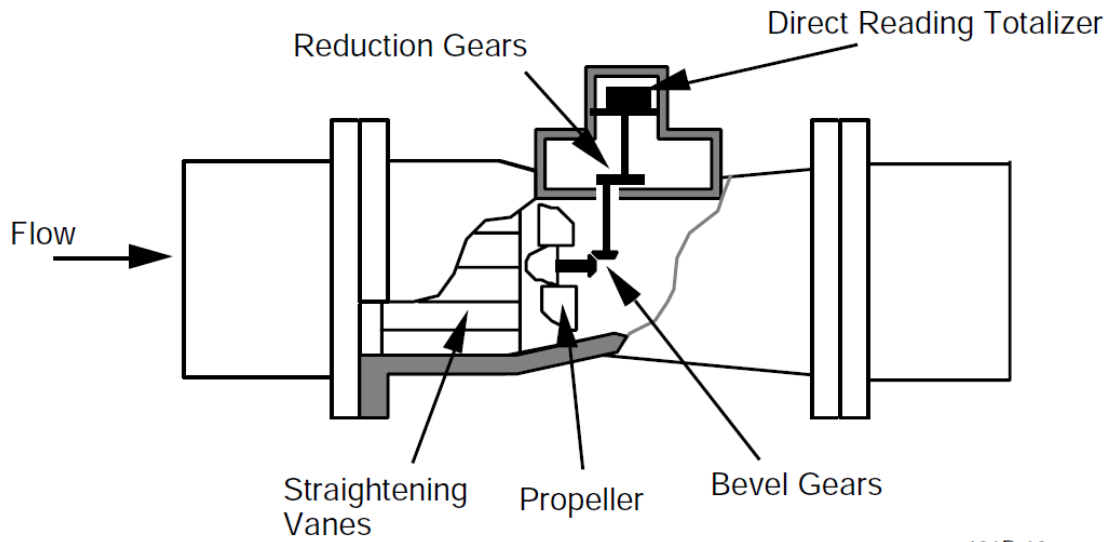
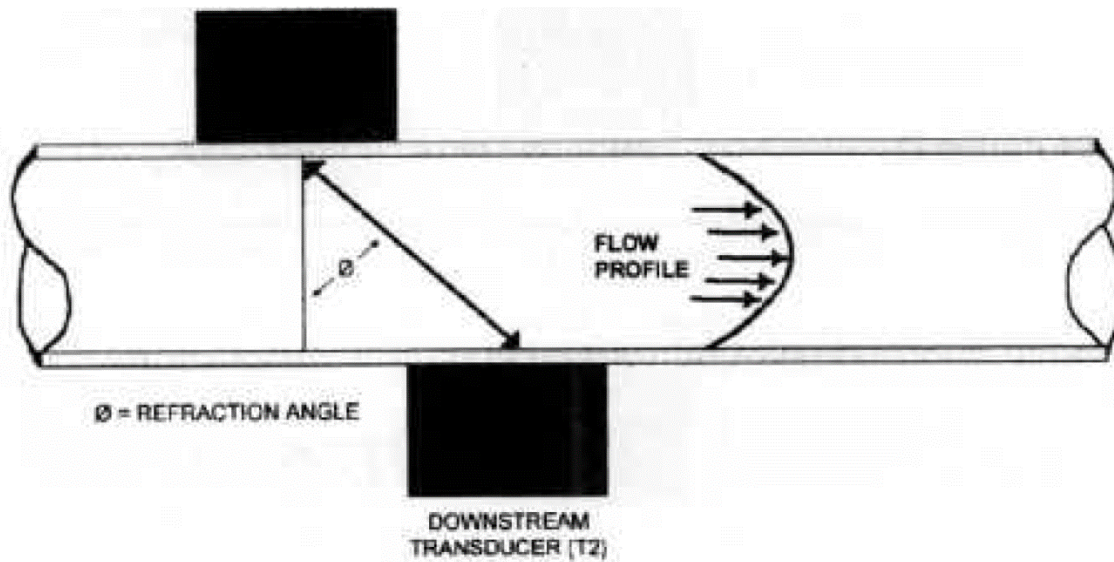

Figure O-11.
Propeller Flowmeter



461B-13

Figure O-12.
Transit-Time Flowmeter



Appendix P – Sludge Inspection Checklists

Sludge Inspection Checklist

Yes	No	N/A	1. Are 40 CFR Part 503 sludge use and disposal requirements contained in a current NPDES permit, in a separate "sludge only" NPDES permit, in a RCRA Subtitle C permit, or in a CAA permit? [503.3(a)(1) or (2) (1)]
Yes	No	N/A	2. Sludge use and disposal practice(s): a. Land Application ____ [503.10] Bulk Sewage Sludge ____ [503.11(e)] Bulk Material Derived from Sewage Sludge ____ [503.11(e)] Or Sold or Given Away in a Bag or Another Container ____ [503.11(e)] b. Surface Disposal ____ [503.20] c. Sewage Sludge Incineration ____ [503.40] d. Onsite or Offsite Storage ____ [503.9(y)] Date storage began ____ ended ____ (Maximum time allowed: 2 years from February 19, 1993) e. Other (list) _____
Yes	No	N/A	3. Each sludge use or disposal practice is permitted? [503.3(a)(1) (1)]
Yes	No	N/A	4. Notification is given to EPA/State of new or different sludge disposal method? (Permit)
Yes	No	N/A	5. Number and location of disposal sites/activities are as described in the permit or fact sheet or land application plan (40 CFR Part 501)? [Permit]
Comments:			
Yes	No	N/A	1. Self-monitoring data are available for all regulated pollutants? [503.17], [503.27], [503.43]
Yes	No	N/A	2. Pathogen and vector attraction reduction method description and certification statement(s) available? [503.17], [503.27]
Yes	No	N/A	3. Records are available for each applicable use or disposal practice? [503.17], [503.27], [503.47]
Yes	No	N/A	4. Accurate records of sludge volume or mass are maintained, where appropriate? [503.25], [503.47]
Yes	No	N/A	5. Monitoring and analyses are performed more often than required by permit? If so, results are reported in the permittee's self-monitoring report? [Permit]
Yes	No	N/A	6. Unit operations records verify compliance with pathogen and vector attraction reduction requirements, where appropriate? [503.15], [503.25]
Yes	No	N/A	7. Self-monitoring is conducted at the frequency specified in the permit, in 503.16 Table 1 (land application), or in 503.26 Table 1 (surface disposal)? [503.16],

Sludge Inspection Checklist

			[503.26] or [503.46] Table 1. Production-dependent – 0-289 mtpy: 1/yr., 290-1499 mtpy: 1/qtr., 1500-14999 mtpy: ½ mo., 15000 mtpy and greater, 1/mo.) mtpy-metric ton per year
Yes	No	N/A	8. Facility reports sludge monitoring data at the frequency specified in the permit? (Only for Class I facilities or POTWs with either total design flow >1 mgd or serving population >10,000) [503.18], [503.28], [503.48]
Yes	No	N/A	9. Sludge records are maintained for at least 5 years? [503.17], [503.27], [503.47]
Yes	No	N/A	10. Sludge data are reported on Discharge Monitoring Report (DMR) or approved form? [Permit]
Yes	No	N/A	11. Sludge records are adequate to assess compliance with annual and/or cumulative pollutant loading rates or other established permit limits? [503.13(a) (2) (i), 503.13(a) (4) (ii)]
Comments:			
Yes	No	N/A	1. Sludge samples are taken at locations specified in the permit? [Permit]
Yes	No	N/A	2. Sludge sample locations are appropriate for obtaining representative samples? [503.8(a)]
Yes	No	N/A	3. Sampling and analysis are conducted for parameters specified in the permit or in 40 CFR Part 503? [Permit], [503.13], [503.23], [503.46]
Yes	No	N/A	4. Sample collection procedures:
Yes	No	N/A	a. Adequate sample volumes are obtained?
Yes	No	N/A	b. Proper preservation techniques are used?
Yes	No	N/A	c. Containers conform to appropriate analytical method specified in 40 CFR Part 503.8?
Yes	No	N/A	d. Samples analyzed in the appropriate time frames in accordance with 40 CFR Part 503.8?
Yes	No	N/A	5. Are results reported on a dry weight basis? [503.13], [503.23], [503.43] (Dry weight concentration = Wet weight concentration/Decimal fraction of solids) e.g., A sludge containing 20 mg/l Cu and having 5% solids. Dry weight Cu (mg/kg) = $\frac{20 \text{ mg/l}}{0.05} = 400 \text{ mg/kg}$
Yes	No	N/A	6. Sample is refrigerated subsequent to compositing?
Yes	No	N/A	7. Chain-of-custody procedures are employed?
Yes	No	N/A	8. Analytical methods used are approved methods in 40 CFR Part 503.8 or updated methods specified for Part 503 compliance?

Sludge Inspection Checklist

Comments:			
Yes	No	N/A	1. Sludge process control parameters maintained as appropriate?
Yes	No	N/A	2. Adequate equipment redundancy (e.g., back-up units)?
Yes	No	N/A	3. Adequate sludge storage capacity?
Yes	No	N/A	4. Contingency plan for sludge disposal practice?
Yes	No	N/A	5. Solids handling operation adequate to manage volume of sludge?
Comments:			
Yes	No	N/A	1. Is primary unstabilized sludge fed to the thickener, centrifuge or drying bed? If yes, list percentage of unstabilized sludge _____
Yes	No	N/A	2. What is the average % solids of the sludge before thickening, drying or centrifuging? _____ % after? _____ %
Yes	No	N/A	3. Is sludge mixed with other materials before or after thickening?
Yes	No	N/A	4. For sludge containing unstabilized solids, is the percent solids greater than 90% prior to mixing with other materials?
Yes	No	N/A	5. For sludge containing no unstabilized solids, is the percent solids greater than 75% prior to mixing with other materials?
Comments:			
			1. Sludge fed to digester(s) includes: ___ Primary ___ Secondary ___ Combined
			2. Digester(s) operating mode: ___ high rate ___ low rate
Yes	No	N/A	3. Digester(s) are operated at proper temperature [mesophilic: 95°F (35°C) and thermophilic: 131°F (55°C)?
			List operating mode: ___ mesophilic ___ thermophilic
Yes	No	N/A	4. Temperature monitoring location and frequency sufficient to demonstrate compliance with Class B pathogen reduction requirements for PSRP?
			Average Temperature: _____ °C or °F

Sludge Inspection Checklist

Yes	No	N/A	5. Solids Retention Time (SRT) or Mean Cell Residence time (MCRT) calculated properly? *
Yes	No	N/A	6. SRT or MCRT sufficient to demonstrate compliance with Class B pathogen reduction requirements for PSRP? Average SRT or MCRT: ____ days *For batch operated digesters with no recycle: SRT or MCRT = Mass of solids in digester, kg Solids removed, kg/day This formula can be used to estimate SRT or MCRT for all digester systems. For calculating SRT or MCRT for other system configurations, use the WEF Manual of Practice or other references. Always write down the calculation used by the facility no matter what the configuration is.
Comments:			
			1. Sludge fed to digester(s) includes: ____ Primary ____ Secondary ____ Combined
			2. Digester(s) operating mode: ____ high rate ____ low rate
Yes	No	N/A	3. Digester(s) are operated at proper temperature [cryophilic: <50°F (<10°C), mesophilic: 50-108°F (10-42°C), and thermophilic: >108°F (42°C)]? List operating mode: ____ cryophilic ____ mesophilic ____ thermophilic
Yes	No	N/A	4. Temperature monitoring location and frequency sufficient to demonstrate compliance with Class B pathogen reduction requirements for PSRP or with Class A pathogen reduction requirements for PFRP (Thermophilic aerobic digestion only)? Average Temperature: ____°C or °F
Yes	No	N/A	5. Solids Retention Time (SRT) or Mean Cell Residence time (MCRT) calculated properly? *
Yes	No	N/A	6. SRT or MCRT sufficient to demonstrate compliance with Class B pathogen reduction requirements for PSRP or with Class A pathogen reduction requirements for PFRP (Thermophilic digestion only)? Average SRT or MCRT: ____ days
Yes	No	N/A	7. Aerobic conditions verified through dissolved oxygen monitoring? *For batch operated digesters with no recycle: SRT or MCRT = Mass of solids in digester, kg Solids removed, kg/day This formula can be used to estimate SRT or MCRT for all digester systems. For calculating SRT or MCRT for other system configurations, use the WEF Manual of

Sludge Inspection Checklist

			<p>6. Indicate which method is used to meet Class A requirements: [503.32(a)]</p> <p><input type="checkbox"/> Fecal Coliform <1000 MPN/g total solids, or <i>Salmonella</i> <3 MPN/4 g total solids, and Time/Temperature requirements. [503.32(a)(3)]</p> <p><input type="checkbox"/> Fecal Coliform <1000 MPN/g total solids, or <i>Salmonella</i> <3 MPN/4 g total solids, and pH requirements. [503.32(a)(4)]</p> <p><input type="checkbox"/> Fecal Coliform <1000 MPN/g total solids, or <i>Salmonella</i> <3 MPN/4 g total solids, and enteric viruses or helminth ova reduction requirements. [503.32(a)(5)]</p> <p><input type="checkbox"/> Fecal Coliform <1000 MPN/g total solids, or <i>Salmonella</i> <3 MPN/4 g total solids, and enteric viruses or helminth ova density requirements. [503.32(a)(6)]</p> <p><input type="checkbox"/> Fecal Coliform <1000 MPN/g total solids, or <i>Salmonella</i> <3 MPN/4 g total solids, and Process to Further Reduce Pathogens (PFRP). [503.32(a)(7) and [503 Appendix B] (5)]</p> <p><input type="checkbox"/> Fecal Coliform <1000 MPN/g total solids, or <i>Salmonella</i> <3 MPN/4 g total solids, and equivalent PFRP. [503.32(a)(8) and [503 Appendix B] (5)]</p>
Yes	No	N/A	7. Are Class B Pathogen reduction requirements met? [503.32(b) (4)]
			<p>8. Indicate which method(s) is used to meet Class B requirements:</p> <p><input type="checkbox"/> Geometric mean of seven Fecal Coliform samples with <2,000,000 MPN/g total solids or <2,000,000 Colony Forming Units/g total solids. [503.32(b)(2)]</p> <p><input type="checkbox"/> Treated by Process to Significantly Reduce Pathogens (PSRP). [503.32(b)(3) and [503 Appendix B] (5)]</p> <p><input type="checkbox"/> Treated by equivalent PSRP. [503.32(b)(4) and [503 Appendix B] (5)]</p>
Yes	No	N/A	9. For Class B sludge which is land applied, are Site Restrictions practiced? [503.32 (b)(5) (4)]
Yes	No	N/A	<p>10. Indicate Site Restrictions practiced where applicable:</p> <p><input type="checkbox"/> Food crops (above ground) are harvested >14 months after application of sewage sludge? [503.32(b)(5)(i)]</p> <p><input type="checkbox"/> Food Crops (below ground) are harvested >20 months after application of sewage sludge when sludge stays on land for >4 months prior to incorporation into soil? [503.32(b)(5)(ii)]</p> <p><input type="checkbox"/> Food Crops (below ground) are harvested >38 months after application of sewage sludge when sludge stays on land for <4 months prior to incorporation into soil? [503.32(b)(5)(iii)]</p> <p><input type="checkbox"/> Food Crops, feed crops, and fiber crops are harvested >30 days after application of sewage sludge? [503.32(b)(5)(iv)]</p> <p><input type="checkbox"/> Animal grazing allowed on land only >30 days after application of sewage sludge? [503.32(b)(5)(v)]</p> <p><input type="checkbox"/> Turf grown on land where sewage sludge was applied placed on high public expose land or lawn is harvested >1 year after application of sewage sludge? [503.32(b)(5)(vi)]</p> <p><input type="checkbox"/> Public access is restricted to land with a potential for high public exposure for 1 year? [503.32(b)(5)(vii)]</p>

Sludge Inspection Checklist

			<input type="checkbox"/> Public access is restricted to land with a potential for low public exposure for 30 days? [503.32(b)(5)(viii)]
Yes	No	N/A	11. Is a Vector Attraction Reduction method practiced? [503.15(c) (6)]
Yes	No	N/A	12. Indicate Vector Attraction Reduction method: [503.33(b)]
			<input type="checkbox"/> 38% Volatile Solids Reduction. [503.33(b)(1) (7)]
			<input type="checkbox"/> 40-day test - Volatile Solids reduced <17%. [503.33(b)(2) (Anaerobic Digestion Only)]
			<input type="checkbox"/> 30-day test - Volatile Solids reduced <15%. [503.33(b)(3) (Aerobic Digestion Only)]
			<input type="checkbox"/> Specific Oxygen Uptake Rate (SOUR) <1.5 mg/hr./gm TS @ 20°C. [503.33(b)(4)]
			<input type="checkbox"/> Aerobic Process for >14 days @ >40°C with average sludge temperatures >45°C. [503.33(b)(5)]
			<input type="checkbox"/> pH >12 for 2 hours and pH >11.5 for 22 hours [503.33(b)(6)]
			<input type="checkbox"/> Sludge (with no unstabilized solids) contains >75% Total Solids prior to mixing with other materials. [503.33(b)(7)]
			<input type="checkbox"/> Sludge (contains unstabilized solids) contains >90% Total Solids prior to mixing with other materials. [503.33(b)(8)]
			<input type="checkbox"/> Subsurface Injection. [503.33(b)(9)]
			<input type="checkbox"/> Soil Incorporation. [503.33(b)(10)]
Yes	No	N/A	13. Are general requirements (503.12) and management practices (503.14) applied for sludge not meeting Table 3 pollutant concentrations, Class pathogen reduction requirements, and vector attraction reduction methods? [503.10], [503.12], [503.14]
Yes	No	N/A	14. Indicate management practices where applicable: <input type="checkbox"/> No threatened or endangered species present or critical habitat affected at the location(s) where bulk sludge is applied. <input type="checkbox"/> Bulk sludge not applied to frozen or snow covered ground. <input type="checkbox"/> Bulk sludge applied >10 meters from waters of the U.S. <input type="checkbox"/> Bulk sludge applied at a rate equal to or less than agronomic rate. <input type="checkbox"/> Label affixed on bag or information sheet provided to user of sold and given away sludge indicating name of sludge preparer, application instructions, and maximum annual whole sludge application rate.
Yes	No	N/A	15. Indicate general requirements practiced where applicable: <input type="checkbox"/> Sludge is not applied to a site where the cumulative pollutant loading or annual application rate has been reached. <input type="checkbox"/> Notification given to the sludge applier regarding total nitrogen content of the sludge. <input type="checkbox"/> Sufficient information required to comply with 40 CFR Part 503 is given to preparers/appliers/land owners.

Sludge Inspection Checklist

	___	Written notification given to permitting authority (including States) regarding the location of land application sites, appropriate NPDES permit numbers.			
Yes	No	N/A	16. Description of how management practices are met for each land application site available?		
Comments:					

Land Application Footnotes:

(1) Permits are not required. Part 503 is self-implementing. Part 503 does not cover industrial sludges or grit and screenings.

(2) 503.13(b)(1), Table 1 values must be met to land apply sludge:

Arsenic	75	Lead	840	Nickel	420
Cadmium	85	Mercury	5757	Selenium	100
Copper	4300	Molybdenum	75	Zinc	7500

(3) 503.13(b)(3), Table 3 must be met for any sludge applied to a lawn or home garden. For bulk sludge, Table 3 must be met or the sludge is subject to cumulative loading limits in 503.13(b)(2). For sewage sludge sold and given away in a bag or other container, Table 3 must also be met or the sludge is subject to annual pollutant loadings in 503.13(b)(4). This also signals that additional recordkeeping requirements of 503.12 and 503.17 apply.

Arsenic	41	Lead	300	Selenium	100
Cadmium	39396	Mercury	17	Zinc	2800
Copper	1500	Nickel	420		

(4) Class A requirements must be met when bulk sludge is land applied to a lawn or home garden, or when sewage sludge is sold or given away in a bag or another container. Also, Class A requirements or Class B requirements combined with appropriate site restrictions must be met for when bulk or bulk material derived from sludge is applied to agricultural land, reclamation site, forest, or public contact site.

(5) Process to Significantly Reduce Pathogens (PSRP) includes Aerobic Digestion, Air Drying, Anaerobic Digestion, Composting, and Lime Stabilization. Process to Further Reduce Pathogens (PFRP) includes Composting, Heat Drying, Heat Treatment, Thermophilic Aerobic Digestion, Beta Ray Irradiation, Gamma Ray Irradiation, and Pasteurization. Each process has required operating conditions to demonstrate compliance. See 503 Appendix B and Unit Process Checklists.

(6) One of the methods 503.33(b)(1)-(10) must be used when land applying bulk sewage sludge to agricultural land, forest, a public contact site, or a reclamation site. One of the methods 503.33(b)(1)-(8) must be met when land applying bulk sludge to a lawn or home garden, or when sewage sludge or derived material is sold or given away in a bag or another container.

(7) Volatile solids reduction through the sludge treatment train [only] is generally calculated using the Van Kleeck equation. following general formula:

$$\% \text{ VS Reduction} = \left(\frac{\text{Mass of solids in, kg} - \text{Mass of solids out, kg}}{\text{Mass of solids in, kg}} \right) \times 100$$

Sludge Inspection Checklist

<p>Other Variations of this formula are presented in the document Environmental Regulations and Technology-Control of Pathogens and Vector Attraction in Sewage Sludge, EPA-625/R-92/013. See document for specific calculations. Website: http://www.epa.gov/ORD/NRMRL/Pubs/1992/625R92013.html.</p>			
Yes	No	N/A	1. Does each Surface Disposal Unit (SDU) have a liner and leachate collection system?
			2. Smallest distance from active SDU boundary to property boundary is _____ ft.
Yes	No	N/A	3. For an active SDU (property boundary is greater than 150 meters from SDU) and without a liner or leachate collection system, do monitoring results show pollutant concentrations below values shown in 40 CFR Part 503.23(a)(1) Table 1? [503.23(a)(1) ⁽¹⁾
Yes	No	N/A	4. For an active SDU without a liner and leachate collection system (property boundary is less than 150 meters from SDU), do monitoring results show pollutant concentrations below values shown in 40 CFR Part 503.23(a)(2) Table 2? [503.23(a)(1) ⁽²⁾
Yes	No	N/A	5. Are management practices employed? [503.24]
Yes	No	N/A	<p>6. List management practices where applicable:</p> <p><input type="checkbox"/> No threatened or endangered species present or critical habitat affected at the location where bulk sludge is surface disposed.</p> <p><input type="checkbox"/> Surface disposal unit shall not restrict flow of base flood.</p> <p><input type="checkbox"/> If in seismic impact zone, design will withstand recorded horizontal ground acceleration.</p> <p><input type="checkbox"/> Located > 60 meters from any fault displaced in Holocene time.</p> <p><input type="checkbox"/> Not located in unstable area or wetlands.</p> <p><input type="checkbox"/> Runoff collection and treatment with 25-year, 24-hour storm runoff event storage capacity.</p> <p><input type="checkbox"/> Leachate collection system operated and maintained for 3 years after closure of the surface disposal unit.</p> <p><input type="checkbox"/> Leachate treated and disposed of in accordance with applicable requirements, i.e., NPDES permit.</p> <p><input type="checkbox"/> Methane is contained under covered units at a concentration less than 25% of the LEL for methane.</p> <p><input type="checkbox"/> Methane is contained under a final cover placed on a closed unit maintained at a concentration less than 25% of the LEL for methane for three years after closure.</p> <p><input type="checkbox"/> Methane concentration at the property line is maintained at a concentration less than the LEL for methane for three years after closure of the unit.</p> <p><input type="checkbox"/> No feed or food crops grown on active unit.⁽³⁾</p> <p><input type="checkbox"/> No animal grazing allowed on active unit.⁽³⁾</p> <p><input type="checkbox"/> Public access restricted for the period of time while a unit is active and for three years after last active unit in a site closes.</p>

Sludge Inspection Checklist

			<input type="checkbox"/> Sludge placed in an active unit does not contaminate groundwater aquifers. ⁽⁴⁾
Yes	No	N/A	7. Classification of Sewage Sludge with respect to Pathogens: [503.30] Class A <input type="checkbox"/> Class B <input type="checkbox"/> Unknown <input type="checkbox"/>
Yes	No	N/A	8. Are Class A Pathogen reductions requirements met? [503.15(a)] ⁽⁵⁾
			9. Indicate which method is used to meet Class A requirements: [503.32(a)] <input type="checkbox"/> Fecal Coliform <1000 MPN/g total solids, or <i>Salmonella</i> <3 MPN/4 g total solids, and Time/Temperature requirements. [503.32(a)(3)] <input type="checkbox"/> Fecal Coliform <1000 MPN/g total solids, or <i>Salmonella</i> <3 MPN/4 g total solids, and pH requirements. [503.32(a)(4)] <input type="checkbox"/> Fecal Coliform <1000 MPN/g total solids, or <i>Salmonella</i> <3 MPN/4 g total solids, and enteric viruses or helminth ova reduction requirements. [503.32(a)(5)] <input type="checkbox"/> Fecal Coliform <1000 MPN/g total solids, or <i>Salmonella</i> <3 MPN/4 g total solids, and enteric viruses or helminth ova density requirements. [503.32(a)(6)] <input type="checkbox"/> Fecal Coliform <1000 MPN/g total solids, or <i>Salmonella</i> <3 MPN/4 g total solids, and Process to Further Reduce Pathogens (PFRP). [503.32(a)(7) and [503 Appendix B] <input type="checkbox"/> Fecal Coliform <1000 MPN/g total solids, or <i>Salmonella</i> <3 MPN/4 g total solids, and equivalent PFRP. [503.32(a)(8) and [503 Appendix B] ⁽⁷⁾
Yes	No	N/A	10. Are Class B Pathogen reduction requirements met? [503.32(b)] (5)
			11. Indicate which method(s) is used to meet Class B requirements: <input type="checkbox"/> Geometric mean of seven Fecal Coliform samples with <2,000,000 MPN/g total solids or <2,000,000 Colony Forming Units/g total solids. [503.32(b)(2)] <input type="checkbox"/> Treated by Process to Significantly Reduce Pathogens (PSRP). [503.32(b)(3) and [503 Appendix B] ⁽⁶⁾ <input type="checkbox"/> Treated by equivalent PSRP. [503.32(b)(4) and [503 Appendix B] ⁽⁶⁾
Yes	No	N/A	12. Is a Vector Attraction Reduction method practiced? [503.25(b)] ⁽⁷⁾
Yes	No	N/A	13. Indicate Vector Attraction Reduction method: [503.33(b)] <input type="checkbox"/> 38% Volatile Solids Reduction. [503.33(b)(1)] <input type="checkbox"/> 40-day test - Volatile Solids reduced <17%. [503.33(b)(2) (Anaerobic Digestion Only)] <input type="checkbox"/> 30-day test - Volatile Solids reduced <15%. [503.33(b)(3) (Aerobic Digestion Only)] <input type="checkbox"/> Specific Oxygen Uptake Rate (SOUR) <1.5 mg/hr./gm TS @ 20°C. [503.33(b)(4)] <input type="checkbox"/> Aerobic Process for >14 days @ >40°C with average sludge temperatures >45°C. [503.33(b)(5)] <input type="checkbox"/> pH >12 for 2 hours and pH >11.5 for 22 hours [503.33(b)(6)] <input type="checkbox"/> Sludge (with no unstabilized solids) contains >75% Total Solids prior to mixing with other materials. [503.33(b)(7)] <input type="checkbox"/> Sludge (contains unstabilized solids) contains >90% Total Solids prior to mixing with other materials. [503.33(b)(8)]

Sludge Inspection Checklist

			<input type="checkbox"/> Subsurface Injection. [503.33(b)(9)] <input type="checkbox"/> Soil Incorporation. [503.33(b)(10)] <input type="checkbox"/> Sludge covered with soil or other material at the end of the day. [503.33(b)(11)]
Yes	No	N/A	14. Have any SDUs been closed?
Yes	No	N/A	15. Has facility submitted closure and post closure plan for any active SDU 180 days prior to closing? [503.22(c)]
Comments:			

Surface Disposal Footnotes:

⁽¹⁾ Table 1 of 503.23(a)(1) must be met for all sludge placed in an active surface disposal unit with a distance of greater than 150 meters from the boundary of the surface disposal unit to the property line. Site-specific limits can also be set by the permitting authority in accordance with 503.23(b).

Table 1 (mg/kg - dry weight basis)

Arsenic	73	Chromium	600	Nickel	420
---------	----	----------	-----	--------	-----

⁽²⁾ Table 2 of 503.23(a)(2) must be met for all sludge placed in an active surface disposal unit with a distance of less than 150 meters from the boundary of the surface disposal unit to the property line. Site-specific limits can also be set by the permitting authority in accordance with 503.23(b).

Table 2 (mg/kg - dry weight basis)

Distance between unit boundary and property line (m)	Pollutant Concentration (mg/kg)		
	Arsenic	Chromium	Nickel
0 to less than 25	30	200	210
25 to less than 50	34	220	240
50 to less than 75	39	260	270
75 to less than 100	46	300	320
100 to less than 125	53	360	390
125 to less than 150	62	450	420

⁽³⁾ Unless specific approval from the permitting authority has been obtained by the facility.

⁽⁴⁾ Facility must have results of groundwater monitoring study developed by a qualified groundwater scientist or a certification from a qualified groundwater scientist to demonstrate no contamination.

⁽⁵⁾ Facility must meet Class A pathogen reduction requirements of 503.32(a) or Class B 503.32(b)(2) through (b)(4) unless vector attraction reduction method 503.33(b)(11), covering sludge at the end of the day, is used.

⁽⁶⁾ Process to Significantly Reduce Pathogens (PSRP) includes Aerobic Digestion, Air Drying, Anaerobic Digestion, Composting, and Lime Stabilization. Process to Further Reduce Pathogens (PFRP) includes Composting, Heat Drying, Heat Treatment, Thermophilic Aerobic Digestion, Beta Ray Irradiation, Gamma Ray Irradiation, and Pasteurization. Each process has required operating conditions to demonstrate compliance. See 503 Appendix B and Unit Process Checklist.

⁽⁷⁾ Facility must meet vector attraction reduction requirements of 503.33(b) to surface dispose sludge.

Sludge Inspection Checklist

Yes	No	N/A	1. Does the incinerator meet the definition of a sewage sludge incinerator?
Yes	No	N/A	2. Do sewage sludge monitoring results show pollutant concentrations below permit limits?
Yes	No	N/A	3. Does THC monitoring show concentrations below 100 ppm (monthly average)?
Yes	No	N/A	4. Are there instruments installed that continuously measure and record THC (or alternatively CO), oxygen concentration, moisture content, and combustion temperatures?
Yes	No	N/A	5. Is the THC instrument calibrated as required by 503.45 (once every 24-hour period using propane) or the permit?
Yes	No	N/A	6. Are the other instruments calibrated as required by the permit?
Yes	No	N/A	7. Are the instruments operated and maintained as specified by the permit?
Yes	No	N/A	8. How many times was the incinerator operated at above the maximum combustion temperature specified in the permit? _____ For how long was the incinerator in operation above the maximum combustion temperature? _____
Yes	No	N/A	9. How many times was the incinerator operated outside the range of the air pollution control devices operating parameters specified in the permit? _____ For how long was the incinerator in operation outside the ranges? _____
Yes	No	N/A	10. Are the following records maintained:
Yes	No	N/A	Concentration of lead, arsenic, cadmium, chromium, and nickel in the sewage sludge fed to the sewage sludge incinerator.
Yes	No	N/A	THC concentrations in the exit gas.
Yes	No	N/A	Information that indicates NESHAP for beryllium in Subpart C of 40 CFR Part 61 is met.
Yes	No	N/A	Information that indicates NESHAP for mercury in Subpart E of 40 CFR Part 61 is met.
Yes	No	N/A	Combustion temperatures, including maximum combustion temperature.
Yes	No	N/A	Values for air pollution control device operating parameters.
Yes	No	N/A	Oxygen concentration.
Yes	No	N/A	Information used to measure moisture content in the exit gas.
Yes	No	N/A	Sewage sludge feed rate.
Yes	No	N/A	Stack height of incinerator.
Yes	No	N/A	Dispersion factor for the site.
Yes	No	N/A	Control efficiency for lead, arsenic, cadmium, chromium, and nickel.
Yes	No	N/A	Risk specific concentration for chromium (if applicable).
Yes	No	N/A	Calibration and maintenance log for the instruments used to measure THC (or CO), oxygen concentration, moisture content, and combustion temperatures.

Sludge Inspection Checklist

Yes	No	N/A	Are these records maintained for 5 years?
Yes	No	N/A	11. Have all instances of noncompliance been reported as specified by the permit?
Comments:			

Appendix Q – No Exposure Certification Form

NPDES FORM 3510-11		United States Environmental Protection Agency Washington, DC 20460 NO EXPOSURE CERTIFICATION for Exclusion from NPDES Storm Water Permitting	Form Approved OMB No. 2040-0211
<p>Submission of this No Exposure Certification constitutes notice that the entity identified in Section A does not require permit authorization for its storm water discharges associated with industrial activity in the State identified in Section B under EPA's Storm Water Multi-Sector General Permit due to the existence of a condition of no exposure.</p> <p>A condition of no exposure exists at an industrial facility when all industrial materials and activities are protected by a storm resistant shelter to prevent exposure to rain, snow, snowmelt, and/or runoff. Industrial materials or activities include, but are not limited to, material handling equipment or activities, industrial machinery, raw materials, intermediate products, by-products, final products, or waste products. Material handling activities include the storage, loading and unloading, transportation, or conveyance of any raw material, intermediate product, final product or waste product. A storm resistant shelter is not required for the following industrial materials and activities:</p> <ul style="list-style-type: none"> - drums, barrels, tanks, and similar containers that are tightly sealed, provided those containers are not deteriorated and do not leak. "Sealed" means banded or otherwise secured and without operational taps or valves; - adequately maintained vehicles used in material handling; and - final products, other than products that would be mobilized in storm water discharges (e.g., rock salt). <p>A No Exposure Certification must be provided for each facility qualifying for the no exposure exclusion. In addition, the exclusion from NPDES permitting is available on a facility-wide basis only, not for individual outfalls. If any industrial activities or materials are or will be exposed to precipitation, the facility is not eligible for the no exposure exclusion.</p> <p>By signing and submitting this No Exposure Certification form, the entity in Section A is certifying that a condition of no exposure exists at its facility or site, and is obligated to comply with the terms and conditions of 40 CFR 122.26(g).</p> <p>ALL INFORMATION MUST BE PROVIDED ON THIS FORM.</p> <p>Detailed instructions for completing this form and obtaining the no exposure exclusion are provided on pages 3 and 4.</p>			
<p>A. Facility Operator Information</p> <p>1. Name: <input style="width: 50%;" type="text"/> 2. Phone: <input style="width: 20%;" type="text"/></p> <p>3. Mailing Address: a. Street: <input style="width: 50%;" type="text"/></p> <p>b. City: <input style="width: 20%;" type="text"/> c. State: <input style="width: 5%;" type="text"/> d. Zip Code: <input style="width: 20%;" type="text"/> - <input style="width: 5%;" type="text"/></p>			
<p>B. Facility/Site Location Information</p> <p>1. Facility Name: <input style="width: 80%;" type="text"/></p> <p>2. a. Street Address: <input style="width: 80%;" type="text"/></p> <p>b. City: <input style="width: 30%;" type="text"/> c. County: <input style="width: 30%;" type="text"/></p> <p>d. State: <input style="width: 5%;" type="text"/> e. Zip Code: <input style="width: 20%;" type="text"/> - <input style="width: 5%;" type="text"/></p> <p>3. Is the facility located on Indian Lands? Yes <input type="checkbox"/> No <input type="checkbox"/></p> <p>4. Is this a Federal facility? Yes <input type="checkbox"/> No <input type="checkbox"/></p> <p>5. a. Latitude: <input style="width: 5%;" type="text"/> ° <input style="width: 5%;" type="text"/> ' <input style="width: 5%;" type="text"/> " b. Longitude: <input style="width: 5%;" type="text"/> ° <input style="width: 5%;" type="text"/> ' <input style="width: 5%;" type="text"/> "</p> <p>6. a. Was the facility or site previously covered under an NPDES storm water permit? Yes <input type="checkbox"/> No <input type="checkbox"/></p> <p>b. If yes, enter NPDES permit number: _____</p> <p>7. SIC/Activity Codes: Primary: <input style="width: 10%;" type="text"/> Secondary (if applicable): <input style="width: 10%;" type="text"/></p> <p>8. Total size of site associated with industrial activity: _____ acres</p> <p>9. a. Have you paved or roofed over a formerly exposed, pervious area in order to qualify for the no exposure exclusion? Yes <input type="checkbox"/> No <input type="checkbox"/></p> <p>b. If yes, please indicate approximately how much area was paved or roofed over. Completing this question does not disqualify you for the no exposure exclusion. However, your permitting authority may use this information in considering whether storm water discharges from your site are likely to have an adverse impact on water quality, in which case you could be required to obtain permit coverage.</p> <p style="text-align: center;">Less than one acre <input type="checkbox"/> One to five acres <input type="checkbox"/> More than five acres <input type="checkbox"/></p>			

NPDES FORM 3510-11		NO EXPOSURE CERTIFICATION for Exclusion from NPDES Storm Water Permitting	Form Approved OMB No. 2040-0211
C. Exposure Checklist			
Are any of the following materials or activities exposed to precipitation, now or in the foreseeable future? (Please check either "Yes" or "No" in the appropriate box.) If you answer "Yes" to any of these questions (1) through (11), you are <u>not</u> eligible for the no exposure exclusion.			
		Yes	No
1.	Using, storing or cleaning industrial machinery or equipment, and areas where residuals from using, storing or cleaning industrial machinery or equipment remain and are exposed to storm water	<input type="checkbox"/>	<input type="checkbox"/>
2.	Materials or residuals on the ground or in storm water inlets from spills/leaks	<input type="checkbox"/>	<input type="checkbox"/>
3.	Materials or products from past industrial activity	<input type="checkbox"/>	<input type="checkbox"/>
4.	Material handling equipment (except adequately maintained vehicles)	<input type="checkbox"/>	<input type="checkbox"/>
5.	Materials or products during loading/unloading or transporting activities	<input type="checkbox"/>	<input type="checkbox"/>
6.	Materials or products stored outdoors (except final products intended for outside use [e.g., new cars] where exposure to storm water does not result in the discharge of pollutants)	<input type="checkbox"/>	<input type="checkbox"/>
7.	Materials contained in open, deteriorated or leaking storage drums, barrels, tanks, and similar containers	<input type="checkbox"/>	<input type="checkbox"/>
8.	Materials or products handled/stored on roads or railways owned or maintained by the discharger	<input type="checkbox"/>	<input type="checkbox"/>
9.	Waste material (except waste in covered, non-leaking containers [e.g., dumpsters])	<input type="checkbox"/>	<input type="checkbox"/>
10.	Application or disposal of process wastewater (unless otherwise permitted)	<input type="checkbox"/>	<input type="checkbox"/>
11.	Particulate matter or visible deposits of residuals from roof stacks and/or vents not otherwise regulated (i.e., under an air quality control permit) and evident in the storm water outflow	<input type="checkbox"/>	<input type="checkbox"/>
D. Certification Statement			
I certify under penalty of law that I have read and understand the eligibility requirements for claiming a condition of "no exposure" and obtaining an exclusion from NPDES storm water permitting.			
I certify under penalty of law that there are no discharges of storm water contaminated by exposure to industrial activities or materials from the industrial facility or site identified in this document (except as allowed under 40 CFR 122.26(g)(2)).			
I understand that I am obligated to submit a no exposure certification form once every five years to the NPDES permitting authority and, if requested, to the operator of the local municipal separate storm sewer system (MS4) into which the facility discharges (where applicable). I understand that I must allow the NPDES permitting authority, or MS4 operator where the discharge is into the local MS4, to perform inspections to confirm the condition of no exposure and to make such inspection reports publicly available upon request. I understand that I must obtain coverage under an NPDES permit prior to any point source discharge of storm water from the facility.			
Additionally, I certify under penalty of law that this document and all attachments were prepared under my direction or supervision in accordance with a system designed to assure that qualified personnel properly gathered and evaluated the information submitted. Based on my inquiry of the person or persons who manage the system, or those persons directly responsible for gathering the information, the information submitted is to the best of my knowledge and belief true, accurate and complete. I am aware that there are significant penalties for submitting false information, including the possibility of fine and imprisonment for knowing violations.			
Print Name: <input style="width: 95%; border: none; border-bottom: 1px solid black;" type="text"/>			
Print Title: <input style="width: 95%; border: none; border-bottom: 1px solid black;" type="text"/>			
Signature: _____			
Date: <input style="width: 10%; border: none; border-bottom: 1px solid black;" type="text"/> <input style="width: 10%; border: none; border-bottom: 1px solid black;" type="text"/> <input style="width: 10%; border: none; border-bottom: 1px solid black;" type="text"/> <input style="width: 10%; border: none; border-bottom: 1px solid black;" type="text"/> <input style="width: 10%; border: none; border-bottom: 1px solid black;" type="text"/> <input style="width: 10%; border: none; border-bottom: 1px solid black;" type="text"/>			

<p>NPDES FORM 3510-11</p>		<p>Instructions for the NO EXPOSURE CERTIFICATION for Exclusion from NPDES Storm Water Permitting</p>	<p>Form Approved OMB No. 2040-0211</p>				
<p>Who May File a No Exposure Certification</p> <p>Federal law at 40 CFR Part 122.26 prohibits point source discharges of storm water associated with industrial activity to waters of the U.S. without a National Pollutant Discharge Elimination System (NPDES) permit. However, NPDES permit coverage is not required for discharges of storm water associated with industrial activities identified at 40 CFR 122.26(b)(14)(i)-(ix) and (xi) if the discharger can certify that a condition of "no exposure" exists at the industrial facility or site.</p> <p>Storm water discharges from construction activities identified in 40 CFR 122.26(b)(14)(x) and (b)(15) are not eligible for the no exposure exclusion.</p> <p>Obtaining and Maintaining the No Exposure Exclusion</p> <p>This form is used to certify that a condition of no exposure exists at the industrial facility or site described herein. This certification is only applicable in jurisdictions where EPA is the NPDES permitting authority and must be re-submitted at least once every five years.</p> <p>The industrial facility operator must maintain a condition of no exposure at its facility or site in order for the no exposure exclusion to remain applicable. If conditions change resulting in the exposure of materials and activities to storm water, the facility operator must obtain coverage under an NPDES storm water permit immediately.</p> <p>Where to File the No Exposure Certification Form</p> <table style="width: 100%; border: none;"> <tr> <td style="width: 50%; border: none;"><u>No Exposure Forms sent regular mail:</u></td> <td style="width: 50%; border: none;"><u>Forms sent overnight/express:</u></td> </tr> <tr> <td style="border: none;"> SW No Exposure Certification (4203M) USEPA 1200 Pennsylvania Avenue, NW Washington, D.C. 20460 </td> <td style="border: none;"> SW No Exposure Certification US EPA East Building, Rm. 7329 1201 Constitution Avenue, NW Washington, D.C. 20004 (202) 564-9537 </td> </tr> </table> <p>Completing the Form</p> <p>You must type or print, using uppercase letters, in appropriate areas only. Enter only one character per space (i.e., between the marks). Abbreviate if necessary to stay within the number of characters allowed for each item. Use one space for breaks between words. One form must be completed for each facility or site for which you are seeking to certify a condition of no exposure. Additional guidance on completing this form can be accessed through EPA's web site at www.epa.gov/owm/sw. Please make sure you have addressed all applicable questions and have made a photocopy for your records before sending the completed form to the above address.</p> <p>Section A. Facility Operator Information</p> <ol style="list-style-type: none"> 1. Provide the legal name of the person, firm, public organization, or any other entity that operates the facility or site described in this certification. The name of the operator may or may not be the same as the name of the facility. The operator is the legal entity that controls the facility's operation, rather than the plant or site manager. 2. Provide the telephone number of the facility operator. 3. Provide the mailing address of the operator (P.O. Box numbers may be used). Include the city, state, and zip code. All correspondence will be sent to this address. 		<u>No Exposure Forms sent regular mail:</u>	<u>Forms sent overnight/express:</u>	SW No Exposure Certification (4203M) USEPA 1200 Pennsylvania Avenue, NW Washington, D.C. 20460	SW No Exposure Certification US EPA East Building, Rm. 7329 1201 Constitution Avenue, NW Washington, D.C. 20004 (202) 564-9537	<p>Section B. Facility/Site Location Information</p> <ol style="list-style-type: none"> 1. Enter the official or legal name of the facility or site. 2. Enter the complete street address (if no street address exists, provide a geographic description [e.g., Intersection of Routes 9 and 55]), city, county, state, and zip code. Do not use a P.O. Box number. 3. Indicate whether the facility is located on Indian Lands. 4. Indicate whether the industrial facility is operated by a department or agency of the Federal Government (see also Section 313 of the Clean Water Act). 5. Enter the latitude and longitude of the approximate center of the facility or site in degrees/minutes/seconds. Latitude and longitude can be obtained from United States Geological Survey (USGS) quadrangle or topographic maps, by calling 1-(888) ASK-USGS, or by accessing EPA's web site at http://www.epa.gov/owm/sw/industry/index.htm and selecting Latitude and Longitude Finders under the Resources/Permit section. <p>Latitude and longitude for a facility in decimal form must be converted to degrees (°), minutes ('), and seconds (") for proper entry on the certification form. To convert decimal latitude or longitude to degrees/minutes/seconds, follow the steps in the following example.</p> <p><u>Example:</u> Convert decimal latitude 45.1234567 to degrees (°), minutes ('), and seconds (").</p> <ol style="list-style-type: none"> a) The numbers to the left of the decimal point are the degrees: 45°. b) To obtain minutes, multiply the first four numbers to the right of the decimal point by 0.006: 1234 x 0.006 = 7.404. c) The numbers to the left of the decimal point in the result obtained in (b) are the minutes: 7'. d) To obtain seconds, multiply the remaining three numbers to the right of the decimal from the result obtained in (b) by 0.06: 404 x 0.06 = 24.24. Since the numbers to the right of the decimal point are not used, the result is 24". e) The conversion for 45.1234567 = 45° 7' 24". <ol style="list-style-type: none"> 6. Indicate whether the facility was previously covered under an NPDES storm water permit. If so, include the permit number. 7. Enter the 4-digit SIC code which identifies the facility's primary activity, and second 4-digit SIC code identifying the facility's secondary activity, if applicable. SIC codes can be obtained from the <u>Standard Industrial Classification Manual, 1987</u>. 8. Enter the total size of the site associated with industrial activity in acres. Acreage may be determined by dividing square footage by 43,560, as demonstrated in the following example. <p><u>Example:</u> Convert 54,450 ft² to acres</p> <p>Divide 54,450 ft² by 43,560 square feet per acre: $54,450 \text{ ft}^2 \div 43,560 \text{ ft}^2/\text{acre} = 1.25 \text{ acres}$.</p> <ol style="list-style-type: none"> 9. Check "Yes" or "No" as appropriate to indicate whether you have paved or roofed over a formerly exposed, pervious area (i.e., lawn, meadow, dirt or gravel road/parking lot) in order to qualify for no exposure. If yes, also indicate approximately how much area was paved or roofed over and is now impervious area. 	
<u>No Exposure Forms sent regular mail:</u>	<u>Forms sent overnight/express:</u>						
SW No Exposure Certification (4203M) USEPA 1200 Pennsylvania Avenue, NW Washington, D.C. 20460	SW No Exposure Certification US EPA East Building, Rm. 7329 1201 Constitution Avenue, NW Washington, D.C. 20004 (202) 564-9537						

<p>NPDES FORM 3510-11</p>		<p>Instructions for the NO EXPOSURE CERTIFICATION for Exclusion from NPDES Storm Water Permitting</p>	<p>Form Approved OMB No. 2040-0211</p>
<p>Section C. Exposure Checklist</p> <p>Check "Yes" or "No" as appropriate to describe the exposure conditions at your facility. If you answer "Yes" to ANY of the questions (1) through (11) in this section, a potential for exposure exists at your site and you cannot certify to a condition of no exposure. You must obtain (or already have) coverage under an NPDES storm water permit. After obtaining permit coverage, you can institute modifications to eliminate the potential for a discharge of storm water exposed to industrial activity, and then certify to a condition of no exposure.</p> <p>Section D. Certification Statement</p> <p>Federal statutes provide for severe penalties for submitting false information on this application form. Federal regulations require this application to be signed as follows:</p> <p>For a corporation: by a responsible corporate officer, which means:</p> <ul style="list-style-type: none"> (i) president, secretary, treasurer, or vice-president of the corporation in charge of a principal business function, or any other person who performs similar policy or decision making functions for the corporation, or (ii) the manager of one or more manufacturing, production, or operating facilities, provided the manager is authorized to make management decisions which govern the operation of the regulated facility including having the explicit or implicit duty of making major capital investment recommendations, and initiating and directing other comprehensive measures to assure long term environmental compliance with environmental laws and regulations; the manager can ensure that the necessary systems are established or actions taken to gather complete and accurate information for permit application requirements; and where 		<p>authority to sign documents has been assigned or delegated to the manager in accordance with corporate procedures;</p> <p>For a partnership or sole proprietorship: by a general partner or the proprietor; or</p> <p>For a municipal, State, Federal, or other public facility: by either a principal executive or ranking elected official.</p> <p>Paperwork Reduction Act Notice</p> <p>Public reporting burden for this certification is estimated to average 1.0 hour per certification, including time for reviewing instructions, searching existing data sources, gathering and maintaining the data needed, and completing and reviewing the collection of information. Burden means the total time, effort, or financial resources expended by persons to generate, maintain, retain, or disclose to provide information to or for a Federal agency. This includes the time needed to review instructions; develop, acquire, install, and utilize technology and systems for the purposes of collecting, validating, and verifying information, processing and maintaining information, and disclosing and providing information; adjust the existing ways to comply with any previously applicable instructions and requirements; train personnel to be able to respond to a collection of information; search data sources; complete and review the collection of information; and transmit or otherwise disclose the information. An agency may not conduct or sponsor, and a person is not required to respond to, a collection of information unless it displays a currently valid OMB control number. Send comments regarding the burden estimate, any other aspect of the collection of information, or suggestions for improving this form, including any suggestions which may increase or reduce this burden to: Director, OPPE Regulatory Information Division (2137), USEPA, 401 M Street, SW, Washington, D.C. 20460. Include the OMB control number of this form on any correspondence. Do not send the completed No Exposure Certification form to this address.</p>	

Appendix R – NPDES Industrial Storm Water Investigation and Case Development (Industrial)

Background Information *(complete in field)*

National Database Information				General	
Inspection Type	W			Inspector Name	
NPDES ID Number				Telephone	
Inspection Date				Entry Time	
Inspection Type	EPA	State	EPA Oversight	Exit Time	
Facility Type				Signature	

Facility Location Information				
Name/Location/ Mailing Address				
GPS Coordinates	Latitude		Longitude	
Receiving Water(s)/MS4's				

Contact Information		
	Name	Telephone
Owner/Permittee		
Operator		
Co-Permittee		
Facility Contact		
Authorized Official(s)		

Site Information:	
Industrial Activity that qualifies the facility for permit coverage	
SIC Code(s)	
No Exposure Certification	

Basic Permit Information <i>(circle one)</i>			
Permit Coverage	Y	N	
Permit Type	General	Individual	
Copy of NOI on-site?	Y	N	
NOI Date			

Basic SWPPP Information			
SWPPP on-site	Y	N	
SWPPP Satisfactory*	Y	N	
SWPPP Implementation Satisfactory	Y	N	
*A Satisfactory SWPPP must be both current and complete (see pages 4, 5, and 6 of this checklist).			

SWPPP Review *(can be completed in office)*

General		Notes:	
Is there a SWPPP?	Y N		
Is a copy of the SWPPP on-site?	Y N		
Was the SWPPP developed before the submittal of the NOI?	Y N		
Did all "operators" and co-permittees sign the SWPPP?	Y N		
Did the signatures include the certification statement?	Y N		
Were the signatories authorized to sign?	Y N		
Was the SWPPP developed specifically for this site?	Y N		
Has it been revised to address any recent changes to operations on-site?	Y N		
Is an individual/team responsible for developing/implementing SWPPP identified (e.g., pollution prevention team)?	Y N		
Are employee training records regarding storm water pollution prevention topics included in SWPPP?	Y N		
Operator evaluation of ESA requirements.	Y N		

Site Map		Notes:	
Is there a legible site map?	Y	N	
Drainage patterns/outfalls?	Y	N	
Identification of types of pollutants likely to be discharged from each drainage area?	Y	N	
Location of major structural controls used to reduce pollutants in runoff?	Y	N	
Name of receiving water(s) or MS4's listed?	Y	N	
Is receiving water a tributary to waters of the U.S. (if "yes" indicate name of tributary)?	Y	N	
Location of significant materials exposed to storm water?	Y	N	
Locations of major spills occurring within 3 years from date of NOI?	Y	N	
Location of fueling, deicing operations, maintenance, loading and unloading, material storage, waste disposal?	Y	N	

Summary of Potential Pollutant Sources		Notes:	
Description of activities, materials, features of site with potential to contribute significant amounts of pollutants to storm water?	Y	N	
If deicing chemicals are used, is there a record of (1) all the types of chemicals used, including Safety Data Sheets, and (2) monthly quantities, either as measured or using best estimates?	Y	N	
Description of the vehicle and equipment wash water disposal method, including the (1) frequency, (2) volume, and (3) destination of said wash water?	Y	N	
Description of the control measures used for collecting or containing contaminated melt water from collection areas used for disposal of contaminated snow?	Y	N	

Significant Spills & Leaks		Notes:	

List of significant spills and leaks over 3-year time period, description of response taken, and actions to prevent similar spills in the future?	Y	N	
---	---	---	--

Storm Water Controls		Notes:	
Does the SWPPP describe the <i>non-structural</i> controls that will be used to prevent/reduce discharge of pollutants in storm water runoff?	Y	N	
Does the SWPPP describe the <i>structural</i> controls that will be used to prevent/reduce discharge of pollutants in storm water runoff?	Y	N	
Does the SWPPP describe other controls that will be used to prevent/reduce off-site tracking or blowing of sediment, dust and raw, final or waste materials, or other solid materials and floating debris?	Y	N	
Does the SWPPP incorporate the 8 baseline controls (good housekeeping, minimizing exposure, PM, spill prevention/response procedures, routine inspections and comprehensive site evaluations, employee training, sediment and erosion control, runoff management)?	Y	N	
Does the SWPPP contain completed routine inspection reports/logs regarding reportable implementation of 8 baseline controls?	Y	N	
Does the SWPPP describe the pollutant or activity to be controlled by each selected control and provide an implementation schedule?	Y	N	

Non-Storm Water Discharges		Notes:	
Certification that facility has been tested for non-storm water discharges from the site?	Y	N	
Description of testing method, drainage points, observed results, and date of test?	Y	N	

Inspections

Self-Inspections		Notes:	
In what areas does the airport authority conduct facility inspections?			
Are routine facility inspections conducted at least once each calendar quarter, with at least one member of the SWPPP team participating?	Y	N	
Are routine facility inspections conducted at least once each calendar year during a period when a stormwater discharge is occurring?	Y	N	
During each inspection are the following examined: <ul style="list-style-type: none"> Industrial materials, residue or trash that may have come in contact with stormwater Leaks or spills from industrial equipment, drums, tanks, and other containers Offsite tracking of industrial waste materials, or sediment where vehicles enter or exit the site Tracking or blowing of raw, final or waste materials from areas of no exposure to exposed areas Control measures needing replacement, maintenance or repair 	Y	N	
Are the routine facility inspection findings documented and maintained with the SWPPP?	Y	N	
Does the annual report include the following:	Y	N	

<u>Self-Inspections</u>		Notes:
<ul style="list-style-type: none"> • The inspection date and time; • The name(s) and signature(s) of the inspector(s); • Weather information; • All observations relating to the implementation of control measures at the facility; • Any incidents of noncompliance; and • A statement, signed and certified. 		

Deicing Operations (if applicable)

<u>Deicing</u>	Notes:
What deicing chemicals does the airport authority use for aircraft and runway deicing?	
What control measures does the airport authority implement to reduce discharge of pollutants from runway and aircraft deicing operations?	
Has the airport authority determined whether alternatives to glycol are feasible?	
What runoff management control measures does the airport authority implement to minimize the discharge of pollutants in stormwater from runway and aircraft deicing?	
Has the airport authority ever applied deicing fluids during non-precipitation events?	
What control measures does the airport authority implement to minimize the discharge of pollutants from deicing fluids that are applied during non-precipitation events?	
What is the seasonal timeframe during which deicing activities typically occur?	

Sampling

Monitoring		Notes:	
Are samples collected within 30 minutes of measurable weather events occurring 72 hours after previous measurable weather event?	Y	N	
Are sampling locations appropriate?	Y	N	
Were the samples collected and preserved in accordance with 40 CFR Part 136?	Y	N	
Were proper chain-of-custody procedures followed?	Y	N	

SWPPP Implementation *(complete in field)*

General	
Industrial Activity	<i>(describe principal product, production rate, potential pollutants, areas exposed to precipitation, direction of storm water flow)</i>
Facility Description	<i>(describe age and size of facility, number of employees, hours of operation)</i>

Storm Water Controls	
List the structural and non-structural controls employed by the facility.	<i>(provide a brief description of each)</i>

Storm Water Controls	
Are the controls reasonable and appropriate for the facility?	<i>(indicate "yes" or "no", or if not appropriate, explain)</i>
Are the controls installed correctly and maintained in effective operating condition?	<i>(indicate "yes" or "no", or if not appropriate, explain)</i>
Are the structural and non-structural controls employed by the facility consistent with the SWPPP?	<i>(indicate "yes" or "no" and explain any observed discrepancies)</i>
Provide a brief description of other controls that manage/prevent/minimize storm water runoff.	<i>(e.g., erosion and sediment controls, exposure minimization, diversion structures, pollution prevention, inlet protection/control at storm drains)</i>

Miscellaneous	
Any evidence of discharge to receiving waters?	<i>(e.g., storm water runoff, dry weather discharge, co-mingling of process waste water)</i>
Do the storm water outfalls on-site correspond with those listed on the site map and in SWPPP?	<i>(indicate "yes" or "no", or if not appropriate, explain)</i>

Photograph Log	
1.	
2.	
3.	
4.	

Appendix S – Industrial Source Control BMP Questions

Industrial Source Control BMP Questions

FUELING

1. Has spill and overfill prevention equipment been installed?
2. Are vehicle fuel tanks often "topped off"?
3. Have steps been taken to protect fueling areas from rain?
4. Is runoff to the fueling area minimized?
5. Are oil/water separators or oil and grease traps installed in storm drains in the fueling area?
6. Is the fueling area cleaned by hosing or washing?
7. Do you control petroleum spills?
8. Are employees aware of ways to reduce contamination of storm water at fueling stations?
9. Where does the water drain from the fueling area?
10. Do any of the drains connect to wells?

SUMMARY OF FUELING STATION BMPs
<ul style="list-style-type: none">• Consider installing spill and overflow protection.• Discourage topping off of fuel tanks.• Reduce exposure of the fuel area to storm water.• Use dry cleanup methods for the fuel area.• Use proper petroleum spill control.• Encourage employee participation.

MAINTAINING VEHICLES AND EQUIPMENT

1. Is maintenance which involves cleaning of vehicle and/or equipment parts (including engine, transmission, brake or other miscellaneous parts) performed on-site?
2. Does the cleaning involve the use of solvents or surfactants?
3. Has the facility looked into using nontoxic or less toxic cleaners or solvents?
4. Are work areas and spills washed or hosed down with water?
5. Are spills or materials washed or poured down the drain?
6. Are oil filters completely drained before recycling or disposal?
7. Are incoming vehicles and equipment checked for leaking oil and fluids?
8. Are wrecked vehicles or damaged equipment stored onsite?
9. Does the facility recycle any of the automotive fluids or parts?
10. Can the facility reduce the number of different solvents used?
11. Are wastes separated?
12. Does the facility use recycled products?

SUMMARY OF VEHICLE MAINTENANCE AND REPAIR BMPs
<ul style="list-style-type: none">• Check for leaking oil and fluids.• Use nontoxic or low-toxicity materials.• Drain oil filters before disposal or recycling.• Do not pour liquid waste down drains.• Recycle engine fluids and batteries.• Segregate and label wastes.• Buy recycled products.

PAINTING VEHICLES AND EQUIPMENT

1. Are vehicles or other equipment painted on-site?
2. In preparation for painting, is old paint removed physically (sanding, sand blasting, etc.) or chemically (solvent paint stripper)?
3. Before applying new paint, are surfaces chemically prepared (coating, etching, cleaning etc.)?
4. Is care taken to prevent paint wastes from contaminating storm water runoff?
5. Are wastes from sanding contained?
6. Are parts inspected before painting?
7. Is the facility using painting equipment that creates little waste?
8. Are employees trained to use spray equipment correctly?
9. Does the facility recycle paint, paint thinner, or solvents?
10. Are wastes separated?
11. Can the facility reduce the number of solvents used?
12. Does the facility use recycled products?

SUMMARY OF PAINTING OPERATION BMPs
<ul style="list-style-type: none">• Inspect parts prior to painting.• Contain sanding wastes.• Prevent paint waste from contacting storm water.• Use proper interim storage of waste paint, solvents, etc.• Evaluate efficiency of equipment.• Recycle paint, paint thinner, and solvents.• Segregate wastes.• Buy recycled products.

WASHING VEHICLES AND EQUIPMENT

1. Has the facility considered using phosphate-free biodegradable detergents?
2. Are vehicles, equipment, or parts washed over the open ground?

SUMMARY OF VEHICLE AND EQUIPMENT WASHING BMPs
<ul style="list-style-type: none">• Consider use of phosphate-free detergent.• Use designated cleaning areas.• Consider recycling wash water.

LOADING AND UNLOADING MATERIALS

1. Are tank trucks and material delivery vehicles located where spills or leaks can be contained?
2. Is loading/unloading equipment checked regularly for leaks?
3. Are loading/unloading docks or areas covered to prevent exposure to rainfall?
4. Are loading/unloading areas designed to prevent storm water runoff?
5. Is piping system routinely checked for leaks?
6. Are there alarms to alert staff of potential problems such as high levels in receiving tanks or pressure irregularities in transmission lines?
7. Where appropriate (especially where transmission lines are long or buried), is the piping system outfitted with flow meters to ensure that the amount unloaded equals the amount received?

SUMMARY OF LOADING/UNLOADING OPERATIONS BMPs
<ul style="list-style-type: none">• Contain leaks during transfer.• Check equipment regularly for leaks.• Limit exposure of material to rainfall.• Prevent storm water runoff.

LIQUID STORAGE IN ABOVE-GROUND TANKS

1. Do storage tanks contain liquid hazardous materials, hazardous wastes, or oil?
2. Are operators trained in correct operating procedures and safety activities?
3. Does the facility have safeguards against accidental discharge?
4. Are tank systems inspected, and is tank integrity tested regularly?
5. Are tanks bermed or surrounded by a secondary containment system?

SUMMARY OF BMPs FOR LIQUID STORAGE IN ABOVE-GROUND TANKS
<ul style="list-style-type: none">• Comply with applicable State and Federal laws.• Properly train employees.• Install safeguards against accidental release.• Routinely inspect tanks and equipment.• Consider installing secondary containment.

INDUSTRIAL WASTE MANAGEMENT AND OUTSIDE MANUFACTURING

1. Has the facility looked for ways to reduce waste at the facility?
2. Has the facility considered waste reduction BMPs?
3. Are industrial waste management and outside manufacturing areas checked often for spills and leaks?
4. Are industrial waste management areas or manufacturing activities covered, enclosed, or bermed?
5. Are vehicles used to transport wastes to the land disposal or treatment site equipped with anti-spill equipment?
6. Does the facility use loading systems that minimize spills and fugitive losses such as dust or mists?
7. Are sediments or wastes prevented from being tracked offsite?
8. Is storm water runoff minimized from the land disposal site?

SUMMARY OF INDUSTRIAL WASTE MANAGEMENT AND OUTSIDE MANUFACTURING BMPs
<ul style="list-style-type: none">• Conduct a waste reduction assessment.• Institute industrial waste source reduction and recycling BMPs.• Prevent runoff and runoff from contacting the waste management area.• Minimize runoff from land application sites.

OUTSIDE STORAGE OF RAW MATERIALS, BY-PRODUCTS, OR FINISHED PRODUCTS

1. Are materials protected from rainfall, runoff, and runoff?

SUMMARY OF BMPs FOR OUTSIDE STORAGE OF RAW MATERIALS, BY-PRODUCTS, OR FINISHED PRODUCTS
<ul style="list-style-type: none">• Cover or enclose materials.

SALT STORAGE

1. Are salt piles protected from rain?
2. Is storm water runoff prevented from contacting storage piles and loading and unloading areas?

SUMMARY OF SALT STORAGE FACILITIES BMPs
<ul style="list-style-type: none">• Put salt under a roof.• Use temporary covers.• Enclose or berm transfer areas.

Appendix T – Notice of Termination for Stormwater

Instructions for Completing EPA Form 3510-13
**Notice of Termination (NOT) of Coverage Under an NPDES General Permit for
 Storm Water Discharges Associated with Construction Activity**

NPDES Form This Form Replaces Form 3517-7 (8-98)

Form Approved OMB Nos. 2040-0086 and 2040-0211

Who May File an NOT Form

Permittees who are presently covered under the EPA-issued National Pollutant Discharge Elimination System (NPDES) General Permit for Storm Water Discharges Associated with Construction Activity may submit an NOT form when final stabilization has been achieved on all portions of the site for which you are responsible; another operator has assumed control in accordance with Appendix G, Section 11.C of the General Permit over all areas of the site that have not been finally stabilized; coverage under an alternative NPDES permit has been obtained; or for residential construction only, temporary stabilization has been completed and the residence has been transferred to the homeowner.

"Final stabilization" means that all soil disturbing activities at the site have been completed and that a uniform perennial vegetative cover with a density of at least 70% of the native background vegetative cover for the area has been established on all unpaved areas and areas not covered by permanent structures, or equivalent permanent stabilization measures (such as the use of riprap, gabions, or geotextiles) have been employed. See "final stabilization" definition in Appendix A of the Construction General Permit for further guidance where background native vegetation covers less than 100 percent of the ground, in arid or semi-arid areas, for individual lots in residential construction, and for construction projects on land used for agricultural purposes.

Completing the Form

Type or print, using uppercase letters, in the appropriate areas only. Please place each character between the marks. Abbreviate if necessary to stay within the number of characters allowed for each item. Use only one space for breaks between words, but not for punctuation marks unless they are needed to clarify your response. If you have any questions about this form, refer to www.epa.gov/npdes/stormwater/cgp or telephone the Storm Water Notice Processing Center at (866) 352-7755. Please submit original document with signature in ink ♠ do not send a photocopied signature.

Section I. Permit Number

Enter the existing NPDES Storm Water General Permit Tracking Number assigned to the project by EPA's Storm Water Notice Processing Center. If you do not know the permit tracking number, refer to www.epa.gov/npdes/stormwater/cgp or contact the Storm Water Notice Processing Center at (866) 352-7755.

Indicate your reason for submitting this Notice of Termination by checking the appropriate box. Check only one:

Final stabilization has been achieved on all portions of the site for which you are responsible.

Another operator has assumed control according to Appendix G, Section 11.C over all areas of the site that have not been finally stabilized.

Coverage under an alternative NPDES permit has been obtained.

For residential construction only, if temporary stabilization has been completed and the residence has been transferred to the homeowner.

Section II. Operator Information

Provide the legal name of the person, firm, public organization, or any other entity that operates the project described in this application and is covered by the permit tracking number identified in Section I. The

operator of the project is the legal entity that controls the site operation, rather than the site manager. Provide the employer identification number (EIN from the Internal Revenue Service; IRS). If the applicant does not have an EIN enter "NA" in the space provided. Enter the complete mailing address and telephone number of the operator. *Optional:* enter the fax number and e-mail address of the operator.

Section III. Project/Site Information

Enter the official or legal name and complete street address, including city, state, zip code, and county or similar government subdivision of the project or site. If the project or site lacks a street address, indicate the general location of the site (e.g., Intersection of State Highways 61 and 34). Complete site information must be provided for termination of permit coverage to be valid.

Section IV. Certification Information

All applications, including NOIs, must be signed as follows:

For a corporation: By a responsible corporate officer. For the purpose of this Part, a responsible corporate officer means: (i) a president, secretary, treasurer, or vice-president of the corporation in charge of a principal business function, or any other person who performs similar policy- or decision-making functions for the corporation, or (ii) the manager of one or more manufacturing, production, or operating facilities, provided, the manager is authorized to make management decisions which govern the operation of the regulated facility including having the explicit or implicit duty of making major capital investment recommendations, and initiating and directing other comprehensive measures to assure long-term environmental compliance with environmental laws and regulations; the manager can ensure that the necessary systems are established or actions taken to gather complete and accurate information for permit application requirements; and where authority to sign documents has been assigned or delegated to the manager in accordance with corporate procedures.

For a partnership or sole proprietorship: By a general partner or the proprietor, respectively; or

For a municipality, state, federal, or other public agency: By either a principal executive officer or ranking elected official. For purposes of this Part, a principal executive officer of a federal agency includes (i) the chief executive officer of the agency, or (ii) a senior executive officer having responsibility for the overall operations of a principal geographic unit of the agency (e.g., Regional Administrator of EPA).

Include the name and title of the person signing the form and the date of signing. An unsigned or undated NOT form will not be considered valid termination of permit coverage.

Paperwork Reduction Act Notice

Public reporting burden for this application is estimated to average 0.5 hours per notice, including time for reviewing instructions, searching existing data sources, gathering and maintaining the data needed, and completing and reviewing the collection of information. An agency may not conduct or sponsor, and a person is not required to respond to, a collection of information unless it displays a currently valid OMB control number. Send comments regarding the burden estimate, any other aspect of the collection of information, or suggestions for improving this form including any suggestions which may increase or reduce this burden to: Chief, Information Policy Branch, 2136, U.S. Environmental Protection Agency, 1200 Pennsylvania Avenue, NW, Washington, DC 20460. Include the OMB number on any correspondence. Do not send the completed form to this address.

Appendix U – Typical "C" Coefficients

TYPICAL "c" COEFFICIENTS FOR 5- TO 10-YEAR FREQUENCY DESIGN STORMS	
Description of Area	Runoff Coefficients
Business	
• Downtown areas	0.70-0.95
• Neighborhood areas	0.50-0.70
Residential	
• Single-family areas	0.30-0.50
• Multi-units (detached)	0.40-0.60
• Multi-units (attached)	0.60-0.75
Residential (suburban)	0.25-0.40
Apartment dwelling areas	0.50-0.70
Industrial	
• Light areas	0.50-0.80
• Heavy areas	0.60-0.90
Parks and cemeteries	0.10-0.25
Playgrounds	0.20-0.35
Railroad yard areas	0.20-0.40
Unimproved areas	0.10-0.30
Streets	
• Asphalt	0.70-0.95
• Concrete	0.80-0.95
• Brick	0.70-0.85
Drives and walks	0.75-0.85
Roofs	0.75-0.95
Lawns—course textured soil (greater than 85 percent sand)	
• Slope: Flat (2 percent)	0.05-0.10
Average (2-7 percent)	0.10-0.15
Steep (7 percent)	0.15-0.20
Lawns—fine textured soil (greater than 40 percent clay)	
• Slope: Flat (2 percent)	0.13-0.17
Average (2-7 percent)	0.18-0.22
Steep (7 percent)	0.25-0.35
Source: <i>Design and Construction of Sanitary and Storm Sewers</i> , with permission from the publisher, American Society of Civil Engineers, <i>Manual of Practice</i> , page 37, New York, 1960.	

Appendix V – Rain Zones of the United States

Figure U-1

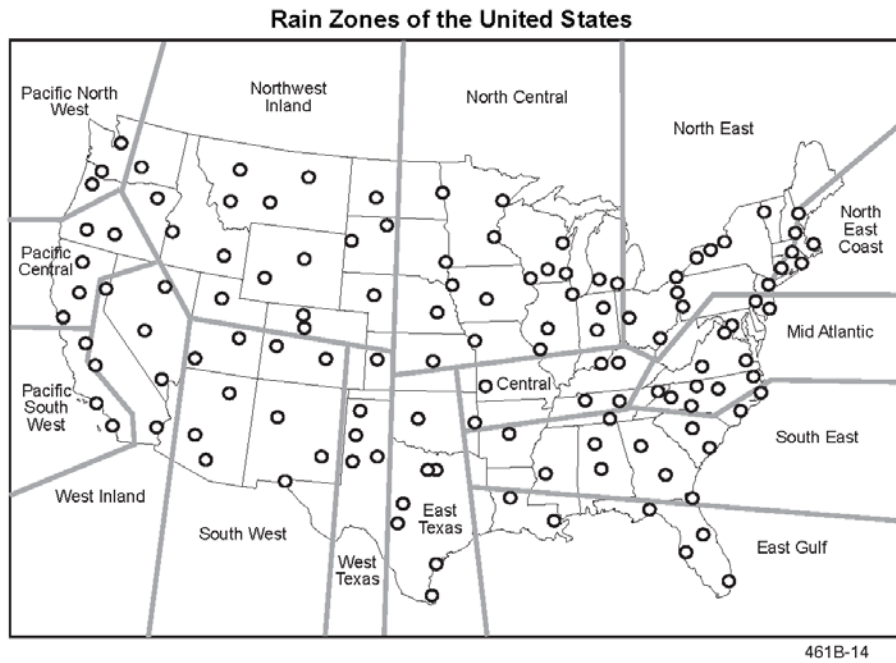

Table U-1

Typical Values of Annual Storm Event Statistics for Rain Zones

Rain Zone	Annual Statistics				Independent Storm Event Statistics							
	No. of Storms		Precip		Duration		Intensity		Volume		DELTA	
	Avg	COV	Avg	COV	Avg	COV	Avg	COV	Avg	COV	Avg	COV
		(in)		(hrs)		(in/hr)		(in)		(hr)		
North East	70	0.13	34.6	0.18	11.2	0.81	0.067	1.23	0.5	0.95	126	0.94
North East-Coastal	63	0.12	41.4	0.21	11.7	0.77	0.071	1.05	0.6	1.03	140	0.87
Midatlantic	62	0.13	39.5	0.18	10.1	0.84	0.082	1.20	0.6	1.01	143	0.97
Central	66	0.14	41.9	0.19	9.2	0.85	0.097	1.09	0.6	1.00	133	0.99
North Central	55	0.16	29.8	0.22	9.5	0.83	0.067	1.20	0.5	1.01	167	1.17
Southeast	65	0.15	49.0	0.20	8.7	0.92	0.122	1.09	0.7	1.10	136	1.03
East Gulf	68	0.17	53.7	0.23	6.4	1.05	0.176	1.03	0.8	1.19	130	1.25
East Texas	41	0.22	31.2	0.29	8.0	0.97	0.137	1.08	0.7	1.16	213	1.26
West Texas	30	0.27	17.3	0.33	7.4	0.98	0.121	1.13	0.5	1.07	302	1.53
Southwest	20	0.30	7.4	0.37	7.6	0.88	0.079	1.16	0.3	0.88	473	1.46
West Inland	14	0.38	4.9	0.43	9.4	0.75	0.055	1.06	0.3	0.87	766	1.54
Pacific South	19	0.36	10.2	0.42	11.6	0.76	0.054	0.76	0.5	0.96	476	2.09
Northwest Inland	31	0.23	11.5	0.29	10.4	0.82	0.057	1.20	0.3	0.83	304	1.43
Pacific Central	32	0.25	18.4	0.33	13.7	0.80	0.048	0.85	0.5	1.05	265	2.00
Pacific Northwest	71	0.15	56.7	0.19	15.9	0.80	0.035	0.73	0.5	1.09	123	1.50

COV - Coefficient of Variation - Standard Deviation / Mean DELTA - Interval between storm midpoints

Appendix W – NOAA Rainfall Worksheet

Appendix X – NPDES Industrial Storm Water Investigation and Case Development (Construction)

Background Information (complete in field)

National Database Information			General	
Inspection Type	W		Inspector Name	
NPDES ID Number			Telephone	
Inspection Date			Entry Time	
Inspector Type (circle one)	EPA	State	EPA Oversight	Exit Time
Facility Type (circle one)	Commercial/Industrial Residential Municipal		Signature	

Facility Location Information				
Name/Location/Mailing Address				
GPS Coordinates	Latitude		Longitude	
Receiving Water(s)				
Disturbed Area		Start Date		Stop Date

Contact Information		
	Name(s)	Telephone
Name(s) and Title(s)/ Role(s) of All Parties Meeting the Definition of Operator		
Facility Contact		
Authorized Official(s)		

Site Information: (circle all that apply)							
Nature of Project	Residential	Commercial/Industrial	Roadway	Private	Federal	State/Municipal	Other
Construction Stage	Clearing/Grubbing	Rough Grading	Infrastructure	Building Construction	Final Grading	Final Stabilization	

Basic Permit Information			Basic SWPPP Information		
Permit Coverage?	Y	N	SWPPP on-site	Y	N
Permit Type	General	Individual	SWPPP Satisfactory*	Y	N
NOI visibly posted at entrance?	Y	N	SWPPP Implementation Satisfactory	Y	Y
Construction sign visibly posted at entrance?	Y	N	*A Satisfactory SWPPP must be both current and complete (see pages 3-6 of this checklist).		
Are instructions posted for obtaining the SWPPP and contacting permit authority if indicators of pollution are observed? (CGP section 1.5)	Y	N			
Copy of permit on-site?	Y	N			
NOI Date					

SWPPP Review (can be completed in office)

General			Notes:
Is there a SWPPP?	Y	N	
Is a copy of the SWPPP on-site?	Y	N	
Was the SWPPP designed specifically for the construction site?	Y	N	
Did all "operators" sign the SWPPP?	Y	N	
Did the signatures include the certification statement?	Y	N	
Were the signatories authorized to sign?	Y	N	
Have modifications been made to the SWPPP?	Y	N	
Are the dates of all SWPPP modifications maintained within the SWPPP?	Y	N	

Do the records of modifications include the name of the person authorizing each change and a brief summary of all changes?	Y	N	
--	---	---	--

Site Description			Notes:
Is there a site description?	Y	N	
Nature/sequence of construction activity?	Y	N	
Total area of site and total area to be disturbed?	Y	N	
Pre/post runoff coefficient/soils description?	Y	N	
Operator evaluation of Endangered Species Act requirements?	Y	N	
Name of receiving water(s) or MS4 listed?	Y	N	
Is the receiving water a tributary to waters of the U.S.? (if "yes" indicate name of tributary)	Y	N	
Is there a site map?	Y	N	
Drainage patterns/outfalls on map?	Y	N	
Area of soil disturbance on map?	Y	N	
Location of major structural controls on map?	Y	N	
Location of storm water discharges to a surface water on map?	Y	N	
Location of materials or equipment storage on map (on-	Y	N	

SWPPP Review (continued)

Controls to Reduce Pollutants		Notes:	
Does the SWPPP include a description of interim and permanent <i>stabilization practices</i> (e.g., seeding, mulching, riprap for the site)?	Y	N	
Does the SWPPP identify the contractor(s) and timing by which <i>stabilization practices</i> will be implemented?	Y	N	
Does the SWPPP include a description of <i>structural practices</i> (e.g., off-site vehicle tracking, silt fences, sediment traps, storm drain inlet protection) for the site?	Y	N	
Where the <i>structural practice</i> is a sediment basin that drains over 10 acres, is it adequately designed? (3,600 cu. ft./acre x total drainage acres)	Y	N	
Does the SWPPP identify the contractor(s) who will implement the <i>structural practices</i> ?	Y	N	
Does the SWPPP identify <i>storm water management</i> measures to address storm water runoff once the construction is completed (e.g., retention ponds, velocity dissipation controls)?	Y	N	
Does the SWPPP describe maintenance procedures for these controls?	Y	N	
If treatment chemicals (polymers, flocculants, etc.) are used, are they being applied properly?	Y	N	
If cationic treatment chemicals are authorized, does the SWPPP contain required description of controls and implementation procedures, etc.?	Y	N	

Inspections			Notes:
Does the SWPPP describe inspection procedures?	Y	N	
Is the inspection schedule at least once every seven (7) calendar days; or once every fourteen (14) calendar days and within twenty-four (24) hours of the occurrence of a storm event of 0.25 inches or greater?	Y	N	
Does the Permittee determine if a storm event of 0.25 inches or greater has occurred on-site? How?	Y	N	
Does the Permittee complete an inspection report within 24 hours of completing any site inspection?	Y	N	
Does the Permittee keep a current copy of all inspection reports at the site or at an easily accessible location?	Y	N	
Do the inspection reports contain the inspection date?	Y	N	
Do the inspection reports contain a summary of inspection findings?	Y	N	
Do the inspection reports contain names and titles of personnel making the inspections?	Y	N	
Are the inspection reports signed and certified by an authorized person?	Y	N	

Corrective Actions			Notes:
Does the Permittee complete a corrective action report for each corrective action taken?	Y	N	
Do the corrective action reports state follow-up actions taken	Y	N	

Corrective Actions			Notes:
Do the corrective action reports state a summary of modifications to stormwater controls?	Y	N	
Do the corrective action reports note whether SWPPP modifications are required as a result of the corrective action?	Y	N	
Does the Permittee keep a current copy of all corrective action reports at the site or at an easily accessible location?	Y	N	

SWPPP Implementation (complete in field)

General	
Site Description	<i>(include description of areas exposed to rainfall/runoff, drainage patterns & direction of flow)</i>

Stabilization Practices	
Any unprotected/ exposed slopes/areas without vegetation, mulch or matting for more than 14 days after construction	<i>(indicate "yes" or "no"; if "yes", how long without such?)</i>

Stabilization Practices	
List stabilization practices employed at site.	<i>(e.g., seeding, mulching, geotextiles, sod stabilization)</i>
Stabilization practices properly applied in a timely manner and adequately maintained?	<i>(indicate "yes" or "no"; explain if necessary)</i>
List structural controls employed at the site. (e.g., silt fences, hay bales, storm drain inlet protection, sedimentation pond, rip rap, check dam, diversion structure)	<i>(provide a brief description for each)</i>

Stabilization Practices	
Discuss how the structural controls are, or are not, appropriate for the site.	<i>(i.e., silt fence installed in a live stream)</i>
Are structural controls installed according to good engineering practices?	<i>(indicate "yes" or "no"; explain if necessary)</i>
Are structural controls properly maintained? (i.e., are inlet protection measures replaced when clogged)	<i>(indicate "yes" or "no"; explain if necessary)</i>

Stabilization Practices	
Are structural controls implemented according to the SWPPP?	<i>(indicate "yes" or "no"; explain if necessary)</i>

SWPPP Implementation *(continued)*

Non-Structural Controls	
Good Housekeeping	<i>(provide brief description and whether appropriate /properly maintained; if N/A, so state)</i>
Vegetative Buffer	<i>(provide brief description and whether appropriate /properly maintained; if N/A, so state)</i>
Materials & Chemical Storage	<i>(provide brief description and whether appropriate /properly maintained; if N/A, so state)</i>
Equipment Wash/ Maintenance Area	<i>(provide brief description and whether appropriate /properly maintained; if N/A, so state)</i>
Concrete Washout Areas	<i>(provide brief description and whether appropriate /properly maintained; if N/A, so state)</i>

SWPPP Implementation *(continued)*

Other Controls	
Street Cleaning	<i>(provide brief description and whether appropriate /properly maintained; if N/A, so state)</i>
Off-site Vehicle Tracking	<i>(provide brief description and whether appropriate /properly maintained; if N/A, so state)</i>
Spill Cleanup	<i>(indicate whether all spills are cleaned up immediately)</i>
Storm Water Outfalls	<i>(indicate whether outfalls identified correspond with the site map)</i>

Other Controls	
Waste Disposal Practices	<i>(provide brief description and whether appropriate /properly maintained; if N/A, so state)</i>

Miscellaneous	
Evidence of sediment or other pollutants in the discharge?	
Evidence of Sediment Deposition to Surface Waters	<i>(provide brief description)</i>
Does the SWPPP reflect current site conditions?	<i>(indicate "yes" or "no"; explain if necessary)</i>

Photograph Log
1.
2.
3.
4.

Appendix Y – Construction Source Control BMP Questions

**CONSTRUCTION SOURCE CONTROL BMP QUESTIONS
SOIL EROSION AND SEDIMENT CONTROL PRACTICES**

MINIMIZE THE AMOUNT OF DISTURBED SOIL

1. Does the site plan require a significant amount of grade changes?
2. Are there portions of the site that do not have to be cleared for construction to proceed?
3. Can construction be performed in stages, so that the entire site does not have to be cleared at one time?
4. Are there portions of the site that will be disturbed then left alone for long periods of time?
5. Does the facility stabilize all disturbed areas after construction is complete?
6. Does snow prevent the facility from seeding an area?
7. Is there enough rainfall to allow vegetation to grow?

PREVENT RUNON FROM FLOWING ACROSS DISTURBED AREAS

1. Does runoff from the undisturbed uphill areas flow onto the construction site?
2. Will runoff flow down a steeply sloped, disturbed area on the site?
3. Is there a swale or stream that runs through the construction site?
4. Does construction traffic have to cross drainage swales or streams?

SLOW DOWN THE RUNOFF TRAVELING ACROSS THE SITE

1. Is the site gently sloped?
2. Is the site stabilized with vegetation?
3. Does runoff concentrate into drainage swales on the site?

REMOVE SEDIMENT FROM ONSITE RUNOFF BEFORE IT LEAVES THE SITE

1. Does the construction disturb an area 10 acres or larger that drains to a common location?
2. Is a sediment basin attainable on the site?
3. Does runoff leave the disturbed area as overland flow?
4. Is the flow concentrated in channels as it leaves the disturbed areas?
5. Are structural controls located along the entire downhill perimeter of all disturbed areas?
6. Is there a piped storm drain system with inlets in a disturbed area?
7. If treatment chemicals are authorized, which are used and how are they being applied and stored?

MEET OR EXCEED LOCAL/STATE REQUIREMENTS FOR EROSION AND SEDIMENT CONTROL

1. Does the State or local government require erosion and sediment control for construction projects?
2. Does the State or local government have an erosion and sediment control requirement that is different from the requirements of the NPDES storm water permit?

OTHER CONTROLS

GOOD HOUSEKEEPING

1. Does the facility appear to implement good housekeeping practices?

WASTE DISPOSAL

1. What steps are taken to ensure that construction waste is properly disposed of?
2. Are provided waste containers sufficient in size and quantity for the amount of waste generated on-site?
3. What management practices are used to minimize or prevent impacts on storm water from hazardous products on the construction site?
4. Are concrete trucks allowed to washout or dump onsite?
5. Is sandblasting performed at the site? If so, what is done with the used grit?

MINIMIZING OFFSITE VEHICLE TRACKING OF SEDIMENTS

1. What measures have been taken to prevent offsite vehicle tracking?

SANITARY/SEPTIC DISPOSAL

1. How are sanitary or septic wastes managed?
2. How does the facility demonstrate compliance with State or local sanitary or septic system regulations?

MATERIAL MANAGEMENT

1. What types of materials are found on the construction site?
2. How are these materials managed?
3. What risks are present onsite as a result of material management practices?
4. Is the facility implementing any methods to reduce potential risks from material management?
5. If applicable, how are pesticides managed at the site?
6. If applicable, how are petroleum products managed at the site?
7. If applicable, what steps are taken to reduce nutrient pollution from fertilizers and detergents?

SPILLS

1. Does the facility have a spill control plan for the site?
2. Does the facility know what spill prevention methods and responses will be used?

CONTROL OF ALLOWABLE NON-STORM WATER DISCHARGES

1. What non-storm water discharges are present at the site?
2. How does the facility manage the non-storm water discharges?
3. How are allowable non-storm water discharges addressed in the storm water Pollution Prevention Plan?

4. What types of controls or practices are used to prevent pollution from non-storm water discharges?
5. What types of controls are used for discharges that have sediments?

Appendix Z – Infiltration Control Inspection Form

Infiltration Control Inspection Form

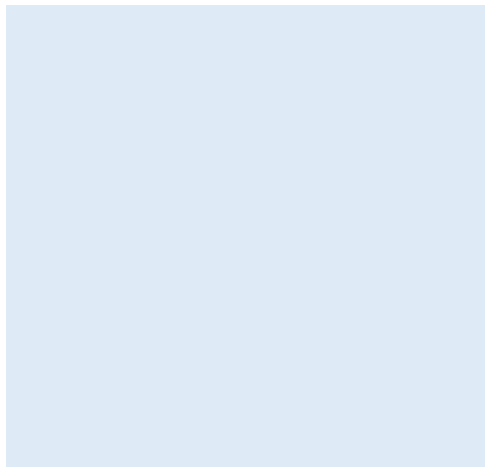

Question	Yes	No	NA	NE	Notes
Are there indications of any of the following?					
Erosion	<input type="checkbox"/>	<input type="checkbox"/>	<input type="checkbox"/>	<input type="checkbox"/>	
Bed Sinking	<input type="checkbox"/>	<input type="checkbox"/>	<input type="checkbox"/>	<input type="checkbox"/>	
Rodent holes or water piping	<input type="checkbox"/>	<input type="checkbox"/>	<input type="checkbox"/>	<input type="checkbox"/>	
Trash and debris	<input type="checkbox"/>	<input type="checkbox"/>	<input type="checkbox"/>	<input type="checkbox"/>	
Leaf accumulation	<input type="checkbox"/>	<input type="checkbox"/>	<input type="checkbox"/>	<input type="checkbox"/>	
Excess sediment build-up	<input type="checkbox"/>	<input type="checkbox"/>	<input type="checkbox"/>	<input type="checkbox"/>	
Control is poorly designed or poorly graded	<input type="checkbox"/>	<input type="checkbox"/>	<input type="checkbox"/>	<input type="checkbox"/>	
Other: _____	<input type="checkbox"/>	<input type="checkbox"/>	<input type="checkbox"/>	<input type="checkbox"/>	
Is there ponded water in the control?	<input type="checkbox"/>	<input type="checkbox"/>	<input type="checkbox"/>	<input type="checkbox"/>	
How many inlets are present? _____					
How many outlets are present? _____					
Are inlets set at an elevation that allows stormwater to flow into the control?	<input type="checkbox"/>	<input type="checkbox"/>	<input type="checkbox"/>	<input type="checkbox"/>	
Are outlets set at an elevation that allows stormwater to pond temporarily in the control and not discharge immediately?	<input type="checkbox"/>	<input type="checkbox"/>	<input type="checkbox"/>	<input type="checkbox"/>	
Are any of the inlet/outlets cracked or eroded?	<input type="checkbox"/>	<input type="checkbox"/>	<input type="checkbox"/>	<input type="checkbox"/>	
Are the inlet/outlets clear of sediment and debris and is water able to flow freely?	<input type="checkbox"/>	<input type="checkbox"/>	<input type="checkbox"/>	<input type="checkbox"/>	
Are the overflow and/or bypass structures clear of overgrown vegetation, excess sediment and debris?	<input type="checkbox"/>	<input type="checkbox"/>	<input type="checkbox"/>	<input type="checkbox"/>	
Are the pretreatment devices functioning as designed?	<input type="checkbox"/>	<input type="checkbox"/>	<input type="checkbox"/>	<input type="checkbox"/>	

Infiltration Control Inspection Form

Are there indications of any of the following?					
Dead plants	<input type="checkbox"/>	<input type="checkbox"/>	<input type="checkbox"/>	<input type="checkbox"/>	
Diseased plants	<input type="checkbox"/>	<input type="checkbox"/>	<input type="checkbox"/>	<input type="checkbox"/>	
Weeds	<input type="checkbox"/>	<input type="checkbox"/>	<input type="checkbox"/>	<input type="checkbox"/>	
Overgrown vegetation	<input type="checkbox"/>	<input type="checkbox"/>	<input type="checkbox"/>	<input type="checkbox"/>	
Is grass maintained at a height of 3-6 inches?	<input type="checkbox"/>	<input type="checkbox"/>	<input type="checkbox"/>	<input type="checkbox"/>	
Other: _____	<input type="checkbox"/>	<input type="checkbox"/>	<input type="checkbox"/>	<input type="checkbox"/>	
If a planting plan is available, are the plants as specified in the plan?	<input type="checkbox"/>	<input type="checkbox"/>	<input type="checkbox"/>	<input type="checkbox"/>	
Are there any bare spots that are without mulch cover or locations with mulch depth less than 2 inches?	<input type="checkbox"/>	<input type="checkbox"/>	<input type="checkbox"/>	<input type="checkbox"/>	
Does mulch appear to need to be replaced?	<input type="checkbox"/>	<input type="checkbox"/>	<input type="checkbox"/>	<input type="checkbox"/>	
Does the bed appear to be over mulched?	<input type="checkbox"/>	<input type="checkbox"/>	<input type="checkbox"/>	<input type="checkbox"/>	
Is there evidence of excess nutrients (e.g., algal mat) at or near the control?	<input type="checkbox"/>	<input type="checkbox"/>	<input type="checkbox"/>	<input type="checkbox"/>	
Is there evidence of excess pesticides (e.g., leaf scorching) applied?	<input type="checkbox"/>	<input type="checkbox"/>	<input type="checkbox"/>	<input type="checkbox"/>	
	<input type="checkbox"/>	<input type="checkbox"/>	<input type="checkbox"/>	<input type="checkbox"/>	
	<input type="checkbox"/>	<input type="checkbox"/>	<input type="checkbox"/>	<input type="checkbox"/>	
	<input type="checkbox"/>	<input type="checkbox"/>	<input type="checkbox"/>	<input type="checkbox"/>	
	<input type="checkbox"/>	<input type="checkbox"/>	<input type="checkbox"/>	<input type="checkbox"/>	
<p>Source: United States Environmental Protection Agency (EPA). 2015. Guidance for Inspecting and Maintaining Green Infrastructure Practices. 2014 Green Infrastructure Technical Assistance Program, City and County of Denver and Denver Urban Flood Control District, Denver, CO.</p> <p>State of Washington Department of Ecology. Example Permeable Pavements Inspection Form. Herrera Environmental Consultants. http://www.ecy.wa.gov/programs/wq/stormwater/municipal/LID/Resources/PermeablePavementInspectionForm.pdf</p>					

Appendix AA – Permeable Pavements Inspection Form

Permeable Pavements Inspection Form

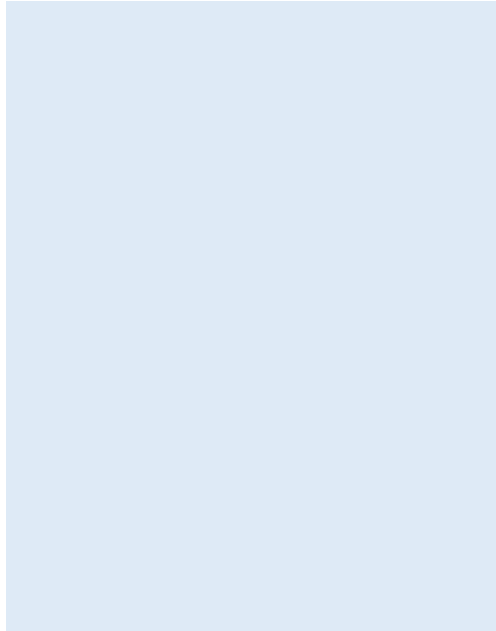

- | | |
|--|---|
| <input type="checkbox"/> Pervious Concrete | <input type="checkbox"/> Interlocking Concrete Pavers |
| <input type="checkbox"/> Porous Asphalt | <input type="checkbox"/> Other: _____ |
| <input type="checkbox"/> Grid Pavers | |

Question	Yes	No	NA	NE	Notes
Is there any evidence of excessive sediment on the surface of the permeable pavement?	<input type="checkbox"/>	<input type="checkbox"/>	<input type="checkbox"/>	<input type="checkbox"/>	
Are there indications of any of the following on the surface of the permeable pavement?					
Moss growth	<input type="checkbox"/>	<input type="checkbox"/>	<input type="checkbox"/>	<input type="checkbox"/>	
Cracks, tripping hazards, or concrete raveling	<input type="checkbox"/>	<input type="checkbox"/>	<input type="checkbox"/>	<input type="checkbox"/>	
Debris (trash, leaves, grass clippings, etc.)	<input type="checkbox"/>	<input type="checkbox"/>	<input type="checkbox"/>	<input type="checkbox"/>	
Surface settlement or depressions	<input type="checkbox"/>	<input type="checkbox"/>	<input type="checkbox"/>	<input type="checkbox"/>	
Other: _____	<input type="checkbox"/>	<input type="checkbox"/>	<input type="checkbox"/>	<input type="checkbox"/>	
Is there any evidence of any spills that have occurred on the permeable pavement? Describe	<input type="checkbox"/>	<input type="checkbox"/>	<input type="checkbox"/>	<input type="checkbox"/>	
If records are available, have they documented any past spills on the permeable pavement? Describe.	<input type="checkbox"/>	<input type="checkbox"/>	<input type="checkbox"/>	<input type="checkbox"/>	
Question	Yes	No	NA	NE	Notes
Is there ponded water on the surface of the permeable pavement? <i>If yes, describe the potential reasons for the ponded water (e.g. debris buildup, illicit connection, improperly graded/overloading of one section of the practice</i>	<input type="checkbox"/>	<input type="checkbox"/>	<input type="checkbox"/>	<input type="checkbox"/>	

Permeable Pavements Inspection Form

Permeable Pavements Inspection Form				
Are there indications of any of the following around the perimeter of the permeable pavement?				
Dead vegetation	<input type="checkbox"/>	<input type="checkbox"/>	<input type="checkbox"/>	<input type="checkbox"/>
Diseased vegetation	<input type="checkbox"/>	<input type="checkbox"/>	<input type="checkbox"/>	<input type="checkbox"/>
Overgrown vegetation	<input type="checkbox"/>	<input type="checkbox"/>	<input type="checkbox"/>	<input type="checkbox"/>
Is grass maintained at a height of 3-6 inches?	<input type="checkbox"/>	<input type="checkbox"/>	<input type="checkbox"/>	<input type="checkbox"/>
	<input type="checkbox"/>	<input type="checkbox"/>	<input type="checkbox"/>	<input type="checkbox"/>
	<input type="checkbox"/>	<input type="checkbox"/>	<input type="checkbox"/>	<input type="checkbox"/>
<p>Source: United States Environmental Protection Agency (EPA). 2015. Guidance for Inspecting and Maintaining Green Infrastructure Practices. 2014 Green Infrastructure Technical Assistance Program, City and County of Denver and Denver Urban Flood Control District, Denver, CO. State of Washington Department of Ecology. Example Bioretention Inspection Form. Herrera Environmental Consultants. http://www.ecy.wa.gov/programs/wq/stormwater/municipal/LID/Resources/BioretentionInspectionForm.pdf</p>				

Appendix AB – Rainwater Harvest Inspection Form

Rainwater Harvesting Inspection Form

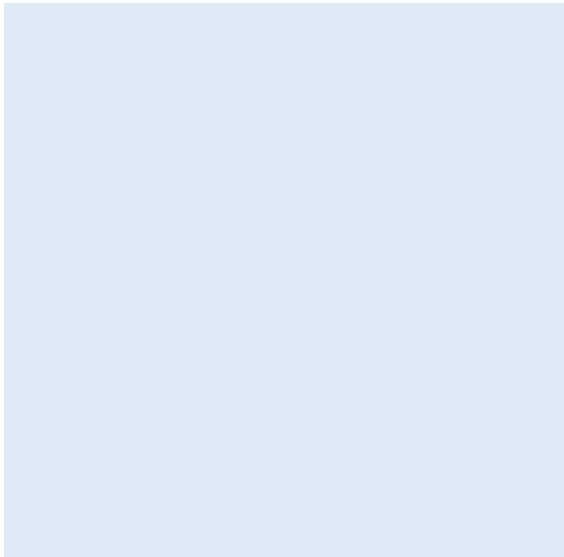

- Irrigation only
- Graywater and/or irrigation
- Potable and/or irrigation
- Other: _____

Question	Yes	No	NA	NE	Notes
Is the tank cracked, leaking, or need repairs?	<input type="checkbox"/>	<input type="checkbox"/>	<input type="checkbox"/>	<input type="checkbox"/>	
Is there evidence of sediment buildup in the tank?	<input type="checkbox"/>	<input type="checkbox"/>	<input type="checkbox"/>	<input type="checkbox"/>	
Are the pump and electrical system functioning properly?	<input type="checkbox"/>	<input type="checkbox"/>	<input type="checkbox"/>	<input type="checkbox"/>	
Other: _____	<input type="checkbox"/>	<input type="checkbox"/>	<input type="checkbox"/>	<input type="checkbox"/>	
Are there leaves or other debris in the gutters or pipes?	<input type="checkbox"/>	<input type="checkbox"/>	<input type="checkbox"/>	<input type="checkbox"/>	
Is there debris or pollutants in the prescreening devices or first flush diverters?	<input type="checkbox"/>	<input type="checkbox"/>	<input type="checkbox"/>	<input type="checkbox"/>	
Are mosquito screens missing or damaged?	<input type="checkbox"/>	<input type="checkbox"/>	<input type="checkbox"/>	<input type="checkbox"/>	
Is there an odor in the water?	<input type="checkbox"/>	<input type="checkbox"/>	<input type="checkbox"/>	<input type="checkbox"/>	
Are any of the valves/hoses clogged?	<input type="checkbox"/>	<input type="checkbox"/>	<input type="checkbox"/>	<input type="checkbox"/>	
How full is the tank?					
Question	Yes	No	NA	NE	Notes
Other: _____	<input type="checkbox"/>	<input type="checkbox"/>	<input type="checkbox"/>	<input type="checkbox"/>	
Is the overflow device in need of repair?	<input type="checkbox"/>	<input type="checkbox"/>	<input type="checkbox"/>	<input type="checkbox"/>	
Is there evidence of erosion at the outlet?	<input type="checkbox"/>	<input type="checkbox"/>	<input type="checkbox"/>	<input type="checkbox"/>	
Is there evidence of debris or sediment in the overflow?	<input type="checkbox"/>	<input type="checkbox"/>	<input type="checkbox"/>	<input type="checkbox"/>	
Other: _____	<input type="checkbox"/>	<input type="checkbox"/>	<input type="checkbox"/>	<input type="checkbox"/>	

Rainwater Harvesting Inspection Form

How is the harvested rainwater used?					
How often is the harvested rainwater used?					
What is the estimated available current storage capacity (% of system that is currently empty)?					
	<input type="checkbox"/>	<input type="checkbox"/>	<input type="checkbox"/>	<input type="checkbox"/>	
	<input type="checkbox"/>	<input type="checkbox"/>	<input type="checkbox"/>	<input type="checkbox"/>	
Source: United States Environmental Protection Agency (EPA). 2015. Guidance for Inspecting and Maintaining Green Infrastructure Practices. 2014 Green Infrastructure Technical Assistance Program, City and County of Denver and Denver Urban Flood Control District, Denver, CO. State of Washington Department of Ecology. Example Permeable Pavements Inspection Form. Herrera Environmental Consultants. http://www.ecy.wa.gov/programs/wq/stormwater/municipal/LID/Resources/PermeablePavementInspectionForm.pdf					

Appendix AC – Green Roof Inspection Form

Green Roof Inspection Form

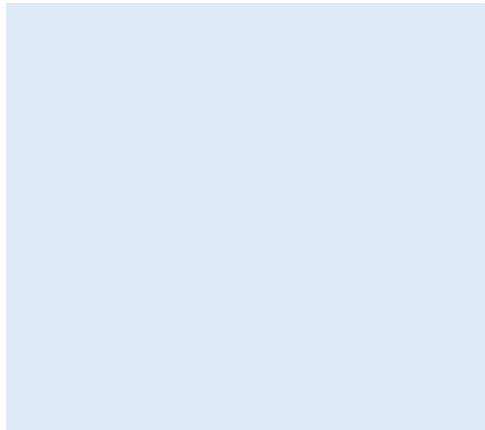

Question	Yes	No	NA	NE	Notes
Are overflow drains, drain boxes, eaves, and scuppers blocked, damaged or have accumulated organic matter deposits?	<input type="checkbox"/>	<input type="checkbox"/>	<input type="checkbox"/>	<input type="checkbox"/>	
Is there evidence of any leaks or cracks in the membrane?	<input type="checkbox"/>	<input type="checkbox"/>	<input type="checkbox"/>	<input type="checkbox"/>	
Is the flashing or caulking in need of repair?	<input type="checkbox"/>	<input type="checkbox"/>	<input type="checkbox"/>	<input type="checkbox"/>	
Is there standing water on the roof (at least 24 hours after a rain event)?	<input type="checkbox"/>	<input type="checkbox"/>	<input type="checkbox"/>	<input type="checkbox"/>	
Is there debris or sediment accumulation on the roof?	<input type="checkbox"/>	<input type="checkbox"/>	<input type="checkbox"/>	<input type="checkbox"/>	
Is there evidence of root penetration (e.g., water damage on the inside of the roof)?	<input type="checkbox"/>	<input type="checkbox"/>	<input type="checkbox"/>	<input type="checkbox"/>	
Other: _____	<input type="checkbox"/>	<input type="checkbox"/>	<input type="checkbox"/>	<input type="checkbox"/>	
Are there dead or diseased plants?	<input type="checkbox"/>	<input type="checkbox"/>	<input type="checkbox"/>	<input type="checkbox"/>	
Are there weeds, unwanted moss, invasive plants, or pests?	<input type="checkbox"/>	<input type="checkbox"/>	<input type="checkbox"/>	<input type="checkbox"/>	
Is there erosion or loss of media on the roof?	<input type="checkbox"/>	<input type="checkbox"/>	<input type="checkbox"/>	<input type="checkbox"/>	
Question	Yes	No	NA	NE	Notes
Other: _____	<input type="checkbox"/>	<input type="checkbox"/>	<input type="checkbox"/>	<input type="checkbox"/>	
	<input type="checkbox"/>	<input type="checkbox"/>	<input type="checkbox"/>	<input type="checkbox"/>	
	<input type="checkbox"/>	<input type="checkbox"/>	<input type="checkbox"/>	<input type="checkbox"/>	

Green Roof Inspection Form

<p>Source: United States Environmental Protection Agency (EPA). 2015. Guidance for Inspecting and Maintaining Green Infrastructure Practices. 2014 Green Infrastructure Technical Assistance Program, City and County of Denver and Denver Urban Flood Control District, Denver, CO. State of Washington Department of Ecology. Example Permeable Pavements Inspection Form. Herrera Environmental Consultants. http://www.ecy.wa.gov/programs/wq/stormwater/municipal/LID/Resources/PermeablePavementInspectionForm.pdf</p>

Appendix AD – Animal Industry Overview

OVERVIEW OF LIVESTOCK AND POULTRY INDUSTRY PRACTICES

A. Overview of Livestock Agriculture

The poultry, swine, dairy, and beef industries constitute the principal sectors of U.S. animal agriculture. The vast majority of AFOs that are by definition CAFOs and subject to NPDES permit requirements are in one of these four sectors. A limited number of veal calf, sheep, duck, and horse AFOs are also CAFOs subject to NPDES permit requirements. In this section, we will provide a general overview of the principal sectors, including descriptions of production and waste management practices, with the objective of providing the CAFO inspector with a general understanding of the nature of each of these industries. The production and waste management practices described in this section are those most likely to be encountered at large CAFOs. It is not intended to describe all the possible practices and combinations of practices that may be encountered, since that number is sizable. Thus, CAFO inspectors must expect to encounter operations and practices that are atypical and should seek additional guidance when necessary. The CAFO inspector should feel comfortable asking an operator to clarify or describe an operation, practice, or piece of equipment.

A.1.0 Poultry

The poultry sector has three principal segments: broilers, laying hens, and turkeys. In each of these segments, production and waste management practices are probably more uniform than in the swine, dairy, and beef industries.

A.1.1 Broilers

Broiler refers to a meat-type chicken typically slaughtered at about 7 weeks of age at a live weight of about 5 pounds. This size of bird is the principal product of the broiler sector within the poultry industry. However, there is also some production of younger birds, identified as squab broilers, Cornish game hens or Rock-Cornish crosses, as well as older birds known as roasters. Squab broilers are typically slaughtered at about 4 weeks of age at a live weight of about 2.25 to 2.5 pounds. Roasters are generally slaughtered at about 8 to 10 weeks of age at a live weight of 6 to 8 pounds. Typically, 5 to 6 flocks of broiler chickens will be produced annually. Because squab broilers and roaster broilers differ in the length of their grow-out cycle (the time to reach slaughter weight), more flocks of squab broilers and fewer flocks of roasters are produced annually. Broilers are typically fed corn-soybean-based diets, which may also include various cereal grains and a variety of other ingredients. Grain sorghum may be substituted for corn.

Broiler-type chicken production tends to be vertically integrated with contracts between grower and integrator. The integrator supplies the birds, the feed, and any pharmaceuticals required. The grower supplies the production facility and labor. With vertical integration, the integrator retains ownership of the live birds, but disposal of the manure and dead birds generated is the responsibility of the grower.

A.1.1.1 Broiler Confinement Facilities

Broiler chicken production typically occurs in either totally or partially enclosed structures. Partially enclosed structures have partially open side walls that can be covered by curtains during periods of cold weather. A combination of natural and mechanical ventilation removes heat and moisture from partially enclosed structures. Mechanical ventilation is used with totally enclosed structures, known as controlled environment housing, or, more commonly, tunnel-type housing.

Broiler houses are normally divided into three chambers. One chamber, referred to as the brood chamber, is used to house day-old chicks (biddies). Until the age of about 2 to 3 weeks, chickens are unable to maintain a constant body temperature and require supplemental heat. Thus, brood chambers are heated at the beginning of the grow-out cycle. As the birds grow and heating requirements are reduced, the second and third chambers are opened sequentially to provide more floor space per bird. In cold weather, broiler houses are heated throughout the grow-out cycle to maximize feed conversion efficiency and the rate of weight gain.

A.1.1.2 Broiler Manure Management

All broiler-type chickens are raised unconfined within the production facility on litter, which has the primary function of absorbing the moisture in the excreted manure. Litter materials vary depending on availability and cost, but they are usually sawdust, wood shavings, peanut hulls, or rice hulls.

Normally, litter and accumulated manure, also commonly called litter, are only removed from the entire house every 1 to 3 years after 5 to 15 or more flocks of birds have been produced. The industry refers to this as a total clean-out. When total clean-outs do not occur on a yearly basis, litter and accumulated manure may be removed annually from the brood chamber. This is known as a brood chamber clean-out. Following both total and brood chamber clean-outs, the litter is replaced.

During each production or grow-out cycle, a material known as crust or cake will form along feeder and water lines. In these areas, the amount of manure excreted is higher than in other areas of the house, and moisture from the manure and waterers tends to bind the mixture of litter and manure together, forming large clumps. As watering systems have improved, the amount of crust formed during each grow-out cycle has decreased. Crust is usually removed after every flock of birds produced. The remaining litter and accumulated manure may be covered (top dressed) with a relatively thin layer of new litter if the amount of crust removed is high. Some poultry operations may use in-house windrowing to treat the cake following each flock, and these poultry operations may only remove cake after several flocks.

Historically, total and brood chamber clean-out litter and crust have been either applied to crop land immediately, if crop production activities permitted, or stored in uncovered piles until land was available for disposal. Over the last several years, structures have occasionally been used to store crust. However, construction cost has generally precluded the use of such storage structures for litter generated by total and brood chamber cleanouts some producers use. The timing of these clean-outs has shifted somewhat from late fall and early winter, as the industry

has become more sensitive to the impact on water quality of litter stored in uncovered piles. It is generally acceptable for litter to be stored under a tarp as long as rain and runoff is diverted around the pile in lieu of constructing covered storage facilities. Temporary short-term stacking of litter (i.e., 2 weeks) on or near a field where it will be applied may also be an acceptable handling method provided manure is applied in a timely manner. For example, Maryland Agriculture Extension allows litter stacked at the field for no longer than two weeks.

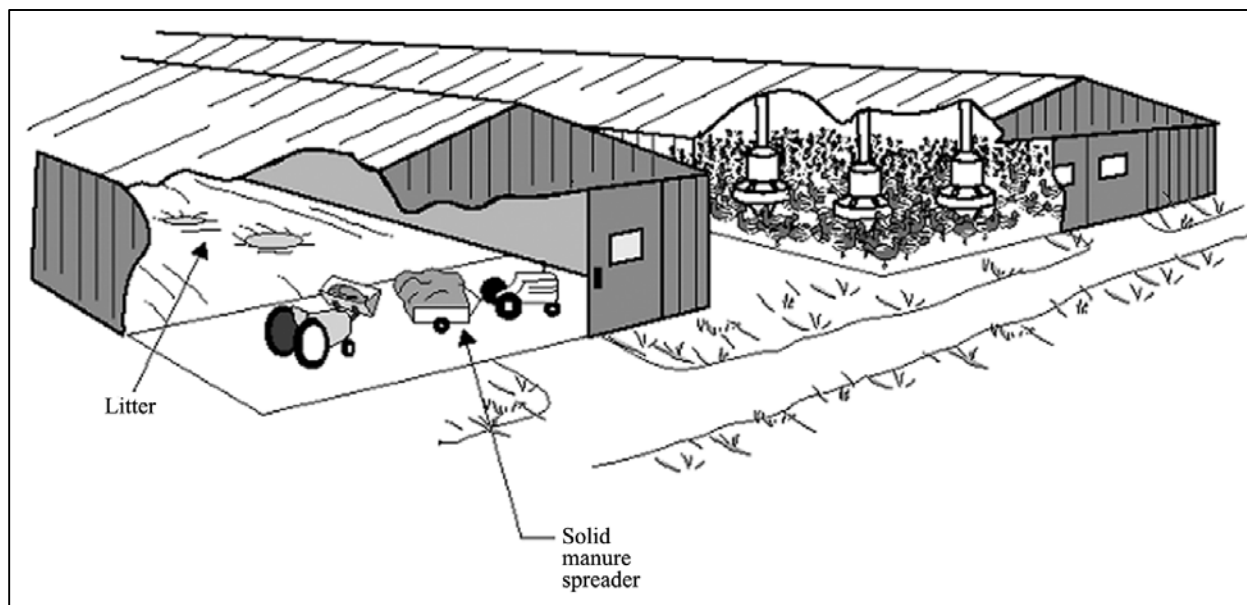

Litter System for Broilers and Turkeys (Source: USDA Agricultural Waste Management Field Handbook)

A.1.1.3 Broiler Mortality Management

With broilers, the highest rate of mortality normally occurs during the first 2 weeks of the grow-out cycle, but continues at a lesser rate throughout the rest of the cycle. Typically, about 4.5 to 5 percent of the birds housed will die during the grow-out cycle although the typical mortality for roasters is about 8 percent. To prevent the possible spread of disease, dead birds must be removed at least daily, if not more frequently. As mentioned earlier, the disposal of dead birds is the responsibility of the grower. Several options are available for dead bird disposal.

Composting is one of the more desirable approaches and has been heavily promoted by the industry. As an alternative to composting or burial, at least one integrator has been distributing freezers to preserve carcasses for subsequent disposal by rendering.

Catastrophic losses of broiler chickens also occur, especially during periods of extremely hot weather but also during weather events such as hurricanes, tornadoes, and snow or ice storms. Catastrophic losses of broilers from excessive heat are usually more severe with older birds. Several options are available for disposal of catastrophic losses, with burial being the most common practice. (Note that burial is prohibited or highly regulated in some states.) Large-scale composting is another, and probably more desirable, option from a water quality perspective.

A.1.2 Laying Hens

A laying hen is a chicken maintained for table egg production. The production cycle begins with the placement of young birds, normally 14 to 16 weeks of age, in the production facility and ends 11 to 12 months later when the birds are removed. These birds, known as spent hens, may be slaughtered for meat for human or pet foods or disposed of by rendering. More than three-fourths of layer farms molt their birds followed by a second period of egg production. Routine molting by withholding or restricting feed is the most common method. Placement and removal of birds are on an “all in–all out” basis. Typically, laying hens are also fed corn- and soybean-based diets, which may also include various cereal grains such as wheat and barley and a variety of other ingredients.

Although the table egg segment of the poultry sector is less vertically integrated than the broiler sector, vertical integration is becoming more common. However, the egg producer is typically responsible for both manure and dead bird disposal if under contract with an integrator or an independent operator. Slightly more than 10 percent of all layer farms have pullet raising facilities on the farm. Pullets are young chickens, usually less than 20 weeks of age, often raised for the purpose of egg production. Traditional pullet houses are similar in construction to broiler houses.

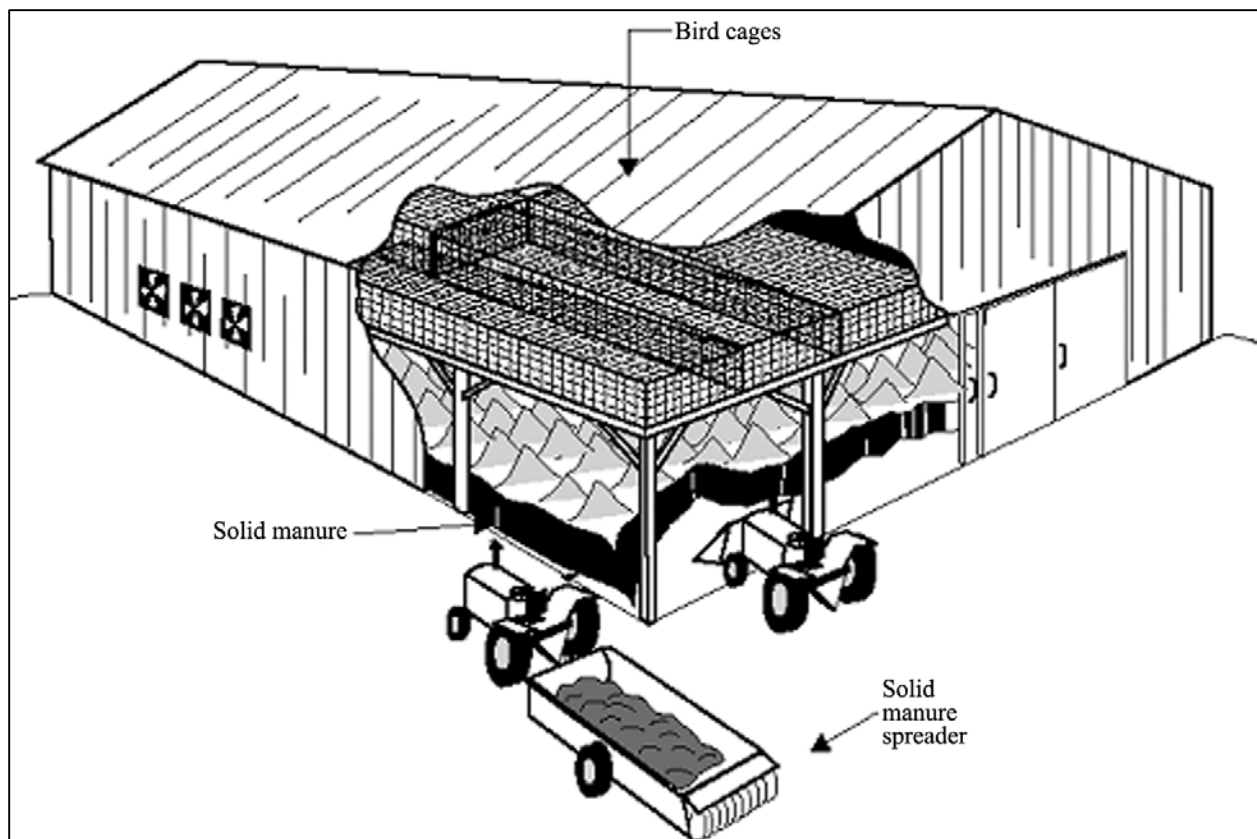

Traditional “High-Rise” House for Layers (Source: USDA Agricultural Waste Management Field Handbook)

A.1.2.1 Laying Hens Confinement Facilities

Most egg production occurs in totally enclosed facilities with mechanical ventilation for temperature control and moisture removal, but partially open-sided houses may be encountered in warm climates. Unlike broilers, laying hens are usually confined in cages and no litter or bedding material is used. However, modern changes in the layer industry are resulting in more diverse housing arrangements, including larger cages, designs with “enriched housing” where hens can freely move within a large cage from laying areas to perches to scratching areas, and designs that allow hens to fly between the floor of the barn to multiple levels in the building for perching and laying.

A.1.2.2 Laying Hens Manure Management

Manure produced by laying hens is handled both as a liquid or slurry and as a solid, with handling as a solid being much more common. Liquid or slurry systems are more common in older production facilities. When laying hen manure is handled as a liquid or slurry, flushing or scraping is used to remove manure from the production facility. With scraping systems, a tank or an earthen structure is often used for storage if the manure is not applied directly to crop land, while flush systems use an anaerobic lagoon for stabilization and storage. Typically, the lagoon is the source of the water used for flushing, although fresh water may be used in rare instances.

Traditionally, to handle laying hen manure as a solid, a two-story production facility, known as a high-rise house, is used. In a high-rise house, the caged hens are located on the second floor of the building, with the manure dropping to the first floor where it is dried and stored. The primary factor responsible for drying is biological heat production in the accumulating mass of manure that causes evaporation of the moisture in the manure. Ventilation systems for high-rise houses are designed to move air from intakes along the eaves of the house roof down through the caged hens and over the mass of accumulating manure before exiting the house, thus removing the moisture evaporated from the manure. Critical to the successful operation of a high-rise house is the avoidance of leaks in the bird watering system and proper exterior grading to direct surface runoff away from the building. Because of the microbial activity in the accumulating mass of manure, which is responsible for the heat generated and the evaporation of manure moisture, stabilization occurs and storage for 1 or more years is provided. Typically, manure is removed from high-rise houses yearly between flocks of hens, but storage for 2 to 3 years is possible.

Modern housing for laying hens, and the type that is currently most often built, is a “manure-belt” system where the manure from caged hens drops onto conveyor belts that move through the house and transport the manure into a separate drying unit or storage structure. The manure may be dried for easier storage or transportation. This housing design and manure management system is beneficial for the health of the birds, as the air quality is improved by the removal of the litter.

The majority of eggs marketed commercially in the U.S. are washed using automatic washers. Cleaning compounds such as sodium carbonate, sodium metasilicate, or trisodium phosphate, together with small amounts of other additives, are commonly used in these systems. Wash water is contaminated with shell, egg solids, dirt, manure, and bacteria washed from the egg

surface into the recycled water. Eggs may be washed either on farm or off farm. Over three-fourths of layer farms process eggs on farm, though one-third of the largest farms are likely to wash eggs off farm. Operations that wash their eggs on farm may do so in-line or off-line. Larger operations commonly collect and store egg wash water on-site in large tanks or lagoons for treatment and storage.

A.1.2.3 Laying Hens Mortality Management

It can be expected that about 1 percent of the started pullets housed will die each month through the laying cycle. To prevent the possible spread of disease, dead birds should be removed from cages daily, if not more frequently. As mentioned earlier, disposal of dead birds is the responsibility of the grower. Several options are available for dead bird disposal. Of these options, composting is one of the more desirable approaches.

Catastrophic losses of laying hens also occur. Loss of power and mechanical ventilation during periods of extremely hot weather is the most common cause of loss. Weather events such as hurricanes and tornadoes can also cause catastrophic losses. Several options are available for the disposal of catastrophic losses, with burial being the most common. (Note that burial is prohibited or highly regulated in some states.) Large-scale composting is another, and probably more desirable, option from a water quality perspective.

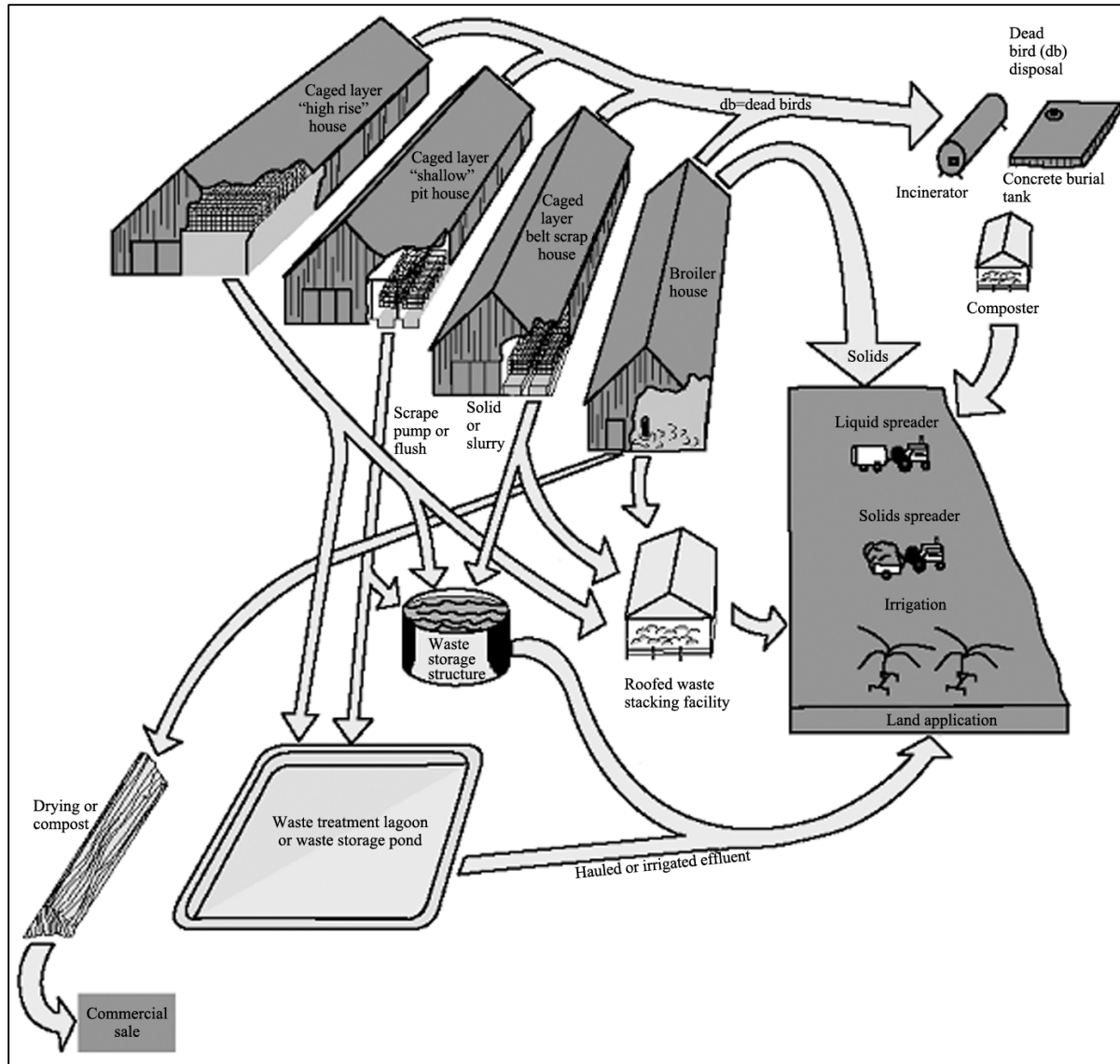

Poultry Waste Handling (Source: USDA Agricultural Waste Management Field Handbook. Note that burial is prohibited or highly regulated in some states.)

A.1.3 Turkeys

Turkey production is similar to broiler chicken production in many respects. The grow-out period for female or hen turkeys is usually about 14 to 16 weeks, resulting in a live weight at slaughter of between 13 and 20 pounds. However, the usual grow-out period for toms or male turkeys is longer, ranging from 17 to 21 weeks, resulting in a live weight at slaughter of between 30 and 37 pounds. Typically, two flocks of turkeys are produced annually because of the longer grow-out cycle and the somewhat seasonal demand for turkey. Turkeys are primarily fed corn- and soybean-based diets, which may also include various cereal grains and a variety of other ingredients.

Vertical integration is also extensive in the turkey sector of the poultry industry, with the same distribution of responsibilities between the integrator and grower as in the broiler sector.

A.1.3.1 Turkey Confinement Facilities

Like broiler production, essentially all turkey production occurs in partially or totally enclosed facilities that are divided into two or three chambers. Initially, only one chamber, also known as the brood chamber, is used; this is the area where the newly hatched turkeys, known as poults are placed. Like broiler chicks, poults are unable to maintain a constant body temperature until about 6 to 8 weeks of age and thus require supplemental heat. Brood chambers for turkeys, therefore, are also heated at the beginning of the grow-out cycle. As with broiler chickens, the second or the second and third chambers are opened to provide more floor space per bird as the birds grow. In cold weather, some heat may be provided throughout the grow-out cycle.

Some turkey producers use separate brood and growing houses and move the birds from the brooding house to the growing house after about 6 to 8 weeks. Another production practice is to use the brood chamber in a house exclusively for brooding and use the remainder of the house for grow-out after the birds reach the age of 6 to 8 weeks. These management systems are known as two-age management systems. Such systems produce more flocks each year than single-age farms.

A.1.3.2 Turkey Manure Management

Turkeys are raised unconfined in the production facility on litter, typically sawdust or wood shavings. Total clean-out of brood chambers and brood houses after each flock is common, as is total clean-out of growing chambers or houses annually. Crust removal between flocks followed by top dressing with new litter also occurs in the production of turkeys.

In the turkey sector, the use of litter sheds to store crust and total clean-outs from brood chambers or brood houses is also emerging. When land is not available for disposal, storage of these materials in uncovered piles is common.

A.1.3.3 Turkey Mortality Management

Typically, about 5 to 6 percent of hens and 9 to 12 percent of toms will die during the grow-out cycle, with the highest rate of loss occurring during the initial weeks. As with broilers and laying hens, dead birds should be removed daily, if not more frequently, with dead bird disposal being the responsibility of the grower. Again, several options for dead bird disposal are available; composting is one of the more desirable approaches from a water quality perspective.

Catastrophic losses of turkeys occur during periods of extremely hot weather, but they may also be due to weather events such as hurricanes, tornadoes, and snow or ice storms. Older turkeys, like older broilers, are more susceptible to catastrophic losses during periods of extremely hot weather. Several options are available for disposal of catastrophic losses, with burial being the most common practice. (Note that burial is prohibited or highly regulated in some states.) Large-scale composting is another, and probably more desirable, option from a water quality perspective.

A.2.0 Swine

The production cycle for hogs has three phases. It begins with gestation and farrowing (birth). After farrowing, the newly born pigs or piglets are normally nursed for a period of just under 3 to 4 weeks until they reach a weight of 10 to 15 pounds. The average pig weaning age is 17 days, but may approach 4 weeks at smaller operations. Over 97 percent of large farms wean at less than 21 days. The production phase after weaning is known as the nursery phase where pigs are fed a starter ration until they reach a weight of 40 to 60 pounds. At this point, they are 8 to 10 weeks of age. The average age for leaving the nursery is 63 days. The third phase of swine production is the growing-finishing phase in which the gilts (young females) and young castrated boars (males) not retained for breeding are fed until they reach a market weight, typically between 240 and 280 pounds. In this phase of swine production, hogs are fed a growing ration until they reach 120 pounds in weight, which is then followed by a finishing ration. Growing-finishing usually takes between 15 and 18 weeks. Hogs are normally slaughtered at about 26 weeks of age. After weaning, swine are typically fed a corn- and soybean-meal based diet which may include small grains such as wheat and barley and other ingredients until slaughtered.

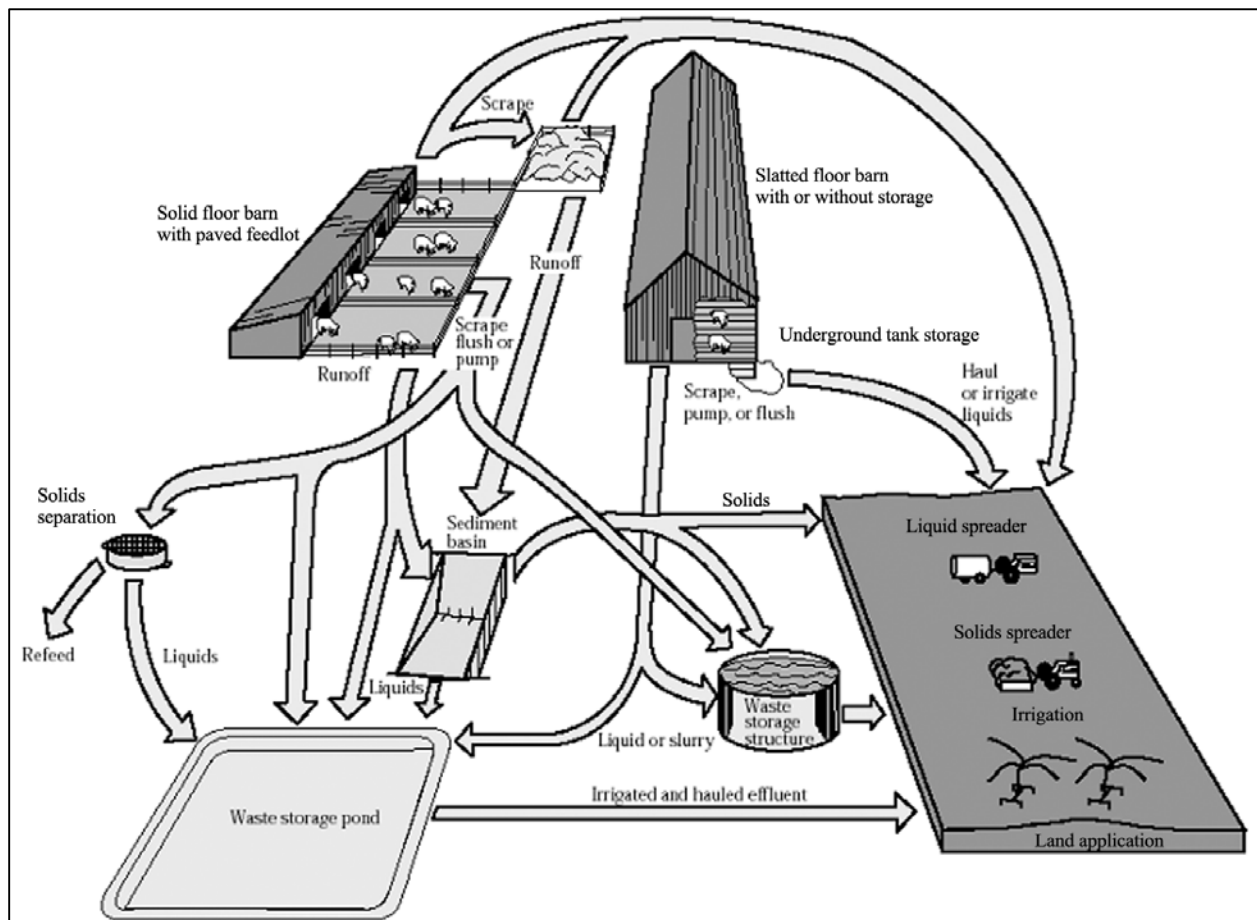

Swine Waste Handling (Source: USDA Agricultural Waste Management Field Handbook. Note that burial is prohibited or highly regulated in some states.)

Swine operations can be of several types. The most common is the farrow-to-finish operation that encompasses all three phases of swine production. Other operations specialize in either feeder pig production or the growing-finishing phase of swine production. Although not common, specialization in either the gestation-farrowing or the nursery phase of the swine production cycle may also occur. Larger grow-finish operations are more likely to obtain feeder pigs from off-site sources. Vertical integration is becoming more common in the swine industry.

A.2.1 Swine Confinement Facilities

The swine industry uses confinement systems ranging from pasture without and with shelters to total confinement, where pigs are confined in pens or stalls. Open paved or unpaved lots with access to a building or huts for shelter are also used, but larger operations will use total confinement 99 percent of the time because of higher feed conversion efficiency and weight gain as well as lower labor costs.

Total confinement facilities for swine are similar in many respects to facilities used for broiler production, except that the pigs are confined in pens. These pens may be totally enclosed or they may have partially open side walls that can be closed with curtains during cold weather. Totally enclosed facilities are mechanically ventilated, whereas facilities with partially open side walls use a combination of natural and mechanical ventilation.

A.2.2 Swine Manure Management

Four principal types of waste management systems are used with total confinement housing in the swine industry: deep pit, pull plug pit, pit recharge, and flush systems. The deep pit, pull plug pit, and pit recharge systems are used with slatted floors, whereas flush systems can be used with either solid or slatted floors.

Deep pits are normally sized to collect and store 6 to 8 months of waste. When they are emptied, the accumulated manure may be disposed of directly by land application or transferred to either storage tanks or earthen storage ponds for later disposal by land application.

Pull plug pit systems use relatively shallow pits to collect manure. These pits are usually drained to a storage tank or an earthen storage pond every 1 to 2 weeks.

Pit recharge systems also use relatively shallow pits that are drained periodically to an anaerobic lagoon. Although the frequency of draining varies, between 4 and 7 days is standard. After the pit is drained, the empty pit is partially refilled with supernatant from the anaerobic lagoon, which differentiates this system from the pull plug pit system—hence, the name pit recharge.

Flush systems use either fresh water or, more commonly, supernatant from an anaerobic lagoon to transport accumulated wastes to that lagoon daily or more frequently. Because pigs will defecate as far away from their feeding and resting areas as possible, facilities with solid floors will usually have a flush channel formed in that area. Facilities with slatted floors usually form a series of parallel flush channels in the shallow pit under the slatted floor.

A.2.3 Swine Mortality Management

In swine production, the highest rate of mortality occurs in young piglets within 3 to 4 days of birth. Typically, about 10 to 12 percent of piglets will die before weaning. Typically, 2 to 4 percent of the pigs die during the nursery stage and during the grow-finish stage. Several approaches are used for dead pig disposal, with burial being the most common. Composting and incineration are also used but primarily for piglets. Although older pigs can be disposed of by composting, disposal through rendering is the more common alternative to burial.

Catastrophic losses of swine also occur but they are primarily due to extreme weather events such as hurricanes, tornadoes, and the like. Heat losses are less common in the swine industry, because pigs, unlike birds, possess sweat glands that help to regulate body temperature. The primary effects of periods of high temperatures on swine production are reduced feed conversion efficiency and a reduced rate of weight gain. Burial is a practical option for the disposal of large numbers of swine carcasses, although rendering could be feasible as well. (Note that burial is prohibited or highly regulated in some states.)

A.3.0 Dairy Cattle

The production cycle in the dairy industry begins with the birth of a calf, which causes the onset of lactation or milk production. A period of between 10 and 12 months of milk production is normally followed by a 2-month dry period to allow for physiological preparation for calving. At the time that milking is normally stopped, a cow will be in the seventh month of a 9-month pregnancy. Thus, a mature dairy cow produces a calf every 12 to 14 months. This frequency of calf production is necessary to maintain a cost-effective level of milk production. Average U.S. milk production is about 17,000 pounds per cow per year. However, herds with averages of 22,000 to 24,000 pounds of milk per cow per year or higher are not unusual.

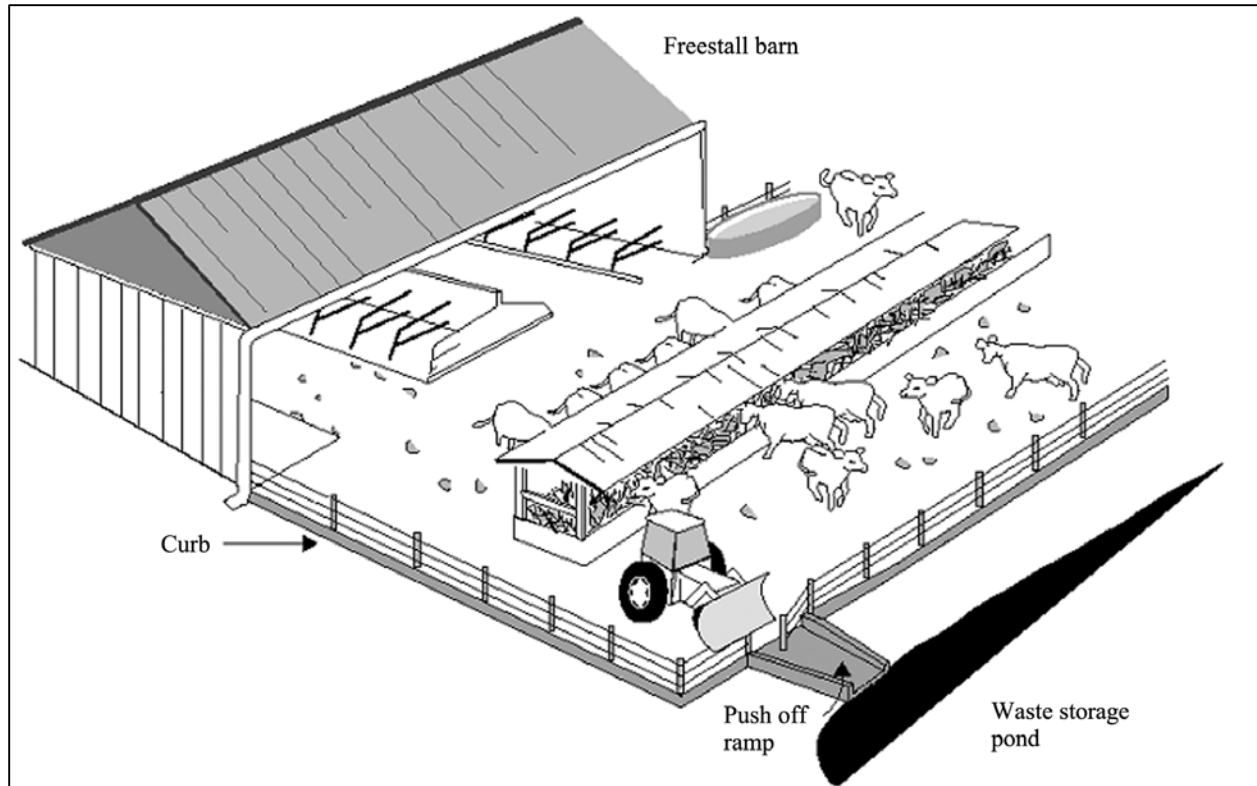

Dairy Confinement Area (Source: USDA Agricultural Waste Management Field Handbook)

About 25 percent of a milking herd is typically replaced each year, but replacement levels can be as high as 40 percent for intensively managed herds. Mature cows are replaced or culled for a variety of reasons, including low milk production and diseases such as mastitis, which is an infection of the udder. Lameness, injury, belligerence, and reproductive problems are also reasons for culling. Nearly all culled dairy cows are slaughtered for beef used in processed foods or in higher quality pet foods.

Roughly 50 percent of the calves produced by dairy cows are bulls unless the livestock producer is using sexed semen (to produce more heifer calves). Because most dairy cows are bred using artificial insemination, the industry has little demand for bull calves. Although some dairy farms will have one or more breeding age bulls for cows that will not conceive by artificial insemination, most bull calves are sold for either veal or beef production.

Because of the continuing need for replacement cows, approximately 50 percent of the female calves born are raised as replacements. Those animals selected as replacements are usually progeny of cows with a record of high milk production. Female calves not raised as replacements are also sold for either veal or beef production.

Female calves retained as replacements are either raised on-site or transferred off-site to an operation that specializes in producing dairy cattle replacements. In this second scenario, the calves may be sold to the replacement operation with the same or other animals purchased back at a later date or raised under contract. In the dairy industry, both male and female animals are called calves up to an age of about 5 months. From the age of 6 to 24 months,

females are called heifers, with first calving typically occurring at 24 months of age. Replacements raised off-site may be purchased or returned either as unbred or open (not pregnant) heifers at an age of about 13 months or as bred heifers at an age usually of 22 to 23 months. Three groups of animals will be present on dairy farms that raise replacements on-site: calves, heifers, and mature lactating and dry (mature nonlactating) cows. Usually, the total number of calves and heifers present will be between 50 and 60 percent of the size of the milking herd.

Lactating dairy cows are milked at least twice per day, but milking three times a day has become more common, especially with higher milk producing herds. With the exception of young calves until weaning, dairy cattle are fed a roughage-based diet or ration composed primarily of silages and hays supplemented with feed grains and by-product feedstuffs to ensure adequate levels of energy, protein, minerals, and other essential nutrients. Citrus pulp, beet pulp, meat and bone meal, and cottonseed meal are examples of by-product feedstuffs. Young calves are initially fed colostrum, which is the milk produced during the first 4 to 5 days after calving that cannot be marketed, and then a milk replacer until weaning and a complete shift to a roughage-based ration.

A.3.1 Dairy Confinement Facilities

The free-stall barn is the predominant type of housing system used on larger dairy farms for lactating cows. In a free-stall barn, cows are commonly grouped by stage of lactation in large pens with free access to feed bunks, waterers, and stalls for resting. The standard free-stall barn design has a feed alley in the center of the barn separating the two feed bunks on each side. Each side of the barn has an alley between the feed bunk and the first row of free-stalls and an alley that extends between the first row of free-stalls facing the feed bunk and a second row of free-stalls facing the side wall of the structure. These are the primary areas of manure accumulation, with little manure defecated in the free-stalls. There may or may not be access to an outside dry lot for exercise or to a pasture for exercise and grazing. In warmer climates, cows may simply be confined in a dry lot with unlimited access to feed bunks, waters, and usually an open structure to provide shade.

With both free-stall barns and dry lot production facilities, milking occurs in a specialized facility known as a milking center. A milking center has three components: a holding area where cows are held prior to milking, a milking parlor where the cows are milked, and an area where milk is stored in refrigerated tanks, known as bulk tanks, until picked up for processing and the milking equipment is cleaned. Holding areas may be either enclosed or open areas depending largely on climate.

There are two predominant housing systems for young unweaned calves: individual pens in an enclosed building and hutches that tend to reduce disease problems. Hutches are small, lightweight structures, typically of fiberglass or plywood construction, that can be easily moved. Individual hutches, sized for one calf, are located in a small fenced area to provide shelter from inclement weather as well as access to fresh air and sunlight. Hutches are routinely relocated to reduce disease transmission. Older calves are either housed in pens as groups in a totally or partially enclosed building or in portable super hutches in a small fenced area.

Heifers are most commonly raised on dry lots with or without shelter, but may also be raised on pasture or in dedicated free-stall barns. Dry cows may be removed from the milking herd to dry lots, pasture, or dedicated free-stall barns.

A.3.2 Dairy Manure Management

Manure is usually removed from free-stall barn alleys at least twice daily, and often more frequently, by either scraping or flushing. A mechanical scraper or a tractor-mounted blade is used to move the manure to a collection pit at one end of the barn. From the collection pit, manure is transferred by pump or gravity to a tank or an earthen pond for storage until disposal by land application. Milking center wastewater may be added to these collection pits to facilitate pumping or gravity flow, since scraped dairy cow manure is quite viscous with a total solids content of around 12 to 13 percent. With scrape systems, other options for managing milking center wastewater, which is generated when the milking parlor and milking equipment are cleaned, are transfer directly into the manure storage structure or transfer to a dedicated lagoon.

Flush systems are the most common in warmer climates where flush water is unlikely to freeze. Flush systems for dairy cattle operate like flush systems for swine and laying hens, with the manure and flush water discharged into an anaerobic lagoon, which is normally the source of the water used for flushing. With flushing systems, milking center wastewater usually is transferred to the lagoon used for manure stabilization and storage.

The type of manure management used by a particular dairy is often a function of the bedding choice for the lactating cows. Common bedding materials include sand, sawdust, rubber mattresses, and water beds. As sand is very abrasive on manure pumps, flush systems are rarely used when sand is the chosen bedding material.

When sand bedding is used, it accumulates in the waste storage facility and must be eventually mechanically removed every several years or else the volume of available manure storage becomes greatly diminished. Some larger dairies will install sand removal systems, typically either a sand lane (gravity removal of sand with flush systems) or a mechanical sand separation system consisting of a cyclone filter or screw auger. Both systems require a high volume of flush water which is usually secured from the waste storage pond.

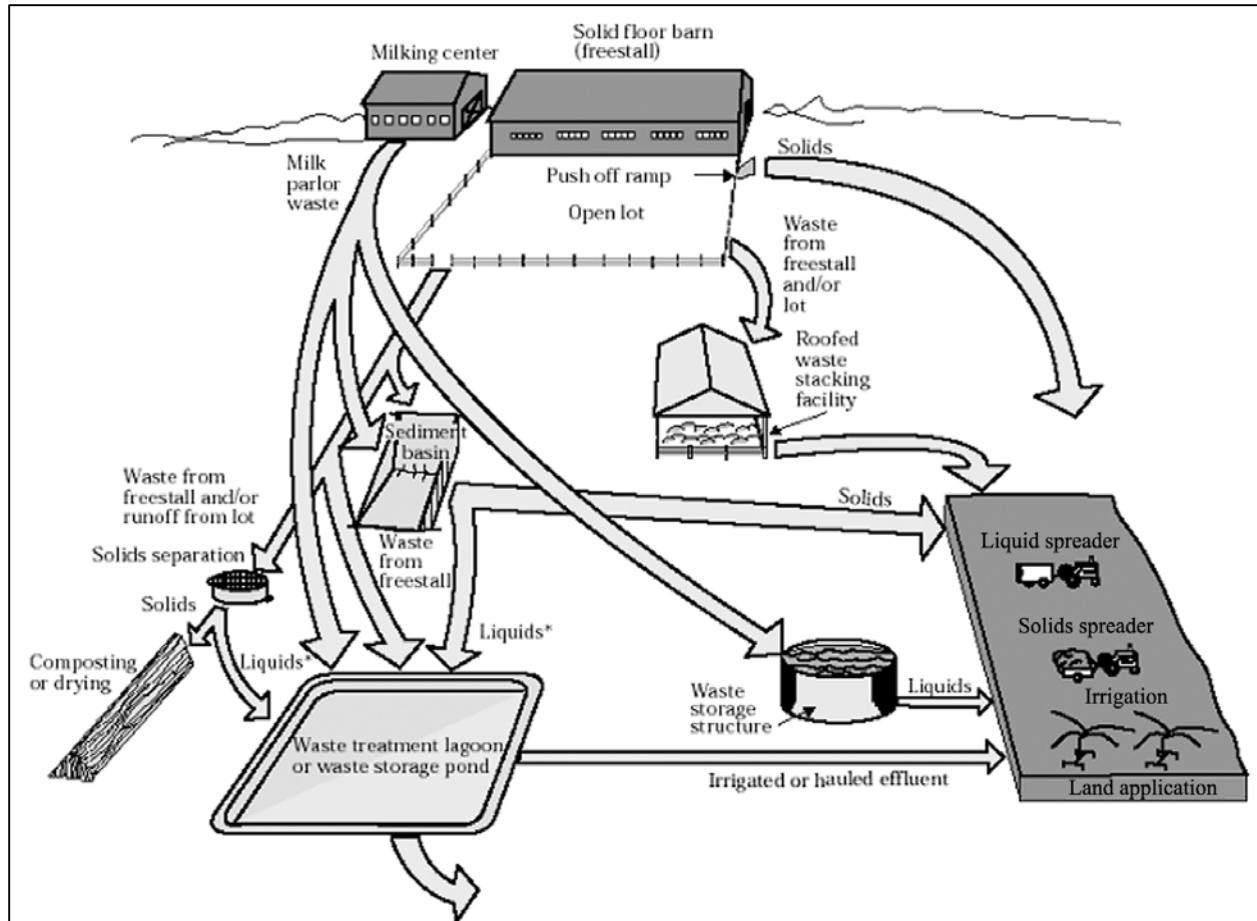

Dairy Waste Handling (Source: USDA Agricultural Waste Management Field Handbook) (Note that burial is prohibited or highly regulated in some states.)

In the nation's southern and western states dry lots are more common than the totally enclosed free stall barns common in the Midwest. Manure accumulations on dry lots for lactating cows are typically removed by scraping with a tractor-mounted blade and handled as a solid, similar to the beef feedlot industry. Areas by feed bunks may be scraped daily, with longer intervals between manure removals in other areas of the lot. Areas by feed bunks may also be flushed. Manure accumulations in dry lots used for heifers and dry cows are usually removed by scraping and are handled as a solid. If manure removed from dry lots by scraping is not land applied immediately, it is stored by stacking on a section of the lot or at a separate site. Calf and heifer manure may be transferred from a scraped free-stall barn to the storage structure used for manure, or the lagoon used for flushed manure, or it may be handled as a solid, depending on the methods of calf and heifer confinement and the handling system used for the manure from the lactating cows.

Dry lots should have runoff collection and retention basins to prevent the discharge of manure-contaminated runoff to adjacent surface waters.

Treatment of the manure before land application using large anaerobic digesters (AD) will be seen more frequently on CAFOs, thanks in part to the work of EPA's Ag STAR program. These

large anaerobic digester vessels can be either completely in-ground or above-ground but in either case the goal is the same – to create electricity or compressed natural gas using the biogas that develops naturally when the temperature of the manure is raised. The typical retention time for the manure is 21 days or less. Livestock producers like the benefits of ADs such as odor reduction, pathogen reduction, and easier transport of the manure nutrients to the field, such as with center pivots (ability to pump depends on the amount of solid separation completed by the treatment system.) See EPA’s Ag STAR website for more information at: <https://www.epa.gov/agstar>

As cattle manure is rather weak in terms of its energy production potential, most ADs will import substrate material to boost the energy production. Common substrate materials include waste food, grease, food processing wastes, etc. The addition of a substrate material increases the energy production and decreases the payback period for the initial investment.

It is not uncommon for large dairy CAFOs to have their AD systems operated by a third party.

A.3.3 Dairy Mortality Management

Although the frequency of mortality in the dairy industry is much less than in the poultry and swine industries, deaths do occur. Usually, carcass disposal is by rendering, with burial being the only other realistic option if no rendering facility willing to accept dead animals is located within a reasonable distance of the farm. (Note that burial is prohibited or highly regulated in some states.) Carcass composting is also an option, particularly for the disposal of young calf carcasses, but can be done with adult animals too if the compost operation is properly sized and managed.

A.4.0 Beef Cattle

There are three different types of operations in the beef industry, with each type corresponding to a different phase of the production cycle. The first is the cow-calf operation that is the source of the heifers and steers (castrated males) fed for slaughter. Cow-calf operations typically maintain a herd of yearling heifers, brood cows, and breeding bulls on pasture or range land to produce a yearly crop of calves for eventual sale as feeder cattle. In colder climates and during drought conditions, cow-calf operations using pasture or range land will provide supplemental feed, primarily hay but also some grain and other feedstuffs. Confinement on dry lots is also an option used in some cow-calf operations when grazing will not satisfy nutritional needs. Although pasture or range-based cow-calf operations are most common, operations that exclusively use dry lots may be encountered. In colder climates, cow-calf operations may have calving barns allowing cows to calve indoors to reduce calf mortality.

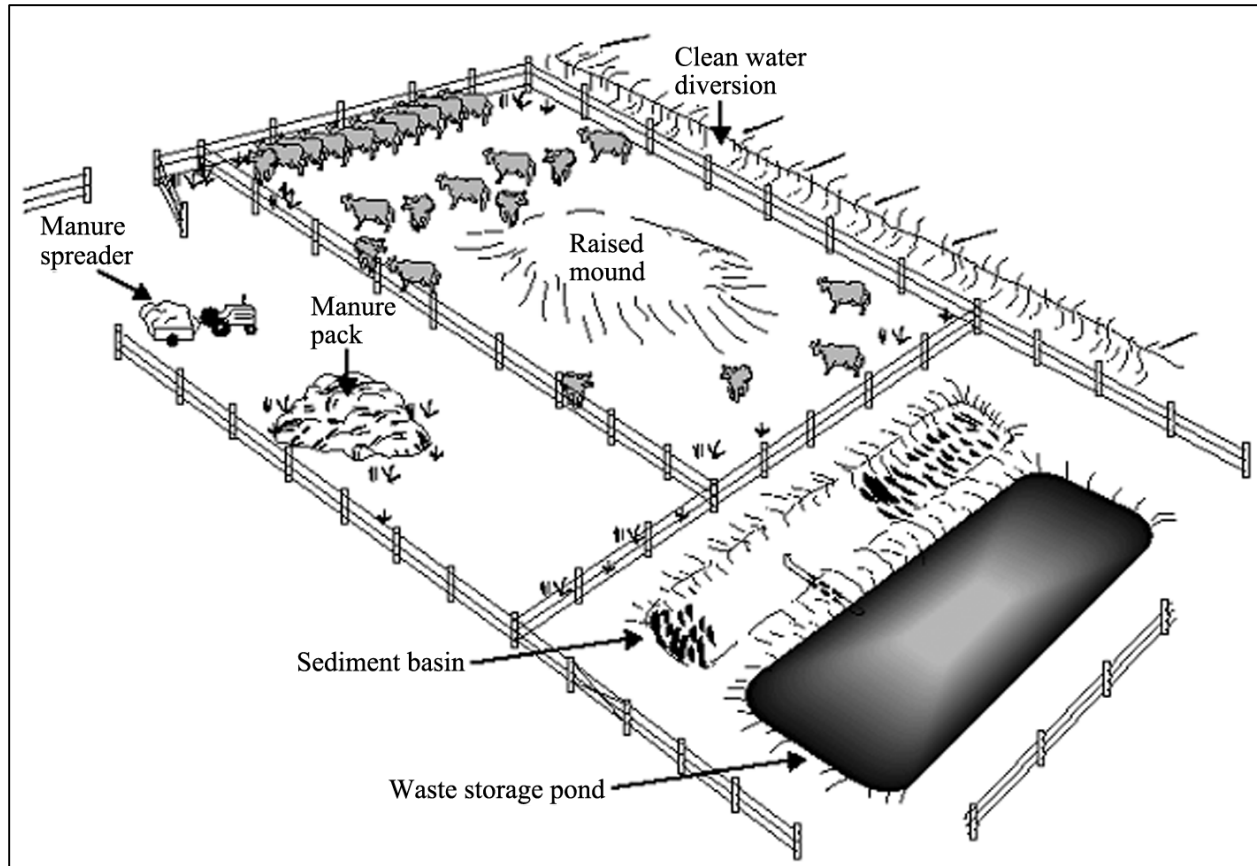

Beef Feedlot Waste Collection (Source: USDA Agricultural Waste Management Field Handbook)

The second type of operation in the beef industry is known as a backgrounding or stocker operation. These operations prepare weaned calves for finishing. Backgrounding operations may be pasture or dry-lot based, or some combination thereof. Relatively inexpensive forages, crop residues, and pasture are used as feeds, with the objective of building muscle and bone mass without excessive fat at a relatively low cost. The length of the backgrounding process may be as short as 30 to 60 days or as long as 6 months. The duration of the backgrounding process and the size of the animal moving on to the finishing stage of the beef production cycle depend on several factors. High grain prices favor longer periods of backgrounding by reducing feed costs for finishing or fattening, while heavier weaning weights shorten the finishing process. Backgrounded beef cattle may be either sold to a finishing operation as “feeder cattle,” usually at auction, or raised under contract with a finishing operation. It is common for large finishing operations to have cattle backgrounded under contract to ensure a steady supply of animals. In some instances, cow-calf and backgrounding operations will be combined.

The final phase of the beef cattle production cycle is the finishing or feedlot phase where a high energy, grain-based ration with only a small amount of roughage is fed to produce rapid weight gain and desirable carcass characteristics. The larger commercial finishing operations usually feed a complete ration that is a mixture of feed grains, roughage, and other ingredients. Usually, the finishing phase begins with 8 to 9-month old animals weighing about 700-800 pounds. Somewhere between 150 and 180 days, these animals will reach the slaughter weights

of 1,250 to 1,350 pounds for heifers and 1,350 and 1,450 pounds for steers, and a new finishing cycle begins. Some feedlot operators will immediately start with younger animals weighing about 275 pounds or older and heavier animals. This will either extend the finishing cycle to about 270 days or shorten it to about 100 days. Beef cattle in the finishing phase are known as “cattle on feed.” Finished cattle are “fed cattle.”

A.4.1 Beef Confinement Facilities

In addition to pasture or range-based cow-calf and backgrounding operations, beef cattle may be raised on unpaved or partially paved open lots or in bedded and slatted confinement barns with pits. When feedlots and dry lots on cow-calf and backgrounding operations are partially paved, it is the areas around feed bunks and sources of drinking water that will be paved. These are high animal traffic areas and have high rates of manure accumulation.

A typical beef cattle feedlot is divided into a series of large pens to allow animals to be grouped by age. In each pen, there are feed bunks, sources of drinking water, and probably shaded areas in warm climates. Feed bunks located along one side of a pen are known as fence line feed bunks, and feed is delivered with specially equipped trucks or tractor-drawn feed wagons from a feed alley. Mechanical feed bunks may be located in the center of a pen or used as a divider between two pens. Although mechanical feed bunks allow cattle to feed on both sides of the feed bunk, their use is generally limited to smaller operations. Feed bunk space per head is an important parameter in beef cattle feedlot design. The large commercial feedlots may also have a feed mill and an area for treating sick animals.

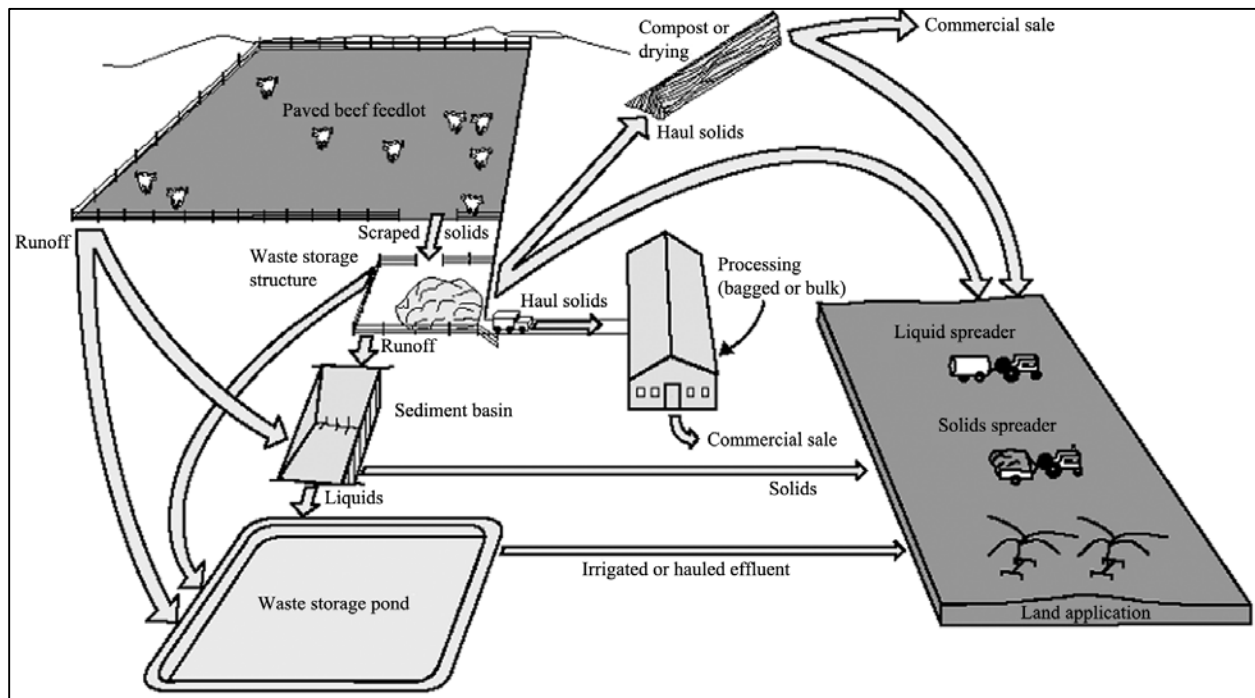

Beef Waste Handling (Source: USDA Agricultural Waste Management Field Handbook. Note that burial is prohibited or highly regulated in some states.)

A.4.2 Beef Manure Management

Manure produced by beef cattle on open lots is primarily handled as a solid, with removal by scraping and storing the collected manure in mounds on the lot. Manure accumulation is typically highest around feed bunks and sources of drinking water. The complete removal of manure from open lots used for beef cattle production may only occur annually during summer months to take advantage of natural drying to facilitate handling as a solid.

Open lots for beef cattle should also have runoff collection and retention basins to prevent the discharge of manure-contaminated runoff to adjacent surface waters.

A.4.3 Beef Mortality Management

As in the dairy industry, the frequency of mortality in the beef cattle industry is much lower than in the poultry and swine industries; however, deaths do occur. Carcass disposal by rendering is the primary option. Additionally, composting may be used to manage mortalities. Given the size of most beef cattle operations, burial cannot generally be considered a realistic alternative in the context of water quality protection.

A.5.0 Land Application of Manure

Livestock and poultry manures have value as sources of plant nutrients for crop production. Historically, livestock or poultry production and crop production have been integrated activities. As animal production units have been consolidated into fewer but larger operations, a decoupling of animal and crop production activities has gradually occurred. As a result, some livestock and poultry producers do not have adequate land under their ownership or direct control for the proper utilization of all the manure that is generated. In this case, producers may sell or give away manure to nearby crop farmers.

Manure handled as a solid, such as broiler, turkey, and solid cattle feedlot manure, is typically surface applied to cropland using either tractor-drawn or truck mounted box-type manure spreaders. To reduce potential pollutant transport in surface runoff, disking or plowing may follow application to incorporate the manure into the soil. Manure handled as a semi-solid or slurry, such as dairy cattle manure scraped from free-stall barns, is typically applied to cropland using tractor-drawn or truck-mounted tanks. This type of manure typically can be surface applied and may be subsequently incorporated into the soil by disking or plowing. Manure handled as a semi-solid may also be directly injected into the soil using specially designed spreading equipment. Manure handled as a liquid, such as flushed dairy and swine manure, and effluent from open cattle feedlots may be applied to cropland using tractor-drawn or truck-mounted tanks or irrigation systems. Due to the volume of manure when handled as a liquid, irrigation is a fairly common method for land application of liquid manure due to the reduction in labor requirements. Like semi-solid or slurry manure, liquid manure may be incorporated into the soil after application or may be directly injected into the soil.

Livestock and poultry manure has many beneficial properties in addition to the nitrogen and phosphorus needed by growing crops. As opposed to chemical fertilizers, manure improves soil quality and increases the soil's ability to absorb and retain moisture. Unfortunately, there are some areas in the country where the land available on farms for manure application is

insufficient to accept all of the manure produced. In the USDA report, [Manure Nutrients Relative to the Capacity of Cropland and Pastureland to Assimilate Nutrients](#), Kellogg et al. (2000) used estimates of livestock populations and land available for manure applications from the Census of Agriculture. They found in some counties the production of recoverable manure nutrients exceeds the assimilative capacity of all the cropland and pastureland available for manure application (without excessive build-up of nutrients) in the county. The number of such counties has significantly increased since their initial analysis conducted in 1982. Figures 1-1 and 1-2 show the regions of the country with excess manure nitrogen and phosphorus assuming no export of manure from the farm, respectively (Kellogg et al., 2000).

A.6.0 Environmental Impacts

Livestock and poultry manure, if not properly handled and managed by the CAFO, can contribute pollutants to the environment and pose a risk to human and ecological health. The components of manure most commonly associated with animal waste include nutrients (including ammonia), organic matter, solids, pathogens, and odorous compounds. Animal waste can also be a source of salts and various trace elements (including metals), as well as pesticides, antibiotics, and hormones. These manure components can be released into the environment through spills or runoff if manure and wastewater are not properly handled and managed.

A CAFO's process wastewater and manure can enter the environment through a number of pathways. These include surface runoff and erosion, overflows from lagoons, spills and other dry-weather discharges, leaching into soil and ground water, and volatilization of compounds (e.g., ammonia) and subsequent redeposition on the landscape. Manure and wastewater can be released from an operation's animal confinement area, treatment and storage lagoons, and manure stockpiles, and from cropland where manure is land-applied.

EPA's [National Water Assessment Report](#) provides information on water quality conditions reported by states to EPA under Sections 305(b) and 303(d) of the Clean Water Act. Data submitted in 2010 indicates that the agricultural sector including crop production, pasture and range grazing, and CAFOs is the leading probable source contributing impairments to the nation's rivers and streams. The top causes of impairments in assessed rivers and streams are pathogens, sediment, nutrients, and organic enrichment/oxygen depletion – all of which are environmental impacts associated with over application or accidental spills of livestock manure, among other agricultural point source and non-point sources such as wildlife and rural septic tanks. The agricultural sector is also the fourth leading contributor of impairments for the nation's lakes, ponds, and reservoirs and the fifth leading contributor for probable water quality impairments in assessed coastal shorelines (EPA 2012b).

Among the reported environmental problems associated with excess nutrients are surface water (e.g., lakes, streams, rivers, and reservoirs) and ground water quality degradation, and adverse effects on estuarine water quality and resources in coastal areas. Scientific literature documents how this degradation might contribute to increased risk to aquatic and wildlife ecosystems; an example is the large number of fish kills in recent years. A literature survey conducted for the 2003 CAFO Rule identified more than 150 reports of discharges to surface waters from hog, poultry, dairy, and cattle operations. Human and livestock animal health

might also be affected by excessive nitrate levels in drinking water and exposure to waterborne human pathogens in manure (EPA 1998).

While most livestock producers understand the economic value of manure and many CAFOs follow individual nutrient management plans tailored to their farm conditions and the crops being grown, incidents can result from over application (too much), improper application (too close to surface waterways), unpredictable precipitation events, poor management, and accidental spills. Assistance for CAFOs in developing site-specific nutrient management plans is available through NRCS, private advisors and many state programs.

A.6.1 Nutrients

Animal wastes contain significant quantities of nutrients, particularly nitrogen and phosphorus. The nutrients provide a valuable resource that can save money by replacing chemical fertilizer. It is desirable to minimize nutrients lost from improper storage and land application. Manure nitrogen occurs in several forms, including ammonia and nitrate. Ammonia and nitrate have fertilizer value for crop growth, but these forms of nitrogen can also produce adverse environmental impacts when they are transported in excess quantities to the environment. Ammonia is of environmental concern because it is toxic to aquatic life and it exerts a direct biochemical oxygen demand (BOD) on the receiving water, thereby reducing dissolved oxygen levels and the ability of a water body to support aquatic life. Excessive amounts of ammonia can lead to eutrophication, or nutrient over-enrichment, of surface waters.

While nitrate is a valuable fertilizer because it is biologically available to plants, nitrate is mobile in soil and can leach to ground water. Excessive concentrations of nitrate in drinking water can produce adverse human health impacts such as methemoglobinemia in infants. Generally, people drawing water from domestic wells are at greater risk of nitrate poisoning than those drawing from public water sources, because domestic wells are typically shallower and not subject to wellhead protection monitoring or treatment requirements. Note that nitrate is not removed by conventional drinking water treatment processes but requires additional, relatively expensive treatment units.

Phosphorus is of concern in surface waters because it can lead to eutrophication and the resulting adverse impacts—fish kills, reduced biodiversity, objectionable tastes and odors, increased drinking water treatment costs, and growth of toxic organisms. Phosphorus is primarily sorbed to soil colloids and transportation to surface water occurs with soil erosion. Soluble phosphorus exists especially when soil is saturated with respect to P and has been found to leach in very sandy soils after many years of manure application. At concentrations greater than 1.0 milligrams per liter, phosphorus can interfere with the coagulation process in drinking water treatment plants thus reducing treatment efficiency. Phosphorus is of particular concern in fresh waters, where plant growth is typically limited by phosphorus levels. Under high pollutant loads, however, fresh water may become nitrogen-limited. Thus, both nitrogen and phosphorus loads can contribute to eutrophication.

A.6.2 Dissolved Oxygen

Livestock manures contain many carbon-based, biodegradable compounds. Once these compounds reach surface water, they are decomposed by aquatic bacteria and other microorganisms. During this process dissolved oxygen is consumed, which in turn reduces the amount of oxygen available for aquatic animals. Severe reductions in dissolved oxygen levels can lead to fish kills. Even moderate decreases in oxygen levels can adversely affect water bodies through decreases in biodiversity characterized by the loss of fish and other aquatic animal populations, and a dominance of species that can tolerate low levels of dissolved oxygen.

A.6.3 Solids

Solids from animal manure include the manure itself and any other elements that have been mixed with it. These elements can include spilled feed, bedding and litter materials, hair, and feathers. In general, the impacts of solids include increasing the turbidity of surface waters, physically hindering the functioning of aquatic plants and animals, and providing a protected environment for pathogens. Increased turbidity reduces penetration of light through the water column, thereby limiting the growth of desirable aquatic plants that serve as a critical habitat for fish, shellfish, and other aquatic organisms. Solids that settle out as bottom deposits can alter or destroy habitat for fish and benthic organisms. Solids also provide a medium for the accumulation, transport, and storage of other pollutants, including nutrients, pathogens, and trace elements.

A.6.4 Pathogens

Pathogens are defined as disease-causing microorganisms. A subset of microorganisms, including species of bacteria, viruses, and parasites, can cause sickness and disease in humans and are known as human pathogens. EPA's [National Water Assessment Report](#) indicates that pathogens are the leading stressor in impaired rivers and streams and the second leading stressor in impaired estuaries, coastal shorelines, and wetlands (EPA 2012b). Livestock manure may contain a variety of microorganism species, some of which are human pathogens. Multiple species of pathogens can be transmitted directly from a host animal's manure to surface water. Pathogens already in surface water can increase in number because of loadings of animal manure nutrients and organic matter.

A number of pathogens are associated with livestock and poultry manure but only a few pose a known or potential threat to humans. The six human pathogens that account for more than 90 percent of food and waterborne diseases in humans are found in livestock manure. These organisms are: *Campylobacter* spp., *Salmonella* spp. (non-typhoid), *Listeria monocytogenes*, *Escherichia coli* O157:H7, *Cryptosporidium parvum*, and *Giardia lamblia*. All of these organisms may be readily transmitted from one animal to another in CAFO settings. Pathogens from animal wastes can enter water sources, resulting in contamination of surface waters. In addition to threats to human health through drinking water exposures, pathogens from animal manure can also threaten human health through shellfish consumption and recreational contact such as swimming in contaminated waters. An important feature relating to the potential transmission for disease for each of these organisms is the relatively low infectious

dose in humans. The protozoan species *Cryptosporidium parvum* and *Giardia lamblia* are frequently found in animal manure and can cause infection in humans. Bacteria such as *Escherichia coli* O157:H7 and *Salmonella* spp. are also often found in livestock manure and have been associated with waterborne disease. The bacteria *Listeria monocytogenes* is ubiquitous in nature and is commonly found in the intestines of wild and domestic animals.

A.6.5 Salts

The salinity of animal manure is directly related to the presence of dissolved mineral salts. In particular, significant concentrations of soluble salts containing sodium and potassium remain from undigested feed that passes unabsorbed through animals. Other major constituents contributing to manure salinity are calcium, magnesium, chloride, sulfate, bicarbonate, carbonate, and nitrate. Especially in arid soils salt buildup deteriorates soil structure, reduces permeability, contaminates ground water, and reduces crop yields. In fresh waters, **increasing** salinity can disrupt the balance of the ecosystem, making it difficult for resident species to remain. Salts also contribute to degradation of drinking water supplies, primarily from runoff containing manure.

A.6.6 Trace Elements

EPA's [National Water Assessment Report](#) indicates that metals (other than mercury) are the fourth leading stressor in impaired wetlands and the fifth leading stressor in impaired lakes (EPA 2012b). Trace elements of environmental concern in manure include arsenic, copper, selenium, zinc, cadmium, molybdenum, nickel, lead, iron, manganese, aluminum, and boron. Of these, arsenic, copper, selenium, and zinc are often added to animal feed as growth stimulants or biocides. Trace elements can also end up in manure through use of pesticides used to suppress houseflies and other pests. Trace elements have been found in manure lagoons and drainage ditches, agricultural drainage wells, and tile line inlets and outlets. They have also been found in rivers adjacent to hog and cattle operations. Trace elements in agronomically applied manures are generally expected to pose little risk to human health and the environment. Most crops, for example, beneficially use a small amount of copper and zinc to complete their life cycle but any amount not assimilated through plant uptake can accumulate in the soil (Novak et al., 2004). Repeated manure application in excess of agronomic rates could result in cumulative metal loadings to levels that potentially affect human health and the environment.

A.6.7 Antibiotics

Antibiotics are used in AFOs for the prevention, treatment and control of animal diseases and can be expected to appear in animal wastes. Antibiotics are used both to treat illness and as feed additives to promote growth or to improve feed conversion efficiency. Between 60 and 80 percent of all livestock and poultry receive antibiotics during their productive lifespan. The primary mechanisms of elimination are in urine and bile, so essentially all of an antibiotic administered is eventually excreted, whether unchanged or in metabolite form. The use of the same antibiotics for humans and livestock has been noted by the World Health Organization (WHO) and others who are concerned that the effectiveness of these antibiotics in treating human diseases could decrease. The emergence of resistant bacteria is of particular concern

because such infections are more difficult to treat and require drugs that are often less readily available, more expensive, and more toxic. The Food and Drug Administration issued a guidance in 2012 encouraging the judicious use of antimicrobial drugs in food animals. They are continuing to work with the pharmaceutical industry to phase out the use in livestock and poultry of medically important antibiotics for human health.

A.6.8 Pesticides and Hormones in CAFOs

Hormones and pesticides are chemicals commonly found in CAFO manure, and both have been linked with endocrine disruption of fish and invertebrates in the surrounding environments. Several forms of estrogens, androgens, or a combination of both have been detected in dairy waste (Zheng et al. 2008), and poultry litter (Jenkins et al. 2006). Pesticides, especially those that are used for treatment of parasites, have also been detected in the environment following manure application (Floate et al. 2005).

Hormones are naturally occurring chemicals produced by animals to regulate physiological processes such as metabolism, growth, and reproduction. Natural steroid hormones include estrogen, progesterone, and testosterone. Synthetic steroid hormones, which mimic the actions of the naturally occurring compounds, may be administered to livestock to promote better muscle growth, produce leaner meat, improve feed conversion efficiency, and improve breeding. Other types of hormones (non-steroid hormones or protein hormones) may also be given to promote growth and increase milk production. Hormones categorized as progestins and gonadotropins may be administered via injections or other means to improve breeding efficiency. A complete list of FDA approved steroid hormones used as implants and their specific use for growth promotion can be found in the Code of Federal Regulations (CFR), Title 21, Parts 522 and 556.

Feedlot effluents containing hormones have been shown to affect fish in adjacent streams causing decreased synthesis of testosterone, smaller testis size, and general demasculinization of those fish (Orlando et al. 2004). Other effects of hormones in the aquatic environment may include feminization or intersex condition in fish and increases in concentrations of proteins related to egg laying in both male and female fish.

Varieties of pesticides are approved for use in feedlot animals for control of insects and parasites, and can enter process wastewater via runoff from topical applications or from manure. These compounds are administered via injection, insecticidal ear tags, or oral consumption in feed/minerals. They may also be applied directly to the skin as pour-on formulation or when animals (especially cattle) pass under a backrubber/oiler or dust bag where insecticides are dispensed to the skin. Ivermectin is a common pesticide that can be applied by several methods to livestock for control of roundworms, lung worms, cattle grubs, mites, lice, and horn flies. Some pesticides are used in CAFOs specifically to control flies. For example, the insecticide methoprene is sometimes used as a feed or mineral additive to control horn flies. Methoprene passes through the digestive tract of animals and remains in the manure where horn flies lay eggs. The pesticide mimics an insect growth regulator called juvenile hormone, and disrupts the life cycle and development of the larval flies.

Insecticides are often designed to interfere with hormonal processes like molting, growth, or reproduction in invertebrates. Residues of some insecticides are well documented for adversely affecting other non-target populations of insects. Additionally, effluent from CAFOs or runoff resulting from spreading manure on pastures or cropland introduces pesticides into the soil and aquatic environment where aquatic insects may be affected. Parasiticides like ivermectin and some insecticides are known to cause mortality to aquatic insects (Schweitzer et al. 2010).

Careful use of hormones, pesticides, insecticides, and antibiotics for production agriculture is important to protect the animals, the livestock producers, the public and the environment. Because these substances are often present in manure, careful management and land application of manure and process wastewater is equally important.

Appendix AE – Management/Soil Science

NUTRIENT MANAGEMENT AND SOIL SCIENCE

Understanding soil science and soil fertility concepts are instrumental in developing, understanding, and implementing nutrient management plans (NMPs) that allow for maximum utilization of the nutrients in the soil while minimizing the runoff of nutrients and pollutants. CAFO inspectors should become aware of the following basic nutrient management and soil science concepts.

Soil Properties

Inspectors should understand the basics of soil properties and how the soil retains nutrients. The nutrients in the soil are a source of information for NMP development and implementation. Important soil priorities are:

- Organic matter is derived from decomposed plant and animal material.
- Bulk density is the mass of dry soil per unit of bulk volume, including the airspace. Soils with a high proportion of pore space to solids have lower bulk densities than those that are more compact and have less pore space. As bulk density increases, pore space is reduced, which inhibits root growth. Fine-textured soils such as silt loams, clays, and clay loams generally have lower bulk densities than sandy soils. Sandy soils typically have less total pore space than finer textured soils.
- Texture is the fineness or coarseness of the mineral particles in the soil and is determined by the relative amounts of different sized mineral particles in the soil.
- Aggregation is the cementing or binding together of several soil particles into a secondary unit.
- Structure describes how soil particles are arranged or grouped together to form structural pieces (building blocks) called peds or aggregates that vary in shape and size. The arrangement of the aggregates determines the soil's structure. Good structure allows favorable movement of air and water and allows and encourages extensive root development.
- Color is an indicator of the soil's composition. Soil colors usually result from various oxidation states of the present minerals. Brighter colors (yellow and red) are an indication of iron oxides and suggest good drainage and aeration. Grayish soils can indicate iron reduction caused by permanently saturated soil. Mottled color soils of various shades of yellow, brown, and gray are indicative of a fluctuating aerobic and anaerobic environment. Very dark browns and black soil colors can be an indication of high levels of organic matter.
- Retention/water-holding capacity is the amount of water retained in a soil that is dependent on the interaction of soil texture, bulk density, and aggregation. The term field capacity defines the amount of water remaining in a soil after downward gravitational flow has stopped, and it is expressed as a percent by weight.
- Soil drainage is defined as the rate and extent of water removal. This includes water movement across the surface and downward through the soil. Topography is a very

important factor in soil drainage. Other factors that affect drainage include the soil layers' texture and soil structure.

- Cat-ion Exchange Capacity (CEC) is a measure of the soil's ability to retain cat-ions and is indicative of the soil's fertility. Soil materials have a net surface charge, usually negative, that allows them to hold and retain ions (i.e., nutrients) against leaching. The net negative charge of a soil is largely attributed to the clay and organic matter in the soil and will naturally attract positively charged nutrients and repel negatively charged nutrients. Cat-ions, positively charged nutrients (e.g., ammonium (NH₃⁺)), remain in the soil while anions, negatively charged nutrients (e.g., nitrate (NO₃⁻)), are repelled and easily leached out of the soil.
- Soil Fertility is the ability of a soil to provide nutrients for plant growth.
- Soil pH affects plant nutrient availability because pH greatly influences the solubility of certain elements. Most crops grow best in slightly acidic soils (pH 6.0 to 6.5).

Soil and Plant Availability of Nutrients

Soil is a pathway for nutrients to flow to surface and groundwater and soil is a medium for nutrient transformations. The nutrient transformations affect the amount and form of nitrogen and phosphorus available to the plant. Appropriate manure and fertilizer applications in an NMP will account for many of the transformations. It is important for an inspector to understand the behavior of nitrogen and phosphorus in the soil.

Nitrogen Cycle and Nitrogen Movement in the Soil

Nitrogen is an essential part of amino acids, the building blocks for proteins, making it an important plant nutrient. Nitrogen in the soil exists in both organic (proteins, amino acids, urea, in living organisms and decaying plant and animal tissues) and inorganic forms [ammonium (NH₄⁺), nitrite (NO₂⁻), nitrate (NO₃⁻), and ammonia (NH₃ (gas))]. The majority of nitrogen in the soils is in an organic form which is largely unavailable for plant uptake.

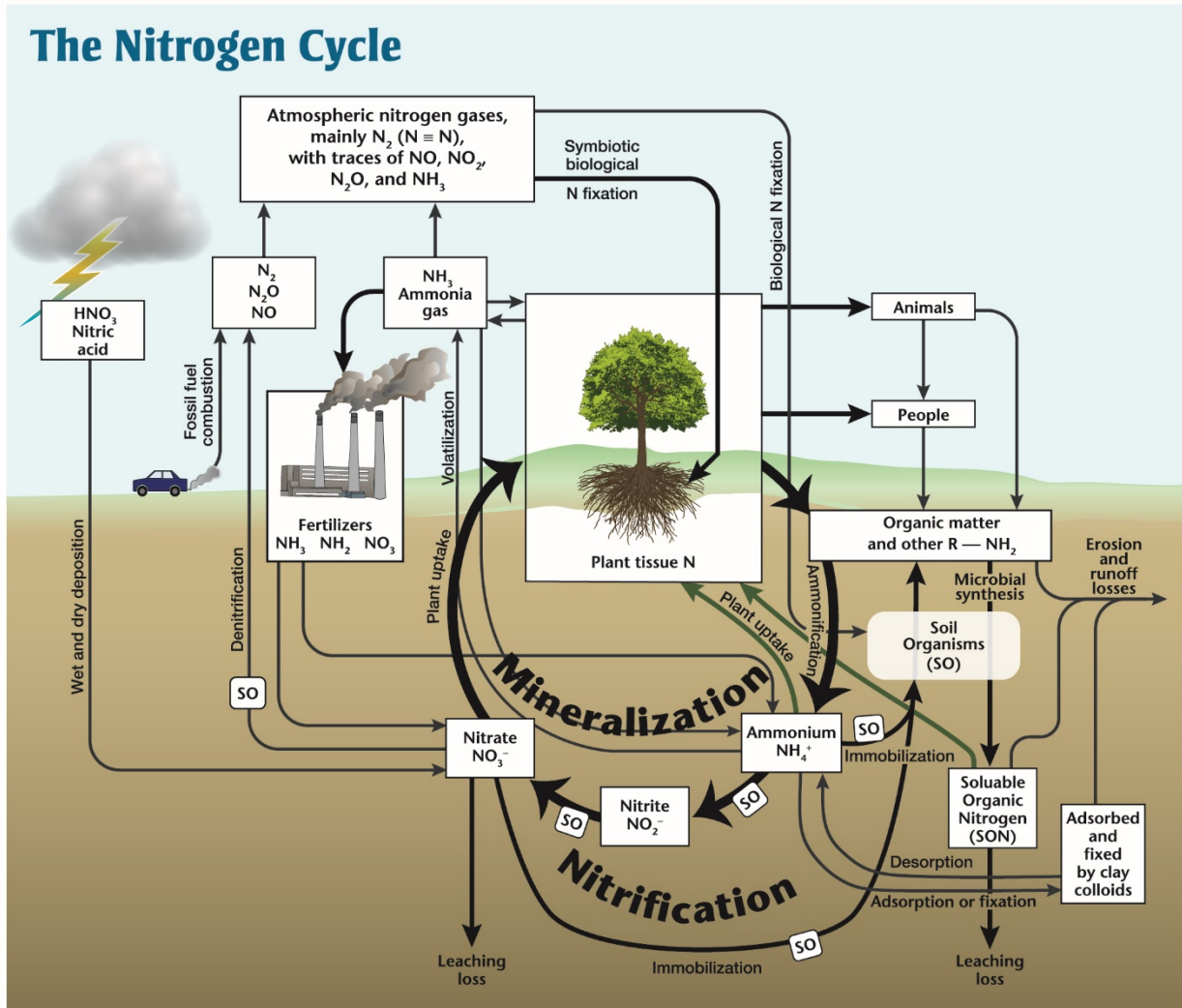

When manure is land applied as an organic compound, only a small fraction of the nitrogen is soluble as ammonium and plant available. However, a larger portion of that nitrogen is mineralized by microbes and is slowly released over many years. Nitrogen mineralization rates of the organic nitrogen present in manure vary depending on various environmental factors such as soil type, the manure source, and climate.

Nitrate is a negatively charged ion that is not adsorbed to the negatively charged soil mineral surfaces. If in excess, the negatively charged nutrient is repelled by the soil surfaces and lost to groundwater through leaching. Factors that contribute to nitrogen leaching or runoff include over-application of nitrogen as fertilizers or manure particularly on sandy or coarse-textured soils; improperly timed applications of nitrogen, poorly designed or nonexistent soil conservation measures; and periods of exceptionally heavy rainfall.

Nitrogen and Legume Credits

The largest amount of nitrogen is found in the atmosphere as an inert gas (N_2). Plants are not able to absorb gaseous nitrogen. Nitrogen becomes plant available when specialized bacteria fix nitrogen gas. Leguminous plants, such as alfalfa and soybeans, have a symbiotic relationship

with nitrogen-fixing bacteria, where the bacteria supply sufficient nitrogen to the plant and the plant supplies carbohydrates to the bacteria. Because of that relationship, a legume crop is able to supply its own nitrogen need and enrich the soil with nitrogen for crops that follow in the rotation and therefore is considered a nitrogen credit.

Since most of the nitrogen in soils is unavailable to plants, manure is typically applied to crops to provide the important nutrients that the plant needs. However, if legume crops are planned in a rotation, legume crops supply nitrogen rather than using nitrogen from the soil. Once the nitrogen recommendation for a crop is known, the manure application rates can be determined by subtracting from the total nitrogen recommendation the amount that will be available to the crop from all other sources. These sources of nitrogen already in the field are referred to as nitrogen credits. Two common credits of plant available nitrogen (PAN) are organic nitrogen from prior manure applications that mineralizes to available nitrogen compounds over the course of the planning period and nitrogen supplied from legume crops.

Phosphorus Cycle and Phosphorus Movement in the Soil

Sources of soil phosphorus include decomposing organic matter, humus, and weathered rock. Plant available forms of phosphorus include hydrogen phosphate (HPO_4^{-2}) and dihydrogen phosphate (H_2PO_4^-). Unlike nitrogen, gaseous forms of phosphorus seldom exist and are often not considered in the phosphorus cycle.

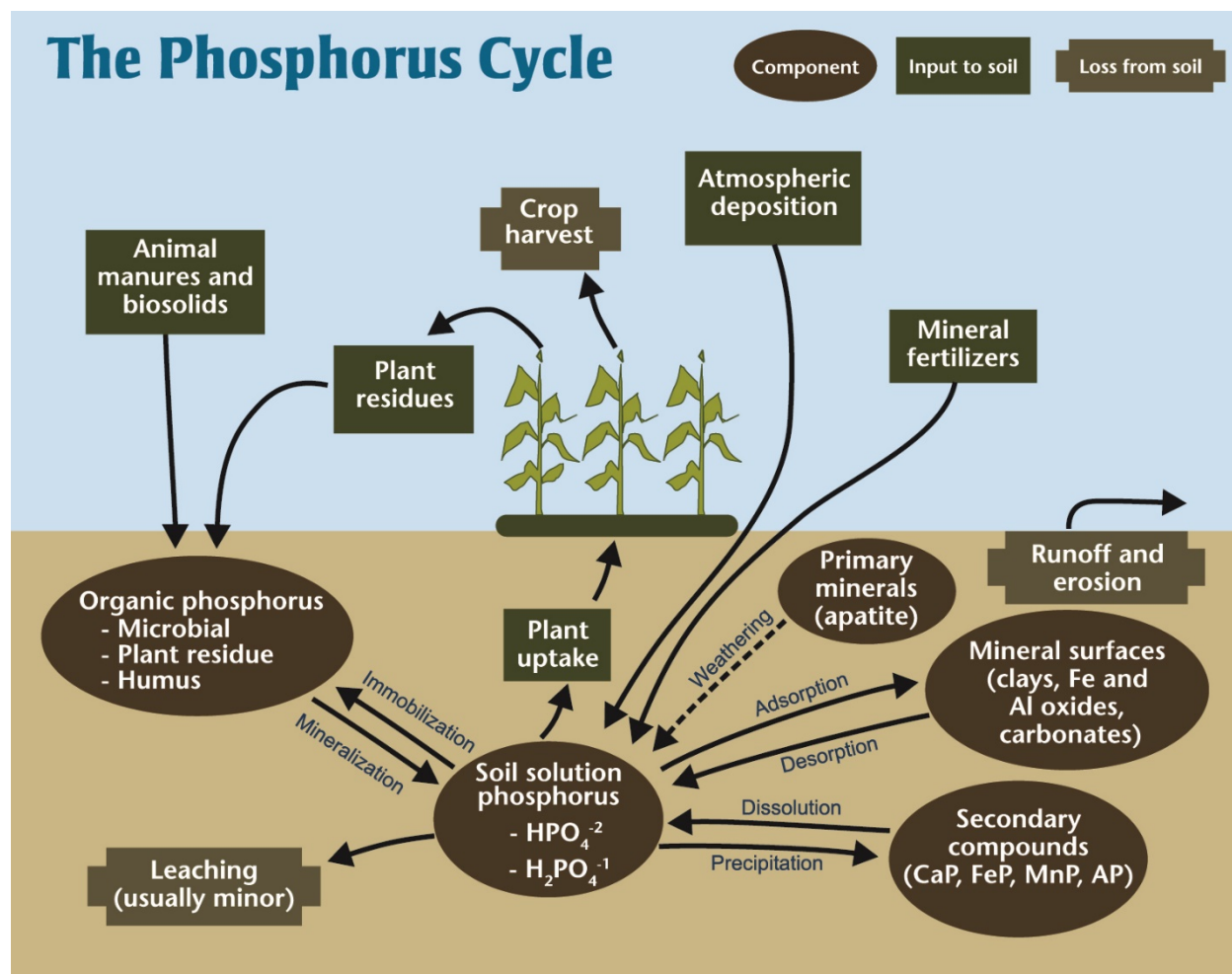

When phosphate ions are added to a soil, they are quickly (within hours) removed from solution to form phosphorus containing compounds with very low solubility. Phosphate most commonly forms compounds with either calcium or iron and aluminum (sometimes manganese). Initially, some ions are retained on the exchange complex, which makes them moderately plant available but with time, they undergo sequential reactions that continually decrease their solubility. These reactions result in phosphorus permanently bonding to the calcium or aluminum/iron/manganese ions, becoming buried from additional precipitation reactions. Those reactions can also capture phosphorus within the calcium or iron/aluminum/manganese particles. That is called phosphorus fixation and it is not easily reversible.

Additions of fertilizers and manures typically allow for only 10 to 15 percent of added phosphorus to be taken up by plants because of that fixation capacity. During the early and mid-20th century, farmers applied phosphorus in quantities far in excess of the plants' nutritional needs and manure has historically been applied at rates to meet plant nitrogen requirements, which can supply 2 to 4 times the phosphorus requirement. What was not removed in the harvest accumulates in the soil in an insoluble, unavailable form.

If not taken up by plants, phosphorus can be lost with surface runoff as dissolved phosphorus (if not incorporated into a soil) or it can be lost with soil particles through erosion or leaching.

Infiltration, Percolation, Leaching, Runoff and Erosion and its Effects on Water Quality

A primary principle of soil water management is to encourage water movement into, rather than off the soil. The more water runs off the surface, the less infiltrates into the soil. The movement of water impacts the movement of nitrogen and phosphorus in the soil. As water enters a soil (infiltration) and moves down through the soil profile (percolation) it carries dissolved nutrients with it (leaching). Dissolved nutrients can also be carried through runoff over the soil. Leaching losses occur when the amount of rainfall or irrigation water entering a soil exceeds the soil's ability to store the excess rainfall or irrigation. The amount and rate of nutrient losses are influenced by the amount of rainfall or irrigation, the topography of the landscape, the amount of evaporation, the soil type, and the crop cover.

The goal for the application of nutrients is to make them available to crops. As described above, as nitrogen (nitrate) percolates through the soil, it can contaminate ground and surface waters. Nitrate can be toxic because it reduces the capacity for blood to carry oxygen. That can be lethal to human infants and can alter normal body functioning in adults. Surface runoff waters from heavily fertilized lands can contain levels of nitrate toxic to livestock. While phosphorus is not toxic, it can degrade water quality if lost from a soil system in significant quantities. Excessive growth of algae and other aquatic species takes place in water overly enriched with nitrogen and phosphorus. This eutrophication process depletes the water of its oxygen, thus harming aquatic life in the affected waterbody.

Maintaining good soil structure is critical to reducing runoff. Excess water that cannot infiltrate the soil accumulates on the surface and flows downgrade displacing surface soil particles along the way (erosion). Soil erosion damages productive soils and can increase nutrient transport to streams and lakes. Soil properties have an effect on nutrient leaching losses. The physical properties of sand, silt, and clay, and the relative proportions of each have direct bearing on nutrient retention. Coarse soils (soils with a high percentage of sand) generally permit greater nutrient loss than do finer textured soils (soils with higher percentage of silt and clay). Organic matter content and type and amount of clay have significant influence on retention and nutrient storage and exchange. Climatic factors and the amount of rain or irrigation water, along with best management practices, have an effect on the amount of infiltration and leaching that occurs in the soil.

Many best management practices are available to encourage residue management and to minimize negative consequences of soil tillage. Excessive tillage destroys the surface and should be avoided. Tillage across the slope, leaving small ridges, encourages water infiltration. Terraces can also help control the erosive potential of water movement and increase infiltration into the soil.

For a more detailed discussion of these concepts, see Appendix A. "Basic Soil Science and Soil Fertility" of the *CAFO Permit Writer's Manual*.

Appendix AF –
Standard Operating Procedure (SOP): Biosecurity
Procedures for Visits to Livestock and Poultry
Facilities

OFFICE OF ENFORCEMENT AND COMPLIANCE ASSURANCE STANDARD OPERATING PROCEDURE (SOP)

Biosecurity Procedures for Visits to Livestock and Poultry Facilities

General

SUMMARY OF PROCEDURE/PURPOSE

This procedure minimizes the risk of EPA personnel and those acting on their behalf (e.g., contractors, grantees, and senior environmental employment staff), here after called “EPA personnel,” transmitting animal diseases from livestock or poultry facilities, to livestock or poultry at another location. Livestock and poultry facilities include ranches, farms, dairies, feed yards, sale yards, swine premises, slaughterhouses, zoos, veterinarians, laboratories and other facilities where there are animals or unprocessed animal tissues, secretions or excretions, here after called “livestock and poultry facilities”.

SCOPE AND APPLICABILITY

These procedures apply to EPA personnel whose job responsibilities require them to make visits to livestock or poultry facilities. These visits may be conducted as part of an inspection, to conduct environmental monitoring, as part of a response action or for other purposes.

OECA has developed this SOP for EPA employees and it is intended solely for internal management purposes. It does not create any rights, substantive or procedural, enforceable at law. OECA may periodically revise this SOP to make improvements and/or to reflect changes in EPA policy. OECA reserves the right to act at variance with this procedure.

If, on a case by case basis, an EPA employee believes a variance is needed from a provision of this SOP, the situation should be discussed with the appropriate safety officer who can provide site- specific guidance. Any such variance must be explained and documented. Varying from this procedure does not disqualify information obtained for any purpose.

DEFINITIONS

Definitions for certain terms included in this SOP are provided in OECA’s Standard Operating Procedure Definitions document available on the [OECA Document Control SharePoint site](#).

EXTENSIVE ANIMAL CONTACT

- Extensive animal contact activities involve prolonged, direct contact with livestock or poultry or unprocessed animal tissues, secretions or excretions.

FOREIGN ANIMAL DISEASES

- Foreign animal diseases in the U.S. include highly pathogenic avian influenza, exotic Newcastle Disease, foot-and-mouth disease, classical swine fever, and African swine fever.

FIELD ACTIVITIES

- See OECA’s Standard Operating Procedure Definitions document.

HIGH RISK LOCATIONS

- High risk locations are those with existing emergency animal disease events.

LIVESTOCK AND POULTRY FACILITIES

- Include ranches, farms, dairies, feed yards, sale yards, swine premises, slaughterhouses, zoos, veterinarians, laboratories, and other facilities where there are animals or unprocessed animal tissues, secretions or excretions.

LEVEL 1 VISIT

- Visit to a farm/ranch that entails only an office or home visit that is not in a high risk location, and where no extensive contact is anticipated.

LEVEL 2 VISIT

- Visit to a farm/ranch where EPA personnel expect to walk around buildings, but not enter any confinement areas and expect to have minimal contact with livestock or poultry. The visit is not in a high risk location, and no extensive contact is anticipated.

LEVEL 3 VISIT

- Visit to a farm/ranch where there will be close contact, or a reasonable expectation of close contact, with livestock or poultry (walking through narrowly confined pens/lots where animals are within reach). The visit is not in a high risk location, and no extensive contact is anticipated.

PERSONNEL QUALIFICATIONS/RESPONSIBILITIES FOR HEALTH AND SAFETY

EPA personnel must comply with all applicable basic health and safety training requirements under Order 1440.2 *Health and Safety Requirements for Employees Engaged in Field Activities*. Supervisors must ensure that these requirements are met. EPA personnel should monitor for any revised or additional health and safety orders, policies and guidance that may affect them. Prior to the inspection/field investigation, a Health and Safety Plan (HASP) must be prepared to determine any health and safety hazards associated with the visit, and placed in the project file. Additionally, a Job Hazard Analysis (JHA) must be prepared for each field personnel's position.

If the EPA personnel's field activities include compliance monitoring or field investigations, the individuals must ensure they have completed all relevant inspector training as required under EPA Orders 3500.1 and 3510.

REFERENCES/OTHER ASSOCIATED PROCEDURES

- USDA/NRCS General Manual, Title 130, Part 403, Subpart H.
- EPA Order 1440.2, Health and Safety Requirements for Employees Engaged in Field Activities
- SHEM Guideline 51, Mandatory Health and Safety Training

- EPA Order 3500.1 Training Requirements for EPA Personnel Who Are Authorized to Conduct Civil Compliance Inspections/Field Investigations and EPA Inspector Supervisors, September 30, 2014
- EPA Order 3510 Training Requirements for Federal Credentials for Inspections and Enforcement of Federal Environmental Statutes and other Compliance Responsibilities, updated October 31, 2012
- [Livestock and Poultry Operation Inspections](#) Under EPA's National Pollutant Discharge Elimination System Program, fact sheet, Sept. 2014, EPA 305-F-14-001
- SHEM Guideline 29, Permit Required Confined Space

PROCEDURE

EQUIPMENT REQUIREMENTS

EPA personnel should be aware of personal health and safety issues when visiting livestock and poultry facilities and consult Health and Safety staff with questions about proper procedures and equipment needed. Livestock and poultry facilities may include areas defined by Occupational Safety and Health Administration (OSHA) as “confined spaces” (e.g., manure pits, grain silos, manure digesters, holding tanks/vaults/sumps/hoppers), which may have a potentially hazardous atmosphere and impair the ability to self-rescue. EPA personnel should not enter such areas.²⁶ In addition, extreme cold or hot conditions may necessitate adaptation of these procedures; personnel may want to consult with Health and Safety staff regarding any needed modifications to this SOP.

The following clothing and supplies should be considered for visits to livestock and poultry facilities.

CLOTHING/PERSONAL PROTECTIVE EQUIPMENT

- Plastic coveralls (disposable outerwear) or cloth coveralls
- Standard steel-toed safety boots with disposable boot covers
- Disposable gloves (e.g., nitrile, or vinyl)
- Hair nets
- Filtering face piece (respiratory protection beyond this is not anticipated but if necessary, would require additional supplies and procedures)
- Safety glasses with impact protection
- Hardhats

²⁶ If EPA personnel need to enter permit required confined spaces, OSHA requires that your employer develop written procedures, an entry permit system, and training for confined space entry. All appropriate safety precautions, which may include the use of appropriate air monitoring devices and personal protective equipment (PPE), must be followed. Refer to [SHEM Guideline 29, Permit-Required Confined Space](#) (internal EPA link)

SUPPLIES (SUPPLIES MUST BE APPROPRIATE TO PLANNED ACTIVITIES, SEE SECTION 2.3 FOR DECONTAMINATION PROCEDURES)

- Water container(s) for potable water
- EPA-approved disinfectant and relevant safety data sheets (SDS)
- Spray bottle for disinfecting small items
- Pump sprayer for disinfecting large items
- Long-handled brush
- Trash bags and zip-lock bags
- Paper towels
- EPA-approved soap or antibacterial wipes or products
- Bucket
- Duct tape to secure plastic boot covers, coveralls, etc.
- Waste containers for storing disinfectant rinsate, other liquid waste
- Plastic tub for storing “dirty” equipment and PPE in the vehicle
- Insect repellent
- First aid kit, including tick removal tool

FACILITY-PROVIDED TRANSPORTATION

EPA personnel may accept offers of facility-provided transportation within a facility if the total value of the transportation is \$20 or less. Consult with your ethics counselor if any of the following conditions apply:

- The total value of the transportation exceeds \$20, or
- You will be transported in non-ground vehicle (e.g., aircraft or helicopter) or
- You will likely be transported across more than one facility.

With prior approval, the Office of General Counsel may be able to accept the gift of travel pursuant to 31 USC 1353 through use of the ethics travel form. To use the ethics travel form, you must: be on travel status (more than 50 miles from the duty station); have a facility representative accompany you; *and* be on travel **in connection with a meeting or educational tour (not an inspection)**.

DECONTAMINATION PROCEDURES

The following procedures should be used to clean equipment, PPE, vehicle tires, and other items that become contaminated.

- Select an EPA registered disinfectant that will be active across a wide spectrum of germs under the conditions in which it will usually be used.
- The state veterinarian, APHIS or the state agriculture department may be able to assist EPA personnel with selecting an appropriate disinfectant.

- When on-site, consult the owner or operator to select a location for later decontamination. Where possible, use an existing decontamination area on-site.
- If there is no designated decontamination area already on-site, select an area on-site, but in an area that will minimize recontamination when leaving the site. The area should allow for proper management of the rinsate (e.g., rinsate will not runoff the property).
- Place clean clothing to change into, as appropriate, in a closed bag at the decontamination site.
- Place all needed decontamination supplies including sufficient water or access to running water at the decontamination site.
- Mix the disinfectant (if not ready-to-use) according to label directions and use appropriate PPE e.g., gloves, eye protection.
- Brush or rinse the contaminated item to remove all visible manure and other debris.
- Apply disinfectant to the item or place item in a container of disinfectant, according to label directions being careful to allow the disinfectant to remain in contact with the item for the required length of time if listed on the label.
- Rinse with water if and as directed on the disinfectant label.
- Place the decontaminated item in a clean location or in a clean bag or another container.
- Manage or contain rinsate if needed, and as appropriate.
- Dispose of used disinfectant according to label directions.

PROCEDURES FOR VISITING LIVESTOCK AND POULTRY FACILITIES

When planning visits to livestock and poultry facilities, EPA personnel should contact APHIS and/or the state veterinarian to identify any high risk areas with existing emergency animal disease events where travel should be avoided. Whenever EPA personnel are directed by the state veterinarian or APHIS not to enter an area, EPA personnel should refer to section 2.4.2 Procedures for Visits to High Risk Locations and Visits with Extensive Animal Contact. In addition, this information should be provided to the OECA Office of Compliance's Concentrated Animal Feeding Operation (CAFO) Coordinator and/or entered in the OECA Biosecurity SharePoint site.

PROCEDURES AFTER CONTACT WITH ANIMALS IN FOREIGN COUNTRIES

If EPA personnel have visited a foreign country where they were exposed to or had contact with animals (with or without a known contagious disease) they should inform their supervisor and should not make on-site visits to livestock or poultry facilities for at least 5 calendar days after their return. Clothing and equipment (including shoes) worn or used when exposed to or contacting animals must be cleaned (i.e., laundered, or rinsed to remove debris and washed with disinfectant according to label directions) before they are used at U.S. facilities. If cleaning is not possible, alternative clothing or equipment should be used.

PROCEDURES FOR VISITS TO HIGH RISK LOCATIONS AND VISITS WITH EXTENSIVE ANIMAL CONTACT

Whenever EPA personnel are directed by the state veterinarian or APHIS not to enter an area, EPA personnel should provide this information to the OECA Office of Compliance's Concentrated Animal Feeding Operation (CAFO) Coordinator and/or enter it in the OECA Biosecurity SharePoint site and follow the procedures in this section.

As a general rule, EPA will **not** conduct inspections on livestock or poultry facilities in areas with ongoing emergency foreign animal disease response activities (e.g., vaccination program, depopulation, disposal, or virus elimination). EPA will consult with the state veterinarian or APHIS office to determine when quarantines have ended and it is safe to resume inspections in the area. In special situations where there is information that demonstrates a substantial risk to human health or the environment, for example, as a result of a discharge from a poultry or livestock operation, EPA should consult with the state veterinarian or APHIS office to identify when it is safe to visit individual operations. Information on these types of situations also should be provided to the OECA Office of Compliance's CAFO Coordinator and/or entered in the OECA Biosecurity SharePoint site.

If EPA personnel anticipate they will have extensive contact with animals or unprocessed animal tissues, secretions or excretions during a visit to a livestock or poultry facility, they should consult with the state veterinarian or APHIS office and their health and safety staff to identify appropriate biosecurity procedures.

PROCEDURES FOR VISITS AT NON-HIGH RISK LOCATIONS, AND NO EXTENSIVE CONTACT

The procedures below provide basic biosecurity practices EPA personnel should follow when visiting farms, ranches, slaughterhouses and other facilities with **no known livestock or poultry diseases and where extensive contact is not planned**.

The biosecurity practices below are based on U.S. Department of Agriculture APHIS and Natural Resources Conservation Service²⁷ (NRCS) procedures. Facility operators may have adopted more stringent biosecurity measures (e.g., showering and changing clothes to come on to or leave the premises).

EPA PERSONNEL SHOULD DISCUSS APPROPRIATE BIOSECURITY MEASURES WITH THE OWNER/OPERATOR AND ARE ENCOURAGED TO ADOPT MORE STRINGENT MEASURES, AS APPROPRIATE, INTO THE PROCEDURES FOR THAT SPECIFIC FACILITY.

PRIOR TO THE VISIT

- Avoid wearing or using any apparel or equipment that cannot be easily cleaned and disinfected. Consider bringing bags to keep sensitive equipment such as phones, and cameras clean.

²⁷ NRCS General Manual, Title 130, Part 403, Subpart H.

- When visiting a facility with various age groups of one species in one day, visit the youngest animal group first. Poultry is an exception. Poultry breeding stock should be visited before other commercial birds.
- Designate a part of the vehicle to carry “dirty” items, preferably separate from the “clean” part of the vehicle where clean supplies are placed, e.g. the dirty area could be inside the trunk of a car.
- In consultation with Health and Safety staff, identify an appropriate location such as an EPA or state laboratory, or office, for disposal of soiled disposable items in case the owner/operator will not allow the waste to remain on-site.
- While it is highly unlikely that any medical or hazardous wastes would be created, if you suspect they may be created due to the type of facility or type of inspection (e.g., involving sampling of wastes), EPA personnel should consult with the appropriate EPA staff to determine the best handling and disposal methods.

BEGINNING THE VISIT

- Close vehicle windows.
- Park vehicle on paved or gravel areas away from pens, pastures, or areas where animals may be held to avoid contact with dirt, urine, blood, litter, wastewater or manure.
- Wash hands with soap and potable water or use antibacterial wipes or gel before entering the site.
- The facility staff may request that the EPA personnel’s vehicle tires be disinfected prior to entering the facility.
- On entering a facility, inform a responsible facility representative of any and all other livestock and poultry facilities visited within the previous 48 hours and whether you entered any animal confinement or waste storage areas.
- Discuss appropriate biosecurity measures with the owner/operator. Facility operators may have adopted more stringent biosecurity measures (e.g., showering and changing clothes to come on to or leave the premises). **EPA personnel are encouraged to adopt more stringent measures, as appropriate, into the procedures for that specific facility.**
- Do not enter pens or buildings where animals are housed or confined.
- EPA personnel should only enter animal confinement areas if it is essential to complete the goals of the visit, and should be accompanied by or authorized to do so by the facility operator.
- Avoid contact to the extent possible with livestock, poultry or other animals (wild or domestic) on any facility.

EPA personnel should follow the appropriate level of biosecurity procedures outlined below depending on the type and circumstances of the planned visit.

ACTIVITIES APPROPRIATE BY RISK LEVEL

Level 1 Visits: Visits to Farms/Ranches That Entail Only Office or Home Visits

In addition to the requirements for visits described in sections 2.4.3.1 and 2.4.3.2, for Level 1 visits:

- Wear clean, steel-toed shoes or boots that can be rinsed and washed with disinfectant (e.g., avoid wearing suede).
- After the visit, inspect shoes prior to entering the vehicle. Clean shoes or boots if they became contaminated with urine, blood, wastewater, or manure, according to decontamination procedures.

After the visit, follow the procedures in sections 2.5 and 2.6 as appropriate.

Level 2 Visits: Visits To Farms/Ranches With Minimal Contact With Livestock

In addition to the requirements for visits under sections 2.4.3.1 and 2.4.3.2, for Level 2 visits:

- Upon arrival and exiting the vehicle, put on new plastic or disinfected rubber boots or other footwear that has been cleaned and disinfected or wear new disposable boot covers. The operator may supply boots, boot covers, or other PPE for you to wear.
- EPA personnel are encouraged to wear disposable coveralls to prevent contamination of clothing. This decision should be made on a case-by-case basis.

After the visit, follow procedures in sections 2.5 and 2.6 as appropriate.

Level 3 Visits: Visits To Facilities With Close Contact

In addition to the requirements for visits under sections 2.4.3.1 and 2.4.3.2, for Level 3 visits:

- Upon arrival and exiting the vehicle, put on new plastic or disinfected rubber boots or other footwear that has been cleaned and disinfected or wear new disposable boot covers. The operator may supply boots, boot covers, or other PPE for you to wear.
- Put on a pair of new disposable or clean coveralls for each visit if personnel will have, or there is a reasonable expectation of, close contact with livestock/poultry (walking through narrowly confined pens/lots where animals are within reach).
- When entering areas where animals will be within reach, personnel should consider wearing disposable gloves and hair nets.
- After visiting areas in which animals are in close proximity, EPA personnel may remove disposable items and resume the inspection in apparel appropriate for the remainder of the visit.

After the visit, follow procedures in sections 2.5 and 2.6 as appropriate.

PROCEDURES AT THE COMPLETION OF THE VISIT

- If not discussed earlier, at the end of the visit, inform the operator of the areas of the site that were visited, and the biosecurity procedures followed.
- Non-disposable items
- At the end of the visit, remove any non-disposable boots/coveralls and, where appropriate, clean and disinfect on-site using decontamination procedures (2.4).
- If non-disposable items are not cleaned and disinfected on-site, place them in the “dirty” area of the vehicle in a manner that minimizes contamination of the vehicle to be cleaned and disinfected later. For example, place “dirty” items together in a covered plastic tub.
- Disposable items
- Place all soiled disposable items in plastic garbage bags and close securely.
- If the outside of the garbage bag became contaminated, wash it off and decontaminate the outside of the bag according to decontamination procedures (2.4).
- If acceptable to the owner/operator, leave the plastic bag with soiled disposable items on-site for disposal.
- If it is not possible to leave the bag on-site, ensure the bag is closed securely, double bag it, and place it in the “dirty” area of the vehicle.
- If the vehicle or tires became contaminated with dirt, urine, blood, wastewater, or manure, wash and disinfect vehicle tires and wheel wells at a location on-site designated by the owner/operator if possible.
- If it is not possible to wash and disinfect the vehicle or tires completely on-site, take the vehicle to a car wash before taking the vehicle to another facility. Record when and where the car was washed in the vehicle logbook.
- Wash your hands with soap and potable water or use antibacterial wipes or gel before leaving the site.

PROCEDURES FOR THE END OF THE DAY

EPA personnel should follow the procedures below after all visits to livestock or poultry facilities have been completed for the day.

- If it was not possible to leave used, disposable items at the facility where they were used, return the double bagged garbage bag to the pre-selected location for disposal (i.e., EPA or state agency facility) or other location identified through consultation with appropriate Health and Safety staff.
- While it is highly unlikely that any medical or hazardous wastes would be created, if these types of wastes were created, EPA personnel should follow prearranged procedures for handling, storage and disposal (see section 2.4.3.1).
- Clean/laundry all reusable clothing in hot water with a disinfectant soap.

- Clean and disinfect equipment according to decontamination procedures.
- Take a shower.
- Check and replenish supplies as necessary to ensure all needed supplies are ready for the next visit.

Appendix AG – Field and Personal Protective Equipment

FIELD AND PERSONAL PROTECTION EQUIPMENT

Table AG-1 presents a quick reference guide to field and personal protection equipment (PPE) that should be considered, as appropriate, for inspections and sampling events.

Table AG-1. List of Field and PPE Equipment

Field Equipment	
<p>Documents and Recordkeeping Tools</p> <ul style="list-style-type: none"> • Credentials • Facility File • Inspection Checklists • Log book • Field notebook • Shipping labels • Analysis request forms • Waterproof pen • Calculator • QAPP & Sampling plan • Copy of Permit • Previous Inspection Report • Extra Inspection Checklists • Compliance Assistance Materials (Factsheets, BMP guidance) 	<p>Protective Clothing¹</p> <ul style="list-style-type: none"> • Bump hat • Disposable boot covers • Hearing protection • Safety shoes (waterproof) • Disposable gloves • Protective suit • Reflective safety vest • Safety glasses/goggles • Rainwear • Climate-appropriate outerwear • Change of clothes
<p>Sampling Materials</p> <ul style="list-style-type: none"> • Prepackaged sampling kit, if available • Sample containers, including extras • Batteries/extension cords • Sample bottle labels/sample seals • Plastic security tape • Chain-of-custody forms • Dissolved oxygen meters • pH meter • Deionized water • Chart paper • Thermometer • Coolers/ice • Preservatives • Directions to laboratory • Shipping labels 	<p>Safety Equipment¹ /Miscellaneous</p> <ul style="list-style-type: none"> • First-aid kit • Extra batteries • Sunscreen • Insect repellent • Paper mask • Backpack • Clip board • Water/Fluids • Sun hat • Binoculars • Road Map • Emergency contact information
<p>Sample Transportation Materials</p> <ul style="list-style-type: none"> • Bubble pack material • Filament tape • Air bill/bill of lading 	<p>Tools</p> <ul style="list-style-type: none"> • Multi-tooled jack knife (Swiss Army type) • Electrical and duct tape • Tape measure

Field Equipment	
<p>Flow Measurement Devices</p> <ul style="list-style-type: none"> • Measurement devices (e.g., flumes, weirs, portable ultrasound or bubble systems) • Flow discharge tables • Level • Ruler • Stopwatch or watch with second hand 	<ul style="list-style-type: none"> • Hand-held range finder and level • Digital camera and extra memory card • Flashlight • Screwdriver • Adjustable wrench and vise grips • Bucket (plastic or stainless steel, as appropriate) • Nylon cord • GPS • Laptop computer • Cell phone and charger • Navigation systems • Pens/pencils • Extra paper • Portable scanner
<p>Biosecurity – Clothing, PPE</p> <ul style="list-style-type: none"> • Plastic coveralls (disposable outerwear) or cloth coveralls • Standard steel-toed safety boots with disposable boot covers • Disposable gloves (e.g., nitrile, or vinyl) • Hair nets • Filtering face piece (respiratory protection beyond this is not anticipated but if necessary, would require additional supplies and procedures) • Safety glasses with impact protection • Hardhats 	<p>Biosecurity – Supplies</p> <ul style="list-style-type: none"> • Water container(s) for potable water • EPA-approved disinfectant and relevant safety data sheets (SDS) • Spray bottle for disinfecting small items • Pump sprayer for disinfecting large items • Long-handled brush • Trash bags and zip-lock bags • Paper towels • EPA-approved soap or antibacterial wipes or products • Bucket • Duct tape to secure plastic boot covers, coveralls, etc. • Waste containers for storing disinfectant rinsate, other liquid waste • Plastic tub for storing “dirty” equipment and PPE in the vehicle • Insect repellent • First aid kit, including tick removal tool

¹ List of Protective Clothing and Safety Equipment is not limited to only Sampling Inspections.

Appendix AH – Mapping Tool (Region 5)

U.S. EPA REGION 5 FACILITY MAPPING PROTOCOL AND WEATHER DATA SOURCES

When provided with a name and address, look up the coordinates of a facility using Terraserver. Latitude/longitude can also be found with Google Earth.

Create an ArcMap project that has these layers:

- NAIP (National Agriculture Imagery Program)
- NHD Flowlines (National Hydrography Dataset)
- DRG (Digital Raster Graphic)
- Bing Maps Aerial Hybrid Layer
- 303d and 305b (Impaired and Assessed Waters)
- County Street Map or other roads layer
- Existing universe of CAFOs shapefile (It helps to have this layer on to make sure a new facility hasn't already been mapped).

Zoom to the coordinates of the facility.

If a facility does not have a waterway flowing through it, use the distance tool and the DRG to measure the distance to the nearest NHD line following drainage contours on the DRG. If the first NHD line is categorized as "Intermittent", highlight the stretch of waterway path in the NHD layer until it gets to a perennial stream. From those selected stream reach portions, the length (in kilometers) can be summed in the attribute table. Multiply the summed length by 0.62 to get the length in miles to the perennial waterway. Note the direction of the flow off the facility and the distances.

Also make note of the county, impairments and reasons for impairments (if impaired), whether the waterway has been assessed, the road or intersection, and location of nearest town.

Make two maps for each facility, one is zoomed out and one is zoomed in.

The zoomed out map shows enough detail to identify the facility in relation to the closest perennial waterway. Aerial imagery is the background and NHD, 303d and/or 305b are displayed. The facility is identified with a callout box. In the callout box, the flow direction off the facility and distances (to intermittent and perennial) are listed. The title of the map has the facility name and address (if known), the county, the latitude/longitude, and any other location information to help one find the facility when out on the road.

The zoomed in map is zoomed in enough to only display the facility. The callout box is left on this map, but moved to where it is not covering any facility structures. This map is the one that can be used during the inspection to identify the name of each structure, etc.

Rainfall Frequency Tables, Average Annual Rainfall, and Historic Climate Data

Updated 06/18/13

**** Some of these links work better with a browser other than Internet Explorer ****

Rainfall Frequency

For a given "Rainfall Event", like a 5 year / 2-hour storm, there is a certain amount of rain that would need to fall in that timeframe to be considered a storm of that magnitude.

These rainfall amounts are dependent on where in the country you are located.

There are tables created by NOAA for listing the precipitation frequencies for each state. The document that contains these tables is called NOAA Atlas 14. It was created in 2004 and revised in 2006. There are different volumes of the Atlas for different states. If you want to view the pdf of the atlas for your state, use this link: <http://www.weather.gov/oh/hdsc/currentpf.htm>

You can use the NOAA Atlas 14 document directly, but it is much easier to use the Precipitation Frequency Data Server. NOAA's Precipitation Frequency Data Server gives output based on the NOAA Atlas for Precipitation Frequency. This is the link for the Precipitation Frequency Data Server: <http://hdsc.nws.noaa.gov/hdsc/pfds/index.html>

When you open the webpage, leave the default settings for DATA DESCRIPTION. Click on the map in the desired state, and then move the red crosshair to the observation site (or anywhere on the map), scroll to the bottom of the webpage and the server will give you a table for the different rainfall events.

Average Rainfall and Climate Normals

Climate normals are the averages in weather parameters. They were recently updated. The climate normals are calculated on a 30-year average and are updated every 10 years. The new normals, which use the climate data from 1981-2010, were released on July 1, 2011 by the National Climate Data Center.

The NOAA site to get this data is:

<http://www.ncdc.noaa.gov/land-based-station-data/climate-normals/1981-2010-normals-data>

First choose whether you want Monthly, Daily or Annual/Seasonal Normals. Then choose the state and city of interest.

(You can also access the old 1971-2000 Normals by clicking on the link on the front page. If you want the Daily Normals, click on the Daily Station Normals 1971-2000 (CLIM84) product and search by your location. If you want monthly and annual normals, click on the Monthly Station Normals 1971-2000 (CLIM81) product and find your location.)

Historic Climate Data

Historic climate data beginning the week of April 9, 2012, this data is now free.

For historic climate data, including rainfall, snowfall, and temperature use NOAA's National Centers for Environmental Information. There is a lag of time between the actual date in question and the date that the information is posted on NCEI. This is due to the quality control checks that NCEI performs on the data. NCEI's main website is:

<http://www.ncdc.noaa.gov/oa/ncdc.html>

To access climate data, go to the website link, above. Once at this website, on the blue banner on the top, click on the Data Access link and then on the Quick Links link. The 23 sections have links for different publications/information. Some of the more popular items one would need are listed below.

Weather Data for One Day or One Month for One Location

In Section 1: "U.S. Local Climatological Data" click on the first link "Quality Controlled Local Climatological Data (QCLCD). Once you click on the "Quality Controlled Local Climatological Data" link, choose the state that you want data for and press Continue. Then Select Desired Station from the choices in the menu. These usually relate to airports, public works offices, or larger cities.

Then choose the desired Year and Month. The next page will allow you to choose one day in that month or choose "E" for the entire month. You also have the option to switch from Daily to Hourly Product.

Note the links in Section 1 for data older than 2005.

Weather Data for the Month or Year for One State

In Section 6: "Climatological Data Publication" you can get the Monthly or Annual reports for one state. After deciding if you need the Individual Monthly Issue or the Individual Annual Issue, follow the menu prompts for your state of interest to get the climate summary from all reporting stations in that state. The next page that comes up will contain a link to the pdf of that report. Click on the link and save the pdf to your computer, renaming it if you desire.

If you are interested in only one site in the Annual Report, you need to first find what division number is associated with your site. One of the last pages will have a map of the state broken up into numbered divisions. Find out which division your site is located in. From the beginning of the report, scroll through the pages until you see a heading for that division. Choose one of the reporting stations within that division.

In the Annual Report, there will be sections for monthly information for:

- Total Precipitation and Departures from Normal
- Average Temperatures and Departures from Normal
- Temperature Extremes and Freeze Data
- Monthly and Seasonal Cooling Degree Days
- Soil Temperatures
- Total Pan Evaporation and Wind Movement (not usually complete for all stations)

Storm Data and Unusual Weather Phenomena

In Section 5, you can get reports by month of severe storm events. The reports have all the states listed and the state data is broken up by region (Central, Northwest, etc.) and county. It will list the date of the event, time, damage done to property and crops and the character of the storm.

Hourly Precipitation Data

In Section 7, you can get a statewide listing by month of the hourly precipitation reports.

Weather Data from National Weather Service

For recent weather that has not been archived, like within the past few months, there are numerous web-sites that make this available. Realize that the weather data is not “official” until it has been quality control checked by NCDC, though.

One website that you can use is the National Weather Service. <http://www.weather.gov/>

Click on the map in the location you are interested in and the website will navigate to the page of the Weather Forecast Office for that area. On the left hand side of the page will be a link for the Local Climate. Clicking on that link brings you to a page that gives you a choice of products, a location and the timeframe of the weather data you want.

The first product, the Daily Climate Report, is what you would use to see the temperature, precipitation, and other weather conditions on that one day. There are other products that may be of better use, depending on what you are looking for.

The locations offered on this page are the locations that are certified by the National Weather Service. You may not be able to get all products for all the locations.

Appendix AI – Sample Permitted CAFO Inspection Checklist

SAMPLE PERMITTED CAFO INSPECTION CHECKLIST PERMITTED CAFO SITE INSPECTION FORM

GENERAL INFORMATION:

NPDES Permit No.:	NPDES Permit Expiration Date: __/__/__
Facility ID # _____	Inspector _____
Facility Name _____	Date _____
Facility Owner _____	Time in _____
Facility Operator _____	Time out _____
Mailing Address _____ _____	Weather _____
Physical Address _____ _____	GPS Reading (at gate) North _____
County _____	²⁸ West _____
Contact Person _____	Section _____
Phone (office) _____ (cell) _____	Township _____
(fax) _____	Range _____
E-mail _____	Does the facility owner/operator own and/or operate any other animal feeding operations? Y or N
Persons Present During Inspection _____ _____ _____	If yes provide name(s) and address(es) and indicate whether the facility is an AFO or a CAFO _____ _____ _____

²⁸ Longitude reading should be a negative number (i.e., -105.2356).

Max. Animals Confined per Month _____ Max. Capacity of Facility _____ Permitted Capacity of Facility _____ Number of animals today (all animals in production area):	Location and name of nearest surface water ²⁹ and description of flow path _____ _____ _____		
	# confined		# confined
Cattle		Sheep	
Dairy mature		Dairy heifers	
Swine (≥55#)		Swine (<55#)	
Turkeys		Laying hens	
Other chickens		Other (specify)	
<input type="checkbox"/> Presented credentials? (check if yes)			
<input type="checkbox"/> Aerial image attached? (check if yes) Source and date: _____			
<input type="checkbox"/> Inspection photos attached? (check if yes)			
<input type="checkbox"/> Potential compliance issues? (check if yes and summarize below)			
_____ _____ _____ _____ _____ _____			

²⁹ Surface water means all waters of the United States.

INSPECTION OBSERVATIONS:

Production Area						
1. List impoundments (attach additional sheet(s), if needed)						
Impoundment ID	Wastewater Type	Wastewater Source(s)	Pumping level ³⁰ (from staff gauge)	Wastewater below pumping level?	Max. recorded level	Date of max. recorded level
	<input type="checkbox"/> process generated <input type="checkbox"/> runoff			Y or N		
	<input type="checkbox"/> process generated <input type="checkbox"/> runoff			Y or N		
	<input type="checkbox"/> process generated <input type="checkbox"/> runoff			Y or N		
	<input type="checkbox"/> process generated <input type="checkbox"/> runoff			Y or N		
	<input type="checkbox"/> process generated <input type="checkbox"/> runoff			Y or N		
	<input type="checkbox"/> process generated <input type="checkbox"/> runoff			Y or N		
	<input type="checkbox"/> process generated <input type="checkbox"/> runoff			Y or N		
2. Impoundment(s) collect all runoff from:						
Y N n/a	Animal confinement areas? ³¹					
Y N n/a	Manure storage areas? ³²					
Y N n/a	Raw material storage areas? ³³					
Y N n/a	Waste containment areas? ³⁴					
Y N n/a	Egg washing or egg processing facility?					
Y N n/a	Mortality storage, handling, treatment or disposal area?					

³⁰ The pumping level represents the minimum capacity necessary to contain runoff and direct precipitation from the 25-year, 24-hour rainfall event (40 CFR Part 412.37(a)(2)).

³¹ Animal confinement area includes but is not limited to open lots, housed lots, feedlots, confinement houses, stall barns, free stall barns, milkrooms, milking centers, cowyards, barnyards, medication pens, walkers, animal walkways, and stables (40 CFR Part 122.23(b)(8)).

³² Manure storage area includes but is not limited to lagoons, runoff ponds, storage sheds, stockpiles, under house or pit storages, liquid impoundments, static piles, and composting piles (40 CFR Part 122.23(b)(8)).

³³ Raw materials storage area includes but is not limited to feed silos, silage bunkers, and bedding materials (40 CFR Part 122.23(b)(8)).

³⁴ The waste containment area includes but is not limited to settling basins, and areas within berms and diversions which separate uncontaminated storm water (40 CFR Part 122.23(b)(8)).

Y N n/a	Other? (describe): _____ <ul style="list-style-type: none">• If no, describe non-retained areas: _____ _____
Y N n/a	3. Was manure or wastewater observed in a waterway? If yes, describe: _____ _____
Y N n/a	4. Adequate storage available for manure, litter, and process wastewater, and procedures are in place to ensure proper operation and maintenance of the storage facilities? [Part 122.42(e)(1)(i)]] _____ _____
Y N n/a	5. Confined animals do not have direct contact with waters of the United States? [Part 122.42(e)(1)(iv)] _____ _____
Y N n/a	6. Clean water is diverted from the production area? [Part 122.42(e)(1)(iii)] _____ _____
Production Area (continued)	
Y N n/a	7. Chemicals and other contaminants handled on-site are not disposed of in any manure, litter, process wastewater, or storm water storage or treatment system? [Part 122.42(e)(1)(v)] _____ _____
<i>Additional Production Area Requirements for Large Dairy Cow, Cattle, Swine, Poultry, and Veal Calf CAFOs (Subparts C and D)</i>	
Y N n/a	8. All open surface impoundments and terminal storage tanks have depth markers which clearly indicate the minimum capacity necessary to contain the runoff and direct precipitation of the 25-year, 24-hour rainfall event? [Part 412.37(a)(2)] _____ _____

Y N n/a 9. Mortalities remain on the production area until disposal, are not disposed in liquid manure or process wastewater treatment systems, and are handled to prevent discharge of pollutants to surface waters? [Part 412.37(a)(4)]

Production area comments:

Land Application Sites

Y N n/a 10. Does the facility apply manure or wastewater to land owned by or under the operational control of the CAFO?

- Number of land application sites:

- Irrigation type(s):

- Furrow/flood irrigation sites – what is fate of applied wastewater and tailwater?

Y N n/a 11. Was manure/wastewater applied in accordance with the procedures and protocols identified in the NMP? (*spot check records for one for one field to complete the information below.*)

If no, describe:

Field ID:		Acreage:		P Index:		Calculations based on: <input type="checkbox"/> N or <input type="checkbox"/> P	
		Calculated*		Applied			
		Gal. or Tons (specify)	Lbs. N or P	Gal. or Tons (specify)	Lbs. N or P		
Rates of application:	Liquid						
	Slurry						
	Solid						
Total Lbs. N or P that may be applied and that were applied:							
*If rates are calculated for more than one form, are the rates <input type="checkbox"/> additive (e.g. slurry <i>and</i> solid) or <input type="checkbox"/> exclusive (e.g., slurry <i>or</i> solid)?							

*****Copy record(s) including rate calculations, land application records and any other relevant documentation.*****

Land application site comments:

Land application site comments (continued):

Monitoring, Documentation and Recordkeeping

Does the facility maintain records of the following for 5 years?

- Y N n/a 12. The completed permit application? [Part 412.37(b)]
- Y N n/a 13. The current design of manure storage structures, including volume of solids accumulation, design treatment volume, total design volume, and approximate number of days of storage capacity? [Part 412.37(b)(5)]
- Y N n/a 14. The date, time, and estimated volume of any overflow? [Part 412.37(b)(6)]
- Y N n/a 15. Manure and process wastewater transfers, including the most current nutrient analysis of the manure or wastewater that was provided to the recipient, the date and approximate amount transferred, and the name and address of the recipient? [Part 122.42(e)(3)]
 - Y N n/a a. Name of recipient
 - Y N n/a b. Address of recipient
 - Y N n/a c. Date of transfer
 - Y N n/a d. Approximate amount transferred (tons/gallons)
 - Y N n/a e. Recent (12 months or less) manure nutrient analysis provided

Additional Production Area Records for Large Dairy Cow, Cattle, Swine, Poultry, and Veal Calf CAFOs

- 16. Documentation of daily and weekly visual inspections of the production area, including:
 - Y N n/a a. Weekly inspection of stormwater diversions, waste storage structures, and process wastewater channeling devices? [Part 412.37(b)(1)]
 - Y N n/a b. Daily inspection of water lines? [Part 412.37(b)(1)]
 - Y N n/a c. Weekly inspection of impoundments and tanks? [Part 412.37(b)(1)]
- Y N n/a 17. Weekly records of the depth of manure and process wastewater in liquid impoundments and terminal tanks? [Part 412.37(b)(2)]
- Y N n/a 18. Documentation of actions taken to correct deficiencies found as a result of production area inspections? [Part 412.37(b)(3)]

Nutrient Management Plan (NMP)

Required NMP Element [Part 122.42(e)(1)]

- Y N n/a 30. Is the facility’s NMP available on-site? Does it reflect the current operational characteristics and practices? [Part 122.42(e)(2)(ii)]
Date developed or last revised: _____
- Y N n/a 31. Ensure adequate storage of manure and process wastewater, including operation and maintenance procedures.
- Y N n/a 32. Ensure proper management of animal mortalities.
- Y N n/a 33. Ensure that clean water is diverted, as appropriate, from the production area.
- Y N n/a 34. Prevent direct contact of confined animals with surface waters.
- Y N n/a 35. Ensure proper disposal of chemicals and other contaminants.
- Y N n/a 36. Identify site-specific conservation practices to control runoff of pollutants
- Y N n/a 37. Identify protocols for manure, process wastewater, and soil sampling and testing.
- Y N n/a 38. Establish protocols to land apply manure or process wastewater in accordance with site-specific nutrient management practices that ensure appropriate agricultural utilization of the nutrients in the manure, litter, or process wastewater.
- Y N n/a 39. Identify specific records that will be maintained to document the implementation and management of the minimum NMP elements (#36-#43 above).

Additional NMP Requirements for Large Dairy Cow, Cattle, Swine, Poultry, and Veal Calf CAFOs

- Y N n/a 40. Application rates are calculated as required by Part 412.4(c)(2)
- Y N n/a 41. Specifies the manure, process wastewater, and soil sampling at the required frequencies and for the required parameters? [Part 412.4(c)(3)]
(manure/wastewater annually for P & N, soils at least every 5 years for phosphorus transport)
- Y N n/a 42. Includes periodic inspection of land application equipment? [Part 412.4(c)(4)]

FACILITY MAP

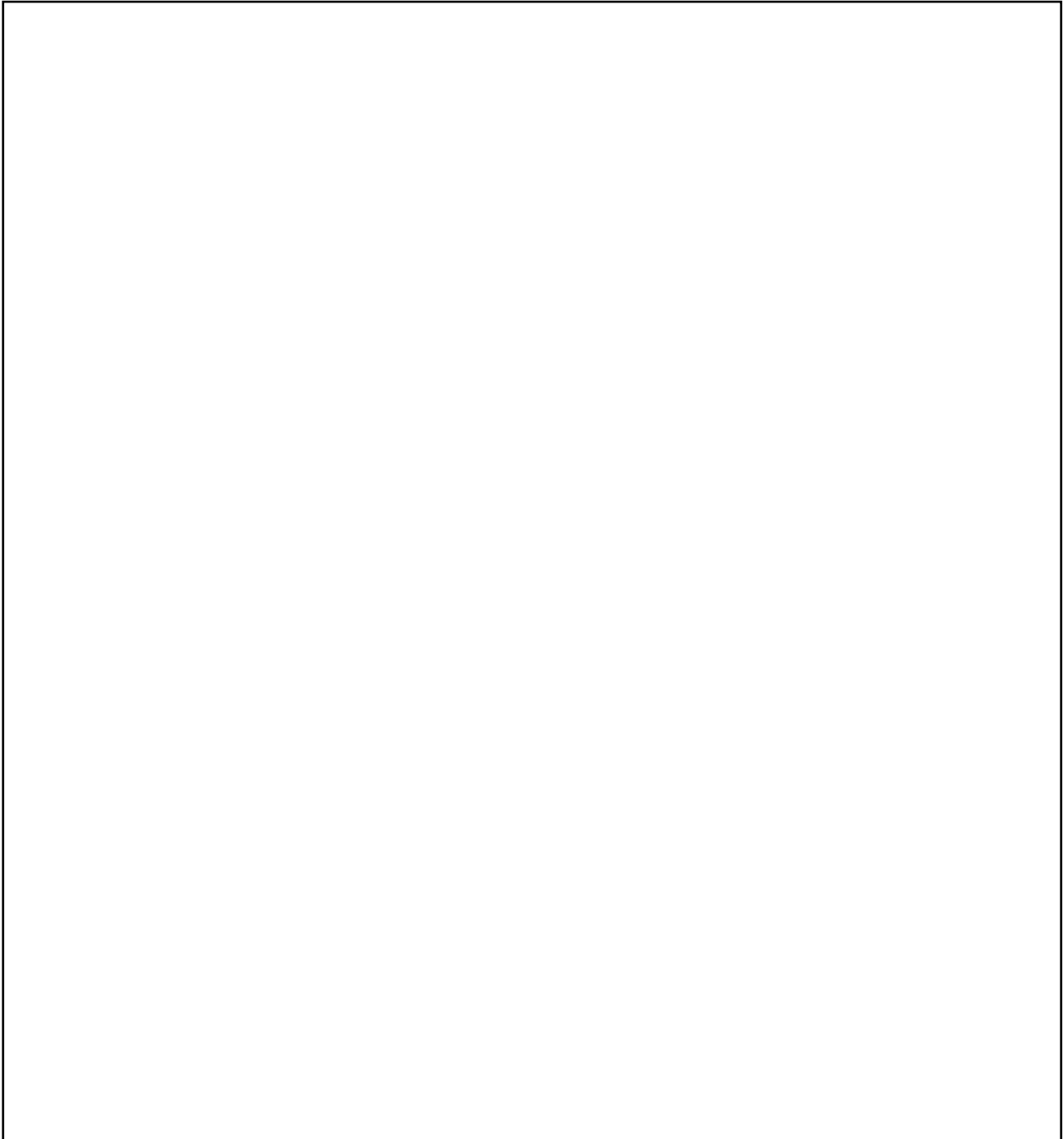

Inspector: _____

Date: _____

Date Inspection Report was Finalized: _____

Date Report was Sent to Facility: _____

Appendix AJ – Regional Inspections Checklists

REGIONAL INSPECTION CHECKLIST

<p>PROGRAM YEAR 2011</p> <p>GEORGIA DEPARTMENT OF AGRICULTURE LIVESTOCK/POULTRY FIELD FORCES AFO/CAFO INSPECTIONS</p>	<div style="font-size: 48px; color: green; font-weight: bold; margin: 0;">LAS</div> <div style="display: flex; justify-content: center; gap: 20px; margin-top: 10px;"> D S CL </div>
GENERAL INFORMATION:	
Inspector's Name: _____ Inspector's Number: _____	
GDA Est #: _____	Landowner's Name: _____ Date: _____
Landowner's Mailing Address: _____ County: _____	
City: _____	State: _____ Zip: _____ Phone#: _____
Farm Name: _____	Person Permit Issued to: _____
Farm Physical Address: _____	
City: _____	Zip: _____ County: _____ Phone#: _____
Landowner's E-mail: _____	Operator's E-mail: _____
Certified Animal Feeding Operator: _____	Certification #: _____
Operator's Mailing Address: _____	
Copy of Certificate on-site: <input type="checkbox"/> Yes <input type="checkbox"/> No	# Hours of Continuing Education Last Year: _____
Documentation for Continuing Education provided to GDA: <input type="checkbox"/> Yes <input type="checkbox"/> *No	
<i>Comments:</i>	
RECORDS:	
NPDES Permit # _____	Copy of Permit on-site <input type="checkbox"/> Yes <input type="checkbox"/> *No
Has Permit been extended: <input type="checkbox"/> Yes <input type="checkbox"/> *No	Copy of Permit Extension on-Site: <input type="checkbox"/> Yes <input type="checkbox"/> *No
NPDES Annual Report Submitted letter on-site: <input type="checkbox"/> Yes <input type="checkbox"/> *No	Date Submitted: _____
Size and Type of Operation: <input type="checkbox"/> Swine <input type="checkbox"/> Dairy <input type="checkbox"/> Commercial Layer	
Does this CAFO have an approved NMP? <input type="checkbox"/> Yes <input type="checkbox"/> *No <input type="checkbox"/> Pending (only if NMP is submitted)	
Date of NMP approval by EPD: _____	Copy of approved NMP on-site: <input type="checkbox"/> Yes <input type="checkbox"/> *No
Has farm completed an annual assessment of NMP? <input type="checkbox"/> Yes <input type="checkbox"/> *No	

Date of last Calibration?	Attach Copy of Annual Calibration		
Specify Type of Dry Manure Application Equipment: <input type="checkbox"/> N/A			
Is Equipment? <input type="checkbox"/> Owned <input type="checkbox"/> Rented or Leased <input type="checkbox"/> Custom Applied			
Date of last Calibration?	Attach Copy of Annual Calibration		
Solids Separator: <input type="checkbox"/> Yes <input type="checkbox"/> No	Pad Type:	<input type="checkbox"/> Open Area	<input type="checkbox"/> Under Shelter
Is storage pad area covered, bermed, curbed, and guttered, or buffered? Describe.			
Are record available showing maintenance of application equipment? <input type="checkbox"/> Yes <input type="checkbox"/> *No			
Comments:			

SOIL/WASTE WATER/MANURE/MONITORING WELL TESTING:	
Date, time, exact location, and name of person responsible for most recent manure and waste water sampling, soil sampling, and monitoring well sampling.	
Manure:	Testing
Waste Water:	Testing
Soil:	Testing
Monitoring Well:	Testing
Semiannual manure, separated solids, waste water analysis. <input type="checkbox"/> Yes <input type="checkbox"/> *No	
Records of annual soil sampling of each application field. <input type="checkbox"/> Yes <input type="checkbox"/> *No	
Does the annual soil sampling report include soil pH and soil test? Phosphorus level measured by Mehlich-1 Extraction or Double Acid? <input type="checkbox"/> Yes <input type="checkbox"/> *No	
Are Records on-site showing date, name, and address of recipients, quantity of manure and nutrient analysis of manure transferred to others? <input type="checkbox"/> Yes <input type="checkbox"/> *No <input type="checkbox"/> *N/A	
Comments:	
MONITORING WELLS:	
Are the monitoring wells shown on the NMP Maps? <input type="checkbox"/> Yes <input type="checkbox"/> *No	
If no, has plan for installation of monitoring well been submitted? <input type="checkbox"/> Yes <input type="checkbox"/> *No	
Does the facility have monitoring wells for each waste water system? <input type="checkbox"/> Yes <input type="checkbox"/> *No	

Does the facility have a monitoring well down gradient of lagoon/storage pond?	<input type="checkbox"/> Yes	<input type="checkbox"/> *No
Does monitoring well records show Nitrate Nitrogen level greater than 10ppm?	<input type="checkbox"/> Yes	<input type="checkbox"/> *No
What were the results for last year? (2) and dates taken.	<input type="checkbox"/> Yes	<input type="checkbox"/> *No
Describe any actions taken to reduce level of Nitrate Nitrogen.		
Comments:		
EMERGENCY ACTION PLAN:		
Does this operation have an Emergency Action Plan?	<input type="checkbox"/> Yes	<input type="checkbox"/> *No
Is the plan included in the NMP?	<input type="checkbox"/> Yes	<input type="checkbox"/> *No
Are Emergency numbers posted for all employees to attain?	<input type="checkbox"/> Yes	<input type="checkbox"/> *No
Emergency Operations Center 24 Hour Spill Reporting should be contacted to report overflow and discharges in cases where EPD District Office personnel are not available. Spill Reporting Telephone Number is (800) 241-4113		
Comments:		
ANIMAL MORTALITY:		
Describe the animal mortality plan for this operation:		
Has a soil investigation been conducted for the disposal site? If "no", give the date that investigation is to be performed:	<input type="checkbox"/> Yes	<input type="checkbox"/> No
Does this facility have a catastrophic mortality disposal plan?	<input type="checkbox"/> Yes	<input type="checkbox"/> *No
Does facility have verification of approved burial site?	<input type="checkbox"/> Yes	<input type="checkbox"/> *No
Comments:		
OUTSIDE INSPECTION		
MEDICAL/CHEMICAL BY-PRODUCT DISPOSAL:		
Does this operation have a disposal plan for disposing of medical and/or chemical waste and preventing introduction into manure or wastewater except when used in accordance with the product label?	<input type="checkbox"/> Yes	<input type="checkbox"/> No
If "yes" briefly describe method?		
Is there evidence of oil, petroleum based products, or chemical spills on-site?	<input type="checkbox"/> Yes	<input type="checkbox"/> No

Comments:	
MONITORING WELL:	
Are monitoring wells being maintained properly and kept free of grass, weeds, and animal burrows? <input type="checkbox"/> Yes <input type="checkbox"/> No	
Are the monitoring wells installed in location on maps? <input type="checkbox"/> Yes <input type="checkbox"/> No*	
Comments:	
ANIMAL MORTALITY:	
Does it appear that animal mortality disposal through observation meets current Department of Agriculture Rules? <input type="checkbox"/> Yes <input type="checkbox"/> No	
Comments:	
DIVERSION OF CLEAN WATER:	
Is storm water diverted from waste water impoundment? <input type="checkbox"/> Yes <input type="checkbox"/> No	
If "yes", are the diversion provisions being properly implemented and maintained? <input type="checkbox"/> Yes <input type="checkbox"/> No	
If "no", is the runoff being collected and is the storage volume of waste water impoundment designed to contain the runoff? <input type="checkbox"/> Yes <input type="checkbox"/> No	
Is runoff from open lots, holding pens, and loafing areas buffered or diverted into the waste water storage system? <input type="checkbox"/> Yes <input type="checkbox"/> No	
Are steps being taken to prevent water wastage? <input type="checkbox"/> Yes <input type="checkbox"/> No	Is the facility recycling? <input type="checkbox"/> Yes <input type="checkbox"/> No
Do livestock have access to surface waters on the farm while in confinement? <input type="checkbox"/> *Yes <input type="checkbox"/> No	
Is all waste water diverted into the waste water impoundment? (including hoof wash, parlor, holding areas, etc.). <input type="checkbox"/> Yes <input type="checkbox"/> *No	
Comments:	
WASTE WATER IMPOUNDMENT STRUCTURE:	GPS: N W
Is embankment(s) grassed, free of erosion, rodent tunnels, cracks or other damage? <input type="checkbox"/> Yes <input type="checkbox"/> *No	
If "no" describe:	
Is embankment free of woody vegetation, briars, etc. <input type="checkbox"/> Yes <input type="checkbox"/> *No	
Date of last brush and/or weed control (mowing, spraying, etc.) of the embankment:	
Does waste water impoundment have a permanent depth marker with? maximum liquid level indicated? <input type="checkbox"/> Yes <input type="checkbox"/> *No	
Estimated number of inches between liquid level and lowest point on top of berm/embankment/dam at the time of inspection:	
Is liquid level at time of inspection above or below maximum liquid level stated in NMP? <input type="checkbox"/> *Above <input type="checkbox"/> Below	
Is this waste water storage structure a zero discharge structure? <input type="checkbox"/> Yes <input type="checkbox"/> *No	
Does it appear that the waste water storage structure has had a recent overflow? <input type="checkbox"/> *Yes <input type="checkbox"/> No	

If "yes", was the overflow the result of a chronic or catastrophic event?		<input type="checkbox"/> Yes	<input type="checkbox"/> No
Describe the event; include date, time and estimated amount of volume:			
If overflow resulted in a discharge, give test results of the BODS and TSS levels:			
Liquid level before overflow:		Liquid level after overflow:	
<p style="color: red;">If, for any reason, there is a discharge of pollutants to a water of the US, the permittee is required to make immediate oral notification within 24-hours to the local Division District Office (or, if after office hours, the Georgia Department of Natural Resources Emergency Operations Center, 1-800 -241-4113) and notify the Division District Office in writing within five (5) working days of the discharge from the facility.</p>			
Comments:			
APPLICATION EQUIPMENT & LAND APPLICATION SITE:			
Is Liquid Manure Application Equipment?	<input type="checkbox"/> Owned	<input type="checkbox"/> Rented/Leased	<input type="checkbox"/> Custom
Is Dry Manure Application Equipment?	<input type="checkbox"/> Owned	<input type="checkbox"/> Rented/Leased	<input type="checkbox"/> Custom
Is there a vegetated buffer between the application fields and down?			
gradient surface waters, sinkholes, open tile line intake structures, etc.?		<input type="checkbox"/> Yes	<input type="checkbox"/> No
Estimated width of the vegetated buffer in feet:			
Are ditches, grassed waterways, terraces, diversions, swales or other water conveyance in the application fields?			
		<input type="checkbox"/> Yes	<input type="checkbox"/> No
Is land application of manure/waste water is being applied at agronomic rates?			
		<input type="checkbox"/> Yes	<input type="checkbox"/> No
Is there evidence of improper land application of manure and/or waste water in wet zones, such as wetlands, drainage ditches, flooded areas, applying during a rainfall event, on frozen field, or runoff entering streams?			
		<input type="checkbox"/> Yes	<input type="checkbox"/> No
If "yes" describe:			
Comments:			

The Georgia Department of Agriculture's review of the animal feeding operation does not relieve the operator from adherence to provisions and requirements contained in the Land Application System (LAS) or National Pollution Discharge Elimination System (NPDES) permit issued for the feeding operation or to rules and regulations issued by the Georgia Department of Natural Resources (DNR), Environmental Protection Division (EPD) and/or US Environmental Protection Agency (EPA).

Any violation identified on this inspection report must be addressed immediately and a completion date agreed to by the producer. Any violation that results in a discharge or damage to the "Waters of the State" will be reported immediately to the Department of Natural Resources, Environmental Protection Division.

Re-inspection Date: (If Needed) _____

_____	_____	_____
Farm Representative/Title	Date	GDA Representative

Inspection was reviewed for completeness and adequacy by: _____ Date : _____

Inspection was reviewed for completeness and adequacy by: _____ Date : _____

Inspection should have 2-A, Calibration Documentation and Inspection Summary attached.

Contacts:

Environmental Management District Offices:

Mountain District (Cartersville)	P.O. Box 3250, Cartersville, Ga 30120-1705	(770) 387-4900
West Central District (Macon)	2640 Shurling Drive, Macon 31211-3576	(478) 751-6612
Costal District (Brunswick)	400 Commerce Center Dr, Brunswick 31523-8251	(912) 264-7284
Southwest District (Albany)	2024 Newton Road, Albany 31701-3576	229) 430-4144
Northwest District (Athens)	745 Gaines School Rd, Athens 30605-3129	706) 369-6376
Northeast District (Augusta)	1885-A Tobacco Road, Augusta 30906-8825	706) 792-7744
Mountain District (Atlanta)	4244 International Parkway St 101, Atlanta, Ga 30354	404) 362-2671

A copy of this Report was mailed or e-mailed to the _____
District Office of EPD by _____
on (date) _____

A. GENERAL INFORMATION (Shaded boxes are for inspector to fill in independently)					
FACILITY NAME (LLC, Inc., Corp, Partnership, sole proprietorship, etc. If facility representative is unsure look under the Secretary of State's website to see if it is listed.)				INSPECTION DATE	ARRIVAL TIME
ADDRESS				INSPECTOR(S) INITIALS	DEPARTURE TIME
CITY	STATE		ZIP CODE	STATE INSPECTOR (if present)	
LEGAL DESCRIPTION (latitude and longitude)			COUNTY	TEMPERATURE	PRECIPITATION TYPE
Facility Owner(s) (Ask for formal name and obtain a business card, letter head or other documentation)	NAME			PHONE	
	NAME			PHONE	
Facility Operators (If different than the owner)	NAME			PHONE	
	NAME			PHONE	
Is the Animal Facility a CAFO? YES NO	CAFO Classification? (Medium or Large?)	CAFO Designation Date (If a designated CAFO)	Designation Reason (If a designated CAFO)		
TYPE OF OPERATION (Circle all that apply) BEEF CATTLE	NUMBER OF ANIMALS OF EACH TYPE (Present at time of inspection)	CAPACITY		TYPE OF CONFINEMENT (Open Lot, Partial or Total Confinement, Pasture)	

DAIRY (Mature and Dry) SWINE HEIFERS/CALVES TURKEYS CHICKENS OTHER				
1.	What number of animals are stabled/confined and feed/maintained for 45 days or more during a twelve-month period? Get documentation (computer records, daily records) for the past year that provides the number of animals on facility each month.			
2,	What are the minimum number of animals that you have had at this facility since the date of operation			
3.	What are the maximum number of animals that you have had at this facility since the date of operation			
4.	Do the animals have direct access to waters of the United States and/or its tributaries?	YES	NO	
5.	Does the facility have the ability to discharge livestock waste to waters of the US via a manmade conveyance?	YES	NO	
6.	Are any crops, vegetation, forage growth, or post-harvest residues sustained in the normal growing season over any portion of the lot or facility where animals are kept?	YES	NO	
7.	What is the total area (acres) devoted to production? (Includes buildings, manure storage areas, feedlots, chemical buildings, and offices. If a large facility this also includes land application area. Not pasture.)			
8.	What is the total area (acres) devoted to pasture?			
9.	Is the facility currently operating under a National Pollution Discharge Elimination System (NPDES) permit? If yes, indicate NPDES ID.	YES	NO	
10.	(ILLINOIS ONLY) Are you a Certified Livestock Manager (300 or greater animal units)? (Should have a certificate that they were certified by the Dept. of Agriculture.) (Ask to see it if they have one.)	N/A	YES	NO
11.	(ILLINOIS ONLY) If greater than 1000 animal units but less than 5000 animal units , a general waste management plan shall be prepared and maintained on file at the facility. If this applies, is plan maintained at the facility? (Ask to see it if they have one.)	N/A	YES	NO
12.	(ILLINOIS ONLY) If greater than 5000 animal units a waste management plan must be prepared, maintained and submitted to the Dept. of Agriculture. If this applies, did facility do this requirement? (Ask to see it if they have one.)	N/A	YES	NO

13.	Does the facility have a current NMP or CNMP? (Details gathered in Section G, but facility representative may need to begin looking for it now)	YES	NO
14.	Does the facility have any other locations under common ownership, or where equipment and/or manure is shared, or where the other site shares land application sites? If so, put names and addresses below.	YES	NO
15.	Number of Employees (not counting immediate family members)?		
B. MANURE, LITTER, AND PROCESSED WASTEWATER STORAGE TYPE			
Type of Storage		Storage Capacity	
Days of Storage			
Storage Lagoon			
Holding Pond			
Above Ground Storage Tanks			
Below Ground Storage Tanks			
Roofed Storage Shed			
Concrete Pad			
Impervious Soil Pad			
Underflow Pits			
Anaerobic Digester			
Outdoor Piles			
None			
Other			
C. LIVESTOCK WASTE MANAGEMENT AND MORTALITIES			
1.	Does the facility have any existing livestock waste management systems? If yes, continue filling out Section C. If no, then proceed to Section D.	YES	NO
2.	Provide a detailed description of the waste management system. (Include structure types, capacity and condition. Include solid and liquid manure handling, and mortality.)		
3.	Does the system have a managed outfall or discharge point?	YES	NO
If Yes, please provide a detailed description. (Riser pipe, spill way, etc. Include a description the area receiving the discharge.)			
4.	Are there any portions of the production area where runoff is not controlled?	YES	NO
If Yes, provide a detailed description of the area(s) of concern:			
5.	Who designed the storage structures?		
6.	Did you receive help from any organization (like NRCS) in the design of the storage structure? If so, who?		
7.	In what year were the storage structures constructed?		
8.	Does the facility have the As-Built for the storage structures? (Ask to see them and note sizes of ponds/lagoons in gallons.)		
9.	What type of lining is used for the storage structures? (Example: clay, concrete, plastic, etc.)		
10.	Do the storage structures have depth markers or staff gauges?	YES	NO
11.	Are levels of manure in the storage structures recorded and records kept? (If YES, ask to see records. Photograph them or get copies.)	YES	NO

12.	Total number of acres available for land application?		
13.	When was the last time the storage structure was pumped down? (If within the past two months, fill out section I.)		
13.	Are land application records kept? (If YES, ask to see records. Photograph them or get copies.)	YES	NO
14.	Is manure transferred off-site to another party?	YES	NO
15.	Are records of manure transfers kept? (If YES, ask to see records. Photograph them or get copies.)	YES	NO
16.	Do the facility personnel perform routine visual inspections of the production area?	YES	NO
17.	Are the routine visual inspections documented? (If YES, ask to see records. Photograph them or get copies.)	YES	NO
18.	How are mortalities managed? (Composted, buried, burned, rendering service, other) (Get name of rendering service if rendered.)		
19.	Are mortalities documented and are records kept? (If YES, ask to see records. Photograph them or get copies.)	YES	NO
Water Sources that Need to be Contained			
20.	What type of method is used to provide drinking water for the animals? (Circle one) Overflow waters Tip Tanks Nipple waters (if nipple waters are used for swine, is backflow prevention installed?) Other (describe)		
21.	How is the water for animals contained?		
22.	Is a mist cooling system used?	YES	NO
If YES, describe how mist water is contained?			
23.	Is this a dairy operation? If yes, answer the following questions in this section. If no, go on to the Bedding section.	YES	NO
24.	How many times per day are cows milked?		
25.	Describe how non-contact cooling water (or also called plate-cooler water) is contained? (Example: It is reused for drinking water for the animals.)		
26.	Describe how the milking parlor is cleaned (hose or flush) and where the process wastewater goes and how it is contained.		
27.	Describe how the tank(s) are washed and where the process wastewater goes and how it is contained.		
28.	Describe where teat dip containers and waste barrels are located.		
29.	Describe where the Copper Sulfate or Formaldehyde (for the foot baths) is located (both unused and used).		
Bedding			
30.	Describe what type of bedding is used for the animals. (Is a different type of bedding used for young animals?)		
31.	Describe how bedding is collected and how often.		

32.	What is done with the used bedding? REUSED LAND APPLIED		
Manure Collection			
33.	How is manure collected? (Circle one) Scraped: Automatically Manually Scrape/Gravity (Scraped to middle or end of barn to a pipe that gravity feeds to storage structure) Scrape/Flush (Barns flushed with water after scraping) Flush (Cleans out barns with clean or reused water) Vacuum (Solids are separated by a vacuum before entering storage pond) Other (Describe this)		
34.	Amount of manure generated annually? Liquids: Solids:		
35.	If manure collection system uses either clean or reused water to flush, describe where this water comes from. (Storage pond, well water, city water, etc.)		
36.	If manure collection system uses either clean or reused water to flush, describe where this water goes and how it is contained.		
Manure Storage			
37.	Is manure stored for the short term? (Daily haul, small pits/storage)	YES	NO
If YES, indicate for how long manure is stored for the short term.			
How is the short term storage drained? GRAVITY AUTOMATICALLY PLUG			
If Automatically, is there a backup power system in place?		YES	NO
If YES, describe the backup power system.			
38.	Where is manure stored for long term and for how long (Also asked in Section B)? Concrete pit under floor (how long stored here?) _____ Concrete storage structure outdoors _____ Earthen storage structure outdoors _____ Slurry storage structure _____ Other (Describe this) _____		

Safety			
1.	Are there barriers guarding the end of any manure push-off platforms?	YES	NO
2.	Is there fencing around earthen manure storage structures?	YES	NO
3.	Are facility personnel trained for safety with large farm animals and safe work practices?	YES	NO
4.	Are facility personnel trained in skid steer operations?	YES	NO
5.	Are facility personnel trained in tractor operations?	YES	NO
6.	Are facility personnel trained in or kept out of confined spaces?	YES	NO
7.	Are facility personnel trained in safety procedures during the maintenance of equipment?	YES	NO
8.	Are belts, pulleys, chains and sprocket guards intact on farm machinery?	YES	NO
9.	Are MSDSs maintained on-site for all chemicals used on the facility?	YES	NO
10.	Does farm equipment have roll over protective devices (ROPS)	YES	NO
11.	Have facility personnel been trained in hazard communications?	YES	NO
Feed Storage Containment			
38.	Describe how feed is contained, including type of storage structure, capacity and type of feed.		
39.	Describe how feed runoff is contained.		
D. RECEIVING SURFACE WATERS			
1.	Provide a detailed description of the flow path from the facility to the nearest named surface water. (Include detailed descriptions of all unnamed tributaries, ditches, and/or other flow paths <i>i.e.</i> , depth, width, color, odor, slope, amount of water present, soil type, erosivity, etc. Ask for local name of ditches/streams.)		
2.	Are there any man-made features not associated with the production area that can affect runoff?	YES	NO

If Yes, provide a detailed description.			
3.	Are there any storm water pathways entering the facility?	YES	NO
4.	Are there any clean water/storm water ponds on-site?	YES	NO
5.	What is the name of the receiving stream and the names of next streams or rivers in flow path?		
6.	How many months out of the year does the receiving stream/ditch have flow in it?		
7.	What is the name of the first navigable water?		
8.	Status of the named surface water? Intermittent Perennial		
What was the State's designation for this Surface water? (if applicable)			
Is this surface water or subsequent tributary listed as an impaired water on the current state 303(d) list?		YES	NO
If YES, what is the impairment?			
E. DISCHARGES			
1.	What is the 25-year, 24-hour rainfall amount for this location? You can find out this information from the Precipitation Frequency Data Server: http://hdsc.nws.noaa.gov/hdsc/pfds/index.html		
2.	Have there been any documented discharges of livestock waste to surface water <i>in the past year</i> ? If YES, answer parts a – i below. If NO, go to part F.	YES	NO
a. Specify the date(s).			
b. What was the reason for the discharge?			
c. What was the duration?			
d. What was the volume?			
e. Was the discharge the result of a 25 year, 24-hour rainfall event?		YES	NO
f. What was the precipitation amount? (if applicable)			
g. Were EPA and/or the State notified?		YES	NO

h. Provide a detailed description of the flow pathway and the area(s) receiving the discharge(s). <i>(include Photographs)</i>			
i. Has the facility taken corrective action to remedy the situation which caused the discharge(s)?		YES	NO
If YES, describe actions taken:			
3.	Is the facility currently discharging livestock waste from the production area? (This can be seen during the walk-through of the facility.)	YES	NO
What is the reason for the discharge?			
4.	Is the discharge the result of a 25 year, 24-hour rainfall event?	YES	NO
5.	What was the precipitation amount immediately before this discharge? <i>(if applicable)</i>		
6.	Was a sample taken? <i>If YES, then fill out Section G.</i>	YES	NO
Provide a detailed description of the flow pathway and the area(s) receiving the discharge(s).			
F. NPDES PERMIT INFORMATION (If no NPDES Permit, skip this section)			
1.	What type of NPDES permit has been issued? (Circle one.) Individual NPDES Permit General NPDES Permit	NPDES #	
2.	What date was the NPDES permit issued?		
3.	What date does the NPDES permit expire?		
4.	Is a copy of the NPDES permit onsite?	YES	NO
5.	Permitted number of animal units?		
6.	Does the NPDES Permit contain a compliance schedule?	YES	NO
If YES, provide a detailed description of the requirements in the compliance schedule and their status.			
7.	Have there been any changes made to the production area since the permit was issued?	YES	NO

If YES, provide a detailed description of those changes.			
8.	Does each open surface liquid impoundment have an adequate depth marker (e.g., staff gauge)?	YES	NO
9.	Are liquid levels recorded in accordance with the NPDES permit?	YES	NO
10.	Is the facility maintaining adequate storage capacity in each manure or litter storage structures?	YES	NO
11.	When storage capacity is not available, are all structures dewatered/emptied in accordance with the NPDES permit?	YES	NO
12.	Are manure solids stored onsite in accordance with the NPDES permit?	YES	NO
13.	Is manure transferred off-site in accordance with the NPDES permit?	YES	NO
14.	Are records of off-site manure disposal being maintained in accordance with NPDES permit?	YES	NO
15.	Is the facility performing routine visual inspections of the production area in accordance with the NPDES Permit?	YES	NO
16.	Are the visual inspections documented?	YES	NO
17.	Are mortalities managed and disposed of in accordance with the NPDES Permit?	YES	NO
18.	Is mortality management documented?	YES	NO
19.	If you answered NO for any of the questions 6-18, then provide a detailed description of the potential permit violation(s).		
G. NUTRIENT MANAGEMENT PLAN (If no NMP, skip this section)			
1.	Does the facility maintain a copy of the nutrient management plan (NMP) onsite?	YES	NO
2.	Date that the NMP (or CNMP) was developed?		
3.	Date that the NMP (or CNMP) was last updated?		
4.	Does the NMP reflect the current operational characteristics (number of animals, cropping, etc.)?	YES	NO
5.	Are the numbers of acres owned/acres leased consistent with those in the NMP?	YES	NO
6.	Is manure and wastewater being applied in accordance with set-back/buffer requirements of the NMP?	YES	NO
7.	Are all of the records identified in the NMP being maintained and kept current?	YES	NO
8.	Are records being maintained at the required frequency?	YES	NO
9.	Are records being maintained onsite for the period required by NMP and/or NPDES permit?	YES	NO

10.	Is the NMP adequately addressing the storage, handling and application of manure and wastewater to prevent discharges to waters of the U.S.?	YES	NO
11.	If you answered NO for any of the questions 1-8, then provide a detailed description of the potential permit violation(s) (optional).		
H. SAMPLING			
1.	Were samples taken during the inspection?	YES	NO
2.	Provide a detailed description of the sampling methods and protocols used, including representative samples, background, holding times, and preservation techniques. (OK to reference the QAPP.)		
3.	Provide a detailed description of where the samples were collected. Include photos and maps of sampling locations. (OK to reference the aerial photo, or logbook where notes on samples were taken.)		
4.	Provide a detailed description of the weather conditions at the time the sample was collected.		
5.	Classify the odors present on-site and locations where malodorous conditions were present. (Scale of 1-10, with 10 being the worst thing you have ever smelled.)		
I. LAND APPLICATION SITES			
1.			

OTHER COMMENTS/NOTES	
ATTACHMENTS INCLUDED WITH THIS CHECKLIST	
INSPECTORS SIGNATURE AND DATE	
SIZE DESIGNATIONS BY ANIMAL TYPE	
LARGE	
DAIRY COWS (Mature, dry or milking)	700
CATTLE (Heifers, steers, bulls, and cow/calf pairs)	1,000
VEAL CALVES	1,000
SWINE (Greater than or equal to 55 pounds)	2,500
SWINE (Less than 55 pounds)	10,000
HORSES	500

SHEEP OR LAMBS	10,000
TURKEYS	55,000
LAYING HENS OR BROILERS (Liquid manure handling system)	30,000
LAYING HENS (Other than liquid manure handling system)	82,000
CHICKENS (Other than laying hens and other than liquid manure)	125,000
DUCKS (Liquid manure handling system)	5,000
DUCKS (Other than liquid manure handling system)	30,000
MEDIUM	
DAIRY COWS (Mature, dry or milking)	200-699
CATTLE (Heifers, steers, bulls, and cow/calf pairs)	300-999
VEAL CALVES	300-999
SWINE (Greater than or equal to 55 pounds)	750-2,499
SWINE (Less than 55 pounds)	3,000-9,999
HORSES	150-499
SHEEP OR LAMBS	3,000-9,999
TURKEYS	16,000-54,999
LAYING HENS OR BROILERS (Liquid manure handling system)	9,000-29,999
LAYING HENS (Other than liquid manure handling system)	25,000-81,999
CHICKENS (Other than laying hens and other than liquid manure)	37,500-124,999
DUCKS (Liquid manure handling system)	1,500-4,999
DUCKS (Other than liquid manure handling system)	10,000-29,999
SMALL	
DAIRY COWS (Mature, dry or milking)	<200
CATTLE (Heifers, steers, bulls, and cow/calf pairs)	<300
VEAL CALVES	<300
SWINE (Greater than or equal to 55 pounds)	<750
SWINE (Less than 55 pounds)	<3,000
HORSES	<150
SHEEP OR LAMBS	<3,000
TURKEYS	<16,000
LAYING HENS OR BROILERS (Liquid manure handling system)	<9,000
LAYING HENS (Other than liquid manure handling system)	<25,000
CHICKENS (Other than laying hens and other than liquid manure)	<37,500
DUCKS (Liquid manure handling system)	<1,500
DUCKS (Other than liquid manure handling system)	<10,000

Appendix AK – Growth Stages of Common Field Crops

GROWTH STAGES OF COMMON FIELD CROPS

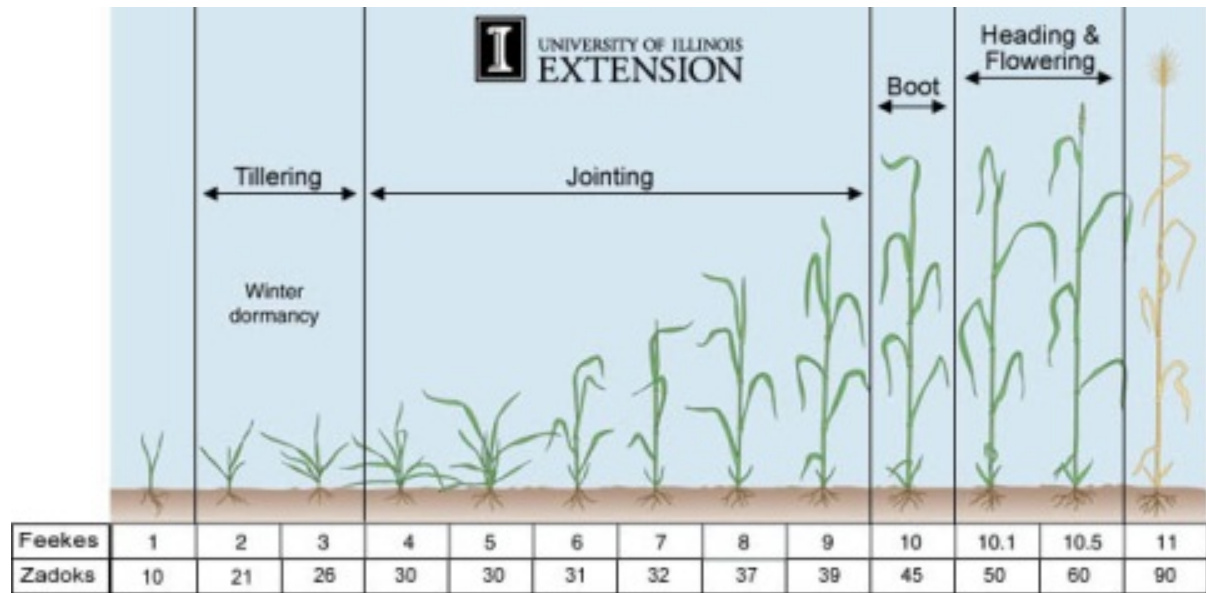

Wheat

Source: University of Illinois – Extension

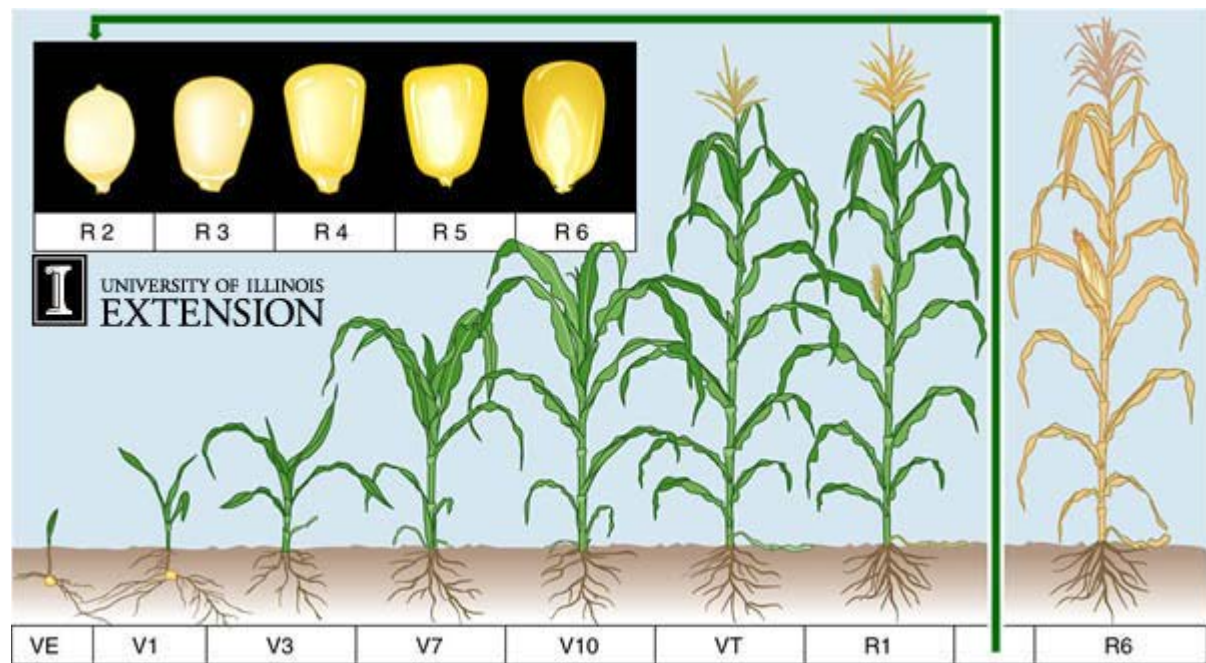

Corn

Source: University of Illinois – Extension

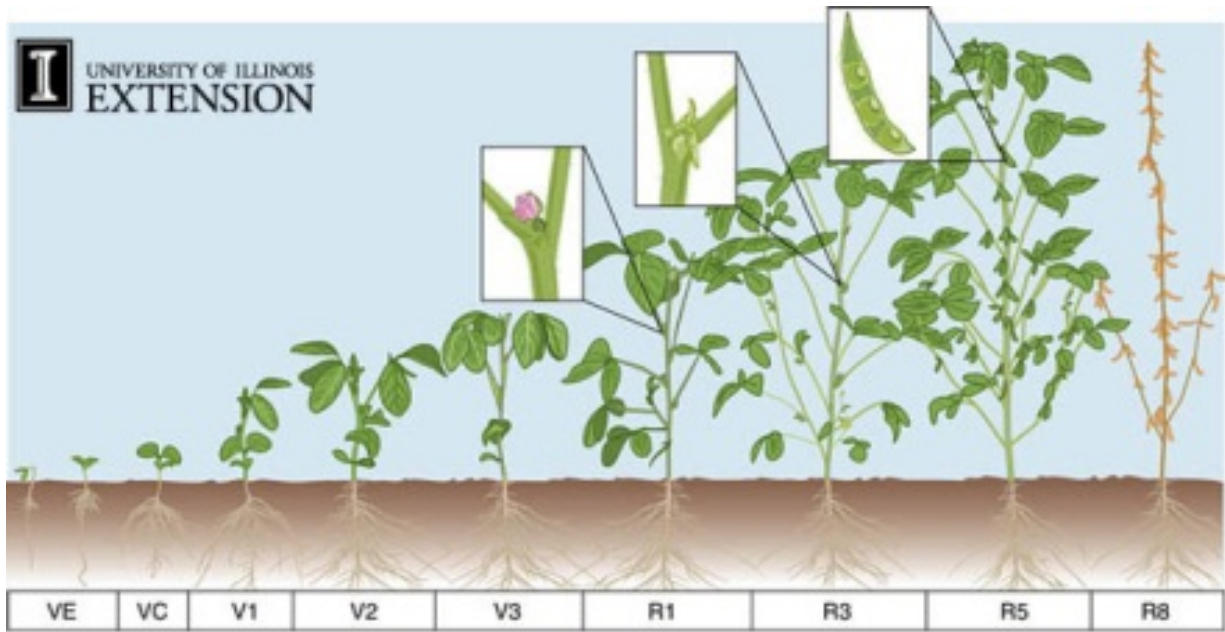

Soybean
Extension

Source: University of Illinois –

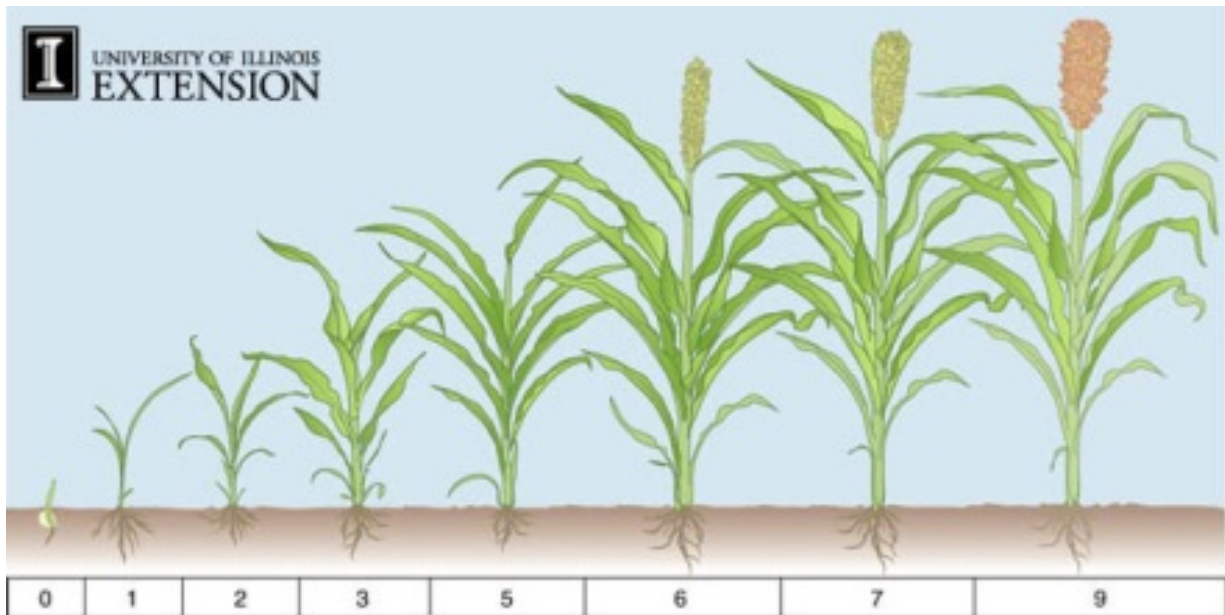

Sorghum
Extension

Source: University of Illinois –

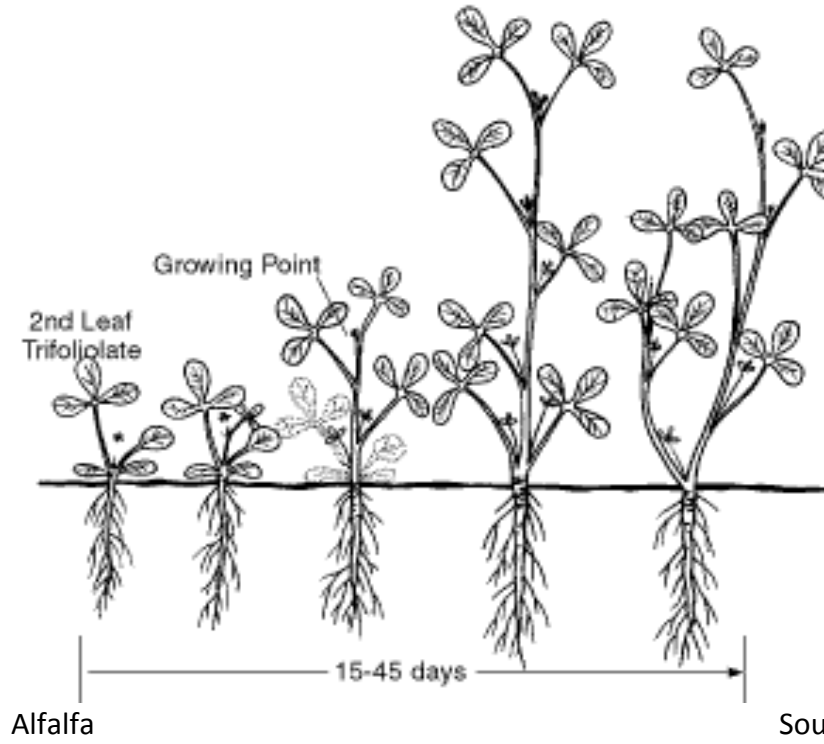

Source: www.ag.ndsu.edu

Appendix AL – Inspection Introduction Letter

EXAMPLE INSPECTION INTRODUCTION LETTERS



Linda S. Adams
Secretary for
Environmental Protection

California Regional Water Quality Control Board Santa Ana Region

3737 Main Street, Suite 500, Riverside, California 92501-3348
Phone (951) 782-4130 • FAX (951) 781-6288 • TDD (951) 782-3221
www.waterboards.ca.gov/santaana



Arnold Schwarzenegger
Governor

NOTICE OF INSPECTION GENERAL WASTE DISCHARGE REQUIREMENTS FOR CONCENTRATED ANIMAL FEEDING OPERATIONS (DAIRIES AND RELATED FACILITIES) WITHIN THE SANTA ANA REGION

August 9, 2007

Dear Dairy Operator:

This letter provides formal notification of the Santa Ana Regional Water Quality Control Board's (Regional Board) intent to conduct an inspection of your facility. [REDACTED] working under contract with the Regional Board, is authorized to conduct the inspection on behalf of the Regional Board. The purpose of the inspection is to determine the facility's compliance with the Regional Board's Dairy Permit, General Waste Discharge Requirements for Concentrated Animal Feeding Operations, Order No. 99-11, and/or its renewed version (General Dairy Permit).

The information gathered during the inspection may include, but is not limited to; the location and contact information, number and type of animals within the facility, status of development and implementation of the Engineered Waste Management Plan, and the manure/wastewater handling and disposal practices. Digital photographs may be taken and samples may be collected during the inspection. The information gathered will be provided to Regional Board staff for review and will assist us in determining whether the facility is in compliance with the General Dairy Permit. After review of the inspection report, Regional Board staff may contact you for additional information regarding your facility or for necessary follow-up.

We look forward to your cooperation with this matter. Please direct any questions to [REDACTED] at [REDACTED].

Sincerely,

[REDACTED]

[REDACTED], Chief
Compliance Section

California Environmental Protection Agency



STATE OF COLORADO

John W. Hickenlooper, Governor
Christopher E. Urbina, MD, MPH
Executive Director and Chief Medical Officer

Dedicated to protecting and improving the health and environment of the people of Colorado

4300 Cherry Creek Dr. S. Laboratory Services Division
Denver, Colorado 80246-1530 8100 Lowry Blvd.
Phone (303) 692-2000 Denver, Colorado 80230-6928
Located in Glendale, Colorado (303) 692-3090

<http://www.cdphe.state.co.us>



Colorado Department
of Public Health
and Environment

September 18, 2012

Subject: Notification of Upcoming CAFO Inspection

Dear Concentrated Animal Feeding Operation Operator:

This letter provides formal notification of the Colorado Department of Public Health and Environment's intent to conduct a Concentrated Animal Feeding Operation inspection of this facility. [Insert Name], working under contract for the state, is authorized to conduct the inspection on the department's behalf. The purpose of the inspection is to determine the facility's compliance with Colorado Water Quality Control Commission Regulation No. 81, Animal Feeding Operations Control Regulation (5 CCR 1002-81) and, if applicable, Regulation No. 61, Colorado Discharge Permit System Regulation (5 CCR 1002-61).

The information gathered during the inspection may include the following:

- Facility location and contact information
- Number and type of animals confined
- Information about site characteristics such as manure/wastewater handling and storage facilities and nutrient management practices

Digital photographs may be taken during the inspection. The information gathered will be provided to the department for review. Please be aware that you may be contacted by the department for additional information regarding your facility or for necessary follow-up.

We look forward to your cooperation with this matter. Please direct any questions to me at (xxx) xxx-xxxx, or via e-mail at [insert email address].

Sincerely,

Fax

To:	[Insert Operator]	From:	[Insert Name]
Fax:	[Insert Fax Number]	Pages:	2 (including cover page)
Re:	CAFO Inspection, [DATE]	Date:	[Insert Date]

Dear Mr./Ms. [Name],

Please find attached the Letter of Introduction from [insert name] regarding the Concentrated Animal Feeding Operation (CAFO) inspection scheduled for the facility located at [address] on [Month] [Day], 2012 at [Time AM/PM].

The inspection should last approximately 2 to 3 hours and will consist of a records review and a facility tour. To expedite the records review portion of the inspection, please have available any of the documents and records listed below that you keep for your operation. (Please note that this is not meant to be a list of records that you are required to keep. This is simply a list of the types of records that we would like to review if you do keep them for your operation.)

- Records of third party manure and/or wastewater transfers
- Nutrient management plan (NMP)
- Land application records (for example, nutrient rate recommendations, records of the amounts of manure and/or wastewater or nutrients applied, or records of the dates and fields for each land application event)
- Records of soil, manure, and/or wastewater sampling and analysis
- Facility inspection records (records of inspections that you perform of any impoundments, berms, swales, or other structures used to contain or divert manure and/or wastewater)
- Documentation of:
 - Calculations of the volume of process wastewater runoff generated for each impoundment
 - Drawings of each impoundment
 - Design documentation or calculations of size requirements for stormwater and process wastewater diversion structures.
- Documentation of the terms of the NMP

The facility tour portion of the inspection will focus on manure and/or wastewater handling, storage, and nutrient management practices at your operation.

I look forward to meeting with you [next week].

Sincerely,

Appendix AM – Sampling Procedures and Equipment

SAMPLING PROCEDURES

CAFO inspectors may be required to collect wastewater, manure, or soil samples during an inspection. Sample collection may be planned in advance or opportunistic. In addition, familiarity with sample collection is useful for determining if the facility followed appropriate procedures for sampling wastewater, manure, and soil. The facility representative may not be familiar with sampling procedures if they are collected by a consultant or extension agent.

Planned sample collection may occur when:

- EPA wants to validate results from soil and manure samples collected by the CAFO for laboratory analysis;
- Surface water or streambed sediment samples are collected as evidence to demonstrate the presence of pollutants discharged from the CAFO; or
- EPA wants to collect samples from standing water in the production area to establish pollutant concentrations.

Opportunistic sampling might occur when a facility is observed to be discharging during the inspection. Regardless, the inspector should be prepared to collect samples. Prior to the inspection, a Quality Assurance Project Plan (QAPP) should be prepared and the inspector should prepare and be familiar with sampling equipment. Sampling, analysis, preservation technique, sample holding time, and sample container requirements are provided in 40 CFR Part 136 as authorized by Section 304(h) of the CWA.

Chapter 5 of the *NPDES Compliance Inspection Manual* is a helpful reference for wastewater sampling/analysis.

Water and wastewater sampling procedures

Typically grab samples will be collected during a CAFO inspection, not composite samples. Grab samples are individual samples collected over a period of time not exceeding 15 minutes and are representative of conditions at the time the sample is collected. The collection of a grab sample is appropriate when a sample is needed to:

- Sample an effluent that does not discharge on a continuous basis
- Provide information about instantaneous concentrations of pollutants at a specific time
- Allow collection of a variable sample volume
- Corroborate composite samples

Some parameters may be sampled only by grab sampling, but others may be sampled by either grab or composite sampling. Parameters not amenable to compositing include pH, temperature, dissolved oxygen, chlorine, purgeable organics, oil and grease, coliform bacteria, and others specified in 40 CFR Part 136. Volatile organics, sulfides, phenols, and phosphorus samples can be composited but require special handling procedures. BOD and ammonia

nitrogen can be sampled by using either grab or composite techniques; if composite sampling is used, appropriate preservation must be provided during and after the sampling period.

Typical parameters sampled at CAFOs are those which readily show an effect on water quality by the discharge. These might include Biochemical Oxygen Demand (BOD), fecal or total coliform bacteria, specific conductance, and ammonia nitrogen. Many other parameters, however, may appropriately be sampled to document such discharges. Sampling of any one or a combination of these parameters can aid the inspector in documenting an illegal discharge.

The volume of samples collected depends on the type and number of analyses needed, as reflected in the parameters to be measured. Obtain the volume of the sample sufficient for all the required analyses plus an additional amount to provide for any split samples or repeat analyses. Consult the laboratory receiving the sample for any specific volume required. In addition, EPA's *Methods for Chemical Analysis of Water and Wastes* (USEPA 1979b) and *Handbook for Sampling and Sample Preservation of Water and Wastewater* (USEPA 1982), and the current Environmental Protection Agency (EPA)-approved edition of *Standard Methods for the Examination of Water and Wastewater* [American Public Health Association (APHA), American Water Works Association (AWWA), and Water Environment Federation (WEF)] contain specific recommended minimum sample volumes for different pollutant parameters.

Sample storage and holding times

40 CFR Part 136 describes required sample containers, sample preservation, and sample holding time. It is essential that the sample containers be made of chemically resistant material unaffected by the concentrations of the pollutants measured. In addition, sample containers must have a closure that will protect the sample from contamination. Collect wastewater samples for chemical analysis in plastic (polyethylene) containers. Exceptions to this general rule are organic pollutant samples which are collected in properly cleaned glass jars or bottles and sealed. Collect bacteriological samples in properly sterilized plastic or glass containers.

Ensure sample containers are clean and uncontaminated. Review analytical procedures for specific container cleaning procedures. Use precleaned and sterilized disposable containers when possible. If not, use the following procedures for cleaning sample containers:

- Wash with hot water and detergent.
- Rinse with acid (e.g., nitric for metals).
- Rinse with tap water, then rinse three or more times with organic-free water.
- Rinse glass containers with an interference-free, redistilled solvent (such as acetone or methylene chloride for extractable organics).
- Dry in contaminant-free area.

Table K 1 presents required containers, preservation techniques, and holding times for parameters that might be analyzed in a CAFO water sample.

TABLE K 1. Required containers, preservation techniques, and holding times (EPA 2004)

Parameter	Container	Preservative	Maximum Holding Time
Coliform, fecal and total	Polyethylene or glass	Cool, 4°C 0.008% Na ₂ S ₂ O ₃ ⁵	6 hours
Ammonia	Polyethylene or glass	Cool, 4°C H ₂ SO ₄ to pH<2	28 days
Dissolved Oxygen Probe Winkler	Glass bottle & top Glass bottle & top	None required Fix onsite and store dark	Analyze immediately 8 hours
Chloride	Polyethylene or glass	None required	28 days
BOD ₅	Polyethylene or glass	Cool, 4°C	48 hours
Total phosphorus	Polyethylene or glass	Cool, 4°C H ₂ SO ₄ to pH<2	28 days
Nitrate	Polyethylene or glass	Cool, 4°C	48 hours

Identify each sample accurately and completely. Use labels or tags to identify the samples that are moisture-resistant and able to withstand field conditions. Use a waterproof pen to complete the labels or tags. A numbered label or tag associated with a field sample data sheet containing detailed information on the sample is preferable to using only a label or tag for information. The information for each sample should include the following:

- Facility name/location
- Sample site location
- Sample number
- Name of sample collector
- Date and time of collection
- Indication of grab or composite sample with appropriate time and volume information
- Identification of parameter to be analyzed
- Preservative used.

To ensure the validity of the permit compliance sampling data in court, written records must accurately trace the custody of each sample through all phases of the monitoring program. The primary objective of this chain-of-custody is to create an accurate written record that can be used to trace the possession and handling of the sample from the moment of its collection through its analysis and introduction as evidence.

- Use sample seals to protect the sample's integrity from the time of collection to the time it is opened in the laboratory. The seal should indicate the collector's name, the date and time of sample collection, and sample identification number.

- Pack samples properly to prevent breakage. Seal or lock the shipping container to readily detect any evidence of tampering can be readily detected. Use of tamper proof evidence tape is recommended.
- Place samples on ice or synthetic ice substitute that will maintain sample temperature at 4°C throughout shipment.
- Accompany every sample with a sample tag and a chain-of-custody record that has been completed, signed, and dated. The chain-of-custody record should include the names of sample collectors, sample identification numbers, date and time of sample collection, location of sample collection, and names and signatures of all persons handling the sample in the field and in the laboratory.
- The responsibility for proper packaging, labeling, and transferring of possession of the sample lies with the inspector.
- Accompany all sample shipments with the chain-of-custody record and other pertinent forms. The originator retains a copy of these forms. Also, the originator must retain all receipts associated with the shipment.
- EPA Inspectors with the responsibility of working with hazardous materials that are placed in commerce (transporting/shipping) must have hazardous materials training as required by the Department of Transportation.
- When transferring possession of samples, the transferee must sign and record the date and time on the chain-of-custody record (use the currently approved record). In general, make custody transfers for each sample, although samples may be transferred as a group, if desired. Each person who takes custody must fill in the appropriate section of the chain-of-custody record.
- Pack and ship samples in accordance with applicable International Air Transportation Association (IATA) and/or DOT regulations.

In general, the most common monitoring errors usually are improper sampling methodology, improper preservation, and excessive sample holding time. In addition, the inspector can analyze field blanks to check for analytical artifacts and/or background introduced sampling and analytical procedures.

Field Blanks

Field blanks are distilled or de-ionized water samples prepared when you are collecting water quality samples. Field blanks are prepared, in the field, after cleaning all sampling equipment but before sample collection. Blanks are prepared by pouring distilled de-ionized water into each scoop, dipper, etc. used for sample collection and then into sample bottles as if they were actual field samples. The field blanks are processed and analyzed in an identical manner as the water quality samples. If the lab detects any contamination in the blanks, the sampling results could be considered tainted (either from contamination, errors in sampling, or analysis problems). Collection and analysis of field blanks is not required by federal CAFO regulations; however, field blanks are used for quality control to assess whether contamination was introduced during sampling, and may prove useful in interpretation of results.

Soil sampling procedures

Crop nutrient requirements vary depending on factors such as soil characteristics and previous fertilization. Soil testing is used to provide agronomic and environmentally sound nutrient and lime recommendations. It provides growers a means to assess soil pH and plant-available nutrient content, to determine the need for addition of lime and nutrients, and to minimize nutrient losses to the environment from over-application.

Good animal manure management includes routine soil sampling on every field that manure is applied. EPA generally considers soil sampling for phosphorus every 5 years as the minimum necessary to properly manage soil nutrient levels (as is required for Large dairy, beef, poultry, swine, and veal calf CAFOs under the ELG. 40 CFR Part 412.4(c)(3)).

Proper sampling is the most important component of an accurate soil test. If a representative sample is not collected, the recommendations developed by the laboratory will likely be inaccurate, resulting in excessive nutrient application or deficiencies that will affect production. Permit writers and inspectors will generally not be collecting soil samples, so this section is provided for informational purposes only. However, enforcement actions might require the soil sample collection in some cases.

A soil probe is the most efficient way to collect samples. For facilities applying nutrients at a nitrogen-based rate, collect separate soil samples at depths of 0 to 12 and 12 to 24 inches. Collect soil samples at a depth of 0 to 12 inches only at facilities applying at a phosphorus-based rate.

Every soil sample submitted for testing typically consist of about 15 to 20 cores taken at random locations throughout one field or management unit. The various cores will be used to form one composite sample to be submitted for laboratory analysis. Keep in mind that each composite sample should represent only one general soil type or condition. If the field contains areas that are obviously different in slope, color, drainage, and texture and if those areas can and will be managed separately, a separate sample should be submitted.

Manure sampling procedures

Manure is a variable material requiring proper sampling procedures to ensure collection of a representative sample. Manure samples submitted to a laboratory should represent the average composition of the material that will be applied to the field. For liquid manure, sample directly from the storage structure, from the outlet pipe where liquid is removed, or from the field using catch cans to collect samples applied through sprinklers. A minimum of six separate liquid manure subsamples must be collected. Combine the subsamples in a clean bucket, thoroughly mix, and transfer approximately one pint of liquid to a clean bottle or another rigid container.

For solid manure, remove the surface six-inch crust and use an auger or shovel to core into the pile. Take a minimum of six separate subsamples from around the pile and combine them in a clean bucket. Mix well and transfer approximately one quart to a clean plastic bag. Keep all manure samples cool until delivered to a lab.

It is important that proper containers are used and maximum holding or shipping times are also identified and followed to avoid contaminating or altering the collected samples.

Laboratory identification

The laboratory selected for analysis of surface water or discharge samples may be different from the laboratory selected for analyzing manure and soil samples. Regardless, the laboratory selected should be certified to perform the analyses according to 40 CFR Part 136 methods for water samples and state technical standards for nutrient management for soil and manure samples. Ideally, the laboratory will be able to provide sampling materials at no charge along with sample collection and preparation instructions and mailing labels (if needed).

Regulations at 40 CFR Part 123.36 requires that state technical standards for nutrient management identify acceptable labs or methods for conducting soil and manure analyses. Alternately, NRCS' CPS 590 (NRCS 2011) specifies requirements for selecting laboratories to conduct soil and manure analyses. Soil test analyses must be performed by laboratories successfully meeting the requirements and performance standards of the North American Proficiency Testing Program-Performance Assessment Program (NAPT-PAP) under the auspices of the Soil Science Society of America (SSSA) and NRCS, or other NRCS-approved program that considers laboratory performance and proficiency to assure accuracy of soil test results. Manure testing analyses must be performed by laboratories successfully meeting the requirements and performance standards of the Manure Testing Laboratory Certification program (MTLCP) under the auspices of the Minnesota Department of Agriculture, or other NRCS- approved program that considers laboratory performance and proficiency to assure accurate manure test results.

Data Handling and Reporting

Verified analytical results are normally entered into a laboratory data management system of some type. The system should contain the sampling data, including sampling time and exact location, dates and times, names of analysts, analytical methods or techniques used, and analytical results. Data are then reported to the inspector for inclusion in the compliance report.

Appendix AN – Sample Quality Assurance Project Plan (QAPP)

SAMPLE QUALITY ASSURANCE PROJECT PLAN (QAPP)

CAFO inspectors may be required to collect wastewater, manure, or soil samples during an inspection. Sample collection may be planned in advance or opportunistic. Opportunistic sampling might occur when a facility is observed to be discharging during the inspection. Regardless, the inspector should be prepared to collect samples. Prior to the inspection, a Quality Assurance Project Plan (QAPP) should be prepared and the inspector should prepare and be familiar with sampling equipment. Below are two QAPP templates for CAFO sampling and analysis.

Sampling, analysis, preservation technique, sample holding time, and sample container requirements are provided in 40 CFR Part 136 as authorized by Section 304(h) of the CWA. Chapter 5 of the *NPDES Compliance Inspection Manual* is a helpful reference for wastewater sampling/analysis.

QUALITY ASSURANCE PROJECT PLAN (QAPP) TEMPLATE



U.S. Environmental Protection Agency Region

This QAPP template was prepared based on *EPA Requirements for Quality Assurance Project Plans* (EPA QA/R-5), EPA/240/B-01/003, March 2001 (<https://www.epa.gov/quality/epa-qar-5-epa-requirements-quality-assurance-project-plans>). It contains an outline of the QAPP elements based on the EPA QA/R-5, with an abridged description of the discussion that should be included within each section (included in redline text). This template was created as a tool to assist in development of QAPPs. Users of this QAPP template may consult the EPA QA/R-5 or the more general *Guidance for Quality Assurance Project Plans* (EPA QA/G-5), EPA/240/R-02/009, December 2002 (<https://www.epa.gov/quality/guidance-quality-assurance-project-plans-epa-qag-5>) as appropriate to obtain additional details and guidance for development of a QAPP.

DRAFT

QUALITY ASSURANCE PROJECT PLAN

<Title of Project (or portion of project addressed by this QAPP)>

Contract/WA/Grant No./Project Identifier

<Enter specific identifier>

Prepared by:

<Enter the contact information including name, affiliation, address, and phone number>

Prepared for:



**U.S. Environmental Protection Agency
Region**

<Enter date>

SECTION A – PROJECT MANAGEMENT

A.1 Title of Plan and Approval
Quality Assurance Project Plan
<Enter Title of Project>

Prepared by:
<Enter Affiliation>

_____ Date: _____
<Enter name, Organization>, Project Manager / Principal Investigator

Approvals:

_____ Date: _____
<Enter name, Organization>, Quality Assurance Officer

_____ Date: _____
< Enter name, Organization>, Section Chief (Mail Code)

_____ Date: _____
< Enter name, Organization >, Associate Director (Mail Code)

_____ Date: _____
<Enter additional contacts, as needed>

A.2 Table of Contents

<TOC must be regenerated upon completion of QAPP content. To do so, Click in TOC below, select Update Field, then select Update Page Numbers Only>

SECTION A – PROJECT MANAGEMENT	791
A.1 Title of Plan and Approval	791
A.2 Table of Contents	792
A.3 Distribution List.....	794
A.4 Project/Task Organization	794
A.5 Problem Definition/Background	794
A.6 Project/Task Description	794
A.7 Quality Objectives & Criteria.....	795
A.8 Special Training/Certification.....	795
A.9 Documents and Records.....	795
SECTION B – DATA GENERATION & ACQUISITION	796
B.1 Sampling Process Design (Experimental Design)	796
B.2 Sampling Methods	796
B.3 Sampling Handling & Custody	796
B.4 Analytical Methods	797
B.5 Quality Control	797
B.6 Instrument/Equipment Testing, Inspection, and Maintenance.....	797
B.7 Instrument/Equipment Calibration and Frequency	797
B.8 Inspection/Acceptance of Supplies & Consumables	798
B.9 Data Acquisition Requirements for Non-Direct Measurements.....	798
B.10 Data Management	798
SECTION C – ASSESSMENT AND OVERSIGHT.....	799
C.1 Assessments and Response Actions	799
C.2 Reports to Management.....	799
SECTION D – DATA VALIDATION AND USABILITY	800
D.1 Data Review, Verification, and Validation.....	800
D.2 Verification and Validation Methods.....	800
D.3 Reconciliation with User Requirements	800

List of Tables

Table A.1 Roles & Responsibilities 4
<insert list of tables>

List of Figures

Figure A.1 Organization Chart..... 4
<insert list of figures>

Appendices

<insert list of appendices>

A.3 Distribution List

List the individuals and their organizations that need copies of the approved QA Project Plan and any subsequent revisions, including all persons responsible for implementation (e.g., project managers), the QA managers, and representatives of all groups involved.

<insert text>

Name, Agency/Company, Title, other contact information as needed

A.4 Project/Task Organization

Identify the individuals or organizations participating in the project and discuss their specific roles and responsibilities. Include the principal data users, the decision makers, the project QA manager, and all persons responsible for implementation. Project QA manager position must indicate independence from unit collecting/using data.

Table A.1 Roles & Responsibilities

Individual(s) Assigned:	Responsible for:	Authorized to:
Name	Responsibility	Action
Name	Responsibility	Action

Provide a concise organization chart showing the relationships and the lines of communication among all project participants. The organization chart must also identify any subcontractor relationships relevant to environmental data operations, including laboratories providing analytical services.

Figure A.1 Organization Chart

A.5 Problem Definition/Background

State the specific problem to be solved, decision to be made, or outcome to be achieved. Include sufficient background information to provide a historical, scientific, and regulatory perspective for this particular project.

- Clearly state problem to be resolved, decision to be made, or hypothesis to be tested
- Historical & background information
- Cite applicable technical, regulatory, or program-specific quality standards, criteria, or objectives

<insert text>

A.6 Project/Task Description

Provide a summary of all work to be performed, products to be produced, and the schedule for implementation. Provide maps or tables that show or state the geographic locations of field tasks. This discussion need not be lengthy or overly detailed, but should give an overall picture of how the project will resolve the problem or question described in A.5.

- List measurements to be made/data to obtain
- Note special personnel or equipment requirements
- Provide work schedule

<insert text>

A.7 Quality Objectives & Criteria

Discuss the quality objectives for the project and the performance criteria to achieve those objectives. EPA requires the use of a systematic planning process to define these quality objectives and performance criteria.

- State project objectives and limits, both qualitatively & quantitatively
- State & characterize measurement quality objectives as to applicable action levels or criteria

<insert text>

A.8 Special Training/Certification

Identify and describe any specialized training or certifications needed by personnel in order to successfully complete the project or task. Discuss how such training will be provided and how the necessary skills will be assured and documented.

<insert text>

A.9 Documents and Records

Describe the process and responsibilities for ensuring the appropriate project personnel have the most current approved version of the QA Project Plan, including version control, updates, distribution, and disposition.

Itemize the information and records which must be included in the data report package and specify the reporting format for hard copy and any electronic forms. Records can include raw data, data from other sources such as data bases or literature, field logs, sample preparation and analysis logs, instrument printouts, model input and output files, and results of calibration and QC checks.

Identify any other records and documents applicable to the project that will be produced, such as audit reports, interim progress reports, and final reports. Specify the level of detail of the field sampling, laboratory analysis, literature or data base data collection, or modeling documents or records needed to provide a complete description of any difficulties encountered.

Specify or reference all applicable requirements for the final disposition of records and documents, including location and length of retention period.

<insert text>

SECTION B – DATA GENERATION & ACQUISITION

B.1 Sampling Process Design (Experimental Design)

Describe the experimental data generation or data collection design for the project, including as appropriate:

- Types and number of samples required
- Sampling network design & rationale for design
- Sampling locations & frequency of sampling
- Sample matrices
- Classification of each measurement parameter as either critical or needed for information only
- Validation study information, for non-standard situations

<insert text>

B.2 Sampling Methods

Describe the sampling procedures:

- Identify sample collection procedures.
- Identify sampling methods and equipment
 - Sampling methods by number, date, and regulatory citation, where appropriate
 - Implementation requirements
 - Sample preservation requirements
 - Decontamination procedures
 - Any support facilities needed
- Describe specific performance requirements for the method.
 - Address what to do when a failure in the sampling or measurement system occurs
 - Who is responsible for corrective action
 - How the effectiveness of the corrective action will be determined and documented

<insert text>

B.3 Sampling Handling & Custody

Describe the requirements for sample handling and custody in the field, laboratory, and transport. Examples of sample labels, custody forms, and sample custody logs should be included.

<insert text>

B.4 Analytical Methods

Identify analytical methods to be followed (with all options) & required equipment.

- Specify any specific method performance criteria
- State requested lab turnaround time
- Provide validation information for non-standard methods
- Identify procedures to follow when failures occur
- Identify individuals responsible for corrective action and appropriate documentation

<insert text>

B.5 Quality Control

Identify QC activities needed for each sampling, analysis, or measurement technique. For each required QC activity, list the associated method or procedure, acceptance criteria, and corrective action. State or reference the required control limits for each QC activity and corrective action required when control limits are exceeded and how the effectiveness of the corrective action shall be determined and documented.

Describe or reference the procedures to be used to calculate applicable statistics (e.g., precision, bias, accuracy).

<insert text>

B.6 Instrument/Equipment Testing, Inspection, and Maintenance

Describe how inspections and acceptance testing of instruments, equipment, and their components affecting quality will be performed and documented to assure their intended use as specified.

Describe how deficiencies are to be resolved, when re-inspection will be performed, and how the effectiveness of the corrective action shall be determined and documented.

Identify the equipment and/or systems requiring periodic maintenance and/or calibration. Describe how periodic preventative maintenance will be performed, including frequency, to ensure availability and satisfactory performance of the systems. Note availability & location of spare parts.

<insert text>

B.7 Instrument/Equipment Calibration and Frequency

Identify all tools, gauges, instruments, and other sampling, measuring, and test equipment used for data generation or collection activities affecting quality that must be controlled and calibrated.

Describe or reference how calibration will be conducted using certified equipment and/or standards with known valid relationships to nationally recognized performance standards. If no such nationally recognized standards exist, document the basis for the calibration.

Indicate how records of calibration will be maintained and be traceable to the equipment.

<insert text>

B.8 Inspection/Acceptance of Supplies & Consumables

State acceptance criteria for supplies and consumables and describe how they will be inspected for use in the project. Note responsible individuals.

<insert text>

B.9 Data Acquisition Requirements for Non-Direct Measurements

Identify type of data needed from non-measurement sources (e.g., computer data bases and literature files), along with acceptance criteria for their use. Define intended use and describe any limitations of such data.

<insert text>

B.10 Data Management

Describe data management process from generation to final use or storage. Describe standard record keeping & data storage and retrieval requirements. Provide examples of any forms or checklists to be used.

Describe data handling equipment & procedures used to process, compile and analyze data (e.g., required computer hardware & software). Describe the process for assuring that applicable information resource management requirements, including EPA specific requirements, are satisfied.

<insert text>

SECTION C – ASSESSMENT AND OVERSIGHT

C.1 Assessments and Response Actions

Describe each assessment to be used in the project including the frequency and type (e.g., surveillance, management systems reviews, readiness reviews, technical systems audits, performance evaluations, data quality).

- What is expected information from assessment?
- What are assessment success criteria?
- What is assessment schedule?

Describe response actions to each assessment.

- How will corrective actions be addressed?
- Who is responsible for corrective actions?

How will corrective actions be verified and documented?

<insert text>

C.2 Reports to Management

Identify frequency and distribution of reports to inform management of project status:

- Results of performance evaluations & audits
- Results of periodic data quality assessments
- Any significant QA problems

Identify the preparer and recipients of reports, and describe any actions the recipient should take as a result of the report.

<insert text>

SECTION D – DATA VALIDATION AND USABILITY

D.1 Data Review, Verification, and Validation

State criteria for accepting, rejecting, or qualifying data; include project-specific calculations or algorithms.

<insert text>

D.2 Verification and Validation Methods

Describe the process for data validation and verification. Identify issue resolution procedure and responsible individuals. Identify the method for conveying results to data users. Provide examples of any forms or checklists to be used.

<insert text>

D.3 Reconciliation with User Requirements

Describe how the project results will be reconciled with the requirements defined by the data user or decision maker. Outline the proposed methods to analyze the data and determine departures from assumptions established in the planning phase of data collection. Describe how reconciliation with user requirements will be documented, issues will be resolved, and how limitations on the use of the data will be reported to decision makers.

<insert text>

**GENERIC QUALITY ASSURANCE
PROJECT PLAN (QAPP)**

FOR

**CONCENTRATED ANIMAL FEEDING
OPERATIONS (CAFO) INSPECTION SAMPLING**

December 2012
Rev 5.0

QAPP APPROVAL:

Unit Manager, USEPA

Date: _____

Director, USEPA

Date: _____

QA Manager, USEPA

Date: _____

TABLE OF CONTENTS

1.0 Project Management Elements	804
1.1 Distribution List	804
1.2 Project/ Task Organization	804
1.3 Problem Definition/ Background.....	805
1.3.1 Background	805
1.3.2 Objectives/Scope	806
1.4 Project/ Task Description and Schedule.....	806
1.4.1 Project/Task Description.....	806
1.4.2 Schedule of Tasks.....	806
Table 1 – Activity Schedule and Tentative Start and Completion Dates*.	806
1.4.3 CAFO Site-Specific Inspection Plan (CSSIP).....	807
1.5 Data Quality Objectives and Criteria for Measurement Data	807
1.6 Special Training Requirements/Certification	808
1.7 Documentation and Records	809
2.0 Measurement/ Data Acquisition	809
2.1 Sampling Process Design (Experimental Design)	809
2.2 Inspection and Sample Collection Procedures.....	810
2.2.1 Health and Safety.....	810
2.2.2 Location.....	810
2.2.3 Sample Collection	810
2.2.4 Sample Collection Equipment	811
Table 2 -Suggested Sample Equipment for CAFO Field Inspections	811
2.2.5 Shipping Requirements.....	812
2.2.6 Decontamination Procedures	812
2.3 Analytical Methods Requirements	812
2.4 Quality Control Requirements.....	812
2.5 Instrument/Equipment Testing, Inspection and Maintenance Requirements.....	813
2.6 Instrument Calibration and Frequency	813
2.7 Inspection/Acceptance Requirements for Supplies and Consumables	813
2.8 Data Acquisition Requirements (non-Direct Measurements).....	813
2.9 Data Management	814
3.1 Assessments and Response Actions.....	815
3.2 Reports to Management.....	815

4.0 Data Validation and Usability	815
4.1 Data Review, Validation, and Verification Requirements	815
4.2 Validation and Verification Methods	815
4.3 Reconciliation with User Requirements	816
Attachment 1-Sample Alteration Form	819
Attachment 2-Corrective Action Form	820
Appendix A: Site-Specific Inspection Plan (CSSIP)	821

1.0 Project Management Elements

1.1 Distribution List

Copies of the completed/signed project plan should be distributed to:

Name	Title (examples)	Mail Stop	Phone Number	e-Mail Address
	EPA Inspector			
	Regional Sample Control Center (RSCC)			
	QA			
	Supervisor			
	Lab Manager			

Summary of analytical results shall be sent to the EPA Inspector. Electronic copies of data are not required unless specifically requested.

1.2 Project/ Task Organization

This section identifies the personnel involved in CAFO inspection sampling and analytical activities and defines their respective responsibilities in the process.

1. Inspector

The inspector conducts the inspection under the authority provided by the Clean Water Act. The inspector's responsibility is to prepare a final inspection report to be submitted to the immediate program manager based on the results of the inspection conducted and the sample analytical data obtained from the laboratory. In conjunction, the inspector shall also be responsible for:

- Site inspection and recording observations in a note book;
- Documenting the location of site using GPS;
- Conducting dye tracer tests if appropriate;
- Conducting direct readings such as pH, temperature, dissolved oxygen, etc..., if appropriate;
- Collecting water or effluent samples if appropriate;
- Coordinating with the Regional Sample Control Center (RSCC) for regional sample numbers, if appropriate;
- Coordinating with the mobile EPA or commercial laboratory for sample analyses, if appropriate;
- Maintaining sample documentation, including chain of custody, photographs, and receiving sample analytical results.

All of these tasks shall be performed in accordance with the approved QA Plan for CAFO inspections. Changes in procedure should be documented in an appropriate addendum to the plan or sample alteration form included with the site-specific inspection plan.

2. Regional Sample Control Center (RSCC)

The role of RSCC is to coordinate and schedule sample delivery and analysis with the regional laboratory based on the information provided by the inspector in the CAFO Site-Specific Inspection Plan Form (see Appendix A). For sample tracking, the RSCC also provides the inspector with an assigned block of regional sample numbers and the corresponding project code.

3. Quality Assurance Officer (QAO)

The QAO is part of the <insert text> and is located within <insert text>. The QAO is designated and assigned by the Unit Manager and authorized by the Regional QA Manager (RQAM) as his/her designee. The QAO works with the EPA inspectors and ensures that the sample collection and analyses are covered by an approved QAPP that incorporates adequate QA/QC activities to generate data of known and documented quality. The QAO reviews the preliminary CAFO Site-Specific Inspection Plan (see section 1.4.3 of this QAPP) prior to inspection, provide technical comments, if necessary, and ensure that the RSCC coordinates and schedules the analysis of parameters of concern with the applicable analytical methods and associated method performance measures. The QAO may also need to prepare the Statement of Work (SOW) that will be needed for sub-contracting sample analyses by a commercial laboratory.

4. Quality Assurance Officer (QAO)

Samples for biochemical oxygen demand (BOD) or nutrients (nitrogen, phosphorus, potassium) analyses will be done at <insert text> located in <insert text>. Due to short technical holding times, for CAFO inspections, samples for *E. Coli* and fecal coliform are sent to <insert text>. In some cases, samples may need to be shipped to a commercial or State lab. For the CAFO program, the <insert text> lab(s) is/are responsible for the following tasks: provision of “certified clean” sample containers and preservatives, sample analysis, data generation, data reduction and validation, submission of summary of analytical results and/or data print-outs (if requested) for each sample analysis to the inspector and the corresponding QC summary results for precision, accuracy and bias of the values reported.

1.3 Problem Definition/ Background

1.3.1 Background

The Federal and State National Pollutant Discharge Elimination System (NPDES) program monitors and regulates the discharge of pollutants from point sources to waters of the United States. Concentrated Animal Feeding Operations (CAFOs) are point sources, as defined by the CWA [Section 502(14)]. CAFO means an “animal feeding operation” (AFO) which meets the criteria in 40 CFR Part 122, appendix B, or which the EPA designates as a significant contributor of pollution pursuant to 40 CFR Part 122.23.

The purpose of this Generic Quality Assurance Project Plan (QAPP) is to provide Inspectors from <insert text> with a basic QAPP that will address the project required Data Quality Objectives (DQO) and provide guidelines on sample collection, sample documentation, analytical methods, and data validation and interpretation of data deliverables. This document was prepared in compliance with the EPA Order 5360.1A2 and the EPA QA/G-5 “*Guidance for Quality Assurance Project Plans, EPA/240/R-02/009*”.

1.3.2 Objectives/Scope

Determine compliance of CAFO discharges with the Clean Water Act through the collection of samples of opportunity from the facilities inspected.

1.4 Project/ Task Description and Schedule

1.4.1 Project/Task Description

This Generic QAPP is developed for the purpose of supporting announced and unannounced CAFO inspection and sampling activities that may be performed as part of the NPDES program. Samples for coliform determination will be analyzed by <insert text>. The lab must be accredited and /or certified by a recognized accrediting authority such as <insert text>. Samples for other parameters, if needed, will be analyzed by <insert text>. All of the analyses will be performed in accordance with the analytical methodologies and QC requirements specified in Table 3 - Data Quality Objectives Summary of this Generic QAPP. See the sample collection section and specific analyses that will be performed.

1.4.2 Schedule of Tasks

Table 1 – Activity Schedule and Tentative Start and Completion Dates*

Activity	Estimated Start Date	Estimated Completion Date	Comments
Obtain block of numbers from RSCC			
Mobilize to Sites	See CSSIP		
Sample Collection			
Analysis of Samples (on-site or fixed laboratory)			
Data Review & Verification, Reporting to Inspector			
Target Completion Date			

* Note: Most of the inspections are unannounced where the facilities inspected, availability of samples and the parameters of concern are unknown at the time of inspection. The inspectors are allowed to submit the CAFO Site-Specific Inspection QA Plan (last 2 pages of this generic QAPP) within 30 days from the last day of sample collection.

1.4.3 CAFO Site-Specific Inspection Plan (CSSIP)

This CAFO generic QAPP shall cover the QA requirements of all CAFO inspections performed by EPA inspectors within Region <insert text>. After <insert text> approval of this generic QAPP, the inspectors are only required to fill-out the summary of this generic QAPP called the “CAFO Site-Specific Inspection Plan (CSSIP)”. The CSSIP is a two-page summary of the sampling, analysis and QA requirements that may be performed during facility inspections. The CSSIP lists the name of facilities inspected, the samples of opportunity that were collected and the chemical and microbiological parameters that were determined by the lab. Table 3 - Data Quality Objectives Summary of this Generic QAPP is also a part of the CSSIP. The inspector(s) check mark the parameters listed in Table 2 applicable to the samples of opportunity collected from the facilities inspected. The draft CSSIP is submitted to the QAO assigned to the project prior to the inspection date for a quick review. A final CSSIP is submitted to the RSCC within 30 days from the last day of sample collection for filing. The first page of CSSIP contains the project, the account code, EPA sample numbers assigned for inspection, list of facilities inspected, address, contact person and phone number, the names of inspectors conducting the inspection and their respective environmental organization affiliations, the total number of samples collected per facility, and the parameters that were determined. The second page of CSSIP is the Table 3 – the Summary of Data Quality Objectives listing the number of samples collected, parameters for analysis, analytical procedures and methodologies and the precision, accuracy and other DQO requirements of the inspection. If applicable, Attachment 1 and 2 (Sample Alteration and Corrective Action Forms), may also be included with the CSSIP. The CSSIP is submitted to the QA Office for review and approval before a scheduled sampling event or immediately after collecting samples of opportunity. A blank 2 page CSSIP is attached In Appendix A of this Generic QAPP.

1.5 Data Quality Objectives and Criteria for Measurement Data

Data Quality Objectives (DQOs) are the quantitative and qualitative terms inspectors and project managers use to describe how good the data needs to be in order to meet the project’s objectives. DQOs for measurement data (referred to here as data quality indicators) are precision, accuracy, representativeness, completeness, comparability, and measurement range. The overall QA objective for analytical data is to ensure that data of known and acceptable quality are provided. To achieve this goal, data must be reviewed for 1) representativeness, 2) comparability, 3) precision, 4) accuracy (or bias), 5) completeness and 6) sensitivity. Precision, accuracy, sensitivity, completeness, sample representativeness and data comparability are necessary attributes to ensure that analytical data are reliable, scientifically sound, and legally defensible. Each analytical result or set of results generated should be fully defensible in any legal action, whether administrative, civil, or criminal.

Precision: The precision of each test depends on the number of tubes used for the analysis. The method that is used for the CAFO analysis (SM 9221) utilizes a confidence limit of 95 %. Samples in duplicate will be analyzed on a 10 % frequency (1 per 10 samples collected). The precision is evaluated using the Relative Percent Difference (RPD) values between the duplicate sample results.

Accuracy: This is not true relative to microbiology. The method has a detection limit of 1 MPN/100 ml. For other parameters analyzed in the fixed laboratory, accuracy will be evaluated by the use percent recovery (%R) of the target analyte in spiked or QC fortified samples.

$$\% \text{ Recovery} = \frac{\text{SQ} - \text{NQ}}{\text{S}} \times 100$$

SQ = quantity of spike found in sample

NQ = quantity found in native (unspiked) sample

S = quantity of spike or surrogate added to native sample

Representativeness is the degree to which data from the project accurately represent a particular characteristic of the environmental matrix which is being tested. Representativeness of samples is ensured by adherence to standard field sampling protocols and standard laboratory protocols. The design of the sampling scheme and number of samples should provide a representativeness of each matrix or product of the chemical processes being sampled.

Comparability is the measurement of the confidence in comparing the results of one sampling event with the results of another achieved by using the same matrix, sample location, sampling techniques and analytical methodologies.

Completeness: Completeness is the percentage of valid results obtained compared to the total number of samples taken for a parameter. Since sampling from inspections are usually grab and limited in number of samples, the number of valid results obtained from the analyses are expected to be equal or better than 85%. %Completeness may be calculated using the following formula:

$$\% \text{ Completeness} = \frac{\# \text{ of valid results}}{\# \text{ of samples taken}} \times 100$$

Sensitivity is the capability of a method or instrument to discriminate between measurement responses representing different levels of a parameter of interest. This is most often expressed in terms of method detection limit, instrument detection limit or laboratory quantitation (reporting) limit.

The QA objectives outlined, above, will be evaluated in conjunction with the data validation process.

1.6 Special Training Requirements/Certification

Inspectors are required to complete the 24-hour Basic Health and Safety training. The inspectors will obtain a basic health and safety training certification from the 24-hour training which should be maintained current by attending an 8-hour safety training refresher course every year. The inspectors must also have a signed and current “credential” certifying the

bearer as “Authorized to Conduct Investigations and Inspections Pursuant to All Federal Laws Administered by the United States Environmental Protection Agency”. All of the training courses listed above are provided by EPA Region <insert text>. Furthermore, sampling and sample documentation skills are also assured by the “mentoring” provided by the senior inspectors in the field.

The laboratories performing the sample analysis for this program are SDWA certified and/or accredited. Scientists (Microbiologists/Chemists) performing the analytical work for this project have extensive knowledge, skill and demonstrated experience in the execution of the analytical methods being requested.

1.7 Documentation and Records

Complete documentation for inspections may include but is not limited to the following forms which should be completed and collated by the EPA Inspector:

- Investigation Report
- Records Inspection Checklist
- Chain of Custody Logs
- Record of Sampling
- Laboratory Analysis Reports
- Photographs, Sketches, Paper Copies, Chemical Labels, MSDS, Application Records or other documentation.

Investigators will maintain field notes in a bound notebook and all documents, records, and data collected will be kept in a case file and submitted to the program office with the final inspection report.

The following documents will be archived at <insert text> or the designated laboratory performing the analysis: (1) signed hard copies of sampling and chain-of-custody records (2) electronic and hard copy of analytical data including extraction and sample preparation bench sheets, raw data and reduced analytical data.

The laboratory will store all sample receipt, sample login, extraction/preparation, and laboratory instrument print-outs and other analytical documentation as per their established SOP.

2.0 Measurement/ Data Acquisition

2.1 Sampling Process Design (Experimental Design)

Prior to compliance inspections, the EPA Inspector will review and evaluate facility files, if available, which may include facility background information, historical ownership, facility maps depicting general geographic location, property lines, surrounding land uses, a summary of all possible source areas of contamination, a summary of past permits requested and/or received,

any enforcement actions and their subsequent responses and a list of documents and studies prepared for the facility, records and inspection reports from previous compliance site visits.

Based on the data and/or a visual survey of the facility, samples of opportunity on an “as needed” basis will be collected for analysis to characterize the pollutants and determine if they are in compliance with the Clean Water Act.

2.2 Inspection and Sample Collection Procedures

2.2.1 Health and Safety

Inspectors visiting CAFO facilities, need to be aware of and sensitive to bio-security issues and/or procedures related to the potential disease transmission from one facility to another. Facility owners/operators may deny access to a facility because of the existence of a disease or illness at the facility. In addition, there is a real potential that the CAFO inspector may be the vector that transmits a disease from one facility to another if proper precautions are not taken. Minimal recommendations are that visitors to facilities wear freshly laundered clothing and clean footwear, or disposable and easy to clean rubberized rain gear, booties and gloves. EPA inspectors should follow the Agency’s Biosecurity guidelines (<http://www.epa.gov/agriculture/biosecurity.pdf>).

2.2.2 Location

CAFO inspectors should use the Global Positioning System (GPS) for documenting locations of facilities inspected. Upon return, the locational data from each GPS instrument should be differentially corrected by the person issuing the equipment.

2.2.3 Sample Collection

Sample collection methods can vary between standard operating procedures used by samplers and different conditions encountered in the field. The following is general guidance for samplers. Samplers should document in their notes or field checklist the actual method used during sample collection.

If samples are collected manually, rubber gloves should be worn to protect the sampler. Also, the use of safety glasses should be considered. Additional safety information should be covered in a site safety plan or pre-inspection safety briefing.

When a discharge point is identified, the sampler should consider collecting, when possible, samples at a minimum of one collection point. This collection point should be obtained at the discharge point. More sample collection points may be collected by the inspectors if necessary.

When dip samples are taken for coliform analysis, the sampler should carefully remove the cap, ensuring that neither the inside of sample bottle or cap are touched. If possible, hold the cap, do not set it down.

To the extent possible, take the sample by holding the bottle near its base in the hand and plunging it, neck downward, below the surface. Use an extension pole if needed to keep from walking into the effluent stream and stirring up the sampling area. Turn bottle until neck points slightly upward and mouth is directed towards the current. If there is no current, create a

current by pushing bottle forward horizontally in a direction away from the hand. If available, there are special apparatuses that will permit mechanical removal of the cap below the water surface. This can be used to avoid potential contamination of the sample by the sampler.

After collection, carefully recap the sample bottle securely. There should be a 1 inch head space in the neck of the bottle, to allow adequate mixing by the analyst. If, however, the sample container is overfilled, DO NOT pour-out any excess sample. Place the cap back securely on the sample bottle and return to analyst overfilled and a notation will be made in the analyst's report. The sample bottle should be labeled with the date and time of collection, collector's name and sample number, and type of analysis requested. This information should be written on the label using an indelible, waterproof ink. Sample bottle should be placed in plastic bags and stored on ice immediately following collection until they are accepted by the analyst. Proper chain of custody procedures should be followed at all times.

Transfer blank: Each inspector will be provided a single transfer blank for each facility to be inspected and an extra sterile bottle. Half way through the sample collection for each facility, transfer the contents of the full bottle into a sterile bottle. Be careful not to contaminate the inside of the bottle or cap during transfer. Label this bottle with date and time of transfer, name of collector, sample number and label the bottle as a TRANSFER BLANK.

If analysis of additional parameters is needed in a specific case, additional sample containers may be needed. Required sample volume, container type, preservation techniques, and holding times for parameters likely to be sampled are included in (Table 3). Inspectors should use their discretion on which parameters should be used to document violations at a particular facility and are encouraged to discuss this with representatives of the CAFO program.

2.2.4 Sample Collection Equipment

Equipment needs will vary from inspection to inspection. The list in Table 2 provides suggestions to be considered prior to leaving for the field.

Table 2 -Suggested Sample Equipment for CAFO Field Inspections

General	Safety	Emergency
Inspector Credentials Field Notebook Camera Waterproof Pens & Markers Clipboard flashlight Extension Sampling Pole Sample containers Ice Chest Disinfectant Solution (bleach) and Water for boots ¹ Extra Set of Coveralls GPS Unit	Water Proof (Rubber) Boots Rain gear Rubber gloves Soap, towels, and water for washing hands Eye protection Hard hat	First Aid Kit Phone numbers Cell Phone

- ¹ Inspectors/samplers are required to disinfect/decontaminate rubber boots before exiting CAFO facilities to help avoid transmitting animal pathogens from one facility to another. For more information, see Section 2.2.1 Health and Safety and 2.2.7 Decontamination Procedure of this QAPP.

2.2.5 Shipping Requirements

All of the samples are hand-delivered to the laboratory analyzing the samples. Samples for coliform analysis will be hand-delivered to the mobile microbiology laboratory within 6 hours of sample collection. Sufficient ice must be provided to ensure that samples remain cold until received and processed by the laboratory.

2.2.6 Decontamination Procedures

Samples will be collected using clean sampling devices and sample collection gears. Sampling devices and sample collection gear like rain gear, rubber boots and gloves will be cleaned and decontaminated using agricultural-approved disinfectants. Inspectors will follow the proper health and safety procedures when collecting and handling samples to minimize or not to incur contamination.

2.3 Analytical Methods Requirements

Not all parameters will be measured for each CAFO facility inspected. In some cases no samples will be taken at all, and in others, samples may be analyzed for coliform only. In other situations, samplers may be requested to collect additional data such as temperature, pH, turbidity, conductivity, etc. Table 3 -Data Quality Objective Summary lists the parameters that can be measured under this plan, the accuracy, precision, preservative, and holding time requirements.

2.4 Quality Control Requirements

Quality Control procedures for analyte measurements will be according to the requirements specified in the method that will be used in the analysis.

Laboratory instrumentation will be calibrated in accordance with the analytical procedure. Laboratory instrumentation will be maintained in accordance with the instrument manufacturer's specifications and the laboratory Standard Operating procedures (SOPs).

Other Quality Control Measures

- Media, reagents and water - Media and reagent water required for field analysis will be prepared and transported to the field site. QC tests specified for drinking water analysis will be conducted on these supplies prior to being transported. Media will be stored in tightly capped tubes in such a way to prevent formation of air bubbles and adverse environmental effects.
- Incubator and water bath - Temperature will be maintained within specified temperature ranges. Thermometers used for recording temperatures will be calibrated against NIST certified thermometer on a yearly basis. Temperatures will be read and recorded twice daily.

- Refrigerator (if present) - Temperature will be maintained within specified temperature ranges. Thermometers used for recording temperatures will be calibrated against NIST certified thermometer on a yearly basis. Temperatures will be read and recorded twice daily.
- Positive and negative culture controls: Organisms as specified in SM 9020B (Intra-laboratory QC guidelines) will be used on a daily basis to ensure the quality of the media and laboratory equipment has not changed.
- Negative laboratory control: A media sterile check will be done on a daily basis to ensure that no changes in media sterility have occurred.
- Duplicates: Ten percent (10%) of routine samples will be processed in duplicate, or a minimum of one per day that samples are received, whichever is greater. A duplicate sample is performed from the same sample bottle. Samples for microbiological analyses on-site are not required to be preserved.
- Laboratory Temperature: Must be maintained within a few degrees of 35 °C to ensure incubator temperature consistency. This will be accomplished with the use of thermostatically controlled electric heaters or thermostatically controlled propane forced air heater.
- Sample Disposal: All “spent” growth media will be autoclaved prior to disposal. All unused water samples will be disposed of in a manner that will not result in contamination of the surrounding environment.

2.5 Instrument/Equipment Testing, Inspection and Maintenance Requirements

The laboratory will follow their standard operating procedures for any preventative maintenance required on laboratory instruments or systems used for this project.

2.6 Instrument Calibration and Frequency

Field maintenance and calibration will be performed where appropriate prior to use of the instruments. Calibration of samplers will be performed in accordance with the methodologies used in sample collection and the Instruments Operational Instructions.

The laboratory will follow the calibration procedures found in the methods listed in Table 3 or in the laboratory’s SOPs.

2.7 Inspection/Acceptance Requirements for Supplies and Consumables

Sample bottles used for microbial testing will be appropriately cleaned and sterilized. They will be certified clean polypropylene bottles (250 or 500 mL). All sample jars used for chemical analysis in this project will be new and certified clean provided by the laboratory. Investigators will make note of the information on the certificate of analysis that accompanies sample jars to ensure that they meet the specifications and guidance for contaminant free sample containers.

2.8 Data Acquisition Requirements (non-Direct Measurements)

Not Applicable.

2.9 Data Management

A field log notebook, photos, GPS location data and the Field Sample and Chain of Custody Data Sheets will be used to document the sampling and inspection activities. For each sample location, the following will be recorded in the notebook:

- facility name and address
- sample number
- date
- time of each sample collection
- physical description of each sample collection point
- weather conditions
- color
- sample appearance
- sample identifier, and measurements

The Field Sample and Chain of Custody Data Sheets will have the following information:

- site name
- sample number
- date
- time of each sample collection
- sampler's name or initials
- sample location.

If applicable, a suffix I -FD will be appended to the sample identified as the field duplicate. For fixed laboratory analyses, field duplicates will be assigned a separate unique sample identifier and will be submitted 'blind' to the analytical laboratory. Analytical duplicate results will be reported with a trailing -AD (analytical duplicate) or D.

All inspection reports including those for potential enforcement cases will be completed within 30 days of inspection date. Validated laboratory results and interpretation (if necessary) will be appended. Reports will be maintained as enforcement confidential documents until release is approved by the USEPA Office of Regional Counsel (ORC). Photographs and other supporting data along with the inspection report will be used to determine NPDES compliance.

All data generated during this project will be processed, stored, and distributed according to laboratory's SOPs.

3.0 Assessment/Oversight

3.1 Assessments and Response Actions

The EPA Inspector will be responsible for reviewing field log notebooks for accuracy and completeness within 48 hours of each inspection. Sample results provided to the EPA Inspector by the laboratory will be appended to the inspection reports. The EPA Inspector will compare the sample information in the field log notebooks with the analytical results appended to the inspection report to ensure that no transcriptions errors have occurred.

With the exception of the microbiological analyses, RPDs between field duplicate and analytical duplicate measurements will be calculated by the laboratory. RPD's greater than the project requirements will be noted in the associated inspection reports.

Laboratories routinely perform performance checks using different program specific quarterly blind and double blind check standards. Each method of analysis requires specific QA/QC runs that must be complied with by the laboratory performing the analysis. An internal assessment of the data and results are also routinely conducted by the appropriate supervisors and the Laboratory QA Coordinator. No additional audits will be performed on the laboratory for this project.

Corrective action procedures that might be implemented from QA results or detection of unacceptable data will be developed if required and documented in Attachment 2.

3.2 Reports to Management

Only the data validation reports with the properly qualified data shall be provided by the laboratory to the Program Manager and/or Inspectors. If, for any reason, the schedules or procedures above cannot be followed, the EPA Inspector must complete the Attachment 1-Sample Alteration Form (SAF). The SAF should be reviewed and approved by the QAO. The laboratory should be given a copy of the QAO approved SAF for reference and project file.

4.0 Data Validation and Usability

4.1 Data Review, Validation, and Verification Requirements

The criteria for the validation will follow those specified in this QA plan and the criteria specified in the methods.

4.2 Validation and Verification Methods

All data generated shall be validated in accordance with the QA/QC requirements specified in the methods, and the technical specifications outlined in the QAPP. The summary of all analytical results will be reported to the EPA Inspector and the Program Manager. The raw data for this project shall be maintained by the laboratory. Data validation will be performed by the laboratory for all the analyses prior to the release of data. The laboratory will also archive the analytical data into their laboratory data management system.

4.3 Reconciliation with User Requirements

All data and related information obtained during the course of this project will be included in a data report package.

Table 3 - Data Quality Objectives Summary

Analytical Group	Number of Samples ¹	# of Field QA Samples: Dups & Blanks (Bottle/Rinsate/Lot /Filter)	MS / MSD Samples	Matrix	Method	Method Detection Limits	Accuracy	Precision (RPD)	Completeness	Preservation	Volume, Container	Holding Time (days)
Mobile Laboratory Measurements												
Fecal Coliform Mobile Lab or Contract lab		10% dup or 1 per day	NA	Water / sludge	9221C, E	1 MPN/ 100 ml	1 MPN/ 100 ml	varies	95	Cool on ice	Use sample from Fecal Coliform	6 hours ³
E. Coli Mobile Lab or Contract Lab		10% dup or 1 per day	NA	Water / sludge	9221 F or 9223 DQ	1 MPN / 100 ml	1 MPN / 100 ml	varies	95	Cool on ice	Use sample from Fecal Coliform	6 hours ³
Fixed Laboratory Measurements												
TKN ⁴		10% dup or 1 per day		Water / sludge	351.2	0.2 mg/ L	75-125%	± 20RPD	95	Cool on Ice H ₂ SO ₄ <2	250 mL P, G ⁶	28 days
Nitrate-Nitrite		10% dup or 1 per day		Water / sludge	353.2	0.2 mg/ L	75-125%	± 20RPD	95	Cool on Ice H ₂ SO ₄ <2	250 mL P, G ⁶	28 days
Total Phosphorus		10% dup or 1 per day		Water / sludge	365.1	0.01 mg/L	75-125%	± 20RPD	95	Cool on Ice H ₂ SO ₄ <2	250 mL P, G ⁶	28 days
BOD		10% dup or 1 per day		Water / sludge	5210B	4 mg/L	NA	± 20RPD	95	Cool on Ice	2,500 mL P, G (may use 1 gal cubitainer)	48 hours (receipt at lab by noon on last day of collection)
Potassium		10% dup or 1 per day		Water / sludge	200.7	0.7 mg/ L	75-125%	± 20RPD	95	Cool on Ice HNO ₃ <2 ⁵	250 mL P, G	180 days

Table 3 - Data Quality Objectives Summary

Analytical Group	Number of Samples ¹	# of Field QA Samples: Dups & Blanks (Bottle/Rinsate/Lot /Filter)	MS / MSD Samples	Matrix	Method	Method Detection Limits	Accuracy	Precision (RPD)	Completeness	Preservation	Volume, Container	Holding Time (days)
Field Measurements (optional - water samples only)												
Dissolved Oxygen		10% dup or 1 per day		Water	360.1	0.1 mg/L	0.2 mg/L	± 20 RPD	100	Not Required	500 ml G	Analyze Immediately
Turbidity Mobile Lab		10% dup or 1 per day		Water	180.1	0.1 NTU	0.5 NTU	± 20 RPD	100	Cool on Ice	100 mL	48 hours
pH		10% dup or 1 per day		Water	150.1	0.1 pH Units	0.1 pH Units	± 0.2 pH Units	100	Not Required	100 ml P, G	Analyze Immediately
Temperature		10% dup or 1 per day		Water	2250B	0.1 °C	0.3 °C	± 20 RPD	100	Not Required	Not Required	Analyze Immediately

¹ - Sample number includes QA samples and Matrix Spike / Matrix Spike Duplicate (MS/MSD) samples listed in the next two columns. P, G - Plastic, Glass.

² - Sodium thiosulfate

³ - Non-potable water samples have a 6 hour holding time from the time of sample collection until receipt at the laboratory. Additional 2 hours holding time are allowed from the verified time of sample receipt in the lab until the samples are seeded into an inoculation broth.

⁴ - Total Kjeldahl Nitrogen

⁵ -Due to shipping restrictions on nitric acid, preservation for potassium may be performed at the lab and the sample held for 18-24 hours prior to sub-sampling.

⁶ - Samples for NO₃+NO₂, TKN, and Total Phosphorus may be combined in one sample container however the required volume increases. Use a 1L P,G bottle if combining nutrients.

Attachment 1-Sample Alteration Form

Project Name and Number: _____

Sample Matrix: _____

Measurement Parameter: _____

Standard Procedure for Field Collection & Laboratory Analysis (cite reference):

Reason for Change in Field Procedure or Analysis Variation:

Variation from Field or Analytical Procedure:

Special Equipment, Materials or Personnel Required:

Initiators Name: _____ Date: _____

Project Officer: _____ Date: _____

Quality Staff: _____ Date: _____

Attachment 2-Corrective Action Form

Project Name and Number: _____

Sample Dates Involved: _____

Measurement Parameter: _____

Acceptable Data Range: _____

Problem Areas Requiring Corrective Action: _____

Measures Required to Correct Problem(s): _____

Means of Detecting Problems and Verifying Correction: _____

Initiators Name: _____ Date: _____

Project Officer: _____ Date: _____

Quality Staff: _____ Date: _____

CAFO Inspection Generic QAPP
Appendix A: Site-Specific Inspection Plan (CSSIP)

This CSSIP will be prepared and used in conjunction with the Generic CAFO QAPP for collecting samples of opportunity during announced and unannounced inspections. Please refer to the Generic QAPP for specific details regarding CSSIP.

Project Code(s)	Sample Numbers	EPA Inspectors/Phone Numbers/Mail Stop
(As noted below)	(Assigned in blocks of 50 sample IDs per Project Code)	

COOPERATING AGENCIES/PARTIES INVOLVED:

Contact Person	Agency	Phone

LIST OF FACILITIES INSPECTED:

Facility Name	Assigned Project Code	Address	Contact person	E-mail/phone Number	# Samples Collected*

*Samples Collected is an estimate prior to the inspection and will be submitted in final form after the inspection is complete.

Parameter(s) to be tested (should match entries on DQO Table):

TENTATIVE PROJECT SCHEDULE:

Activity	Est. Start Date	Est. Completion Date	Comments
Mobilize to Site			
Sample Collection			
Laboratory Receipt of Samples			
Target Completion Date			

DATA DISTRIBUTION:

Name and Mail Stop	Electronic	Hard Copy

Concurrence with the CSSIP:

QA Chemist: _____ Date: _____
 Name and Signature

Inspector: _____ Date: _____
 Name and Signature

Instructions

<Insert Region specific instructions>

CSSIP Page 2 - Table of Data Quality Objectives Summary

Analytical Group	Number of Samples ¹	# of Field QA Samples: Dups & Blanks (Bottle/Rinse/ Lot /Filter)	MS / MSD Samples	Matrix	Method	Method Detection Limits	Accuracy	Precision (RPD)	Completeness	Preservation	Volume, Container	Holding Time (days)
Mobile Laboratory Measurements												
Fecal Coliform Mobile Lab or Contract Lab		10% dup or 1 per day	NA	Water / sludge	9221 C, E	1 MPN/ 100 ml	1 MPN/ 100 ml	varies	95	Cool on ice	Use sample from Fecal Coliform	6 hours ³
E. Coli Mobile Lab or Contract Lab		10% dup or 1 per day	NA	Water / sludge	9221 F or 9223 DQ	1 MPN / 100 ml	1 MPN / 100 ml	varies	95	Cool on ice	Use sample from Fecal Coliform	6 hours ³
Fixed Laboratory Measurements												
TKN ⁴		10% dup or 1 per day		Water / sludge	351.2	0.2 mg/ L	75- 125%	± 20RPD	95	Cool on Ice H ₂ SO ₄ <2	250 mL P, G ⁶	28 days
Nitrate-Nitrite		10% dup or 1 per day		Water / sludge	353.2	0.2 mg/ L	75- 125%	± 20RPD	95	Cool on Ice H ₂ SO ₄ <2	250 mL P, G ⁶	28 days
Total Phosphorus		10% dup or 1 per day		Water / sludge	365.1	0.01 mg/L	75- 125%	± 20RPD	95	Cool on Ice H ₂ SO ₄ <2	250 mL P, G ⁶	28 days

Analytical Group	Number of Samples ¹	# of Field QA Samples: Dups & Blanks (Bottle/Rinse/ Lot /Filter)	MS / MSD Samples	Matrix	Method	Method Detection Limits	Accuracy	Precision (RPD)	Completeness	Preservation	Volume, Container	Holding Time (days)
BOD		10% dup or 1 per day		Water / sludge	5210 B	4 mg/L	NA	± 20RPD	95	Cool on Ice	2,500 mL P, G (may use 1 gal cubitainer)	48 hours (receipt at lab by noon on last day of collection)
Potassium		10% dup or 1 per day		Water / sludge	200.7	0.7 mg/L	75-125%	± 20RPD	95	Cool on Ice HNO ₃ <2 ⁵	250 mL P, G	180 days
Field Measurements (optional - water samples only)												
Dissolved Oxygen		10% dup or 1 per day		Water	360.1	0.1 mg/L	0.2 mg/L	± 20 RPD	100	Not Required	500 ml G	Analyze Immediately
Turbidity Mobile Lab		10% dup or 1 per day		Water	180.1	0.1 NTU	0.5 NTU	± 20 RPD	100	Cool on Ice	100 mL	48 hours
pH		10% dup or 1 per day		Water	150.1	0.1 pH Units	0.1 pH Units	± 0.2 pH Units	100	Not Required	100 ml P, G	Analyze Immediately
Temperature		10% dup or 1 per day		Water	2250 B	0.1 °C	0.3 °C	± 20 RPD	100	Not Required	Not Required	Analyze Immediately

¹ - Sample number includes QA samples and Matrix Spike / Matrix Spike Duplicate (MS/MSD) samples listed in the next two columns. P, G - Plastic, Glass.

² - Sodium thiosulfate

³ - Non-potable water samples have a 6 hour holding time from the time of sample collection until receipt at the laboratory. Additional 2 hours holding time are allowed from the verified time of sample receipt in the lab until the samples are seeded into an inoculation broth.

⁴ - Total Kjeldahl Nitrogen

⁵ - Due to shipping restrictions on nitric acid, preservation for potassium may be performed at the lab and the sample held for 18-24 hours prior to sub-sampling.

⁶ - Samples for NO₃+NO₂, TKN, and Total Phosphorus may be combined in one sample container however the required volume increases. Use a 1L P,G bottle if combining nutrients.

Appendix AO – Detailed Review of Nutrient Management Plan Implementation

DETAILED ANALYSIS OF NMP IMPLEMENTATION

Evaluation of the calculations and records associated with the NMP typically will focus on the site-specific terms of the NMP that have been incorporated as conditions of the CAFO's permit. NMP review of the land application elements will focus on the nutrient transport risk assessment, rate calculations, and land application records.

When evaluating the land application requirements of the NMP, use the elements in Table 1 to help identify potential compliance alerts and clarification questions to ask the facility.

Table 1: NMP Land Application Records and Recordkeeping Expectations

NMP Records to be Reviewed	Expectation for What Will be Recorded
How much manure does the CAFO generate each year?	This information is used to determine if the CAFO has adequate storage and land application fields or if manure must be transferred off-site.
If the CAFO does not land apply manure, can they produce manure transfer records to account for disposal of all manure?	Manure transfer records should account for all manure generated. The CAFO must also have manure test results provided to each manure hauler.
How many land application fields under the CAFO's control are used and what is the total acreage?	Amount of manure land applied divided by available acreage approximates the weight of manure applied per acre.
Does every acre receive manure every year or are the fields rotated? If rotated, does the CAFO have a quantitative approach to determine which fields receive manure each year?	If the CAFO is relying on multiyear phosphorus application, ³⁵ they must be able to demonstrate that they are not over applying in frequency or amount.
Are setbacks or buffers from down gradient surface waters documented and implemented?	The CAFO representative will need to identify which fields have buffers or setbacks and show at least one of these to the inspector.
Do NMP records account for all forms of manure present at the CAFO (solid, slurry, and liquid)?	If the CAFOs sampling is representative, nutrient application will be based on sample results from all forms of manure. Otherwise, the CAFO may over- or under-apply as a result of not accounting for nutrients in all manure forms.
Does the CAFO have recent sampling and analysis records for all manure sources?	Nutrient application rates must be based on the most recent manure nutrient results. If manure nutrient content changes significantly from values used in the nutrient

³⁵ For a discussion of multiyear phosphorus application refer to section 6.3 of EPA's *Permit Writers' Manual for CAFOs* (February 2012).

NMP Records to be Reviewed	Expectation for What Will be Recorded
	management plan, the nutrient management plan should be updated to reflect the new values.
Does the CAFO have recent soil sampling and analysis records, P risk assessments, and rate calculations for all fields currently receiving or scheduled to receive manure?	Non-recent of these may not reflect current conditions and result in over- or under-application of nutrients and potential environmental harm from offsite transport of phosphorus in runoff.
What crops are planted or planned for nutrient application fields and what are the nutrient uptake rates for these crops?	Different crops have different nutrient uptake rates and timing considerations for nutrient applications. The CAFO should base application rate calculation on book value nutrient uptake rates specific to the state or region, or actual uptake rates based on recent plant tissue samples. In the latter case, the CAFO should provide laboratory reports in support of the results. The inspector should field-verify the crops being grown in one or more land application fields. Appendix I contains photos of the growth stages of common field crops.

Nutrient Application Rate Calculations

For permitted CAFOs, the permit writer will have already ensured that the methodology used to calculate rates in the NMP is consistent with the permit and applicable technical standards. The inspector's job is to verify that the actual manure application rates are being calculated in accordance with the NMP methodology. This determination will depend on whether the NMP terms were developed in accordance with the linear or narrative rate approach as discussed below.

Terms Applicable to Linear and Narrative Rate Approaches Fields Available for Land Application

The NMP will identify each field where land application is planned. The inspector should compare the land application records with the fields identified in the NMP to ensure manure, litter, or process wastewater were not applied to fields that are not covered by the plan. Use of a land application site that is not identified in the NMP constitutes non-compliance with a permit term. Also, addition of a land application site not covered by an approved NMP constitutes a substantial change to the NMP that requires a permit modification with associated permitting authority review and public notice.

Timing Limitations for Land Application

As described in [Chapter 6.5.1](#) of the *Permit Writers' Manual for CAFOs* this term refers to limitations described in the technical standards for when manure applications should be prohibited or delayed. The inspector should check land application records to see if the applicable timing limitations are being followed. In some cases this will be a straightforward evaluation. Often, however, evaluating compliance will require the inspector and case officer to use professional judgment and diverse resources, as illustrated by the examples below.

EXAMPLE COMPLIANCE EVALUATION FOR TIMING LIMITATIONS

Example Timing Limitation

Manure shall not be spread between December 1 and March 15.

Compliance Evaluation

Check land application dates to ensure manure has not been spread during the restricted time frame.

Example Timing Limitation

Delay field application of animal manures or organic by-products if precipitation capable of producing runoff and erosion is forecast within 24 hours of the time of the planned application.

Compliance Evaluation

Compare land application dates with local precipitation records. If precipitation occurred within a day of land application, additional evaluation may be warranted to determine whether:

1) The precipitation was capable of producing runoff and erosion. In some cases this may be determined using on-site records, though these types of records are not common. Several modeling tools are available to predict soil erosion based on precipitation events and field conditions including, but not limited to:

- Water Erosion Prediction Project (WEPP) Model (<http://www.ars.usda.gov/Research/docs.htm?docid=10621>)
- CREAMS, A field scale model for Chemicals, Runoff, and Erosion from Agricultural Management Systems
- Areal Nonpoint Source Watershed Environment Response Simulator (ANSWERS)

Document Review Tip: Spot check records for a single field

- ✓ Does the CAFO have current soil and manure test results for the field and source of manure applied?
- ✓ Are the calculations for planned manure application rates consistent with the NMP methodology?
- ✓ Are actual manure application rates consistent with calculated rates?
- ✓ Are the total nutrient applications (from manure and other sources) consistent with crop nutrient recommendations?
- ✓ Did the CAFO perform a phosphorus index risk assessment for the field?
- ✓ Is the CAFO applying phosphorus at a rate consistent with the phosphorus transport risk assessment?
- ✓ Was manure applied on the same day as, or the day before, a significant rain event?

It is usually easiest and least expensive for a CAFO to apply manure to the field nearest the manure

- AGNPS model (<http://go.usa.gov/KFO>)

2) The precipitation was forecast at the time of application. There are many sources of historical weather information; unfortunately, historical weather forecasts are more difficult to obtain. If local newspaper archives are available, these may be a resource for determining the forecast for a specific date.

If these two pieces of information can be determined, the inspector and case officer then would have to use professional judgment to deduce whether the CAFO operator should reasonably have been aware that precipitation capable of producing runoff and erosion was forecast within 24 hours at the time the manure was applied. Because the analysis is resource-intensive and somewhat subjective, retrospective compliance determination for this type of timing limitation may not be practical. If an inspector is concerned that the CAFO operator may be applying manure without consideration for timing limitations, real-time monitoring might be a better method for evaluating compliance. Records obtained during an on-site inspection can be used to predict typical application schedules for a particular operation. It may be beneficial to conduct drive-by inspections during these time frames when significant rainfall is predicted to determine whether land application is occurring.

Example Timing Limitation

Wastewater shall not be applied when the ground is frozen or saturated or during rainfall events.

Compliance Evaluation

Determining whether manure or wastewater was applied during rainfall events is relatively straightforward but may require some judgment or interpretation. The inspector can compare land application dates with local precipitation records. CAFOs often maintain daily precipitation logs. Alternatively, Internet resources such as The Weather Underground (www.weatherunderground.com) and Utah Climate Center (<http://climate.usurf.usu.edu/products/data.php>) can be used to determine whether a rainfall event occurred, at least at a nearby weather station, on a specific date. Unless the data document the time of application and precipitation, it might not be possible to positively determine whether the two events were concurrent, but the inspector and case officer can use information such as the magnitude of the rainfall, whether rainfall occurred on the previous and/or subsequent days, the amount of manure or wastewater applied, and other circumstantial data to assess the likelihood that manure or wastewater was applied during a rainfall event.

Evaluating whether wastewater was applied on frozen or saturated ground is more complex. Many variables such as season, latitude, altitude, proximity of lakes and rivers, and local landscape, can affect when soils freeze and thaw. To predict soil saturation the inspector and case officer would need information on soil types including antecedent soil moisture, hydraulic conductivity, infiltration rate, and precipitation and irrigation history. Here again, the evaluation is time-consuming and because it is not based on direct observation may not result in a positive determination of non-compliance. If the land application records for a facility

suggest the CAFO operator is applying wastewater to frozen or snow-covered ground, it may be more effective for an inspector to visit CAFOs under those conditions to observe whether land application is occurring.

Outcome of the Field-Specific Assessment of the Potential for Nitrogen and Phosphorus Transport from Each Field

The inspector should ensure the calculated land application rates are consistent with the rate recommendation from the technical standards based on the outcome of the risk assessment.

Some states require CAFOs to use a nitrogen leaching index or other tool to assess the risk of nitrogen movement to groundwater. Where such a tool is required and strictly focuses on groundwater protection, use of the tool is not a federally enforceable requirement under the NPDES program. However, where there is a direct hydrologic link from groundwater to surface waters and a nitrogen leaching risk assessment is required as part of the technical standards for nutrient management, the inspector should check to ensure that any rate limitations or management practice specifications associated with the outcome of the leaching index are being implemented.

CAFO inspectors should be familiar with the phosphorus risk assessment tool required by the applicable technical standards for nutrient management. Often, this will be the state's Phosphorus Index (P Index), but could also be a soil test phosphorus method, a phosphorus environmental threshold, or other similar assessment tool. Where the risk assessment for a field indicates that manure application should be restricted to a phosphorus-based rate, any application exceeding that rate is inappropriate unless the state allows multi-year phosphorus application. Where rates are P-limited and multi-year P applications are made, the inspector should review the land application records to ensure the applications are consistent with all restrictions associated with the multi-year P flexibility (e.g., no additional P applied until the P applied in single year has been removed through uptake and harvest, the total multi-year rate does not exceed the single-year N recommendation, location or timing restrictions).

The inspector should also check to see that the risk assessment rating is being re-calculated at appropriate intervals. Some state technical standards may specify re-calculation at a specific frequency or based on specific triggers. Even if the permit or technical standards do not specifically require re-calculation of the risk assessment outcome, the inspector should be aware of circumstances under which a field should be re-assessed. These circumstances will depend on the specific risk assessment used. In general, where there is a change in any of the factors used in calculating the risk of nutrient transport, the risk should be re-assessed. For example, many P Indices account for the conservation practices implemented on a field when evaluating the risk of nutrient transport from that field. If the CAFO operator changes the conservation practices used on a field, then the P Index for that field should be re-calculated. Any change to a field that might reasonably result in an increase in the nutrient transport risk could be considered a trigger for recalculating that field's risk assessment.

In states that allow use of more than one type of phosphorus risk assessment, the inspector should check to be sure that the assessment tool used in the NMP submitted with the application for permit coverage is used throughout the permit term. A CAFO may not switch to

a different risk assessment method during the permit term unless the permit is revised to reflect the new term for the outcome of the field specific assessment, as this would trigger a substantial permit modification. See Chapter 4.1.7 of the *NPDES Permit Writers' Manual for CAFOs* (EPA, 2012a).

The examples below illustrate compliance evaluations for the most common types of risk assessment tools:

Example: Nitrogen Leaching Index Outcome

Net Score: 13

Risk Interpretation: This field has a HIGH risk for nitrogen leaching and management changes should be implemented to decrease risk. Manure should be applied at P agronomic rates. Apply nitrogen using split in-season applications at or below the agronomic rate. Changes in irrigation management and/or method may also be necessary. If there is an underlying aquifer that is shallow (< 20 ft.) or used locally as a public drinking water source, increase the risk to VERY HIGH. [Colorado NRCS. 2006, Colorado Nitrogen Leaching Index Risk Assessment (Version 2.0). Agronomy Technical Note No. 97 (revised), August 25, 2006. <http://efotg.sc.egov.usda.gov/references/public/CO/COATN_97v2.pdf >)]

Compliance Evaluation

Terms like “should” and “may be necessary” complicate compliance evaluation for this type of requirement. The inspector and case officer will need to use professional judgment to determine what practices, including phosphorus-based rates and irrigation management changes, the CAFO operator should reasonably be expected to implement. In this case, split in-season nitrogen application is required; the inspector should review the NMP and land application records to ensure that this practice is used. If inorganic nitrogen sources (e.g., anhydrous ammonia, urea) are used, the inspector should keep in mind that the entire manure nitrogen contribution may be applied at one time. Local recommendations for practices like split nitrogen application can be used as guidelines for evaluating compliance if the practices are not covered in the technical standards for nutrient management; Land Grant Universities are good sources for recommendations on agricultural practices.

Example: Soil Test Phosphorus Level

Soil test phosphorus level (Bray P1/Mehlich 3 ppm): 63 ppm

Basis for nutrient application: Not to exceed 1.5 x crop P₂O₅ removal [Indiana NRCS. 2001. Conservation Practice Standard, Nutrient Management, Code 590. Indiana Natural Resources Conservation Service Field Office Technical Guide—July 2001.]

Compliance Evaluation

The inspector should verify that the soil test phosphorus result used to determine the basis for nutrient application is current and based on the appropriate extraction method. Next, the inspector should evaluate the calculated land application rates to verify that the planned application does not exceed 1.5 times the crop P₂O₅ removal rate.

Example: Soil Phosphorus Threshold Level

Soil test phosphorus threshold: 40 ppm (Olsen), 60 ppm (Bray-1), 6 ppm (Morgan)

Soil test phosphorus level: 50 ppm (Olsen)

Phosphorus application rate: Crop rotational phosphorus uptake [Idaho NRCS. 2007. Conservation Practice Standard, Nutrient Management, Code 590. Idaho Natural Resources Conservation Service Field Office Technical Guide— June 2007.]

Compliance Evaluation

The inspector should verify that the soil test phosphorus result used to determine the basis for nutrient application is current and based on the appropriate extraction method. Next, the inspector should check the calculated land application rates to verify that the planned application does not exceed the crop phosphorus uptake rate.

Example: Phosphorus Index

Phosphorus index value and risk rating: 12, Medium risk

Recommended rate basis: Nitrogen-based application

Compliance Evaluation

If not already done during the permitting process, the inspector should review the factors used to calculate the P Index value to ensure the values appear to reasonably reflect site conditions. Those factors might include soil erosion, runoff class, soil test phosphorus, phosphorus application rates, and conservation practices. Factors like soil test phosphorus, application rates, and conservation practices can be checked against facility records. Others, like runoff class or other soil properties, can be checked against soil surveys (available through NRCS's Web Soil Survey: <http://websoilsurvey.nrcs.usda.gov/app/HomePage.htm>). Soil erosion is usually calculated using the Revised Universal Soil Loss Equation, version 1 (RUSLE2). RUSLE2 is a computer model that uses a detailed mathematical approach for integrating multiple equations that describe how certain factors affect soil erosion. Appendix A of the *NPDES Permit Writers' Guide for CAFOs* contains a detailed discussion of RUSLE2. The inspector also should evaluate calculated land application rates to ensure that the planned nitrogen application does not exceed the recommendation.

A Note on Phosphorus Recommendations

The inspector should be aware of differences between the several types of phosphorus recommendations that may be seen.

- Soil test phosphorus recommendation: A recommendation for the amount of additional phosphorus needed in the soil to ensure an optimal level of phosphorus to support achievement of maximum potential crop yield.
- Phosphorus crop uptake: The amount of phosphorus a crop will take up from the soil during its life cycle.
- Phosphorus crop removal: The amount of phosphorus that will be removed from the field through crop uptake and harvest. This amount may be less than the phosphorus crop uptake amount since a portion of the plant may remain in the field after harvest and the nutrients in the crop residue returned to the soil.

Planned Crop or Other Use

The rate calculations in the NMP are based on the crop or crop rotation planned for each field. The inspector should evaluate land application records to ensure the crops actually grown in the field are the same as the crops that were planned for that field during that year. The only exception would be for the use of alternative crops included in the NMP, which is discussed below as a term for the narrative rate approach.

A Note on Yield Goals

The inspector should check on-site records, where available, to ensure that actual yields are consistent with the yield goals used in the NMP.

Total Nitrogen and Phosphorus Recommendations for Each Crop

During the permitting process, the permit writer will evaluate these recommendations to ensure they are consistent with the planned crops and yields in accordance with the technical standards for nutrient management. For the total nitrogen recommendation and phosphorus recommendations based on crop uptake or removal, this permitting evaluation is adequate. For a total phosphorus recommendation that is based on soil test phosphorus levels, the inspector can check the facility records for the soil phosphorus analysis used as the basis for the recommendation included in the NMP. Specifically, the inspector can check to see if the analysis uses the appropriate extraction method as specified in the technical standard for nutrient management, that the soil sample was taken at the correct depth (see *Soil Sampling* in Chapter 5.9.2 of the *NPDES Permit Writers' Manual for CAFOs* (EPA, 2012a)), and that the analysis reports phosphorus in the same form as used in the soil test recommendation. Phosphorus is commonly reported as either elemental phosphorus (or total P) or phosphorus pentoxide (P_2O_5). Total P can be converted to P_2O_5 as follows: $P_2O_5 = P \times 2.29$.

Realistic Annual Yield Goals

The realistic yield goal is an estimated potential for crop yield for a given field. The total nutrient requirements for fields are largely based on the CAFOs expected crop yields; generally, the higher the yield expectation, the higher the nutrient requirement. An unrealistic estimate can result in either a deficiency or an excess of nutrients being applied. In addition to crop variety and climate, crop yields are influenced by field-specific factors including, among others, soil fertility, soil type, crop management and pest control. Thus, estimated yields can be expected to vary for different fields. State technical standards for nutrient management need to identify acceptable methods and data sources for establishing realistic yield goals. One way to establish realistic yield goals is to use the average of the three highest yields of the five most recent years that the specific crop was grown in the field. For new operations where production records are not available, CAFOs may need to use information available through county NRCS field offices or from local farmers.

Terms Applicable to the Linear Approach

Credits for Plant Available Nitrogen in the Field

Under the linear approach, the credits from the nitrogen that will be available to the crop from all other sources are terms. These other sources include nitrogen credits from mineralization and legumes.

Nitrogen credits are a term even for a field with a phosphorus-based rate because the nitrogen credit is needed to calculate the appropriate amount of supplemental nitrogen to be added to the field to ensure that the crop's nitrogen requirement is not exceeded.

Consideration of Multi-Year Phosphorus Application

Where a phosphorus-based rate is required, technical standards for nutrient management might allow several years' worth of phosphorus to be applied in a single application. For an NMP that includes multi-year phosphorus application, the permit term will identify the field, crop, and year for the application. Where allowed, a multi-year phosphorus application should not exceed the nitrogen recommendation for the year of the application, and no additional phosphorus should be applied until the amount supplied in the multi-year application is removed through crop uptake and harvest. Technical standards for nutrient management might include additional restrictions or requirements for where or when such applications are allowed and what practices must be implemented to reduce the risk of nutrient loss from a multi-year phosphorus application. The inspector should evaluate land application records to verify that multi-year applications did not occur during any year or on any field or crop not identified in the NMP. For any field where a multi-year application was used, the inspector should also determine the number of years covered by the application and check to see that phosphorus was removed during the subsequent years through harvest as specified in the NMP and that no additional phosphorus was applied for the number of years covered by the multi-year application. In addition, the inspector should check for implementation of any specifications for multi-year in the permit or technical standards for nutrient management.

For example, Illinois' General NPDES Permit for Concentrated Animal Feeding Operations (Permit No. ILA01) requires site-specific practices, determined through assessment procedures to be specified in the NMP, to minimize runoff of P applied to land in a multi-year P application. For a permitted CAFO in Illinois, the inspector should first determine that the assessment procedures specified in the NMP were followed and ascertain the practices that were identified as a result of the assessment. Then the inspector should check to see if those practices were implemented to minimize phosphorus runoff from the multi-year phosphorus application.

Accounting for All Other Additions of Plant Available Nitrogen and Phosphorus

As described in the *NPDES Permit Writers' Manual for CAFOs* (EPA, 2012a), this term captures all non-manure nutrient sources (e.g., chemical fertilizers, biosolids, and nutrients in irrigation water). The permit term will identify the "other additions" that are planned for each field and crop for each year of permit coverage. The inspector should evaluate land application records to see if only the nutrient sources identified in the NMP were actually applied to the field. It is important to note that the term does not obligate the CAFO operator to use a specific nutrient source. So, for example, if the NMP indicates that Field X will receive nitrogen from process wastewater and irrigation water in a certain year but the land application records indicate that only manure was applied, the permit term has not been violated. However, for the same scenario, if the land application records indicate that process wastewater and anhydrous ammonia were applied, the facility would be out of compliance with the permit term because the NMP had not accounted for the use of anhydrous ammonia.

In addition, the term does not limit the amount of nutrients supplied through “other additions.” For example, a CAFO’s NMP indicates that Field X will receive 100 pounds of nitrogen per acre from process wastewater and 50 pounds per acre of nitrogen from irrigation water. However, rainfall was lower than average and the CAFO operator had to irrigate more than anticipated, thereby supplying more nitrogen from irrigation water than expected. The term *accounting for all other additions of plant available nitrogen and phosphorus* is not violated because additional nitrogen was applied from irrigation water. However, in this case the inspector would need to check that the amount of nitrogen supplied from process wastewater was decreased accordingly so that the total nitrogen application did not exceed the term *total nitrogen recommendation for each crop*.

Form and Source of Manure that Is Land Applied

The inspector should compare the form and source of manure to be applied to each field and crop, identified in permit terms, with the land application records to see if the planned form(s) and source(s) were used.

Timing and Method of Land Application

The permit term for timing should be as specific as needed to reflect how the timing impacts nutrient availability in the application rate calculation. Therefore, the inspector should rely on the permit term, and not necessarily the application timing specified in the NMP to evaluate compliance. The specificity of the term will be guided by the state technical standards for nutrient management and, largely, the nitrogen availability factors that are required. For example, many states provide a single availability factor or mineralization rate for seasonal (i.e., fall or spring) application. In those states, the permit term might simply specify fall or spring application. In some cases, a permit term might be as specific as “within two weeks before planting.” In most cases the CAFO’s NMP will include a specific date for planned applications since most nutrient management planning programs require a specific date. EPA does not expect permit terms to require a specific application date. The compliance evaluation depends on the term that was identified for *timing of land application*. The inspector must make sure the actual nutrient applications identified in the facility records are consistent with the permit term.

The permit term for method of application will specify at least whether the surface or subsurface application is planned and may be as specific as identifying the type of equipment that will be used. The term should also reflect whether the manure is to be incorporated within a certain time frame. The CAFO inspector should evaluate land application records to see if the actual method of application, including time to incorporation, is consistent with the planned method reflected in the permit term.

Maximum Amount of Nitrogen and Phosphorus from Manure, Litter and Process Wastewater

The permit term will be expressed as the maximum pounds per acre of nitrogen that may be applied to each field for each year of permit coverage. The term will also include a maximum amount of phosphorus, in pounds per acre per year, for fields where application is limited to phosphorus-based rates. The inspector should evaluate land application records to see if the actual amount of nitrogen (or nitrogen and phosphorus where applicable) applied did not

exceed the amount specified in the permit term. The inspector should verify that the land application records document nutrient application using the same chemical forms used in the permit term.

Methodology to Account for the Amount of Nitrogen and Phosphorus in the Manure to be Applied

For the linear approach, only the actual amount of manure, litter, or process wastewater to be applied should vary on an annual basis since the maximum amount of N and P to be applied from manure is a permit term. The NMP and permit term should describe the specific methodology used to make this calculation. The amount of manure to be applied will depend on the results of the annual manure analysis and the calculation will be similar to the following:

$$\frac{\text{Pounds of N or P to be applied per acre}}{\text{Pounds of N or P per ton or gallon of manure}} = \text{Tons or gallons of manure to be applied per acre}$$

The inspector should check the CAFO's records to verify that the amount of manure to be applied was calculated in accordance with the methodology specified in the permit term. In general, the following information will be needed to make this determination using the formula above:

- *Maximum amount of N (and P as applicable) from manure, litter, and process wastewater:* This is a permit term and should be identified in the permit
- *Pounds of N (and P as applicable) per ton or gallon of manure:* The source for this data is the result of the manure analysis used to calculate the manure application rates. The inspector should check to be sure that the analysis is for a recent sample, taken no more than 12 months before the date of application, and that the analysis is representative of the material applied. Most importantly, the sample should represent the actual source of the manure, litter, or process wastewater applied. A sample may represent multiple sources (i.e., storage structures) only if the manure sources and management structures for those two sources are so similar as to support a reasonable expectation that that the nutrient content of the manure will be the same.

Consider, for example, two dairies, each with a milking parlor, outdoor confinement areas, a solids separator, and two impoundments. At Dairy A, all process wastewater, including wash water from the milking parlor, flush water from the feed lane, and runoff from the pens flows to the solids separator. Effluent from the separator can be directed to either of the two impoundments; the dairy allows one impoundment to fill and then directs wastewater to the second impoundment while the first is being emptied. Because the contents of each impoundment are from the same source and managed the same, it is reasonable to expect that a wastewater taken from one impoundment would represent the nutrient content of both impoundments. At Dairy B, milk parlor wash water and feed lane flush water are directed to the separator. Effluent from the separator can be directed to either of the two impoundments. Runoff from the pens

flows directly to one of the impoundments. At this dairy, it may not be reasonable to expect that wastewater from both impoundments would have the same nutrient content since one impoundment receives wastewater from a source that is significantly different from the other (runoff from the pens).

The inspector should also make sure that the pounds of N or P per ton or gallon of manure used to calculate the amount of manure to apply is expressed using the same chemical form as provided on the manure analysis or has been calculated or converted appropriately. For nitrogen-based application rates, planners and CAFO operators often calculate the amount of plant available nitrogen in the manure to be applied. This is calculated by adding the inorganic forms (typically ammonium and nitrate) and the portion of organic nitrogen that will be available in the first year after application (based on the mineralization rates specified in the technical standards).

Terms Applicable to Narrative Rate Approach

Maximum Amount of Nitrogen and Phosphorus from All Sources of Nutrients

Different than the linear approach where land application rates are expressed in terms of the amount of nutrients to be applied from manure, the narrative rate approach sets an upper limit on the amount of nutrients to be applied from all sources. The term is the maximum amount of nitrogen and phosphorus derived from all sources of nutrients for each crop identified in the NMP in chemical forms determined to be acceptable to the Director, in pounds per acre, for each field. In the narrative rate approach, the maximum limit is identified only for each crop but does not need to be reported each year that the crop is planted.

The maximum amount of nitrogen from all sources under the narrative rate approach is based on the maximum amount of nitrogen that can be applied to a field for the specified crop based on crop type, yield goal, and current nitrogen soil test – where required. The maximum amount of nitrogen from all sources is the same value reported for the term, total crop nitrogen recommendation.

The maximum amount of phosphorus from all sources can be set for each crop according to the maximum amount of phosphorus applied in any one year for any one crop based on the outcome of the field-specific risk assessment. This preserves the flexibility of the narrative rate approach. Because the phosphorus site index changes with different crops and years, different rates of manure can be applied according to P-Index recommended rates. Manure may be applied at N-based rates for some years and crops and P-based rates for other years and crops.

EXAMPLE COMPLIANCE EVALUATION:

MAXIMUM AMOUNT OF NITROGEN AND PHOSPHORUS FROM ALL SOURCES OF NUTRIENTS

Compliance Evaluation

To evaluate this term, the inspector will check to see if a total crop nutrient recommendation exists for each crop included in the NMP. The total nutrients land applied must not exceed the calculated total crop nutrient recommendations for a specific crop.

Compliance Issues

- Nutrients applied from all sources exceed the total crop nutrient recommendation calculated for a specific crop.
- The CAFO did not calculate the maximum amount of nutrients that can be applied to a specific crop.
- The CAFO did not account for crop type, yield goal and current soil test when determining the total crop nitrogen recommendation.
- The CAFO did not conduct a field-specific risk assessment when determining the total crop phosphorus recommendation.

Alternative Crops

The narrative rate approach allows for greater flexibility than the linear approach by allowing the NMP to include alternative crops that may be planted in lieu of those included in the planned rotation. If alternative crops are included, the NMP must also identify for each alternative crop realistic yield goals and nitrogen and phosphorus recommendations. The term includes the alternative crops listed in the NMP, along with their associated yield goals and nitrogen and phosphorus recommendations.

EXAMPLE COMPLIANCE EVALUATION: ALTERNATIVE CROPS

Example: At CAFO A the north field typically is planted in wheat. However, when wheat prices drop, CAFO A plants alfalfa. CAFO A must include wheat and alfalfa plus their respectively yield goals and, nitrogen and phosphorus recommendations in the NMP.

Under the Narrative Approach, the methodology must account for the following factors:

- ✓ Credits for PAN in the field
- ✓ Amount of nitrogen and phosphorus in the manure to be applied
- ✓ Consideration of multi-year phosphorus application
- ✓ Accounting for all other additions of plant available nitrogen and phosphorus to the field
- ✓ Form and source of manure, litter and process wastewater
- ✓ Timing and method of land application
- ✓ Soil test results
- ✓ Volatilization of nitrogen and mineralization of organic nitrogen

Compliance Evaluation

The inspector should verify that any crop listed in CAFO A's land application records or actual crop(s) planted in the land application areas are included in the NMP.

Compliance Issues

- The crop observed growing in a land application area is not included in the NMP.
- During the review of land application records, a crop included in the manure application records is not listed in the NMP.

Methodology

Unlike the linear approach where permit terms are factors of the methodology, the factors themselves are not required to be terms in the narrative approach, but rather the methodology used to account for them in the CAFO's NMP is a term. Under the narrative rate approach, the methodology is the enforceable permit term, rather than the factors included.

As long as the methodology presented in the NMP is followed and includes all necessary factors, the calculated amount of manure, litter, or process wastewater can change from year to year.

EXAMPLE COMPLIANCE EVALUATION: METHODOLOGY

Compliance Evaluation

As previously mentioned, the permit writer will have already ensured that the methodology used to calculate rates in the NMP is consistent with the permit and applicable technical standards. The inspector should see if the actual manure application rates are being calculated in accordance with the NMP methodology.

The following factors must be accounted for in calculating the rates of manure application:

- Credits for Plant Available Nitrogen (PAN) in the field
- Amount of nitrogen and phosphorus in the manure to be applied
- Consideration of multi-year phosphorus application
- Accounting for all other additions of plant available nitrogen and phosphorus to the field
- Form and source of manure, litter and process wastewater
- Timing and method of land application
- Soil test results
- Volatilization of nitrogen and mineralization of organic nitrogen

Compliance Issues

- CAFO is not able to document values used in the application rate calculations (e.g., no laboratory results for soil and manure analyses).
- Application rate calculations are based on a different methodology than presented in the NMP.
- CAFO does not account for additional commercial fertilizer applications or other sources of nutrients.

Records for Permitted Medium and Small CAFOs

Permitted medium and small CAFOs are subject to the same requirements as a Large Permitted CAFO, with the exception of the ELG. Permitted medium and small CAFOs must maintain records to document NMP development and implementation. See Table 2 below for examples of records that might be maintained to document implementation of the nine minimum measures as well as potential compliance alerts suggesting non-compliance with the specific requirements. Permitted medium and small CAFOs are not subject to the ELG. Any technology-based requirements and associated records will be specified in the permit for a medium or small CAFO and may be similar to the ELG requirements for large CAFOs.

Records for Unpermitted Large CAFOs

Unpermitted large CAFOs are not required to develop and implement an NMP, but are required to maintain records documenting implementation of nutrient management practices that address three of the nine NMP minimum measures to qualify for the agricultural stormwater exemption. Unpermitted large CAFOs must have records indicating that they are implementing 40 CFR Part 122.42(e)(1)(vi)-(ix) on their land application sites to ensure appropriate agricultural utilization of land applied nutrients. These practices ensure that precipitation-related discharges from the land application areas qualify for the agricultural stormwater exemption. As provided in Table 2 below, records must exist for measures 6 through 8.

Table 2: Example Records to Evaluate Minimum Measures

Measure	Example Records	Potential Compliance Alerts
Identify site-specific conservation practices to be implemented, including buffers or equivalent practices, to control runoff of pollutants to waters of the United States [40 CFR Part 122.42(e)(1)(vi)]	<ul style="list-style-type: none"> • NMP or CNMP • Engineering drawings or as built drawings showing the location and dimension of berms, buffers, setbacks, and other conservation practices between land application fields or production areas and WOUS • Narrative descriptions of conservation practices implemented to control pollutant runoff, such as NRCS conservation practice standards 	<ul style="list-style-type: none"> • The CAFO does not have documentation of buffers, setbacks, or other conservation practices to minimize nutrient runoff to nearby WOUS. • Conservation practices are identified but do not include operation and maintenance protocols to ensure long-term effectiveness to control pollutant runoff.

Measure	Example Records	Potential Compliance Alerts
<p>Identify protocols for appropriate testing of manure, litter, process wastewater, and soil [40 CFR Part 122.42(e)(1)(vii)]</p>	<ul style="list-style-type: none"> • NMP or CNMP • A facility sampling plan that identifies sampling locations, sampling frequency, analytical methods, and laboratories for manure, litter, process wastewater, and soil analysis • Laboratory reports that identify testing procedures and results for manure, litter, process wastewater, and soil 	<ul style="list-style-type: none"> • The CAFO land applies manure or wastewater without sampling the nutrient content of manure and soil. • Soil and manure analyses are not current. • Manure and process wastewater analysis are not representative of all sources that are land applied. • Soil analyses are not available for all fields used for land application. • Soil or manure analytical results are not consistent with those used to calculate land application rates.
<p>Establish protocols to land apply manure, litter or process wastewater to ensure appropriate agricultural utilization of the nutrients in the manure, litter or process wastewater [40 CFR Part 122.42(e)(1)(viii)]</p>	<ul style="list-style-type: none"> • Site map showing land application fields • NMP or CNMP • Manure spreading agreements • Manure application rate calculations in accordance with the methodology in the NMP • Land application records • Application equipment inspection logs 	<ul style="list-style-type: none"> • No documentation of manure application rates, protocols, or schedules. • The CAFO land applies manure and/or wastewater without agronomic rate calculations supporting the application. • Manure application at rates higher than the rates calculated in accordance with the NMP. • Manure is applied at a constant rate across all fields and crop types. • Land application records are incomplete (e.g., do not specify manure source, amount, dates, application method, etc.). • Actual amount of nutrients applied is calculated at the end of the season rather than tracked for each application event. • Manure is applied to fields that are not identified in the NMP.

Appendix AP – Inspection Report Template (R7)

INSPECTION REPORT TEMPLATE

Example: Structure for Model Inspection Report

All inspection reports should be structured and formatted in an organized way. This example identifies each of the major sections of the report. Each section in this example report has the purpose to communicate specific information as simply and cleanly as possible. This format can be adapted to all types of inspection reports.

It is essential to remember that our goal is clear communication of essential information. We can use our computers' ability to indent, bold, italics, color, change fonts, etc. to help us construct a clear and easy to understand report. Once your master report is completed you can use it to "cut and paste" into additional reports.

Comments: Comments are made throughout the report to highlight important points or identify critical information. Comments are shown in brackets and *[italics]*.

Boiler Plate: Certain sections of the report should use "boiler plate" language. This language should be used for all inspection reports. Slight modifications may be made to accommodate changes in inspection type.

Attachments: Attachments are to be listed in a logical order from Attachment 1, at the beginning of the report, to Attachment 1 + n, at the end of the report. Please reference Attachments as often as needed to clearly present your findings.

Photographs: Photographs need to be referenced, and referenced as often as needed. All photograph numbers should match the photograph log from the field. Photo location and direction should be noted on maps or diagrams using a circle with the photo number in it and an arrow to note direction (σ).

Acronyms: All acronyms will be defined at their first use. For example: I conducted a Confined Animal Feeding Operation (CAFO) inspection at Beefmaster Feeders (BF).

REPORT OF CONFINED ANIMAL FEEDING OPERATION INSPECTION

At

BEEFMASTER FEED YARD

**Rural Route 2, Box 31
Tall Prairie, Kansas**

NPDES Permit Number: KS023764

[use appropriate media program ID or Permit number]

June 5, 2005

By

**U.S. ENVIRONMENTAL PROTECTION AGENCY
Region VII
Enforcement Coordination Office**

[The title area should be center justified, Arial font, bold, size 12, and capitalized as shown]

1.0 INTRODUCTION *[All section headings should be left justified, Arial font, bold, size 12, and all capitalized. This section describes who requested the inspection and under what authority it was conducted.]*

[Boiler plate – Use correct name, address, and date]

At the request of the Water, Wetlands and Pesticides Division, Water Enforcement Branch, I performed a Concentrated Animal Feeding Operation (CAFO³) inspection at Beefmaster Feed Yard on June 5, 2005. This inspection was performed pursuant to Section 308(a) of the Federal Water Pollution Control Act, as amended. The CAFO inspection was conducted as a Level B Multimedia Inspection, and the *Region 7 Multimedia Screening Checklist* (MMSC) is included as Attachment 1 *[if completed]*. This narrative report and attachments present the findings and observations made during the inspection.

[The text of the general body of this report should be left justified, Times New Roman font, size 12, and double-spaced after each period. Please be careful not to allow “widows and orphans” and ensure that new section titles are not be left dangling at the bottom of the page.]

2.0 PARTICIPANTS

[List all those who participated in the inspection activity: name, title, organization)

Beefmaster Feed Yard (BFY):

Tex Ritter, General Manager*

Jill Oakly, Safety Manager*

Kansas Department of Environment (KDE):

John Wayne, Inspector*

U.S. Environmental Protection Agency (EPA):

Angus Steak, CAFO Inspector

*Copy of business card included in Attachment 2 .

3.0 INSPECTION PROCEDURES

[Boiler plate -- Note: In this section, you describe the general procedures used during your inspection, including: SOPs used, initial facility contact, initial site entry, personal identification, purpose, scope, objectives and flow of the inspection, verification that you are at the correct facility and that you are talking with the correct person who can act as the official facility representative, confidential business information, notices of potential violations, and Section 1001 and 1002 of US Code, etc.]

I conducted this inspection in accordance with the procedures described herein and the following EPA Region VII Standard Operating Procedures (SOPs), unless otherwise noted:

<u>SOP No.</u>	
2332.09	Bio-Security Procedures for Conducting NPDES Compliance Evaluations at Animal Feeding Operation
A29392	Sampling of CAFO wastes. <i>[if sampling occurred]</i>

[List all applicable SOPs that are used.]

Prior to beginning the inspection, I conducted a visual reconnaissance of the BFY facility and its surroundings from the public right-of-way. This included State Hwy 24, County road "H" and an un-named road on the north side of the facility. During my reconnaissance, I searched for areas of environmental concern, discharges, drainage patterns, flow directions, distance and direction of nearest perennial waters, visual condition of perennial waters, facility location and layout and potential issues covered on the MMSC. I identified no obvious environmental issues or concerns during this preliminary examination. *[If you did identify a significant issue, state briefly what it was and that it will be fully described later in the report.]*

I contacted Mr. Ritter *[who]*, General Manager, of BFY, by telephone *[how]*, on June 4, 2005, the day before the inspection, at approximately 1300 hrs *[when]*. I conducted this pre-notification to facilitate my access to the facility *[why]*. I informed Mr. Ritter that I would be conducting an inspection at his facility *[where]* on the afternoon of June 5 *[when]*. I asked him if he would be available at that time. He said that he would. Additionally, Mr. Wayne, the KDE inspector, accompanied me during the inspection. *[The theme of answering the questions of*

*who, what, when, where, how, and why, **MUST** run throughout you report and each of the questions needs to be answered to the best of your ability.]*

I arrived at BFY at approximately 1400 hrs on June 5, 2005. Upon arrival, I introduced myself and presented my credentials to Mr. Ritter and Ms. Oakly. I also provided them my business card. I asked Mr. Ritter if he was able to act as the “Official Facility Representative” for the BYF. He said that he would represent the facility. I asked him what he was responsible for and how long he had those responsibilities. Mr. Ritter said that he is responsible for the overall management of the facility and that he had been the General Manager for the last ten years. He said Ms. Oakly was BFY’s Safety Manager, and that she has held that position for the last eight years. Ms. Oakly verified what Mr. Ritter said, and explained she was responsible for all environmental management and compliance activities at BFY.

I explained to them that I would be conducting a Concentrated Animal Feeding Operation (CAFO) inspection under the authority of Section 308 (a) of the Federal Water Pollution Control Act to evaluate their compliance status with their NPDES permit *[if the facility is not permitted, you would say, “their compliance with the requirements of the CWA and determine whether or not they require a permit”]*. I also informed them that I would also be evaluating compliance with several other regulatory requirements through the completion of a Multimedia Screening Checklist. I explained that the inspection would consist of a review of facility operations, required records, waste generation and management practices, and a visual inspection of the site. I stated that I would document my findings and observations by making copies, taking photographs and/or videos, obtaining statements from facility staff, and collecting samples if necessary *[state: “and by collecting samples,” if this was a sampling inspection]*.

I explained to Mr. Ritter and Ms. Oakly that in order to fully understand their operations and properly evaluate their compliance status, it is important that I collect truthful and accurate information. I asked them to inform me anytime they were uncertain about what they were providing me or if they did not understand what I was asking. I presented Mr. Ritter and

Ms. Oakly a copy of *Section 1001 and 1002 of the U.S. Federal Code*** concerning making false statements to federal inspectors. I asked them if they understood Section 1001 and 1002. They said, “Yes, they did.”

At the conclusion of the inspection, I summarized my preliminary findings and observations to Mr. Ritter and Ms. Oakly. I explained BFY’s right to make a claim of business confidentiality and presented Mr. Ritter with a *Confidentiality Notice*** (Attachment 3). Mr. Ritter did not make any confidentiality claims at the time of the inspection. I prepared a *Receipt for Documents and Samples*** (Attachment 4) for all material I received from Mr. Ritter and provided him with a copy of the receipt *[if copies or other material were received]*. I completed an In-Briefing/Exit-Briefing checklist and a CAFO inspection checklist during the inspection (Attachments 5 and 6 respectively). I prepared and presented Mr. Ritter with a *Notice of Preliminary Findings*** (NOPF -Attachment 7) form. I explained that this form documents those observations and preliminary findings made during the inspection process and that the preliminary findings are based on my knowledge of what I observed and knew at the time. I also explained that these findings do not constitute a final enforcement determination and are provided to assist the

facility in their compliance efforts. I explained his need to respond within 10-days. Mr. Ritter acknowledged receipt of these forms by signing them.

*[** Titles of documents should be in italic print]*

4.0 FACILITY DESCRIPTION

[This section of the report will vary based on the facility inspected and the specific findings, observations, and potential violations and regulatory concerns you identify. Please use the format and cover each section identified below.

Please focus on using short, easy to understand sentences, and a separate paragraph for each new train of thought or topic. Use first person, active voice, and strive to present the material in order to minimize your chance of being misunderstood.

For each statement or fact that you present, you must be able to describe or explain “How you know what you know.” If it is not obvious to the reader how you know or knew it, either do not include the statement, rewrite the statement, obtain the appropriate information need to demonstrate how you know what you are saying. If necessary, identify areas where additional inquiry is needed.

For each potential violation or regulatory concern, present the information using a “Compare and Contrast style.” Make sure you address each “Element of Proof” for each component of the potential violation identified in the law, permit, or regulation. This is essential to a good report. For example, a large CAFO needs to have 1000 head of cattle (Element of proof #1) on-site for more than 45-days/year (Element of proof #2) – I counted 2750 head on the day of the inspection and Mr. Ritter’s inventory records (Attachment) show that he had at least that number of cattle on-site for 250 days during the last year.]

4.1 Facility Operations

[This section should provide a brief description of the facility location, the owner, the operator (if different from the owner), number of employees, years at this location, prior operations at this location, size, and a general overview of operations. A more specific description of operations should be described in the sections of this report were the specific description relates directly to the compliance requirements.]

According to Mr. Ritter, BFY is located approximately 3 miles north of Tall Prairie, Kansas (see map, Attachment). The facility address is 40410 NW 20th Avenue, Tall Prairie, KS. *[Note mailing address if different]* The legal description is contained in (Attachment – *[Do not copy the legal description into the report if possible as they are very exact and errors can be easily made]*).

Mr. Ritter stated that the facility employs three full time employees and 2 seasonal employees. He said that BFY was constructed in 1962 has been a feeding operation ever since. He said that Mr. Beefmaster owns BFY.

Mr. Ritter stated that BFY operates a feedlot on approximately 201 acres which are divided into 25 pens. He said that BFY also leases an additional 7,000 acres (see map, Attachment) for grazing, corn production, and land application. He said that BFY currently has approximately 3550 head of cattle in the pens and that he is permitted for a maximum of 5000 head. He said

that all runoff from the 25 pens drain through a series of ditches and runoff control berms into a single five acre lagoon. Mr. Ritter said that he has three center pivot irrigation units for land application of lagoon wastewater on approximately 60 acres.

Mr. Ritter said that manure from the pens is scraped weekly and sold to a composting operation located adjacent to the facility. He said that BFY has three manure storage areas onsite (shown in Attachment .) Mr. Ritter said the runoff from these manure storage areas is captured by the facility lagoon system.

Mr. Ritter also said that BFY has one 500-gallon used oil tank, one 1000-gallon diesel tank, and two 560-gallon gas tanks (Photos 1-3).

4.2 CAFO Status and NPDES Permit Status

[In this section, you need to demonstrate that you have determined that the facility meets the minimum criteria to be subject to the CAFO requirements and you should identify if they are a permitted facility and their key permit requirements, e.g., maximum capacity and that the permit was still in force and has not expired.]

BFY has an NPDES permit for their CAFO that limits the maximum number of cattle to 5000 head. The permit was issued by NDEQ on December 12, 2003 (Attachment). The permit will expire on December 11, 2008. I inspected the facility for compliance with the permit requirements. *[If the facility does not have a permit, skip this type of paragraph.]*

Based on my observations of the cattle on-site, a review of facility records and statements by Mr. Ritter, BFY is confining at least 1,000 (total) head of cattle for more than 45 days during the last twelve month period. During my inspection, I estimated the number of cattle in each of the pens to be approximately 3300-3700 head on the day of the inspection. I reviewed inventory and sales documents which show that there were more than 2500 head on-site continuously during the last 12 month period (Attachment). Mr. Ritter stated that he had 3550 head on the day of the inspection and that there were at least 2500 head on-site during the last 12 months. My inspection of the pens also revealed no vegetative cover in any of the pens (see photo 6-10). As a result of my observations, this facility meets the definition of large CAFO as it is defined at Title 40 of the Code of Federal Regulations, Part 122.23.

4.3 Regulatory History

[Please describe any past inspection activities, compliance orders, previous violations, concerns, or other issues found during your file review or inspection that may affect potential enforcement at this facility. Remember who, when, and what.]

The Nebraska Department of Environmental Quality conducted an inspection of the facility on December 2, 2004 (Attachment). The inspection report lists the following as areas of concern: *[NEVER make a statement like “The inspection report states that the facility was in compliance at the time of the inspection.” This is unnecessary and only opens the door to questions and other issues regarding EPA vs. State findings.]*

1. The facility was granted a 90-day extension to complete the permeability tests on the lagoon. The deadline for completion is now March 12, 2005.

2. KLA Environmental will be conducting the permeability test. To conduct this test, the water level of the lagoon needs has to be increased by 1 ft in order to float the test equipment. It is estimated that it will take two days to complete the test and return the water level to its original level.

I asked Mr. Ritter what were the results of the permeability tests and if the lagoon was returned to its original level within the two days. He said that the tests were completed on March 2, 2005 and that the permeability of the soil met the permit requirements (Attachment). He also said that he dewatered the lagoon after the test in order to immediately return it to its original level.

On August 24, 1999, EPA Region VII conducted an inspection of the facility. This inspection led EPA to issue an administrative compliance order (ACO) to the facility on December 21, 1999 (See Attachment). The following is a summary of the violations listed in the ACO:

1. The facility did not record the freeboard levels in the lagoons on a daily basis when the levels were less than required by the NPDES permit.
2. Wastewater was land applied during days with precipitation in excess of 0.05 inches and on days immediately preceded by more than 0.05 inches of precipitation.
3. Pond #9 was not completed as described in the facility NPDES permit.
4. Pond #5 did not have a staff gauge.
5. The staff gauges in the remainder of the ponds were tilted and leaning in such a way that determining the required depth was difficult.

5. FINDINGS AND OBSERVATIONS

[In this section you will identify your findings and observations on the day of the inspection. Include rainfall data from nearest official weather station if it is or has been raining within the week prior to the inspections. Remember to include distance, slope, and drainage information to the nearest perennial waters of the U.S.]

Mr. Ritter said he recorded 0.65 inches of precipitation at the feed yard the day before the inspection. I reviewed the last three years of precipitation records required by BFY's permit and observed that the recent rainfall events had been recorded, as well as, previous rainfall events for the past three years. Except for the dust being minimized on the day of the inspection, I did not observe any other impacts of the limited amount of rainfall on the day before the inspection.

Mr. Ritter said that BFY uses tractor-pulled scrapers to clean the pens on a weekly basis to keep them clean and dry. During my inspection of the pens, they appeared to be well maintained (photo). I also verified that the drainage from all of the pens would flow into the lagoon during a rainfall event by physically observing the slope and flow control structures, i.e., ditches flowing to the lagoon. If an overflow were to occur, it would flow from the northeast corner of the lagoon dam (photo) into Jenkins Creek. According to the USGS topographical map, Jenkins Creek is the nearest perennial stream and is approximately 200 yards from the lagoon dam (Attachment).

I inspected the three manure piles located south of the lagoon (see map) and noted that two were quite large (photo) and one was much smaller (photo). I verified that the drainage from the manure piles goes to the lagoons as described by Mr. Ritter. Mr. Ritter said that all of the manure generated by the facility is either sold to a composting operation, located adjacent to the feedlot, or is given away to private individuals. Mr. Ritter provided me with a copy of his records showing the amount of manure picked up by the composting operation (B&G Potting Soil, Inc.) or given away from January 13, 2003 to the present (See sales records Attachment).

During the inspection, I observed the freeboard level in the facility lagoon and compared it against what was specified in BFY's permit.

NOPF #1 – Failure to Maintain Adequate Freeboard - Section B, Operation and Maintenance Requirements, of the facilities NPDES permit states: *“Whenever the available storage capacity is less than the amounts specified in Table 1, dewatering shall be initiated and conducted on all days suitable for land application of wastes until the required storage capacity is again available.”* Table 1 requires that a freeboard level of five feet be maintained. I observed that the freeboard level was four feet on the day of the inspection. I obtained this level by reading it off the staff gage located in the South end of the lagoon. According to Mr. Ritter, this is the deepest portion of the lagoon.

Mr. Ritter said that he had been busy and just did not get around to pumping down the lagoon. He also said that he was aware of the five foot minimum level.

NOPF #2 – Failure to Fully Maintain Monthly Operating Log - Section C, Operation and Maintenance Requirements, of the facilities NPDES permit states: *“A written operational*

log shall be maintained. For each day waste is applied, information recorded shall include; soil condition (frozen/ thawed, etc.), quantity of waste applied, and the area where the waste was applied.” During my review of BFY’s monthly operating log, I observed that the condition of the soil in the land application area is not specified on land application days (Attachment). Mr. Ritter land applies over approximately 60 acres with center pivot irrigation systems.

The current NPDES permit does not specify the amount of time the facility is required to wait following a precipitation event until land application can proceed.

NOPF #3: Failure to Maintain Records for Three Years – *Appendix 3 of BFY’s permit, requires BFY to maintain daily records of lagoon levels. During my review of the records, I observed that BFY was not keeping a log of daily lagoon levels prior to March 16, 2003 (Attachment). Mr. Ritter said that he first became aware of this requirement as a result on an December 2, 2004 NDEQ inspection.*

[NOTE 1: All potential violations and/or concerns should be described using separate, indented paragraphs, italics and bold text as shown above. It is critical that they stand out from the rest of the report.

Note 2: If this facility did not have a permit, you should document the same type of information that a basic NPDES CAFO would require, just not cite it on the NOPF.]

Example of Sampling:

According to BFY precipitation logs (Attachment), BFY had three inches of rain in the last 48 hours. This is much less then the seven inches of a 25 year, 24-hr storm event.

NOPF #4: Discharging in Excess of Permit Limitations - *Section D, Discharges, of BFY’s permit states: “The facility will not discharge any wastewater unless it is the result of a 25 year, 24-hour storm event.” I observed the lagoon overflowing (photo). I followed the overflow, down gradient, approximately 200 yards to where it entered Jenkins Creek (photo 10, note dark discoloration of the overflow material). As I walked this path, I took readings with my inclinometer at several points (see map) and noted that the grade was approximately 5%. I collected samples approximately 100 yards up-stream from the discharge point (point A), at the discharge point (point B), and approximately 100 yards down stream of the discharge point (point C). The samples show (Attachment – Analytical Sample Data) an increase in fecal coliform in the receiving stream from the upstream point (point A) to the downstream point (point C). What is notable about the results, is that the concentration of fecal coliform at point C is approximately 60 times higher than it was upstream (point A). The concentration of fecal coliform downstream was 1,750,000 CFU/ 100ml. The NDEQ Water Quality Standards establish a limit of 200 CFU/ 100 ml for all state waterbodies if there is a possibility it can be used for full body contact recreation. Jenkins Creek is routinely used for swimming by local children near the stream access (point D), approximately ¾ mile downstream from the discharge point B. Sampling at point D showed a fecal coliform concentration of 600,000 CFU/100ml, well above the state standard.*

[Note 3: If the facility is discharging to Waters of the U.S. and they do not have a permit, you would cite them for “Unlawful Discharge of Pollutants to Water of the U.S.” per Section 301 , CWA.]

6. OTHER REGULATORY CONCERNS

As noted earlier, I conducted this inspection as a Level B Multimedia inspection. Part of the MMSC covers the requirements for Spill Prevention Control and Countermeasures (SPCC). I observed five fuel storage tanks on-site during the inspection. I observed that two of the tanks, identified as T1 and T2 by Mr. Ritter (photo), were being used and three were in the process of construction. The smaller of the two tanks (T-1) had a capacity of 1,000 gallons and, according to Mr. Ritter, contained #2 off-road diesel. Mr. Ritter also stated that the larger tank (T-2) had a capacity of 4,000 gallons and contained unleaded gasoline. I asked Mr. Ritter if these two tanks were full. He said yes, that they had just been filled last month (see fuel receipt, Attachment). The three new tanks each will have a capacity of 1000-gallons each and will have secondary containment.

Concern: Failure to Have and SPCC Plan or Secondary Containment – 40 CFR Part 112 requires all oil tanks with a combined capacity of greater than 1320 gallons to have secondary containment and an SPCC plan approved by a Professional Engineer. I did not observe secondary containment around either tank T-1 or T-2 (photo). Mr. Ritter stated that he did not have an SPCC plan.

I observed one maintenance shop located on the west side of the facility (see map). Mr. Ritter said that the shop generates used oil but he did not know what the generation rate was. He said that used oil is stored in an approximately 2000-gallon tank on the north side of the shop.

CONCERN: Labeling of Used Oil Tank - 40 CFR Part 279 requires all generators of used to label their used oil containers with the words “USED OIL.” I observed that the used oil tank was not labeled with the words used oil (photo).

Angus Steak, CAFO Inspector

Date

ATTACHMENTS:

1. Multimedia Screening Checklist (1 page)
2. Copy of Business Cards (varies)
3. Confidentiality Notice (1 page)
4. Receipt for Documents and Samples (1 page)
5. In-Briefing/Exit-Briefing checklist (1 page)
6. CAFO Inspection Checklist (? pages)
7. Notice of Potential Violations (3 pages)
8. Other attachments listed in order

Photographs (18)

Appendix AQ – Media-Specific Inspection Components

The information in this appendix was excerpted from NEIC's *Multimedia Investigation Manual*

The information presented in this appendix includes many significant tasks for several media-specific inspection areas. Media discussed include hazardous waste, air, drinking water, toxic substances, and pesticides; emergency planning/community right-to-know and the Superfund program are also discussed.

A. Resource Conservation and Recovery Act (RCRA)

Subtitle C Hazardous Wastes

Evaluating Compliance

Under RCRA Subtitle C, hazardous wastes are subject to extensive regulations on generation, transportation, storage, treatment, and disposal. A manifest system tracks shipments of hazardous wastes from the generator through ultimate disposal. This "cradle-to-grave" management is implemented through regulations and permits.

In determining the facility status under RCRA, the investigator must decide whether the facility is a generator, transporter, and/or Treatment, Storage, and Disposal Facility (TSDF), and whether the facility is permitted or has interim status. Generally, EPA Regional and State offices maintain files for the facility to be inspected. Information may include:

- A list of wastes that are treated, stored, and disposed and how each is managed (for TSDFs)
- A list of hazardous wastes generated, their origins, and accumulation areas (for generators)
- Biennial, annual, or other reports required by RCRA and submitted to the regulatory agencies; these include any required monitoring reports
- A detailed map or plot plan showing the facility layout and location(s) of waste management areas
- The facility RCRA Notification Form (Form 8700-12)
- The RCRA Part A Permit Application (for TSDFs)
- The RCRA Part B Permit application (for TSDFs, if applicable)
- The RCRA permit (for TSDFs, if applicable)
- Notifications and/or certifications for land disposal restrictions (for generators).

Generators

Hazardous waste generators are regulated under 40 CFR Parts 262 and 268. These regulations contain requirements for:

- Obtaining an Environmental Protection Agency (EPA) Identification Number
- Determining whether a waste is hazardous

- Managing wastes before shipment
- Accumulating and storing hazardous wastes
- Manifesting waste shipments
- Recordkeeping and reporting
- Restricting wastes from land disposal (also regulated under Part 268).

The generator regulations vary, depending upon the volume of hazardous wastes generated with fewer requirements for smaller generators. Large Quantity Generators (LQGs) generate greater than 1000 kg of hazardous waste/month, Small Quantity Generators (SQGs) generate less than 1000kg/month but more than 100 kg/month, while Conditionally Exempt Small Quantity Generators (CESQGs) generate less than 100 kg/month. The investigator must determine which regulations apply. Additionally, the investigator should do the following:

- Verify that the generator has an EPA Identification Number that is used on all required documentation (e.g., reports, manifests, etc.).
- Confirm that the volume of hazardous wastes generated is consistent with reported volumes. Examine the processes generating the wastes to assure that all generated hazardous wastes have been identified. Look for improper mixing or dilution.
- Ascertain how the generator determines/documents that a waste is hazardous. Check to see wastes are properly classified. Collect samples, if necessary.
- Determine whether pre-transport requirements are satisfied, including those for packaging, container condition, labeling and marking, and placarding.
- Determine the length of time that hazardous wastes are being stored or accumulated. Storage or accumulation for more than 90 days requires a permit (facilities that generate less than 1000 kg/month of hazardous waste are allowed to store/accumulate for up to 180 days without a permit). Generators storing for less than 90 days must comply with requirements outlined in 40 CFR Part 262.34.
- Verify RCRA reports and supporting documentation for accuracy, including inspection logs, biennial reports, exception reports, and manifests (with land disposal restriction notifications and/or certifications).
- Watch for accumulation areas which are in use but have not been identified by the generator. Note: Some authorized State regulations do not have provisions for "satellite storage" accumulation areas.
- Determine whether a generator has the required contingency plan and emergency procedures, whether the plan is complete, and if the generator follows the plan/procedures.
- Determine whether hazardous waste storage areas comply with applicable requirements.
- Facilities with their own vehicle maintenance garage should be evaluated to assure that wastes such as used oil, anti-freeze, solvents, and paints are disposed of properly.

Transporters Hazardous waste transporters (e.g., by truck, ship, or rail) are regulated under 40 CFR Part 263, which contains requirements for:

- Obtaining an EPA Identification Number
- Manifesting hazardous waste shipments
- Recordkeeping and reporting
- Sending bulk shipments (by water, rail).

Storage regulations apply if accumulation times at transfer stations are exceeded. Transporters importing hazardous wastes, or mixing hazardous wastes of different Department of Transportation (DOT) shipping descriptions in the same container, are classified as generators and must comply with 40 CFR Parts 262 and 268. Investigators evaluating transporter compliance should do the following:

- Verify that the transporter has an EPA identification number that is used on all required documentation (e.g., manifests).
- Determine whether hazardous waste containers stored at a transfer facility meet DOT pre-transport requirements.
- Verify whether the transporter is maintaining recordkeeping and reporting documents, including manifests, shipping papers (as required), and discharge reports. All required documents should be both present and complete.

Treatment, Storage, and Disposal Facilities

Permitted and interim status TSDFs are regulated under 40 CFR Parts 264 and 265, respectively. (40 CFR Part 264 applies only if the facility has a RCRA permit (i.e., a permitted facility); 40 CFR Part 265 applies if the facility does not have a RCRA permit (i.e., an interim status facility). These requirements include three categories of regulations consisting of administrative requirements, general standards, and specific standards. The investigator should do the following activities to determine compliance with Subparts A through E:

- Verify that the TSDF has an EPA Identification Number that is used on all required documentation.
- Determine what hazardous wastes are accepted at the facility, how they are verified, and how they are managed.
- Compare wastes managed at the facility with those listed in the Hazardous Waste Activity Notification (Form 8700-12), the Parts A and B permit applications, and the permit.
- Verify that the TSDF has and is following a waste analysis plan kept at the facility; inspect the plan contents.
- Identify and inspect security measures and equipment.
- Review inspection logs to ensure they are present and complete. Note problems and corrective measures.

- Review training documentation to ascertain that required training has been given to employees.
- Inspect waste management areas to determine whether reactive, ignitable, and incompatible wastes are handled pursuant to requirements.
- Review preparedness and prevention practices and inspect related equipment.
- Review contingency plans; examine emergency equipment and documented arrangements with local authorities.
- Examine the waste tracking system and associated recordkeeping/reporting systems. Required documentation includes manifests and biennial reports, and may include unmanifested waste reports and spill/release reports. Relevant documents may include on-site waste tracking forms.
- Verify that the operating record is complete according to 40 CFR 264.73 or 265.73.

The investigator can determine compliance with standards in Subparts F through H by doing the following:

- For permitted facilities, verify compliance with permit standards with respect to ground water monitoring, releases from solid waste management units, closure/post-closure, and financial requirements.
- For interim status facilities required to monitor ground water, determine what kind of monitoring program applies.
- Depending on the type of investigation, examine the following items to determine compliance:
 - Characterization of site hydrogeology
 - Sampling and analytical records
 - Statistical methods used to compare analytical data
 - Analytical methods
 - Compliance with reporting requirements and schedules
 - Sampling and analysis plan (for content, completeness, and if it is being followed)
 - Conditions, maintenance, and operation of monitoring equipment, including wellheads, field instruments, and sampling materials
 - Construction/design of monitoring system
 - Assessment monitoring outline and/or plan
 - Corrective action plan for permitted facilities and for interim status facilities under 3008(h) enforcement actions.
- For waste management units undergoing closure, review the closure plan (including amendments and modifications), plan approval, closure schedule, and facility and regulatory certification. Examine response actions to any release of hazardous waste constituents from a closed or closing regulated unit.

- For waste management units in post closure care, inspect security measures, ground water monitoring and reporting, and the maintenance and monitoring of waste containment systems.
- Verify that the owner/operator has demonstrated financial assurance regarding closure.

Specific Hazardous Waste Management Units

The technical standards in 40 CFR Part 264 (Subparts I through O and Subpart X) and 40 CFR Part 265 (Subparts I through R) govern specific hazardous waste management units used for storage, disposal, or treatment (e.g., tanks, landfills, incinerators). Standards for chemical, physical, and biological treatment at permitted facilities under 40 CFR Part 264 have been incorporated under Miscellaneous Units, Subpart X. The investigator should do the following:

- Identify all hazardous waste management areas and the activity in each area; compare the areas identified in the field with those listed the permit or permit application, as appropriate. Investigate inconsistencies between actual practice and the information submitted to regulatory agencies.
- Verify that the owner/operator is complying with applicable design, installation, and integrity standards; field-check the design, condition, and operation of waste management areas and equipment.
- Determine how incompatible wastes and ignitable or reactive wastes are managed.
- Verify that the owner/operator is conducting self-inspections where and when required; determine what the inspections include.
- Identify and inspect required containment facilities for condition and capacity; identify lead detection facilities.
- Determine whether hazardous waste releases have occurred and how the owner/operator responds to leaks and spills.
- Verify that the owner/operator is complying with additional waste analysis and trial test requirements, where applicable.
- Check the closure/post-closure procedures for specific waste management units (surface impoundments, waste piles, etc.) for regulatory compliance.
- For landfills, determine how the owner/operator manages bulk and contained liquids.
- Field-check security and access to waste management units.
- Determine the facility monitoring requirements (for air emissions, ground water, leak detection, instrumentation, equipment, etc.) and inspect monitoring facilities and records.

Land Treatment Facilities

When inspecting land treatment facilities, the investigator should also review the following items:

- Soil monitoring methods and analytical data.
- Comparisons between soil monitoring data and background concentrations of constituents in untreated soils to detect migration of hazardous wastes.
- Waste analyses done to determine toxicity, the concentrations of hazardous waste constituents, and, if food-chain crops are grown on the land, the concentrations of arsenic, cadmium, lead, and mercury in the waste(s). The concentrations must be such that hazardous waste constituents can be degraded, transformed, or immobilized by treatment.
- Runon and runoff management systems.

Incinerators

When evaluating compliance of interim status incinerators, the investigator also should review and/or inspect the following items:

- Waste analyses done to enable the owner/operator to establish steady-state operating conditions and to determine the pollutants that might be emitted.
- General procedures for operating the incinerator during start-up and shut-down.
- Operation of equipment used for monitoring combustion and emissions control, monitoring schedules, and data output.
- The incinerator and associated equipment.

For permitted incinerators, the investigator must evaluate the incinerator operation against specific permit requirements for waste analysis, performance standards, operating requirements, monitoring, and inspections. The investigator also should do the following:

- Verify that the incinerator burns only wastes specified in the permit
- Verify methods to control fugitive emissions
- Determine waste management practices for burn residue and ash.

Thermal Treatment Facilities

The investigator evaluating compliance of thermal treatment facilities in interim status also should review the following items:

- General operating requirements, to verify whether steady-state operating conditions are achieved, as required.
- Waste analysis records, to ensure that (a) the wastes are suitable for thermal treatment and (b) the required analyses in 40 CFR Part 265.375 have been performed.

Thermal treatment facilities permitted under 40 CFR Part 264 Subpart X will have specific permit requirements.

Biological Treatment Facilities

The investigator evaluating compliance of chemical, physical, and biological treatment facilities in interim status also should do the following:

- Determine the general operating procedures.
- Review the waste analysis records and methods to determine whether the procedures are sufficient to comply with 40 CFR Part 265.13.
- Review trial treatment test methods and records to determine whether the selected treatment method is appropriate for the particular waste.
- Examine procedures for treating ignitable, reactive, and incompatible wastes for compliance with Subpart Q requirements.

Chemical, physical, and biological treatment facilities permitted under Subpart X will have specific permit requirements.

Air Emission Standards

Owners/operators of TSDFs and generators with 90-day units must comply with air emission standards contained in Subparts AA, BB, and CC of 40 CFR Parts 264 and 265. Subparts AA and BB establish standards for equipment containing or contacting hazardous wastes with organic concentrations of at least 10 percent. This equipment includes:

- Process vents
- Pumps in light liquid service
- Compressors
- Sampling connecting systems
- Open-ended valves or lines
- Valves in gas/vapor service or in light liquid service
- Pumps and valves in heavy liquid service, pressure relief devices in light liquid or heavy liquid service, and flanges and other connections.

Total organic emissions from process vents must be reduced below 1.4 kg/hr. and 2.8 mg/yr. The other equipment types above must be marked and monitored routinely to detect leaks. Repairs must be initiated within 15 days of discovering the leak.

Subpart CC establishes standards for units managing hazardous wastes with organic concentrations of greater than 500 ppmw at the point of waste origination. The following types of units must be controlled:

- Tanks
- Containers
- Surface impoundments
- Miscellaneous Subpart X units

The facility operating record should contain information documenting compliance with the air emission standards. A complete list of required information is in 40 CFR Parts 264.1035, 264.1064, 265.1035, and 265.1064. Permitted facilities must submit semiannual reports to the Regional Administrator outlining which valves and compressors were not fixed during the preceding 6 months. The investigator can do the following things:

- Visually inspect the equipment for marking.
- Review documentation in the operating record and cross-check this information with that submitted to the Regional Administrator in semiannual reports.

Land Disposal Restrictions

Land Disposal Restrictions (LDR) in 40 CFR Part 268 prohibit land disposal of hazardous wastes unless the waste meets applicable treatment standards as listed in 40 CFR Part 268.40-43. The treatment standards are expressed as (1) contaminant concentrations in the extract or total waste or (2) specified technologies.

Notifications and certifications comprise the majority of required LDR documentation. Notifications tell the treatment or storage facility the appropriate treatment standards and any prohibition levels that apply to the waste. Certifications are signed statements telling the treatment or storage facility that the waste already meets the applicable treatment standards and prohibition levels.

Investigators evaluating hazardous waste generators for LDR compliance should do the following:

- Determine whether the generator produces restricted wastes; review how/if the generator determines a waste is restricted.
- Review documentation/data used to support the determination that a waste is restricted, based solely on knowledge.
- Determine how/if a generator determines the waste treatment standards and/or disposal technologies.
- Verify whether the generator satisfies documentation, recordkeeping, notification, certification, packaging, and manifesting requirements.
- Ascertain whether the generator is, or might become, a TSDF and subject to additional requirements.
- Determine who completes and signs LDR notifications and certifications and where these documents are kept.
- Review the waste analysis plan if the generator is treating a prohibited waste in tanks or containers.

Investigators evaluating TSDFs should do the following:

- Ensure the TSDF is complying with generator recordkeeping requirements when residues generated from treating restricted wastes are manifested offsite.
- Verify whether the treatment standards have been achieved for particular wastes prior to disposal.
- Review documentation required for storage, treatment, and land disposal; documentation may include waste analyses and results, waste analysis plans, and generator and treatment facility notifications and certifications.

Subtitle I—Underground Storage Tanks (USTs)

Evaluating Compliance

Because the tanks are located underground, visual/field observations have limited application in determining compliance for USTs. The UST program relies heavily on the use of documents to track the status and condition of any particular tank.

Interviews with facility personnel are important when determining compliance with any environmental regulation. Questions regarding how the facility is handling its UST program will give the inspector insight into the types of violations that may be found. Topics to be covered in the interview include:

- Age, quantity, and type of product stored for each onsite tank.
- How and when tanks have been closed.
- Type of release detection used on each tank (if any); some facilities may have release detection on tanks where it is not required.
- Type of corrosion protection and frequency of inspections.
- Which tanks have pressurized piping associated with them.

Visual/field observations are used to determine if any spills or overfills have occurred that have not been immediately cleaned up. The presence of product around the fill pipe indicates a spill or overfill. Proper release detection methods can also be verified with field observations.

During the interviews, ask the facility if monthly inventory control along with annual tightness testing is used. If monthly inventory control is used, check the measuring stick for divisions of 1/8 inch. A field check of the entire facility can also be done to determine if any tanks may have gone unreported. Fillports and vent lines can indicate the existence of a UST.

Documents take up the largest portion of time during a UST inspection. Documents that should be reviewed include:

- Notifications for all UST systems
- Reports of releases including suspected releases, spills and overfills, and confirmed releases
- Initial site characterization and corrective action plans
- Notifications before permanent closure

- Corrosion expert's analysis if corrosion protection is not used
- Documentation of operation of corrosion protection equipment
- Recent compliance with release detection requirements, including daily inventory sheets with the monthly reconciliation
- Results of site investigation conducted at the time of permanent closure.

Document retention rules also apply, so be sure to get all of the documents a facility may be required to keep. To determine if the implementing agency has been notified of all tanks, compare the notifications to general UST lists from the facility. Usually, the facility will keep a list of tanks separate from the notifications and tanks may appear on that list that do not appear on a notification form. Also, compare the notifications to tank lists required in other documents, like the Spill Prevention Control and Countermeasures Plan.

RCRA Non-Notifiers

Anytime an investigator is conducting an inspection, they should be aware of the possibility of a “non-notifier” under RCRA. A non-notifier is a facility who has either not notified the EPA or the delegated state of their hazardous waste activity or is managing hazardous waste in an unpermitted unit. The failure to notify may be intentional or the facility may not be aware that the unit should be regulated.

Two specific circumstances for an investigator to be aware of are as follows:

- a facility that is generating a hazardous waste and failed to notify of their generator status and obtain a RCRA I.D. Number.
- a facility that is disposing of hazardous waste in an on-site surface impoundment or landfill that has been determined by the facility to be either a non-hazardous solid waste management unit or an exempt wastewater treatment unit. (When inspecting the wastewater treatment plant, investigators should be aware that the RCRA exemption applies to tanks only. If wastewater meeting the definition of a hazardous waste is discharged into a surface impoundment, this unit is required to have a RCRA permit.)

B. Clean Air Act (CAA)

The Clean Air Act (CAA) is the legislative basis for air pollution control regulations. It was first enacted in 1955 and later in 1963, 1965, 1970, 1977, and 1990. The 1955 and the 1963 Amendments called for the abatement of air pollution through voluntary measures. The 1965 amendments gave Federal regulators the authority to establish automobile emission standards.

Basic Program

The CAA Amendments of 1970 significantly broadened the scope of the CAA, forming the basis for Federal and State air pollution control regulations. Section 109 of the 1970 Amendments called for the attainment of National Ambient Air Quality Standards (NAAQS, 40 CFR Part 50) to protect public health and welfare from the known or anticipated adverse effects of six air

pollutants (as of 1990 the standards were for small particulates, sulfur dioxide, nitrogen dioxide, carbon monoxide, ozone, and lead). The States were required to develop and submit to EPA implementation plans that were designed to achieve the NAAQS. These State Implementation Plans (SIPs) contained regulations that limited air emissions from stationary and mobile sources. They were developed and submitted to EPA on a continuing basis and became federally enforceable when approved.

Section 111 of the 1970 Amendments directed EPA to develop standards of performance for new stationary sources. These regulations, known as New Source Performance Standards (NSPS, 40 CFR Part 60), limited air emissions from subject new sources. The standards are pollutant and source specific.

Section 112 of the 1970 amendments directed EPA to develop standards for hazardous air pollutants. These regulations, known as the National Emission Standards for Hazardous Air Pollutants (NESHAPs, t 40 CFR Part 61), limited hazardous air emissions from both new and existing sources.

The CAA Amendments of 1977 addressed the failure of the 1970 amendments to achieve the NAAQS by requiring permits for major new sources. The permit requirements were based on whether the source was located in an area that did not meet the NAAQS (non-attainment areas). The permit program for sources in attainment areas was referred to as the Prevention of Significant Deterioration (PSD) program.

The CAA Amendments of 1990 significantly expanded the scope of the CAA. Section 112 amendments have amended the NESHAP program with the new provisions called "Title III - Hazardous Air Pollutants." Title III listed 189 hazardous air pollutants (Appendix O) and required EPA to start setting standards for categories of sources that emit these pollutants within 2 years (1992) and finish setting all standards within 10 years. It also contains provisions for a prevention-of-accidental-releases program.

Section 211 of the CAA regulates any fuel or fuel additive for use in motor vehicles if the resulting emission would cause or contribute to air pollution that may reasonably be anticipated to endanger public health or welfare, or if the emission products would significantly impair any emission control device or system in general use. There are several provisions under CAA section 211 which regulate fuels such as gasoline, diesel fuel, and fuel additives.

The Federal tampering prohibition is contained in Section 203(a)(3) of the CAA, 42 U.S.C. 7522(a)(3). Section 203(a)(3)(A) of the CAA prohibits any person from removing or rendering inoperative any emission control device or element of design installed on or in a motor vehicle or motor vehicle engine prior to its sale and delivery to an ultimate purchaser. Section 203(a)(3)(A) also prohibits any person from knowingly removing or rendering inoperative any such device or element of design after such sale and delivery and the causing thereof.

Section 203(a)(3)(B) of the CAA prohibits any person from manufacturing, selling, offering for sale, or installing any part or component intended for use with, or as part of, any motor vehicle or motor vehicle engine where a principal effect of the part or component is to bypass, defeat, or render inoperative any device or element of design installed on or in a motor vehicle or

motor vehicle engine in compliance with regulations under this title, and where the person knows or should know that such part or component is being offered for sale or is being installed for such use.

Section 609 of the CAA Amendments of 1990 requires facilities that perform service on vehicle air conditioners to have recycling or recovery equipment and the technicians who use the equipment to be certified by an EPA-approved Section 609 program.

Evaluating Compliance

The following procedures are used to evaluate compliance with the Clean Air Act.

Before an onsite inspection, the documents listed below should be obtained from State or EPA files and reviewed to determine what regulations apply and what compliance problems may exist.

- The State air pollution control regulations contained in the SIP (State regulations and permits form the basis for the air compliance inspection and will vary from State to State).
- Title V operating permit/application; the State operating and construction permits.
- The most current emissions inventory (check for sources subject to SIP, NSPS, and NESHAPs requirements).
- The Volatile Organic Compound (VOC) and Hazardous Air Pollutant emissions inventory. (The VOC inventory may not be included in the emissions inventory, but reported separately under SARA Title III Form R submittal. More information on the former submittal is found in the Emergency Planning and Community Right-to-Know section.).
- The consent decrees/orders/agreements still in effect and related correspondence.
- The most recent inspection reports.
- The most recent monthly or quarterly Continuous Emission Monitoring/Continuous Opacity Monitoring (CEM/COM) reports.
- AIRS Facility Subsystem (AFS) reports.
- Process descriptions, flow diagrams, and control equipment for air emission sources.
- Facility plot plan that identifies and locates the air pollution emission points.
- The on-site inspection should include a review of the records and documents listed below:
 - Process operating and monitoring records to determine if permit requirements are being followed.
 - Fuel analysis reports (including fuel sampling and analysis methods) to determine if sulfur dioxide emission limits and/or other fuel requirements are being met.

- Reports of process/control equipment malfunctions causing reportable excess emissions (refer to SIP to determine reportable malfunctions and report requirements).
- Source test reports to determine if NSPS, NESHAPs, MACTs, and/or major sources have demonstrated compliance with emission standards.
- CEM reports to determine if NSPS and SIP reporting requirements are being met (reported emissions should be checked against raw data for accuracy, and reported corrective actions should be checked for implementation).
- CEMS/COMS certification tests (relative accuracy and calibration drift) to verify that performance specifications at 40 CFR Part 60, Appendix B, are met.
- Records and reports specified in SIP regulations, NSPS, NESHAP, and MACT subparts, and applicable permits.

The onsite inspection should also include the following:

- Visible Emission Observations (VEOs), by inspectors certified to read smoke within the last 6 months, to determine compliance with SIP, NSPS, or NESHAPs opacity limits (document non-compliance with EPA Method 9, 40 CFR Part 60, Appendix A).
- A check of real time CEM measurements to determine compliance SIP, NSPS, or NESHAPs limits (opacity CEM measurements can be compared against VEOs).
- A review of CEM/COM calibration procedures and frequency to determine if the zero/ span check requirements and analyzer adjustment requirements of 40 CFR Part 60 are being met.
- Observations of process and control equipment operating conditions to determine compliance with permit conditions (if no permit conditions apply, control equipment operating conditions can be compared to baseline conditions from stack tests or manufacturer's specifications for proper operation).
- Observation of control equipment operating conditions and review of equipment maintenance practices and records to determine proper operation of control equipment.
- When inspecting a fuel refinery or terminal and when time permits, the investigator should review records to assess compliance with fuel regulations under CAA section 11. Things to look for include compliance with the new reformulated gasoline requirements including Reid vapor pressure levels (during summer months only) and oxygenate levels of outgoing gasoline, the sulfur content of outgoing diesel fuel, and the lead level of unleaded gasoline leaving the refinery.
- When inspecting a facility with its own fleet of vehicles or garage, maintenance records for the vehicles should be reviewed to determine compliance with Section 203 of the CAA. A review of air conditioning repair/maintenance records should also be conducted to determine compliance with Section 609 of the CAA.

- A review of all sources to determine if existing, new, modified, or reconstructed sources have construction and operating permits required by SIP (note other process changes that may not require a permit but could affect emissions). For example:
 - Are there any boilers, stationary diesel engines (emergency generators, lift pumps), or waste gas boilers of any size? What are their capacities, when installed or altered?
 - Are there any incinerators for sludge, grease, grit, screenings, etc.? When were they installed or altered?
 - Are there any storage tanks storing any liquid except water? What are their capacities, when installed or altered?
 - Are there any solvent or gasoline tanks? What are their capacities, when installed or altered?
 - Are there any storage silos for storing solid particles (e.g., lime)? What are their capacities, when installed or altered?
 - Are there any air pollution control devices of the following types? When were they installed or altered?
- Odor control equipment (carbon adsorbers, scrubbers) on such equipment as sludge handling/storage tanks, pump stations, wet-wells, metering stations, grit screening, headworks building?
- Waste gas burners such as digester flares, boilers, etc.?
- Scrubbers on pH adjustment process or pretreatment equipment (usually HCl control)?
 - Is there any shop equipment of the following types? When was it installed or altered?
- Paint spray booths
- Shotblast booths, controlled (any size) or uncontrolled
- Solvent degreasers
 - Is there any wastewater or water treatment equipment designed to reduce Volatile Organic Compounds (VOCs), which may emit air contaminants, such as aeration basins, surface impoundments, air strippers, roughing filters, trickling filters, or oil/water separators? When was the equipment installed or altered?
 - At industrial/commercial wastewater and pretreatment facilities, are there any aeration basins, lagoons, or settling basins? When were they installed or altered?
 - At industrial/commercial treatment works, is there equipment used to dispense odor reducing/masking agents? When was it installed or altered?
 - At industrial/commercial treatment works, is there equipment used directly to manufacture fertilizers (including mixers, blenders, conveyors, etc.)? When was it installed or altered?

C. Safe Drinking Water Act (SDWA)

Basic Program

Public drinking water supply systems (i.e., that serve at least 25 people or have 15 service connections for at least 60 days per year) are regulated by the Safe Drinking Water Act (SDWA) Amendments of 1986. Public water systems are divided into two categories designated as community and noncommunity systems. A community system serves people year-round, whereas a noncommunity system serves people only for a portion of the time (e.g. hotels and campgrounds). Different requirements apply to each type of system. Different requirements also apply depending on whether the water supply source is surface water or groundwater. EPA sets standards [known as Maximum Contaminant Levels (MCLs) for the quality of water that can be served by public water systems. Public systems must sample their water periodically and report findings to the State (or EPA, if the State has not been delegated the authority to enforce the SDWA). The systems must notify consumers if they do not meet the standards or have failed to monitor or report. EPA is on a statutory schedule for promulgating a large number of new MCLs.

The Underground Injection Control (UIC) program was developed pursuant to the SDWA (Public Law 93-523), Part C—Protection of Underground Sources of Drinking Water (40 CFR Parts 124 and 144 through 148). The scope of the UIC program is the determination of the soundness of construction and operation of injection wells as they relate to the protection of all underground sources of drinking water. The UIC program regulates five classes of injection wells, summarized as follows:

- Class I Industrial, municipal, or hazardous waste disposal beneath the lowermost underground source of drinking water (USDW)
- Class II Oil and gas-related wells used for produced fluid disposal, enhanced recovery, hydrocarbon storage, etc.
- Class III Mineral extraction wells
- Class IV Hazardous or radioactive waste disposal above or into a USDW Class V Injection wells not included in Classes I through IV.

Evaluating Compliance

Monitoring requirements for water supply systems and whether the system can be reasonably expected to routinely provide safe potable water should be determined. Many facilities purchase their potable water supply from a nearby municipality. If no further treatment is provided (e.g., chlorination by the facility), the facility remains a "consumer" rather than becoming a "supplier," and consequently does not have the monitoring or reporting requirements that a supplier would have. Nevertheless, the facility does have a responsibility to ensure that their actions do not result in contamination of the municipal water supply (e.g., through cross-connection). The audit team should be alert to these possibilities.

Inspectors should:

- Verify public water system records of monitoring and reports of exceedances of MCLs
- Interview water system personnel to identify potential operations and maintenance problems
- Check for appropriate treatment systems, such as adequate disinfection
- Check for cross-connections to the water supply and distribution system
- Obtain water source, treatment, and service area information
- Verify that sample locations are appropriate and representative for each contaminant (i.e. sample collected in distribution system versus entry to distribution system)
- Verify that sampling techniques and procedures are appropriate for UIC inspections, the following should be reviewed:
 - Current status of wells (active, abandoned, under construction repairs)
 - Types of wastes discharged to wells
 - UIC permit and permit conditions, if applicable
 - Injection well construction
 - Potential pathways of endangerment to Underground Sources of Drinking Water (USDWs)
 - Protection of USDWs from endangerment
 - Frequency and type of Mechanical Integrity Testing (MIT)
 - Annular pressure
 - Annular pressure monitoring
 - Radioactive tracer surveys
 - Installation methods for well plugging
 - Remedial operation
 - Applicability of land disposal restrictions to injection well operations
 - Recordkeeping and evidence documentation
 - Outlets for floor drains
 - Connection to "dry" wells
 - Evidence of surface ponding
 - Presence of septic systems and/or leach fields

Several States and industries have requested approval of alternative mechanical integrity testing methods or variances to accommodate special local hydrogeological conditions, historical practices, or industry interests. Inspectors and field investigators should be cautioned to keep current with special permit conditions and the status of any pending approvals/denials of alternative mechanical integrity testing procedures and variances.

D. Toxic Substances Control Act (TSCA)

This section describes those specific aspects of toxic substances control that are addressed by the Toxic Substances Control Act (TSCA) and its associated rules and regulations (40 CFR Parts 702 through 799).

Basic Program

The regulation of toxins under TSCA is divided into two components for Agency enforcement program management purposes.

1. "Chemical control" covers enforcement aspects related to specific chemicals regulated under Section 6 of TSCA, such as Polychlorinated Biphenyls (PCBs), Chlorofluorocarbons (CFCs), and asbestos.
2. "Hazard evaluation" refers to the various recordkeeping, reporting, and submittal requirements specified in Sections 5, 8, 12, and 13 of TSCA; although, some elements of what might be termed "chemical control" are also addressed in these sections. Sections 12 and 13 of TSCA, which pertain to chemical exports and imports, respectively, will not be covered in this manual because of their special nature and unique requirements.

Prior to discussing TSCA activities at a facility, the investigator must present appropriate facility personnel with copies of two TSCA inspection forms:

1. Notice of Inspection—Shows purpose, nature, and extent of TSCA inspection.
2. TSCA Inspection Confidentiality Notice—Explains a facility's rights to claim information at the facility as TSCA Confidential Business Information.

Before leaving the site, two additional forms must be completed, as appropriate:

1. Receipt for Samples and Documents—Itemizes all documents, photos, and samples received by the investigator during the inspection.
2. Declaration of Confidential Business Information—Itemizes the information that the facility claims to be TSCA Confidential Business Information.

Evaluating Compliance

Chemical Control

Although the controlled substances most frequently encountered during multi-media investigations are PCBs, the investigator should determine if other regulated toxic substances are present at the facility. Currently these include metal working fluids (Part 747), fully halogenated chlorofluoroalkanes (40 CFR Part 762), and asbestos (40 CFR Part 763); additional toxic substances may be regulated in the future. Because the probability of finding PCBs and

PCB-items at the facility is greater than finding other TSCA-regulated substances, the following discussion is directed toward an evaluation of compliance with proper PCB and PCB-item handling procedures. If other TSCA-regulated substances are found, the investigator should consult the regulations for appropriate requirements.

Management of PCBs/PCB-items is regulated under 40 CFR Part 761. In general, these regulations address recordkeeping, marking and labeling, inspections, storage, and disposal.

Facilities that store and/or dispose of PCBs and PCB-items should have EPA-issued letters of approval that contain facility operating and recordkeeping requirements in addition to those specified in 40 CFR Part 761. The investigator must obtain a copy of these approvals and any subsequent notifications to evaluate facility compliance. The inspector should review Part 761.30 to identify uses of PCB transformers which are prohibited beginning October 1, 1990, but with effective dates extending to October 1, 1993. The inspector should also review the requirements found in Part 761.30 that allow the installation of PCB transformers for emergency use.

In general, the compliance evaluation includes obtaining and reviewing information from Federal, State, and local regulatory agency files; interviewing facility personnel regarding material handling activity; examining facility records and inspecting materials handling units. Specific investigation tasks include:

- Inspect all in-service electrical equipment, known or suspected of containing PCBs, for leaks or lack of proper marking. A similar inspection should also be made of any equipment that the facility is storing for reuse. Make certain that any remedial actions were quick and effective in the case of leaks, spills, etc.
- If the above equipment includes any PCB transformers or capacitors, make certain that all relevant prohibitions are being met, such as those involving enhanced electrical protection, as well as other requirements in the Use Authorization section of the PCB Rule. Make certain that any hydraulic or heat transfer systems suspected of containing PCB fluids have been properly tested.
- Determine whether the facility is involved with servicing PCB items or using/collecting/ producing PCBs in any manner. If so, make certain that the appropriate requirements of the PCB Rule are being met.
- Determine whether the facility is involved with either the storage or disposal of PCBs/PCB- items. Inspect all storage for disposal facilities for proper containment, leaking items, proper marking, dates/time limits, location, protection from elements, and other necessary requirements. If the facility disposes of PCBs, make certain that proper methods are being employed and that design and operation of disposal units is in accordance with regulatory requirements.
- Determine whether storage/disposal facilities are complying with the notification and manifesting requirements contained in Subpart K of the PCB Rule.
- Thoroughly review, for purposes of adequacy and regulatory compliance, all records and reports required by the PCB Rule including the following:

- Annual documents
- Inspection logs
- PCB transformer registration letters
- Manifests/certificates of destruction
- Test data
- Spill cleanup reports
- EPA-issued permits or letters of approval
- SPCC plan, if one is necessary
- Operating records
- Notification of PCB activity.

Hazard Evaluation

Establishing compliance with the various hazard evaluation aspects of TSCA is best accomplished through review and evaluation of the recordkeeping, reporting, and submittal data required by the various regulatory components of Sections 5 and 8. In general, Section 5 addresses new chemicals (i.e., those not on the TSCA Chemical Substances Inventory) and Section 8 addresses existing chemicals (i.e., those chemicals that are on the TSCA Chemical Substances Inventory).

Much of the information obtained and reviewed under these two sections of TSCA will be declared "TSCA Confidential Business Information" by company officials, and thus special security procedures must be followed during review and storage of the documents.

40 CFR Parts 703 through 723 should be consulted for an explanation of TSCA terms and definitions. The following list summarizes the different objectives for inspections of the key TSCA Sections 5 and 8 components.

1. Premanufacture Notification (PMN)

- a. Verify that all commercially manufactured or imported chemicals are on the TSCA Chemical Substances Inventory, are covered by an exemption, or are not subject to TSCA.
- b. Verify that commercial manufacture or import of new chemicals did not begin prior to the end of the 90-day review date, and not more than 30 days before the Notice of Commencement (NOC) date. If commercial manufacture or import has not begun, verify that no NOC has been submitted.
- c. Verify the accuracy and documentation of the contents of the PMN itself.

2. Research and Development (R&D) Exemption

- a. Verify that the recordkeeping and notification requirements are being met for all R&D chemicals.
- b. Verify that "Prudent Laboratory Practices" and hazardous data searches are adequately documented.

3. Test Marketing Exemption (TME)

- a. Verify that the conditions spelled out in the TME application are being met, particularly with respect to dates of production, quantity manufactured or imported, number of customers and use(s).
- b. Verify that the TME recordkeeping requirements are being met.

4. Low Volume Exemption (LVE) and Polymer Exemption (PE)

- a. Verify that specific conditions of the exemption application are being met, and that all test data have been submitted.
- b. For an LVE, verify that the 1,000-kg limit per 12-month period has not been exceeded. For a PE, ensure that the chemical structure and monomer composition(s) are accurate.
- c. Verify that recordkeeping requirements for both LVEs and PEs are being met.

5. 5(e)/5(f) Order, Rule, or Injunction

- a. Verify that all conditions of the order, rule, or injunction are being followed, including use of protective equipment, glove testing, training, and recordkeeping.
- b. If a testing trigger is specified, verify production volume and status of testing activity.

6. Significant New Use Rule (SNUR)

- a. Verify that no commercial production has occurred prior to the 90-day review date.
- b. Verify that SNUR notices (i.e., Significant New Use Notices [SNUNs]) have been submitted for all applicable manufactured, imported, or processed chemicals.
- c. Verify technical accuracy of SNUN and completeness of required recordkeeping.

7. Bona Fide Submittals

Determine the commercial production (or import) status and R&D history of those bona fide chemicals not found on the confidential 8(b) inventory. Verify findings against applicable PMN, TME, and other exemption.

8. Section 8(a) Level A PAIR and CAIR Report

- a. Determine if Preliminary Assessment Information Rule (PAIR) and Comprehensive Assessment Information Rule (CAIR) reports have been submitted for all 8(a) Level A listed chemicals manufactured or imported by the facility.
- b. Verify the accuracy of submitted PAIR information, particularly the reported figures for total production volume and worker exposure levels.
- c. Verify the accuracy of submitted CAIR information and if the report meets the date specified in the regulation.

9. Section 8(b) Inventory Update Rule (IUR)

- a. Verify the accuracy of the information submitted in response to the IUR.
- b. Determine that required information was submitted by the deadline for all chemicals subject to IUR.

10. Section 8(c) Recordkeeping

- a. Determine if the facility has a Section 8(c) file and that allegations of significant health and environmental harm on record are properly filed and recorded.
- b. Determine that all applicable allegations have been recorded and filed.
- c. Determine if the facility has a written Section 8(c) policy and if the policy includes outreach to the employees.

11. Section 8(d) Reporting

Determine if copies (or lists) of all unpublished health effects studies have been submitted by manufacturers, importers, and processors for any Section 8(d) listed chemical.

12. Section 8(e) Reporting

- a. Verify that all Section 8(e) substantial risk reports to the Agency were accurate and submitted within the required time frames.

- b. Verify that all substantial risk incidents and/or test results have been reported to EPA.
- c. Determine that the company has an adequate written policy addressing Section 8(e), and that it relieves employees of individual liability.

E. Federal Insecticide, Fungicide, and Rodenticide Act (FIFRA)

Basic Program

Pesticides are regulated by FIFRA and regulations promulgated pursuant to FIFRA. Under FIFRA, pesticide products must be registered by EPA before they are sold or distributed in commerce. EPA registers pesticides on the basis of data adequate to show that, when used according to label directions, they should not cause unreasonable adverse effects on human health or the environment. States have primary enforcement responsibility for FIFRA.

To ensure that previously registered pesticides meet current scientific and regulatory standards, in 1972 Congress amended FIFRA to require the "reregistration" of all existing pesticides.

Evaluating Compliance

The following list is used in conjunction with specific storage/use/disposal requirements found on pesticide labels. FIFRA requires a written Notice of Inspection and written Receipt for Samples collected.

- Determine types and registration status of all pesticides produced, sold, stored, and used at the facility, particularly if any are restricted or experimental use pesticides.
- Determine use(s) of each pesticide.
- Determine certification status of facility/handlers.
 - Verify who certifies facility/pesticide handlers (EPA, State, Department of Defense).
 - Determine if commercial or private applicator.
 - If restricted-use pesticides are used, check if pesticide applicators are authorized to use these pesticides.
 - Check expiration dates on licenses/certificates.
- Review applicable records.
 - Check previous inspection records and complaints.
 - Check application records.
 - Check restricted-use pesticides records (must be kept at least 2 years). Document suspected violations accordingly.
 - Check inventory records.

- Check training records.
- Inspect storage, mixing/loading, and container disposal areas
 - Check bulk storage areas for compliance with Federal/State rules.
 - Check location, ventilation, segregation, shelter, and housekeeping of pesticide storage handling areas. Check security, fire protection, and warning signs, as may be required by State regulations.
 - Check mixing equipment/procedures for reducing handlers' exposures to pesticides.
 - Check for safety equipment/procedures/use.
 - Check container cleanup and disposal procedures.
- Pesticide waste disposal
 - Check to see that pesticides are disposed of in accordance with applicable label and RCRA requirements.
- Determine measures taken to ensure farm worker safety.
 - Check pesticide use records for re-entry time limit notation.
 - Check pesticide use records for informing farmer(s) or warning workers and/or posting fields.
- Observe actual pesticide application.
 - Observe mixing/loading and check calculations for proper use dilution.
 - Observe when spray is turned on/off with respect to ends of field.
 - Watch for drift or pesticide mist dispersal pattern.
 - Note direction of spraying pattern and trimming techniques.
 - Record wind speed and direction, air temperature, and relative humidity.
 - Observe application with respect to field workers, houses, cars, power lines, and other obstacles.
 - Determine if applicator and assisting personnel are wearing safety gear required by the label.

F. Emergency Planning and Community Right- to-Know Act (EPCRA)

Basic Program

The Emergency Planning and Community Right-To-Know Act of 1986 is a free-standing law contained within the Superfund Amendments and Reauthorization Act (SARA) of 1986. EPCRA is also commonly known as SARA Title III. EPCRA requires dissemination of information to State and community groups and health professionals on chemicals handled at regulated facilities.

An EPCRA inspection verifies that the facility owner/operator has notified State and local agencies of regulated activities; has submitted information to specific State and local agencies; and has prepared and submitted all other required reports.

Evaluating Compliance

Emergency Planning (Sections 301 through 303)

EPA promulgated regulations that identify extremely hazardous substances and the levels to be regulated under EPCRA. The inspector should determine whether the facility is subject to EPCRA regulation. If the facility does meet the requirements, the inspector should verify whether the facility owner/operator:

- Notified the State emergency response agency and the local emergency planning committee that the facility is regulated under EPCRA.
- Designated a facility emergency coordinator to assist the local emergency planning committee in the planning process.
- Notified the local emergency planning committee of the emergency coordinator's identity.

Emergency Notification (Section 304)

The owner/operator of a facility subject to EPCRA must immediately report releases of hazardous substances above the reportable quantity. Substances subject to this requirement are the extremely hazardous substances listed in 40 CFR Part 355 and hazardous listed in 40 CFR Part 302. The inspector should verify whether an immediate notification (within 15 minutes) was made to the:

- State emergency response commission
- Local emergency planning committee
- National Response Center

Community Right-to-Know Requirements (Sections 311 through 312)

Manufacturing facilities subject to the Occupational Safety and Health Act (OSHA) Hazardous Communication regulation (29 *CFR* Part 1910) are required to prepare Material Safety Data Sheets (MSDS) for each hazardous chemical handled at the facility. OSHA revised its Hazardous Communication Regulation, effective September 23, 1987, to require that MSDSs be prepared by nonmanufacturing facilities. The inspector should verify that the facility owner/ operator has sent the following to the State emergency response commission, the local emergency planning committee, and the local fire department:

- MSDSs or a list of chemicals covered by MSDSs found at the facility above the threshold planning quantity (40 CFR Part 370 Subpart B)
- An annual inventory (Tier 11 Form) of hazardous chemicals found at the facility above the threshold planning quantity (40 CFR Part 370 Subpart D).

Toxic Chemical Release Reporting (Section 313)

Covered facilities (40 CFR Part 372.22) that manufacture, process, or otherwise use certain chemicals above specified amounts must annually report releases to the environment. The

inspector should determine whether the facility owner/operator is required to submit this annual report (Form R). The following criteria are applied to determine if the facility is required to report:

- The facility has the equivalent of 10 or more full-time employees.
- The facility is in SIC codes:
 - 10 (except 1011, 1081, and 1094)
 - 12 (except 1241)
 - 20 through 39
 - 4911, 4931, or 4939 (limited to facilities generating power for consumer use by combusting coal and/or oil)
 - 4953 (limited to RCRA Subtitle C facilities) o 5169 and 5171
 - 7389 (limited to facilities engaged in solvent recovery services)
- The facility manufactured or processed in excess of 25,000 pounds or used in any other manner 10,000 pounds or more of the chemicals listed on the Toxic Release Inventory (TRI). The list of TRI chemicals can be found in the current year's reporting instructions.

G. Pollution Prevention

Basic Program

EPA is developing an Agency-wide policy for pollution prevention. Present authorities were established in the 1984 Hazardous and Solid Waste Amendments to RCRA (Section 3002). The October 1990 Pollution Prevention Act established pollution prevention as a national priority. The September 16, 1998, Executive Order 13101, Section 403, Federal Facility Compliance.

Evaluating Compliance

EPA has developed a policy regarding the role of inspectors in promoting waste minimization (OSWER directory number 9938.10). As stated in the policy, to evaluate compliance, the Inspector should:

- Check hazardous waste manifests for a correctly worded and signed waste minimization certification.
- Determine whether this certification was manually signed by the generator or authorized representative.
- Confirm that a waste minimization program is in place by requesting to see a written waste minimization plan, or requesting that the plan be described orally, or requesting that evidence of a waste minimization program be demonstrated. The inspector can, and should, visually check for evidence of a "program in place" onsite.
- Check the Biennial Report and/or Operating record of generators and TSDFs, as appropriate. These documents should contain descriptions of waste minimization

progress and a certification statements. If known omissions, falsifications, or misrepresentations on any report or certification are suspected, criminal penalties may apply and the case should be referred for criminal investigation.

- Check any waste minimization language included in the facility's permits, any enforcement order, and settlement agreements. Verify that waste minimization requirements are being satisfied.

The policy also states that the inspector should promote waste minimization by:

- Being familiar with, recommending, and distributing waste minimization literature.
- Referring the facility to the appropriate technical assistance program for more specific or technical information.
- Providing limited, basic advice to the facility of obvious ways they can minimize their waste. This advice should be issued in an informal manner with the caveat that it is not binding in any way and is not related to regulatory compliance.

The multi-media inspection team can also document cross-media transfers of wastestreams, that can result in false claims of waste minimization. For example, a facility could treat a solvent wastewater stream in an air stripper that has no air pollution control devices. On paper, the amount of solvent discharged to a land disposal unit or sewer system could show a reduction, but the pollutants are going into the air, possibly without a permit. Another example would be a facility claiming a reduction in hazardous waste generated because the waste stream was delisted.

Appendix AR – National Multimedia Screening Inspection Worksheet

GENERAL INFORMATION

1. Inspector(s) Name _____ 2. Date _____

3. Facility Name/Address

4. Facility Contact(s)/Title(s)

5. Description of Facility Operations

SIC Code _____

Number of Employees _____

Operating Schedule

Major Products/Production Capacity

RCRA

Observations

1. Does the facility generate anything that looks like waste material that might contain hazardous constituents?

2. If so, describe what the facility says regarding the RCRA regulatory status of the waste material and their rationale for such determination. (e.g., have they made a RCRA waste identification and what was that determination? Have they determined the waste to be exempt from regulation and why?)

3. Describe the process that generates the waste material.

4. Do you see any containers of hazardous waste, land disposal units, lagoons, treatment units? Approximately how many?

5. Were any of the units that contain or handle hazardous wastes (containers, berms, dikes, tanks, piping, impoundments, etc.) in poor condition, unmarked, opened, leaking, cracked, corroded, or in a condition that would allow the release or potential release of hazardous

wastes? If yes, describe unit(s). Any actual or evidence of past releases observed? If so, describe waste (i.e., liquid, sludge, etc.) unit(s), and location.

6. Does the facility operate a boiler or industrial furnace which burns hazardous wastes? Was there any incineration of hazardous waste on-site?

7. Was there any evidence of spills, leaks, or discharges of hazardous wastes? If so, provide location and description.

Interview Questions/Records Review

1. If the facility is a generator of hazardous waste was there a notification of hazardous waste activity? What is the quantity (kilograms/month) of hazardous wastes produced? How are they produced?

2. What is the EPA Identification Number?_

3. What was the basis (i.e. test, knowledge of process and waste) for determining if the facility did or did not produce or handle hazardous wastes? Who made the determination?

UST

Observations

1. Are there any underground storage tanks? _____

2. Approximately how many? What are the contents? (Wastes, virgin petroleum, or chemicals)

3. What type of leak detection is used? When was it last used?

4. Is there any evidence of leaks, spills, broken piping, broken fill/vent lines, or leaking pump joints or valves? Provide location and description.

Interview Questions/Records Review

1. If the tanks are for virgin petroleum or chemicals (not wastes), are they registered with the state? Date of registration? Date of tank(s) installation?

SPCC

Observations

1. Does the facility have the capacity to store oil either in above or below ground tanks? How many gallons? Does any tank have a capacity of more than 660 gallons in a single tank or does the facility have a capacity of more than 1320 gallons in a number of tanks or a capacity of more than 42,000 gallons below the ground?

2. What type of secondary containment is used at the facility? Were there any deficiencies in the secondary containment (cracks, broken, dikes left open)? Is it adequate to contain the entire contents of the largest tank?

Interview Questions/Records Review

1. Does the facility have a certified (signed by a P.E.) plan? When was it last updated?

2. Has there been any major changes to oil storage at the facility since the last modification of the plan?

WETLANDS

Observations

1. Are there any wet areas near the facility with wetland-type vegetation (cattails, rushes, sedges) that have been disturbed by waste disposal, ditching, or filling?

Interview Questions/Records Review

1. Does the facility have a federal section 404 permit or any state or local permit authorizing the fill?

FIFRA

Observations

1. Does the facility produce pesticides? _____
2. Is the facility applying pesticides? _____
3. Where are the pesticides stored?

Interview Questions/Records Review

1. If the facility produces pesticides what is the establishment's registration number?

2. If the facility is applying pesticides what is the registration number of the pesticides?

AIR

Observations

1. Is there any asbestos on-site? _____

2. Is the facility undergoing or has the facility undergone any renovations or demolitions during the last 18 months which involve the removal or disturbance of asbestos-containing materials? Approximately how much asbestos (square feet or linear feet) was removed?

3. Does the facility have any coating or printing operations? Does the facility use any paints or organic solvents? What, if any, type of air pollution control is used? Was it operating?

4. Were there any odors? What process was the source of the odors? Describe the odors.

5. Were there any visible (opaque smoke) emissions? What process was the source? Was there any fugitive (not from a stack) emissions? Was the air pollution control equipment, if any, operating? Describe source.

Interview Questions/Records Review

1. If asbestos was removed was notification provide to the State and EPA?

2. If the facility has coating or printing operations are they water based or organic solvent based?

3. Does the facility handle/emit any of the National Emission Standards for Hazardous Air Pollutants (NESHAP) chemicals other than asbestos (mercury, beryllium, vinyl chloride, benzene, arsenic, radionuclides)? Describe process.

4. Has the facility added new or expanded existing processes in the last two years? Was it permitted by EPA of the State?

TSCA-PCBs

Observations

1. Did the facility have or does it have any PCB electrical equipment? What equipment (type and quantity) is on-site?

2. Does the facility have a PCB equipment storage area for disposal or reuse? Describe the storage area (i.e. concrete pad, walls, roof, curbs).

3. Are there any labels/markings on the PCB equipment?

4. Is there any leaking PCB electrical equipment? Describe.

5. Does the facility have any hydraulic systems? Any leaking?

Interview Questions/Records Review

1. If the facility has PCB electrical equipment was it tested? What were the test results?

2. If the facility has any hydraulic systems when were they tested for PCBs? What were the test results?

WATER-NPDES

Observations

1. Does the facility use water in its manufacturing process?

2. Does the facility discharge to a stream, municipal sewer, or use subsurface disposal?

3. What process(es) generate wastewater? Is the wastewater treated? Is the effluent clear? Does the treatment plant appear to be maintained (look for rust, dry basins, abandoned equipment, etc.)?

4. Where does the storm water drain to?

5. Where do floor drains discharge?

Interview Questions/Records Review

1. How is the treatment plant's sludge disposed? How is it tested?

EPCRA

Interview Questions/Records Review

1. Were there any chemical releases in excess of the reportable Superfund quantities (see below)? Who was provided the notification? Was it oral or written?

2. Does the facility manufacture, process, or use any toxic chemicals in a quantity greater than 10,000 lbs./yr.? Identity them. Are any of them section 313 chemicals³⁶?

3. If the answer to question 2 is yes, has the facility submitted the toxic chemical release form (R)?

4. Does the facility have the Material Safety Data Sheets on-site and were they submitted to the State Emergency Response Commission (SERC) and/or the Local Emergency Planning Committee (LEPC)?

5. Has the facility submitted the Emergency and Hazardous Chemical Inventory forms to the LEPC and SERC?

³⁶ The chemicals subject to these requirements can be found in EPA publication number 560/4-92-011, January 1992, "Title III, List of Lists".

SDWA-UIC

Observations

1. Are there any discharges other than sanitary waste (i.e. industrial wastes) into or onto (including drain fields) the ground? Is an on-site septic disposal system used? Describe the discharges and disposal system.

Interview Questions/Records Review

1. Does the facility have or has it had any wells (dug, drilled or driven), dry wells, leachfields, or septic systems? Did they receive(d) commercial or industrial waste (liquid and/or solid), cooling water, or drainage from roof drains, floor drains, or parking lots? If yes, give a description.

2. Does the facility have a permit? _____

3. What is the current status of wells (active, abandoned, under construction, repairs)?

4. If the wells are inactive what was the date they were last used?

SDWA-PWS

Interview Questions/Records Review

1. What is the facility's source of drinking water? Does the facility have a private well? How many people does it serve?

2. Is the water sampled and analyzed for contaminants? Are the results reported to the state or EPA?

ENVIRONMENTAL ASSESSMENT

1. Is there any evidence of environmental impacts that haven't been addressed? Possible examples include:

- additional evidence of spills, leaks
- vegetation damage in the surrounding area
- odors in the surrounding neighborhood
- neighborhood covered with "dusts"
- poor water quality in streams near the facility.

2. Were there situations of possible excessive occupational exposure that should be referred to OSHA?

Office of Enforcement and Compliance Assurance

INSPECTION MANUAL

NPDES COMPLIANCE INSPECTION MANUAL

Number: OECA-MANL-2017-001-RO

[1/20/2017]

U.S. Environmental Protection Agency



**U.S. Environmental Protection Agency
Office of Enforcement & Compliance Assurance
Controlled Document**

STANDARD OPERATING PROCEDURE

Title: NPDES Compliance Inspection Manual

Effective Date: 1/20/2017

Number: OECA-MANL-2017-001-RO

Author

Name: <AUTHOR>

Title: <TITLE>

Office:

Signature:

Date:

Approvals

Name: <AUTHOR>

Title: <TITLE>

Office:

Signature:

Date:

Name: <AUTHOR>

Title: <TITLE>

Office:

Signature:

Date:

Name: <AUTHOR>

Title: <TITLE>

Office:

Signature:

Date:

Name: <AUTHOR>

Title: <TITLE>

Office:

Signature:

Date:

Name: David Meredith

Title: Quality Assurance Manager

Office: OC

Signature:

Date:

Revision History

This table shows changes to this controlled document over time. The most recent version is presented in the top row of the table. Previous versions of the document are maintained by the OECA Document Control Coordinator.

History	Effective Date
NPDES Compliance Inspection Manual Revision 1	1/20/2017