

*Prepared for*

**NAVAL FACILITIES ENGINEERING COMMAND  
ENGINEERING SERVICE CENTER**

Port Hueneme, California

*Technical Submittal for Project:*

**Project Title: CLEAN, INSPECT, AND REPAIR STORAGE TANKS 5 & 17**  
**Location: PEARL NAVAL BASE – REDHILL COMPLEX, Pearl Harbor, HI**  
**Task Order No.: N62583-09-D-0132/0003**  
**WGS Project Number: 54118**  
**Date: 12 Apr, 2010**

**TANK 5 & 17 CLEANING, INSPECTION AND REPAIRS  
PROJECT EXECUTION WORK PLAN**

**Submitted By:**  
 Willbros Government Services, LLC  
 2087 E. 71<sup>st</sup> Street  
 Tulsa, OK 74136

Rev	Date	Description	Reviewed	Approved
A	4/12/10	For Approval	PS	TDA
0	5/24/10	Approved – NAVFAC ESC / FISC Review	DB	TDA
1				
2				
3				



Distribution is limited to US Government agencies and their contractors; administrative/operational use within the context of this project. Other request shall be referred to the Naval Facilities Engineering Service Center.



**TABLE OF CONTENTS**

---

**Administrative Section**

I. Project Work Plan Cover .....1  
II. Table of Contents .....2  
III. List of Tables, Figures and Appendices .....3  
IV. List of Acronyms and Abbreviations .....4

**Project Section**

1.0 Project Scope of Work and Procedures .....5  
1.1 Introduction .....5  
1.2 Background and Objectives .....5  
1.3 Work Plan Implementation.....5  
1.4 Project Specifications .....5  
1.5 Required Permits .....5  
2.0 Project Schedule and Controls.....6  
2.1 Project Schedule .....6  
2.2 Critical Path .....6  
3.0 Responsible of Parties .....7  
3.1 Program Manager .....7  
3.2 Program Health and Safety Officer .....7  
3.3 Project Manager .....7  
3.4 Site Manager.....7  
3.5 Field Health & Safety Officer .....8  
3.6 Subcontractors .....8  
3.7 Change Management.....9  
4.0 Project Execution Strategy .....9  
4.1 Mobilization and Site Preparation Plan .....9  
4.1.1 Traffic Control Plan .....9  
4.2 Confined Space .....10  
4.3 Hot Work .....10  
4.4 Transportation of Materials and Equipment Plan .....10  
4.5 Project Task and Sequences .....10  
4.5.1 Tank and Pipe Cleaning.....17  
4.5.2 Tank Inspections.....19  
4.5.3 Tank Calibrations .....22  
4.6 Health, Safety and Environmental Management.....24  
4.7 Subcontractor Management and Coordination .....24  
4.8 Quality Assurance .....25  
4.9 Repairs .....30  
4.10 Demobilization .....30  
5.0 Key Personnel .....30  
6.0 Technologies, Materials and Equipment .....31  
7.0 Hazardous Waste Disposal .....32  
8.0 Project Reporting and Documentation .....32





---

### LIST OF TABLES

---

<b>Number</b>	<b>Title</b>	
Table 3-1	Project Organization.....	6
Table 3-2	Subcontractor Organizations and Associated Project Task.....	8
Table 5-1	Key Personnel Qualifications .....	30

---

### LIST OF FIGURES

---

<b>Number</b>	<b>Title</b>	
Figure 4-1	Project Sample Tank Calibration Chart.....	23

---

### LIST OF APPENDICES

---

- Appendix A – PROJECT SPECIFICATIONS
- Appendix B – DETAILED PROJECT SCHEDULE
- Appendix C – PROJECT DRAWINGS
- Appendix D - PROJECT PROCEDURES - Tank Cleaning & Decontamination
- Appendix E - PROJECT PROCEDURES - Non-Destructive Testing (NDE)
- Appendix F - PROJECT PROCEDURES – Repair Construction / QC / Welding
- Appendix G – PERSONNEL RESUMES AND CERTIFICATIONS



---

## LIST OF ACRONYMS AN ABBREVIATIONS

---

API	American Petroleum Institute
ASME-BPV	American Society of Mechanical Engineers – Boiler & Pressure Vessel Code
ASNT	American Society of Non-Destructive Testing
AWS	American Welding Society
BMP	Best Management Practice
CO	Contracting Officer
CP	Cathodic Protection
DA	Department of the Army
DBB	Double Block and Bleed Valve
DO	Delivery Order
DOT	Department of Transportation
EPP	Environmental Protection Plan
FFD	Federal / Naval Fire Department
F-76	Diesel Fuel Marine
FHWA	Federal Highway Administration
FISC	Fleet and Industrial Supply Center
FLD	Field Operating Procedure
FORFAC	Fuel Oil Reclamation Facility
FSO	Field Safety Officer
HASP	Health and Safety Plan
HPV	High Point Vent
JP-5	Jet Propellant Grade 5
JP-8	Jet Propellant Grade 8
LOTO	Lockout Tagout
LPD	Low Point Drain
NAVFAC	Naval Facilities Engineering Command
NFESC	Naval Facilities Engineering Service Center
NAVSTA	Naval Station
NDE	Non-Destructive Examination
NPDES	National Pollution Discharge Elimination System
NTR	Navy Technical Representative
PM	Project Manager
POC	Point of Contact
PPE	Personal Protective Equipment
QA	Quality Assurance
QC	Quality Control
SSHEP	Site Specific Health & Environmental Plan
SM	Site Manager
SOW	Statement or Scope of Work
TO	Task Order
USACE	U.S. Army Corp of Engineers
USN	U.S. Navy
UST	Underground Storage Tank
VS	Valve Station
WDP	Waste Disposal Plan
WP	Work Plan





## **REDHILL COMPLEX PROJECT - 54118 TANK 5 & 17 CLEANING, INSPECTION & REPAIR**

### **1.0 PROJECT SCOPE OF WORK AND PROCEDURES**

#### **1.1 INTRODUCTION**

Under contract agreement (Contract No. N62583-09-D-0132/ Task Order [TO] 0003 / Modification 00) with the Naval Facilities Engineering Service Center (NFESC), Willbros Government Services, LLC (Willbros) has prepared this Work Plan (WP) for *Pearl Harbor Redhill Complex Tank Project*, Fleet and Industrial Supply Center (FISC), Pearl Harbor, Hawaii.

The WP shall be utilized in conjunction with the project Site Specific Health and Environmental Plan (SSHEP), Health and Safety Plan (HASP), Environmental Protection Plan (EPP) and Waste Disposal Plan (WDP). The WP outlines the project activities in accordance with the NAVFAC ESC Statement of Work (SOW) dated 13 Jan, 2010.

#### **1.2 BACKGROUND AND OBJECTIVES**

The project site is located on the Pearl Harbor Naval Base, Redhill Complex on Oahu, HI. The Redhill Tank Complex provides strategic fuel supply to the USN Pacific Fleet. The Redhill Complex contains twenty (20) UST tanks, 100 ft. dia. X 250 ft. high and ancillary equipment. The complex was originally built beginning in December 1940 and construction was completed in September 1943.

The project objectives under this contract are to provide cleaning, inspection and repairs for Tanks 5 & 17. The scope limits includes the tanks, tank components and to the first flange connection from the tank to the first isolation valve. The scope of work is defined in the NAVFAC SOW document and described in the following portions of this work plan.

#### **1.3 WORK PLAN IMPLEMENTATION**

All site activities will be performed in accordance with this WP, Willbros policies and procedures, applicable federal and local standards, and specified NAVFAC ESC requirements. In the event that the aforementioned regulations conflict, the most stringent standards will be met. Supporting this WP is a SSHEP, HASP, EPP and WDP, submitted under separate cover. All Willbros and subcontractor personnel involved in this project shall review and understand these documents prior to the start of work. The draft and final versions of this WP will be submitted for review and approval.

#### **1.4 PROJECT SPECIFICATIONS**

The project specifications listed in Appendix A are compiled from the NAVFAC SOW and related contract documents. These project specifications will be implemented in the development, design and execution of the project work plan. The project will also insure compliance with all local, state and federal regulations and Willbros standard policies and procedures.

#### **1.5 REQUIRED PERMITS**

Willbros will obtain hot work permits for any hot work task on the storage tank and confined space permits will be obtained as needed. A Marine Chemist will be employed to certify the site condition is ready for hot work. Willbros will coordinate with Federal Fire to obtain a hot work permit. No environmental or other permits are required.





**2.0 PROJECT SCHEDULE AND CONTROLS**

**2.1 PROJECT SCHEDULE**

The project schedule is provided in Appendix B, the schedule illustrates the projected timelines for the discrete project tasks from the project preparation through project closeout. These tasks only allow for task contracted under this TO and does not include anticipated or estimated repairs, coatings or other activities. As additional task(s), repairs, coatings or other activities are added to the TO; the project schedule will be changed to reflect the additional time required for the added task or activities.

**2.1 CRITICAL PATH**

Willbros has not identified any relevant schedule risk item which has a significant probability of adversely affecting the project work schedule. The Willbros project management and controls team will monitor and update the schedule regularly; to evaluate and anticipate any realistic potential problems and to have plans in place to maintain our work schedule. The Critical Path will be integrated and shown on the overall project schedule.

**3.0 RESPONSIBILITIES OF PARTIES**

All personnel entering the project site are subject to the requirements of this WP. The following subsections will provide the chain of command for this project. The Site Manager (SM) and the Field Health & Safety Officer (FSO) will be responsible for the oversight of all activities, field personnel and subcontractors. Table 3-1 provides a list of key participants, including relevant project contacts and NAVFAC ESC personnel.

Title	Name	Organization	Phone Number
Contracting Officer	██████████	NAVFAC / SCAN	(805) 982-2479
Contracting Officer Representative	██████████	NAVFAC ESC	(805) 982-3595
Navy Technical Representative	██████████	NAVFAC ESC	(808) 471-1461
Willbros Project Manager	Tim Anderson	Willbros Government Services, LLC	(918) 481-4347 D / (832) 618-0281 C
Willbros Project Engineer	Gene Humes / David Sloan	Willbros Government Services, LLC	(918) 496-0400
Willbros Site Manager	Reed Cavin	Willbros Government Services, LLC	(808) 352-0528
Willbros Site Health & Safety Officer	Binh Ly	Willbros Government Services LLC / Inserv	(808) 352-0528
Willbros Program Manager	Doug Bayles	Willbros Government Services, LLC	(918) 499-2890
Willbros Corp Safety Manager (Downstream Divisions)	Eric Biggs	Willbros Government Services, LLC / Inserv	(918) 234-4150

**Table 3-1. Project Organization**





### **3.1 PROGRAM MANAGER**

Mr. Doug Bayles, P.E. serves as the Program Manager for all NAVFAC Program TO's / DO's. Mr. Bayles is responsible for ensuring that Willbros executes all TO's / DO's efficiently, expeditiously, and with the highest degree of competency.

Willbros's Program Manager will support the Project Manager (PM) with regard to purchasing, soliciting of vendors, evaluation of bids including consent packages, property management, and any environmental compliance and health/safety issues.

### **3.2 PROGRAM HEALTH AND SAFETY OFFICER**

The Program Health and Safety Officer for this project is Mr. Eric Biggs, the Senior Safety Personnel for the NAVFAC fuel programs in Willbros (WGS). The Program Health and Safety Officer is also the Willbros Government Services Corporate Safety Manager.

The Program Health and Safety Manager will have the following responsibilities:

- Ensure that the HASP complies with all federal and local health and safety requirements. If necessary, modify specific aspects of the SSHEP and HASP to adjust for on-site changes that affect safety.
- Evaluate and authorize any changes to the SSHEP and HASP.
- Implement and provide oversight of the Environmental Compliance and Health & Safety Program.
- Assist in acting as liaison with government officials regarding health and safety-related site matters.
- Maintain frequent communication with the SM regarding site activities and implementation of the SSHEP and HASP.
- Assist in training site personnel in the site-specific hazards.
- Ensure site and project personnel are in compliance with the Willbros Safety Program.

### **3.3 PROJECT MANAGER**

Mr. Tim Anderson is the Project Manager for this TO. The Project Manager's responsibilities include daily supervision of TO execution; establishment of work teams for specific tasks; allocation of assigned resources for optimum safety and quality work execution; resolution of issues regarding alternative approaches; direct and frequent liaison with the Government representatives; early identification and resolution of problems; identification of potential or desired modifications to the scope of work; cost, schedule, and field construction quality control; and preparation of TO deliverables. The Program Manager will be regularly informed about the status of the project activities and any changes in the scope of work, milestone dates, or resource requirements.

### **3.4 SITE MANAGER**

Mr. Reed Cavin will be the SM for this TO. Mr. Cavin will report directly to the PM for daily site activities. The SM is responsible for supervising and managing field execution of the project. The SM will provide direct day-to-day supervision of field personnel and subcontractors, and will render site management decisions relevant to project execution and safety.





### 3.5 FIELD HEALTH & SAFETY OFFICER

The FSO is responsible for ensuring that all personnel adhere to the requirements of the Willbros Health and Safety Program (HASP ) and the Site Specific Health and environmental Plan (SSHEP).

The FSO has the following responsibilities:

- “STOP WORK” authority for health and safety reasons.
- Implement and enforce the SSHEP and HASP.
- Conduct daily safety briefings.
- Ensure that all project personnel follow the requirements of the SSHEP and HASP.
- Train employees in site-specific hazards.
- Ensure Competent Personnel ( Confined Space, Scaffolding, Air Monitoring, Etc. ) training is current and identified for use in the required appropriate activities.
- Specify proper levels of Personal Protective Equipment (PPE) according to the specifications of the SSHEP, HASP, project plans and regulations.
- Develop additional health and safety procedures, as required.
- Investigate accidents/incidents and “near misses”.
- Conduct visitor orientation.
- Conduct necessary safety audits and complete required documentation.
- Coordinate with Division Health and Safety Manager concerning monitoring and PPE.
- Conduct air monitoring as necessary.

### 3.6 SUBCONTRACTORS

Table 3-2 shows the proposed subcontractors to be contracted for this project and their associated project site work tasks or activities as they relate to current project.

**Table 3-2 Subcontractor Organizations and Associated Project Task**

Subcontractor	ROLE / RESPONSIBILITY
Marine Chemist Hawaii	Marine Chemist services as needed for additional project support.
Testex	Perform NDE testing of the tank and components
Engineering & Inspection of Hawaii	NDE testing and inspections as needed for additional project support
Pacific Commercial Services	Cleaning and disposal services as needed for additional project support. Equipment rental as needed for additional project support.
Hawaii Marine	Cleaning and disposal services as needed for additional project support
Hawaiian Pumping	Cleaning and disposal services as needed for additional project support
Interspec, LLC	Tank Calibrations and strapping as needed for project support.
Gauge Point Calibrations	Tank Calibrations and strapping as needed for project support.
Chemitrol	Portable Toilets – Supply, Service & Maintenance
Kealahalani Equip & Rental	Equipment Fuel Supply
Mr. Sandman	Equipment rental as needed for additional project support.
FKS	Equipment rental as needed for additional project support.
Hawaiian Rent All	Equipment rental as needed for additional project support.
Rolloffs Hawaii	Site trash containers.
Valve Service & Supply	Materials supply and service as needed for project support.





### **3.7 CHANGE MANAGEMENT**

Recognizing that project success and quality are common goals of all project stakeholders, change management during various phases of the project is very important. The project may undergo changes during the course of the work depending on field conditions and unforeseen circumstances. NAVFAC ESC and the Base point of contact (POC) have the responsibility to evaluate the project requirements during and/or upon the site assessment, as well as to identify/add any necessary scope detail. Typically, changes in project scope can be handled most efficiently early on in the process, (i.e. during the concept development and planning stage). Proper communication and mitigation of potential changes prior to the implementation of project execution activities will provide a significant cost savings; also reduce the likelihood of costly changes or schedule impacts to the project after the WP has been approved and the construction activities have begun. It is anticipated that changes in conditions may occur in the field. Change management procedures will include documentation and timely notifications of changes. As required, scope and potential cost changes will be communicated to the Contracting Officer (CO) through the NAVFAC ESC NTR. The documentation provided will include justification of changes, requests for compensation (as appropriate), and an estimate of schedule and cost impacts.

### **4.0 PROJECT EXECUTION STRATEGY**

Site work and operating plans associated with this project are described in the following sections and associated appendices. The work will be conducted in compliance with the contract documents, project drawings and specifications, and applicable guidance documents and regulations. The project specifications, drawings and procedures are included in relevant Appendices respectively.

#### **4.1 MOBILIZATION AND SITE PREPARATION PLAN**

The SM, subcontractors, materials, and equipment will be mobilized to the site in accordance with the project schedule. During mobilization, Willbros will establish work zones, installation of barriers, posting of signage, and permit coordination (as necessary). Equipment and materials will be mobilized to the site on an as-needed basis to avoid multiple handling, storage, and transportation costs. An equipment storage/staging area is required when field operations commence. Willbros plans to utilize the area at the existing at the ADIT Tunnel openings as indicated on Drawing 01-006. A sketch of the area and approval of the area usage is included in Appendix C. This area will be used for trucks, equipment, material storage, and serve as an assembly, staging and fabrication area. Prior to staging any required materials or equipment within the storage/staging area, the Willbros's team will install necessary Best Management Practices (BMP) for storm water management as noted in Willbros's EPP. BMP's will be removed at the completion of construction. Coordination between Willbros, our subcontractors, NAVFAC ESC and FISC personnel will occur on a daily basis to allow the work to be completed on time and with as little interruption to facility operations as possible. Willbros will hold a pre-construction meeting prior to the first mobilization to implement site security, health and safety procedures and environmental controls.

##### **4.1.1 Traffic Control Plan**

Willbros has identified that materials, equipment and transports will utilize local, county and state roads and highways. No current shipment will require permits, special handling or interfere with the vehicular traffic in the area. Prior to the start of any activities that would occur in the vehicle thoroughfare, a traffic control plan will be submitted for review and approval to safely modify the traffic pattern during construction. The traffic control plan and devices used will be in accordance with the Federal Highway Administration's (FHWA) Manual on Uniform Traffic Control Devices (MUTCD).





## **4.2 CONFINED SPACE**

Confined space is defined as any space having: (1) a limited or restricted means of entry or exit, (2) space large enough and so configured that an employee can bodily enter and perform assigned activities, and (3) conditions not designed for continuous employee occupancy. Willbros HASP, Confined Space Program and Procedures, will be adhered to for any work identified as a confined space. Prior to entry activities into a permit required confined space, the SM will complete a Confined Space Entry Permit (located in appropriate section of the HASP). Additionally, the SM will communicate with the Federal Fire Department (FFD) about confined space entry schedules and notify them specifically for changes to the entry schedule. The FFD will be the responsible party for rescues should workers become entrapped and site personnel cannot evacuate them. Willbros expects to maintain a daily permit requirement for confined spaces on the project.

## **4.3 HOT WORK**

Hot work will be required to complete known and anticipated repair requirements. Hot work is defined as any task producing heat, sparks or energy sufficient to serve as an ignition source at a work site that potentially has an ignitable atmosphere. Examples include welding, cutting, grinding, use of power tools, sand blasting, and use of internal combustion engines. Willbros will obtain a Hot Work Permit from the FFD for work that will be performed on the fuel storage tanks, piping or pipeline. The SM will communicate with the FFD about hot work schedules and notify them about any changes. The SM will designate a Fire Watch for each hot work operation. The Fire Watch will remain in clear view of the hot work at all times and close enough to provide emergency assistance if needed. A Marine Chemist will certify the area is suitable for hot work operations and assist in the Hot Work Permit application. Fire extinguishers will be located in the immediate vicinity of the hot work being performed. The extinguishers will be routinely inspected for operability prior to commencing work. Facility fire suppression system location and operations will be briefed to all work crew personnel prior to initiation of work.

## **4.4 TRANSPORTATION OF MATERIALS AND EQUIPMENT PLAN**

Willbros and its subcontractors will be responsible for transporting equipment, materials, and waste materials on and off the site. Willbros will subcontract with local, licensed and authorized firms to transport any waste materials from the site, if necessary, for off-site treatment, storage, and/or disposal. The SM will also verify that each load of waste material is accompanied by a manifest and procedures outlined in the WDP are followed (as required). Additionally, Willbros's SM shall inspect all construction vehicles prior to leaving the project site to ensure that minimal soil adheres to wheels and undercarriages.

## **4.5 PROJECT TASK AND SEQUENCES**

The tank's product will be transferred by NAVFAC ESC or FISC personnel to the lowest level possible as described in the SOW. Our site management and project team will transfer, handle and dispose of the residual product and sludge as described in the SOW. This will be coordinated with NAVFAC site personnel. These activities will utilize proper PPE, equipment and safety procedures to provide a safe working environment.

We will transfer the residual re-useable product from the specified tank to a temporary or adjacent tank in the local area. The residual product will be transferred from the temporary tank to another adjacent or nearby tank or piping header connection. We will use a pump and temporary hoses as needed to transfer the residual product in the local area or range of up to 200ft.

Once the product reaches a low level and the product appears to be contaminated with rust or debris, the product will be transferred thru a filter to remove any remaining debris. Product which is not of an acceptable quality will be transported to the local flare unit and flared; or specified waste disposal site as defined in the SOW.





## Willbros Government Services, LLC – Project Execution Work Plan

---

Any residual sludge will be placed in approved 55 gallon shipping barrels for shipping and disposal at approved disposal sites. These barrels will have the required chain of custody and shipping documentation for transfer to the local disposal site or return shipment during de-mobilization for remote site locations. The barrels will be shipped to an approved disposal site and disposed of in accordance with proper hazardous waste disposal procedures.

The project SOW includes the project preparation, Lock Out Tag Out (LOTO) tank isolation, internal preparations to support activities, cleaning for personnel entry, waste disposal, inspection of tank and appurtenances, non-destructive testing, tank suitability for service reports and returning tanks to operational readiness. Tank repairs, modifications or alterations will be determined by NAVFAC after reviewing the tank integrity reports and approving which items are to be repaired. These repairs will be executed by change orders to the contract.

The following section list the chronological sequence and major task required to complete the project SOW for this task order. The next section contains the project SOW and relevant details for this task order.

Project planning, coordination and scheduling are the cornerstones of project execution. Project delivery in tasks as simple or complex as those we expect in this contract requires effective communication and execution of project task; disciplined and defined schedule, project goals and milestones to ensure the proper coordination of all elements needed to meet or exceed the customer needs. The list of major tasks is detailed below. See Appendix C for Project Execution Plan Drawing.

Willbros has combined the project requirements and our project management expertise to plan the scope of work in the most efficient manner.

Below is a chronological sequence of tasks to be performed to ensure timely, accurate completion of the task order requirements:

- Received notification of task award. ( NAVFAC )
- Conduct site visit and define SOW access and tie in points. ( WGS Project Manager )
- Complete draft design and work plan ( WGS Project Team )
- Engineering - Submit draft design and work plan to the NAVFAC. ( WGS Project Team )
- NAVFAC reviews and approves work plan and drawings. ( NAVFAC )
- Issue final work plan and drawings. ( WGS Project Team )
- Engineering – Define materials, equipment or supplies for procurement (WGS Project Engineer)
- Procurement - Procure all materials, equipment or supplies (WGS Procurement)
- Ship all materials, equipment or supplies to site. (WGS Logistics)
  - Receive all materials, equipment or supplies
  - Receive shipping containers
  - Load shipping containers and ship
  - Mobilize site manager to begin site orientation and develop communication with proper NTR and site personnel. Mobilize Site Manager to arrive prior to cleaning, inspection and construction support team arrival. Site Manager will perform recognizance of the area so that the rest of the team will be up to speed upon arrival. ( WGS Project & Site Manager )
  - Mobilize Cleaning, Inspection and Support Team.( WGS Project & Site Manager )
  - Perform Site Orientation with Site Manager and NAVFAC Field Representative. Perform required notifications. Obtain equipment from the port and perform inventory and inspection. (WGS Site Manager )
  - Hold kick-off meeting and perform the required safety requirements. ( WGS Site Manager )





- **Tank # 5 100 ft Dia. X 250 ft H – Red Hill Complex**
  - Mobilize and prep for work activities (WGS Site Manager)
    - Identify staging and storage area
    - Meet with the NTR and site POC to discuss project SOW
    - Meet with the NTR and site POC to discuss temp. equipment locations
    - Meet with the NTR and site POC to discuss temp. power locations
    - Set up equipment, containers and materials
    - Install and verify tunnel communications
  - Prep tanks including LOTO, install temporary blinds (WGS)
    - Install safety barricades
    - Drain or pump residual product into adjacent tank or connection header
    - Install temporary piping, hoses and/or equipment as for the cleaning system temporary tanks.
    - Install shoring and lifting devices as needed to install blinds
    - Drain remaining residual product
    - Install temporary isolation blinds
    - LOTO
  - Access the vent spool (WGS)
    - Install safety barricades
    - Remove any existing concrete, paint or bolt restrictions and dispose
    - Install shoring and lifting devices as needed to lift and rotate out of work path
    - Loosen & rotate spool, protect gasket surfaces
  - Install temporary ventilation and ducting (WGS)
    - Install safety barricades
    - Install temporary electrical power distribution panel and connect to the Gov't supplied power (WGS Electrical Technician or local electrician)
    - Install temporary wiring for power operations
    - Install ventilation blower, connect power and test operational readiness
    - Connect temporary ducting to the existing vent system for ventilation
  - Ventilate tank (WGS)
    - Verify safety perimeter for any area for potential gas vapors
    - Check valve alignment and equipment operations
    - Determine and install relevant safety barricades and signs
    - Initiate blower for ventilation
  - Remove Manways and items for access (WGS)
    - Install safety barricades
    - Install electric air compressors in local tunnels for air supply to air impact tools
    - Loosen bolts and remove manway
  - Remove bottom motorized skin valves for tank access and safety (WGS)
    - Install safety barricades
    - LOTO, electrical power and mechanical connections (Electrician)
    - Loosen bolts
    - Install shoring or supports as needed to lift and lower the motorized valves.
    - Stage valves in non-traffic area
    - Protect gasket surfaces and electrical connections
  - Install temporary explosion proof lighting (WGS)
    - Perform confined space entry procedure, gas test (Safety)
    - Confirm environmental conditions and select proper PPE (personnel protective equipment)





## Willbros Government Services, LLC – Project Execution Work Plan

---

- As specified in the confined space permit, utilize proper PPE and install temporary explosion proof electrical lighting. Lighting utilized will conform to the appropriate atmospheric conditions and vapors.
- Inspect catwalk & tower structure (WGS – Doug Bayles – Hawaii PE)
  - Confirm conditions of the confined space permit and utilize proper PPE.
  - Perform inspection of catwalk and handrails. ( WGS – Doug Bayles – Hawaii PE)
  - Identify any deficiencies and provide list and recommendations to NAVFAC.
  - Make repairs as directed by NAVFAC authorized personnel and properly executed change order.
- Install crane or boom systems – (2) Booms Systems or Guyless derricks (WGS Specialist)
  - Install safety barricades
  - Install and stage crane, boom system or guyless derricks.
  - Install working scaffold to tower for crane, boom system or guyless derrick access.
  - Install temporary lifting devices to set crane or boom equipment to tower structure.
  - Install crane, boom system or guyless derrick systems.
  - Install and bolt to the tower structure
  - Install controls; system, performance and load test
- Install tank cleaning system and temporary piping, transfer and storage system (WGS)
  - Install safety barricades
  - Install temporary wash solution tank
  - Install temporary rinsate return tank
  - Install temporary Frac Tank
  - Install temporary hoses, piping from tank to Frac tank system
  - Install cleaning pressure wash system
  - Test cleaning system
- Clean tanks (WGS)
  - Install safety barricades
  - Obtain confined space entry, select PPE based on conditions
  - Pressure wash with (2) crews from man baskets on the crane, boom system or guyless derricks.
  - Wash residual product and sludge into rinsate and return system, transfer waste from the rinsate tank through the tunnel slop lines to the central slop line sump, transfer and pump the waste to the Frac tank located near the upper access tunnel in the contractor staging area.
  - Transfer waste product and sludge to disposal site via a vacuum truck.
  - Complete tank cleaning
  - Obtain certification from Marine chemist / CIH
  - Breakdown, remove equipment from tank
- Pressure test lower tank piping to header (WGS)
  - Install pressure testing equipment
  - Install safety barricades
  - Pressure test piping spools from header to tank
  - Complete test and documentation
  - Breakdown test set up and remove from tank
- Perform non-destructive testing on tank components (Testex)
  - Install equipment and operational test
  - Obtain confined space entry, select PPE based on conditions
  - NDT testing with (2) crews from man baskets and guyless derricks.
  - UT Proof areas identified as potential concern
  - Breakdown, remove equipment from tank
  - Preliminary daily and final reports
- Inspect tanks, appurtenances and coating (WGS)





## Willbros Government Services, LLC – Project Execution Work Plan

---

- Install equipment and operational test for API653 inspection
  - Obtain confined space entry, select PPE based on conditions
  - API653 inspection from man baskets on the crane, boom system or guylless derricks. Proof NDT testing areas and identify areas of potential concern
  - Breakdown, remove equipment from tank
  - Preliminary daily and final reports
  - Perform strapping and tank calibration with high definition 3D scan
    - Set up equipment and operational test for tank calibration strapping
    - Obtain confined space entry, select PPE based on conditions
    - Tank calibration strapping from man baskets on the crane, boom system or guylless derricks.
    - Breakdown, remove equipment from tank
    - Preliminary daily and final reports
  - Submit preliminary and final inspection reports (WGS Site Manager to NTR)
  - Tank repairs – as approved by NAVFAC change order or contract modification.
  - Install bottom motorized valves (WGS)
    - Set up safety barricades
    - LOTO, electrical power and mechanical connections (Electrician)
    - Install shoring or supports as needed to lift and install the motorized valves.
    - Protect gasket surfaces and electrical connections
    - Install bolting utilizing proper torquing procedures
  - Remove temporary ducting and blinds (WGS)
    - Set up safety barricades
    - Set up shoring and lifting devices as needed to remove blinds
    - Remove temporary piping, hoses and/or equipment as for the cleaning system temporary tanks.
    - Remove LOTO
  - Return Tank control back to Facility Operations (WGS Site Manager)
  - Demobilize equipment and manpower to next tank ( WGS Project Team)
- **Tank # 17 100 ft Dia. X 250 ft H – Red Hill Complex**
- Mobilize and prep for work activities (WGS Site Manager)
  - Identify staging and storage area
  - Meet with the NTR and site POC to discuss project SOW
  - Meet with the NTR and site POC to discuss temp. equipment locations
  - Meet with the NTR and site POC to discuss temp. power locations
  - Set up equipment, containers and materials
  - Install and verify tunnel communications
- Prep tanks including LOTO, install temporary blinds (WGS)
  - Install safety barricades
  - Drain or pump residual product into adjacent tank or connection header
  - Install temporary piping, hoses and/or equipment as for the cleaning system temporary tanks.
  - Install shoring and lifting devices as needed to install blinds
  - Drain remaining residual product
  - Install temporary isolation blinds
  - LOTO
- Access the vent spool (WGS)
  - Install safety barricades
  - Remove any existing concrete, paint or bolt restrictions and dispose
  - Install shoring and lifting devices as needed to lift and rotate out of work path





## Willbros Government Services, LLC – Project Execution Work Plan

---

- Loosen & rotate spool, protect gasket surfaces
- Install temporary ventilation and ducting (WGS)
  - Install safety barricades
  - Install temporary electrical power distribution panel and connect to the Gov't supplied power (WGS Electrical Technician or local electrician)
  - Install temporary wiring for power operations
  - Install ventilation blower, connect power and test operational readiness
  - Connect temporary ducting to the existing vent system for ventilation
- Ventilate tank (WGS)
  - Verify safety perimeter for any area for potential gas vapors
  - Check valve alignment and equipment operations
  - Determine and install relevant safety barricades and signs
  - Initiate blower for ventilation
- Remove Manways and items for access (WGS)
  - Install safety barricades
  - Install electric air compressors in local tunnels for air supply to air impact tools
  - Loosen bolts and remove manway
- Remove bottom motorized skin valves for tank access and safety (WGS)
  - Install safety barricades
  - LOTO, electrical power and mechanical connections (Electrician)
  - Loosen bolts
  - Install shoring or supports as needed to lift and lower the motorized valves.
  - Stage valves in non-traffic area
  - Protect gasket surfaces and electrical connections
- Install temporary explosion proof lighting (WGS)
  - Perform confined space entry procedure, gas test (Safety)
  - Confirm environmental conditions and select proper PPE (personnel protective equipment)
  - As specified in the confined space permit, utilize proper PPE and install temporary explosion proof electrical lighting. Lighting utilized will conform to the appropriate atmospheric conditions and vapors.
- Inspect catwalk & tower structure (WGS – Doug Bayles – Hawaii PE)
  - Confirm conditions of the confined space permit and utilize proper PPE.
  - Perform inspection of catwalk and handrails. ( WGS – Doug Bayles – Hawaii PE)
  - Identify any deficiencies and provide list and recommendations to NAVFAC.
  - Make repairs as directed by NAVFAC authorized personnel and properly executed change order.
- Install crane or boom systems – (2) Booms Systems or Guyless derricks (WGS Specialist)
  - Install safety barricades
  - Install and stage crane, boom system or guyless derricks.
  - Install working scaffold to tower for crane, boom system or guyless derrick access.
  - Install temporary lifting devices to set crane or boom equipment to tower structure.
  - Install crane, boom system or guyless derrick systems.
  - Install and bolt to the tower structure
  - Install controls; system, performance and load test
- Install tank cleaning system and temporary piping, transfer and storage system (WGS)
  - Install safety barricades
  - Install temporary wash solution tank
  - Install temporary rinsate return tank
  - Install temporary Frac Tank
  - Install temporary hoses, piping from tank to Frac tank system





## Willbros Government Services, LLC – Project Execution Work Plan

---

- Install cleaning pressure wash system
- Test cleaning system
- Clean tanks (WGS)
  - Install safety barricades
  - Obtain confined space entry, select PPE based on conditions
  - Pressure wash with (2) crews from man baskets on the crane, boom system or guylless derricks.
  - Wash residual product and sludge into rinsate and return system, transfer waste from the rinsate tank through the tunnel slop lines to the central slop line sump, transfer and pump the waste to the Frac tank located near the upper access tunnel in the contractor staging area.
  - Transfer waste product and sludge to disposal site via a vacuum truck.
  - Complete tank cleaning
  - Obtain certification from Marine chemist / CIH
  - Breakdown, remove equipment from tank
- Pressure test lower tank piping to header (WGS)
  - Install pressure testing equipment
  - Install safety barricades
  - Pressure test piping spools from header to tank
  - Complete test and documentation
  - Breakdown test set up and remove from tank
- Perform non-destructive testing on tank components (Testex)
  - Install equipment and operational test
  - Obtain confined space entry, select PPE based on conditions
  - NDT testing with (2) crews from man baskets and guylless derricks.
  - UT Proof areas identified as potential concern
  - Breakdown, remove equipment from tank
  - Preliminary daily and final reports
- Inspect tanks, appurtenances and coating (WGS)
  - Install equipment and operational test for API653 inspection
  - Obtain confined space entry, select PPE based on conditions
  - API653 inspection from man baskets on the crane, boom system or guylless derricks. Proof NDT testing areas and identify areas of potential concern
  - Breakdown, remove equipment from tank
  - Preliminary daily and final reports
- Perform strapping and tank calibration with high definition 3D scan
  - Set up equipment and operational test for tank calibration strapping
  - Obtain confined space entry, select PPE based on conditions
  - Tank calibration strapping from man baskets on the crane, boom system or guylless derricks.
  - Breakdown, remove equipment from tank
  - Preliminary daily and final reports
- Submit preliminary and final inspection reports (WGS Site Manager to NTR)
- Tank repairs – as approved by NAVFAC change order or contract modification.
- Install bottom motorized valves (WGS)
  - Set up safety barricades
  - LOTO, electrical power and mechanical connections (Electrician)
  - Install shoring or supports as needed to lift and install the motorized valves.
  - Protect gasket surfaces and electrical connections
  - Install bolting utilizing proper torquing procedures
- Remove temporary ducting and blinds (WGS)





## Willbros Government Services, LLC – Project Execution Work Plan

---

- Set up safety barricades
- Set up shoring and lifting devices as needed to remove blinds
- Remove temporary piping, hoses and/or equipment as for the cleaning system temporary tanks.
- Remove LOTO
- Return Tank control back to Facility Operations (WGS Site Manager)
- Demobilize equipment and manpower ( WGS Project Team)
- Prepare final documentation per project requirements.

Following the completion of the on-site work, the documentation book will be provided including all reports, inspection results, and other documentation.

### 4.5.1 Tank and Pipe Cleaning

The storage tanks will be cleaned utilizing the following procedure. Our site manager will coordinate with the cleaning crew to perform all of the tank cleaning, temporary storage, transfer and disposal. Willbros will perform these activities for this project. Willbros cleaning crew personnel has performed similar activities on other Red Hill Complex and Pearl Harbor projects. The tank cleaning procedures and approach incorporates the requirements specified in OSHA- 29 CFR 1910, API-2015 and API-2016.

A comprehensive (HS&E) Health Safety & Environmental Plan has been outlined and developed for the Red Hill Complex Project. The HS&E plan carefully monitors the safety and condition of the tank, surrounding tunnel environments and area personnel to ensure a safe work place is maintained throughout all phases of the project and activities. This plan ensures the careful preparation, communication, coordination, controls and execution of all activities for this SOW and as applicable for surrounding activities.

The Site Manager and cleaning crew will meet for daily safety meetings to review the (JSA) Job Safety Analysis form, confined space entry permit, gas atmospheric testing and surrounding conditions. All immediate and surrounding concerns will be noted, monitored and evaluated throughout the day for potential changes. LOTO will be in place and verified to ensure there are not any improper releases of energy or gases into the surrounding environment. Continuous oxygen, gas LEL and environmental monitors will be utilized by local base and individual personnel monitors. Trained confined space attendants will be stationed on both levels for continuous monitoring of the working personnel and surrounding conditions.

Temporary isolation blinds will be installed at the tank or piping connections for LOTO and ducting interconnected for the initial ventilation of the tanks. The tanks or piping will continue to have air movers installed to maintain a safe working environment for the tank atmosphere and surrounding areas. The cleaning crew will utilize scaffolds, boom systems or guylens derricks and man baskets for access to all elevated areas of the tank or piping for cleaning.

Temporary piping, hoses, portable and Frac tanks will be staged in a closed loop system for liquids and sludge as it exits the tank. These liquids and sludge will be received in the recycle rinsate return tank at the bottom of the tanks, transferred via temporary piping up to 200 ft away to the tunnel slop line, then to the central slop line sump and pumped by the sump pump to a Frac tank located at the contractor staging area outside of the upper access tunnel within 100 ft. Vacuum trucks will load the waste product, transport to a registered disposal site for processing and disposal. The waste disposal will process and dispose of a maximum of twenty (20) BBLs of sludge from each tank as specified in the NAVFAC SOW.

#### 4.5.1.1 Air Monitoring

Air monitoring must be performed on all sites in accordance with company and industry safety practices. Organic vapor concentrations are monitored in the field with a photo ionization detector (PID). Flammable vapor and/or gas are monitored with an oxygen/combustible meter real-time instrument, the instrument also measures for concentrations of CO (carbon monoxide) and H<sub>2</sub>S (hydrogen sulfide).

Engineering controls such as the venturi air mover or pneumatic blower (supplied by compressed air) or motorized blower to exhaust or dilute vapors emanating from product or sludge in the tank will be utilized.

All work will comply with the Occupational Safety and Health Act (OSHA) standard, "Hazardous Waste Operations and Emergency Response" (29 CFR 1910.120), and other federal, state, and local procedures





that are included and implemented in Willbros (WGS) Site-Specific Health and Safety Plan (HS&EP). Generation and use of this document certifies that the workplace has been evaluated for the hazards as described. A hazard assessment will be performed and the adequacy of the personal protective equipment (PPE) will be selected and certified per 29 CFR 1910.132 (d) which is duly noted by the signature(s) and date appearing on the confined space entry form.

#### **4.5.1.2 Commencing the AST Cleaning Process - Fuel Removal, Waste Handling, Pressure Washing, and Disposal**

The Site Manager will notify the Navy NTR a minimum of five working days in advance to ensure adequate time is available to transfer fuel before starting tank cleaning requirements. All on specification fuel (product) will be transferred to another tank of the same product by utilizing an air driven pump, a portable filter and either through installed piping or contractor furnished hoses. After the transfer of all on specification fuel the remaining product and sludge will be removed to the base for incineration or a specified disposal processing site as specified in the SOW.

Rinsate from the tank cleaning process will be removed and disposed via the waste treatment plant or a specified disposal processing site as specified in the SOW. After all fuel, sludge and initial rinse has been removed and the LEL is below 10 % and the O<sub>2</sub> is above 19.5% the tank shall be entered with Level C- PPE and with forced ventilation.

A high pressure spray wash of the tank interior and internal components shall be conducted and all rinsate pumped out and transferred to waste treatment or a specified disposal processing site as specified in the SOW. After an LEL of < 1%, O<sub>2</sub> above 19.5%, no CO or H<sub>2</sub>S then continued tank cleaning can continue with Modified Level D – PPE.

#### **4.5.1.3 Cleaning Covered, Underground, Floating or Fixed Roof Tanks**

Personnel entering underground or floating-roof tanks will be familiar with design elements that affect entry, identify confined or restricted spaces and cleaning activities. They will:

- Inspect and determine condition of the confined or restricted space, floating roof areas before workers descend onto it.
- Determine best method of safely entering a confined or restricted space, descending onto the floating roof to reposition roof support legs.
- Determine best method of vapor freeing tank, including any confined or restricted spaces, the area under the roof resting on support legs or between the fixed roof and the floating roof.
- Determine if hydrocarbons are entrapped in confined or restricted space, pontoons, seal envelopes or foam panels.
- Clean peripheral pontoons or retention areas.
- Gas test complete double decks, retention areas or spaces.
- Clean seals that enclose annular space between floating roof and shell. They will use flexible foam-filled bags.

#### **4.5.1.4 Confined Space Safe Entry Certification**

After the cleaning process is completed the tank will be checked by a Marine Chemist or Certified Industrial Hygienist and certified safe for personnel entry.





#### 4.5.2 Tank Inspections

The inspection of Red Hill Complex Tanks 5 and 17 shall be carried out according to the requirements of API Standard 653, Tank Inspection, Repair, Alteration and Reconstruction; and as supplemented by this Statement of Work. The inspections will be performed in a safe and professional manner, and the inspection, preliminary and final field report, and tank evaluation will be completed in accordance with applicable federal and local regulations.

Willbros will provide the onsite API653 and visual inspection, NDT data review and integrity analysis. Willbros will provide certified API653 and/or STI inspector as appropriate to complete the project. Willbros will utilize Engineering & Inspection of Hawaii to assist as needed.

Testex will be performing all of the (NDT) non-destructive testing for the tank shell, upper and lower domes, welds and appurtenances. Testex will be providing (2) two (NDT) non-destructive testing crews to provide the wall and component thickness readings. Testex will utilize three different NDT methods as previously performed on the last (4) tank inspections at the Red Hill Storage Tanks. The NDT evaluation and testing methods will be utilizing (LFET) Low Frequency Electromagnetic Technique – Falcon 2000 Mark II and (BFET) Balanced Field Electromagnetic Technique – Hawkeye; and traditional ultrasonic longitudinal and shearwave inspection for proofing areas. Testex has developed site specific equipment inspection and testing equipment and procedures for the Red Hill storage tanks. Testex has performed these procedures and test on the Red Hill storage tanks from 2004 thru 2009.

The NDE testing and evaluation SOW includes 100% of courses A, B, C, D, E and F of the upper dome, the extension (including the manway), the barrel (including under Cat Walk), courses 1, 2, 3, 4 of the lower dome, and the floor. The LFET Falcon 2000 Mark II system will be used for component scanning for wall thickness and back side corrosion, with UT prove up as needed. The BFET - Hawkeye system will be used to evaluate the accessible tank welds for surface and toe cracks with shearwave prove up as needed.

The inspector will be assisted by our on-site personnel as needed to perform the visual inspection. Testex and the API653 inspector are qualified to ASNT NDE Level II in performing all NDE inspections. The API653 inspector will monitor the NDE testing and review the test data acquired for potential areas of concern and to have follow-up proof UT inspections.

Our API653 inspector is experienced in tank design, fabrication, repair, construction, inspection, operation and behavior will perform the tank engineering evaluation. The inspection will include the following.

##### 4.5.2.1 Historical Review Record

The API653 inspector will establish a historical record of the entire tank detailing as much information as possible, including:

- Nameplate Information - tank dimensions, capacity, operating and design pressure.
- Tank Data- original manufacturer, construction contractor, and year of construction.
- All applicable construction standards used.
- A general plan drawing, showing the general arrangement of the major components, and the location and size of all penetrations. Product presently stored.
- Design specific gravity, maximum permissible liquid level and maximum operating temperature.
- Shell material and allowable stress of each shell course to be used in calculations.
- Previous inspection reports, as available.
- List and description of any significant environmental (earthquake, hurricane, etc.) Or operational (over-pressure, vacuum, foundation settlement, etc.) events.
- Description of any repairs or alterations completed (drawings, material test reports/certifications, radiographs attached, etc.)
- All other pertinent information and details.





#### 4.5.2.2 General Tank Overview

The API653 inspector will perform a general overview of the tank for compliance with latest editions of API650, Welded Steel Tanks for Oil Storage, API653, tank inspection, repair, alteration and reconstruction, API651, cathodic protection of aboveground petroleum storage tanks, good tank construction, industry standards and operating practice. This includes as applicable, but is not limited to:

- General assessment of the tank site, soil structures, berm, dike and dike drainage, soil conditions and surrounding areas.
- Description of nearby tanks that could possibly affect the tank undergoing inspection.
- Description of any signs of over-pressure or vacuum such as shell buckling, distortions, dimpling not accounted for in the historical review.
- Description of any signs of significant natural attack or event not accounted for in the historical review.

He will also perform a comprehensive visual inspection on all tank components, including recording of observations.

#### 4.5.2.3 Definitive Shell Inspection

A definitive shell inspection will be performed according to API653 Section 4 including LFET or Ultrasonic testing (UT) readings which are taken as follows:

##### Site Specific Inspection Criteria: ( Red Hill Project Testing Requirements )

- Shell courses: Per the NDT section SOW.

If the original plate thickness is not known and the shell plates do not appear badly corroded, the inspector shall use the average of the highest LFET or UT reading of each plate in the course as the nominal thickness. To determine the controlling thickness of a badly corroded shell course, API653 section 4, shall be used. Corroded areas will be mapped in the Tank Evaluation Report.

##### Tank Shell Measurements

The tank shell will be measured in accordance with API-653 for dimensional tolerances. All measurements, including peaking, banding, plumbness and roundness, will be performed according to API-653 and recorded in the engineering data. We will include them in the Tank Evaluation Report.

#### 4.5.2.4 Definitive Dome Roof Inspection

The inspector will not access the structure or roof without first determining the extent of thinning of the component. On Floating Roof Tanks, guidance for the evaluation will be based upon the criteria of API653 and API650 - Appendix C, for external floating roofs or Appendix H for internal floating roofs.

On Fixed Roof Tanks, the inspection is performed in accordance with API653 Section 4. LFET or UT readings will be taken as follows:

- Rectangular plates: Per the NDT section SOW.
- Sketch plates: Per the NDT section SOW.
- Any corroded areas will be mapped in the Tank Evaluation Report.

For Structurally Supported Aluminum Dome Roofs Guidance for the evaluation will be based upon the criteria of API650 - Appendix G.

For Steel Floating Roofs inspections are conducted in accordance with API653 Section 4. LFET or UT readings are taken as follows:

- Rectangular plates: Per the NDT section SOW.
- Sketch plates: Per the NDT section SOW.

Any corroded areas shall be mapped in the Tank Evaluation Report.





#### **4.5.2.5 Full Bottom & Lower Dome Inspection**

The NDT technicians and API653 inspector will conduct tank bottom inspections according to API-653, Section 4. LFET or UT readings as follows:

- Rectangular plates: Per the NDT section SOW.
- Sketch plates: Per the NDT section SOW.
- Circumferential readings: Per the NDT section SOW.
- Any defects shall be mapped in the Tank Evaluation Report and marked on the tank.
- Any relevant corrosion areas shall be mapped in the Tank Evaluation Report.
- In areas where LFET examination indicates loss of material, UT measurement back up is completed to verify extent of underside corrosion. Defects are mapped in the Tank Evaluation Report and marked on the tank.

#### **4.5.2.6 Tank Foundation Inspection**

A survey of the foundation near the outside will be performed as accessible or applicable to identify any foundation settlement, erosion, cracking or other failure. There must be a minimum of eight (8) equally spaced elevation readings, with a maximum spacing of 32 feet around the circumference. The condition of any anchor bolts or embedment will be observed and recorded. All surveying will be performed according to API-653 Appendix B and recorded on appropriate forms. All survey results will be included in the Tank Evaluation Report.

#### **4.5.2.7 Inspection of Tank Appurtenances**

The tank nozzles, man-ways, and other appurtenances will be examined for adequacy of wall thickness, reinforcement, weld spacing and corrosion. Observations will be made from both the outside and inside of the tank, as accessible. Nozzles will be examined for structural adequacy and compliance with applicable standard. Tank accessories, such as relief valves and level gauges will be examined for functionality and general condition, if possible.

#### **4.5.2.8 Inspection Checklists**

Inspection checklists are taken from the current API653. An In-service and an Out-of-service checklist must be followed for all Out-of-service Inspections. Non-applicable items must be marked N/A, while inspection write ups elaborate on items of non-conformance or disrepair. Items of recommendations for improvement or marginally passable items will be acknowledged and noted.

#### **4.5.2.8 Table of Contents of the Completion Report**

The table of contents of our completion will report will include at a minimum the information listed below:

- Introduction and Executive Summary
- Suitability For Service Statement
- References
  - American Petroleum Institute Standards & RPs
  - American Society of Mechanical Engineers Codes
  - Code of Federal Regulations
  - National Association of Corrosion Engineers Standards & RPs
  - National Fire Protection Association Standards & Codes
  - Underwriters Laboratories Inc. Standards & RPs





- American Society of Nondestructive Testing Standards & RPs
- Description
  - Job Description
  - Tank Description
  - Service Description
  - Part Description
  - Joint Type Description
  - Inspection Description
- Inspection
  - Inspection Results/Findings
  - Non-Destructive Testing
  - Pressure Testing of applicable tank piping
  - Maintenance Recommendations-Short Term
  - Maintenance Recommendations-Long Term
  - Compliance Requirements
  - Serviceability Statement
  - Recommended Inspection Schedule
  - Near Future Recommendations
  - Long Term Repair Recommendations
- Appendices
  - Engineering Calculations
  - Engineering Data
  - Engineering Drawings
  - API Checklists
  - Photographs
  - Field Data/Equipment Certifications
  - Calibration / Strapping Charts

#### **4.5.3 Tank Calibration**

The tanks will be strapped (calibrated) in accordance with API's Manual of Petroleum Measurement Standards Chapter 2 – Tank Calibration utilizing the Optical Method. A three-dimensional scan of the tank internal wall will be performed utilizing a GPT-3100W Non-Prism Total Station to accomplish a high definition scan. A proprietary computer program will then be utilized to determine precise tank capacities and generate the final tank calibration charts. Interspec, LLC will perform the strapping, dimensioning and final tank calibration charts. See sample below





**Sample Format**  
1/16 inch - 2 feet per page

0 FEET							1 FEET								
0 **	776	3	1,622	6	2,467	9	3,312	0	4,158	3	5,003	6	5,849	9	6,695
1/16	793	1/16	1,639	1/16	2,485	1/16	3,330	1/16	4,176	1/16	5,021	1/16	5,867	1/16	6,713
1/8	811	1/8	1,657	1/8	2,502	1/8	3,348	1/8	4,193	1/8	5,039	1/8	5,885	1/8	6,731
3/16	829	3/16	1,675	3/16	2,520	3/16	3,365	3/16	4,211	3/16	5,056	3/16	5,902	3/16	6,748
1/4	846	1/4	1,692	1/4	2,538	1/4	3,383	1/4	4,228	1/4	5,074	1/4	5,920	1/4	6,766
5/16	864	5/16	1,710	5/16	2,555	5/16	3,401	5/16	4,246	5/16	5,092	5/16	5,938	5/16	6,784
3/8	881	3/8	1,727	3/8	2,573	3/8	3,418	3/8	4,264	3/8	5,109	3/8	5,955	3/8	6,801
7/16	899	7/16	1,745	7/16	2,590	7/16	3,436	7/16	4,281	7/16	5,127	7/16	5,973	7/16	6,819
1/2	917	1/2	1,763	1/2	2,608	1/2	3,453	1/2	4,299	1/2	5,144	1/2	5,990	1/2	6,836
9/16	934	9/16	1,780	9/16	2,626	9/16	3,471	9/16	4,316	9/16	5,162	9/16	6,008	9/16	6,854
5/8	952	5/8	1,798	5/8	2,643	5/8	3,489	5/8	4,334	5/8	5,180	5/8	6,026	5/8	6,872
11/16	970	11/16	1,816	11/16	2,661	11/16	3,506	11/16	4,352	11/16	5,197	11/16	6,043	11/16	6,889
3/4	987	3/4	1,833	3/4	2,678	3/4	3,524	3/4	4,369	3/4	5,215	3/4	6,061	3/4	6,907
13/16	1,005	13/16	1,851	13/16	2,696	13/16	3,542	13/16	4,387	13/16	5,233	13/16	6,079	13/16	6,925
7/8	1,022	7/8	1,868	7/8	2,714	7/8	3,559	7/8	4,404	7/8	5,250	7/8	6,096	7/8	6,942
15/16	1,040	15/16	1,886	15/16	2,731	15/16	3,577	15/16	4,422	15/16	5,268	15/16	6,114	15/16	6,960
1	1,058	4	1,904	7	2,749	10	3,594	1	4,440	4	5,285	7	6,131	10	6,977
1/16	1,075	1/16	1,921	1/16	2,766	1/16	3,612	1/16	4,457	1/16	5,303	1/16	6,149	1/16	6,995
1/8	1,093	1/8	1,939	1/8	2,784	1/8	3,630	1/8	4,475	1/8	5,321	1/8	6,167	1/8	7,013
3/16	1,111	3/16	1,957	3/16	2,802	3/16	3,647	3/16	4,493	3/16	5,338	3/16	6,184	3/16	7,030
1/4	1,128	1/4	1,974	1/4	2,819	1/4	3,665	1/4	4,510	1/4	5,356	1/4	6,202	1/4	7,048
5/16	1,146	5/16	1,992	5/16	2,837	5/16	3,682	5/16	4,528	5/16	5,374	5/16	6,220	5/16	7,066
3/8	1,163	3/8	2,009	3/8	2,854	3/8	3,700	3/8	4,545	3/8	5,391	3/8	6,237	3/8	7,083
7/16	1,181	7/16	2,027	7/16	2,872	7/16	3,718	7/16	4,563	7/16	5,409	7/16	6,255	7/16	7,101
1/2	1,199	1/2	2,045	1/2	2,890	1/2	3,735	1/2	4,581	1/2	5,426	1/2	6,272	1/2	7,118
9/16	1,216	9/16	2,062	9/16	2,907	9/16	3,753	9/16	4,598	9/16	5,444	9/16	6,290	9/16	7,136
5/8	1,234	5/8	2,080	5/8	2,925	5/8	3,771	5/8	4,616	5/8	5,462	5/8	6,308	5/8	7,154
11/16	1,252	11/16	2,098	11/16	2,942	11/16	3,788	11/16	4,633	11/16	5,479	11/16	6,325	11/16	7,171
3/4	1,269	3/4	2,115	3/4	2,960	3/4	3,806	3/4	4,651	3/4	5,497	3/4	6,343	3/4	7,189
13/16	1,287	13/16	2,133	13/16	2,978	13/16	3,823	13/16	4,669	13/16	5,515	13/16	6,361	13/16	7,207
7/8	1,304	7/8	2,150	7/8	2,995	7/8	3,841	7/8	4,686	7/8	5,532	7/8	6,378	7/8	7,224
15/16	1,322	15/16	2,168	15/16	3,013	15/16	3,859	15/16	4,704	15/16	5,550	15/16	6,396	15/16	7,242
2	1,340	5	2,186	8	3,030	11	3,876	2	4,721	5	5,567	8	6,413	11	7,259
1/16	1,357	1/16	2,203	1/16	3,048	1/16	3,894	1/16	4,739	1/16	5,585	1/16	6,431	1/16	7,277
1/8	1,375	1/8	2,221	1/8	3,066	1/8	3,911	1/8	4,757	1/8	5,603	1/8	6,449	1/8	7,295
3/16	1,393	3/16	2,238	3/16	3,083	3/16	3,929	3/16	4,774	3/16	5,620	3/16	6,466	3/16	7,312
1/4	1,410	1/4	2,256	1/4	3,101	1/4	3,947	1/4	4,792	1/4	5,638	1/4	6,484	1/4	7,330
5/16	1,428	5/16	2,274	5/16	3,119	5/16	3,964	5/16	4,810	5/16	5,656	5/16	6,502	5/16	7,348
3/8	1,445	3/8	2,291	3/8	3,136	3/8	3,982	3/8	4,827	3/8	5,673	3/8	6,519	3/8	7,365
7/16	1,463	7/16	2,309	7/16	3,154	7/16	3,999	7/16	4,845	7/16	5,691	7/16	6,537	7/16	7,383
1/2	1,481	1/2	2,326	1/2	3,171	1/2	4,017	1/2	4,862	1/2	5,708	1/2	6,554	1/2	7,400
9/16	1,498	9/16	2,344	9/16	3,189	9/16	4,035	9/16	4,880	9/16	5,726	9/16	6,572	9/16	7,418
5/8	1,516	5/8	2,362	5/8	3,207	5/8	4,052	5/8	4,898	5/8	5,744	5/8	6,590	5/8	7,436
11/16	1,534	11/16	2,379	11/16	3,224	11/16	4,070	11/16	4,915	11/16	5,761	11/16	6,607	11/16	7,453
3/4	1,551	3/4	2,397	3/4	3,242	3/4	4,088	3/4	4,933	3/4	5,779	3/4	6,625	3/4	7,471
13/16	1,569	13/16	2,414	13/16	3,260	13/16	4,105	13/16	4,951	13/16	5,797	13/16	6,643	13/16	7,489
7/8	1,586	7/8	2,432	7/8	3,277	7/8	4,123	7/8	4,968	7/8	5,814	7/8	6,660	7/8	7,506
15/16	1,604	15/16	2,450	15/16	3,295	15/16	4,140	15/16	4,986	15/16	5,832	15/16	6,678	15/16	7,524

**Capacities in Gallons**

\*\* Volume below Strike Point. \* Bottom Volumes based on Physical Survey.  
\*\* Strike Point located 1.80" above intersection of shell & bottom.

Liquid Head Calculated at 35.0 API.  
Volumes reflect a Steel Temperature of 60 F.

Nominal Tank Size - 100' 0" Diameter x 40' 0" Height.  
See Page 2 for Floating Roof Information.

Safe Fill Height - 38' 00".

Strapped : 11 August 2009  
Computed : G.D.B  
File No. : 123456/S789

Calculated per API MPMS  
Ch. 2.2A/95 & Ch. 2.2D/03

**Figure 4-1 Sample Tank Calibration Calculations**





#### **4.6 HEALTH, SAFETY AND ENVIRONMENTAL MANAGEMENT**

A comprehensive preliminary (HS&E) Health Safety & Environmental Plan has been outlined and developed for the Red Hill Complex Project. The HS&E plan carefully monitors the safety and condition of the tank, surrounding tunnel environments and area personnel to ensure a safe work place is maintained throughout all phases of the project and activities. This plan ensures the careful preparation, communication, coordination, controls and execution of all activities for this SOW and as applicable for surrounding activities.

The Site Manager, HSO and associated crews will meet for daily safety meetings to review the (JSA) Job Safety Analysis form, confined space entry permit, gas atmospheric testing and surrounding conditions. All immediate and surrounding concerns will be noted, monitored and evaluated throughout the day for potential changes. Lock out Tag out (LOTO) will be in place and verified to ensure there are not any improper releases of energy or gases into the surrounding environment. Continuous oxygen, gas LEL and environmental monitors will be utilized by competent trained personnel. Trained confined space attendants will be stationed on both levels as needed for continuous monitoring of the working personnel and surrounding conditions. Atmospheric conditions will be maintained at the appropriate OSHA PEL levels. Personnel PPE will be updated to appropriate atmospheric condition. Any area that will be outside of the OSHA PEL levels will be barricaded and have signs posting the appropriate PPE level for entry.

WGS will mount two (2) boom systems or guylless derricks to the center structure of the specified tank which is out of service. The two (2) boom systems or guylless derricks will provide an additional back up system for safety purposes. The additional derrick provides an alternative resource and method for high angle access rescue.

Willbros has reviewed the SOW and developed a preliminary HS&E Plan to encompass all of the activities, environments and surrounding areas. WGS will prepare a final SSHEP site-specific safety plan that implements a safety program conforming to OSHA 1910 and EM 385-1-1, U.S. Army Corps of Engineers Safety and Health Requirements, Appendix A, Minimum Basic Outline for Accident Prevention, and sections. Safety measures that will be taken during the on-site work include the use of permits, monitoring confined space procedures and having respiratory equipment in the standby position. Other safety measures include the use of hard hats, safety toe footwear, safety eye wear, brass hammers and brass wrenches. All work will be with in the appropriate compliance of environmental and safety standards and/or regulations.

#### **4.7 SUBCONTRACTOR MANAGEMENT AND COORDINATION**

Our Program Manager will coordinate with our Corporate Procurement Department, Project Manager, Site Manager, Engineer, vendors and suppliers to open accounts, coordinate orders and delivery schedules, and enter required information for each vendor and supplier in our purchasing database.

The Program Manager makes the final decision on the use of vendors and subcontractors. He has the authority to make commitments for the company on proposals, modifications and subcontract agreements. However, requirements always exist throughout the effort that requires a subcontractor or specialized vendor. Our process provides proven steps to select the most qualified subcontractor or vendor. The Program Manager has the final authority on all decisions made from identifying subcontractors and vendors until service or work completion, or parts have passed all tests.

Our Corporate Procurement Department directly supports our NAVFAC project team as follows:

- Identify and prequalify vendors and suppliers for inclusion in our Worldwide Supplier database
- Assist in preparing the Master Agreements and blanket purchase agreements
- Facilitate the distribution of the agreements to minority and woman-owned businesses
- Expedite deliveries of equipment and material during phase-in to ensure the project functions immediately
- Provide any other purchasing assistance needed to ensure quick, orderly delivery of service





## Willbros Government Services, LLC – Project Execution Work Plan

---

Qualified subcontractors who have the required licenses, specialized equipment, skilled personnel and established proficiency training programs to support the requirement are best suited to execute the specialized requirements of this contract. We follow specific steps to ensure subcontractors have the qualifications and resources to perform appropriately. By applying these methods to subcontractor selection, we ensure that the subcontractors selected meet our high standards for performance, quality and timeliness. The process comprises the following:

- Conduct face-to-face meetings with potential subcontractors
- Provide a clear and detailed Statement of Work (SOW) or Material/Part Specifications
- Review quality of past performance
- Examine financial resources including the availability of a line of credit to finance operations between payments and any potential or existing contractual and/or legal issues
- Validate that subcontractor management is experienced and has a proven track record of successful on-time completion of quality work on contracts similar in scope and size
- Verify subcontractor has a permanent team of craftsmen skilled, licensed, and certified in the required specialty areas
- Appraise existing capital equipment on hand to perform the targeted work scope versus the amount of equipment that would have to be purchased to perform the work
- Conduct competitive bid process to determine best value

### 4.7.1 Subcontractor Management

Our primary inspection subcontractor performing work on site reports to the Site Manager for all work tasking and performance. Willbros incorporates all subcontractors into our inspection process and schedules, and Environmental, Safety and Health (ESH) requirements. The Site Manager conducts daily inspections of subcontracted work. We monitor the schedule to ensure the work meets the agreed upon timelines and we keep the Program Manager informed on the status of subcontracted work during our scheduling meetings.

We will inform the Contracting Officer of any potential subcontractor performance issues in an expeditious manner in order to minimize any impact on the Navy. We will communicate with the subcontractor directly concerning any inspection and acceptance issues. This provides open communication and clear lines of authority during the subcontract management process, and minimizes critical issues that might otherwise result in poor subcontractor performance.

When we use subcontractors, they are integrated into each project organization, and work directly for our Site Manager. They are responsible for work quality and performance levels the same as our own workforce. Work schedules, change orders, and quality of work for our entire organization is driven through our information management systems and enforced by our management team, regardless of what company is performing the work.

### 4.7.2 Subcontractor Coordination

Our subcontractors, as members of the Willbros team, maintain direct lines of communication within their own company's workforce at the working levels to promote interaction between disciplines. Willbros and subcontract personnel have direct access to each other through formal and informal discussions about project and contractual issues.

## 4.8 QUALITY ASSURANCE

The Willbros Quality Assurance and Control System focuses on building quality into every project, not just inspecting it in the end. We implement and consistently administer the QA/QC system on all projects by controlling the factors that directly influence a task order — people, materials, and processes.

Our quality system is developed from EP 715-1-2, A Guide to Effective Contractor Quality Control. It is a proven Corps of Engineers (USACE) quality system that focuses on our personnel instituting controls and performing regular and frequent inspections of work performed by in-house personnel, subcontractors, and suppliers.





## Willbros Government Services, LLC – Project Execution Work Plan

---

It uses time-tested, three-phase control process assuring that we are adequately prepared to begin a phase of work, eliminate deficiencies, and follow through in accomplishing the work compliantly.

### 4.8.1 Quality Assurance and Control Responsibilities

Willbros philosophy is that quality is everyone's job. It starts with the craftsperson performing his work in a quality manner. His foreman, in turn, inspects his work. Our project manager, site managers, and field inspectors are all responsible for inspecting the work. By having several key skills in house and by ensuring that our QC personnel are multi-disciplined, we can ensure that qualified personnel conduct our inspections. However, to address specific needs for field QC inspection and quality workmanship, WGS has appointed our Site Manager as our Site QA/QC Manager. Our QA/QC Manager achieves quality and safety for this task order by properly training and monitoring performance of all site personnel for the duration of the work.

The QA/QC Manager has the responsibility to control construction quality and inspect the work. His specific responsibilities are:

- Implements and manages the QC program ensuring compliance with all NAVFAC, POL and API standards and conformance to all related industry practices on all project activities
- Conducts project QC meetings and coordination meetings with Government representatives
- Conducts, manages, and coordinates the three phases of control and documentation monitoring both in-house and subcontracted work activities in accordance with inspection program
- Manages and supervises field personnel to ensure quality workmanship, code and specification compliance.
- Prepares requisite reports, documentation, and supporting data
- Conducts trend analysis and root cause analysis to identify potential problems
- Approves all submittals and contract deliverables

### 4.8.2 Quality Control Methodology and Approach

A major component of our planned quality control activities is our site inspection plan. The QA/QC/HSE Manager schedules in-process inspections and tests utilizing a site inspection plan to ensure that all services and supplies conform to the project Statement of Work and contract requirements. The site inspection plan is designed to identify all definable features of the work that are to be provided to the Government. It identifies the method of measuring quality service and the frequency of in-process inspections.

### 4.8.3 Three Phases of Quality Control for In-Process Inspection

The three phases of control include each definable feature of work, preparatory, initial, and follow-up. They are the core of our construction quality management system. We employ these three phases of control on each project to ensure that work complies with the Statement of Work, specifications, and contract requirements.

### 4.8.4 Preparatory Phase

The preparatory phase is accomplished prior to the start of each definable feature of work and includes as a minimum:

- Review of applicable specifications for each definable feature of work
- Review of contract drawings and other contract requirements
- Verification that appropriate shop drawings and submittals have been submitted and approved, and that required test results have been received, when required
- Review testing plan to ensure that all QC tests are included
- Ensure that all preliminary work has been completed
- Inspect all required material, equipment and preliminary work to ensure that it is on-hand and complies with shop drawings and specifications
- Review the Safety Plan and Activity Hazard Analysis (AHA) to ensure that applicable safety requirements are met and Material Safety Data Sheets are on-hand for all hazardous chemical
- Discussion of construction methods
- Other items may be added to this list as appropriate to address delivery order unique areas.





#### **4.8.5 Initial Phase**

When construction crews are ready to start a definable phase of work, our QA/QC Manager accomplishes the initial phase observing the start of work to ensure that it complies with our work plan. The results of the initial phase are documented in the daily inspection report. The following is performed for each definable feature of work:

- Check preliminary work to verify full compliance
- Establish quality workmanship requirements
- Resolve any questions, conflicts, or differences
- Review Safety Plan including hazard analysis
- Ensure testing is performed

The initial phase is repeated for each new crew to work on site and when the acceptable level of specified quality is not attained.

#### **4.8.6 Follow-up Phase**

The follow-up phase is repeated daily for on-going work and more frequently if necessary until each definable feature of work is complete. Final follow-up checks are conducted by field personnel and all deficiencies are corrected prior to the start of additional features of work. The follow-up phase is documented in the daily inspection report and includes:

- Verifying that work is in compliance with the work plan and specifications
- Confirming that quality workmanship is maintained
- Validating that testing is performed as necessary
- Ensuring that any rework items are corrected

#### **4.8.7 Methodology for Final Inspection**

At the completion of all work on the task order or on any increment established by a completion time specified, the QA/QC Manager conducts a pre-final inspection of the work and develops a punch list of any items that do not conform to the work plans and specifications. This list is included in the quality control documentation and includes the estimated date by which the deficiencies will be corrected. Pre-final inspections eliminate punch list items before final inspection.

After the punch list deficiencies are corrected (if any), the QA/QC Manager makes a second completion inspection to check that all of the punch list deficiencies. This final inspection and any deficiency corrections required by this inspection are finished within the time stated for completion of the entire work or for any specified increment if the project is divided into increments by separate completion dates.

The QA/QC/HSE Manager schedules final inspections with the Government Inspector and end user as necessary a minimum of two workdays in advance. As part of our final inspection, we obtain all applicable warranties from subcontractors, manufacturers, vendors, and suppliers. After final acceptance of the work, Inspectors attach an Equipment Warranty Sticker thereon. This sticker for equipment states:

- Manufacturer
- Serial number
- Model number
- Contract number
- Contract name
- Date the contractor's warranty expires
- Date the manufacturer's warranty expires

The QA/QC/HSE Manager maintains a record of all warranties and guarantees for the life of the contract and takes appropriate action to assist the Government in obtaining warranty service before the period expires if needed.

#### **4.8.8 Testing**

All Quality control testing is performed in accordance with American Society for Testing and Materials (ASTM), EM standards, codes and industry standards. We perform specified tests as required to ensure that





control measures are adequate to provide a product that conforms to contract requirements. Testing is in accordance with the contract documents and conforms to the following standards:

- ASTM standards
- DOD/NAVFAC specifications
- American Petroleum Institute (API) standards
- American Association of State Highway and Transportation Officials (AASHTO) standards
- American Welding Society (AWS) standards
- American Society of Mechanical Engineers (ASME) publications

**4.8.8.1 The types of tests include but are not limited to the following:**

- Pressure test
- Leak or vacuum box testing
- Dye Penetrant Testing
- Magnetic Particle Testing
- Ultrasonic Longitudinal
- Ultrasonic Shear Wave
- Ultrasonic B-Scan
- Magnetic Flux Leakage
- Eddy Current and Electromagnetic Testing
- X-Rays or Radiographic
- Hardness Testing
- Materials classification
- Anchor Profiles
- Humidity and Dew Point Controls
- Dry or wet film thickness testing

**4.8.9 The QA/QC Manager performs the following activities and provides the following data:**

- Prepares a Testing Plan and Log
- Verifies that testing procedures comply with the contract requirements (the specifications may establish the minimum testing requirements. The Company may increase test frequency or provide additional tests as necessary to ensure compliance of work performed)
- Verifies laboratory facilities and procedures. All laboratories meet the criteria and accreditation specifications of the Government's solicitation.
- Checks test equipment calibration data against certified standards
- Verifies that recording forms, including all of the test documentation requirements, have been prepared
- Verifies that test documents report the expected test results and actual test results for each test or phase
- Attaches a copy of the updated Testing Plan and Log to the last daily Contractor Quality Control Report

Our QA/QC Manager uses the Contractor Test Report format to report all necessary data and document test results. He distributes test results on the work day following the completion of each test.

**4.8.10 Quality Documentation and Resolution of Deficiencies**

Documentation is the key element for developing, recording, analyzing, and monitoring the quality control program. At our site office, the quality records are established and inspected for validity and accountability. Government-published forms, logs, and records are utilized when appropriate. All quality control inspections are documented, and files are maintained to identify trends.

Our Construction Quality Management (CQM) Documentation System is founded on interrelated elements that collectively form the entire structure. The QA/QC Manager maintains current records of quality control activities, operations, inspections, and tests, including subcontractors and suppliers. All records documenting





## Willbros Government Services, LLC – Project Execution Work Plan

---

our delivery order activities are preserved for the duration of the contract and then archived as required. All QA/QC documents and records are available for review by the Contracting Officer on request. Documentation includes QC reports and logs, equipment calibration records, drawings, and associated documents concerning submittals and materials that require inspection.

### **4.8.11 Reports/Records**

All quality control records are retained for the duration of the contract in our program management office. This record file is for contractor management use and is available to the Government on request. The QA/QC Manager is responsible for setting up and maintaining current records of the day-to-day quality control operations, activities, and tests performed, including the work of suppliers and subcontractors.

### **4.8.12 Weekly Production Report**

The Production Report is produced for each week that work is performed. It is normally limited and includes field photos. The report is informal and may consist of hand written notes on a standard form. The report will account for each calendar day while on-site.

The reporting of work will be identified by terminology consistent with the statement of work. Production Reports will be prepared and dated by the WGS on-site Project Engineering and contain the following information:

- Date of report, report number, name of contractor, Delivery Order Number, title and location of tasks, and construction manager present.
- Weather conditions in the morning and in the afternoon. Include temperature, wind, rain, fog, and humidity for construction work involving concrete placement.
- A list of contractor and subcontractor personnel on the work site, their trades, employer, work location, descriptions of work performed, and hours worked.
- A list of contractor and subcontractor equipment on the work site, rented or owned, if rented - from who, location, description of work performed with equipment, and hours the equipment was on-site, used, idle, and/or down for repair.
- A list of job safety action taken and safety inspection and safety inspections conducted. Indicate that safety requirements have been met including the results of the following:
- Was a job safety meeting held? (If YES, submit a copy of the meeting minutes with final project submittals.)
- Were there any lost time accidents? (If YES, attach a copy of the completed OSHA report and submit with final project submittals.)

### **4.8.13 Deficiency Reporting**

Our deficiency report documents discrepancies in supplies, materials, and workmanship. The report includes a summary of all corrective actions taken. Summary data is reported to the Project Manager on the Contractor Quality Control Report. A closed loop process is used for all quality control inspections and handling deficiencies. The QA/QC Manager is accountable to follow up on any noted discrepancy with a corrective action plan to mitigate or minimize the deficiency and to prevent recurrence.

### **4.8.14 Task Order Close-out Procedures**

As part of our contract and task order close-out procedures, we have developed checklists that are used to ensure the smooth transition of completed work to the new users as well as accurate, final documentation to the Contracting Officer, COTR, and/other designated representatives. Our task order close-out checklists include the following items to include in the task order/contract turnover procedures:

- All as-built/record drawings related to the work
- All operations and maintenance manuals and/or media
- Manufacturer's warranty information and points of contact for all installed equipment, systems, etc.





#### 4.9 REPAIRS

Tank repairs are not covered under the initial contract SOW or as a part of the original scope of work for this project. After the inspection is completed a preliminary report will be submitted to NAVFAC ESC for their review. The final inspection report and recommendations will be submitted to NAVFAC ESC for review and approval of items which are to be repaired, modified or replaced. All repairs will be executed under a contract modification. All repair activities and task will be identified and listed on the project schedule. The schedule will be updated to incorporate the repair task, activities and additional time required to perform the repairs.

#### 4.10 DEMOBILIZATION

Demobilization and staging of equipment and tools will be an on-going process as various stages of the work are completed to mitigate work site congestion. Upon completion of site operations, remaining site personnel, materials, temporary facilities, and equipment will be demobilized from the site. The final demobilization will not occur until NAVFAC ESC personnel approve all site work and conduct a final inspection.

Willbros will conduct a final inspection and walk through with NAVFAC ESC and FISC Pearl Harbor personnel. The findings will be included in the Project Construction Certification Report.

#### 5.0 KEY PERSONNEL AND SUBCONTRACTORS

Willbros personnel project personnel are listed below. Each person meets or exceeds all the minimum qualifications required by the SOW. Willbros key person has extensive experience in the POL industry, design and construction of fuel piping, knowledge and experience in tanks cleaning, inspection, repairs, and strapping. The Table 5-1 demonstrates that our personnel meet or exceed the minimum qualifications for this task order.

KEY PERSONNEL POSITION	PERSONNEL NAME	QUALIFICATIONS
Project Manager / API 653 Inspector	Tim Anderson	<ul style="list-style-type: none"> <li>▪ B.S., Mechanical Engineering</li> <li>▪ API 653 Cert - #494 Tank Inspector</li> <li>▪ API 570 Cert - #1080 Piping Inspector</li> <li>▪ API 510 Cert - #5034 Pressure Vessel Inspector</li> <li>▪ AWS CWI Welding Inspector</li> <li>▪ ASNT Level II – UT, MT, PT, RT, VT, LT</li> <li>▪ 23 years POL facilities experience including work in remote Syrian and Omani deserts</li> <li>▪ 23 years industry experience</li> <li>▪ DOT Registered Tank Inspector / Engineer</li> </ul>
Project Engineer	Gene Humes, P.E.	<ul style="list-style-type: none"> <li>▪ M.S., Civil Engineering</li> <li>▪ 35 years engineering and construction of piping systems experience</li> <li>▪ Professional Engineer - #10844</li> </ul>
Site Manager / Field Superintendent	Reed Cavin	<ul style="list-style-type: none"> <li>▪ 7 years POL Facilities and Industrial Construction and Maintenance experience</li> <li>▪ SPCC C-7 Certification</li> <li>▪ Hazardous Waste/Confined Space/Lead/Scaffolding/Operator Certified.</li> </ul>





		<ul style="list-style-type: none"> <li>▪ Construction and Site Superintendent at Redhill – Completing 6 tank projects</li> <li>▪ Experience in the coordination of multiple personnel and subcontractors performing in limited areas.</li> </ul>
Tanks - Subject Matter Expert	Doug Bayles, P.E.	<ul style="list-style-type: none"> <li>▪ Professional Engineer - #11288-C HI</li> <li>▪ Professional Engineer – Reg. 47 States</li> <li>▪ API 653 Cert - #1904 Tank Inspector</li> <li>▪ API Committee Member</li> <li>▪ 20 years POL Facilities and Industrial Construction and Maintenance experience</li> </ul>
<b>Other Significant Personnel Involved:</b>		
API 653 Inspector	Kenneth McNamara (Additional Inspection Support as Needed)	<ul style="list-style-type: none"> <li>▪ 12 years experience inspections in the POL industry including work in remote areas</li> <li>▪ 2 Years Inspecting Tanks in Red Hill Facility for FISC, Pearl Harbor</li> <li>▪ API 570 Piping Inspector</li> <li>▪ API 653 Aboveground Storage Tank Inspector</li> <li>▪ API 510 Pressure Vessel Inspector</li> </ul>

**Table 5-1. Key Personnel Qualifications**

The above table summarizes the personnel experience, qualifications and certifications; see Appendix G for detailed resumes for each person.

## 6.0 TECHNOLOGIES, MATERIALS AND EQUIPMENT

### 6.1 TECHNOLOGIES AND EQUIPMENT

Willbros in conjunction with Testex and subcontractors will utilize the most modern technologies available and proven instruments to perform equipment, STI or API 653 inspection and Non-Destructive Examinations. Some of the technologies to be utilized, but are not limited to, are as follow:

- A TesTex - BFET Hawkeye low voltage remote eddy current scanner to detect surface cracks in metal plates or weld toes. A small handheld unit is used on hard to reach places.
- A TesTex - LFET Falcon 2000 Mark II low voltage remote eddy current scanner to detect back side corrosion or surface cracks in metal plates. A small handheld unit is used on hard to reach places.
- Krautkramer DMS 2 Ultrasonic thickness meters to determine metal thickness. These meters are of the latest technology displaying both a thickness reading for the metal but also a second reading of the coating thickness when measuring through paint. All measurements are electronically stored and down loaded into the API-653 Report Program. All minimum required thicknesses, corrosion rates, tank safe fill heights and tank life before required repairs are necessary.
- Krautkramer USN-60 Ultrasonic longitudinal and shearwave test equipment used to determine or evaluate metal thickness. These test equipment are of the latest technology longitudinal and shearwave test equipment for evaluating material flaws in metal plates and thickness testing. The equipment can be set up for displaying both a thickness reading for the metal but also a second reading of the coating thickness when measuring through paint.
- Shell settlement, edge settlement and bottom levelness measurements are taken using a high accuracy HILTI Laser Transit. All results are entered into a computerized program and evaluated in accordance with API-653 Appendix B.
- A Partlow MRC 5000 pressure/temperature transmitter and chart recorder is used for conducting pipeline pressure testing in accordance with API-1110. It reads and records in 0.1 psi increments.





## Willbros Government Services, LLC – Project Execution Work Plan

---

- Thorpe pit gauges when measuring pitting on tank bottoms, shells and roofs. Also when evaluating pitting and corrosion on piping during an API-510/570/653 evaluation.
- PHD.LITE atmosphere testing equipment
- MFE Enterprises' 2412 permanent magnet system floor scanners for detecting backside corrosion on carbon steel plates. (Available alternate resource)
- A Silver Wing dry transducer type magnetic tank crawler to obtain continuous readings of thickness on the tank shell at heights of up to 75 feet. (Especially good when inspecting underground UST or cut & cover tanks) (Available alternate resource)

Our inspectors are certified on the operation and testing on all the equipment per manufacturer's guidelines, ASNT SNT-TC1A Level II, and the requirements specified in specifications, ASME Section V, API or other any applicable codes.

Other technologies that may be utilized include:

- Arc Welding
- Hydraulic / Pneumatic / Electric Boom System and/or Guyless Derricks – These are a simple crane and/or boom system which is connected to a center column or structure. Guyless Derricks are commonly used in the tank industry in the construction of storage tanks. WGS personnel have extensive training and experience in the various methodologies and techniques in the construction of field erect storage tanks and structures. WGS will mount two boom systems or guyless derricks to the center structure of the specified tank which is out of service. The two boom systems or or guyless derricks will provide a more efficient utilization of manpower and an additional back up system for safety.
- NDT VT Non-destructive testing Visual Examination.
- NDT MT Non-destructive testing Magnetic Particle Inspection, Dry Powder.
- NDT LT Vacuum Box Leak Testing of conventional Bottom Corner or Lap Joint Welds.

### **7.0 HAZARDOUS WASTE DISPOSAL**

#### **7.1 HAZARDOUS WASTE MATERIALS OR PRODUCTS**

Willbros has developed a detailed waste disposal and treatment plan (WDP) to address all hazardous waste on this task order.

#### **7.2 HAZARDOUS WASTE DISPOSAL**

All Federal, State, and local hazardous waste regulations shall be complied with for all material disposal. Please refer to the WDP and EPP for additional documentation.

### **8.0 PROJECT REPORTING AND DOCUMENTATION**

Project reporting and documentation will be provided to the Government during or final documentation following the completion of the field activities.

#### **8.1 REPORTING REQUIREMENTS**

Willbros SM will provide daily Quality Control Reports together with the Daily Progress Reports. All reports will be included in the Final Report. Daily reports will be submitted to NAVFAC ESC daily or upon request.





## **8.2 MEETING MINUTES**

Willbros will attend meetings, as requested by the NTR, to discuss technical or regulatory issues, and project progress and status. Willbros will prepare presentation materials, as requested by the NTR, prior to the subject meeting.

## **8.3 DIGITAL IMAGING**

A photo permit will be applied for to permit the use of digital images to be taken during the course of the work. Digital imaging will be provided with the Final Report.

## **8.4 DOCUMENTATION**

Field activities will be documented on a daily basis in the SM field logbook for the project. The following items will be noted in the field logbook:

- Name/initials of the Site Manager
- Date, time, and location of activity/action
- Encountered problems and resolutions
- Health and Safety information (i.e. weather conditions, potential hazards)
- Other appropriate information

Subcontractor activities will also be recorded, and subcontractor daily logs will be provided to Willbros for backup. The daily logs and reports will be maintained in a filing system established for the project and shall also be provided to the government, as requested.

## **8.5 PROJECT CONSTRUCTION COMPLETION CERTIFICATE**

At the completion of field activities, a Construction Completion Certification Report documenting site activities and data generated will be prepared for review and approval. The Construction Completion Certification Report shall include all permits, NDE results, vendor purchased equipment certification (to include serial and model number), operation and maintenance manuals (if required), daily quality control (QC) and progress reports, and as-built drawings. The Construction Completion Certification Report will also include an electronic version of the as-built drawings.





**APPENDIX A**

**PROJECT SPECIFICATIONS**





## PROJECT SPECIFICATIONS – 54118 REDHILL TANK COMPLEX

WGS has reviewed the project SOW and listed the applicable requirements for reference and utilization in the development of the execution and work plan to ensure compliance with all relevant regulations, project requirements including the following codes and specifications:

**a. American Petroleum Institute (API)**

- i. API Recommended Practice 574, *Inspection Practices for Piping System Components*, Latest Edition.
- ii. API Recommended Practice 575, *Inspection of Atmospheric and Low-Pressure Storage Tanks*, Latest Edition.
- iii. API Standard 650, *Welded Steel Tanks for Oil Storage*, Latest Edition.
- iv. API Recommended Practice 651, *Cathodic Protection of Aboveground Petroleum Storage Tanks*, Latest Edition.
- v. API Recommended Practice 652, *Lining of Aboveground Petroleum Storage Tanks*, Latest Edition.
- vi. API Standard 653, *Tank Inspection, Repair, Alteration and Reconstruction*, Latest Edition.
- vii. API/ANSI Standard 2015, *Requirements for Safe Entry and Cleaning of Petroleum Storage Tanks*
- viii. API/ANSI RP 2016 *Guidelines and Procedures for Entering and Cleaning Petroleum Storage Tanks*
- ix. API Standard 2550, *Measurement and Calibration of Upright Cylindrical Tanks*

**b. American Society of Mechanical Engineers (ASME)**

- i. ASME B31.3, *Process Piping*, Latest Edition.
- ii. ASME B31.4, *Pipeline Transportation Systems for Liquid Hydrocarbons and Other Liquids*, Latest Edition.
- iii. ASME IX.

**c. Code of Federal Regulations (CFR)**

- i. 29 CFR 1910, *Permit-Required Confined Spaces for General Industry*.
- ii. 40 CFR 112, *Oil Pollution Prevention*.

**d. Military Handbooks (MIL-HDBK)**

- i. MIL-HDBK 1022A, *Department of Defense Handbook: Petroleum Fuel Facilities*, 01 November 1999.
- ii. MIL-HDBK 201B, *Military Standardization Handbook: Petroleum Operations*.

**e. National Association of Corrosion Engineers (NACE)**

- i. NACE Recommended Practice, RP0184-97, *Repair of Lining Systems*.
- ii. NACE Recommended Practice, RP0193, *External Cathodic Protection of On-Grade Metallic Storage Tank Bottoms*.
- iii. NACE Recommended Practice, RP0288-94, *Inspection of Linings on Steel and Concrete*.

**f. National Fire Protection Association (NFPA)**

- i. NFPA-30, *Flammable and Combustible Liquids Code*.

**g. Steel Tank Institute (STI)**

- i. STI SP001, *Standard for the Inspection of Aboveground Storage Tanks*.

**h. Safety**

- i. EM 385-1-1, *U.S. Army Corps of Engineers Safety and Health Requirement, Appendix A Minimum Basic Outline for Accident Prevention, and sections*.





**i. Unified Facilities Criteria (UFC)**

- i. UFC 3-460-01, *Petroleum Fuel Facilities*.

**j. Unified Facilities Guide Specification (UFGS)**

- i. UFGS 09970, Epoxy/Fluoropolyurethane Interior Coating Of Welded Steel Petroleum Fuel Tank
- ii. UFGS 09971, Exterior Coating System for Welded Steel Petroleum Storage Tanks
- iii. UFGS 09973, Interior Coating System for Welded Steel Petroleum Storage Tanks
- iv. UFGS 01351, Safety, Health, and Emergency Response
- v. UFGS 13205, Steel Tanks with Fixed Roofs





## **APPENDIX B**

### **DETAILED PROJECT SCHEDULE**



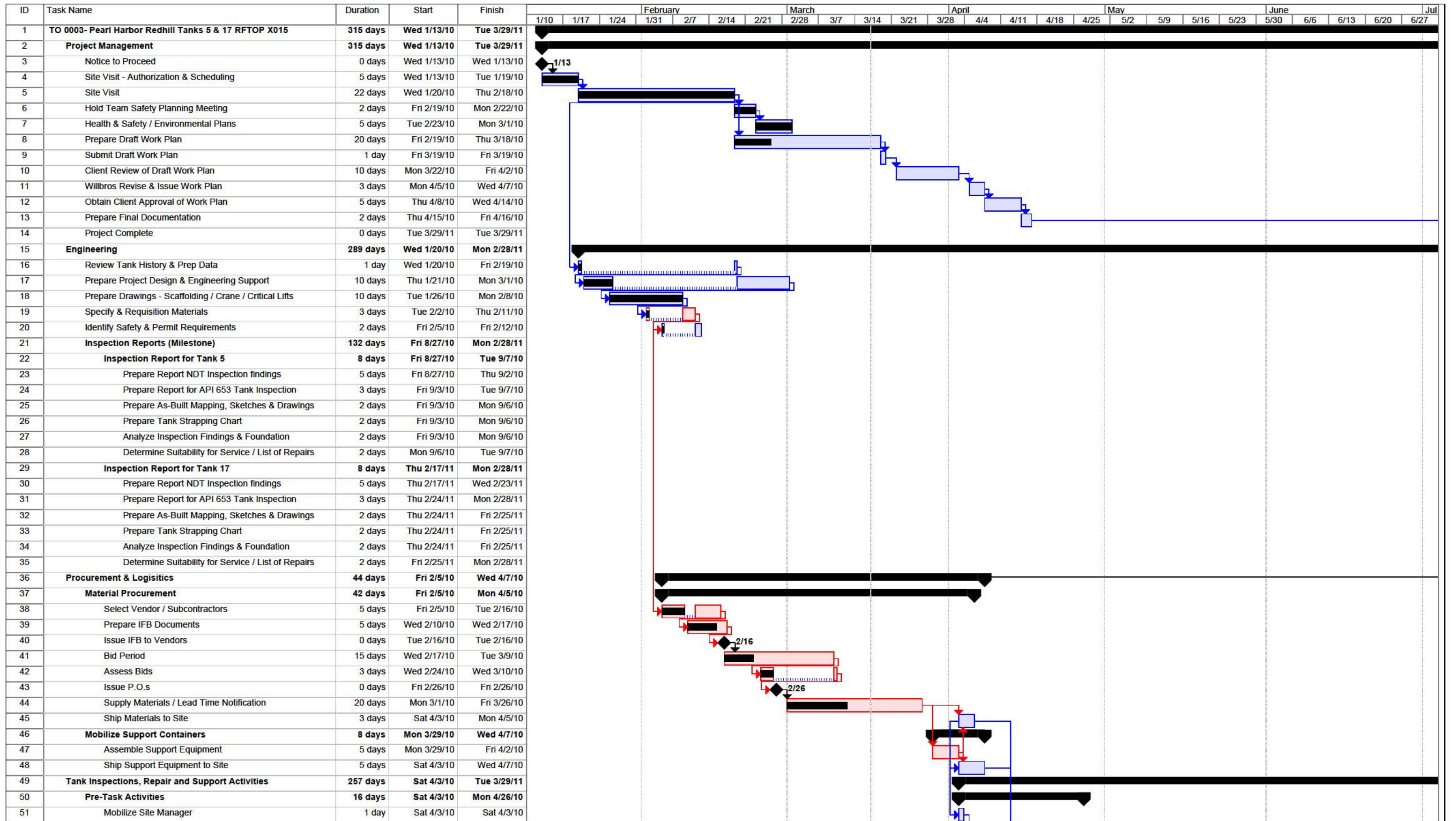

Project: T0003 - Redhill Tanks Rev0  
Date: Wed 3/17/10

Task		Split		Milestone		Project Summary		External Milestone	
Project Guide: Critical Task		Progress		Summary		External Tasks		Deadline	











ID	Task Name	Duration	Start	Finish	February				March				April				May				June				Jul		
					1/10	1/17	1/24	1/31	2/7	2/14	2/21	2/28	3/7	3/14	3/21	3/28	4/4	4/11	4/18	4/25	5/2	5/9	5/16	5/23	5/30	6/6	6/13
154	<b>Catwalk &amp; Structure - Inspection &amp; Repairs</b>	<b>7 days</b>	<b>Wed 11/10/10</b>	<b>Thu 11/18/10</b>																							
155	Obtain Daily Confined Space Entry Permit / Safety M	1 day	Wed 11/10/10	Wed 11/10/10																							
156	Gas Test - Part of Confined Space / Hot Work Permit	1 day	Wed 11/10/10	Wed 11/10/10																							
157	Install Temporary Lighting and Safety Cabling	2 days	Thu 11/11/10	Fri 11/12/10																							
158	Inspect Catwalk and Handrails	1 day	Mon 11/15/10	Mon 11/15/10																							
159	Submit List of Identified Items for NAVFAC Approval	1 day	Tue 11/16/10	Tue 11/16/10																							
160	Repair Catwalk Defecencies & Replace Missing Bolts	1 day	Tue 11/16/10	Tue 11/16/10																							
161	Install Scaffolding For Tower Access	2 days	Tue 11/16/10	Wed 11/17/10																							
162	Inspect Tower & Crane Structure	2 days	Tue 11/16/10	Wed 11/17/10																							
163	Submit List of Identified Items for NAVFAC Approval	1 day	Thu 11/18/10	Thu 11/18/10																							
164	Repair Tower & Crane Structure	0 days	Thu 11/18/10	Thu 11/18/10																							
165	<b>Tank Access Preparation</b>	<b>7 days</b>	<b>Tue 12/7/10</b>	<b>Wed 12/15/10</b>																							
166	Install Temporary Lighting and Safety Cabling	1 day	Tue 12/7/10	Tue 12/7/10																							
167	Install Crane Boom & Lift Equipment	6 days	Wed 12/8/10	Wed 12/15/10																							
168	Install Add'l Scaffolding - In Areas Not Accessible b	1 day	Wed 12/8/10	Wed 12/8/10																							
169	Remove Interferences	1 day	Thu 12/9/10	Thu 12/9/10																							
170	<b>Pipe Testing</b>	<b>14 days</b>	<b>Fri 11/12/10</b>	<b>Wed 12/1/10</b>																							
171	Set Up Test Equipment	1 day	Fri 11/12/10	Fri 11/12/10																							
172	Hydro Test Lower Piping Section	12 days	Mon 11/15/10	Tue 11/30/10																							
173	Remove Test Equipment	1 day	Wed 12/1/10	Wed 12/1/10																							
174	Issue Pressure Test Report to NAVFAC	1 day	Wed 12/1/10	Wed 12/1/10																							
175	<b>Tank - Nondestructive Testing &amp; API 653 Inspection</b>	<b>45 days</b>	<b>Thu 12/16/10</b>	<b>Wed 2/16/11</b>																							
176	Nondestructive Testing - Upper & Lower Domes/Shel	40 days	Thu 12/16/10	Wed 2/9/11																							
177	API 653 Inspection- Upper & Lower Domes/Shell Scc	5 days	Thu 2/10/11	Wed 2/16/11																							
178	API 653 Inspection- Nozzles & Manways	2 days	Thu 2/3/11	Fri 2/4/11																							
179	API 653 Inspection- Appurtenances	2 days	Mon 2/7/11	Tue 2/8/11																							
180	API 653 Inspection- Coatings	1 day	Wed 2/9/11	Wed 2/9/11																							
181	<b>Perform Tank Strapping</b>	<b>5 days</b>	<b>Thu 2/17/11</b>	<b>Wed 2/23/11</b>																							
182	Measurements Required for Gauging Calibrations	5 days	Thu 2/17/11	Wed 2/23/11																							
183	Submit Measurements Charting to Engineering	0 days	Thu 2/17/11	Thu 2/17/11																							
184	<b>Tank Repairs</b>	<b>0 days</b>	<b>Wed 2/23/11</b>	<b>Wed 2/23/11</b>																							
185	Issue Preliminary Inspection Report	0 days	Wed 2/23/11	Wed 2/23/11																							
186	Issue Preliminary Repair Recommendations	0 days	Wed 2/23/11	Wed 2/23/11																							
187	NAVFAC Review & Approval of Repair Recommenda	0 days	Wed 2/23/11	Wed 2/23/11																							
188	<b>Return Tank to Service</b>	<b>125 days</b>	<b>Wed 10/6/10</b>	<b>Tue 3/29/11</b>																							
189	Remove Lift Equipment from Tanks	5 days	Thu 2/24/11	Wed 3/2/11																							
190	Remove Scaffolding For Tower Access	1 day	Thu 3/3/11	Thu 3/3/11																							
191	Remove Tools, Lighting & Safety Devices from Tanks	1 day	Thu 3/3/11	Thu 3/3/11																							
192	Remove Blinds & Fitting Protections	2 days	Fri 3/4/11	Mon 3/7/11																							
193	Reinstall Manways & Vent Spools	2 days	Tue 3/8/11	Wed 3/9/11																							
194	Reinstall Lower Piping Spools & Motor Valves	12 days	Thu 3/10/11	Fri 3/25/11																							
195	Inspect Tanks using Inspection Checklist	1 day	Mon 3/28/11	Mon 3/28/11																							
196	Inform Operations of Tank Readiness	1 day	Tue 3/29/11	Tue 3/29/11																							
197	Remove Locks & Chains from Tank Valves	1 day	Tue 3/29/11	Tue 3/29/11																							
198	Start Tank Filling Procedures Slowly	1 day	Tue 3/29/11	Tue 3/29/11																							
199	Monitor Tanks for Leaks	1 day	Tue 3/29/11	Tue 3/29/11																							
200	Check All Tank Appurtenances	1 day	Tue 3/29/11	Tue 3/29/11																							
201	Begin Normal Tank Operations (Milestone)	0 days	Tue 3/29/11	Tue 3/29/11																							
202	<b>Equipment Maintenance</b>	<b>120 days</b>	<b>Wed 10/6/10</b>	<b>Tue 3/22/11</b>																							
203	Inspect and Maintenance Equipment - Ongoing	120 days	Wed 10/6/10	Tue 3/22/11																							

Project: T0003 - Redhill Tanks Rev0  
Date: Wed 3/17/10

Task  Split  Milestone  Project Summary  External Milestone 

Project Guide: Critical Task  Progress  Summary  External Tasks  Deadline 





Project: T0003 - Redhill Tanks Rev0  
 Date: Wed 3/17/10

Task		Split		Milestone		Project Summary		External Milestone	
Project Guide: Critical Task		Progress		Summary		External Tasks		Deadline	



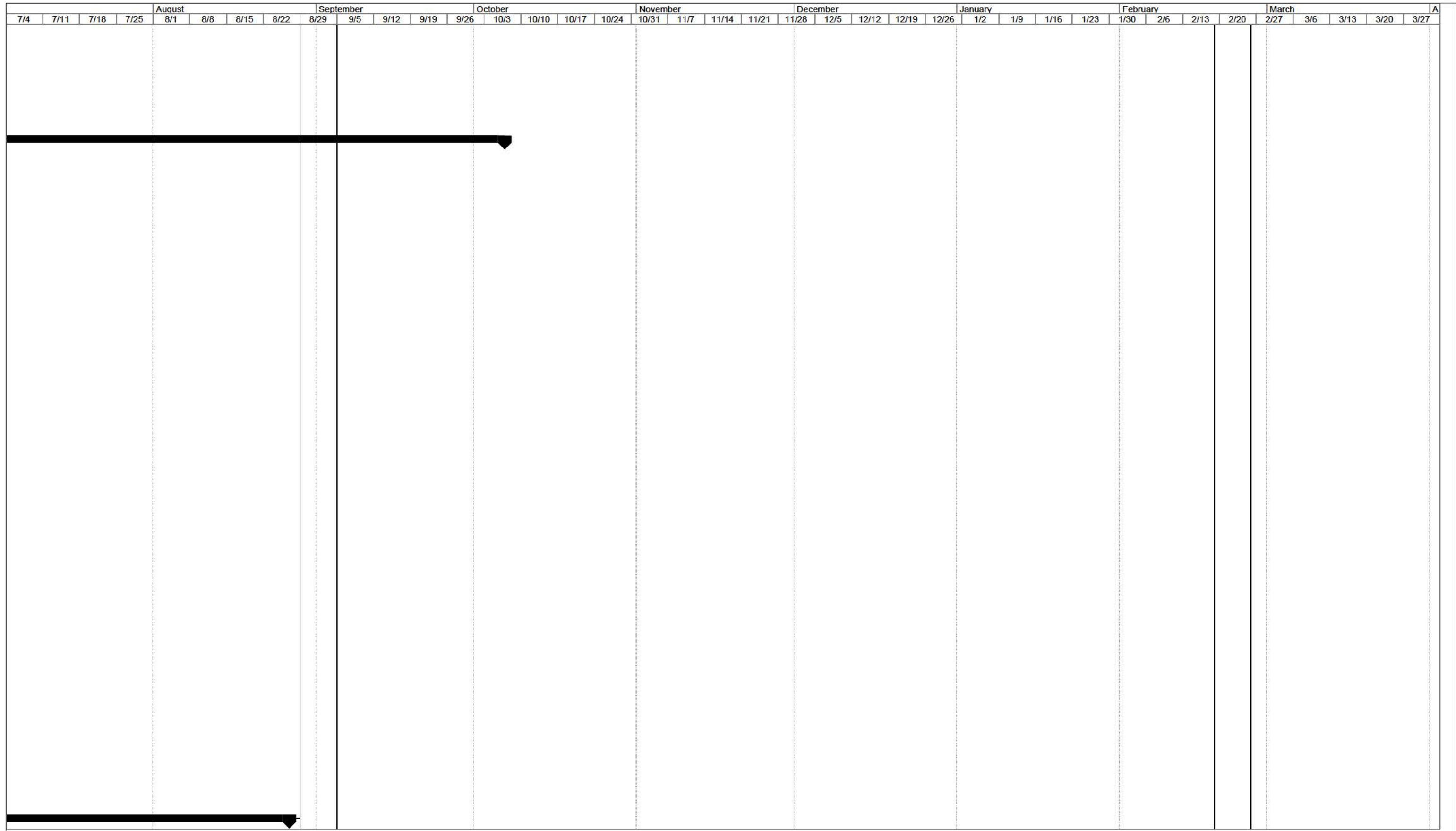

Project: T0003 - Redhill Tanks Rev0  
Date: Wed 3/17/10

Task		Split		Milestone		Project Summary		External Milestone	
Project Guide: Critical Task		Progress		Summary		External Tasks		Deadline	



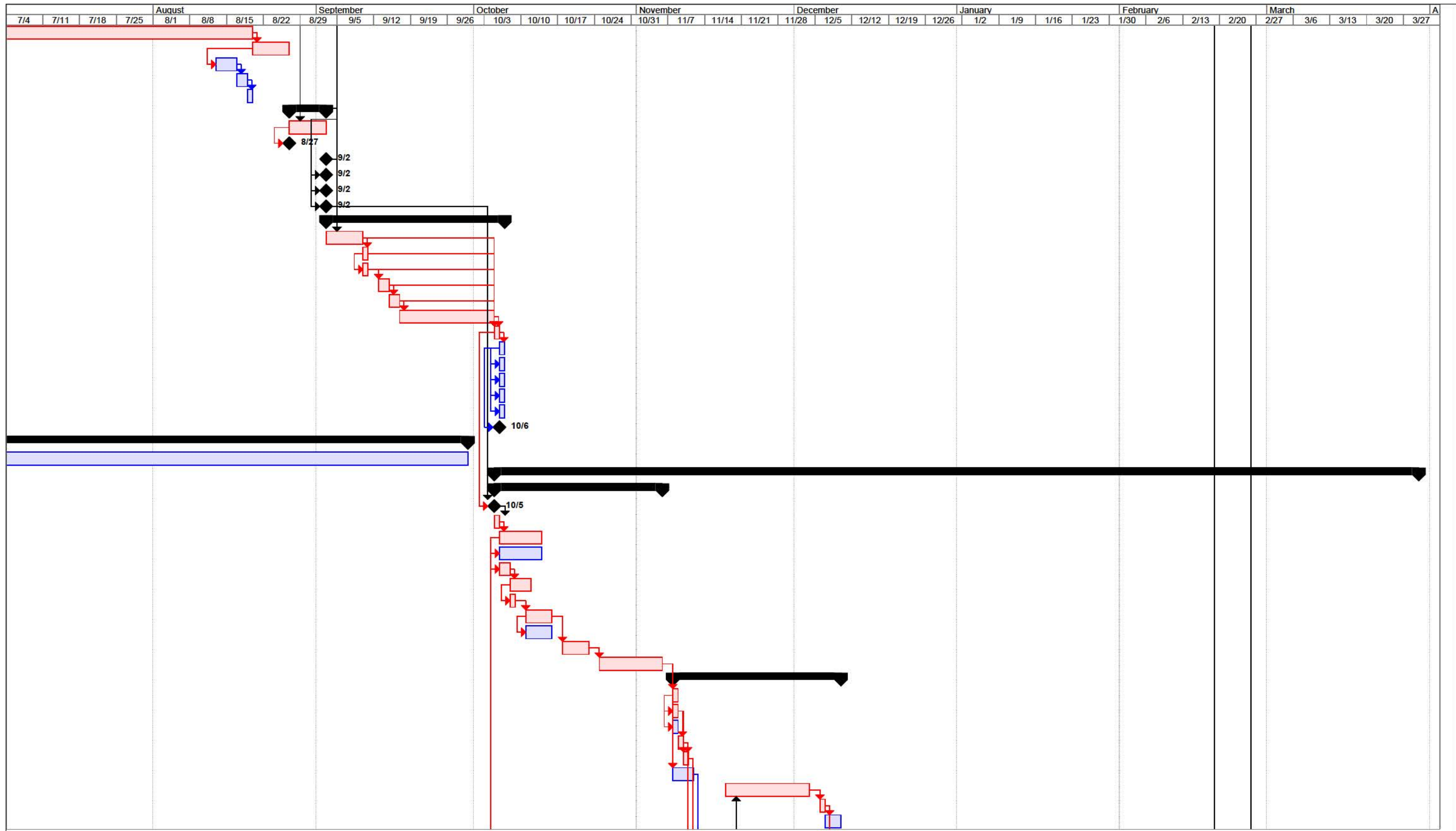

Project: T0003 - Redhill Tanks Rev0  
 Date: Wed 3/17/10

Task		Split		Milestone		Project Summary		External Milestone	
Project Guide: Critical Task		Progress		Summary		External Tasks		Deadline	

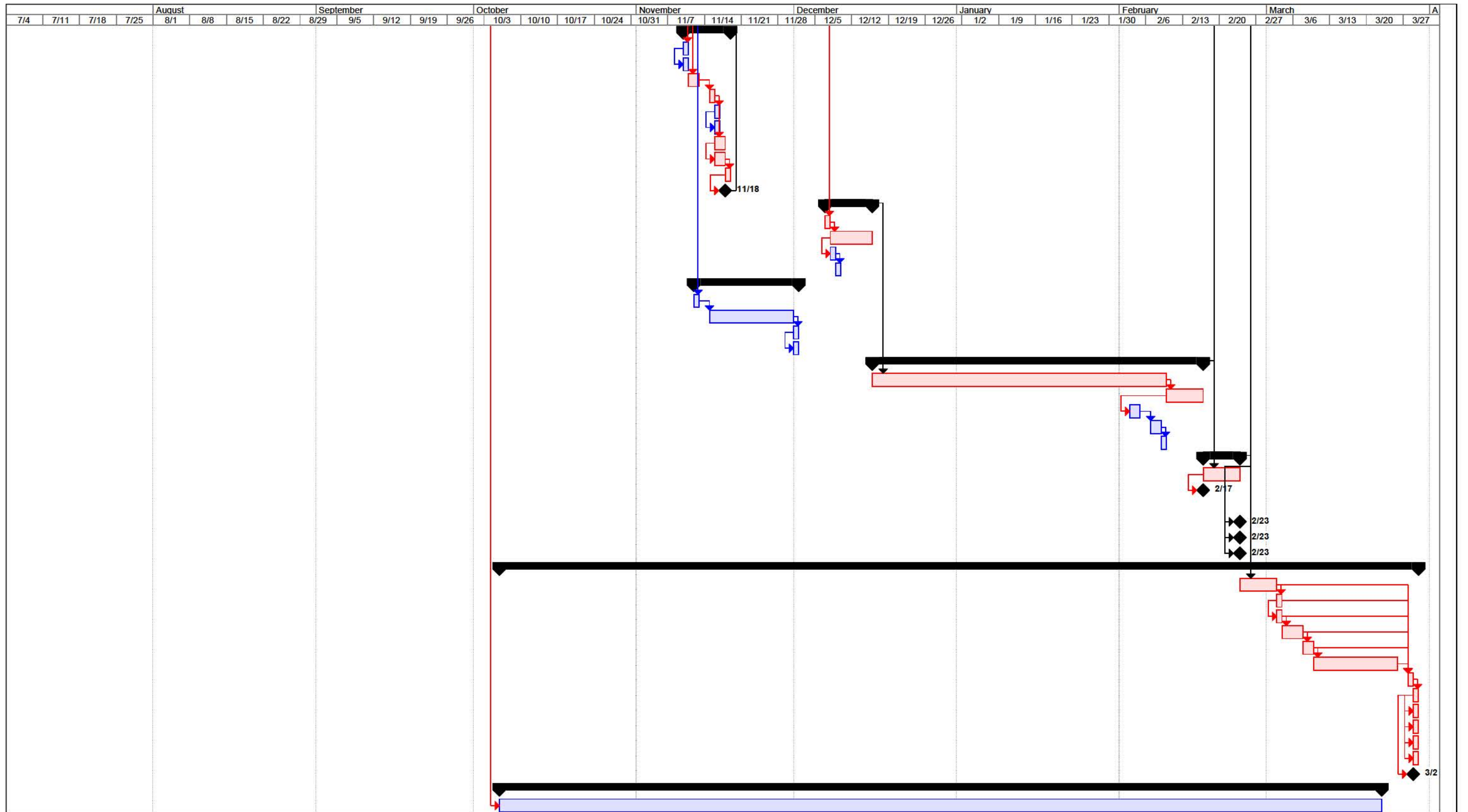

Project: T0003 - Redhill Tanks Rev0  
Date: Wed 3/17/10

Task  Split  
Project Guide: Critical Task  Progress

 Milestone  
 Summary

 Project Summary  
 External Tasks

 External Milestone  
 Deadline







**APPENDIX C**

**DETAILED PROJECT DRAWINGS**









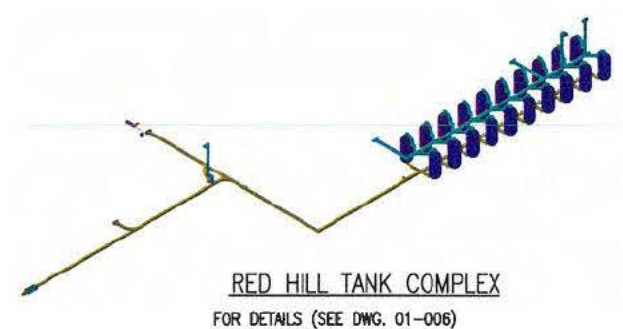
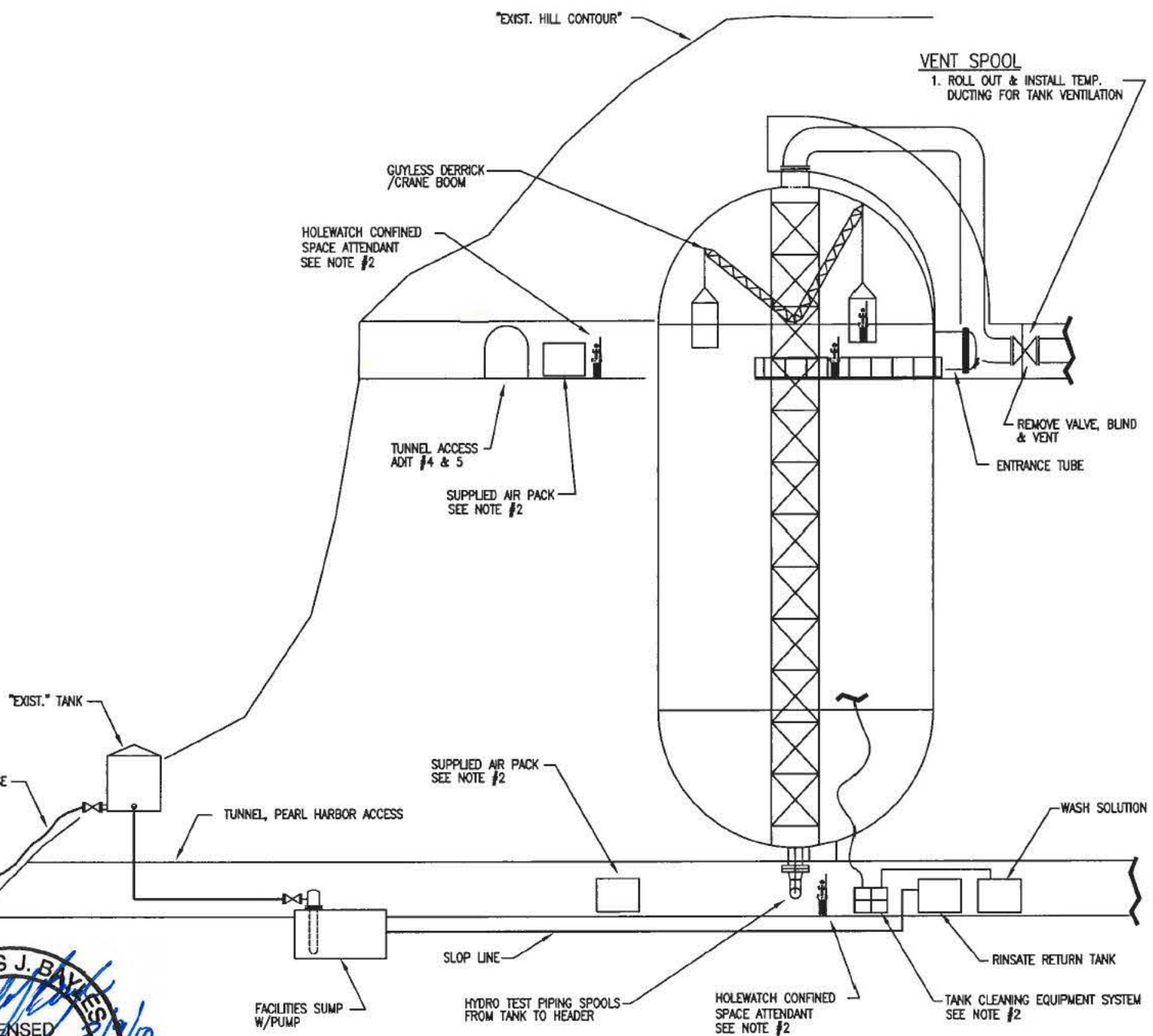
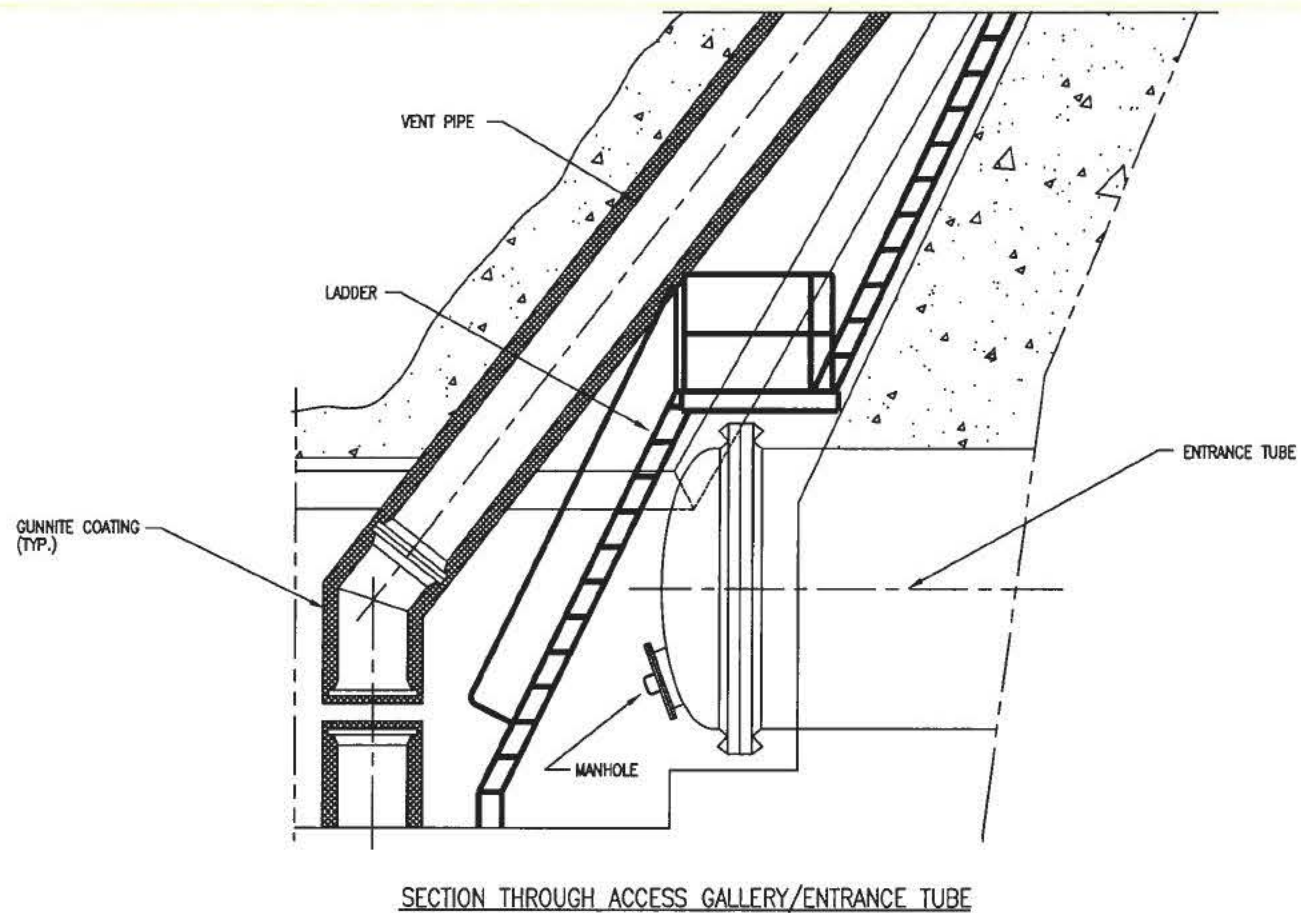

NOTE:  
 1. ACCESS THRU TUNNEL BY NAVFAC TRAIN OR WGS EQUIPMENT.  
 2. EQUIPMENT AND PERSONNEL MAY BE STAGED ON UPPER OR LOWER LEVELS.



**NOT FOR CONSTRUCTION**

**ISSUED FOR APPROVAL**  
 9-MAR-10

REFERENCE	NUMBER	NO.	DATE	REVISION	BY	CHK	APPR	APPR	APPR	CONSTRUCTION	LAST DATE	REV.
										CONSTRUCTION		
										BIDS		
										APPROVAL		
										INFORMATION		
										ISSUED FOR:	SIGNATURE:	DATE:
										DRAWN:	LJM	DATE: 11/20/09
										CHECKED:		DATE:
										ENGINEER:	TDA	DATE:
										W.E.I.:		DATE:
										CLIENT:		DATE:
										CLIENT:		DATE:
		B	3/9/10	REVISED, RESUBMITTED FOR APPROVAL								
		A	11/20/09	ISSUED FOR PROPOSAL	LJM	GH						

WILLBROS GOVERNMENT SERVICES (U.S.), LLC

**PEARL NAVAL BASE-REDHILL COMPLEX  
 TANK EQUIPMENT STAGING DETAILS  
 PEARL HARBOR, HI**

SCALE	PROJECT NO.	DRAWING NO.	SHEET	REV.
NOTED	54118	01-005	1 OF 1	B





















## **APPENDIX D**

### **PROJECT PROCEDURES – TANK CLEANING & DECONTAMINATION**





Willbros Government Services, LLC – Site Operations & Procedures  
**HEALTH AND SAFETY PROCEDURES**

SUBJECT: <b>AIR MONITORING AND SAMPLING</b>					
REVISION 3	6/23/09	SOP #	SOP-1	PAGE	1 OF 7

**1.0 POLICY**

Air monitoring will be conducted on all projects involving hazardous materials in order to determine the appropriate level of protection.

**2.0 PURPOSE**

The primary purpose of monitoring the air in the work environment is to determine employee exposure levels to airborne contaminants. However, air monitoring results and the proper maintenance of sampling records is important for several other reasons: 1.) to document the magnitude of employee exposures and identify fluctuations in contaminant concentrations caused by variations in production levels, job turnover, and weather; 2) to address employee concern/complaints; 3) to determine and/or document the effectiveness of control measures; and 4) to enhance worker training on chemical substances to which they MAY be exposed.

**3.0 REQUIREMENTS**

3.1 HS&E Safety/Compliance Manager

- a) Assure that monitoring is conducted for job locations with exposure potential.
- b) Evaluate job locations when changes occur in processes or chemicals.
- c) Audit and update this program as needed to assure a sound program.
- d) Ensure compliance with HASP & SSHEP.

3.2 Supervisor

- a) Assure that employees wear monitoring equipment properly.
- b) Assure that job locations with potential exposure are brought to the attention of the Safety/Compliance Manager.

3.3 Employee

- a) Properly wear monitoring equipment for the instructed time.
- b) Notify the Safety/Compliance manager or your supervisor of job locations for which monitoring SHOULD be conducted.

**4.0 DEFINITIONS**

ACGIH – American Conference of Governmental Industrial Hygenists; establishes Threshold Limit Values (TLV’s) for chemical substances.

AIHA – American Industrial Hygiene Association

Aerosols – Liquid droplets or solid particles dispersed in air that are of fine enough size (0.01 to 100 micrometers) to remain so dispersed for a period of time. Examples of aerosols are dust, mists, and fumes, which are finely dispersed particles in air.

Air – The mixture of gasses that surrounds the earth, its major components are nitrogen (78%), oxygen (21%), carbon dioxide (0.04%), and argon (0.96%).

Air monitoring – The sampling for and measurement of pollutants in the atmosphere.

Breathing Zone – An air sample collected in the breathing area (hemisphere forward of the shoulders with a radius from 6-9 inches) of a worker to asses his exposure to airborne contaminants.





Willbros Government Services, LLC – Site Operations & Procedures  
**HEALTH AND SAFETY PROCEDURES**

SUBJECT: <b>AIR MONITORING AND SAMPLING</b>					
REVISION 3	6/23/09	SOP #	SOP-1	PAGE	2 OF 7

Ceiling Limit (c) – The airborne concentration that SHOULD not be exceeded during any part of the working exposure. This limit is used with chemical substances that are acute health hazards and this instantaneous airborne concentration SHOULD not be exceeded.

Dusts – Solid particulates in air generated by crushing, cutting, grinding drilling, etc., organic or inorganic materials such as rock, metal, and wood.

Fumes – Minute solid particulates in air produced by the condensation of a molten metal; fumes are commonly associated with welding operations. Odorous gasses and vapors SHOULD not be called fumes.

Gas – A state of matter in which the material has very low density and viscosity; can expand and contract greatly in response to changes in temperature and pressure; and uniformly distributes itself through any container.

Liter Per Minute (lpm) – This is the flow rate usually expressed in liters per minute (lpm) which is set on the air sampling pump.

mg/m<sup>3</sup> – Milligrams per cubic meter; a unit of measurement used to describe airborne concentrations of aerosols (dusts, mists, fumes).

Mists – Suspended liquid droplets in air generated by condensation from the gaseous to the liquid state or by breaking up a liquid into dispersed state, such as by splashing, foaming or atomizing. Mists are formed when a finely divided liquid is suspended in air.

NIOSH – National Institute for Occupational Safety and Health. This institute conducts research on occupational hazards and recommends methods and standards for dealing with them.

Permissible Exposure Limit (PEL) – The PEL is the airborne concentration permitted for the substance which (PEL) MAY not be exceeded, often average over a period of 8 hours. The PEL is a legal limit enforced by OSHA.

Particulate – A particle of solid or liquid matter in air.

PPM – Parts Per Million; parts of vapor or gas per million parts of air (by volume).

Threshold Limit Value (TLV) – Established by the ACGIH, the TLV refers to an atmospheric concentration of a contaminant to which nearly all workers MAY be repeatedly exposed day after day, without adverse health effect. TLV's are not legal limits.

Time Weighted Average (TWA) – The average exposure level (atmospheric concentration of a contaminant) during a designated working period, usually eight hours. It can be calculated from either one sample or several consecutive samples collected from the breathing zone of the same employee.

Vapors – The gaseous form of substances which are normally in the solid or liquid state (at room temperature and pressure).



Willbros Government Services, LLC – Site Operations & Procedures  
**HEALTH AND SAFETY PROCEDURES**

<b>SUBJECT: AIR MONITORING AND SAMPLING</b>					
REVISION 3	6/23/09	SOP #	SOP-1	PAGE	3 OF 7

**5.0 GENERAL SAMPLING PROCEDURE**

- 5.1 Instruments available include Flame Ionization detectors, photoionization detectors (HNU or TIP), oxygen/LEL, hydrogen sulfide monitors, hydrogen cyanide monitors, carbon monoxide monitors, and colorimetric tubes.
- 5.2 Records of all direct reading monitoring will be kept on the form provided.
- 5.3 Personal samples will be collected to determine individual exposures per the site-safety plan or per guidance by the corporate health and safety manager. Samples will be logged on an air sample data and summary sheets log (see attachment A) and will follow laboratory chain-of-custody requirements.
- 5.4 Results will be posted on site or the individual sampled will be notified in writing.
- 5.5 Review the work area and be knowledgeable of the processes involved prior to sampling (identify the source of airborne contaminants, review Material Safety Data Sheets, interview supervisors, determine burning/scheduling rates).
- 5.6 Ensure all monitoring equipment is calibrated and documented in accordance to the manufacturers specification. More frequent calibration may be necessary and will be at the discretion of the compliance/safety manager.
- 5.7 Select the employee to be sampled and discuss the purpose of the sampling
- 5.8 Place the sampling equipment on the employee so that it does not interfere with work performance.
- 5.9 Attach the collection media (filter cassette, charcoal tubes, etc.) to the shirt collar to obtain a representative sample of the worker’s breathing zone. The collection media SHOULD always be in a downward vertical position to avoid contamination.
- 5.10 Prepare a “blank” sample during the sampling period for each type of sample collected.
- 5.11 Passive diffusion sorbent badges may also be used for certain approved chemicals.

**6.0 RECORDS**

**6.1 Exposure Records**

The following records SHALL be maintained for at least 30 years past the last date of employment:

- a) Personal Air Sample Data Sheets
- b) Chain-of-Custody Forms
- c) Laboratory Analysis Sheets

SOP Revision History

Revision	Date	Changes Summary
Revision 0	12/01/94	New
Revision 1	7/7/99	Unknown
Revision 2	7/15/04	Unknown
Revision 2	12/26/07	SOP number change
Revision 3	2/23/09	Review & minor formatting changes



## **Attachment A**

## WILLBROS ENVIRONMENTAL SERVICES AIR SAMPLE DATA SHEET

Project Sampling Equipment

Type \_\_\_\_\_ ID No. \_\_\_\_\_

Calibration \_\_\_\_\_

Sample Number

Date

Contaminant(s)

Analytical Method

Sample Type

General Area

Personal Name \_\_\_\_\_ SSN \_\_\_\_\_

Work Activities/Conditions

Sample Location

Pump No.	Initial Flow	Time On	Final Flow	Time Off	Average Flow	Total Time	Total Volume
	LPM		LPM		LPM	Minutes	Liters

Results

Contaminant  
TWA

Concentration

8-Hour

Sampling Performed By: \_\_\_\_\_

Sampling Reviewed By: \_\_\_\_\_



## **Attachment B**

**WILLBROS ENVIRONMENTAL SERVICES  
AIR MONITORING SUMMARY**

DATE: \_\_\_\_\_

SAMPLING LOCATION: \_\_\_\_\_  
\_\_\_\_\_

WEATHER SUMMARY: \_\_\_\_\_  
\_\_\_\_\_

DAILY SUMMARY: \_\_\_\_\_  
\_\_\_\_\_  
\_\_\_\_\_  
\_\_\_\_\_  
\_\_\_\_\_  
\_\_\_\_\_  
\_\_\_\_\_

SPECIAL CONDITIONS OR OBSERVATIONS: \_\_\_\_\_  
\_\_\_\_\_  
\_\_\_\_\_  
\_\_\_\_\_  
\_\_\_\_\_

MONITORING PERFORMED BY: \_\_\_\_\_





Willbros Government Services, LLC – Site Operations & Procedures  
**HEALTH AND SAFETY PROCEDURES**

**SUBJECT:TANK CLEANING & DECONTAMINATION**

Revision 3	5-21-08	SOP #	SOP-2	PAGE	1 OF 8
------------	---------	-------	-------	------	--------

1 **POLICY** - All tank cleaning and decontamination projects will be conducted according to this procedure and a corresponding site safety SSHEP and HASP plan.

2 **PURPOSE** - This procedure outlines the steps necessary to ensure the safe cleaning and decontamination of tanks.

3 **SITE ASSESSMENT**

3.1 Visually inspect the site to ensure that the work can be safely done. Special attention must be given to safe work surfaces, the presence of overhead and underground lines which may hinder equipment operation, and local traffic which may be affected.

3.2 Locate the tank, together with piping, vents, manways, energy sources, and other associated safety hazards.

3.3 If uncertain of the tank contents, sample to verify that the tank contains the indicated product. Note liquid levels. Check for the presence of water and other contaminants.

3.4 Sample the tank vapor space with appropriate monitoring equipment that will verify safe/unsafe conditions. Refer to the HSE Procedure “Air Monitoring and Sampling”.

4 **SAFETY PRACTICES BEFORE CLEANING TANKS**

**Process for Certification of Tanks to be “Gas Free”**

4.1 Sample the tank atmosphere for flammables and oxygen. The atmosphere must be less than 10 percent of the LEL and contain between 19.5 and 23% oxygen. If the atmosphere shows flammable vapors > 10 percent LEL, then action must be taken to reduce the concentration such as ventilation or introduction of inert atmosphere.

4.2 Determination of the number and location of samples shall be determined by Willbros Corporate HS&E Manager due to the variation in projects. The Project Manager shall contact this person to describe the tank / surrounding area prior to sampling.

4.3 Sampling will only be preformed by the project On Site Supervisor or personnel specifically designated by the Corporate HS&E Manager.

4.4 Ambient background samples shall be collected upwind of the tank to be sampled.

4.5 Sampling equipment shall be calibrated prior to and again upon completion of the sampling. A “bump”/field test is acceptable on meters only if an exhaustive calibration



Willbros Government Services, LLC – Site Operations & Procedures  
**HEALTH AND SAFETY PROCEDURES**

<b>SUBJECT:TANK CLEANING &amp; DECONTAMINATION</b>					
Revision 3	5-21-08	SOP #	SOP-2	PAGE	2 OF 8

has been completed within a 30 day period. Documentation of calibrations is required and shall be sent to the Corporate HS&E Manager prior to sampling.

4.6 Colorimetric tube pumps shall be checked for leaks by inserting an unbroken tube and depressing the plunger. The pump is acceptable if the plunger does not expand back to its original position. Read the instructions for the colorimetric tubes for the number of strokes needed and the color change indicating a positive test. Be aware that some tube have cross-sensitivities and may cause a false readings. Colorimetric tubes detection limits vary. Consult with the Corporate HS&E Manager prior to use.

4.7 Sampling shall be completed for the following constituents:

- Benzene (utilize a colorimetric tube or meter specific for benzene)
- Oxygen & Flammable Vapors (utilize O2/LEL meter)
- Hydrogen Sulfide (utilize H2S meter or colorimetric tube)
- Carbon Monoxide (utilize CO meter or colorimetric tube)
- Total Hydrocarbons/Organics (utilize a photo ionization detector (PID))

4.8 Record Readings on the attached sheet and forward to the Corporate Health and Safety Manager.

4.9 If the tank atmosphere is greater than 10 percent LEL, one of these actions can be taken to make the tank safe for cutting.

Ventilate the Tank: This procedure only will work with clean products. (The tank will re-gas rapidly if not a clean product). Readings should be taken at the location of the tank exhaust to check for flammables. Note that exhausted vapors may be flammable, toxic, and require respiratory protection.

Clean and Ventilate the Tank: Use a cleaning method such as Butterworth spinner nozzle with hot water, pump out liquids, and then ventilate as above.

Inert the Tank: Nitrogen from a liquid nitrogen tank, or carbon dioxide from dry ice can be used to inert the atmosphere in the tank to **below the** oxygen concentration necessary for combustion. Note that flammable vapors will still be present; and once the tank is cut or opened, the inert gas can be lost. The atmosphere must be diluted to less than 8 percent oxygen by volume to be completely safe for normal petroleum products. O2 /LEL meter must be used to verify the oxygen concentration. Measurements must be made continuously. The quantity of inert gas which must be used depends on how the gas is presented to the tank. In practice, about 6 to 8 and perhaps as many as 10 tank volume would be required, depending on how the material is administered. If dry ice is used approximately, 11.5 pounds of dry ice per 100 cubic feet (15 lbs per 1,000 gallons) of tank volume is required to reduce the oxygen to 8 percent. There are several precautions which must be observed when using dry ice. The material is extremely cold - 109.3 F.

Foam the Tank: If product cannot be totally removed a method which has proven successful is to "foam" the surface of the remaining liquid with a fire fighting or vapor suppression foam. This foam blend should be 3 inches or 4 inches thick and will have the effect of suppressing vaporization of the volatile material. Foam does break down so continuous air monitoring will be needed to verify a nonflammable atmosphere and reapplication of the foam blanket may be required.





Willbros Government Services, LLC – Site Operations & Procedures  
**HEALTH AND SAFETY PROCEDURES**

<b>SUBJECT:TANK CLEANING &amp; DECONTAMINATION</b>					
Revision 3	5-21-08	SOP #	SOP-2	PAGE	3 OF 8

The foam must be applied through a tank opening and thus the tank must be opened. After laying the foam blanket, the tank may have to be ventilated so that the vapor flammable concentration is reduced to less than 10 percent of the LEL on the combustible gas indicator. In extreme cases, high expansion foam can be used to completely fill the tank. Obviously, no ventilation will be necessary in this case.

<b><u>Tank "Gas Free" Certification Form</u></b>						(Revision 1 2-4-08)
Date / Time:						
Project Location / ID:						
Sample Location / ID:						
Sampled By: (On Site Supervisor)						
Equip. Calibration Date:						
<b>Sampling Sites Specific location / Comments / Description.</b>						
Special Note 1: Background sample site must always be up wind from tank.						
Special Note 2: The number and location of samples shall be determined by Willbros Corporate HS&E Manager.						
Ambient Background Sample						
Tank Sample 1						
Tank Sample 2						
Tank Sample 3						
Tank Sample 4						
<b><u>Sampling Readings.</u></b>						
	Ambient Background Sample	Tank Sample 1	Tank Sample 2	Tank Sample 3	Tank Sample 4	
Benzene:						ppm
Oxygen:						%
Flam. Vapors (LEL):						%
Hydrogen Sulfide:						ppm
Carbon Monoxide:						ppm
Total Hydrocarbons:						ppm



Willbros Government Services, LLC – Site Operations & Procedures  
**HEALTH AND SAFETY PROCEDURES**

<b>SUBJECT:TANK CLEANING &amp; DECONTAMINATION</b>					
Revision 3	5-21-08	SOP #	SOP-2	PAGE	4 OF 8

**Process for Securing / Supporting Floating Roof Tanks Prior to Work**

- 4.10 API standard 2015 and API recommended practice API 2016 address the hazards associated with working on and inside above ground storage tanks. API 2026 addresses safe access/egress and hazards associated with entry onto floating roofs. Each Project Manager that works in or on the tank should be familiar with the requirements of these documents and adhere to them.
  
- 4.11 All Willbros and Contractor safety procedures and policies shall apply. These would include LOTO, Confined Space, and others. Reference the specific Willbros Procedures on these as needed.
  
- 4.12 General requirements / hazards associated with this work include:
  - 4.12.1 Confined Space—Respirator usage is based on conditions present however customer / site requirements may be more stringent, up to and including the use of supplied air for this task.
  - 4.12.2 4-7 man crew...may vary depending on # of people in confined space
  - 4.12.3 Vertical entry to space. From roof top---rescue equipment/fall protection
  - 4.12.4 Ventilation needed----air mover/blower
  - 4.12.5 Monitor atmosphere with LEL/O2 meter
  - 4.12.6 Watch for pinch points when pulling pins
  - 4.12.7 Spark proof tools/wrenches????
  - 4.12.8 Make sure rain / snow is kept off the floater when roof is landed.
  - 4.12.9 Suspend work if winds exceed 50 MPH or are anticipated.
  - 4.12.10 No substantial work activities, materials or equipment are allowed on top of floating roof, if personnel are working underneath the floating roof. (Substantial work activity is defined as Single Piece of equip. >500lbs; Total Weight >1500lbs.)
  
- 4.13 Prior to landing a floating roof, it is recommended that the roof be examined to assess the condition of the roof and its supports. the examination should be coordinated along with the leg-repositioning if required.
  
- 4.14 The examination shall include the following actions:
  - 4.14.1 Perform a visual inspection (Corrosion & Plumbness) of each of the floating roof support assemblies in-place: legs, leg pins, leg sleeves, adjacent roof deck.
  - 4.14.2 Perform visual inspection of floating roof deck and internal compartments to verify that they are free of water, product, vapor or significant debris.
  - 4.14.3 Inspect anti-rotation device to verify that it is structurally sound, welds are not significantly corroded or cracked.
  - 4.14.4 Check the floating roof primary seal type & condition to verify the seal provides lateral restraint.





Willbros Government Services, LLC – Site Operations & Procedures  
**HEALTH AND SAFETY PROCEDURES**

<b>SUBJECT:TANK CLEANING &amp; DECONTAMINATION</b>					
Revision 3	5-21-08	SOP #	SOP-2	PAGE	5 OF 8

- 4.15 Prior to entry under the roof, the following shall be done:
  - 4.15.1 If the floating roof lacks a reliable means of anti-rotation wedges or blocks shall be installed in the rim space in at least 4 equally spaced locations.
  - 4.15.2 Remove floating roof manway cover plates and ladders placed near the manways (on top of deck to be used for emergency access)

**Setting & Pinning Legs** - Prior to entering a tank to perform the cleaning, a detailed plan for supporting the roof shall be developed by the cleaning contractor. It shall include:

- 4.16 Information obtained during the roof inspection so that all supports that were determined to be damaged or inadequate are identified and replacement support is incorporated into the plan.
- 4.17 It shall include the plan for establishing back-up supports to be installed near shell manways and floating roof manways so emergency exits are supported. A minimum of two cribbing stacks shall be installed by each shell manway used for entry.
- 4.18 Enter from top of tank – follow all Willbros confined space entry protocols. A specialized retrieval system called a Davit is recommended for dome roof tanks. After securing the manway, the tank should be surveyed to ensure that all visible legs are in contact with the bottom, all legs are plumb and straight.
- 4.19 Verify that the anti-rotation device is well attached and functioning as intended.
- 4.20 Check the condition of the primary seal to determine whether it is providing adequate lateral support to floating roof.
- 4.21 Set legs at desired height by pulling up as far as possible and give a visual inspection before sliding it down to the appropriate setting and inserting the pin threw the hole in the leg.
- 4.22 Insert pin into legs to secure by" Cotter pins will be placed threw the pin to ensure that it is secure.

**Cribbing Procedures for Entry.** Cribbing (Placement of supports under floating roof structures) is a Willbros requirement on all projects of this type.

- 4.23 Crib stack material requirements are hardwood 6’ x 6’ x 4’ long. Pressure treated wood is not acceptable. These requirements can be overridden based on site specific conditions as long as acceptable documentation is provided assuring the load capabilities of the alternate materials. Cribbing should be solid, straight and free of



Willbros Government Services, LLC – Site Operations & Procedures  
**HEALTH AND SAFETY PROCEDURES**

<b>SUBJECT:TANK CLEANING &amp; DECONTAMINATION</b>					
Revision 3	5-21-08	SOP #	SOP-2	PAGE	6 OF 8





Willbros Government Services, LLC – Site Operations & Procedures  
**HEALTH AND SAFETY PROCEDURES**

<b>SUBJECT:TANK CLEANING &amp; DECONTAMINATION</b>					
Revision 3	5-21-08	SOP #	SOP-2	PAGE	7 OF 8

- 5.3 All vacuum equipment will need to be bonded or grounding if combustible or flammable liquids are present.
- 5.4 All cleaning activities should take place on the outside of the tank if at all possible; however, if this is not feasible, then a confined space permit will need to be issued prior to entry. Refer to HS&E “Confined Space Entry” Safety Procedure.
- 5.5 The method of cleaning will vary based on the amount and types of material to be cleaned. In general, the following types of equipment may be utilized: Vacuum trucks, pressure washer, drum vacuum, squeegee, mops, brushes, etc.

**6 TANK CONTENTS REMOVAL**

- 6.1 All products will be removed by pumping (if possible).
- 6.2 If the tank atmosphere is flammable, the tank shall be inerted prior to cleaning. (See section 4.9 above for additional information)
- 6.3 If possible, all lines will be removed by disconnecting joints rather than cutting or burning. No hot work will be performed without a hot work permit / LEL testing.
- 6.4 The tank will then be carefully cleaned and decontaminated.

**7 TANK DECONTAMINATION**

- 7.1 Decontamination is required to remove residue from the tank.
- 7.2 The decontamination area will be marked as an exclusion zone. Proper PPE, medical emergency equipment, shower, and eye wash, should be available.
- 7.3 Before opening the tank to permit entry for water blasting, foaming, or other cleaning methods used, verify again for the presence of flammable vapors. Confined space entry procedures apply.
- 7.4 Personnel will wear protective suits / respiratory protection appropriate to hazards.
- 7.5 Establish a method for rinse water containment and proper disposal procedures.

**SOP Revision History**

Revision	Date	Changes Summary
Revision 0	10/08/96	New



Willbros Government Services, LLC – Site Operations & Procedures  
**HEALTH AND SAFETY PROCEDURES**

<b>SUBJECT:TANK CLEANING &amp; DECONTAMINATION</b>					
Revision 3	5-21-08	SOP #	SOP-2	PAGE	8 OF 8

Revision 1	11/09/04	Unknown
Revision 2	12/26/07	SOP number change
Revision 3	5-21-08	Added HS-39 (gas free cert) and included addl info on setting legs and cribbing for floating roof tanks
		Reviewed 6-23-09 – no changes





Willbros Government Services, LLC – Site Operations & Procedures  
**HEALTH AND SAFETY PROCEDURES**

<b>SUBJECT: BONDING AND GROUNDING</b>		
REVISION 3	5-27-09	SOP # SOP-3
		PAGE 1 OF 2

**1.0 POLICY**

Static sparks are dangerous ignition sources wherever the air contains an ignitable mixture. Hazardous areas include near the nozzles of flammable liquid fill pipes and delivery hoses, open containers of flammable liquids, around tank truck fill openings, and drum bumpholes. Flammable liquid containers should be bonded or grounded to prevent spark-ignited fires and explosions.

**2.0 PURPOSE**

To prevent a fire or explosion initiated by static electricity.

**3.0 REQUIREMENTS**

Employees who are transferring flammable liquids from one vessel to another are to use the following guidelines:

3.1 Bonding: equalizes static electricity by creating a conductive connection between two vessels.

Bonding Requirements:

- A conductive connection between the transferring container and the receiving container must exist.
- Examples of acceptable connections are: 1) a flexible conductor such as a bonding strap or wire secured to the containers; or 2) solid metal contacts between containers.

3.2 Grounding: means to dissipate static electricity into the earth to eliminate its buildup.

Grounding Requirements:

- Examples of acceptable grounding techniques are: grounding straps, cables or wires connected to known grounds such as water pipes, grounded metal structural parts of buildings and metal underground gas pipes.
- All grounding equipment should be checked periodically for effectiveness.

SOP Revision History

Revision	Date	Changes Summary
Revision 0	11/08/04	New
Revision 1	2/23/06	Unknown
Revision 2	12/26/07	SOP number change
Revision 3	5-27-09	Review & minor formatting

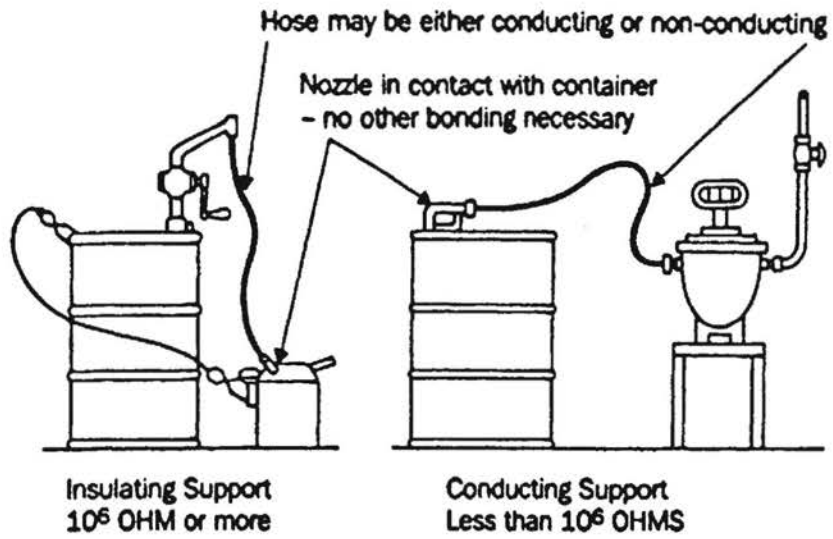

Bond wire necessary except where containers are inherently bonded together - or arrangement is such that fill stem is always in metallic contact with receiving container during transfer.

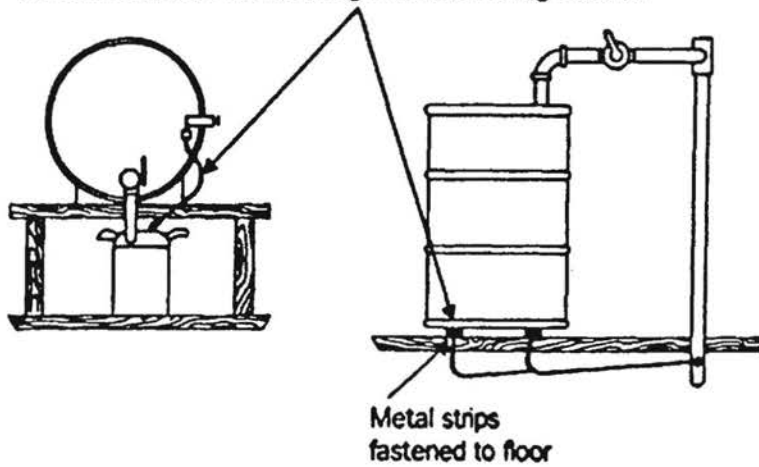





<b>SUBJECT: VACUUM TRUCK OPERATION</b>			
Revision 3	2-4-08	SOP # SOP-4	PAGE 1 OF 3

**1.0 POLICY**

Willbros believes in proper operation of vacuum trucks to prevent injury and equipment damage. Only properly trained and licensed operators and will be permitted to operate vacuum trucks.

**2.0 PURPOSE**

This program is intended to provide Willbros personnel with a guideline for the safe operation, use and inspection of vacuum trucks. All activities and operations shall comply with Willbros SSHEP and HASP.

**3.0 GENERAL REQUIREMENTS**

- Before beginning operations operators shall conduct an inspection and complete the vacuum truck inspections form attached to this document. The inspection shall include the vacuum truck, equipment, and loading/off loading sites.
- Vacuum trucks shall be operated in accordance to manufacturers specifications.
- A [Vac Truck Checklist](#) will be filled out for all jobs involving vac truck work. The form has sections to be filled out prior to leaving for the job, on the job, and post job.
- Atmospheric air monitoring shall be conducted prior to and during operations involving hazardous materials. Be aware that environmental conditions may change during operations like wind direction, other plant operations, or a product release. Air monitoring shall be in accordance to Willbros’s Air Monitoring Health and Safety standard and conducted by a qualified person. Testing shall include but may not be limited to oxygen content, flammable range, and toxicity. If monitoring reveals a toxic atmosphere where respiratory protection is required adhere to Willbros’s Respiratory Protection Program. Vacuum operations shall cease if atmospheric conditions at the truck are greater then (>) 10 percent of the lower flammable limit.
- Vacuum trucks shall not enter into tank dike areas until such areas have been checked/monitored and rendered safe.
- All personnel shall leave the vacuum truck cab during loading and off-loading operations.
- All operators and assistance shall wear hearing protection while the vacuum truck is in operation.
- Vacuum truck operators shall remain positioned between the vacuum truck and the source or receiving tank, or container and within 25 feet of the vacuum truck throughout the duration.
- Vacuum truck operators shall monitor the transfer operation and be ready to quickly close the product valve and stop the pump in the event of a blocked line or release of material.
- Vacuum truck operators shall maintain proper distances when operating vacuum trucks inside facilities with restricted clearances.



Willbros Government Services, LLC – Site Operations & Procedures  
**HEALTH AND SAFETY PROCEDURES**

<b>SUBJECT: VACUUM TRUCK OPERATION</b>					
Revision 3	2-4-08	SOP #	SOP-4	PAGE	2 OF 3

- The use of a safety “T” shall be used and reachable by the work crew.
- A pressure release “spool valve” shall be in place at the line furthest away from the pressure/vacuum source.

4.0 **FLAMMABLE LIQUIDS**

- Transferring flammable or combustible liquids shall be conducted in vacuum hose constructed of conductive material or thick walled hose with imbedded conductive wiring. The conductive hose shall provide suitable electrical conductance less than or equal to 1 mega ohm per 100 feet. Thin walled metallic spiral-wound conductive hoses shall not be used.
- The vacuum transfer system shall be bonded to achieve a continuous conductive path from the truck through the hose and nozzle to the tank or other container and grounded to earth. Grounding may be achieved by connecting to any properly grounded object like a metal building, tank frame, a fire hydrant, or a metal light post.
- Vacuum trucks should be located upwind of the vapor source.
- Vacuum pump vapors should be vented to areas free of ignition sources. Extending exhaust stacks or attaching additional hose can achieve venting.
- Vacuum pumps and blowers operated at high speeds may produce high discharge temperatures or concentrations so continuous atmospheric monitoring is critical.
- Smoking shall not be permitted within at least 100 feet of the truck, the discharge of the vacuum pump, or any other vapor source.

5.0 **TRAINING**

- Vacuum truck operators shall be trained. Training will consist of a review of the operations manual provided by the manufacturer. A written test shall be completed to verify that the information was retained.
- A minimum of three days of operation under the direct supervision of a trained operator who has a good safety record. The trained operator must be satisfied with this performance until they are permitted to operate the vacuum truck alone.
- Vacuum truck operators must be trained to be aware of the effect of speeds, turns and the changing center of gravity.
- Vacuum truck operators shall be trained in the potential hazards associated with petroleum facilities such as sources of ignition, flammable atmospheres, toxic vapors, slips and falls, fires and explosions, and driving safety. They should be trained in the hazards of petroleum products, by-products, wastes and materials being transferred, and government and facility safety procedures.





Willbros Government Services, LLC – Site Operations & Procedures  
**HEALTH AND SAFETY PROCEDURES**

<b>SUBJECT: VACUUM TRUCK OPERATION</b>			
Revision 3	2-4-08	SOP # SOP-4	PAGE 3 OF 3

Please reference Vacuum Truck Operators training manual (See example attached) for additional information: [Vacuum Truck Operations Training Manual](#)

**SOP Revision History**

Revision	Date	Changes Summary
Revision 0	3/12/1997	New
Revision 1	3/27/2007	Unknown
Revision 2	12/21/07	SOP Number Change
Revision 3	2-4-08	Added training manual link– updated header
Revision 4	11-21-08	Added general bullet 3 – vac truck checklist



Willbros Government Services, LLC – Site Operations & Procedures  
**HEALTH & SAFETY PROCEDURES**

<b>SUBJECT: WATER BLASTING</b>				
REVISION 4	9-14-09	SOP #	SOP-5	PAGE 1 OF 15

**1.0 POLICY**

Willbros water blasting projects will be run in a safe, organized method to prevent injuries.

**2.0 PURPOSE**

Provide general information on the safe operation of water blasting for Willbros Environmental projects. The purpose of the Health & Safety Program is to improve Willbros's Safety Awareness by increasing the hazard analysis of the all activities having the highest potential of serious injury and/or death.

**3.0 SCOPE**

Water blasting, sometimes referred to also as hydro blasting or water jetting, is a rapidly growing and ever changing industry. If contractors, supervisors, field representatives, or operators have any questions in the area of high-pressure water operations; they should refer to ASTM E1575-08 industry standard or contact Willbros Corporate Compliance. Water blasting is the operation of high-powered water jets as normally used in construction, maintenance, drilling, metal, industrial, environmental, and demolition work. These high-pressure jets are used for both their cleaning and cutting applications.



Prior to starting a high-pressure operation, make sure that all components are rated for the correct operating pressure. The system is "only as strong as its weakest link." Never modify (i.e., cut, weld, mold, file, etc.) or use any component that has been modified, without written approval from the manufacturer. Manufacturer guidelines have been set for your safety and they should be respected and followed.

Water blasting is now the preferred method of industrial cleaning in oil refineries, steel mills, chemical plants, airports, and automotive plants worldwide. It is an efficient and cost effective method of remediation. But, if done incorrectly, can be very dangerous. Take the time to follow the company and manufacturer safety procedures.





Willbros Government Services, LLC – Site Operations & Procedures  
**HEALTH & SAFETY PROCEDURES**

<b>SUBJECT: WATER BLASTING</b>	
REVISION 4	9-14-09
SOP #	SOP-5
PAGE	2 OF 15

**NO JOB IS SO IMPORTANT THAT YOUR SAFETY OR THE SAFETY OF OTHERS SHOULD BE COMPROMISED.**

**LEVELS OF WATERBLAST PROJECTS**

- ***Low Pressure Cutting/Cleaning Operations: Systems pressure does not exceed 3,500 psi.***  
 Used in applications such as: removal of unwanted matter from surfaces and/or cut surface material. These operations can be performed with or without the addition of other liquids or solid particles to the water jet stream. These operations are usually performed in situations where the material that is to be removed has not bonded to the product.
- ***Standard Pressure Cutting/Cleaning Operations: Systems pressure 3,500-20,000 psi.***  
 These operations are usually performed in situations where extremely heavy "build ups" have formed on particular products. These build ups include: scale, rust, tar, rubber, paint, epoxies, etc. For pressures up to and including 20,000 psi the use of National Pipe Thread (NPT) fittings are recommended. NPT fittings, along with the use of Teflon tape, will provide a quality, leak-proof seal suitable for high pressure operations. These operations can be performed with or without the addition of other liquid or solid particles to the water jet stream.
- ***Ultra-High Pressure Cutting/Cleaning Operations: Systems pressure exceeds 20,000 psi.***  
 These operations are usually performed in cutting, stripping, and molding projects. These ultra-high pressures require the use of a cone or soft seat fitting. These fittings will allow the seal to be contained within the component itself, this will provide added protection against rupture. An anti-seize lubricant, along with the soft seat fitting, should be used in all connectors rated at, or above 20,000 psi. These operations can be performed with or without the addition of other liquid or solid particles to the water jet stream.

**4.0 RESPONSIBILITIES**

**Water Jet Crew**

All employees engaged in water blasting activities **MUST** be properly trained and qualified before beginning any high-pressure operation. A qualified employee is defined as: personnel who have undergone a proper training program and who have demonstrated the knowledge, skill and experience to perform all likely tasks, and shall operate high pressure water jet equipment. During any project, the correct application of the water blasting equipment is the responsibility of the water jet crew. The crew consists of the following members:



Willbros Government Services, LLC – Site Operations & Procedures  
**HEALTH & SAFETY PROCEDURES**

<b>SUBJECT: WATER BLASTING</b>				
REVISION 4	9-14-09	SOP #	SOP-5	PAGE 3 OF 15

*The Nozzle Operator:*

- Controls the action of the high-powered jets through the use of a control gun, foot valve or delivery hose. The Nozzle Operator shall Always be responsible for the safety (or foot) valve control.
- Completes the final safety check on the water blasting components.
- Relays information to the other crewmembers as to the progress of the project.
- Is responsible for ensuring that the work area is maintained during water jet operation.

*The Pump Operator:*

- Monitors the pump while the system is energized and the nozzle operator is blasting.
- Remains with pump and maintains visual contact / communication with the nozzle operator at all times.
- Performs daily maintenance on the unit.
- Alerts co-workers of the hazards involved with the project.
- Keeps visitors clear of the immediate area.
- Makes the necessary adjustments to the water blast equipment during the project.
- Quickly shuts down a project if the nozzle operator is in danger or conditions have become **UNSAFE**.

*The Crew Leader:*

- Takes responsibility for the overall quality of the project.
- Appropriates all necessary permits for the project (i.e., hot work, confined space, lock-out/tag-out, etc.)
- Reviews the site safety program with crew and assures it is followed.
- Administers first aid to a crewmember in case of injury.
- Schedules a regular change in tasks for the members of the crew; keeping operators from becoming fatigued.

**NOTE: Although single person operations are not recommended, they can be performed when the pump pressure does not exceed 3,500 psi, and the flow of the system is less than ten gallons per minute.**

**Project Start-up Procedures**

Every water blast site has its own unique characteristics; therefore, each member of the water jet crew shall review every project. High-pressure operations must be secured with barricade tape and other appropriate warning signs. It might be necessary to have this barricaded area inspected by the contractor or another field representative, for their approval. Exit points for hoses and lances must also be barricaded or shielded. The appropriate pre-operational





Willbros Government Services, LLC – Site Operations & Procedures  
**HEALTH & SAFETY PROCEDURES**

<b>SUBJECT: WATER BLASTING</b>			
REVISION 4	9-14-09	SOP # SOP-5	PAGE 4 OF 15

procedures must be followed before beginning any high-pressure operation. Prior to high-pressure operations, the project should be:

- **Pre-planned** to ensure that personnel are familiar with the equipment, work area, and method of cleaning that will be implemented on the project.
- **Monitored** for potential hazards.
- **Barricaded / Shielded** to enclose potential hazardous areas (barricades may be safety tape, rope, wire, barrels, etc., as long as it is highly visible).
- **Inspected for defects** in the hoses, lances, fittings, couplings, nozzles, etc.
- **Flushed** to clean the system of debris that might clog the components.
- **Pressurized slowly** to inspect the system for leaks and/or other faulty components.

**Project Shutdown Procedures**

The temporary shutdown of a project might be necessary if certain conditions arise. **Water blasting projects should be shutdown if:**

- An unauthorized visitor enters the barricaded area.
- Severe weather changes or other hazardous conditions are detected.
- An alarm is sounded within the plant, refinery, or area in which the project is being performed.
- **ANY** crewmember feels that the project has become **UNSAFE**.

**Required PPE for Water blasting**

OSHA requires PPE be selected based upon the associated hazards of the work. The following is the minimum PPE to be worn while water blasting:

- **Hard Hat:** hard hats or appropriate helmets that meet American National Standards Institute (ANSI) head protection standards should provide Physical protection of the head. Their selection must be based on acceptable integration with protective clothing and respirators.
- **Safety Glasses with Side Shields**
- **Heavy Non-Slip Gloves:** Hands are the part of the body most likely to come in contact with chemicals. Gloves come in different materials and thickness. The ability of the gloves to withstand chemical and physical hazards is very important.
- **Metatarsal Boots:** Steel-toed boots that are made of chemical resistant materials and provide added protection to the top of the foot and shin.
- **Face Shields:** In situations where full-face respirators are not used, face shields are used to protect the face from chemicals and debris.
- **Rain Gear:** This will not provide full and complete body protection. However, they do provide additional splash protection when used with non-encapsulating suits.



Willbros Government Services, LLC – Site Operations & Procedures  
**HEALTH & SAFETY PROCEDURES**

<b>SUBJECT: WATER BLASTING</b>			
REVISION 4	9-14-09	SOP # SOP-5	PAGE 5 OF 15

- **Hearing Protection:**
- Additional PPE that might be required while water blasting may include:
  - Fire retardant clothing (FRC)
  - Chemical goggles
  - Respiratory protection
  - Full body harness and lanyard
  - Long cotton underwear
  - Chemical resistant inner gloves
  - Chemical resistant outer gloves/boots
  - Two way radio communications
  - Escape mask

**NOTE: Use of two or more waster blasters in the same area is discouraged. If this practice is warranted an additional risk assessment shall be made by the supervisor and additional PPE requirements shall be considered.**

- **Water Blasting with pressures or 3,500 psi or greater needs to be evaluated for the following additional Personal Protective Equipment. It is the supervisor's responsibility to assess the specific job hazard. It is the supervisor's responsibility to justify this decision on waterblaster / safe work permit paperwork prior to work. If engineering controls are not available to control potential hazards all additional PPE shall be utilized.**
  - Wet Suit / Rain Suit / Heavy Duty Slicker
  - Kevlar plated protective suits, sometimes referred to as "Turtle Skin Suits" which serve as a segmented panel personal armor system that protects the feet, legs, chest, and arms. This suit is comprised of three components that are worn on top of a standard wet suit.
    - Gaiter: Protects feet, shins, toes, and insteps
    - Gauntlet: Protects wrist, forearm, and back of hand
    - Body Suit: Protects chest, torso, upper legs, and lower legs

**NOTE: It is the responsibility of the Crew Leader to ensure that the Kevlar Plated Personal Protective Suit is rated to protect at the pressure level utilized on the water blasting unit.**

**NOTE: Inadequate or incorrect protection can result in serious injury, so a "safety first" approach in choosing protective equipment is in order.**

**In-Use Monitoring**

When you are wearing PPE you should be alert for any of the following conditions:

- Signs that the protective ensemble has been degraded in any way.





Willbros Government Services, LLC – Site Operations & Procedures  
**HEALTH & SAFETY PROCEDURES**

<b>SUBJECT: WATER BLASTING</b>			
REVISION 4	9-14-09	SOP # SOP-5	PAGE 6 OF 15

- Notice of chemical odors and Signs that it is becoming more difficult to breathe.
- Notice of skin irritation.
- Interference with your ability to see clearly.
- Your ability to move has been restricted.
- Sense of discomfort, rapid pulse, nausea, or chest pain.

**Inspection and Maintenance**

When working with pressures that are involved in water blasting, valves and seating surfaces encounter a high amount of daily wear. Therefore, these items require frequent inspections, maintenance, and replacement to ensure proper operation. All fittings should be compatible in size, thread, and pressure rating to coincide with the other components of the high-pressure unit.

Loose or leaking couplings should be either replaced or repaired immediately. Failure to correct these faulty fittings will cause unnecessary wear on the systems pump. This will eventually lead to system over-pressurization, ultimately causing system failure. If a leak is detected after the project has started, the pump must be shut down before the repair can be made. **NEVER ATTEMPT TO REPAIR A LEAK WHILE THE SYSTEM'S PUMP IS ENERGIZED!** This greatly increases the chance of rupture or burst in the system while the operator is in a vulnerable position.

**Checklists and written records are needed.** There are different types of inspections:

- Inspection and testing of new equipment.
- Inspection of equipment at the time it is issued to workers.
- Inspection after use.
- Periodic inspection of stored equipment.
- Inspection when problems are reported.

**Please see Water blasting Checklist attached.**

**CAUTION: The responsibility to inspect PPE must be assigned to a specific qualified person. Workers should know how to do a basic equipment inspection.**

**5.0 REQUIREMENTS**

**PUMP SAFETY**

**Safety Release Devices**

The pump is the single most important component of the high-pressure water system. It is generally referred to as the "heart" of the unit. Knowing this, it is obvious that the care and maintenance of the pump is vital to the effectiveness of the project. The pump is equipped with four safety release devices that protect the system against over-pressurization.



Willbros Government Services, LLC – Site Operations & Procedures  
**HEALTH & SAFETY PROCEDURES**

<b>SUBJECT:</b>		<b>WATER BLASTING</b>	
REVISION 4	9-14-09	SOP # SOP-5	PAGE 7 OF 15

- *Automatic Regulating Valve - Valve used to automatically control the working pressure of the pump by controlling the water flow. When the pump exceeds a set value, the valve will partially open. As the valve opens further, more water is bypassed from the nozzle to the supply reservoir. This valve is sometimes referred to as an "unloading valve."*
- *Rupture (Burst) Disc - This is a metal disc held in a specially designed holder that will fail when the pressure applied exceeds a preset limit. Discs are usually different sizes to accommodate the various pressures that are discharged from the pump. A rupture disc is the main safety release device and is designed to relieve 100% of the systems pressure.*
- *Pressure Relief Valve - This valve is spring-loaded and held in the closed position during normal operations. The device is designed to open when the system's pressure exceeds a preset limit. This valve is commonly referred to as a "pop-off" valve. The pressure relief valve is the main back up to the rupture disc.*
- *Bypass Valve - This valve is used to set the operating pressure, either manually or automatically, which controls the jet stream issuing from the nozzle. The valve also, "bypasses" unused water flow to the regulating tank. This conserves the amount of water that is used during the project.*

**NOTE: The above-mentioned safety devices serve as warning signs against system failure. All members of the water jet crew should be familiarized with these safety features. These devices should be inspected and tagged on a regular basis to ensure that they are in proper working condition.**

**Gauges**

The gauge is another very important feature of the high-pressure pump and is crucial to maintaining control of the system's pressure. A properly working gauge should:

- Be highly visible for the operators.
- Have a scale range of at least 50% above maximum working pressure.
- Be liquid-filled for a steady and accurate reading.
- Be equipped with a safety snubber.

**NOTE: A snubber absorbs the hydraulic shock and allows the gauge to display a more accurate reading. The snubber provides the gauge protection against wear and gives it a longer operating life.**

**Filters**

Filters and strainers should be checked regularly to ensure that they are not blocked or damaged. The pump operator should take the time to examine, change, or clean the filters to ensure that solid particles, which might clog the nozzle orifices, have not escaped the filter. These solid particles can damage the valves, nozzles, and connections making the pump run poorly. Filters and strainers should be checked on a regular basis, but especially so, when the quality of the water supply is





Willbros Government Services, LLC – Site Operations & Procedures  
**HEALTH & SAFETY PROCEDURES**

<b>SUBJECT: WATER BLASTING</b>			
REVISION 4	9-14-09	SOP # SOP-5	PAGE 8 OF 15

poor. The manufacturer's recommendation should be followed when setting a maintenance schedule. Filters should be adequately sized as to collect any particles that might block the smallest opening in the system.

**FITTING SAFETY**

Fittings (sometimes called valves or couplings) are the links that tie the components of the high-pressure system together. All fittings must be cleaned before installing in the system. Also, be sure that all fittings are leak-free and pressure rated for the appropriate application. Never use damaged or corroded fittings. The use of a brass or cast iron fitting is also not recommended. Manufacturers suggest the use of a reinforced stainless steel fitting for all high-pressure applications. The seal that the fitting provides is crucial to the safety of the project.

**HOSE SAFETY**

**Components**

High-pressure hose is a flexible hose that can be used to carry water and/or other abrasives from one part of the high-pressure water jetting system to another. The high-pressure hose consists of:

- A rubber or plastic core.
- Reinforced high tensile steel wires.
- A protective covering.
- Pressure tested end fittings.

As an added safety feature, the hose shall be equipped with a **hose shroud assembly near the operator**. A hose shroud is a length of flexible material, usually formed into a tube around a hose end coupling across the connection to the jetting gun. The shroud provides some instantaneous protection should the hose rupture. **The shroud will not form a permanent barrier to the flow of water from a damaged hose.**

**Damage/Defects**

Due to the heavy amount of friction that is caused by water blasting, the hose is constantly subjected to wear and damage. The condition of the high-pressure hose is critical to the safety of not only the water jet crew, but to everyone in the general vicinity of the water blast project. Barricades should be made so that all hoses are protected from being run over and crushed by vehicles, forklift trucks, etc. If a hose is run over while energized it will over pressurize and could rupture immediately. The hose should also be laid out to avoid unnecessary wear.

Prior to each operation, the hose should be inspected for certain visual defects. The hose should be discarded if:

- Steel or fiber wires are frayed or broken.
- The protective covering has blisters or bulges.



Willbros Government Services, LLC – Site Operations & Procedures  
**HEALTH & SAFETY PROCEDURES**

<b>SUBJECT:</b> WATER BLASTING					
REVISION 4	9-14-09	SOP #	SOP-5	PAGE	9 OF 15

- The hose is crushed or kinked.
- End fittings are damaged.

Along with the above-mentioned visual defects, there are two non-visual defects that should result in the hose being discarded. The hose should be discarded if:

- The hose has been subjected to pressures exceeding 50% above maximum working pressure.
- The hose is more than three years old regardless of its condition.

**NOTE: High-pressure hoses should be flushed with low pressure water before beginning operation.**

**Whip Checks**

Hoses must also have whip checks in case of hose failure. A whip check is a length of cable, wire, or nylon that bridges the different links of high-pressure hose. Opening each end and looping them over the hose’s end fittings install whip checks. This will prevent the hose from "whipping" in case of coupling failure. **Whip checks are the water jet crew's #1 safety defense against high-pressure accidents.**

**NOTE: Nylon Whip Checks are a better option over wire / cable whip checks due to potential injury when handling when they become abraded. Nylon is also easier to cut away / replace.**

**End Fittings**

The final components of the high-pressure hose are the end fittings (couplings). The couplings are used to connect several links of high-pressure hose. Like all water blast components, couplings must be rated and tested for the appropriate operating pressure. Couplings generally fall under two categories - Screw (quick) type or Ball (hammer) style

**NOTE: It is important to remember that couplings are safe only when whip checks are in place.**

**SURFACE CLEANING SAFETY**

**Control Gun (Shotgun)**

Surface cleaning is the use of high-pressure water to clean the unwanted deposits of materials from a given surface. The most common method of surface cleaning is performed through the use of a control gun (commonly referred to as a shotgun). Shot gunning is defined as a hand-held application whereby an assembly of a lance and a nozzle can be manually manipulated in virtually all planes of operation. A properly working shotgun should:

- **Be equipped with a double trigger double dump valve guard and safety latch.** The trigger should be easy for the operator to control while wearing gloves. The safety latch will "lock out" the gun and prevent accidental actuation. (See safety note below)





Willbros Government Services, LLC – Site Operations & Procedures  
**HEALTH & SAFETY PROCEDURES**

<b>SUBJECT: WATER BLASTING</b>			
REVISION 4	9-14-09	SOP # SOP-5	PAGE 10 OF 15

- **Have a shrouded whip hose.**
- **Be as light as possible.** (This will reduce operator fatigue. Also, it will give the operator a greater sense of mobility and balance.)
- **Be at least 66 inches in length from the tip of the nozzle to the butt of the barrel.** (This is the recommended safe distance between the operator and the high-powered water jets.)
- **Have a nozzle assembly.** (This is the support that will hold one or more nozzles in place while water blasting sometimes referred to as nozzle holder.)
- **Have a lance section.** (This is a length of pipe / lance that is used to extend the gun reach.)
- **Have a shoulder stock.** (To give the operator support while engaged in water blasting.)

**NOTE: Some control guns feature dual action triggers. These double trigger guns require that the operator, one by each hand, activate two triggers in order to generate high-pressure water. This style of gun will provide the operator with maximum safety while surface cleaning.**

**Surface Preparation**

The work surface itself, must meet certain specifications before activities can take place. The area:

- Should not be so large that the high-pressure hose has to be stretched or twisted.
- If located four or more feet above the ground, must have the OSHA approved scaffolding constructed. **(NEVER WATERBLAST FROM A LADDER!!)**
- Must be free of any obstacles (hoses, air lines, pipes, etc.) that might hinder movement.
- Should be cleared of any debris that might be projected through the air if struck by the high powered jet stream (practice good housekeeping).

**Nozzles**

The nozzle (commonly called the tip) is the device that discharges the water from the system. It restricts water flow, accelerating the force and shaping it to the required flow pattern. There are three major types of nozzles used in water blasting operations.

- **Straight Tip:** The straight tip exits from a circular orifice and is used to carry great force to the target with a minimal displacement of water. Straight tips are typically used for their cutting power or to clean extremely hardened materials. A straight tip is also known as a zero degree jet or a "hard hitter."
- **Fan Tip:** The fan tip has a greater coverage, than the straight tip, as it is designed to spread out as it exits the orifice. The degree at which the jet tapers out from the central axis is often used to designate the jet produced. These tips are often used to clean larger areas requiring less energy to remove unwanted matter.
- **Surface Spin Tip:** A tip that is set in the opposite direction of the nozzle's motion. The spin jet is used to provide force to move the nozzle into the object (tube, pipe, silo, etc.)



Willbros Government Services, LLC – Site Operations & Procedures  
**HEALTH & SAFETY PROCEDURES**

<b>SUBJECT: WATER BLASTING</b>			
REVISION 4	9-14-09	SOP # SOP-5	PAGE 11 OF 15

that is to be cleaned. The use of this jet allows the operator to clean in otherwise inaccessible location.

**TUBE CLEANING** - Tube cleaning consists of inserting a rigid or flexible lance, with an affixed nozzle, into a tube, pipe, or drain, to clean the inner diameter. This method of cleaning uses self-propelling nozzles that allow the operator to clean these hard to reach areas. The nozzles are propelled because of specially designed orifices, or openings (cutters, pullers, polishers, etc.) That advance the lance through the tube.

There must always be proper clearance when line moleing a tube, pipe, drain, etc. Clearance is the distance between the outside diameter of the lance and nozzle and the inside wall of the item that is being cleaned. This clearance will allow adequate washout of water and debris while preventing the jets from reversing its direction.

Whip hose, as in all methods of water blasting, must be used during tube cleaning operations. The whip hose will prevent bending or kinking near the foot gun, which could prove especially hazardous to the nozzle operator.

**Lances - The lances used in tube cleaning fall under two categories.**

**Flex Lance**

The flex lance is a length of flexible, tubular material that is used to line mole in areas with a small amount of space. The use of a flex lance gives the operator a greater sense of mobility while line moleing. The flex lance consists of:

- A steel core. □ A protective covering.
- High strength reinforcing wires. □ High-pressure end fittings.

As mentioned in the section on Hose Safety, the flex lance should be checked for certain visual defects. The flex lance should be discarded if it has:

- Kinks □ Bends □ Crushed spots.
- A damaged protective covering □ Loose or leaking end fittings.
- If any of the above mentioned conditions exist then lance failure may occur.

For additional protection while flex lancing, a stainless steel rod ("stinger") is inserted into the nozzle. The stinger acts as a safety guard between the operator and the high-pressure jets. A lance safety grip (hand guard) with an anti-withdrawal device (horse shoe washer) shall be used and sized appropriate to the nozzle fitting to prevent hydraulicing out of the tube.

**Rigid Lance**

A rigid or stiff lance is a seamless length of tubular steel, which gives the lance a hard or stiff quality. Stainless steel is the recommended material for rigid lances. The rigid lance is used





Willbros Government Services, LLC – Site Operations & Procedures  
**HEALTH & SAFETY PROCEDURES**

<b>SUBJECT: WATER BLASTING</b>			
REVISION 4	9-14-09	SOP # SOP-5	PAGE 12 OF 15

for extremely hard to clean tubes with large amounts of build up. As with flex lances, it is important to examine rigid lances for defects. The rigid lance should be discarded if it has Kinks, Bends, Crushed Spots, Damaged Threads, or Scale Build-Up.

In many rigid lancing operations, extensions are required to reach the entire length of the tube, pipe, drain, etc. The length of the rigid lance (including the series of extensions) shall not be so large that the operator cannot control the lance. If the lance has exceeded the length that the operator can control, then a second operator shall be used to assist in controlling the lance. Six (6) feet is the maximum length of lance that one operator can safely handle.

**Foot Controlled Valve (Foot Gun)**

The most common method of controlling pressure while tube cleaning is through the use of a foot-controlled valve (or foot gun). A foot gun allows the nozzle operator to safely control the water jets while keeping his/her hands free to operate. A properly working foot valve (foot gun) must have:

- A freely moving pedal that is clear from any obstructions.
- A low pedal force to reduce operator fatigue.
- A protective guard to prevent accidental actuation.
- The durability to handle daily operations.
- Nozzle Operator Shall Be In Control Of Foot Valve At All Times

**NOTE: When performing a two-man line cleaning operation, the individual who is inserting the nozzle MUST also control the foot valve.**

**Line Moleing Operations**

To be added at a later time

**ACCIDENTS/PERSONAL INJURY**

**First Aid Procedures**

All accidents are preventable. However, should an injury or other harmful situations occur, certain steps must be taken in the event of a high-pressure emergency. All injuries must be reported to a field supervisor immediately. The operator must never **ASSUME** that the injury is not severe. Non-medical personnel may not necessarily see the full extent of the injury, particularly internal damage. Even though certain water cuts may not leave a large surface wound, the fluid path that the water takes may spread chemical contaminants or bacteria through the body. If not monitored correctly, this exposure can lead to infections, internal organ damage, or even death.



Willbros Government Services, LLC – Site Operations & Procedures  
**HEALTH & SAFETY PROCEDURES**

<b>SUBJECT: WATER BLASTING</b>			
REVISION 4	9-14-09	SOP # SOP-5	PAGE 13 OF 15

**Medical Emergency Card**

In the event of an injury involving a high-pressure water cut, the injured person must be taken to a hospital immediately. To ensure that the doctor knows and fully understands the nature of the injury, all water jet operators should carry a precautionary medical emergency card. This card should be waterproof and easily accessible for the hospital staff. It should also list the chemical material involved on the project and the pressures that the operator was exposed to. This is an example of a medical card that might be found in the field:

**This person has been involved with high-pressure water jets.  
Please take this into account when making your diagnosis:**

**Unusual irritations have been reported to occur when lead based organisms enter the body under the working pressures and temperatures that were present at the time of the incident. These organisms may act as a facial pallor, cause anemia, or lead to kidney disease. Respiratory support might be necessary.**

**SUMMARY**

It is impossible to list all rules and procedures for every situation that can be encountered while water blasting; therefore, it is important that individuals working in this industry:

- Exhibit individual responsibility for safety awareness and use good judgment in performing their jobs. *(If It Is Unsafe – Stop Work!!)*
- Ask the immediate supervisor if any questions exist as to the appropriate safety practices.
- Alert other crewmembers of situations that you detect as possibly harmful.
- Follow all applicable safety procedures and guidelines for the facility where the operations are being conducted (i.e., refineries, steel mills, auto factories, chemical plants, etc.)
- Inspect all tools before using.
- Respect all warning signs and other barricades.

Water blasting is one of the most efficient and cost effective methods of industrial cleaning. However, if performed incorrectly, it can be extremely dangerous. Take the time to learn and follow all company and manufacturer safety procedures. **YOUR SAFETY COMES FIRST!**

**SOP Revision History**

Revision	Date	Changes Summary
Revision 0	3/12/97	New
Revision 1	5/09/07	Unknown
Revision 2	12/21/07	SOP number change
Revision 3	12/17/08	Unknown
Revision 4	9-14-09	Complete Re-write
Revision 5	12-07-09	Updated blaster picture (double handle)



**WATERBLASTING SAFETY CHECKLIST (Revision Date 9-14-09)**

Date: \_\_\_\_\_ Job#: \_\_\_\_\_ Location: \_\_\_\_\_

Equipment Being Cleaned: \_\_\_\_\_

<b>WATERBLASTING SAFETY CHECKLIST</b>		YES	NO	N/A
1	Is the area, including other end of unit being serviced, cleaned, roped off, and are proper safety signs posted?			
2	Have precautions been taken to protect electrical equipment from water?			
3	Is there any hazard to personnel from possible damage to equipment such as release of corrosive chemicals, flammable liquids or gases, etc.?			
4	Are all fittings of the correct pressure rating?			
5	Are all hoses of the correct pressure rating?			
6	Are all hoses in good operating condition?			
7	Are all fittings in good operating condition?			
8	Are all nozzles free from plugging? And in good operating condition?			
9	Have precautions been taken to prevent linemole reversal? Is stinger length a minimum of 1.5 times the diameter of the pipe?			
10	Is the filter on the pump suction clean and in good operating condition?			
11	Is there a minimum of 20 PSIG fresh clean water supply at pump suction?			
12	Have precautions been taken against freezing?			
13	Do all personnel have the proper safety equipment for this job?			
14	Do all personnel have the proper safety training for this job?			
15	Are all personnel qualified to perform this work?			
16	Are explosive or flammable vapors possible and are monitoring provisions established?			
17	If answer to 16 is "yes", do not use de-mineralized water or condensate and ground lance to equipment being cleaned.			
18	Is there any danger from the wastewater or from the reaction of the scale and water?			
19	If answer to 18 is "yes", has proper personal protective equipment been supplied to prevent injury, and has personnel been informed of this additional hazard?			
20	Has complete hook-up been flushed prior to installing nozzle?			
21	Has hook-up, including pipes, hoses and connections, been pressure tested with water at maximum operating pressure?			
22	Is dump system operating properly? (Will it dump when released?)			
23	Are safety systems operational?			
24	Has the job site been examined to determine if Confined Space Entry Requirement apply?			
25	Has all relevant moving equipment, such as conveyors, choppers, mixers, etc., been mechanically or electrically disabled with an appropriate lockout procedure?			
26	Has job been examined for environmental considerations, with action as appropriate?			
27	If flex lancing - has the hose been marked at least 24" from the nozzle to warn operator of the nozzle location?			
28	If flex lancing - is there sufficient space to allow washout of debris and water?			
29	If flex lancing - is the length of nozzle and coupling greater than inside diameter of the pipe?			
30	If flex lancing - have precautions, including the use of a nozzle support (stinger), been put in place?			

Supervisor Signature: \_\_\_\_\_

Employee Signatures: \_\_\_\_\_  
 \_\_\_\_\_







## **APPENDIX E**

### **PROJECT PROCEDURES – NON-DESTRUCTIVE TESTING (NDE)**

**TesTex Inspection Procedure  
For Storage Tanks 1-20  
at the  
Red Hill site  
Oahu, Hawaii**

**Flaw reporting and marking**

When areas reading less than nominal wall are found, the area is marked directly with paint. That area is then measured to the nearest permanent landmark (such as a weld line, patch plate, etc). The information is then placed on the TesTex-Red Hill preliminary data sheet. Copies of these sheets are to be given to the job contact at the beginning of the following day. Additional copies are to be faxed or emailed to TesTex headquarters once a week for processing.

**The Inspection begins on the Floor of the Tank**

**Numbering and Inspection**

- 1) Number the floor plates as per the TesTex-Red Hill tank floor drawing, paying close attention to the orientation of landmarks such as the 36" and 18" pipes, Tower corners, patch plates, etc. Keep in mind that odd numbered tanks are mirrored in comparison to even numbered tanks.

**Floor**

- 2) Once numbered, the floor (made up of 7 plates for a total of 25 feet in diameter) can now be scanned. Each of the 4 Technicians will use specially designed 8" wide LFET (Low Frequency Electromagnetic Technique) scanners. The electronics for each is to be the TesTex 8 channel TS-2000 instrument. Each technician's computer is to be running software WinLFET version 1.80.03, TS-2000 option. Since the floor plates are carbon steel with a thickness of 0.500", the frequency should be set to between 5 and 10 Hz. The actual frequency will be determined by the lowest frequency in the range producing the cleanest baseline (signal to noise below 0.5 degrees phase). Note: At a minimum, all technicians must check their system using the calibration plate at the beginning of each day. See separate LFET procedure for more details. Also note that if power is lost, once restored, all computer settings must be re-entered.

**Notes:**

- \* All patch and cover plates throughout the tank will be spot checked with conventional ultrasonic technique. Also, if any nozzles exist in the tank, U.T. will be



performed at the 12, 3, 6, and 9 o'clock positions around the circumference of the pipe as well as a spot check on the face of the nozzle.

\* Additionally, the corners of all plates throughout the tank must be checked with U.T.

### **Lower Dome**

- 3) Using the position of the catwalk above and the corners of the tower, start to layout and mark the quadrants (A, B, C, and D). Quadrant A begins directly under the catwalk at the closest corner of the tower. Likewise, quadrant B begins at the next corner clockwise around the tower. Continue this pattern for the other two quadrants. Paint lines showing the locations of each quadrant on course 1 and as far as you can reach on course 2, along with each quadrant letter so as to clearly be seen from above.

### **Course 1**

- 4) Once the quadrants have been identified, numbers are then assigned to the plates (wrote in chalk on each plate) of course 1. The numbers begin in quadrant A and continue through quadrant D.
- 5) Once the floor plates have been scanned, technicians can begin scanning the plates in course 1. These plates, as well as the rest of the tank, are carbon steel with a thickness of 0.250". A frequency of 10 Hz (plus or minus up to 1 Hz is allowed for cleanliness of signal) will be used for the remainder of the inspection.

### **Course 2**

- 6) Once all of the plates of course 1 have been scanned, scanning is to begin on the first 3 feet of course 2. Plates again are numbered in chalk starting with plate 1 at the beginning of quadrant A and continuing around to quadrant D. When the first 3' has been scanned, the two boomed baskets must be loaded with all of the equipment (3 TS-2000 electronics per basket) and the 2 outrigger trays (2 per basket to place computers on). Once the baskets have been fitted with all of the items, scanning can continue on the remainder of course 2. This is done by starting at the 3' line and scanning vertical passes up and down the width of the basket from the 3' line to the interface between course 3 and 4. All area now above the 3' line of course 2 must be both scanned with the 8" hand scanners (all plate surface area) and with the Hawkeye pencil probes (all welds). When scanning with the Hawkeye, a scan is taken on each side of all welds (probe bisects the weld/plate interface on each side). The software is to be set on a frequency of 100 Hz, gain of 18, rotation of 305. The probe should be used on the calibration plate periodically to assure proper function. See separate Hawkeye procedure for more details.

**Notes:**

\* There will be area in quadrant A and quadrant D that will not be reachable in the boomed baskets. This area will be scanned with an auxiliary basket at the end of the job (see barrel section for more details).

\* If a project coordinator is on site during the first week, this person will scan all welds below 3' on course 2 to include course 1 and the floor. Otherwise, the four technicians will scan these welds as each section is done.

\* Additionally, all intersection welds between course 1 and the floor must be retested using Shear Wave Ultrasonic Technique. This is performed when a Certified Ultrasonic Technician is available. Also, all possible defect locations found in welds throughout the tank, will be backed up with Shear Wave Ultrasonic technique. In addition, all welds will be visually inspected for pinholes. These pinhole areas, if found to have depth, will be marked for later Shear Wave sizing.

**Course 3**

7) Once all of the plates in course 2 have been scanned, the teams can move to course 3. Again, plates in this course are numbered as they were in course 2. Scanning also is performed in the same pattern of vertical up and down movements the width of the basket between the intersection of course 2 & 3 and course 4.

**Course 4**

8) Repeat the procedure for course 3.

**Barrel**

9) The Barrel consists of 28 courses (or rows) of plates. The plates in each course will be numbered 1 through X starting in quadrant A.

10) When scanning the barrel, drops as wide as the width of the basket are made vertically the entire height of the barrel section. Within a drop, there will be 28 scanning areas (i.e. the basket will be repositioned 28 times to cover the height of the barrel). Chalk lines will be placed at each end of the baskets on the wall the full height of the barrel to show individual drops. There will be 19 drops for each basket for a total of 38 that are reachable in the boomed baskets.

**Note:**

\* There will be 2 additional drops (one in quadrant A and one in quadrant D under the catwalk) that will be scanned using the auxiliary doublewide basket. These scans are best done after the upper dome has been scanned (so as to not lose time



dismantling equipment from the boomed baskets). Both drops are done at the same time and includes the lower dome from 3' above the course 1 and course 2 intersection to barrel.

### **Expansion joint**

11) The expansion joint consists of a lip of double plate that extends from the tank wall into the tank perpendicularly at the barrel-extension interface or at the barrel-upper dome interface. The welds associated with this area must be scanned using the Hawkeye system.

### **Extension** (not present in all tanks)

12) The extension section consists of 4 courses of plates and is approximately 15' in height. This section, if present, is numbered and scanned the same way as the barrel.

**Notes:** The area around the catwalk that is not reachable in the baskets will be scanned at the end of the job from the catwalk. A ladder will be used to reach the rest of the extension area above the catwalk that is out of reach by standing.

\* Additionally, the inside of the manway will be scanned with LFET scanners after the catwalk area.

### **Upper Dome**

#### **Course A**

13) This section is scanned the same way as the barrel. The plate numbering should be much the same as it was for the lower dome.

**Note:** Some tanks have a channel over the welds of the upper dome. If this is the case, U.T. spot checks will be done at the bottom of each vertical channel where they intersect a horizontal channel. No Hawkeye weld scanning will be done since the exposed welds are not structural. The only exception to this will be if wall loss is found around the intersection points of the channels.

#### **Course B**

14) This section is numbered and scanned the same way as course A.

#### **Course C**

15) This section is numbered and scanned the same way as course B. \*

\* Inspection of portions or this entire course will depend on how close the baskets can get to the surface of the tank. Scanning procedure may resort to that of course D.

### **Course D**

16) Scanning of this course depends on how close the boom is able to position the basket to the surface. Traditionally in past inspections, the basket was too far away from the surface to hand scan-using LFET. The alternative was 100% U.T. measurements by using a special designed delivery unit.

### **Course E**

17) Inspection of this course is to be done with the special designed U.T. delivery units.

### **Course F**

18) This course is the top of the tank. Access to this course is by the ladder staircase, which is outside of the tank. This ladder staircase leads up and over to a manhole in the top of the tank. Enter into and down the ladder to the penthouse platform. From this platform, U.T readings will be taken on the 24 plates of the course above you.

### **Pipes**

19) The 18 and 32-inch supply pipes in the lower tunnel under the tank will be U.T. spot-checked. A technician is to crawl into the 32 inch line and take 8 circumferential U.T. readings every 3 feet. The 18-inch line is too small to enter into, so the U.T. readings are taken at 8" and 18", just inside of the pipe. Additional methods may be used such as, Shear Wave Ultrasonics on the welds or special designed LFET scanners for I.D. surface inspections. \*

\* Special designed scanners are a concept at this time and are not included in the price of the inspection



**INTRODUCING THE ULTIMATE ABOVE GROUND STORAGE TANK INSPECTION TOOL -- THE FALCON 2000 MARK II SYSTEM. ENHANCEMENTS MADE TO THE HIGHLY RANKED SYSTEM SUPPORT THE STATEMENT: "THE MOST INNOVATIVE AND COMPLETE TOOL TO DETECT AND QUANTIFY DEFECTS."**

The world's most advanced and compact inspection tool for above ground storage tanks has many new features to enhance inspection capabilities. These improvements are based upon Testex's field experience in testing hundreds of storage tanks, and input from dozens of NDT inspectors from both domestic and international industries.

The Falcon 2000 Mark II System is based on the principles of Low Frequency Electromagnetic Technique (LFET). This system has several advantages over other conventional methods such as magnetic flux leakage (MFL) and ultrasonic testing (UT). No other method or system can compare to the features of the Falcon 2000 Mark II System.



*The Falcon 2000 Mark II System integrated for one man operation*

### **ADVANTAGES AND FEATURES**

- No couplant or magnets required
- Minimal floor preparation
- Tests through coatings
- Maximum penetration up to 1.25" (32mm)
- Scanning speed of 15-20 feet (4.5 - 6m) per minute
- Tests ferrous materials such as carbon steel and cast iron
- Upgradable to test non-ferrous materials such as stainless steel and aluminum
- PC based/Modular electronics using digital signal processing
- Real time data display with advanced signal processing
- Wheel assemblies provide easy maneuverability and independent height adjustment
- Full coverage over scanned area with no "dead space"
- High resolution color graphics with 3-D display
- Uses a maximum voltage of 712V DC inside of tank, meeting required specifications for tank safety
- LEDs with adjustable threshold provide a visual alarm
- Electronic & Software compatibility between Falcon Sr & Jr
- 32 channels -- Falcon Sr.; 16 channels -- Falcon Jr.
- Falcon Jr. specially designed for hard to reach areas

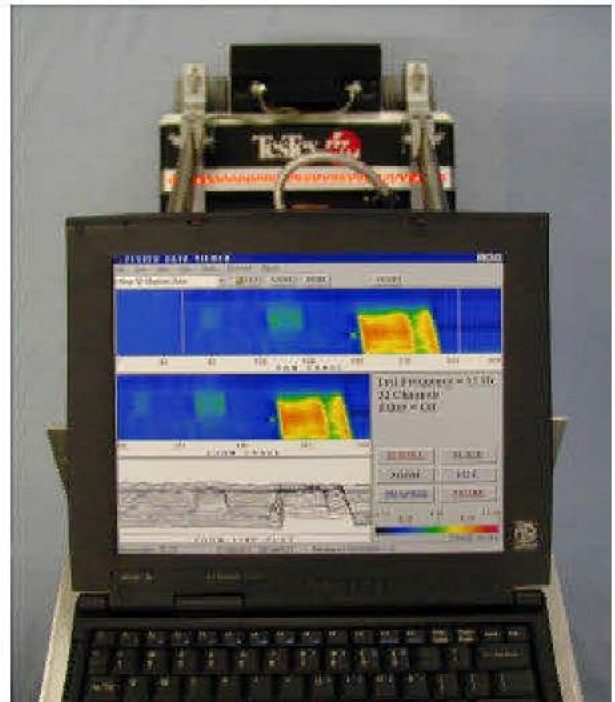

*Operator's view of the Falcon 2000 Mark II System*

**PITTSBURGH (HO)**

Tel: 412-798-8990  
Fax: 412-798-8995  
www.testex-ndt.com

**HOUSTON**

Tel: 713-680-8604  
Fax: 713-680-9469

**SOUTH BEND**

Tel: 574-254-9953  
Fax: 574-254-9961

**ATLANTA**

Tel: 770-323-8903  
Fax: 770-323-8603

**PHILADELPHIA**

Tel: 215-638-4233  
Fax: 215-638-4237

**NEW ORLEANS**

Tel: 504-393-0968  
Fax: 504-393-0762



## NEW DESIGN FEATURES

New features have been added to the original design of the Falcon 2000 System to enhance the capabilities. These enhanced features apply to sensors, electronics, alarm systems, wheels, suspension, maneuverability, total system integration, and software (signal processing, Windows programming, and a newly patented "Quick View" system for easy flaw discrimination).

### Sensors and Electronics

- Higher sample rate for greater resolution of smaller flaws
- Precisely matched sensors assure uniform channel response
- Upgradable to **dual frequency** for topside and bottomside defect discrimination
- Advanced utilization of the **ADSP2101** chip for more in depth, on-line processing
- Upgradable to a **SHARC** (Super Harvard Architecture) **DSP chip** with 160 million instructions per second
- Electronics package with surface mount technology and miniaturized PC boards **inside** floor scanner

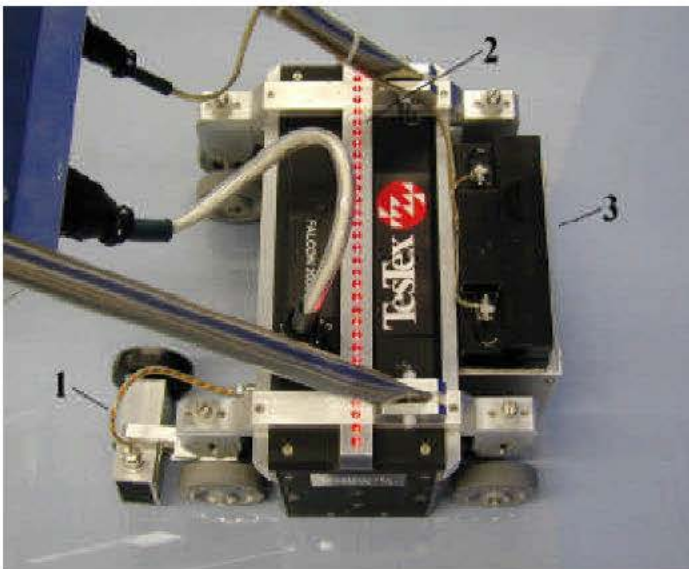

Side view of the Falcon 2000 Mark II Floor Scanner. Showing 1. encoder, 2. recessed threshold alarms, and 3. battery

### Alarm System

- Protected LED Threshold alarms
- Brighter, easier to see alarms
- Alarm indicates when scanner is pushed too fast (to ensure speed control)

### Wheels and Suspension

- **Larger diameter wheels** [3" (6mm)]
- Increased number of wheels (8 wheels)
- **Wider wheel base** for increased stability
- Double wheel axle design for heavily pitted topside and non-level plates
- **Chemically resistant wheels** are designed to suppress vibrations and roll over debris without sustaining damage

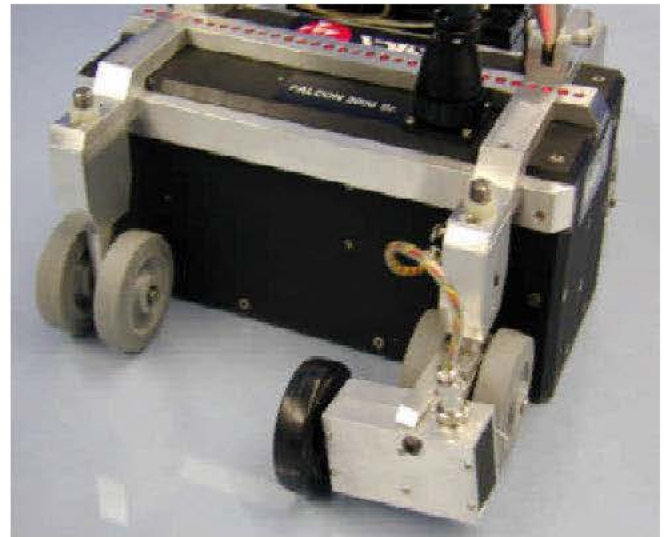

Rear view of the Falcon 2000 Mark II Scanner showing encoder box and double wheel suspension

### Maneuverability and Integration

- Fixed wheels provide more stable and straighter scans
- One piece fixed stainless steel push handle for more control
- Operation by one individual
- Notebook PC mounted to handle

### Software

- **New filters** have been optimized to reduce background noise and enhance flaw signals
- **Patented "Quick View"** feature to simultaneously view phase and amplitude for easy flaw discrimination (see insert for details)
- **Windows based** display program with **embossing** and **3-D rotational view** capabilities

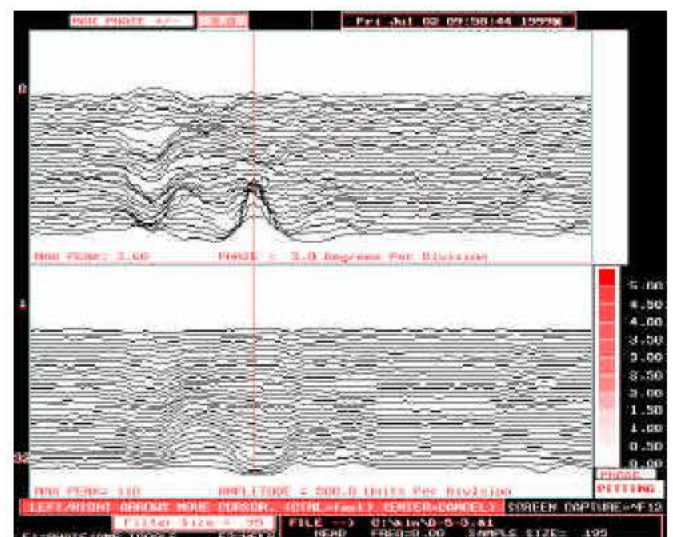

Patented "Quick View" display program showing 32 channels of phase and amplitude simultaneously, using real tank data -- see insert for details



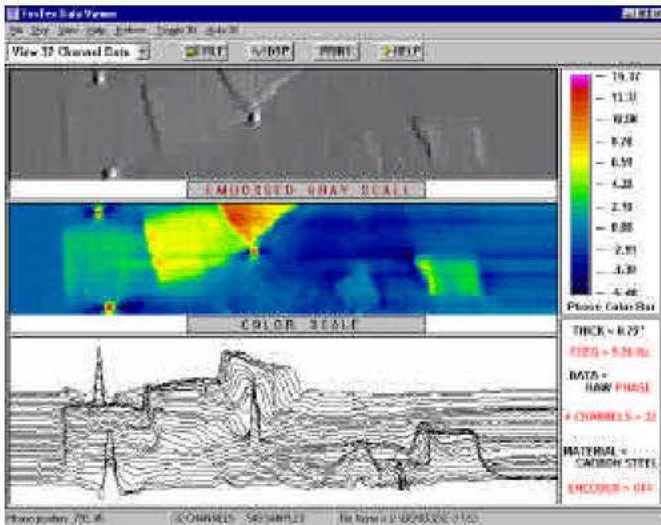

Windows based display program with embossed data. The top screen shows embossed data in grey scale; middle shows color C-Scan view; bottom shows line plot side view for 32 channels.

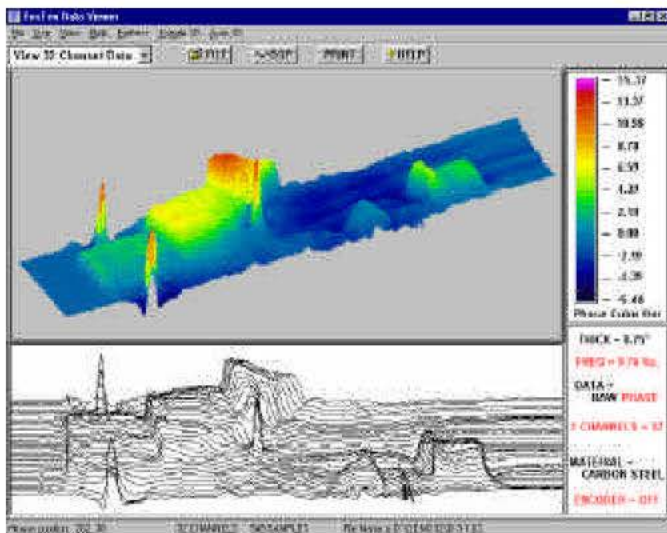

Windows based display program with 3-D rotational image. The top screen shows 3-D rotational image movable with program controls or with mouse; bottom shows line plot side view for 32 channels.

## DETECTION CAPABILITIES

- **Topside and Bottomside** defects evaluated in a single scan using the new dual frequency electronics option
- Detects **1/8" (3mm) diameter** pits 50% deep on 1/4" (6mm) plates
- Detects as low as **5% wall thinning**
- Clearly separates flaws from liftoff signals using the patented "Quick View" software
- Detects flaws through standard **coating** with thicknesses up to 0.200" (5mm) \*

\* Pit/crack resolution may be compromised with thicker coatings

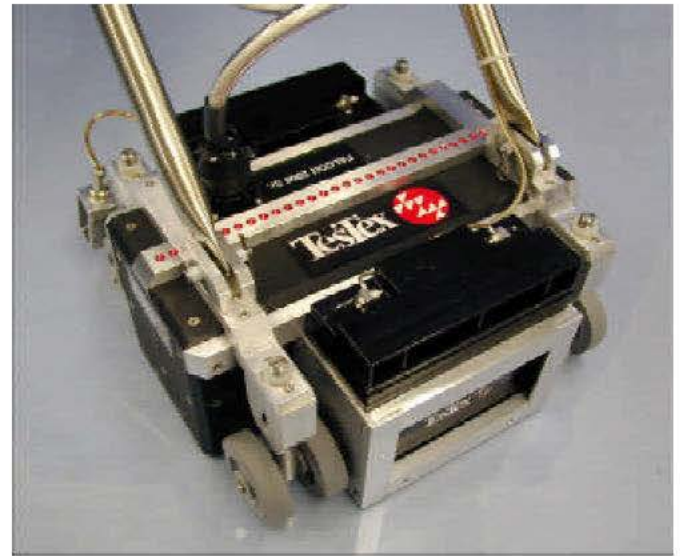

Battery operated system with extra battery pack

## OPTIONS

- **Encoder:** An electronic wheel feeds distance and speed information into the collection and display software for locating and mapping flaws
- **Mapping software:** Takes plate dimensions input by user and draws entire tank floor (with the help of Autocad LT or Turbocad and the encoder data, the software plots each flaw seen by the Falcon System at the corresponding spot on the tank floor where it occurred) -- see insert for details
- **Batteries:** Two 12V batteries provide 10 hours of operation
- **Battery Charger:** A dual battery charger can charge batteries overnight for a full day of power needs
- **Falcon Jr.:** 16 channel hand held scanner with wheels, for hard to reach areas such as sumps, annular rings, roof supports, and buckled areas



The Falcon 2000 Jr. hand held scanner used for hard to reach areas



## SOFTWARE FEATURES

- User friendly menu driven functions
- Special real time signal processing algorithms
- Real time 3-D display in full color
- Rotating view for seeing hidden flaws
- C-scan type overhead view shows defects for easy detection
- Encoder data displayed for distance and location plots
- Digital filtering for signal manipulation while preserving raw data
- Zooming algorithms for detailed views
- Uniquely separates pitting from gradual wall loss or gradual wall loss from pitting, by suppressing one or the other (see insert)
- Shows wall thinning in percent loss or inches/mm remaining

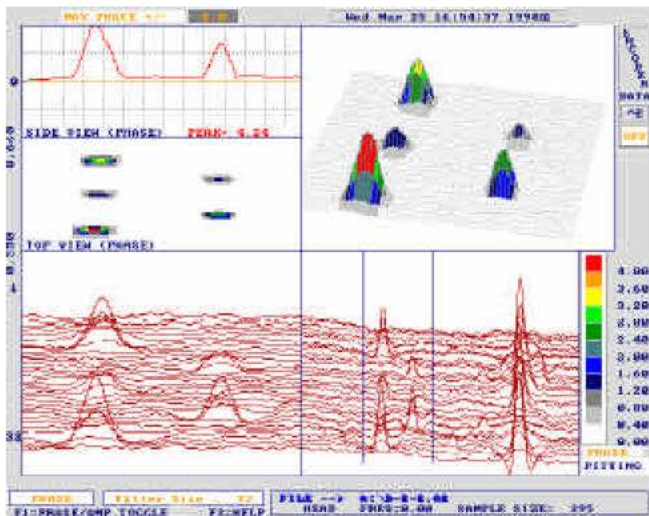

Full screen view of calibration plate data for pits of 1/8" (3mm) to 1/2" dia. (12mm)

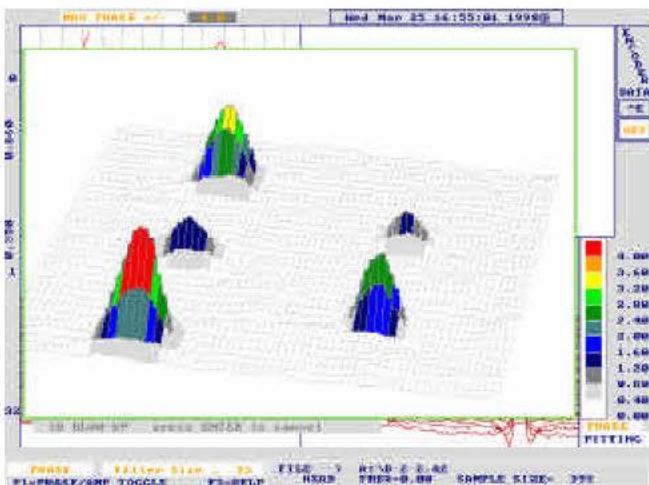

Zoomed up view of calibration data for 5/16" (8mm) pits 75%, 45%, 60% (first row) and 1/4" dia. (6mm) pits 60% and 30% (second row)

## TECHNICAL SPECIFICATIONS

### ELECTRONICS

Electronic Base	Digital/DSP based
Channels	16 or 32
Power Consumption	Max 15VA
Line Voltage	110/220 VAC (self-adjusting) 50/60 Hz or 12 VDC
Dimensions	13" (330mm) L x 11.5" (292mm)W x 3.5" (89mm) H
Weight	5 lbs. (2.27kg)

### SCANNER

Measuring Technique	Low Frequency Electromagnetic Technique (LFET)
Maximum Penetration	0.750" (19mm) Carbon Steel 1.25" (32mm) CrMo or Cast Iron
Number of Sensors/Channels	Sr. 64/32 Jr. 16/16
Inspection Width	Sr. 13" (330mm) Jr. 4" (102mm)
Scanning Speed	15 - 20 ft (4.5 - 6m) per minute
Dimensions	Sr. 13.5" (343mm) L 11.5" (292mm) W 6.5" (165mm) H Jr. 6.5" (165mm) L 4.5" (114mm) W 5.5" (140mm) H
Weight	Sr. 26 lbs. (11.8kg) Jr. 3 lbs. (1.36kg)

### BATTERY PACKS

Number	2
Voltage/Current	12 VDC / 17Ah
Charge Life	10 hours per battery
Charging Time	12 hours
Weight	14.3 lbs.(6.5kg) each

The system is operated using a Pentium II PC through a serial port cable. It is modular and can easily be packed for transport and taken inside the storage tank through a standard size manway.

Above Ground Storage Tank Inspection System available for lease, sale, or service



**PITTSBURGH (HQ)**  
Tel: 412-798-8990  
Fax: 412-798-8995  
www.testex-ndt.com

**HOUSTON**  
Tel: 713-680-8604  
Fax: 713-680-9469

**SOUTH BEND**  
Tel: 574-254-9953  
Fax: 574-254-9961

**ATLANTA**  
Tel: 770-323-8903  
Fax: 770-323-8603

**PHILADELPHIA**  
Tel: 215-638-4233  
Fax: 215-638-4237

**NEW ORLEANS**  
Tel: 504-393-0968  
Fax: 504-393-0762



**A REVOLUTIONARY TECHNIQUE HAS BEEN DEVELOPED FOR THE DETECTION  
OF CRACKS IN WELDS AND OTHER MATERIALS.**

TesTex introduces one of the most innovative systems for the detection and sizing of both surface and sub-surface toe-cracks in welds and base metals. Although the current system and geometric configuration is most suited for the inspection of lap welds in storage tank plates, the system is easily adaptable for the detection of toe-cracks in other welds such as butt, toe, fillet, etc.

This system is based on the eddy current principles of electromagnetic techniques and replaces the old and laborious techniques such as vacuum box, dye penetrant or magnetic particle inspection. The technique is quantitative and gives the depth and length of cracks. Unlike UT, the system does not demand a clean surface and is forgiving to scale, corrosion products, etc. With scanning speeds up to 1 ft./second, the system is fast, accurate and efficient for the evaluation of toe-cracks in welds.

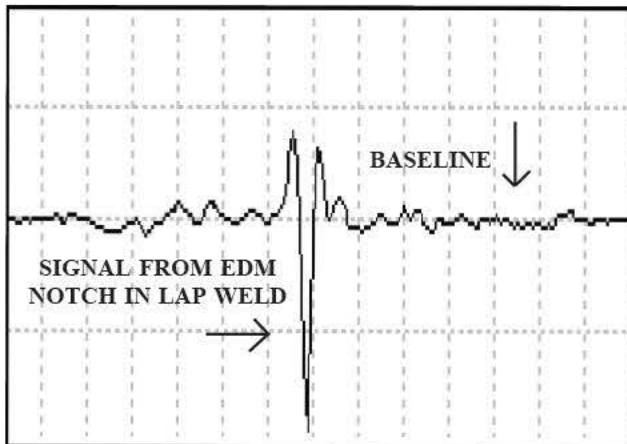

*Flaw signal from a sub-surface 6mm EDM notch incorporated into a lapweld. Plate thickness is 0.375 in. Scanning speed is approximately 1 ft/sec.*

**Advantages**

- Paints/coatings and corrosive products have no impact on flaw signal
- Requires only minimum surface preparation
- Unlike UT, requires no couplant - dry method
- Testing speeds from a few inches/sec to 1 ft./sec
- Elimination of liftoff/noise signals using special algorithms

**Features**

- Realtime display of flaws
- Signals are digitized and stored for future trending purposes
- DSP based electronics platform
- Scanners with various profiles to fit the weld outlines of lap, butt, tee, fillet, etc.
- Enhanced S/N ratio using special noise reduction techniques

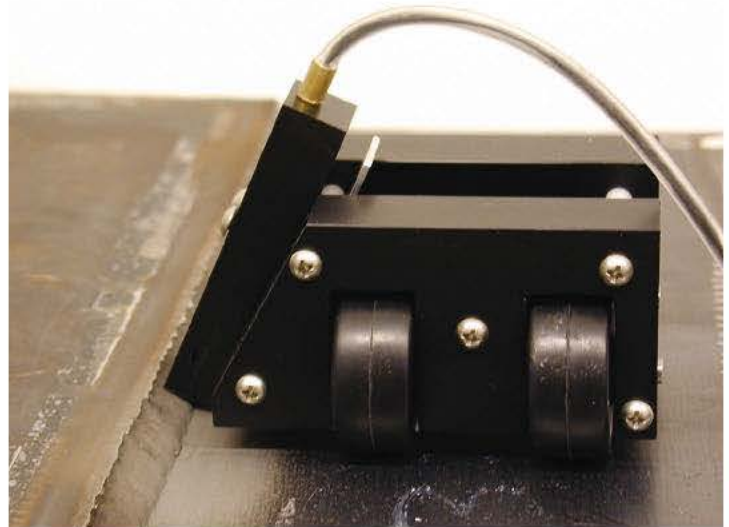

*A lapweld being scanned using the Hawk-Eye 2000*

**Versatility**

- Can be used for different lapweld sizes for 6mm, 9mm and 12mm thick plates
- A single envelope system for 1, 2 or 3 sensors
- Adjustments for sensor orientation
- Separates weld data from heat affected zone data

**System Specifications**

- Works with Falcon Mark II Electronics
- Size 4"(10 cm) x 2"(5 cm) x 3"(7.6 cm), Wt. 1 lb(<0.5kg)
- Channels: Up to 4
- Power: 12VDC or 110/220 VAC

**THE HAWK-EYE 2000 IS AN INTEGRAL PART OF THE TOTAL INSPECTION SYSTEM FOR STORAGE TANKS.**

**PITTSBURGH (HO)**  
Tel: 412-798-8990  
Fax: 412-798-8995  
www.testex-ndt.com

**DOMESTIC**  
**HOUSTON**  
Tel: 713-680-8604

**ATLANTA**  
Tel: 770-323-8903  
**CHI/SOUTH BEND**  
Tel: 574-254-9953

**NEW ORLEANS**  
Tel: 504-393-0968  
**PHILADELPHIA**  
Tel: 215-638-4233

**INTERNATIONAL**  
**U.K. (GRIMSBY)**  
Tel: 1469 541586

**JAPAN**  
Tel: 82 289 6770  
**INDIA**  
Tel: 91 22 55978015

## TesTex Inc.

TesTex is a Non-Destructive Testing (NDT) company founded 22 years ago, based out of Pittsburgh, Pennsylvania. The company has seven domestic branches, five foreign operations, and several licensees around the world staffed with over 250 employees. It has a Research and development department dedicated to serving the specialized needs of the industry. The R&D department has produced several innovative state of the art NDT systems over the years to inspect pipes, storage tanks, boilers, etc. for the refining, petro-chem., chemical, and power industries. One of the biggest strengths of TesTex is its ability to quickly adapt technology to a client's application not only for the best Flaw detection resolution but also for the best possible productivity. The R&D department, with input from the field staff, is always working to improve technology and efficiency. This is evident in the progression of the three previously inspected tanks at RedHill. When Tank 15 began in January 2005, we started using two 4" wide hand scanners to inspect the surface area. By the time the work resumed on Tank 15 in late July of that year, we had developed 8" wide scanners. These scanners weighed the same as the 4" wide scanners and gave double the coverage. For Tank 16, beginning in December 2005, we made an extra two 8" wide scanners and reduced the size of the electronics so that each of the two inspectors in each basket could scan at the same time. This put four 8" wide scanners in use at the same time in the tank. By doing this, the time required to perform the entire inspection of the tank went from 25 days in tank 15 to 20 days in tank 16. This productivity was also carried on to tanks 2 and 20 in 2008.

## LFET THEORY

Low frequency electromagnetic technique (LFET) uses discreet send and receive coils. The send coil or driver coil is excited at a very low frequency (10 hz or less), which creates an AC electromagnetic field. This field propagates into the test material from one side through to the other. In areas with no wall loss, the electromagnetic field will experience a set amount of signal strength loss as shown in first figure below. When the scanner moves across an area with wall thinning, a stronger electromagnetic field is measured as shown in the second figure below.

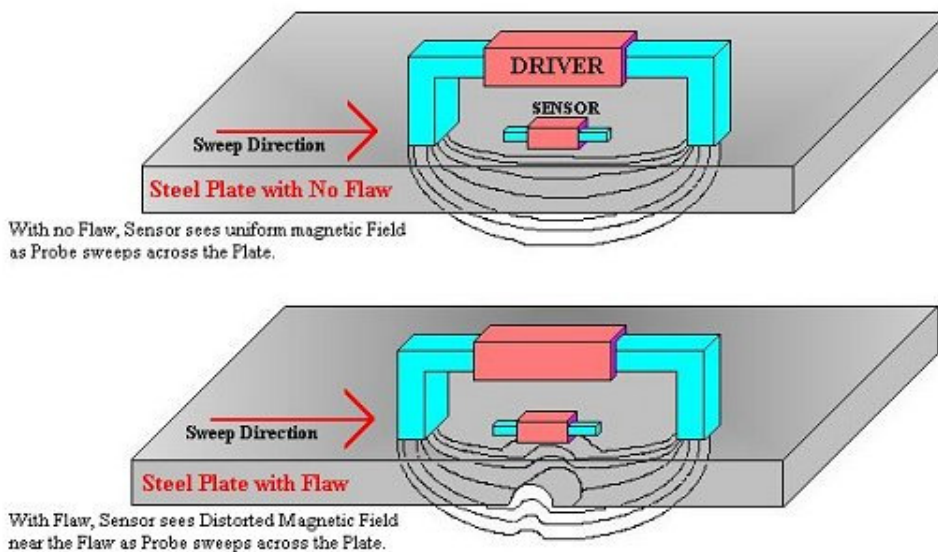



## Sample waveform from tank 16

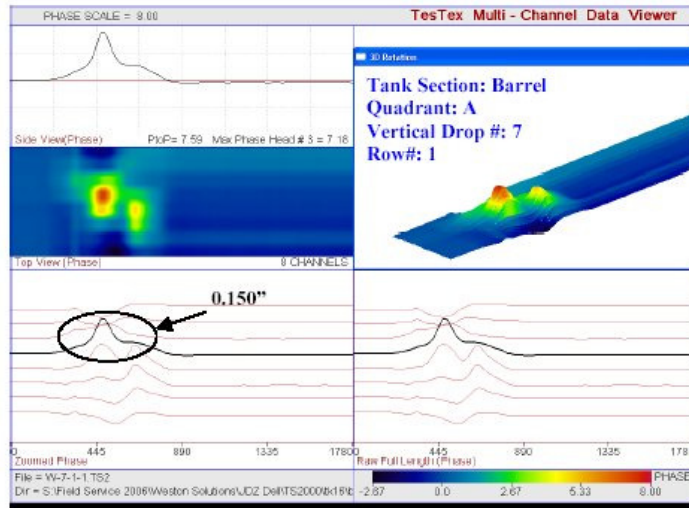

**Flaw # 164:** The waveform above depicts a stock side gouge exhibiting 0.150" wall remaining.

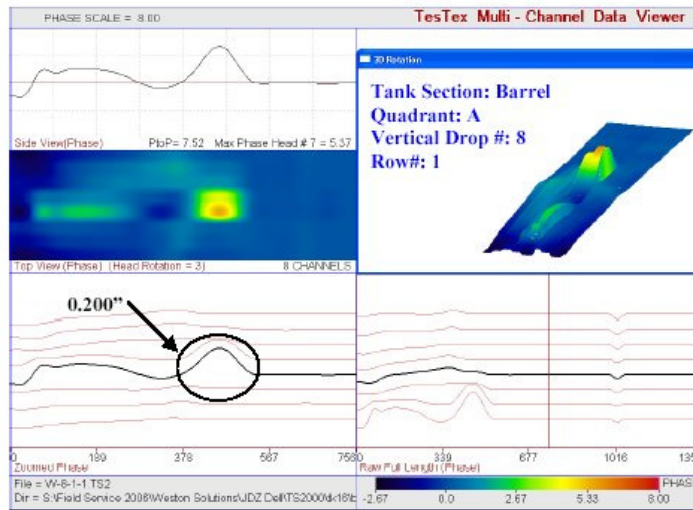

**Flaw # 165:** The waveform above depicts a stock side gouge exhibiting 0.200" wall remaining.

**8" LFET hand scanner**

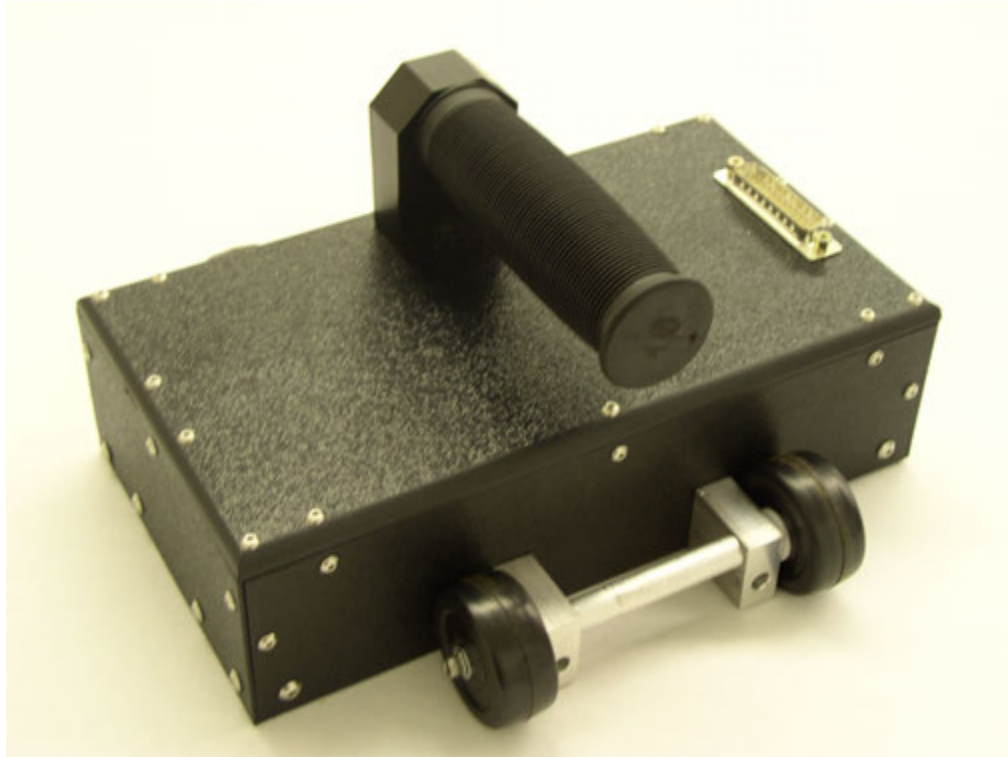

**LFET scanning being performed under the catwalk on the barrel section of Tank 6**





**BFET (Balanced Field Electromagnetic Technique) being performed on a weld seam in Tank 6**



# TesTex





## ET Level II Certification

This is to certify that Larry McDougal has received Electromagnetic Technique Level II training as per SNT-TC-1A 2006 edition and the TesTex Written Practice, and has passed the related examinations. The Electromagnetic Technique certification applies to the following disciplines:

- Remote Field Electromagnetic Technique (RFET)
- Low Frequency Electromagnetic Technique (LFET)

		<i>Examination Scores</i>	
<i>Date of Hire:</i>	<i>August 2, 1992</i>	<i>General:</i>	<i>93.7%</i>
<i>Date of Certification:</i>	<i>September 7, 2001</i>	<i>Specific:</i>	<i>90.1%</i>
<i>Re-Certification:</i>	<i>September 3, 2004</i>	<i>Practical:</i>	<i>95%</i>
<i>Re-Certification:</i>	<i>August 31, 2007</i>	<i>Composite:</i>	<i>92.9%</i>
<i>Expiration Date:</i>	<i>August 31, 2012</i>		

  
\_\_\_\_\_  
TesTex, Inc. Level III

  
\_\_\_\_\_  
Director of Training

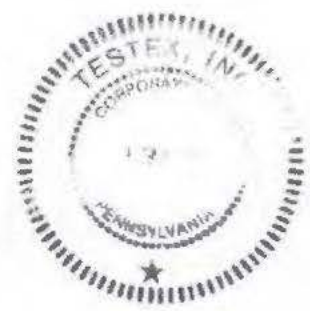



# TesTex



## ET Level II Certification

This is to certify that Jason Tonini has received Electromagnetic Technique Level II training as per SNT-TC-1A 2006 edition and the TesTex Written Practice, and has passed the related examinations. The Electromagnetic Technique certification applies to the following disciplines:

- Eddy Current Technique (ECT)
- Remote Field Electromagnetic Technique (RFET)
- Low Frequency Electromagnetic Technique (LFET)

		<i>Examination Scores</i>	
<i>Date of Hire:</i>	<i>June 10, 2002</i>	<i>General:</i>	<i>92.3%</i>
<i>Date of Certification:</i>	<i>August 22, 2003</i>	<i>Specific:</i>	<i>80.2%</i>
<i>Re-certification:</i>	<i>August 18, 2006</i>	<i>Practical:</i>	<i>100%</i>
<i>Expiration Date:</i>	<i>August 18, 2011</i>	<i>Composite:</i>	<i>90.8%</i>

  
\_\_\_\_\_  
TesTex, Inc. Level III

  
\_\_\_\_\_  
Director of Training



# TesTex



## UT Level II Certification

This is to certify that Jason Tonini has received Ultrasonic Thickness Testing Level II training as per SNT-TC-1A 2006 edition and the TesTex Written Practice, and has passed the related examinations.

		<i>Examination Scores</i>	
<i>Date of Hire:</i>	<i>June 10, 2002</i>	<i>General:</i>	<i>77.5%</i>
<i>Date of Certification:</i>	<i>January 6, 2004</i>	<i>Specific:</i>	<i>88%</i>
<i>Re-Certification:</i>	<i>January 5, 2007</i>	<i>Practical:</i>	<i>84%</i>
<i>Expiration Date:</i>	<i>January 5, 2012</i>	<i>Composite:</i>	<i>83.2%</i>

TesTex, Inc. Level III

Director of Training





# TesTex



## ET Level II Certification

This is to certify that Richard Ornelas has received Electromagnetic Technique Level II training as per SNT-TC-1A 2006 edition and the TesTex Written Practice, and has passed the related examinations. The Electromagnetic Technique certification applies to the following disciplines:

- Eddy Current Technique (ECT)
- Remote Field Electromagnetic Technique (RFET)
- Low Frequency Electromagnetic Technique (LFET)

		Examination Scores	
Date of Hire:	January 3, 2005	General:	80%
Date of Certification:	July 22, 2005	Specific:	78%
Re-Certification:	July 22, 2008	Practical:	100%
Expiration Date:	July 17, 2013	Composite:	86%

  
\_\_\_\_\_  
TesTex, Inc. Level III

  
\_\_\_\_\_  
Director of Training



# TesTex



## UT Level II Certification

This is to certify that Richard Ornelas has received Ultrasonic Thickness Testing Level II training as per SNT-TC-1A 2006 edition and the TesTex Written Practice, and has passed the related examinations.

		<i>Examination Scores</i>	
<i>Date of Hire:</i>	<i>January 3, 2005</i>	<i>General:</i>	<i>72.5%</i>
<i>Date of Certification:</i>	<i>May 13, 2005</i>	<i>Specific:</i>	<i>77%</i>
<i>Re-Certification:</i>	<i>May 13, 2008</i>	<i>Practical:</i>	<i>93%</i>
<i>Expiration Date:</i>	<i>May 13, 2013</i>	<i>Composite:</i>	<i>80.8%</i>

  
\_\_\_\_\_  
*TesTex, Inc. Level III*

  
\_\_\_\_\_  
*Director of Training*





# TesTex



## ET Level II Certification

This is to certify that William Cole has received Electromagnetic Technique Level II training as per SNT-TC-1A 2006 edition and the TesTex Written Practice, and has passed the related examinations. The Electromagnetic Technique certification applies to the following disciplines:

- Eddy Current Technique (ECT)
- Remote Field Electromagnetic Technique (RFET)
- Low Frequency Electromagnetic Technique (LFET)

		<i>Examination Scores</i>	
<i>Date of Hire:</i>	<i>March 5, 2001</i>	<i>General:</i>	<i>80%</i>
<i>Date of Certification:</i>	<i>July 21, 2006</i>	<i>Specific:</i>	<i>81.4%</i>
<i>Expiration Date:</i>	<i>July 21, 2011</i>	<i>Practical:</i>	<i>87.5%</i>
		<i>Composite:</i>	<i>83%</i>

  
\_\_\_\_\_  
*TesTex, Inc. Level III*

  
\_\_\_\_\_  
*Director of Training*



# TesTex



## UT Level II Certification

This is to certify that William Cole has received Ultrasonic Thickness Testing Level II training as per SNT-TC-1A 2006 edition and the TesTex Written Practice, and has passed the related examinations.

		<i>Examination Scores</i>	
<i>Date of Hire:</i>	<i>March 5, 2001</i>	<i>General:</i>	<i>70%</i>
<i>Date of Certification:</i>	<i>September 4, 2007</i>	<i>Specific:</i>	<i>82%</i>
<i>Expiration Date:</i>	<i>September 4, 2012</i>	<i>Practical:</i>	<i>95%</i>
		<i>Composite:</i>	<i>82.3%</i>

  
\_\_\_\_\_  
TesTex, Inc. Level III

  
\_\_\_\_\_  
Director of Training





# TesTex



## ET Level II Certification

This is to certify that ***Jim Parris*** has received Electromagnetic Technique Level II training as per SNT-TC-1A 2006 edition and the TesTex Written Practice, and has passed the related examinations. The Electromagnetic Technique certification applies to the following disciplines:

- Eddy Current Technique (ECT)
- Remote Field Electromagnetic Technique (RFET)
- Low Frequency Electromagnetic Technique (LFET)

		<i>Examination Scores</i>	
<i>Date of Hire:</i>	<i>September 2, 2008</i>	<i>General:</i>	<i>94.3%</i>
<i>Date of Certification:</i>	<i>February 6, 2009</i>	<i>Specific:</i>	<i>88.2%</i>
<i>Expiration Date:</i>	<i>February 6, 2014</i>	<i>Practical:</i>	<i>100%</i>
		<i>Composite:</i>	<i>94.2%</i>

  
\_\_\_\_\_  
*TesTex, Inc. Level III*

  
\_\_\_\_\_  
*Director of Training*



# TesTex



## UT Level II Certification

This is to certify that Jim Parris has received Ultrasonic Thickness Testing Level II training as per SNT-TC-1A 2006 edition and the TesTex Written Practice, and has passed the related examinations.

		<i>Examination Scores</i>	
<i>Date of Hire:</i>	<i>September 2, 2008</i>	<i>General:</i>	<i>70%</i>
<i>Date of Certification:</i>	<i>January 9, 2009</i>	<i>Specific:</i>	<i>85%</i>
<i>Expiration Date:</i>	<i>January 9, 2014</i>	<i>Practical:</i>	<i>90%</i>
		<i>Composite:</i>	<i>81.7%</i>

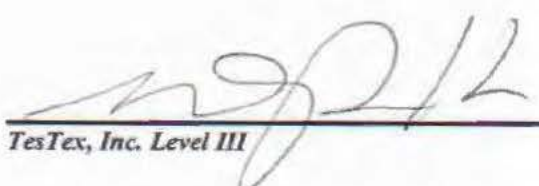
  
\_\_\_\_\_  
*TesTex, Inc. Level III*

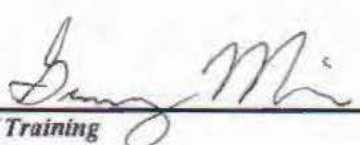
  
\_\_\_\_\_  
*Director of Training*







Baker Inspection Group, LLC  
413 Applegrove Street NW, Suite 100  
North Canton, Ohio 44720

## NDE PERSONNEL CERTIFICATION RECORD

This is to certify that Jeff Miller

Employee Number 029

has satisfactorily completed the Education, Training, and Experience requirements as outlined in Baker Inspection Group's Written Practice, NDT 001, Procedure for Qualification and Certification of Nondestructive Testing Personnel and is hereby considered in the following disciplines:

DISCIPLINE	LEVEL	ORIGINAL CERT. DATE	RE-CERTIFICATION DATE
Liquid Penetrant (PT)	II	10 January 2008	09 January 2013
Magnetic Particle (MT)	II	10 January 2008	09 January 2013
Ultrasonic (UT)	II	13 January 2008	12 January 2013
Visual (VT)	II	January 2006	January 2011
AWS CWI		January 2009	January 2012
AWS CWE		August 2008	August 2012

Any restrictions placed upon this/these certification(s) will be indicated on Certification Record

\*\* LEVEL I & LEVEL II RECERTIFICATION IS DUE FIVE (5) YEARS FROM THE ABOVE DATE(S).

LEVEL III RECERTIFICATION IS DUE FIVE (5) YEARS FROM THE ABOVE DATE(S).

Joe Wolfe  
ASNT Level III Certification # 104186

Holley Baker  
President/CEO

**REMARKS:** Current Eye Tests Furnished Upon Request

Formerly certified by Law Engineering, Inc. under previous company ownership

# Baker Inspection Group, LLC.

hereby certifies that

**Jeff Miller.**

has met the training, experience and testing requirements of SNT-TC-1A for the Ultrasonic Method.

01/13/2008

Certification Date

01/13/2011

Re-Certification Due Date

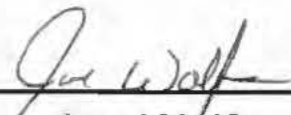

Joe Wolfe

Company Level III

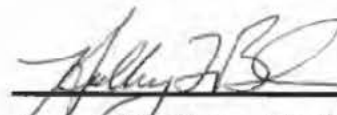

Holley Baker

President / CEO





**WILLBROS GOVERNMENT SERVICES (U.S.), LLC**

A WILLBROS COMPANY

# NON-DESTRUCTIVE TESTING PROCEDURE

## MT-1

## MAGNETIC PARTICLE INSPECTION

### BY

### PROD TECHNIQUE VISIBLE LIGHT DRY POWDER METHOD

Revision 1: Dated November 11, 2005

Rev	Description	Reviewed	Approved
0	Approved	IQC	DG
1	General	IQC	DG
2			
3			
4			
5			

**Magnetic Particle Examination  
Revision 1 – Dated November 11, 2005**

**Table of Contents  
Prod Technique  
Visible Light  
Dry Powder Method**

- I. Introduction**
- II. Scope**
- III. Applicable Reference Specifications**
- IV. Surface Conditions**
  - 4.1 As Welded**
  - 4.2 Dirt, Grease & Lent**
  - 4.3 Cleaning**
- V. Inspection Method**
- VI. Inspection Technique (Prod)**
- VII. Calibration**
- VIII. Application of Inspection**
  - 8.1 Source of Current**
  - 8.2 Equipment**
  - 8.3 Iron Powder**
  - 8.4 Inspection Sequence**
- IX. \*Evaluation**
- X. Precautions**
- XI. Demagnetization**
- XII. Final Cleaning**
- XIII. Reports**
- XIV. \*Acceptance/Rejection Standards**
- XV. Certification of Competence for NDE Personnel**



**Magnetic Particle Examination  
Visible Light  
Dry Powder Method**

**I. Introduction**

The magnetic particle examination method may be applied to detect cracks and other discontinuities on or near the surface of ferromagnetic materials. The sensitivity is greater for surface discontinuities and diminishes rapidly with increasing depth of subsurface discontinuities below the surface. Typical types of discontinuities that can be detected by this method are cracks, laps, seams, cold shuts, and lamination.

**II. Scope**

Magnetic Particle Inspection shall be considered as a means to detect only surface or near surface discontinuities. Sensitivity is greatest for surface discontinuities and diminishes rapidly with depth below the surface. The effective depth for near surface discontinuities is controlled by many variables such a shape, material, surface finish, prod spacing. Magnetic particle examination should not be used for locating discontinuities more than 1/2” below the surface.

**III. Applicable Reference Specifications**

ASME CODE, SECTION V      Nondestructive Examination

ASTM A275                      Magnetic Particle Examination and  
Inspection of Heavy Steel Forgings

ASTM E709	Standard Recommended Practice for Magnetic Particle Examination
ASME CODE, SECTION VIII	Boiler and Pressure Vessel Code, Div. 1
MIL-I-6868	Military Specification Magnetic Particle Examination

#### IV. **Surface Conditions**

- 4.1 As Welded - Satisfactory results are usually obtained when the surfaces are in the as welded, as rolled, as cast, or as forged condition. However, surface preparation by grinding or machining may be necessary where surface irregularities could mask indications due to discontinuities.
- 4.2 Dirt, Grease, Lint, Etc. – Prior to Magnetic Particle Examination the surface to be examined and all adjacent areas within at least 1” shall be dry and free of all dirt, grease, lint, scale, welding flux and spatter, oil or other extraneous matter that could interfere with the examination.
- 4.3 Cleaning – Cleaning may be accomplished using detergents, organic solvent, descaling solutions, paint remover, vapor degreasing, sand or grit blasting, or ultrasonic cleaning method.

#### V. **Inspection Method**

Examination shall be done by the continuous method; that is, the magnetizing current remains on while the examination medium is being applied and while excess of the examination medium is being removed.



## **VI. Inspection Technique (Prod)**

The prod electrodes (generally solid copper or braided copper tips) are first pressed firmly against the test part. The magnetizing current is then passed through the prods and into the area of the part in contact with the prods. This establishes a circular magnetic field in the part around and between each prod electrode, sufficient to carry out a local magnetic particle examination. Half-wave rectified direct current shall be used since it will detect both surface and near surface discontinuities. This prod technique utilizes dry magnetic particle materials due to better particle mobility. Proper prod examination entails a second placement with the prods rotated approximately 90 degrees from the first placement to assure that all existing discontinuities are revealed. Depending on the surface coverage requirements, overlap between successive prod placements may be necessary. Caution: Extreme care should be taken to maintain clean prod tips, to minimize heating at the point of contact and to prevent arc strikes and local overheating on the surface being examined since these may cause adverse effects on material properties. Steel or aluminum or copper braided tip prods, or pads rather than the solid copper tip prods are recommended where the possibility of copper penetration exists. Open-circuit voltages should not exceed 25V. A remote-control switch, which may be built into the prod handles, shall be provided to permit the current to be turned on after the prods have been properly placed and to turn it off before the prods are removed in order to minimize arcing.

## **VII. Calibration Frequency**

- 7.1 Each piece of magnetizing equipment shall be calibrated every six months or when the equipment has been subject to major electric repair, periodic overhaul, or damage.

## **VIII. Application of Inspection**

- 8.1 Solid prods or other contact devices shall be used for localized circular magnetization when inspecting with portable equipment over large areas such as castings, welds, wrought, and forged surface.
- 8.2 Magnetic particle inspection should not be performed at temperatures above 600°F.
- 8.3 Iron Powder – Iron powder shall be gray or red dry magnetic particle (Magnaflux 1-gray or 8A-red). All particles shall have high permeability to allow ease of magnetizing and attraction to the discontinuities and low retentivity so they will not be attracted to each other. 8A-red becomes sticky and loses color above 325°F.
- 8.4 Inspection Sequence
- 8.4.1 First, the prods or contacts shall be placed on the centerline of the area to be inspected. The distance between prods or contacts shall not exceed 8". Conversely prod spacing less than 3" is not recommended due to banding of the particles around the prod.



- 8.4.2 Half-Wave Rectified direct current should be used. The current shall be 100 (minimum) to 126 (maximum) amp/in. of prod spacing for sections  $\frac{3}{4}$ " thick or greater. For sections less than  $\frac{3}{4}$ ", the current shall be 90 to 110 amp/in. of prod spacing.
- 8.4.3 Apply powder over the area and hold prods or contacts on the surface.
- 8.4.4 Remove excess iron powder by blowing dry air over the area while the current is on and the prods or other contacts are in place. A small air bank syringe or air pressure at approximately 1 to 2 psi shall be used for this purpose.
- 8.4.5 Interpretation of Indications – Shall be made with the magnetizing current on and a minimum 100 ft/candle light source.
- 8.4.6 Repeat steps at 90 degrees to the centerline.
- 8.4.7 Direction of Magnetization – At least two separate examinations shall be performed on each area. During the second examination, the lines of magnetic flux shall be approximately perpendicular to those used during the first examination.
- 8.4.8 Examination Coverage – All examinations shall be conducted with sufficient overlap to assure 100% coverage.
- 8.4.9 Magnetizing Field Adequacy – When it is necessary to verify the adequate direction of the magnetizing field, the magnetic

particle field indicator shall be used by positioning the indicator on the surface to be examined. When using the indicator, a suitable flux or field strength is indicated when a clearly defined line of magnetic particles forms across the cooper face of the indicator when the magnetic particles are applied simultaneously with the magnetizing force.

## **IX. Evaluation**

- 9.1 All valid indications formed by magnetic particle examination are the result of magnetic flux leakage fields. Indications may be relevant or nonrelevant. Indications caused by particles being held by nonmagnetic forces are false. Examples include particles lying in the depression at the side of a weld, or particles wedged into rust or scale on the surface.
- 9.2 Relevant indications are produced by flux leakage fields, which are the result of discontinuities that may or may not be acceptable. Relevant indications should be evaluated with regard to the applicable standards or Code agreed upon between the manufacturer and the purchaser.
- 9.3 Nonrelevant indications can occur singularly or in patterns as a result of flux leakage fields created by conditions such as changes in section, inherent material properties, etc. or may be associated with a discontinuity which is not considered detrimental to the part.



## **X. Precautions**

Precautions for personnel safety, possible material damage, and misinterpretation of discontinuities shall be:

- 10.1 The prods shall be placed in firm contact with the surface prior to applying current in order to prevent injury to the operators' eyes by arc flashes. When initially applying the current, the operator shall turn his head away from the prod.
- 10.2 Magnetizing Procedures – For the prod technique, magnetization is accomplished by portable prod type electrical contacts pressed against the surface in the area to be examined. To avoid arcing, a remote control switch, which may be built into the prod handles, shall be provided to permit the current to be turned on after the prod has been properly positioned.
- 10.3 A dust mask should be worn when there is a possibility of inhaling dry magnetic powder.
- 10.4 Continuous circular lines of iron powder will be found adjacent to and concentric with the prods. These lines shall be interpreted as nonrelevant.
- 10.5 Nonrelevant or false indications often appear but are usually able to be identified.
  - 10.5.1 Line like indications may appear at the junction of two metals of different permeability or at the boundary of the weld and base metal or in a material with a banded microstructure.

10.5.2 Cold worked surface will often develop broad indications if there is an abrupt change in permeability.

10.5.3 Flow from forging or rolling will appear as many groups of parallel indications caused by magnetization far beyond that required for flaw location.

10.5.4 Broad areas of particle accumulation, which might mask indications from discontinuities, are prohibited and such areas will be cleaned and reexamined.

**XI. Demagnetization**

When residual magnetism in the part could interfere with subsequent processing or usage, the part shall be demagnetized any time after completion of examination. ASME CODE, SECTION V, SE709 1983

**XII. Final Cleaning**

When required in the applicable Customer's specification and/or code, the surface shall be cleaned so that iron powder is completely removed after inspection.

**XIII. Reports**

A detailed Magnetic Particle inspection report shall be prepared: See Example.



#### **XIV. Acceptance Standards**

Any indications of an imperfection, which is believed to be nonrelevant, shall be regarded as a defect unless on reevaluation it is shown by reexamination by the same method or by the use of other nondestructive methods, and/or by surface conditioning that no unacceptable discontinuities are present.

14.1 Examination of Areas from which defects have been removed. After a defect is thought to have been removed, and prior to making weld repairs, the area shall be

14.2 Unacceptable defects and repairs requirements

Where a discontinuity is removed by chipping or grinding, and subsequent welding is not necessary, care shall be taken to contour the surface so as to eliminate any sharp notches or corners. When a defect appears to be removed, the area shall be reexamined by the same method to verify that it has removed completely. If repairs are made, the repaired area shall be examined by the same method.

14.3 Treatment of Imperfections believed nonrelevant

Any rejectable indication, which is believed to be nonrelevant, shall be reevaluated by the same method or by the use of other nondestructive methods, and/or by surface conditioning to prove that no unacceptable discontinuities are present.

14.4 Re-examination of repair areas.

After repairs have been made, the repair area shall be blended into the

surrounding surface so as to avoid sharp notches, crevices, or corners and re-examined by the magnetic particle method.

**XV. Certification of Competence for NDE Personnel**

NDE Level II shall perform evaluation of Magnetic Particle Examination.





**WILLBROS GOVERNMENT SERVICES (U.S.), LLC**

A WILLBROS COMPANY

# NON-DESTRUCTIVE TESTING PROCEDURE

## MT-2

## MAGNETIC PARTICLE INSPECTION

## BY

## YOKE TECHNIQUE VISIBLE LIGHT DRY POWDER METHOD

Dated November 11, 2005

Rev	Description	Reviewed	Approved
0	Approved	IQC	DG
1			
2			
3			
4			
5			

**Magnetic Particle Examination  
Dated November 11, 2005**

**Table of Contents  
Yoke Technique  
Visible Light  
Dry Powder Method**

- I. Introduction**
- II. Scope**
- III. Applicable Reference Specifications**
- IV. Surface Conditions**
  - 4.1 As Welded**
  - 4.2 Dirt, Grease & Lent**
  - 4.3 Cleaning**
- V. Inspection Method**
- VI. Inspection Technique**
- VII. Calibration**
- VIII. Application of Inspection**
  - 8.1 Source of Current**
  - 8.2 Equipment**
  - 8.3 Iron Powder**
  - 8.4 Inspection Sequence**
- IX. \*Evaluation**
- X. Precautions**
- XI. Demagnetization**
- XII. Final Cleaning**
- XIII. Reports**
- XIV. \*Acceptance/Rejection Standards**
- XV. Certification of Competence for NDE Personnel**



**Magnetic Particle Examination  
Yoke Technique  
Dry Powder Method**

**I. Introduction**

Alternating Current (AC) magnetic particle examination method may be applied to detect cracks and other discontinuities on or near the surface of ferromagnetic materials. Typical types of discontinuities that can be detected by this method are cracks, laps, seams, cold shuts, and lamination.

**II. Scope**

The visible light dry powder magnetic particle examination method shall be used to detect surface or near surface discontinuities. Sensitivity is greatest for surface discontinuities and diminishes rapidly with depth below the surface. AC magnetic particle examination should only be used for locating discontinuities open to the surface.

Applicable Reference Specifications

ASME CODE, SECTION V	Nondestructive Examination
ASTM A275	Magnetic Particle Examination and Inspection of Heavy Steel Forgings
ASTM E709	Standard Recommended Practice for Magnetic Particle Examination
ASME CODE, SECTION VIII	Boiler and Pressure Vessel Code, Div. 1
MIL-I-6868	Military Specification Magnetic Particle Examination

### **III. Surface Conditions**

3.1 As Welded satisfactory results are usually obtained when the surfaces are in the as welded, as rolled, as cast, or as forged condition.

However, surface preparation by grinding or machining may be necessary where surface irregularities could mask indications due to discontinuities.

3.2 Dirt, Grease, Lint, Etc. – Prior to Magnetic Particle Examination the surface to be examined and all adjacent areas within at least 1” shall be dry and free of all dirt, grease, lint, scale, welding flux and spatter, oil or other extraneous matter that could interfere with the examination.

3.3 Cleaning – Cleaning may be accomplished using detergents, organic solvent, descaling solutions, paint remover, vapor degreasing, sand or grit blasting, or ultrasonic cleaning method.

### **IV. Inspection Method**

Examination shall be done by the continuous method; that is, the magnetizing current remains on while the examination medium is being applied and while excess examination medium is being removed.

### **V. Inspection Technique**

The poles are first pressed against the test part. When the AC yoke is energized, a longitudinal magnetic field is induced in the part between the poles sufficient to carry out a local magnetic particle examination. This yoke



technique generally utilizes dry magnetic particle materials due to better particle mobility. Proper yoke examination entails a second placement with the yoke rotated approximately 90 degrees from the first placement to assure that all existing discontinuities are revealed. Depending on the surface coverage requirements, overlap between successive yoke placements may be necessary.

## **VI. Calibration Frequency**

- 6.1 Each piece of magnetizing equipment shall be calibrated every six months or when the equipment has been subject to major electric repair, periodic overhaul, or damage.
- 6.2 The AC electromagnetic yoke shall have a lifting force of at least 10 lb. At a pole spacing of 2 to 4 inches and shall be checked with a 10 lb steel weight.

## **VII. Application of Inspection**

- 7.1 An AC yoke shall be used for localized longitudinal magnetization when inspecting with portable equipment over large areas such as castings, welds, wrought, and forged surface.
- 7.2 Magnetic particle inspection should not be performed at temperatures above 600°F.
- 7.3 Iron Powder – Iron powder shall be a gray or red dry magnetic particle (Magnaflux 1-gray or 8A-red). All particles shall have high

permeability to allow ease of magnetizing and attraction to the discontinuities and low retentivity so they will not be attracted to each other. 8A-red becomes sticky and loses color above 325°F

#### 7.4 Inspection Sequence

7.4.1 Pole spacing for the yoke will be from 3 inches minimum to 6 inches maximum.

7.4.2 While keeping the yoke energized, spray or dust powder over the area between the poles.

7.4.3 Remove excess iron powder by blowing dry air over the area while the current is on and the poles in place. A small air bank syringe or air pressure at approximately 1 to 2 psi shall be used for this purpose.

7.4.4 Interpretation of Indications - Shall be made with the magnetizing current on and a minimum 100 ft/candle light source.

7.4.5 Repeat steps at 90 degrees to the centerline.

7.4.6 Direction of Magnetization – At least two separate examinations shall be performed on each area. During the second examination, the lines of magnetic flux shall be approximately perpendicular to those used during the first examination.

7.4.7 Examination Coverage – All examinations shall be conducted with sufficient overlap to assure 100% coverage.



7.4.8 Magnetizing Field Adequacy – When it is necessary to verify the adequate direction of the magnetizing field, the magnetic particle field indicator shall be used by positioning the indicator on the surface to be examined. When using the indicator, a suitable flux or field strength is indicated when a clearly defined line of magnetic particles forms across the copper face of the indicator when the magnetic particles are applied simultaneously with the magnetizing force.

## **VIII. Evaluation**

- 8.1 All valid indications formed by magnetic particle examination are the result of magnetic flux leakage fields. Indications may be relevant or nonrelevant. Indications caused by particles being held by nonmagnetic forces are false. Examples include particles lying in the depression at the side of a weld, or particles wedged into rust or scale on the surface.
- 8.2 Flux leakage fields that are the result of discontinuities that may or may not be acceptable produce relevant indications. Relevant indications should be evaluated with regard to the applicable standard or Code agreed upon between the manufacturer and the purchaser.
- 8.3 Nonrelevant indications can occur singly or in patterns as a result of flux leakage fields created by conditions such as changes in section,

inherent material properties, etc. or may be associated with a discontinuity which is not considered detrimental to the part.

## **IX. Precautions**

Precautions for personnel safety and misinterpretation of discontinuities shall be:

- 9.1 A dust mask should be worn when there is a possibility of inhaling dry magnetic powder.
- 9.2 Nonrelevant or false indications often appear but are usually able to be identified.
  - 9.2.1 Line like indications may appear at the junction of two metals of different permeability or at the boundary of the weld and base metal or in a material with a banded microstructure.
  - 9.2.2 Cold worked surface will often develop broad indications if there is an abrupt change in permeability.
  - 9.2.3 Flow from forging or rolling will appear as many groups of parallel indications caused by magnetization far beyond that required for flaw location.
  - 9.2.4 Broad areas of particle accumulation, which might mask indications from discontinuities, are prohibited and such areas will be cleaned and reexamined.



**X. Demagnetization**

When residual magnetism in the part could interfere with subsequent processing or usage, the part shall be demagnetized by one of the methods in ASME CODE, SECTION V, SE709.

**XI. Final Cleaning**

When required in the applicable Customer's specification and/or code, the surface shall be cleaned so that iron powder is completely removed after inspection.

**XII. Reports**

A detailed Magnetic Particle inspection report shall be prepared: See Example.

**XIII. Acceptance Standards**

13.1 Unacceptable defects and repairs requirements.

Where a discontinuity is removed by chipping or grinding, and subsequent welding is not necessary, care shall be taken to contour the surface to eliminate any sharp notches or corners. When a defect appears to be removed, the area shall be reexamined by the same method to verify that it has been removed completely. If repairs are made, the repaired area shall be examined by the same method.

14.2 Treatment of Imperfections believed nonrelevant

Any rejectable indication, which is believed to be nonrelevant, shall be reevaluated by the same method or by the use of other nondestructive methods, and/or by surface conditioning to prove that no unacceptable discontinuities are present.

14.3 Examination of Areas from which defects have been removed.

After a defect is thought to have been removed, and prior to making weld repairs, the area shall be examined by suitable methods to ensure that the defect has been eliminated.

14.4 Re-examination of repair areas

After repairs have been made, the repair area shall be blended into the surrounding surface so as to avoid sharp notches, crevices, or corners and re-examined by the magnetic particle method and by all other methods of examination that were originally required for the affected area.

**XIV. Certification of Competence for NDE Personnel**

NDE Level II shall perform evaluation of Magnetic Particle Examination.





**WILLBROS GOVERNMENT SERVICES (U.S.), LLC**

A WILLBROS COMPANY

# NON-DESTRUCTIVE TESTING PROCEDURE

## PT-1

## LIQUID PENETRANT INSPECTION

## BY

## VISIBLE DYE METHOD

Revision 4: Dated October 22, 2007

Rev	Description	Reviewed	Approved
0	Approved	IQC	DG
1	General	IQC	DG
2	General	IQC	DG
3	General	IQC	DG
4	General	IQC	DG
5			

**NON-DESTRUCTIVE TESTING PROCEDURE  
PT-1  
LIQUID PENETRANT INSPECTION BY  
VISIBLE DYE METHOD  
SOLVENT REMOVAL**

**CONTENTS**

	<u>Paragraph</u>
Scope .....	1
Applicability .....	2
Procedure Qualification.....	3
Identification.....	4
Procedure .....	5
*Inspection .....	6
*Interpretation .....	7
*Acceptance Criteria .....	8
Repair Indications .....	9
Post Cleaning.....	10
Reports.....	11
Qualification.....	12
Certification.....	13
Exhibits	



## 1.0 SCOPE

This procedure describes the Visible Dye Penetrant examination utilizing the Solvent-removable process as performed by Integrated Service Company L.L.C.

This method of nondestructive examination provides for the detection of discontinuities open to the surface in ferrous and non-ferrous materials, which are non-porous.

Typical discontinuities detectable by this method are cracks, seams, laps, cold shuts, laminations, surface porosity, and lack of fusion.

This procedure is in accordance with the applicable requirements of ASME Section V, Article 6; Section VIII, Div. 1, Appendix 8, and Section I, Appendix A-270.

## 2.0 APPLICABILITY

This procedure governs all Solvent-Removable Visible Dye Liquid Penetrant examinations performed by Integrated Service Company L.L.C. Inspectors.

All outside testing services and laboratories utilizing Solvent-Removable Visible Dye Liquid Penetrant methods shall abide by this procedure. Alternate or substitute procedures must be submitted to Integrated Service Company L.L.C. for approval.

Liquid penetrant examination is performed on longitudinal weld seams, girth weld seams, overlays, flame cut plate and finished machined surfaces. (Non-essential variable)

## 3.0 PROCEDURE QUALIFICATION

When procedure qualification is specified, a change of a requirement in ASME Section V Table T-621 identified as an essential variable from the specified value, or range of values, shall require requalification of this written procedure. Where a range is specified for an essential variable, the bounding values of the range shall be qualified by demonstration. A change of a requirement identified as a nonessential variable from the specified value, or range of values, does not require requalification of the written procedure. All changes of essential or nonessential variables from the value, or range of values, specified by the written procedure shall require revision of, or an addendum to, the written procedure.

#### 4.0 IDENTIFICATION

Integrated Service Company L.L.C. Inspectors will use the following family of materials for the standard method.

The dye penetrant will be Magnaflux Spotcheck SKL-SP1 or Sherwin Dubl-Chek DP-40 / DP-51.

The cleaner / remover will be Magnaflux Spotcheck SKC-S or Sherwin Dubl-Chek DR-60.

The developer will be Magnaflux Spotcheck SKD-S2 or Sherwin Dubl-Chek D-100.

#### 5.0 PROCEDURE

Color contrast penetrant inspections may be performed on a component at any point in processing, but normally after the final heat treatment or stress relieving.

##### Preparation (Essential variable)

All material surfaces to be examined must be free of all rust, splatter, scale, grease, paint, oily films and dirt. Any of these contaminants can prevent the penetrant from entering surface defects.

If only a section of a part, such as a weld, is to be inspected, the adjacent area within one inch of the surface to be inspected must also be cleaned.

Material surfaces must have a finish, which will permit proper interpretation of developed indications. The surface shall be even with no abrupt ridges or valleys. The shape and size of objects to be examined are not limiting factors, provided the specified area under examination can be properly examined within the specified time intervals of this procedure.

The material surface will be cleaned using Magnaflux Spotcheck SKC-S or Sherwin Dubl-Chek DR-60.

Parts must be completely dry prior to penetrant application. Permit five minutes elapsed time for evaporation after cleaning with solvent / cleaner.

Grit or sandblasting prior to the examination is not permitted.

Flame cut edges shall have scale removed prior to cleaning.

The part will be warmed or allowed to cool to a temperature within the range of 50 degrees F to 125 degrees F. When it is not practical to conduct an examination with these temperature limits, qualify the procedure at the temperature of intended use as described in ASME Sec.V, Art. 6, T-653 using the Eishin Crack Panels. Another family of materials may be required.

### Application of Dye Penetrant (Essential variable)

Application of the dye penetrant shall be by aerosol spray or brush.

Hold the can nozzle six to twelve inches from the area to be sprayed. Spray the penetrant on the surface so that the entire part or the area under inspection is completely covered with penetrant.

If the part is stationary, move the spray over the entire surface to be inspected. The spray may be held stationary and the part moved through it if the part is mounted on a rotating machine.

### Penetration (Dwell) Time (Essential variable)

The surface must remain wetted for a period of not less than 10 minutes. If the penetrant dries within this time, remove it and start again. Do not leave the penetrant on longer than thirty minutes.

### Excess Penetrant Removal (Essential variable)

After the penetrant has been on the surface to be inspected for the prescribed period of time, all excess penetrant shall be removed from these surfaces by the following steps.

1. Remove excess penetrant by wiping with a clean, lint-free material, repeating the operation until most traces of penetrant have been removed.
2. The remaining traces shall be removed by wiping the surface with a clean, lint-free material lightly moistened with cleaner / remover.

To minimize removal of penetrant from discontinuities, care shall be taken to avoid the use of excess solvent. Flushing the surface with remover, following the application of the penetrant, and prior to developing is prohibited.

### Drying After Excess Penetrant Removal (Essential variable)

The surfaces may be dried by normal evaporation, blotting, wiping or forced air. Parts must be completely dry prior to developer application. Permit five minutes elapsed time for evaporation.

### Application of Wet Developer (Essential variable)

The developer shall be applied by aerosol spray as soon as possible after penetrant removal. Shake the can thoroughly and spray short spurts to clear the spray valve. The time interval between penetrant application and the application of the developer shall not exceed 30 minutes.



Spray the area to be inspected with a thin, even coat. The proper developer thickness will dry to a thin translucent layer. The developer requires one-to-two minutes to dry due to its non-chlorinated carrier and propellant. The developer is translucent and care must be taken not to over apply, a heavy coat can mask defects.

The developer must be thoroughly dry before interpretation. It must dwell for a period of not less than 10 minutes before interpretation. Do not interpret after thirty minutes

## 6.0 INSPECTION

Visible penetrant indications can be inspected in either natural or artificial white light. Adequate illumination is required to ensure no loss of sensitivity in the inspection. A minimum light intensity at the inspection sight of 100 foot candles is required. The light source must be verified and documented as meeting 100 foot candle lighting requirement.

## 7.0 INTERPRETATION

Indications shall be interpreted and evaluated based on the following definitions.

Only indications with a majority dimension greater than 1/16 inch shall be considered as relevant.

### Linear Indications:

Linear indications are those in which the length is more than three times the width.

### Rounded Indications:

Rounded indications are those, which are circular or elliptical with a length equal to or less than three times the width.

## 8.0 ACCEPTANCE CRITERIA

The criteria for acceptance or rejection shall be as specified in the job specifications and/or in the applicable Code or Standard.

## 9.0 REPAIR OF INDICATIONS

Defects greater than acceptable shall be removed by grinding and/or chipping. If the defects do not encroach upon the minimum thickness, they do not need to be repaired, except they shall be faired in or blended by grinding to eliminate abrupt valleys or ridges. The area shall be retested in accordance with this procedure after fairing.

Defects that reduce the minimum piece or wall thickness shall be removed by chipping and/or grinding and repaired by welding, provided the repair falls within

the permissible requirements of the specific material specification and referencing Code Section. After the defect removal procedure and prior to making the weld repairs, the area shall be examined by suitable methods to ensure the defect has been removed. Welded repairs shall be made by ASME qualified welders and procedures. The repaired area shall be retested in accordance with this procedure.

#### 10.0 POST TEST CLEANING (Non-essential variable)

Post test cleaning is necessary in those cases where residual penetrant or developer could interfere with subsequent processing or with service requirements. If deemed necessary, the entire surface of material affected by the penetrant dye or developer will be cleaned by liberally flushing with Magnaflux Spotcheck SKC-S or Sherwin Dubl-Chek DR-60 cleaner / remover.

#### 11.0 REPORTS

The results of the examination shall be reported on the Liquid Penetrant Test Report form. This report shall be signed and dated by the examiner. (See Exhibit #1)

#### 12.0 QUALIFICATION

##### Procedure (Essential variable)

Qualification of the procedure shall be performed by utilizing a test piece containing one or more discontinuities of the smallest relevant size encountered in production examinations. The procedure shall be demonstrated as being capable of detecting such discontinuities. Documentation of this demonstration to the Authorized Inspector shall be maintained on file.

##### Requalification

Requalification shall be required when a change of a requirement in ASME Section V Table T-621 identified as an essential variable from the specified value, or range of values is made to this written procedure. Re-demonstration of the procedure to the Authorized Inspector shall be required.

##### Personnel (Non-essential variable)

Personnel utilizing this procedure to make final acceptance inspections shall be qualified in accordance with the requirements of Appendix 8 of ASME Section VIII Division 1, and Appendix A-270 of ASME Section I.

Personnel certified Level II or III shall perform interpretation of results.

## 13.0 CERTIFICATION

WGS hereby certify that this procedure has met all the requirements of T-150 of Section V of the ASME Code.





# **WILLBROS GOVERNMENT SERVICES (U.S.), LLC**

A WILLBROS COMPANY

## **PRESSURE TEST PROCEDURE NDT-3**

Revision 6 February 21, 2010

<b>Rev</b>	<b>Description</b>	<b>Reviewed</b>	<b>Approved</b>
<b>0</b>	<b>Approved</b>	<b>IQC</b>	<b>DG</b>
<b>1</b>	<b>General</b>	<b>IQC</b>	<b>DG</b>
<b>2</b>	<b>General</b>	<b>IQC</b>	<b>DG</b>
<b>3</b>	<b>General</b>	<b>IQC</b>	<b>DG</b>
<b>4</b>	<b>General</b>	<b>IQC</b>	<b>DG</b>
<b>5</b>	<b>General</b>	<b>IQC</b>	<b>DG</b>
<b>6</b>	<b>General</b>	<b>IQC</b>	<b>TDA</b>
<b>7</b>			

## **TABLE OF CONTENTS**

- I. Scope**
- II. Responsibility**
- III. Requirements**
- IV. Procedure**
- V. Calibrations**
- VI. Records**

# HYDROSTATIC TEST PROCEDURE

## I. SCOPE:

This procedure is to insure that all the requirements of the applicable sections of the ASME Code are met and to insure the safety of all personnel which are involved in performing the hydrostatic test.

## II. RESPONSIBILITIES:

The Site Manager or Field Superintendent is responsible for the safe performance of the hydrostatic test. Only trained personnel, aware of these procedural steps, shall be used to conduct the test.

The Quality Control Manager or his designee is responsible for witnessing and documenting the results of the hydrostatic test and assuring that it is performed safely in accordance with this procedure.

For hydrostatic tests performed to meet ASME Code requirements, the Quality Control Manager or his designee is responsible for notifying the Authorized Inspector in advance of the test so that he may be present.

**NOTE:** The Authorized Inspector must witness and accept all hydrostatic test performed to meet Code requirements.

## III. REQUIREMENTS:

All welds shall be satisfactorily completed and the vessel and or piping released by Quality Control for hydrostatic testing.

**NOTE:** All fabrication shall have been completed, except for operations which can not be performed prior to the test such as weld end preparation, seal welding of vent plugs or cosmetic grinding on the base material which does not affect the required thickness. All examinations shall have been performed, except those required after the test.

## IV. PROCEDURE:

1.0 The hydrostatic test pressure (usually 150% of design) and temperature shall be determined from the approved vessel and or piping design specifications.



- 2.0 Flanges and nozzles which are not utilized during the hydrostatic test shall be blanked and plugged using material approved for the job or standard approved material in the hydrostatic test area.
- 2.1 Material (blinds, threaded plugs, bolting, etc.) shall be compatible for the design pressure of the vessel and or piping and for use with the specified test pressure. Only material in good physical condition shall be used.
- 2.2 Material used for welded closures shall be as specified on the vessel/piping drawing and identified by "P" number or by material specification.
- 2.3 Welded connections made to temporary closures shall have the minimum weld sizes as specified on the vessel/piping drawing.
- 2.4 Any additional NDE specified on the drawing for welded temporary closure shall be performed and any necessary repairs made.
- 2.5 These connections must be visually inspected for verification of proper material, preparation, welding, threading, or bolting as specified on the vessel/piping drawing.
- 2.6 The design and capacity of test plugs will be verified by Supervision and Quality Control. The plugs will be secured by chain or other means to assure containment if they slip.
- 2.7 Visual inspection by Quality Control of all closures is required before pressure application.
- 3.0 Hydro Trees will be engineered and constructed to WGS Engineering specifications or better. All Hydro Trees will be marked with their rated capacity. Temporary drains and vents will use the same or higher schedule pipe as the Hydro Tree.
- 4.0 The testing medium shall be clear city tap water with less than 50 ppm Chloride content unless otherwise specified in the vessel/piping design specifications. This report will include the latest city water quality report. Other liquid mediums may be used if there is a danger of freezing or water would cause adverse effects on the vessel/piping.
- 5.0 A calibrated gauge shall be selected with a dial range of at least 1 1/2 times and not more than 4 times the hydrostatic test pressure. The spacing between graduations shall be such that the Quality Control Inspector and the operator controlling the test shall be able to determine when the required test pressure has been applied.

- 5.1 Digital reading pressure gauges having a wider range of pressure may be used provided the readings give the same or greater degree of accuracy as obtained with dial pressure gauges.
  - 5.2 The gauge shall be mounted directly to the vessel/piping as near as practical to the top most part undergoing the hydrostatic test. Hydrostatic head on the gauge shall be considered depending on the location of the gauge.
  - 5.3 If the indicating gauge is not readily visible to the operator controlling the pressure applied, an additional indicating gauge shall be provided where it will be visible to the operator throughout the duration of the test. For large vessels, consideration shall be given to the use of a recording gauge in addition to indicating gauges.
- 6.0 Connect all fill and vent connections as necessary.
- 6.1 Open vents must be located at the high point of the vessel/piping during the fill up to purge the air from the system.
  - 6.2 A hose or some other means to control water release should be installed on the high point vent.
- 7.0 Prior to filling the vessel, all personnel not involved with the hydrostatic test shall be kept at a safe distance from the testing area. The item to be hydro tested, the pump and the high pressure hose will be roped off at a safe distance with red barricade tape.
- 8.0 The temperature of the testing medium shall be as specified in the vessel/piping design specifications.
- 8.1 The testing medium shall be at least ambient temperature but in no case less than 70 degrees F for Section I items. For NBIC repairs, the metal temperature should not be less than 60 degrees F preferably at least 30 degrees above the MDMT but not more than 120 degrees F for section VIII Division 1 items. The temperature for B31.3 Piping is limited by the stress value at test pressure-temperature.
  - 8.2 The test pressure shall not be applied until the vessel and its contents are at about the same temperature.
- 9.0 The vessel shall be filled with the testing medium until all air pockets have been expelled. The vent valve shall be closed when it is determined that venting is completed.

9.1 Vents shall be provided at all high points of the vessel/piping in the position in which it is to be tested to purge possible air pockets while the vessel is filling. If the operator or the Quality Control Inspector determines the vent arrangement is inadequate, the test shall be aborted until the problem is resolved.

**CAUTION:** The venting of air at ALL high points must be checked IMMEDIATELY prior to the pressure test. As the temperature of the testing medium increases, air may be released. It must be vented.

9.2 If the pressure does not come up readily when pumping, stop. This could be an indication of air in the system. Depressurize and re-purge to assure the removal of air.

10.0 The operator of the hydrostatic pump shall have a clear view of the test pressure gauge, so that he will be aware of the test pressure at all times.

10.1 The pump operator will be stationed away from the immediate vicinity of the vessel/piping being tested as deemed necessary to provide for his safety. A means of observing the pressure gauge will be provided.

10.2 If the operator or the Quality Control Inspector suspects any gauge to be in error, the test will be aborted until such gauge has been replaced or recalibrated.

11.0 At this time and until the conclusion of the hydrostatic test, the pump operator will not leave the pump station for any purpose except when relieved by an individual competent in the performance of this operation.

12.0 The hydrostatic pressure shall be applied gradually until the required test pressure is reached. The pressure application will be witnessed by the Quality Control Inspector. A close visual inspection WILL NOT BE conducted at this time.

12.1 The test pressure shall never be exceeded by more than 6%.

12.2 NO FITTINGS OR CONNECTIONS WILL BE TIGHTENED WHILE THE SYSTEM OR VESSEL IS UNDER PRESSURE.

12.3 If a leak is detected during testing, the pressure is to be lowered to 2/3 of the test pressure (or maximum allowable working pressure) prior to approaching the vessel.

12.3.1 Leakage of temporary gaskets or plugs installed for the purpose of conducting the hydrostatic test and which



will be replaced later may be permitted unless the leakage exceeds the ability to maintain the vessel/ piping test pressure for the required amount of time or interferes with the evaluation of the test results.

- 13.0 After the predetermined holding time of the hydrostatic test pressure, the pressure will be lowered to  $2/3$  the test pressure (usually the maximum allowable working pressure).
  - 13.1 The holding time shall be a minimum of ten (10) minutes or a greater time if specified on the vessel/piping drawing or requested by the Inspector to complete the visual inspection of joints or components.
- 14.0 A close visual examination will then be conducted of all joints and connections at this time. When a satisfactory Hydro has been completed, the results will be recorded on the Job Traveler (if it is an ASME Code job) and the appropriate Hydrostatic/Pneumatic Pressure Test Form by the Quality Control Inspector.
- 15.0 Upon completion of the hydrostatic test, the pressure will be dropped. The pressure gauge will be checked to verify it has returned to zero.
- 16.0 Drain and vent valves will be opened to allow the vessel to drain. Never open the drains on a large vessel without first opening the vent. Open lines shall be elevated in order to be free of any standing water

## V. Calibrations

The test gauge(s) shall be calibrated within a (1) year current time frame and in accordance with NIST standards. A copy of the gauge(s) calibration will be present during the test.

## VI. Records

The Hydrostatic/Pneumatic Pressure Test will be recorded on the appropriate form as determined by the QC Inspector at the completion of the test. The test record will be maintained for the duration as specified by the applicable code.

### 1.0 Approved Test Forms

- 1.1 Record of Hydrostatic/Pneumatic Test
- 1.2 Pressure Test Certificate

A copy of the test gauge calibration(s) shall be attached to the test report for final records. All test records or reports will be submitted in the project final report or data book.

## Record of Hydrostatic / Pneumatic Test

Job Number \_\_\_\_\_ Location \_\_\_\_\_

Sheet Number \_\_\_\_\_ Mark Number \_\_\_\_\_

Date of Test \_\_\_\_\_ Gage Number \_\_\_\_\_ Calibration \_\_\_\_\_

Chart Recorder Number \_\_\_\_\_

Calibration Date \_\_\_\_\_

Hydrostatic Test Pressure \_\_\_\_\_ PSIG

Test Medium \_\_\_\_\_

Duration of Test \_\_\_\_\_

Witness and Accepted by:

Inspector: \_\_\_\_\_ Date: \_\_\_\_\_

Customer Representative \_\_\_\_\_ Date: \_\_\_\_\_



# WILLBROS GOVERNMENT SERVICES (U.S.), LLC

A WILLBROS COMPANY

## Pressure Test Certificate

PROJECT		LOCATION	JOB NUMBER	
CONTRACTOR		P & ID No.		
SERVICE				
TEST PACK NUMBER.		DRAWING No.		
SYSTEM NUMBER				
MARK No.		ISO No.		
LINE No.				
LINE SPECIFICATION		TEST MEDIUM		
DESIGN PRESSURE (MAWP)		PSI	TEST PRESSURE	PSI
STRESS RELIEVED		YES	NO	INTERNAL LINING
				YES
				NO
ALL PRE- TEST NDE COMPLETE AND ACCEPTED		SIGNATURE		DATE
MATERIAL RECORDS COMPLETE		SIGNATURE		DATE
WELDING HISTORY RECORDS COMPLETE		SIGNATURE		DATE
PRE-TEST INSPECTION		FOREMAN SIGNATURE		DATE
WELDING OF PRESSURE PARTS COMPLETE		_____	SYSTEM FILLED AND PURGED OF AIR	
PROPER GASKETS, BOLTS AND BLINDS		_____	TEMPERATURE WITHIN SPECIFICATION	
TEMPORARY VENTS AND DRAINS INSPECTED		_____	HYDRO EQUIPMENT AND GAGES INSPECTED	
TEST PLUGS INSPECTED AND SECURED		_____	OPERATORS PROPERLY INSTRUCTED	
INSTRUMENTATION BLOCKED OR REMOVED		_____	BARRACADES IN PLACE	
VALVES IN THE RIGHT POSITION (OPEN/CLOSED)		_____	AREA CLEARED OF PERSONEL	
TEST MEDIUM WITHIN SPECIFICATION		_____	_____	
QUALITY CONTROL SIGNATURE				DATE
PRESSURE TEST		DATE OF TEST	AMBIENT	START
DURATION			TEMP.	FINISH
COMMENTS (TO INCLUDE GAGE NUMBER AND CALIBRATION DATE)				
	Inspected by		Witnessed by	
COMPANY	_____		_____	
SIGNATURE	_____		_____	
PRINT NAME	_____		_____	
DATE	_____		_____	
POST HYDRO RESTORATION				
HYDRO BLOWN DOWN & DRY		_____	CONTROL & CHECK VALVES INSTALLED	
HYDRO BLINDS PULLED		_____	HIGH POINT PLUGS SEAL WELDED & INSPECTED	
PROPER GASKETS INSTALLED		_____	NDE ON PLUG SEAL WELDS COMPLETE	
PROPER BOLTING & TIGHTNESS		_____	DRAIN / VENT VALVES CLOSED & PLUGGED	
	Inspected by		Witnessed by	
COMPANY	_____		_____	
SIGNATURE	_____		_____	
PRINT NAME	_____		_____	
DATE	_____		_____	



STRESS CALCULATIONS FOR 3/4" SA106-GR B PIPE  
t-12.5% for pipe with no Corrosion Allowance

ASME PG-27.2.1 TUBING PRESSURE CALCS. <=5"OD

Thickness	Diameter	Stress	Exp tubes
0.135	1.05	17100	0
t	D	S	e

$$P = S [ 2t - 0.01D - 2e / D - ( t - 0.005D - e ) ]$$

Pressure
2218.725

Sch 80

ASME PG-27.2.1 TUBING PRESSURE CALCS. <=5"OD

Thickness	Diameter	Stress	Exp tubes
0.192	1.05	17100	0
t	D	S	e

$$P = S [ 2t - 0.01D - 2e / D - ( t - 0.005D - e ) ]$$

Pressure
3193.425

Sch 160

ASME PG-27.2.1 TUBING PRESSURE CALCS. <=5"OD

Thickness	Diameter	Stress	Exp tubes
0.269	1.05	17100	0
t	D	S	e

$$P = S [ 2t - 0.01D - 2e / D - ( t - 0.005D - e ) ]$$

Pressure
4510.125

Sch XXS

MAWP FOR HYDRO TREE VALVES:

TYPE	PRESSURE
800#	2000#
1500#	3750#
2500#	6250#

# Hydro Tree Rated to 1500 PSI

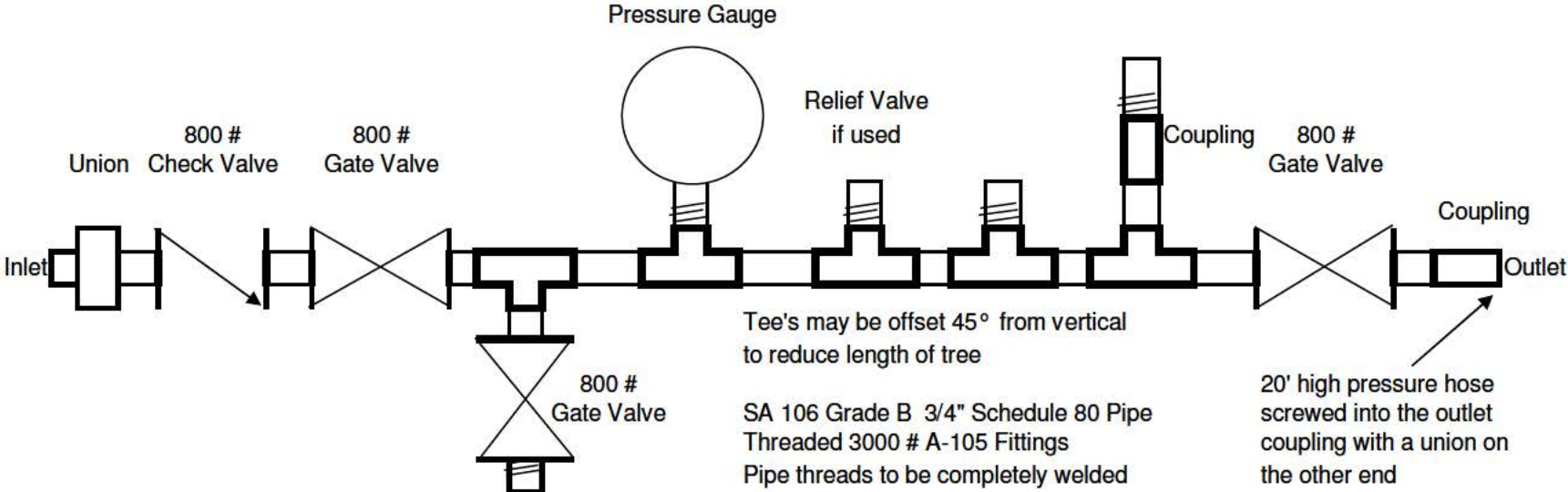

# Hydro Tree Rated to 3000 PSI

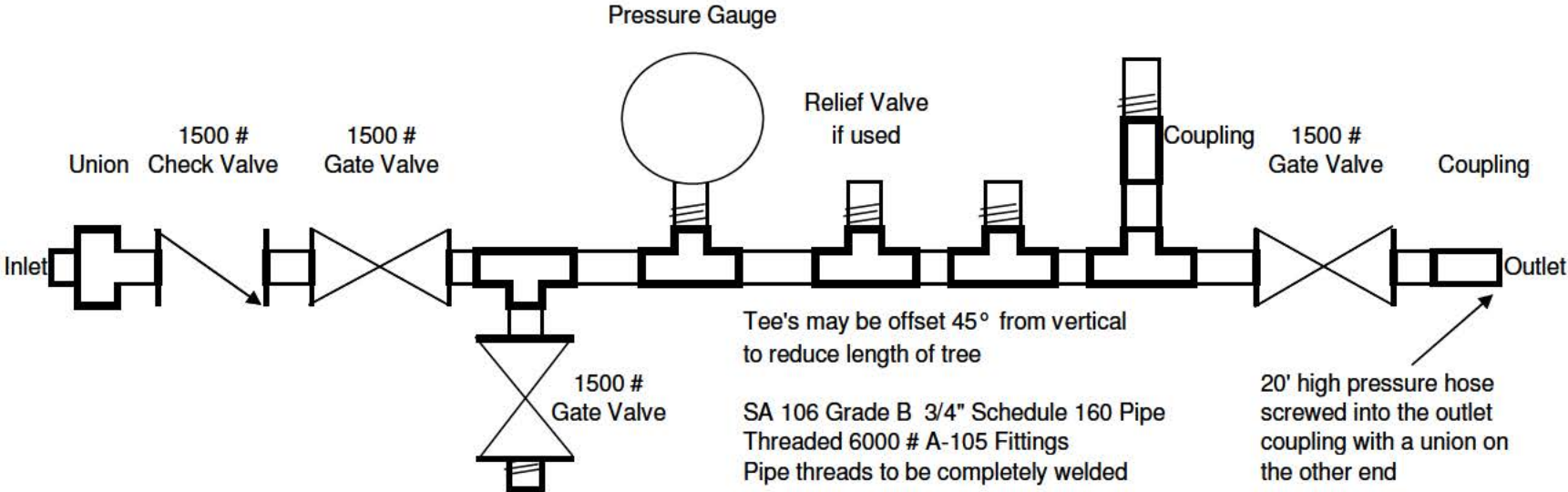



# Hydro Tree Rated to 4500 PSI

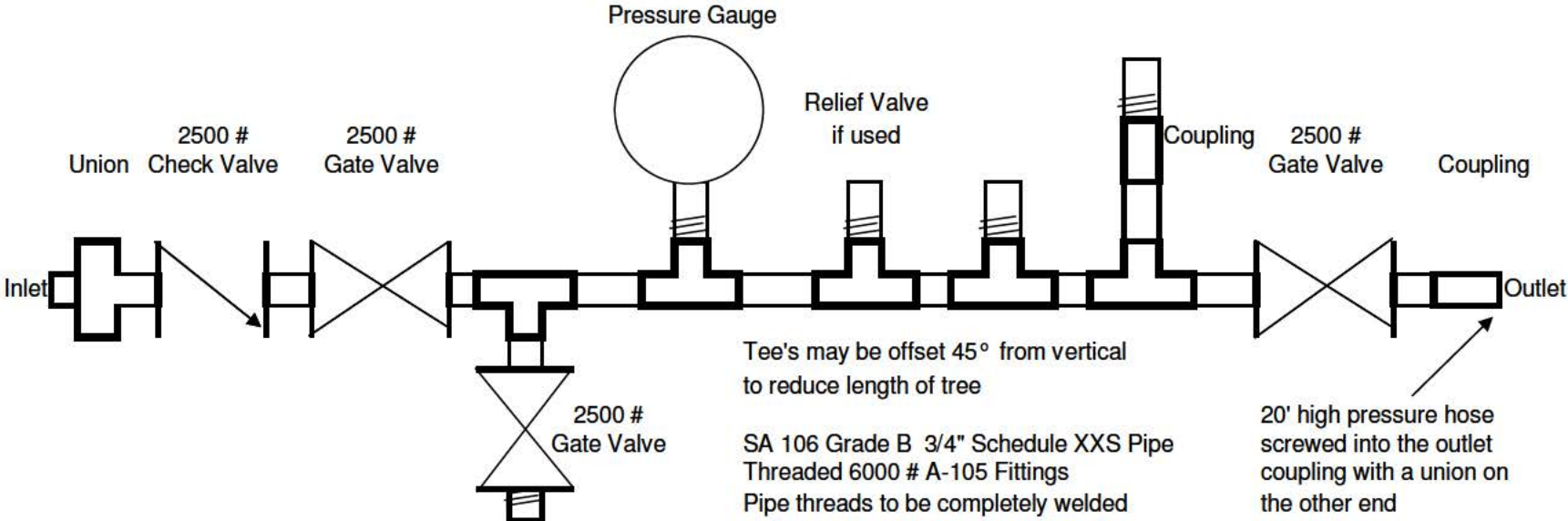

# TANK CALIBRATION BY THE OPTICAL METHOD

Reference: ANSI/API MPMS 2.2D-2003)

## PREPARATION

The minimum number of horizontal stations shall be selected in accordance with Page 6 of the Field Strapping charts. Additional stations, beyond the minimum specified in the table may be selected, but an even number of stations shall always be chosen. The stations shall be spaced as nearly equidistantly around the tank circumference as is possible. Horizontal stations shall be chosen to ensure that the vertical readings are always at least 12 inches (300 millimeters) away from the vertical weld seams. For the bottom ring, the preferred vertical station is (a) at 20 percent of the course height below the upper horizontal weld seam and (b) within the focal range of the optical instrument.

## INSTRUMENT VERIFICATION

The optical device shall be leveled along three axes at each horizontal station. The perpendicularity of the optical ray or vertical reference line shall be verified. The optical device shall be rotated 180 degrees about the vertical axis and the reading on the horizontal scale shall again be noted. The optical device shall not be permitted to move during this measurement. The difference between the two measurements shall be within 1 in 20,000 over the total height of the tank. For example, if the tank height is 40 feet, the difference between the two measurements should be less than 0.002 foot.

## FIELD FORMS

Complete all applicable information on all Field Forms.

## TANK CALIBRATION FIELD DATA

**CLIENT:** \_\_\_\_\_

Mailing Address \_\_\_\_\_

**CONTACT:** \_\_\_\_\_

Phone: \_\_\_\_\_

Fax: \_\_\_\_\_

E-mail: \_\_\_\_\_

**CLIENT:** Name & \_\_\_\_\_

Location for Table: \_\_\_\_\_

Tank Number: \_\_\_\_\_ File Number: \_\_\_\_\_

Strapped by : \_\_\_\_\_ Issuing Office: \_\_\_\_\_

**TABLE INFORMATION:** (Circle or note as required)

MAIN TABLE INCREMENT: 1", 1/4", 1/8", 1/16", 5 cm, 1 cm, 1 mm, 1/10' or 1/100'

TABLE VOLUME: Barrels, US Gallons, Imperial Gallons, Litres, Cubic Metres

TABLE LANGUAGE: English, French or Spanish

TABLE LAYOUT: Vertical / Horizontal      FORMAT: Innage / Ullage / Both

TABLE SIZE: 8 1/2 x 11 / 8 1/2 x 14 / 11 x 14 / 11 x 17 / A4 / Other: \_\_\_\_\_

ELECTRONIC FILES    TABLES & CALC (POF)    DATA FILES: Excel / Other \_\_\_\_\_

NUMBER OF LAMINATIONS: \_\_\_\_\_    NUMBER OF PAPER COPIES: \_\_\_\_\_

**Notes:**

**Submit Data To:**

1. Average values, if applicable, will be issued in 1/16", 1 mm or 1/100'.
2. Volume Format unless requested will be:
  - US Gallons, Imperial Gallons, Litres - issued 0 decimals
  - Barrels - issued 2 decimals
  - Cubic Metres - issued 3 decimals
3. Data submitted to be based on most current API/ASTM Standards.



**TANK DATA**

Tank # \_\_\_\_\_

1. Date Strapped: \_\_\_\_\_ Year Built & Serial No.: \_\_\_\_\_
2. Nominal Size: Diameter: \_\_\_\_\_ Height: \_\_\_\_\_ Safe Fill Height: \_\_\_\_\_  
*(to be Supplied by Terminal)*
3. Tank Shell: *Mild Steel* \_\_\_\_\_ *Stainless* \_\_\_\_\_ *Other* \_\_\_\_\_
4. Tank Insulated or to be Insulated: *Yes* / *No*
5. Reference Temperature for Tank Shell: 60°F / 15°C / Other \_\_\_\_\_ °F / °C
6. Average Operating Temperature for Product: 60°F / 15°C / Other \_\_\_\_\_ °F / °C
7. Product Service to be: \_\_\_\_\_ API @ 60°F \_\_\_\_\_ or Density @ 15°C \_\_\_\_\_
8. Product at Strapping: \_\_\_\_\_ API @ 60°F \_\_\_\_\_ or Density @ 15°C \_\_\_\_\_
9. Air Temp @ Strapping: \_\_\_\_\_ °F / °C. Liquid Ht.: \_\_\_\_\_ Liquid Temp: \_\_\_\_\_ °F / °C
10. Tank Bottom: 1. Cone Up (Ht.) \_\_\_\_\_ 2. Cone Down (Ht.) \_\_\_\_\_  
3. Sloping (Ht.) \_\_\_\_\_ (Is gauge point on HIGH / LOW / OTHER side of slope?)  
4. Flat 5. Physical Survey 6. Liquid Calibrated 7. Other \_\_\_\_\_

11. Strike Point / Datum Ht. (SP) Above + \_\_\_\_\_ Below - \_\_\_\_\_ Intersection of Shell & Bottom

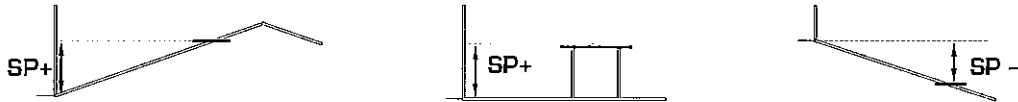

12. Type of Roof: 1) *Cone* 2) *Dome* 3) *Flat*  
4) *Internal Floating* 5) *External Floating* 6) *Other* \_\_\_\_\_

13. Shape of Underside of Floating Roof: 1) *Flat Pan* 2) *Round Pontoon*  
3) *Angled Pontoon* 4) *Square Pontoon* 5) *Other* (submit sketch)

14. Floating Roof Data Obtained from: 1) *Terminal* 2) *Previous Table* 3) *Measurement*

15. WEIGHT of Floating Roof: \_\_\_\_\_ pounds / kilograms

16. ROOF DATA:

- Height TO bottom of Deck or Pontoon . . . . .★ (A) \_\_\_\_\_
- Height From Strike Point to bottom of Deck. . . (SH) \_\_\_\_\_
- Height FROM Deck to bottom of Pontoon . . . . .(B) \_\_\_\_\_
- Pontoon Diameter or Height . . . . .(C) \_\_\_\_\_
- Pontoon Length (on radius) . . . . .(D) \_\_\_\_\_
- Pontoon Rim Space . . . . .(E) \_\_\_\_\_

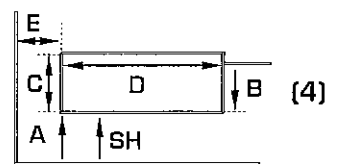
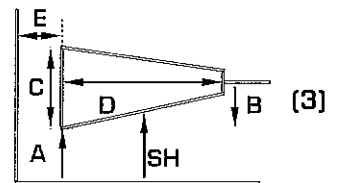
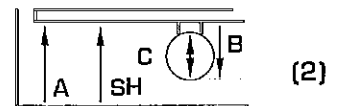
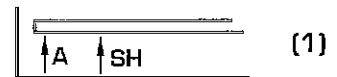

17. Distance between Pin Settings for High & Low Roof: \_\_\_\_\_

18. Roof Measured in: HIGH / LOW position.

19. Table issued with Roof Position: HIGH / LOW / BOTH

20. Roof to be: 1) *Deducted - API / Density* 2) *Not Deducted*.

21. If Not Deducted Displ. by: 1) *Formula* 2) *Supplementary Table*.

★ (A) measurement to be taken near Shell adjacent to Strike Point/Datum

**TANK MEASUREMENTS**

Tank # \_\_\_\_\_

Note: For further clarification refer to API MPMS Ch. 2.2A

Ring No.	Strapped % Up	External Circumference Feet / Metres	Plate Thickness	Ring Height	Butt Straps / Tape Rise Number x Width x Depth
Btm					
1					
2					
3					
4					
5					
6					
7					
8					
9					
10					

Master Tape (1) \_\_\_\_\_ Feet / Metres. Master Tape # \_\_\_\_\_ @ \_\_\_\_\_ Tension.

Circumference (2) \_\_\_\_\_ Feet / Metres. Span Used \_\_\_\_\_ (Copy of Certificate must be submitted)

Total Tank Height . . . . . (A) \_\_\_\_\_

Vertical Height to Gauge Point . . . . . (B) \_\_\_\_\_

Reference Gauge Height . . . . . (GH) \_\_\_\_\_

Gauge Point Description . \_\_\_\_\_  
 (example - at benchmark in hatch)  
 (rim of hatch opposite hinge) \_\_\_\_\_

Horizontal Level Distance to Gauge Point . . . . . (C) \_\_\_\_\_

1. Overflow or 2. Foamline (circle) . . . . . (D) \_\_\_\_\_  
 (Distance to bottom of lowest vent or foamline.)

If Foamline : Stop Table \_\_\_\_\_ (or) Run to Full Height \_\_\_\_\_

Ring Construction: (If composite - describe each ring)

- 1. Butt-Welded    2. Butt-Riveted    3. Lap-Riveted
- 4. Lap-Welded    5. Other: (describe) \_\_\_\_\_

Number of Plates per Ring: \_\_\_\_\_

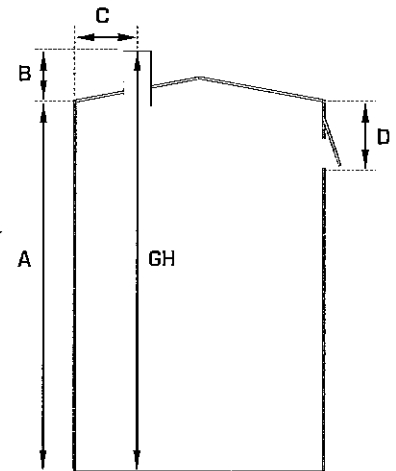

Does Tank Have Tilt? Yes / No





Rod Reading @ Strike Point / Datum : \_\_\_\_\_ ( Location to be marked on survey with an "X" )

Rod Reading @ Shell Nearest Strike Point / Datum : \_\_\_\_\_

Rod Reading @ 2nd Strike Point / Datum : \_\_\_\_\_ ( Location to be marked on survey with an "\*" )

Measurement Readings Recorded in 1. Inches 2. Feet or 3. Millimetres

Direction of Stations: A. Clockwise B. Counter-Clockwise

NOTE: All Rod Readings to be taken with the rod "0" point on tank floor.

NUMBER OF RADII

	Shell	1'	5'	10'	15'	20'	30'	40'	50'	60'	70'	80'	90'	100'	110'	Center
1																
2																
3																
4																
5																
6																
7																
8																
9																
10																
11																
12																
13																
14																
15																
16																
17																
18																
19																
20																
21																
22																
23																
24																

FLOATING ROOF SURVEY : Rod Reading of Roof @ Strike Point \_\_\_\_\_ (Reading to be taken with rod "0" point on roof.)

	Rim	5'	10'	15'	20'	30'	40'	50'	60'	70'	80'	90'	100'	110'	Center
1															

Circle the approximate Bottom Configuration:  
 1. CONE UP    2. CONE DOWN    3. FLAT  
 4. SLOPING    5. UNEVEN    6. Other : \_\_\_\_\_

IF CONE DOWN - IS ADDITIONAL BOTTOM TABLE

REQUIRED ?    Yes    No

Increment :    1/4",    1/8",    mm,    Other : \_\_\_\_\_

**Optical / Radii Stations**  
 (use same number of stations & direction as Optical Readings)

Minimum number of stations for any tank = 8

Formula to establish minimum stations

a. Circumference (feet) / 30 or  
 b. Circumference (metres) / 9  
 (Round to an even number of stations)

Maximum distance between points on any radii is 10 feet ( 3 metres)

**NOTE:** All Readings to be taken with the "0" point on scale nearest the tank shell.  
For further clarification refer to API MPMS Chapter 2 - Section 2B.

20% & 80% up each ring are the assumed Optical Locations unless otherwise marked.

		1 Btm	2	3	4	5	6	7	8	9	10
NUMBERS OF HORIZONTAL ZONES	1										
	2										
	3										
	4										
	5										
	6										
	7										
	8										
	9										
	10										
	11										
	12										
	13										
	14										
	15										
	16										
	17										
	18										
	19										
	20										
	21										
	22										
	23										
	24										
Total											
Avg.											

Reference Circumference: (1) \_\_\_\_\_ Feet / Metres  
 Reference Circumference: (2) \_\_\_\_\_ Feet / Metres  
 Master Tape #: \_\_\_\_\_ @ \_\_\_\_\_ Tension. Span Used \_\_\_\_\_  
 (Copy of Certificate must be submitted)

Optical Readings Taken: 1. Internally 2. Externally  
 Trolley Horizontal Scale Reading: 1. Feet 2. Millimetres  
 Direction of Stations: A. Clockwise B. Counter-Clockwise

Reference Opticals must be taken at same position as reference strap.  
 Mark Reference Optical Ring Position with a " \* "

Minimum Stations		
Diameter	Number of	
Feet	Metres	Stations
50	15	8
100	30	12
150	50	16
200	70	20
250	85	26
300	100	32
350	120	36

Refer to formula on Page 5

# HORIZONTAL CYLINDER

TANK # \_\_\_\_\_

DATE : \_\_\_\_\_

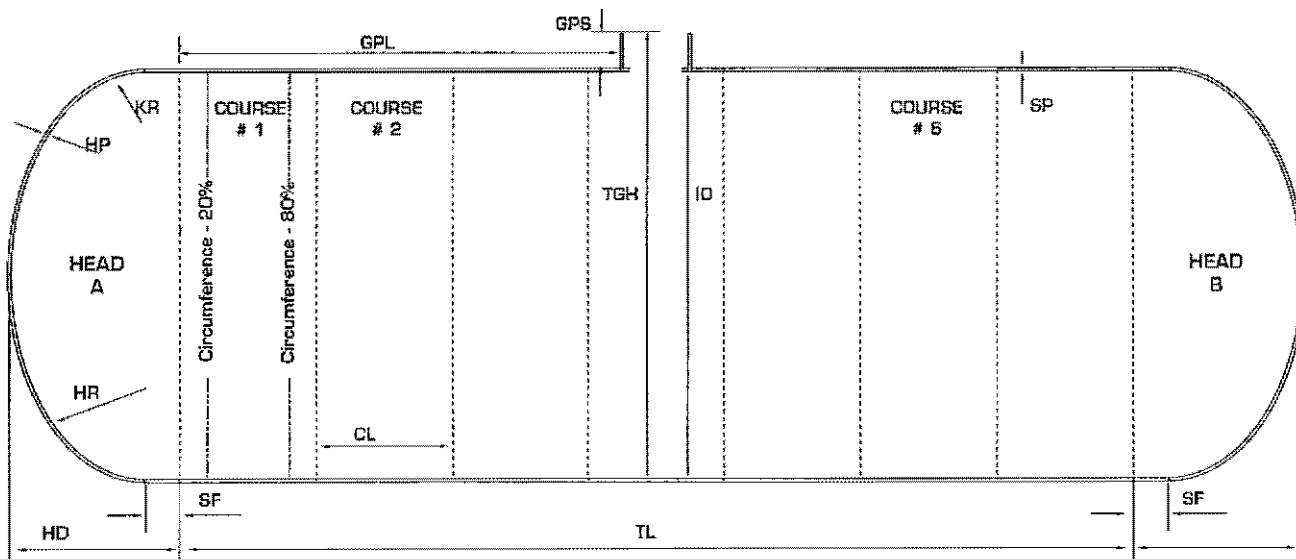

No.	%	Circumference Strap	Length (CL)
1	20%		
	80%		
2	20%		
	80%		
3	20%		
	80%		
4	20%		
	80%		
5	20%		
	80%		
6	20%		
	80%		
7	20%		
	80%		
8	20%		
	80%		

### MAIN CYLINDER DATA

Total Gauge Height (TGH)
Vertical Height (GPS)
Internal Diameter (ID)
Gauge Point Distance (GPL) <span style="float: right;">From A or B</span>
Total Cylinder Length (TL)
Plate Thickness (SP)
Operating Temperature - 60 F / 15 C / Other _____

**CONSTRUCTION:** BUTT OR LAP / WELDED OR RIVETED

NUMBER OF PLATES PER COURSE: \_\_\_\_\_

BUTT STRAPS : NO. \_\_\_\_\_ WIDTH \_\_\_\_\_ DEPTH \_\_\_\_\_

HEAD DATA	HEAD 'A'	HEAD 'B'
Straight Flange (SF)		
Head Depth (HD)		
Plate Thickness (HP)		
Knuckle Radius (KR)		
Head Radius (HR)		

Master Tape # \_\_\_\_\_ @ Tension \_\_\_\_\_  
(Copy of Certificate must be submitted)

IS CYLINDER ON AN INCLINE: YES / NO

WHICH IS LOW END? HEAD 'A' OR HEAD 'B'

HEIGHT AT HEAD 'A' : \_\_\_\_\_

HEIGHT AT HEAD 'B' : \_\_\_\_\_

TOTAL INCLINE : \_\_\_\_\_

LENGTH BETWEEN HTS IF OTHER THAN (TL) \_\_\_\_\_

TYPE OF HEAD : FLAT / DISHED / 2:1 ELLIPTICAL  
HEMISPHERICAL / OTHER \_\_\_\_\_

ATTACHED TO CYLINDER :

SET IN / SET OUT / BUTTED

DISTANCE SET IN / OUT \_\_\_\_\_

Refer to API Std. 2551 for further clarification.  
USE REVERSE TO RECORD DEADWOOD AND ADDITIONAL COMMENTS.





## **APPENDIX F**

### **PROJECT PROCEDURES – REPAIR CONSTRUCTION / QUALITY CONTROL / WELDING**



**WILLBROS GOVERNMENT SERVICES (U.S.), LLC**

---

A WILLBROS COMPANY

# **WILLBROS GOVERNMENT SERVICES, LLC**

## **FIELD QUALITY CONTROL PLAN & MANUAL**

<b>Rev</b>	<b>Description</b>	<b>Reviewed</b>	<b>Approved</b>
<b>0</b>	<b>Approved</b>	<b>IQC</b>	<b>DG</b>
<b>1</b>	<b>General</b>	<b>IQC</b>	<b>TDA</b>
<b>2</b>			
<b>3</b>			
<b>4</b>			
<b>5</b>			



TABLE OF CONTENTS

<u>SECTION</u>	<u>CONTENTS</u>
1.	INTRODUCTION
2.	PERSONNEL RESPONSIBILITIES
3.	PROGRAM METHODS
4.	FORMS AND REPORTS
5.	RECEIVING INSPECTION
6.	MATERIAL STORAGE AND CONTROL
7.	CIVIL
8.	PAINTING
9.	INSULATION
10.	STRUCTURAL STEEL
11.	WELD MATERIAL CONTROL
12.	WELDING PROCEDURES
13.	WELDING QUALIFICATION
14.	PRODUCTION WELDING CONTROL
15.	PIPE ERECTION
16.	FABRICATION AND ERECTION OF PRESSURE VESSELS AND STORAGE TANKS





## 1. Introduction

### 1.1 Purpose

The objective of this Field Quality Control Program is to establish written plan procedures and inspection guidelines for Field inspectors, and craft specialists to assure that component materials are assembled, installed, inspected and tested in accordance with specifications, governing Codes, standards and contract documents.

This program's intended use is to ensure that all inspections, documentation, reports and records will be maintained throughout all phases of the project.

The Field Quality Control Program will be directed to all disciplines to improve communication and coordination with all project members. Its intent is to provide historical data and traceability of the projects and maintenance effort as related to materials, crafts employed, procedures utilized, and inspections performed in accordance with established procedures.

### 1.2 Scope

These directives and procedures shall be used by project participants to assure compliance with material, fabrication, inspection and testing specifications and codes.

The quality effort provided is to assure that quality requirements established by the Client are initiated in the inspection program. Quality requirements will be maintained from receipt of material through installation and final testing.

It is intended to have craft supervision participate in the responsibility for overall quality function and have maximum coordination of effort where quality requirements are involved.

This program will be subject to periodic review and revision to encompass new material and techniques.

### 1.3 Responsibility

It is the responsibility of Project Management and the QA/QC Manager to administer and implement the inspection procedures as deemed necessary to verify and attain established quality requirements for the project.

Enforcement of quality procedures at the field level will be through the site QA/QC Manager and Site Project Manager.

The Inspector(s) will be trained and qualified professionals in all related quality procedures, testing and methods of documentation, as required by individual work assignments.

Audits will be performed by the QA/QC Manager to determine effectiveness of quality functions, evaluate schedules, procedures and personnel performance.





It will be the responsibility of the Site QA/QC Manager to organize, review, and turn over all Project Quality Control Documents to Client Inspection for final review, cataloging, and disposition.

## 2. Personnel Responsibilities

### 2.1 Quality Control Manager

Formulate and administer the quality control requirements for jobsite activities in accordance with Client, engineering specifications, applicable codes and this Field Quality Control Program.

Coordinate the quality inspection activities of inspectors with craft supervisors and specialists on the jobsite.

Administer the organizing of filing and recording systems and disposition of quality related documentation.

Facilitate and participate in the resolution of quality issues concerning vendors, engineering, and construction with quality representatives from Client.

Administer continuing surveillance of all craft disciplines to assure that quality standards of workmanship are maintained and conform to approved drawings and specifications in all areas.

Initiate action to prevent, stop or correct the occurrence of quality control deficiencies, defective work and deficient reports.

Administer and provide for certification of all inspection and NDE personnel. Utilize guidelines established by codes and standards.

Develop additional quality procedures as required to cover special tests, audits, or to improve coverage of the Field Quality Control Program.

### 2.2 Site Inspector

Assures by inspection at the jobsite, that all quality requirements are maintained for each assigned area or areas and that the proper levels of inspection are applied based on Client and approved specifications, codes and drawings.

Monitors testing, in-process work and evaluations to assure quality requirements are met.

Maintains welder qualifications and welder performance records.

Responsible for weld mapping and testing requirements.

Maintains and initiates records. Reviews procedures and documentation for completeness, accuracy and compliance to Client specifications and standards.

Performs investigation and research in the definition and isolation of quality problems and participates in the resolution of quality problems.

Assignment of Inspectors will be to one or more of the following, as qualification and experience allow, i.e.: Based on the site organization structure, inspectors may be assigned by plant area.





- Receiving inspection, material storage and issue control
- Civil survey, concrete and structural
- Piping, welding and weld material control
- Mechanical equipment, vessel, tanks and exchangers
- Electrical and instrumentation
- Quality testing, system hydro, NDE,

Surveillance of craft personnel to assure:

- Approved engineering and workmanship methods are being used
- Quality approved material is being used
- Advanced warning of possible problem areas is provided to supervision
- Good safety practices are being followed
- Cooperation is achieved to meet quality goals
- Accurate documentation of work and testing is maintained

### 3. Program Methods

#### 3.1 Scope

This Field Quality Control Program is established for use by WGS and their Sub-contractors. All inspections, tests and verifications will be conducted in accordance with Client and Engineering specifications, or Codes and specifications referenced therein. This document describes the systematic methods that will be utilized to establish the quality requirements to meet design intent.

The quality control effort will be coordinated within WGS and with their Subcontractors. The following Quality Control Jobsite plan will be reviewed and initiated for the respective job.

#### 3.2 Site Plan

Inspection will be by audit, testing and surveillance and will provide a progressive flow of records and information.

Receiving inspection will be performed on all major equipment when it is received at the jobsite. Storage of equipment and material will be monitored.

The Inspector(s) will continuously monitor the welder qualification, NDE testing, erection and welding of Tank and its components.

The Inspector(s) will monitor the activity of craft disciplines to assure and report that construction meets Client specifications and accepted quality levels of workmanship and safety.





The Superintendents, Inspectors, and Client Representative, will provide final acceptance of work completed and all inspections. All hydro test results will be monitored and signed off by Client representatives.

The Inspector(s) shall also recognize safety problems and report unsafe areas, working conditions, or working practices during inspection surveillance.

### 3.3 Corrective Action

A primary function of any quality inspection program is the control of nonconforming material, assemblies, or construction methods. Inspectors will utilize this plan of actions when any condition does not comply with drawings, specifications, Codes or Client specifications. The nonconformity must be eliminated before final acceptance.

If at any time material or workmanship is observed that do not comply with drawings, specification, Code or acceptable construction practices, the Inspector shall notify the Superintendent to initiate prompt corrective action. This information may be documented in the form of a discrepancy report. The Inspector will maintain discrepancy reports. The QA/QC Manager and Superintendent will evaluate all Discrepancy reports for resolution and correction.

The discrepancies, if they cannot be corrected immediately (verbally), shall be documented on a Nonconformance Report Form. A detailed description will be given for the item or condition that has failed to meet drawing or specification requirements and an explanation of conditions at the time of failure and probable cause. All nonconformance reports will be sent to the QA/QC Manager for approval.

All nonconformance reports will be evaluated by the QA/QC Manager, Project Engineer, and Design Engineering as appropriate to coordinate the resolution and determine methods of correction which may prevent recurrence of the problem.

When corrective action is complete, the item will be subject to final inspection by the Inspector.

The Inspector will note on his Final Acceptance Report any retest required, NDE required, or change in identification of any replacement parts used in correcting the problem.

### 3.4 Inspection Documentation and Reports

The QA/QC Manager will initiate, or assure initiation by craft foreman, engineering, supervisors, superintendents, or inspectors the appropriate required test and inspections of specific systems or components and submit recorded forms with verification of the Inspector's signature to the appropriate Client representative.





#### 4. Forms and Reports

The Quality Control inspection forms and reports (Exhibits) will be the primary documentation used by WGS.

Additional forms such as checklist, Client documentation and Code data forms can be added to the applicable sections for initiation by the Project Manager, Site Manger or the Quality Control Manager.

Each Inspector and Craft Supervisor making an inspection is required to document activities as they apply to the specific area or item of inspection. The QA/QC Manager will assure that copies of reports are sent through project or jobsite distribution list, as determined by contract or initial jobsite planning.

The QA/QC Manager will conduct periodic monitoring to assure continuing compliance to Client specification and procedures.

All forms require the same accurate completion and punctual submittal to demonstrate a professional Quality Assurance Program for the project. This form numbering system and following forms index may be supplemented to include Client documentation.

#### 5. Receiving Inspection

##### 5.1 General

All equipment, components and material received in the field require inspection. Inspection will vary in extent according to equipment type, material quantities and Client requirements. All items received will be inspected to assure they conform to purchase order and shipping documents.

##### 5.2 Responsibility

Assignment of receiving inspection responsibility depends upon the type of equipment, components and material subject to inspection and to what extent inspection was performed at the source.

Responsibility for receiving inspection is assigned to the QA/QC Manager or his designee.

##### 5.3 General Procedure

The Material Control Inspector, based on the size and scope of the project, will have the following prime duties:

- a. Provide facilities and personnel necessary to receive and assure proper storage of material, component parts, and bulk commodities.
- b. To assure proper identification of all items listed on the receiving report prior to signing the receiving documents.
- c. Rotating equipment shall be tagged with the equipment number, as specified by the purchase order.





- d. Identify and record shipping damage at time of delivery, have driver sign receiving report if possible. Client Project Management is to be notified of shipping damage.
- e. Notify the Inspection department at the time material has arrived.
- f. Assist in resolving discrepant material issues.
- g. Generate and maintain Over, Short and Damage Report, Shipping Records and Receiving Report.
- h. A copy of the Over, Short or Damage Report, Shipping Records and Receiving Reports are to be filed and copied to the WGS QA/QC Manager, Project Manager and Client entity, e.g. projects and or purchasing.
- i. PMI as required for alloy materials will be performed to the specific inspection procedure.

NOTE: The extent of receiving inspection on major equipment items may be supplemented with vendor surveillance requirements.

#### 5.4 Quality Control Inspection

The Field Quality Control Inspection will provide the necessary inspection required to assure compliance to all applicable specification, codes and purchase order documents.

Upon notification of receipt of material, components parts, and bulk commodities, the QA/QC Manager will determine the level of inspection to be performed by reviewing purchase order documents, engineering specification Codes and standards and any other referenced documents.

The Inspector will assure receipt of the required documentation. If the required documentation is not received with the shipment, the Inspector will report this fact to the QA/QC Manager.

Inspection should be made at the time of material arrival to verify the quality of the item and will also determine acceptability.

The Inspectors shall perform over, short or damage inspection.

The Inspector will complete the Receiving Inspection Report. He will maintain one (1) copy for his inspection records and attach two (2) copies to the receiving documents.

Receiving Inspection Report with Rejected items must be retained and maintained in a separate file for proper follow-up action. Disposition and verification of corrective action is required on reports prior to placing items in Accepted status.

Only the Inspector will be authorized to release rejected items after disposition.





## 6. Material Storage and Control

### 6.1 General Procedures

This is a system for assuring that adequate procedures exist for controlling material during storage, and will be used only when Integrated Service Company L.L.C. is responsible for material storage and controls.

The applicable craft and/or subcontractor, when designated, will be responsible for the performance of preventive maintenance and storage requirements.

The QA/QC Manager or his designee will conduct periodic inspections to assure compliance with the required storage procedure.

The objective is to assure that items are properly identified, protected, stored and maintained to ensure manufacturer's guarantees and warranties are not voided and to further assure proper operation.

### 6.2 Responsibilities

The QA/QC Manager or his designee will inspect all items received in accordance with the Receiving Inspection procedure in this manual and will assure that the preventive maintenance and storage requirements established by Client, Project Engineering and Manufacturer Standards are being adhered to.

The Material Control Manager will prepare a list of equipment and materials indicating storage and preventive maintenance requirements.

The responsible craft will perform preventive maintenance as indicated on the equipment list and will record actual dates on the record of preventive maintenance.

### 6.3 Inspection

The Project Quality Control Manager will determine preventive maintenance requirements or other special requirements from equipment technical manuals, engineering specifications and purchase documents.

Quality Control will conduct spot-checks in construction area, material storage yard, stock rooms, tool rooms and warehouse to ensure that the material and equipment are being properly stored and or maintained.

Quality Control will also ensure that a Rotating Equipment Log has been prepared and that all equipment, which must be rotated to prevent deterioration, is rotated at the prescribed frequency.

### 6.4 Storage and Protection

#### a. Fittings, Carbon Steel:

- All screwed fittings shall be stored indoors.
- All fittings 2" and below shall be stored indoors.



- Butt-weld fittings above 2" may be stored outside provided adequate protection is available to ensure quality control requirements.
- b. Fittings, Alloy
  - Procedures for alloy fittings shall be the same as for carbon steel, with one exception:
  - Stainless fittings shall be stored on wood and not allowed to come in contact with the ground, mud, water or debris.
- c. Instrumentation:
  - Where practical, all instruments shall be stored indoors with adequate weather and hazard protection.
  - Where outside storage is necessary, proper precaution shall be taken to provide adequate weather and hazard protection. Periodic checks shall be made to ensure proper protection.
- d. Pipe:
  - All pipes shall be stored outside on supports such as 4' x 4's or other timbers, with each end covered.
  - Pipe shall be checked at least once a month for any oxidation of surfaces covered ends and proper corrective action taken if oxidation should occur.
- e. Electrical:
  - Small electrical fittings shall be stored indoors.
  - Large fittings may be stored outdoors with proper weather protection.
  - Conduit maybe stored outside on elevated surfaces.
  - All electrical components will be stored indoors.
- f. Pumps, Motors and Machinery:
  - Pumps, motors and machinery will be stored outside in an area free from motorized traffic and hazards.
  - Motors will be stored on pallets or cribbing high enough to keep them out of the water.
  - Motor vents and openings shall be covered to protect the internals from moisture, dust and dirt.
  - Exposed shafts, gears shall be waterproofed to protect them from oxidation.
- g. Bolts and Gaskets:
  - Bolts and gaskets will be stored inside. Gaskets will be stored on a flat surface with nothing place on top of them.
  - Bolts will be periodically checked for corrosion.





- Ring joint gaskets should be coated or wrapped to prevent scoring of the sealing surface.

## 7. Civil

### 7.1 Responsibility

The WGS Quality Control Department is responsible for inspection or verification of civil work performed by WGS and/or WGS subcontractors.

### 7.2 Survey

Verify that all preliminary survey work for the site has been previously completed and documented.

The following items pertaining to the detailed site survey shall be of special attention to the Quality Control Inspector:

- Check to see that the correct control monument and benchmark are used.
- Check to see that the benchmarks are adequately protected.
- Check to see that the permanency of the control monuments is adequate.

### 7.3 Soil Investigation

Soil investigation shall be contracted to independent civil consultants.

The consultant may be asked to supply bearing ratio curves, land fill procedures, compaction test reports and moisture-density reports

### 7.4 Site Preparation

All trees, shrubs, stumps, fences, abandoned structures, foundation, large rocks, debris, etc., shall be removed to a depth specified by the contract specifications.

Any area that may collect rainwater shall have proper drainage.

Determine that grass and other organic material have been removed as required by the Project drawings and specifications. This material is to be disposed of as per contract specification and not stockpiled or buried where other construction operations will be interfered with.

Drainage of rain and subsurface water shall be adequate. This may be accomplished by keeping a sufficient number of pumps available.

Investigate the existence of underground obstructions, such as pipelines, telephone cable, per cables, etc., prior to the start of excavation activities. Notify engineering of any finding so that the information may appear on proper drawings.

Check for soft spots and undesirable materials.

Check for location and depth of excavation to ensure conformance with approved drawings and specifications.





#### 7.5 Backfill

The soil consultant shall approve any backfill materials used on the construction site. If the Fill material was not approved at the time of soils investigation and it is questionable, the soil consultant shall be called for approval.

Prior to placing of fill material, the excavation should be inspected for the following:

- The area is free of organic materials; i.e., paper, wood, rags, etc. Water is removed.
- Loose rock, dirt, etc., which will interfere with foundations, has been removed.
- Check for soft spots

#### 7.6 Compaction

The Quality Control Inspector will witness compaction test.

The compaction test may be performed by a subcontracted soils inspection agency. This agency will be required to submit all tests to the Quality Control Manager.

The procedure for the density test shall be in accordance with applicable engineering spec. or ASTM Standards.

#### 7.7 Foundations

Investigate and record all areas for existing underground facilities.

When depth of excavation is great enough and conditions indicate possible ground cave-in, shoring shall be used for safety of personnel. The Safety Department should be notified to obtain proper safety permit as required. USE OSHA STANDARDS.

All open holes, excavation and dangerous operations shall be barricaded and the Safety Department notified.

The Quality Control Inspector shall check the size and location prior to excavation. Verify elevation of the excavation.

Water shall be removed from the excavation site. Pumps must be available to maintain drainage in the event water continues to run into the excavation.

Backfill of the excavation shall be accomplished by using only soil materials approved by specifications and the soil consultants.

All loose debris shall be removed before backfill starts.

#### 7.8 Trenching

The excavation should be checked by the Quality Control Inspector as to location and elevations.



Coated pipe should lie on sand bags or other suitable softeners. Hard supports are not acceptable.

Backfill under roads, foundations, slabs or other load-bearing areas shall be compacted in accordance with engineering specification.

Shoring and barricades shall be used as necessary, within the Safety Department's approved guidelines.

#### 7.9 Foundations or Pads

The location, size and other design variables shall be checked by the Inspection Department for conformance with approved drawings and specifications.

The fill material shall conform to applicable specifications. A compaction test shall be taken as described by specifications. A copy of the compaction test results on each foundation shall be filed with the Project Manager and Q C Manager.

If an oiled sand base is required by specifications, it shall be mixed outside the excavation area, then brought into the base and compacted.

#### 7.10 Levees and Basins

The Inspector should check the location, size and elevation of the levees and basin to ensure conformance with approved design drawings.

The fill material shall conform to and be installed in accordance with approved drawings.

#### 7.11 Concrete Testing

The Inspector will sample and make cylinders in accordance with ASTM C31 and C172.

Each truck will be tested for slump to comply with Client specifications. One slump test performed in accordance with ASTM C 143. If the slump exceeds, by more than one inch, the maximum specified slump for the classification of concrete ordered in accordance with the Ready-Mixed Concrete Specification, the Inspector shall reject the concrete.

#### 7.12 Forms and Reinforcing Steel

The Inspector will check the following items:

- Dimension of form and embedded items.
- Elevation measurements.
- Chamfer (Usually a triangular length of wood, approximately 1/2" leg, which is a part of the formwork, intended to break exposed sharp edges).
- Evacuation to assure absence of organic material, excessive water, etc.
- Correct amount of clearance between rebar and proposed concrete surfaces after pour.





- Spacing between rebar, as checked against applicable drawings.
- Correct size of rebar.
- Amount of lap of rebar is per applicable drawings.
- That rebar lopped together are secured with wire or correct securing procedure per specifications.
- That excessive rust, dirt, mud or other organic materials have been removed from rebar.
- Anchor bolts, angles, etc. for proper size, material and installation dimensions. All rails, plates and other embedded items are installed and accurately placed.
- Pipe sleeves & fittings are properly installed.
- All conduit and grounding is properly installed. (Signed off by Electrical Department)

#### 7.13 Concrete Placement

Concrete should not be allowed to drop over five feet (5') or aggregate separation may occur.

Excessive vibration may cause aggregate separation.

Finish to be in accordance with specification. Finish work should be done on the same day as the pour.

Add only approved mixtures to concrete to advance or retard curing process, air entraining, etc.

#### 7.14 Pour - Q.C. Data

The following items should be checked and logged:

- Estimated quantity required. Information should be obtainable from the drawing or Engineering.
- The required design strength and Cylinder Test per Client specifications.
- Slump required by specification and actual results.
- Approximate atmospheric temperature at time of pour.
- Record concrete temperature at time of placement.
- Number of gallons of water added to concrete mix at jobsite.
- Time from batch plant to placement (from batch ticket).
- Batch ticket number (Attach ticket from each truck used).





## 8. Painting

### 8.1 Standards and Specifications

These Standards shall apply to painting performed by WGS and or a Painting Contractor hired by WGS.

All painting shall conform to the applicable project specifications and manufacturer's recommendations.

Surface preparation shall conform to applicable painting specification.

Note: On all piping, which will require field hydro, welds and approximately 2" either side of welds are to be left unpainted.

### 8.2 Receiving Inspection

- Check for areas where paint may have been applied over mill scale or rust. Check for the use of correct paint.
- Check for dry film thickness.
- Paint materials shall be checked for damaged containers.

### 8.3 Inspection Procedures - Paint

All painting must conform to approved Client painting specifications for protective coating of equipment. The following items shall be checked prior to, during and after final painting:

- Surface preparation per applicable drawings:
- Surface shall be dry and clean, free from dirt, oil, grease, water and other foreign matter.
- Motors, pumps and related equipment, which may be damaged by any specific cleaning, process, i.e., sand blasting shall be brought to the attention of the Client for necessary changes.
- All surfaces must be painted on the same day that they were cleaned.
- On pumps and motor, paint should not be allowed in parts, which may affect operation; i.e., seals, air filters and rotation shafts, bearing, etc.
- Check for the use of the correct primer.
- If multiple layers of primer are to be used, each layer shall be checked by the Inspection Department to ensure that proper millage requirements have been met and that surface profile conditions and compatibility with other paints are acceptable.
- Intermediate coat shall not be applied until the Inspector has approved the primer coat(s).
- Check intermediate painting materials to ensure conformance to specification.



- The final coat of paint shall not be applied until the Inspector has approved intermediate coats.
- Check for the use of correct paint materials of final coat.
- Check thickness of finished product.
- Check for good workmanship; i.e., no paint runs, excessive sand that may have blown on wet paint, scratches, etc.
- All special coatings must be applied in strict accordance with the approved specification and the manufacturing's recommendations. If information available is in conflict, contact the Project Field Engineer.

## 9. Insulation

### 9.1 General

These Standards shall apply to insulation installation performed by WGS and or an Insulation Contractor hired by WGS.

All insulation must conform to the applicable approved project insulation specifications,

The specifications will list the approved materials for insulating equipment and piping for both hot and cold services. The Inspector must examine all materials as they are used to see that they conform to specifications.

### 9.2 Receiving Inspection

Items received already insulated shall be checked against the applicable purchase order for the following:

- Correct thickness.
- Correct material.
- Damage.

Insulation received shall be checked for the following:

- Water damage to insulating cements or insulation.
- Excessive breakage of block or pre-form pipe insulation.
- Damage to jacketing materials.
- Ensure that all material conforms to specifications.

### 9.3 Equipment

The Inspector must inspect the following equipment before insulation is applied:

- Confirm the completion of all testing; i.e., hydro, pneumatic, ND, etc.
- Mechanical check for all insulation rings, supports, clips, ladders, platforms, etc.





- Confirm that equipment has been painted as required.
- Surface of equipment should be free of ice, snow, dirt, grease, etc.
- Nozzles and other protruding items usually require paint before insulation.
- Make certain that bull plugs or other small connections are of sufficient length to project through insulation, or make positive note of their location so that insulation can be subsequently cut away to expose the connections. Bull plugs may be required by specification to be seal-welded before insulation.

#### 9.4 Insulation Checklist for Equipment

The following is a checklist for inspection of insulation:

- Check for the use of proper materials.
- Check thickness of insulation and jacketing.
- Check distance between bands, screws, etc.
- Where double layer insulation is used, common joints between layers must be avoided.
- Insulation must be kept dry until properly weatherproofed. Check insulation expansion or contraction joints when required. Check on amount of lap and use of "S" clips on jacketing.
- Check the expansion bands have been installed when specified.
- Check that insulation support rings and stiffener rings and covered with insulation where require.
- Insulation shall be beveled at all flanged connections to allow for removal of bolts without insulation damage.
- Inspect for completely sealed joints on cold insulated equipment.

#### 9.5 Piping

Verify removable/reusable insulation pads are removed and identified prior to starting.

Piping shall be checked for the following, prior to insulation:

- Confirm the completion of all PWHT and testing; i.e., Hydro, Pneumatic, NDE, etc.
- Mechanical check for completion of supports, clips, shoes, guides, stops, branch connections, line size and line number, heat treatment, etc.
- Piping in cold service may require special paint.
- Material surfaces should be free of foreign matter.
- Vertical piping may require insulation supports.





- Remove all temporary supports, brackets, etc
- Ensure that steam and electric tracing systems are complete, if applicable.
- Most of the recommended inspection procedures as listed in the above equipment insulation checklist may apply to piping. A review of applicable piping specifications is recommended for detail requirements.

## 10. Structural Steel

### 10.1 Receiving and Storage

Receiving inspection of prefabricated structural steel shall be performed and documented in accordance with this manual.

Mixing of bolts and nuts, even of the same diameter, grade and length, is not permitted. Only certain pretested combinations of bolt lot, nut lot and washer lot, as established by the supplier or by jobsite testing, are permitted to be installed. Even when project specifications do not specifically require lot traceability, the practice of keeping bolt and nut lots separate and controlled is recommended. It is not necessary to record where the specific lots are installed on the structure.

In all situations, it is important to keep fastener components (bolts, nuts and washers) in containers protected from exposure to rain, dew and other forms of condensation under the cover. Most black bolts use a form of water-soluble oil, and this is easily washed off under the above conditions. If not kept in closed containers, this lubricant will also slowly evaporate, particularly in hot, sunny and dry environments.

If the lubrication of black fastener components is lost, or if the bolts become rusty, dirty, gritty or otherwise damaged, they must be cleaned and re-lubricated.

Special storage requirements must be met for galvanized fasteners. Galvanized bolts and nuts are to be provided by the supplier as a set. Over tapping of the nuts, necessary to allow the nuts to fit onto the bolt threads, makes thread stripping a possibility. Therefore, the bolt/nut set is to be pre-tested by the supplier to ensure that stripping will not occur, and then shipped together. At the site, galvanized bolts and nuts must be kept together as an assembly. If other nuts are used with the bolts, poor thread fit may result causing high torques or thread stripping. If nuts other than those supplied with the bolts are to be used, pre-testing following ASTM A325 procedures would be required.

Galvanized fastener components are lubricated differently than black fasteners, and this lubricant is generally more durable than the oily finish used on black bolts. Regardless, galvanized fastener components should be protected from the weather.

### 10.2 Erection

Unless noted otherwise in contract documents, steel construction shall be in accordance with the American Institute of Steel Construction (AISC) Code of





Standard Practice and AISC specification for structural joints using ASTM A325 or A490 bolts.

Any structural alterations which deviate from design must be approved by Design Engineer before the change.

Attachments and connections to any galvanized steel for erection shall be bolted and holes made by drilling or punching; welding to galvanized steel is not permitted. Burning holes is not permitted.

Bearing surfaces and surfaces that will be in permanent contact shall be cleaned of dirt and scale prior to assembly of modules. Any weld slag is to be ground off.

Except when bolt removal is specified on erection drawings, all erection bolts used in welded construction shall be properly tightened and left in place. When erection bolts are to be removed, the holes shall be filled with plug welds.

The specified hole diameter shall not be enlarged without approval by the designated engineer. Enlarging of holes to correct for misfits shall not be made by burning.

It is a requirement that black fasteners be oily to the touch prior to being installed. When compared to oily fasteners, bolts that have lost their lubrication may require as much as twice the torque to install them.

Galvanized fasteners are lubricated in a manner different than black bolts. They are not oily. The nut is the only lubricated component of the assembly. The nut is lubricated with a wax based product by the manufacturer.

Bolted connections using structural bolts and nuts shall conform to the requirements of slopes, washers and joint surfaces of the "Specification for Joints" (AISC). Each bolt shall be tightened so that all fasteners in the joints are "Snug Tight" unless otherwise specified.

When torque wrenches are specified to provide bolt tension, they shall be calibrated and used in accordance with the "Specification for Joints".

Structural joints made with ASTM A490 bolts shall be tightened to the proof load of the bolts per the "Specification for Joints".

Structural joints made with high strength bolts per ASTM A325 shall be installed per previous paragraph only if so specified or indicated as "Slip Critical" or Fully Tensioned on the design or erection drawings.

Hardened washers shall be provided in accordance with the "Specification for Joints" for selected high-strength bolted connection details.

### 10.3 Structural Bolt Tightening

Bolts shall be tightened by use of methods described in ASTM, A-325 and A-490. Recommended torques are in Table 1.

Structural bolts will be at least flush with the face of the nut. It is not permitted for the bolt end to be below the face of the nut after tightening is complete.





The joint should be snugged first, starting at the most rigid part of the joint. In a joint with a single or double row of bolts, this would be where the steel is already in contact, working towards the end where the steel may not be in contact. If there is solid contact between the steel at all locations, the direction of tightening does not matter. In a bolt pattern with several rows, such as a large web splice in a girder, the bolts in the center of the joint should be snugged first, then proceed to work towards the free edges of the plate. After the joint has been completely snugged, pretensioning (tightening) of the bolts should follow the same systematic pattern used for snugging. In the snug condition, and even in the fully pretensioned condition, there may be cases where gaps remain between the steel. These gaps however, must be away from the bolt holes. Gaps along the edges of parts may be caused by member tolerances, misalignment, shear distortion, welding and heat distortion.

**10.4 Pre-installation Testing Requirements**

AISC specifications require that all fasteners assemblies (bolt, nut, washer and DTI when used) are tested using the selected installation procedure prior to the fasteners being installed in the structure. The purpose of these procedures is to verify that the crew understands and can properly implement the installation process, and that the process will indeed develop the required minimum bolt pretension when used on the structure. Such procedures are applicable only to high-strength bolts that must be pretensioned (tightened).

<b>PRE-INSTALLATION TESTING REQUIRED TENSION (KIPS)</b>		
<b>Bolt Diameter</b>	<b>A325 Bolt</b>	<b>A490 Bolt</b>
1/2	13	16
5/8	20	25
3/4	29	37
7/8	41	51
1	54	67
1 1/8	59	84
1 1/4	75	107
1 3/8	89	127
1 1/2	108	155

Above values are 5% higher than the required pretension values used for design, actual installation and inspection.

**10.5 Turn of Nut Method**

Snug the joint so that no gaps exist between the layers of steel at the bolt holes. Apply a few hits with an impact wrench (until solid sound) or apply full effort on a spud wrench.





Inspect the joint to verify that the snug condition has been achieved.

Matchmark each bolt and steel surface in a straight line, going across a corner of the bolt. Also matchmark a nut corner and the steel.

One worker must hold the bolt head as the nut is turned.

Using a systematic approach, apply the required turns as given in Table T2. If there is a sloping surface, but less than 1:20 (3 Deg) underneath either the bolt head or nut, see the alternate turns requirements in Table T3. If the slope exceeds 1:20, a beveled washer is required.

Using visual inspection, verify by using the matchmarks that the turns have been applied to the nut as required by the tables. Also, verify that the bolt did not turn during tightening using the nut matchmarks.

#### 10.6 Re-use of Bolts Previously Tightened

Occasionally, it may be necessary to remove a previously tightened bolt and later re-install it. The specification permits re-use of black A325 bolts only with the engineering approval. Galvanized bolts and A490 bolts cannot be re-used.

Bolts that have been installed to the snug condition and then subsequently loosen when adjacent bolts are snugged are not considered as re-used bolts. Similarly, bolts that are touched up in the pretensioning process are not considered re-used. To be considered as re-use, the bolt must be loosened and removed from the hole.

A325 bolts that have been installed only to the snug condition and then removed can generally be re-used. Snugged-only A490 bolts and galvanized A325 bolts should be considered for re-use only if snugged by hand or if very lightly snugged with an impact wrench.

To check previously snugged and previously tightened A325 bolts to see if they can be re-used, run the nut up the entire length of the bolt threads by hand. If this is possible, the bolt may be re-used. Bolts that have yielded from tightening will stretch in the first few threads (nearest the bolt head), preventing the nut from progressing further up the threads. These bolts should not be re-used.

Because of the over-tapping of the nut threads for galvanized fasteners, this check is not valid for galvanized bolts.

A490 bolts do not have the same ductility that A325 bolts have. A490 bolts may not be re-used.

#### 10.7 General Inspection Procedures

The Quality Control Inspector shall check the following:

- Inspect the materials to verify that they are readily identifiable, have proper markings, and have proper documentation in accordance with the project specifications.





- Inspect the storage methods to ensure that fastener lots are kept separate and identifiable until time for assembly. Galvanized fastener assemblies must be kept together as a unit as shipped by the supplier.
- Verify that adequate lubrication is present on all fasteners to be used.
- Proper grouting of column base plates. Check vertical and horizontal alignment.
- Placement and elevation of all bearing plates.
- Proper welding procedures, weld quality and welder certification. All structural steel welding will conform to AWS D.1.1; however, welders qualified to Section IX will be considered with prior approval by Client Quality Control Dept.
- That engineered drawings are followed.
- If required, observe the rotational-capacity test procedures to verify the quality of the materials and their lubrication.
- Observe the pre-installation testing for each combination of grade, diameter, length and production lot of bolts with the grade, diameter and production lot of nuts that will be used with these bolts. In some cases, the washer diameter and lot is also included as a part of the test assembly. Three assemblies of each combination must be tested at the start of the project, prior to installation
- All bolting material for grade and size and tightness. A bolt shall be placed in each hole of each joint.
- Repair of any coatings damaged during shipment, storage, erection or by field welds. If structures are to be painted, refer to painting procedures of this manual or design engineering.
- Bolting in structural steel is paint marked after torquing to indicate that they are secured in accordance with specifications. The paint shall be placed on an exposed surface and easily visible.

#### 10.8 Inspection of Turn of Nut Method

See General Inspection Procedures – Common to All Installation Methods for pre-installation inspection steps.

- After bolts have been placed in the holes and the joints have been snugged, observe to verify that the joint has been properly snugged as determined by visual appearance. No gaps may be present in the immediate vicinity of the bolt holes, but gaps may be present between layers of steel away from the holes.
- Visually verify the length of bolt used is proper for the grip. The end of the bolt must be at least flush with the face of the nut (not recessed). The maximum stick-out is usually in the range of six threads, but varies by bolt diameter and production tolerances. For shear-bearing joints where the





threads must be excluded from the shear plane, additional verification of bolt length and the direction in which the bolt is oriented is necessary.

- Following inspection for the snug condition, observe the placement of match-marks, if used for these joints. Match-marking is recommended.
- Observe the pretensioning (tightening) of the bolts using the proper techniques of the turn-of-the-nut method. If match-marking is used, observe the marks after tightening to verify that proper rotation has been provided. If no match-marking is used, observe the bolting crew during tightening to verify that the wrench chuck is marked and watched for proper rotation and that the fixed end of the assembly (usually the bolt head) is held during tightening.
- Record that inspection has been completed for this particular group of joints.

#### 10.9 Hole Size Adjustment

The Specifications provide specific hole sizes for the various bolt diameters. These sizes are provided in Table T4. A tolerance of 1/32" larger than the stated whole diameter is permitted to allow for hole deformation and minor reaming.

If reaming beyond the specified hole size is necessary for fit-up, the Site Engineer must be contacted. In certain types of joints, the allowable stress for the bolt and steel will be reduced when the hole is made larger than that provided on the shop drawings. Shear-bearing joints may need to be changed to slip-critical joints when holes become oversized or become slotted in the loaded direction. In some cases, it may be necessary to enlarge the hole to the next larger bolt size and use an appropriately larger bolt diameter.

For slotting holes using a cutting torch, the width of the slot cannot be increased beyond the tabular value, plus the 1/32" tolerance, except that occasional rounded gouges from the torch to 1/16" are permitted. No grinding of the interior of the hole is required unless the structure is dynamically loaded, as designated by the Site Engineer.

For field modifications, holes may be flame-cut with the Engineer's permission. Generally, flame-cut holes in materials to 1/2" thick require no further work, provided the hole size meets the Table T4 values and tolerance. It is suggested that flame-cut holes be made smaller than the required diameter and reamed to the appropriate finished diameter.

### 11. Weld Material Control

#### 11.1 Procurement

A certificate of compliance or materials test report (M.T.R.) must be requested from the suppliers on all Code weld materials. The certificate must be traceable to the lot or heat number and material type and grade.





Low hydrogen, mild steel, low alloy, stainless and other exotic welding materials shall be purchased in hermetically-sealed containers.

Bare filler material used for Gas Tungsten Arc Welding (GTAW) process shall be purchased tagged or stamped on both ends with the applicable material designation number to facilitate identity in the field.

#### 11.2 Receiving

Upon receipt of welding material, the Quality Control Department shall verify acceptability of the welding material by inspection for possible shipping damage. Coated electrodes received in broken containers shall be rejected.

If required by Client Specification, a sample of each lot of alloy materials will be verified by Positive Material Identification.

#### 11.3 Storage

All welding material will be stored in a dry area and protected from environmental conditions. Materials will be segregated and stacked according to classification.

Acceptable coated electrodes and bare welding wire shall be controlled by Rod Room attendant.

After opening the hermetically sealed containers, all electrodes that are not used immediately shall be stored in the drying ovens.

Rods exposed to the atmosphere longer than manufactures recommendation shall be disposed of. Rods will not be reconditioned.

Any electrodes that have been directly exposed to moisture will be discarded.

#### 11.4 Storage Ovens

Storage Ovens shall have thermostat controls.

The temperature setting for low hydrogen electrodes shall be maintained at 250 + 25°. The Quality Control Inspector shall spot check the ovens for proper heat, segregation of welding materials and visual appearance of the electrodes, at any time during normal working hours.

Under no circumstances will items other than welding electrodes be placed in the storage ovens.

When possible, store only one type rod in an oven. The oven is to be conspicuously marked with material grade stored.

#### 11.5 Distribution

Prior to any welding operation, the Welding Supervisor or Foreman will coordinate the selection of proper welding material with the Quality Control.

Welding material will be issued by the rod room attendant to the welders only under controlled conditions. It is essential that the type of material issued is as specified for the given weldment and weld procedure. Welding Foreman and





Quality Control Inspectors are responsible for identification of type and grade of weld rod.

The end of each shift or weld assignment, the welder will be responsible for returning all unused welding material to the Rod Control Room. Electrodes that have been kept in a heated rod caddy will be returned to the storage oven.

#### 11.6 Quality Audits and Surveillance

Audits shall be performed on a continuing basis by the Welding Foreman and Quality Control personnel to assure conformance to this procedure and applicable welding procedures.

### 12. Welding Procedures

#### 12.1 Selection

Weld Procedures will be chosen to match the job scope, engineering and contract requirements.

All WPS's will be approved by Quality Control, the Client, and if applicable Engineering, before welding commences.

Only WPS's that meet the specific job Code requirements shall be used.

#### 12.2 ASME Code Construction

ASME Code Construction generally encompasses work on boiler, boiler piping and pressure vessels. It includes any work performed to which the requirements of Section I or Section VIII, Division 1 of the ASME Boiler and Pressure Vessel Code are legally imposed.

The QA Manager shall be notified immediately whenever Code Construction is to be performed.

ASME Code work must be done in accordance with the Integrated Service Company L.L.C. Quality Control Manual for ASME Code Construction, a Willbros Company.

### 13. Welder Qualification

#### 13.1 Testing

Quality Control shall have the prerogative to witness all tests and will be notified before any coupons are made ready for qualification acceptance testing.

Welder Continuity on the Welder Performance Qualification Reports will be within the last 6 months for each process that welder uses.

Welders will be tested and approved before a WPQR is written. Essential variables will be recorded on the WPQR.

With Client approval, welders may take a Production Test to Qualify or renew their Continuity.



When more than one welder, process, or filler metal is used to make a test coupon, the range shall be determined for each welder, process or filler metal individually based on the actual weld metal deposited thickness for each welder, process or filler metal.

Test coupons will be bent or radiographed.

### 13.2 Test Inspection

The inspector shall be attentive to, but not limited to, the following conditions during the test:

- a. Ensure the correct qualified Welding Procedure Specification (WPS) is being used.
- b. Check for use of proper size, thickness and material of the test coupon.
- c. Check for the use of proper electrode and flux materials.
- d. Check for proper welding process; i.e. GTAW, GMAW, SMAW, etc.
- e. Preheat, if required. Refer to the governing codes/specifications for recommended temperatures for various metals.
- f. Cleanliness of bevel. NOTE: It may be necessary to grind the I.D. of the test coupon approximately 1/4" from the bevel edge to remove any mill scale which may cause fusion problems on weld out.
- g. Check the root opening.
- h. Check for misalignment.
- i. Other essential, supplementary and non-essential variables as listed on the WPS are adhered to.

On a pipe test, the welder is not allowed to grind out the root pass from the I.D. side. He or she may grind the root pass from the O.D and re-weld from the O.D.

On a plate test, the use of a grinder and a gouge are permitted.

After the test is completed, the Inspector should check the following:

- a. Workmanship of the welder.
- b. Check the weld reinforcement, I.D. and O.D., to applicable Code requirements.
- c. Check for undercut, I.D. and O.D.
- d. Visually check for Incomplete Penetration on the I.D. Incomplete Penetration in excess of that which is acceptable by the applicable Code shall be rejected.
- e. Check for cold lap/non-fusion on the O.D. and I.D.
- f. On plate per API 650 and ASME Section IX codes will apply,

The Inspector may request that the coupon be tested by radiography or by bend-testing.





### 13.3 Radiography/Ultrasonic

- a. Welds are to be examined of their length or circumference.
- b. Film is to be interpreted to applicable Code.
- c. Radiography is to be accomplished in accordance with qualified/approved procedures.
- d. Welds that are to be examined by Ultrasonic Testing, testing will be performed to qualified/approved Ultrasonic procedures.

### 13.4 Guided Bend Test

- a. Straps are to be selected and marked by the Welding Supervisor/Inspector as directed by applicable Code or procedure.
- b. The welder or welder operator will stamp his initials on the coupon straps before the straps are removed from the coupon. The Welding Supervisor/Inspector is to determine and mark the straps which will require face and root bends.
- c. The welder/welder operator is to be responsible for cutting the straps from the coupon. Physical assistance from any other person during this preparation whether it be grinding, cutting or any other procedure which may affect the final results of the test, will not be allowed.
- d. The straps shall be bent, using the Guided Bend Test Jig, as described in ASME, Section IX, QW-466, or other applicable Code.
- e. Interpretation of the Bend Test shall be judged in accordance with ASME, Section IX, QW-163, Acceptance Criteria, or equivalent applicable Codes.

### 13.5 Welder Acceptance

After the welder has been accepted by the above mentioned test, he will be issued a welding stamp by the WGS Quality Control. His name will be placed on the Qualified Welders Log. A Qualification form shall be issued with his name by the Quality Control Manager.

### 13.6 Qualification Continuity Log

For welders qualified under ASME, Section IX, a log (Welders Log) must be kept to document that the welder has welded with a process at least once every six (6) months in order to maintain his qualification to weld with that process.

A Welder Performance Qualification Report (WPQR) that is current within the last (6) months may be substituted for a Continuity Log.

## 14. Production Welding Control

### 14.1 Welding Procedures

All welding performed on site will conform with qualified welding procedures which shall be submitted to and approved by Client prior to the start of welding activities.





All welders will be qualified to WGS weld procedures.

Copies of the qualified welding procedures shall be maintained on site by the Quality Control Department for reference and permanent retention.

#### 14.2 Welder Performance Qualification

WGS will conduct or supervise the Welder Qualification tests.

Records attesting to the Welder Performance Qualification tests shall be generated and maintained by Quality Control.

The Quality Control Department shall maintain a complete listing of welders and welding operators.

The Inspector will maintain a weld rejection rate per welder and supply current information to the Superintendent.

#### 14.3 Welding Material Control

The Inspector and Foremen shall verify that the welding material used conforms to the welding procedure. No substitutions for the specified material will be made without approval from the QA/QC Manager and Client.

#### 14.4 Fit-Up and Welding

Visual surveillance shall be performed to establish compliance to welding procedures. The inspection parameters listed below are recommended as a guideline:

- a. Inspect end preparation and joint configuration as established by applicable weld procedures and engineering specifications.
- b. Inspect internal alignment and root opening prior to welding.
- c. Check preheat requirements. Refer to the WPS and applicable Code/specifications for recommended time and temperature for various materials.
- d. Check tack welds that are to be incorporated into the final weld. Look for proper blend grinding and absence of visual defects.
- e. Check for proper welding materials, position and other essential variables of applicable welding procedures and welder qualifications.
- f. Check root pass for cracks, porosity, slag, fusion lines and quality workmanship.
- g. Inspect completed welds for proper reinforcement. All welds should blend smoothly into the base metal and be free of cold lap or non-fusion at the toe.
- h. Inspect welds for surface discontinuities such as undercut. Surface porosity and arc strikes are to be considered an injurious defect and should be repaired.
- i. All repairs are to be made in accordance with approved procedures.





- j. Each welder shall be responsible for stamping his assigned symbol adjacent to the weld he has made. This will be done with a low stress steel die stamp or a halogen-free paint marker. Weld maps shall be maintained by the Inspector.

#### 14.5 Post Weld Heat Treatment

Procedures for post weld heat treatment shall be submitted to Client Engineering for approval.

Refer to the applicable Code and/or Client specifications for recommended time and temperature requirements for various materials.

The Project Engineer, Client Specifications, QC Manager and applicable Codes shall determine the requirements and methods of post weld heat treatment to be performed. The Inspector will examine the heating equipment and installation per specification and the following checklist:

- a. Thermocouple attachment.
- b. Insulation.
- c. Recorder hook-up.
- d. Check chart for correct weld and line identification.
- e. Check for proper heating cycle; i.e. specified rate of temperature rise, holding time and cooling rate.
- f. Power failures are to be reported to the QC Manager.
- g. The Inspector is to make notations on the chart where there are deviations from the required heating cycle.
- h. Review charts and attach to inspection reports for filing.

#### 14.6 Quality Control - Weld Numbering System

When the Inspector receives the isometrics from Engineering, a prenumbering system shall be employed. The Inspector must review shop fabricated spool sheets with isometric drawings to check for addition or deletion of field welds. Every field weld within a system or line number shall be numbered consecutively, starting with the number one (1) (in the direction of flow) and continuing to the end of that system.

Alternatively, rack pipe and underground pipe may be marked on the appropriate drawing as the welds are completed and/or become ready for X-Ray.

When a field weld is added between two welds on an isometric, that weld becomes the same weld number as the preceding weld, with a letter designation added after the weld number.

All sockolet connections, weldolet welds, saddle welds, lateralet welds, etc., will be numbered as a weld on the line. Welds on the butt end of fittings will be numbered on the branch line isometric.





In all cases where practicable, weld numbers will be physically marked on the pipe adjacent to the weld with a paint type marker. If the Welding Foreman marks initial weld numbers, the Inspector will verify for accuracy. In addition, the Inspector will verify the line designation number and ISO drawing number are marked on each line and spool piece mark numbers are marked on each spool.

#### 14.7 Nondestructive Examinations

The QC Inspector will log completed welds that have passed a visual inspection.

The Jobsite Inspector in conjunction with Construction Supervision will schedule all NDE examinations.

NDE requirements for a given weld shall be determined by the Inspector in compliance with applicable project specifications, codes and standards.

The Inspector will advise the NDE Technician of welds ready for examination.

All inspections, heat treatments and NDE examinations will be recorded on the Weld Log (which correlate information to all welds on each isometric drawing) to indicate status of each weld. Weld maps (marked up isometric drawings) will be maintained to indicate weld numbers and provide as-built information and traceability.

NDE requirements shall be determined by Client, Engineering and applicable Code.

All pertinent information shall be recorded on the NDE report form.

#### 14.8 Field Welding Inspector's Checklist

##### a. Specifications

- General Specifications
- Project Specifications
- Client Specifications
- Drawings and Detail Sheets
- Contract or Purchase Order Specifications
- Quality Control System Specifications
- Welding Procedure Specifications
- Nondestructive Testing Procedure Specifications

##### b. Pre-Job Implementation

- Quality Control System Conferences - All Parties
- Off-Site Fabricators Inspection
- Vendor Inspection
- Procure Quality Control System Equipment, Printing, Supplies



- Compile Qualified Welder List and WPQR's.
- Establish Weld Procedures to be used and receive approval from Client.
- c. On-Site Inspection
  - Pre-Welding Inspection
  - Base Metal: Specification, size, thickness, traceability. Preparation Bevel, Land, Internal Alignment
  - Welding Procedure Verification
  - Qualified Welder(s) Assignment Verification
  - Welding Processes and Consumable Verification: Filler Metal (Specifications, Sizes), Condition Shielding Gas (Quantity, Specifications), Purge Gas (Specifications, Quantity, Method).
  - Preheat and interpass temperatures (Method, Control).
- d. As-Welding Inspection
  - Current Settings and Verification
  - Penetration and Fusion
  - Technique: Direction, Travel Speed, Heat Input, Bead Width
  - Cleaning: Power Tools, Solvent
  - Interpass NDE: Magnetic Particle, Liquid Penetrant
  - Stray Arc Strikes: Electrode, Contour, Undercut
  - Welder Symbol Stamp Applied
- e. Post Welding Inspection
  - Pre-Stress Relief NDE, Repairs, Repair NDE Stress Relief: Method Controls.
  - Brinell Hardness Survey
  - Post-Stress NDE: Repairs, Repair Procedure
  - Completed Weld Acceptance
  - Post-Welding Records and Reports
  - Print and/or Spool Sheet Notated

## 15. Pipe Erection

### 15.1 Procedures

This procedure covers pipe erection for underground and aboveground requirements. All pipe installations are governed by applicable engineering





specifications and Codes. This procedure is to be used in conjunction with Production Welding Control Procedures, Section 14.

Reference applicable sections of this manual for various procedures as necessary; i.e. Civil, Quality Testing, etc.

## 15.2 Aboveground Piping

Below are listed some items the Inspector shall be attentive to in pipe and pipe rack inspection:

- a. Welds
- b. Pipe alignment
- c. Check orientation of hand wheels on all valves, branch connections, instrument connections, etc.
- d. Conformance to material and fabrication specifications.
- e. Material test reports and certificates of compliance on materials to be used.
- f. Valves must be mounted with designed flow direction.
- g. Pre-fabricated meter runs which must be installed with proper flow direction and tap orientation.
- h. Shipping bars must not be removed from expansion joints until after pressure test.
- i. Spring-actuated pipe supports which have spring stops for shipping shall not be removed until after pressure test.
- j. Correct installation and type of flange gaskets and bolts. Exposed threads of stud bolts shall be approximately the same on both ends. The stud shall be flush with the nut, but not more than five (5) threads. Thread compound shall be put on exposed threads for protection. Client bolt up policy shall prevail over WGS policy.
- k. Strainers and traps must be installed with proper flow direction. It is important that the pressure ratings and material of the strainers and traps are as specified.
- l. Adequate support.
- m. Proper installation of pipe guides, anchors and shoes.
- n. Check proper installation of spring hangers, pick-up supports, hangers, dummy supports, etc.
- o. Proper installation of spectacle blinds.
- p. Verify that proper thread compound is being applied to pipe threads. If threaded pipe connects are seal-welded, then all the threads shall be encompassed in the weld. If connections are seal-welded, thread compounds are not to be used.
- q. All flange bolts should be tightened in a manner which will ensure uniform flange contact with the gasket.





- r. No oil or pipe dope may be used on any pipe for oxygen service.

### 15.3 Underground Piping

Prior to use, inspect pipe and fittings for any visual damage.

Fabrication and installation shall be done in strict accordance with job specifications and standards.

Pipe to be installed in clay, shale or rock requires a compacted loam or a fine granular material base.

Pipe to be installed in compacted sand, sandy loam, or granular soil requires no additional base work unless specified on contract drawings.

Pipe runs under roads or other foundations shall be compacted as required in the job specifications and standards.

Sand-filled cloth bags may be used to aid in setting underground lines. These bags need not be removed upon completion of installation.

Application of field coating and wrapping shall be in accordance with underground pipe specifications.

Inspection shall check for the following:

- a. Welds are clear of welding spatter.
- b. Pipe is clear of loose mill scale, rust, water, oil, grease, dirt, and other foreign matter.
- c. Primer is being used which is compatible with the existing line coating system.
- d. Proper overlap of tape according to specifications.
- e. Coating of valves for complete coverage.
- f. Test and inspect coated and wrapped pipe for voids and leaks by means of a holiday detector prior to backfilling.
- g. Prior to testing, inspect underground pressure system using underground piping drawings to ensure that proper anchors, supports and thrust blocks have been installed.

### 15.4 Pre-test Punch-out

Area Craft Forman and WGS Quality Control Inspector will perform a Pre-Test inspection for the following, but not limited to, items:

- a. Quality Control shall review all documents, records and reports to verify the completeness of each system and that no further repairs, x-rays, etc. or replacement parts are pending.
- b. Coordinate with the Site Manager, Engineer and discipline supervisor, to define areas of responsibility for all personnel in the final test.
- c. Visually inspect completed work and compare to the isometrics and drawings, paying specific attention to the following:



- Incomplete work or missing parts.
  - Proper installation of blinds.
  - Installation of danger/caution signs and other devices to prevent accidental misuse.
  - Check all valves.
  - General workmanship and appearance conforms to good construction practice.
- d. All discrepancies shall be documented and sent to the responsible supervision for corrective action.
- e. If required, sign the release to test documentation.

#### 15.5 Pre-Commissioning Start-up Inspection

- a. This inspection activity should be performed with the Client Quality Control Department and Operations Personnel. Witness of the inspection by Client inspection will be at their discretion.
- b. Typical items of inspection support during this phase of operation are as follows:
- Verify area is free of obstructions and grade of soil is of contract specs
  - Verify location of hazards such as power lines underground piping etc.
  - Verify local and federal permits are acquired.
  - Verify route of entrance, exits, or possible construction roads.
  - Verify and locate surveyed center of tank and/or benchmarks.

### 16. Fabrication and Erection of Pressure Vessels and Storage Tanks.

#### 16.1 Field Fabrication Inspection

a. Welding Qualifications

Prior to start of fabrication, assure that welding procedures and welders have been qualified in accordance with contract specifications and Sections 12 and 13 of this manual.

Examine filler metal to assure it is in accordance with approved procedures and specifications. Audit storage identification and issuing procedures for welding materials.

b. Visual Inspection

Examine mill test reports of materials used for pressure parts to ensure compliance with material specifications.

Obtain copies of mill test reports and mark to indicate vessel parts provided from material listed thereon.





Check that pressure part materials are marked for proper identification.  
Check transfer of marking on pieces cut from plate.

Check standard flanges for identification type and rating; check dimensions of all special flanges fabricated from plate or forgings.

Examine gaskets and bolting material to assure proper type and size.

Verify that formed heads conform to the specified configuration.

Record code stamping data on heads with welded seams.

Check pipe and fittings for proper type, schedule, material and ratings.

Examine all welds for weld contour, height or reinforcement, mismatch size of fillets, undercuts, pinholes and other defects.

Verify that drain connections are ground flush with the inside contour of the vessel.

Check that the proper radius is ground on the inside corners of all openings.

Check that bolt holes in flanges, unless otherwise specified, straddle the centerline.

Verify the weepholes in the reinforcing rings.

Check for grounding lug, nameplates, and other attachments.

Check that bolt holes in double base rings are properly aligned.

Check that all skirts are vented and have access openings, where required.

Inspect trays for proper material and conformance to drawings.

c. In-Progress Inspection

Inspect materials, especially pressure parts, for finish, damage, laminations, cracks, scars, excessive pitting. Perform a magnetic particle or dye penetrant test on edge surfaces in addition to visual check, when required by specification.

Visually inspect the bevels of heads and plates for welding.

Check alignment of longitudinal and circumferential joints for compliance with Code tolerances. Tack welds used for alignment are not to become part of the joint.

Check fit-up of head to shell and other attachments to the vessel.

See that proper pre-heat is applied when required by welding procedure.

Perform random check of back-gouging on all pressure-resisting welds to assure sound weld joints.

Verify the joint design being employed is in accordance with procedures and specifications.

See that welders identification stamping is in accordance with specification requirements.





Witness or review certified reports of all in-process nondestructive examinations specified, such as Radiography, Magnetic Particle, Liquid Penetrant and Ultrasonic.

d. Measurements

Measure to assure all dimensions and orientations are within tolerances specified on drawings and standards. This normally includes sizes, locations, thickness, projections, levelness and plumb, strapping, peaking, banding, and nozzle orientation.

Mark actual dimensions on an As Built Drawing if measurements are different from approved drawings but within tolerance.

Document out of tolerance dimensions on a Nonconformance Report and initiate corrective action.

e. Final Test

Examine NDE reports for compliance with Code acceptable limits, adequate definition, identification and material or weld defects.

Verify proper recording, documentation and storage of film.

Witness other NDE test or examine certified test reports.

Check for current calibration of NDE test equipment and gauges used in pressure test.

Witness all final pressure or vacuum tests.

Witness all functional tests or other test which may be specified by job scope.

f. Cleaning and Painting

Check to assure that tank has been completely drained of water.

Verify that all foreign material and debris has been removed from tank interior.

Witness testing of internal coatings when required.

When required by specifications, verify surface preparation and paint preparation, type, coverage, thickness and color as required by drawings or purchase order.

g. Documentation

Assemble and retain records and reports for inclusion in the completed job package to Client.

16.2 Field Erection

The following is a general guide for the erection of tanks.

a. Inspect foundation per API 650 tolerances and document on inspection data sheet.

b. Lay bottom following all the governing codes and specifications of API 650.



## WILLBROS GOVERNMENT SERVICES (U.S.), LLC

A WILLBROS COMPANY

- c. Erect the vertical shell in a manner fulfilling all the requirements of API 650 and ASME codes that apply.
- d. Follow OSHA regulations and WGS procedures when using scaffolding for the tank erection.
- e. When hanging structure follow WGS drawing and bolting specifications.
- f. Laying roof will follow WGS drawings engineered and approved by customer.
- g. Hanging and installing ladder will be built per drawing utilizing OSHA regulations.



**Willbros Government Services ("WGS")**  
**DAILY PRODUCTION REPORT**  
 (ATTACH ADDITIONAL SHEETS IF NECESSARY)

DATE:

CONTRACT #:	TITLE AND LOCATION:	REPORT NO.:
WGS PROJECT #:	REPRESENTATIVE:	
SITE MANAGER:	MAX. TEMP.:	MIN. TEMP.:
AM WEATHER:	PM WEATHER:	

**WORK PERFORMED TODAY**

**TASKS:**

**WGS LABOR SUMMARY**

NAME	EMPLOYER	TRADE	TIME		HOURS
			IN	OUT	

<b>JOB SAFETY</b>	WAS A JOB SAFETY MEETING HELD THIS DATE? <small>(If YES, attach copy of the meeting minutes)</small>	YES	NO	TOTAL WORK HOURS ON JOB SITE THIS DATE:	
	WERE THERE ANY LOST TIME ACCIDENTS THIS DATE? <small>(If YES, attach copy of completed OSHA report)</small>	YES	NO	CUMULATIVE TOTAL OF WORK HOURS FROM PREVIOUS REPORTS:	
	WAS CRANE/TRENCHING/SCAFFOLD/HV ELECTRICAL/HIGH WORK DONE? <small>(If YES, attach statement or checklist showing inspection performed)</small>	YES	NO	TOTAL WORK HOURS FROM START OF CONSTRUCTION:	
	WAS HAZARDOUS MATERIAL/WASTE RELEASED INTO THE ENVIRONMENT? <small>(If YES, attach description of incident and proposed action)</small>	YES	NO		

LIST SAFETY ACTIONS TAKEN TODAY / SAFETY INSPECTIONS CONDUCTED  Yes  SAFETY REQUIREMENTS HAVE BEEN MET.

**EQUIPMENT/MATERIAL RECEIVED TODAY TO BE INCORPORATED INTO WORK**

DESCRIPTION	QUANTITY	SHIPPING DOCUMENTS

**WGS CONSTRUCTION AND PLANT EQUIPMENT ON THE JOB SITE TODAY**

DESCRIPTION	IDLE	RENTED / OWNED	QUANTITY	TIME IN	TIME OUT	HOURS

**SUBCONTRACTORS ONSITE TODAY**

COMPANY	# OF PERSONNEL	WORK PERFORMED

**REMARKS / UNRESOLVED ISSUES / ANY SCHEDULE IMPACTS / PROJECT DELAYS**

Printed Name \_\_\_\_\_ Signature \_\_\_\_\_ Date \_\_\_\_\_



DELIVERY ORDER NO.:	<b>CONTRACTOR QUALITY CONTROL REPORT</b> (ATTACH ADDITIONAL SHEETS)	REPORT NO.:	DATE:
---------------------	--	-------------	-------

PHASE	Y=YES, N=NO, SEE REMARKS; BLANK-NOT APPLICABLE	IDENTIFY DEFINABLE FEATURE OF WORK LOCATION AND LIST PERSONNEL PRESENT
P R E P A R A T O R Y	THE PLANS AND SPECS HAVE BEEN REVIEWED	<u>Work Location:</u>
	THE SUBMITTALS HAVE BEEN APPROVED.	<u>Pre-Work Evaluation/Site Preparation:</u>
	MATERIALS COMPLY WITH APPROVED SUBMITTALS.	
	MATERIALS ARE STORED PROPERLY.	
	PRELIMINARY WORK WAS DONE CORRECTLY.	<u>Personnel Present:</u>
	TESTING PLAN HAS BEEN REVIEWED.	>
	WORK METHOD AND SCHEDULE DISCUSSED	>

PHASE	Y=YES, N=NO, SEE REMARKS; BLANK-NOT APPLICABLE	<u>Work Location:</u>	TESTING PERFORMED & WHO PERFORMED TEST
I N I T I A L	PRELIMINARY WORK WAS DONE CORRECTLY	<u>Accomplishment of Subject Work Tasks</u>	
	SAMPLE HAS BEEN PREPARED / APPROVED.		
	WORKMANSHIP IS SATISFACTORY.		
	TEST RESULTS ARE ACCEPTABLE.		
	WORK IS IN COMPLIANCE WITH THE CONTRACT.		

PHASE	Y=YES, N=NO, SEE REMARKS; BLANK-NOT APPLICABLE	TESTING PERFORMED & WHO PERFORMED TEST
F O L L O W U P	WORK COMPLIES WITH CONTRACT AS APPROVED IN INITIAL PHASE.	

REWORK ITEMS IDENTIFIED TODAY  
(NOT CORRECTED BY CLOSE OF BUSINESS)

REWORK ITEMS CORRECTED TODAY  
(FROM REWORK ITEMS LIST)

Remarks:

ON BEHALF OF THE CONTRACTOR, I CERTIFY THIS REPORT IS COMPLETE AND CORRECT AND EQUIPMENT AND MATERIAL USED AND WORK PERFORMED DURING THIS REPORTING PERIOD IS IN COMPLIANCE WITH THE CONTRACT DRAWINGS AND SPECIFICATIONS TO THE BEST OF KNOWLEDGE EXCEPT IN THIS REPORT.

PRINT NAME OF AUTHORIZED QC MANAGER AT SITE

AUTHORIZED QC MANAGER AT SITE SIGNATURE

DATE

**GOVERNMENT QUALITY ASSURANCE REPORT**

DATE

QUALITY ASSURANCE REPRESENTATIVE'S REMARKS AND/OR EXCEPTIONS TO THE REPORT

PRINT NAME OF GOVERNMENT QA REPRESENTATIVE

GOVERNMENT QA REPRESENTATIVE

DATE

PROJECT TITLE  
(Location, State)

SITE PHOTOGRAPHS

SAMPLE







INTEGRATED SERVICE COMPANY, L.L.C.

1900 N. 161st. E. AVENUE  
TULSA, OKLAHOMA 74116

Welding Procedure Specification (WPS)

WPS No.: 1-S-1 Date: 6/28/1994 Rev. No.: 0

Page 1 of 2

Supporting PQR(s): P1-E-1

Weld Type: Groove and fillet welds

BASE METALS (QW-403)

P-No. 1 Thickness Range: 0.1875 in. to 1.5000 in.  
to P-No. 1

PREHEAT (QW-406)

Minimum Preheat Temperature: 50 °F  
Maximum Interpass Temperature: 500 °F  
Preheat Maintenance: None after weldment

POSTWELD HEAT TREATMENT (QW-407)

PWHT Type: No PWHT will be performed  
PWHT Temperature: None °F  
PWHT Holding Time: None

Weld Process / Method Weld Deposit Limit <b>POSITION (QW-405)</b> Position of Joint Weld Progression <b>FILLER METAL (QW-404)</b> AWS Classification SFA Spec. / F-No. A-No. or Chemical Composition Filler Metal Trade Name Pass Greater Than 1/2": Filler Metal Size (in.) <b>ELECTRICAL (QW-409)</b> Welding Amperage Range Welding Voltage Range Travel Speed (in/min) Max. Heat Input (J/in) Current Type and Polarity <b>TECHNIQUE (QW-410)</b> Peening Stringer or Weave Bead	1st Process		
	SMAW / Manual		
	0.0000 in. to 1.5000 in.		
	All Positions		
	Vertical up		
	E7018		
	5.1 / 4		
	1		
	n/r		
	No		
	1/8	5/32	3/16
	90-160	110-200	200-300
	n/r	n/r	n/r
Var.	Var.	Var.	
None			
DCEP (reverse)			
None			
Stringer and weave bead			

(1) No peening done with this procedure.

No pass greater than 1/2" allowed.

Preheat to 175F if "T" > 1" and C > 0.30%; To 200F if 1.25 < "T" <= 1.5"

INTEGRATED SERVICE COMPANY, L.L.C.

Welding Procedure Specification (WPS)

WPS No.: 1-S-1

Rev. No.: 0

Page 2 of 2

**JOINT DESIGN (QW-402)**

Weld Type: Groove and fillet welds

Joint Type	Backing	Root Opening	Groove Angle	Root Face	Groove Radius
Single-V groove	no backing	3/16" max.	50 degree min.	1/8" max.	
Single-bevel groove	no backing	3/16" max.	45 degree min.	1/8" max.	
Single-V groove	gouged & back welded	1/4" max.	50 degree min.	3/16" max.	
Double-bevel groove	gouged & back welded	1/4" max.	45 degree min.	3/16" max.	
Double-V groove	gouged & back welded	1/4" max.	45 degree min.	3/16" max.	
Square groove	T-joint	1/32" max.			
Square groove	no backing	3/32" max.			

Fillet Welds: All (QW-451A)

Retainers: None

See fabrication drawing.

WELD JOINT DESCRIPTIONS SHOWN ARE NOT INCLUSIVE OF ALL THOSE FOUND ON A JOB. WELD JOINT DESIGN REFERENCE IN AN ENGINEERING SPECIFICATION OR A DESIGN DRAWING SHALL TAKE PRECEDENCE OVER WELD JOINTS SHOWN IN THIS WPS.

Initial and Interpass Cleaning: With wire brush clean 1" both sides of weld joint.

Method of Back Gouging: Grind until all defects are removed.

Minimum preheat must be maintained during thermal cutting, tacking, and welding operations.

Welds shall be cleaned between each pass. When completed, remove all slag and projections.

We certify that the statements in this specification are correct and in accordance with the requirements of Section IX of the ASME Code.

By: David S. Glaves

David S. Glaves

6/28/1994

Date

QC Manager



**INTEGRATED SERVICE COMPANY, L.L.C.**

1900 N. 161st. E. AVENUE  
TULSA, OKLAHOMA 74116

**Procedure Qualification Record (PQR)**

PQR No.: P1-E-1

Date: 3/17/1975

WPS No.: 1-S-1

Page 1 of 2

<p><b>JOINT DESIGN (QW-402)</b>  Weld Type: <u>Groove weld</u>  Groove Type: <u>Single-V groove</u>  Backing: <u>Open butt, no back weld</u>  Root Opening: <u>1/8</u> in.    Root Face: <u>1/16</u> in.  Groove Angle: <u>60</u> °</p> <p><b>PREHEAT (QW-406)</b>  Minimum Preheat Temperature: <u>50</u> °F  Maximum Interpass Temperature: <u>500</u> °F  Preheat Maintenance: <u>None after weldment</u></p>	<p><b>BASE METALS (QW-403)</b>  Specification Type and Grade:  <u>SA-515, Grade 70</u> to <u>SA-515, Grade 70</u>  P-No. <u>1</u> Group No. <u>2</u> to P-No. <u>1</u> Group No. <u>2</u>  Thickness (in.): <u>0.7500</u></p> <p><b>POSTWELD HEAT TREATMENT (QW-407)</b>  Type: <u>No PWHT performed</u>  PWHT Temperature: <u>None</u> °F  PWHT Holding Time: <u>None</u> hr.</p>												
<p><b>Weld Process / Method</b>  <b>POSITION (QW-405)</b>  Position of Joint  Weld Progression  <b>FILLER METAL (QW-404)</b>  AWS Classification  SFA Spec. / F-No.  A-No. or Chemical Composition  Filler Metal Trade Name  Weld Deposit 't' (in.)  Pass Greater Than 1/2":  Filler Metal Size (in.)  <b>ELECTRICAL (QW-409)</b>  Amperage Used  Voltage Used  Travel Speed (in/min)  Max. Heat Input (J/in)  Current Type and Polarity  <b>TECHNIQUE (QW-410)</b>  Stringer or Weave Bead</p>	<p><b>1st Process</b>  <b>SMAW / Manual</b></p> <hr/> <p><b>3G - Vertical</b>  Vertical up</p> <hr/> <p><b>E7018</b></p> <hr/> <p><b>5.1 / 4</b></p> <hr/> <p><b>1</b></p> <hr/> <p><b>n/r</b></p> <hr/> <p><b>0.7500</b></p> <hr/> <p><b>No</b></p> <hr/> <table style="width:100%; border-collapse: collapse;"> <tr> <td style="width:33%; border-right: 1px solid black; text-align: center;">1/8</td> <td style="width:33%; border-right: 1px solid black; text-align: center;">5/32</td> <td style="width:33%; text-align: center;">-</td> </tr> <tr> <td style="border-right: 1px solid black; text-align: center;">90-110</td> <td style="border-right: 1px solid black; text-align: center;">110-150</td> <td style="text-align: center;">-</td> </tr> <tr> <td style="border-right: 1px solid black; text-align: center;">20</td> <td style="border-right: 1px solid black; text-align: center;">22-23</td> <td style="text-align: center;">-</td> </tr> <tr> <td style="border-right: 1px solid black; text-align: center;">4-9</td> <td style="border-right: 1px solid black; text-align: center;">4-9</td> <td style="text-align: center;">-</td> </tr> </table> <hr/> <p><b>None</b></p> <hr/> <p><b>DCEP (reverse)</b></p> <hr/> <p><b>Stringer and weave bead</b></p>	1/8	5/32	-	90-110	110-150	-	20	22-23	-	4-9	4-9	-
1/8	5/32	-											
90-110	110-150	-											
20	22-23	-											
4-9	4-9	-											
<p>(1) Peening was not used with this weld test.  <u>No Pass &gt; 1/2" t.</u></p>													



INTEGRATED SERVICE COMPANY, L.L.C.

Procedure Qualification Record (PQR)

PQR No.: P1-E-1

Page 2 of 2

Tensile Test (QW-150)

Specimen No.	Diameter (in.)	Area (in <sup>2</sup> )	Ultimate Total Load (lb)	Ultimate Unit Stress (PSI)	Failure Type and Location
1	0.521	0.213	17100	80300	Weld metal
2	0.521	0.213	17400	81700	Weld metal

Guided Bend Tests (QW-160)

Type and Figure No.	Result	Type and Figure No.	Result
QW-462.2 Side bend	Satisfactory	QW-462.2 Side bend	Satisfactory
QW-462.2 Side bend	Satisfactory	QW-462.2 Side bend	Satisfactory

Hardness Test - Brinell hardness

Location	Readings								
SA-515 HAZ	187	185	180						
Weld Metal	180	170	185						

Welder's Name: Herman Kohlmeyer I.D.: \_\_\_\_\_ Stamp No.: K

PQR was done and welding of coupon was witnessed by: Cust-O-Fab Inc

Test conducted by: Metlab Testing Services Lab Test No.: P1-E-1

We certify that the statements in this record are correct and that the test welds were prepared, welded, and tested in accordance with the requirements of Section IX of the ASME Code.

By: \_\_\_\_\_ 3/17/1975 QC Manager  
David S. Graves Date



INTEGRATED SERVICE COMPANY, L.L.C.

1900 N. 161st. E. AVENUE  
TULSA, OKLAHOMA 74116

Welding Procedure Specification (WPS)

WPS No.: 1-S-10 Date: 7/30/2008 Rev. No.: 0

Page 1 of 2

Supporting PQR(s): 7024-A

Weld Type: Groove and fillet welds

<b>BASE METALS (QW-403)</b>		
P-No. <u>1</u> Thickness Range: <u>0.0625 in. to 0.7500 in.</u>		
to P-No. <u>1</u>		
<b>PREHEAT (QW-406)</b>		<b>POSTWELD HEAT TREATMENT (QW-407)</b>
Minimum Preheat Temperature:	<u>60</u> °F	PWHT Type: <u>No PWHT will be performed</u>
Maximum Interpass Temperature:	<u>400</u> °F	PWHT Temperature : <u>None</u> °F
Preheat Maintenance:	<u>None</u>	PWHT Holding Time: <u>None</u>
Weld Process / Method Weld Deposit Limit <b>POSITION (QW-405)</b> Position of Joint Weld Progression <b>FILLER METAL (QW-404)</b> AWS Classification SFA Spec. / F-No. A-No. or Chemical Composition Pass Greater Than 1/2": Filler Metal Size (in.) <b>ELECTRICAL (QW-409)</b> Welding Amperage Range Welding Voltage Range Travel Speed (in/min) Max. Heat Input (J/in) Current Type and Polarity <b>TECHNIQUE (QW-410)</b> Peening Stringer or Weave Bead Multiple / Single Pass (per side)	<b>1st Process</b>	
	<b>SMAW / Manual</b>	
	0.7500 in. maximum	
	<b>Flat only</b>	
	N/A	
	<b>E7024</b>	
	<u>5.1</u> / <u>1</u>	
	<u>1</u>	
	No	
	<u>5/32</u>	<u>3/16</u>   <u>1/4</u>
	<u>170-240</u>	<u>220-300</u>   <u>260-350</u>
	<u>n/r</u>	<u>n/r</u>   <u>n/r</u>
	<u>Var.</u>	<u>Var.</u>   <u>Var.</u>
	None	
	<b>DCEP (reverse)</b>	
None		
<b>Stringer and weave bead</b>		
<b>Multipass</b>		

INTEGRATED SERVICE COMPANY, L.L.C.

Welding Procedure Specification (WPS)

WPS No.: 1-S-10

Rev. No.: 0

Page 2 of 2

JOINT DESIGN (QW-402)

Weld Type: Groove and fillet welds

Joint Type	Backing	Root Opening	Groove Angle	Root Face	Groove Radius
Single-V groove	No backing	3/16" max	50 deg min	1/8" max	
Single bevel	No backing	3/16" max	45 deg min	1/8" max	
Single-V groove	Gouged & back welded	1/4" max	50 deg min	3/16" max	
Double bevel	Gouged & back welded	1/4" max	45 deg min	3/16" max	
Double-V groove	Gouged & back welded	1/4" max	45 deg min	3/16" max	
Square groove	T-joint	1/32" max			
Square groove	No backing	3/32" max			

Fillet Welds: All fillet sizes on all base metal thicknesses and all diameters.

Retainers: None

WELD JOINT DESCRIPTIONS SHOWN ARE NOT INCLUSIVE OF ALL THOSE FOUND ON A JOB. WELD JOINT DESIGN REFERENCE IN AN ENGINEERING SPECIFICATION OR A DESIGN DRAWING SHALL TAKE PRECEDENCE OVER WELD JOINTS SHOWN IN THIS WPS.

Initial and Interpass Cleaning: With wire brush clean 1 inch (25 mm) on both sides of weld joint

Method of Back Gouging: When required, grind until all defects are removed.

Minimum preheat must be maintained during thermal cutting, tacking, and welding operations.

Welds shall be cleaned between each pass. When completed, remove all slag and projections.

We certify that the statements in this specification are correct and in accordance with the requirements of Section IX of the ASME Code.

By: 

David Haas

7/30/2008

Date

QC Process Manager





**INTEGRATED SERVICE COMPANY, L.L.C.**

1900 N. 161st. E. AVENUE  
TULSA, OKLAHOMA 74116

**Procedure Qualification Record (PQR)**

PQR No.: 7024-A

Date: 10/21/1987

WPS No.: 1-S-10

Page 1 of 2

<b>JOINT DESIGN (QW-402)</b> Weld Type: <u>Groove weld</u> Groove Type: <u>Single-V groove</u> Backing: <u>Open butt, no back weld</u> Root Opening: <u>3/32</u> in.      Root Face: <u>1/8</u> in. Groove Angle: <u>60</u> °	<b>BASE METALS (QW-403)</b> Specification Type and Grade: <u>SA-36</u> to <u>SA-36</u> P-No. <u>1</u> Group No. <u>1</u> to P-No. <u>1</u> Group No. <u>1</u> Thickness (in.): <u>0.3750</u>
<b>PREHEAT (QW-406)</b> Minimum Preheat Temperature: <u>100</u> °F Maximum Interpass Temperature: <u>400</u> °F Preheat Maintenance: <u>None after welding</u>	<b>POSTWELD HEAT TREATMENT (QW-407)</b> Type: <u>No PWHT performed</u> PWHT Temperature: <u>None</u> °F PWHT Holding Time: <u>None</u> hr.

<b>Weld Process / Method</b> <b>POSITION (QW-405)</b> Position of Joint Weld Progression <b>FILLER METAL (QW-404)</b> AWS Classification SFA Spec. / F-No. A-No. or Chemical Composition Filler Metal Trade Name Weld Deposit 't' (in.) Pass Greater Than 1/2": Filler Metal Size (in.) <b>ELECTRICAL (QW-409)</b> Amperage Used Voltage Used Travel Speed (in/min) Max. Heat Input (J/in) Current Type and Polarity <b>TECHNIQUE (QW-410)</b> Stringer or Weave Bead	<b>1st Process</b> <b>SMAW / Manual</b>  <b>1G - Flat</b>  <b>N/A</b>  <b>E7024</b> <u>5.1</u> / <u>1</u> <u>1</u> <u>n/r</u> <u>0.3750</u> <u>No</u> <table border="1" style="width: 100%; border-collapse: collapse;"> <tr> <td style="width: 33%; text-align: center;">1/8</td> <td style="width: 33%; text-align: center;">5/32</td> <td style="width: 33%; text-align: center;">3/16</td> </tr> <tr> <td style="text-align: center;">195</td> <td style="text-align: center;">225</td> <td style="text-align: center;">255</td> </tr> <tr> <td style="text-align: center;">24</td> <td style="text-align: center;">27</td> <td style="text-align: center;">28</td> </tr> <tr> <td style="text-align: center;">3-5</td> <td style="text-align: center;">5-7</td> <td style="text-align: center;">6-8</td> </tr> </table> <u>None</u> <b>DCEP (reverse)</b>  <b>Stringer and weave bead</b>	1/8	5/32	3/16	195	225	255	24	27	28	3-5	5-7	6-8	
1/8	5/32	3/16												
195	225	255												
24	27	28												
3-5	5-7	6-8												

(1) Peening was not used with this weld test.

INTEGRATED SERVICE COMPANY, L.L.C.

Procedure Qualification Record (PQR)

PQR No.: 7024-A

Page 2 of 2

Tensile Test (QW-150)

Specimen No.	Width (in.)	Thickness (in.)	Area (in <sup>2</sup> )	Ultimate Total Load (lb)	Ultimate Unit Stress (PSI)	Failure Type and Location
1	1.000	0.375	0.375	28000	74700	Base metal
2	1.000	0.375	0.375	28000	74700	Base metal

Guided Bend Tests (QW-160)

Type and Figure No.	Result	Type and Figure No.	Result
QW-462.3(a) Face bend	Acceptable	QW-462.3(a) Root bend	Acceptable
QW-462.3(a) Face bend	Acceptable	QW-462.3(a) Root bend	Acceptable

Hardness Test - Brinell hardness

Location	Readings								
SA-36 BM	198	181	196						
SA-36 HAZ	188	182	190						
Weld metal	160	163	188						

Visual Examination: Satisfactory

Liquid Penetrant Test: Satisfactory

Added hardness, visual and penetrant results January 12, 2009.

Welder's Name: Charlie Wood

I.D.:

Stamp No.: A

PQR was done and welding of coupon was witnessed by: Cust-O-Fab

Test conducted by: Tulsa Testing and Insp.

Lab Test No.: 7024-A

We certify that the statements in this record are correct and that the test welds were prepared, welded, and tested in accordance with the requirements of Section IX of the ASME Code.

By: David S. Glaves

David S. Glaves

10/21/1987

Date

QC Manager



INTEGRATED SERVICE COMPANY, L.L.C.

1900 N. 161st. E. AVENUE  
TULSA, OKLAHOMA 74116

Welding Procedure Specification (WPS)

WPS No.: 1-S-6 Date: 2/24/1999 Rev. No.: 2 Date: 7/16/1999

Page 1 of 2

Supporting PQR(s): 99-010016-2

Weld Type: Groove and fillet welds

**BASE METALS (QW-403)**

P-No. 1 Thickness Range: 0.1875 in. to 0.8640 in.  
to P-No. 1

**PREHEAT (QW-406)**

Minimum Preheat Temperature: 60 °F  
Maximum Interpass Temperature: 550 °F  
Preheat Maintenance: None after weldment

**POSTWELD HEAT TREATMENT (QW-407)**

PWHT Type: No PWHT will be performed  
PWHT Temperature: None °F  
PWHT Holding Time: None

Weld Process / Method

Weld Deposit Limit

**POSITION (QW-405)**

Position of Joint

Weld Progression

**FILLER METAL (QW-404)**

AWS Classification

SFA Spec. / F-No.

A-No. or Chemical Composition

Filler Metal Trade Name

Pass Greater Than 1/2":

Filler Metal Size (in.)

**ELECTRICAL (QW-409)**

Welding Amperage Range

Welding Voltage Range

Travel Speed (in/min)

Max. Heat Input (J/in)

Current Type and Polarity

**TECHNIQUE (QW-410)**

Peening

Stringer or Weave Bead

1st Process  
**SMAW / Manual**  
0.0000 in. to 0.2500 in.

All Positions  
Any

E6010

5.1 / 3

1

n/r

No

3/32 | 1/8 | 5/32

60-90 | 80-120 | 110-165

n/r | n/r | n/r

Var. | Var. | Var.

None

DCEP (reverse)

None

Stringer and weave bead

(1) No peening done with this procedure.

Revision 2: Progression.

Preheat to 175F if "T" > 1" and C > 0.30%; To 200F if 1.25" < "T" <= 1.5"



INTEGRATED SERVICE COMPANY, L.L.C.

Welding Procedure Specification (WPS)

WPS No.: 1-S-6

Rev. No.: 2

Page 2 of 2

**JOINT DESIGN (QW-402)**

Weld Type: Groove and fillet welds

Joint Type	Backing	Root Opening	Groove Angle	Root Face	Groove Radius
Single-V groove	no backing	3/16" max.	50 degree min.	1/8" max.	
Single-bevel groove	no backing	3/16" max.	45 degree min.	1/8" max.	
Single-V groove	gouged & back welded	1/4" max.	50 degree min.	3/16" max.	
Double-bevel groove	gouged & back welded	1/4" max.	45 degree min.	3/16" max.	
Double-V groove	gouged & back welded	1/4" max.	45 degree min.	3/16" max.	
Square groove	T-joint	1/32" max.			
Square groove	no backing	3/32" max.			

Fillet Welds: All (QW-451.4)

Retainers: None

See fabrication drawing.

WELD JOINT DESCRIPTIONS SHOWN ARE NOT INCLUSIVE OF ALL THOSE FOUND ON A JOB. WELD JOINT DESIGN REFERENCE IN AN ENGINEERING SPECIFICATION OR A DESIGN DRAWING SHALL TAKE PRECEDENCE OVER WELD JOINTS SHOWN IN THIS WPS.

Initial and Interpass Cleaning: With wire brush clean 1" both sides of weld joint.

Method of Back Gouging: When required, grind until all defects are removed.

Minimum preheat must be maintained during thermal cutting, tacking, and welding operations.

Welds shall be cleaned between each pass. When completed, remove all slag and projections.

We certify that the statements in this specification are correct and in accordance with the requirements of Section IX of the ASME Code.

By: *David S. Graves*

David S. Graves

2/24/1999

Date

QC Manager



INTEGRATED SERVICE COMPANY, L.L.C.  
 1900 N. 161st. E. AVENUE  
 TULSA, OKLAHOMA 74116

**Procedure Qualification Record (PQR)**

PQR No.: 99-010016-2

Date: 1/8/1999

WPS No.: 1-S-6

Page 1 of 2

<b>JOINT DESIGN (QW-402)</b> Weld Type: <u>Groove weld</u> Groove Type: <u>Single-V groove</u> Backing: <u>Open butt, no back weld</u> Root Opening: <u>1/8</u> in.    Root Face: <u>1/16</u> in. Groove Angle: <u>75</u> °	<b>BASE METALS (QW-403)</b> Specification Type and Grade: <u>SA-106, Grade B</u> to <u>SA-106, Grade B</u> P-No. <u>1</u> Group No. <u>1</u> to P-No. <u>1</u> Group No. <u>1</u> Thickness (in.): <u>0.4320</u> Diameter (in.): <u>6.6250</u>	
<b>PREHEAT (QW-406)</b> Minimum Preheat Temperature: <u>60</u> °F Maximum Interpass Temperature: <u>350</u> °F Preheat Maintenance: <u>None</u>	<b>POSTWELD HEAT TREATMENT (QW-407)</b> Type: <u>No PWHT performed</u> PWHT Temperature: <u>None</u> °F PWHT Holding Time: <u>None</u> hr.	
<b>Weld Process / Method</b> <b>POSITION (QW-405)</b> Position of Joint Weld Progression <b>FILLER METAL (QW-404)</b> AWS Classification SFA Spec. / F-No. A-No. or Chemical Composition Filler Metal Trade Name Weld Deposit 't' (in.) Pass Greater Than 1/2": Filler Metal Size (in.) <b>ELECTRICAL (QW-409)</b> Amperage Used Voltage Used Travel Speed (in/min) Max. Heat Input (J/in) Current Type and Polarity <b>TECHNIQUE (QW-410)</b> Stringer or Weave Bead	<b>1st Process</b> <b>SMAW / Manual</b>  <u>6G - 45 degree pipe</u> <u>Vertical up and down</u>  <u>E6010</u> <u>5.1</u> / <u>3</u> <u>1</u> <u>n/r</u> <u>0.1250</u> <u>No</u> <u>3/32</u>   <u>-</u>   <u>-</u> <u>90</u>   <u>-</u>   <u>-</u> <u>23</u>   <u>-</u>   <u>-</u> <u>Var.</u>   <u>-</u>   <u>-</u> <u>None</u> <u>DCEP (reverse)</u>  <u>Stringer bead</u>	<b>2nd Process</b> <b>SMAW / Manual</b>  <u>6G - 45 degree pipe</u> <u>Vertical up and down</u>  <u>E7018</u> <u>5.1</u> / <u>4</u> <u>1</u> <u>n/r</u> <u>0.3070</u> <u>No</u> <u>1/8</u>   <u>-</u>   <u>-</u> <u>100</u>   <u>-</u>   <u>-</u> <u>24</u>   <u>-</u>   <u>-</u> <u>Var.</u>   <u>-</u>   <u>-</u> <u>None</u> <u>DCEP (reverse)</u>  <u>Stringer bead</u>
(1) Peening was not used with this weld test. Revised to define root pass progression up, fill passes down.		

**INTEGRATED SERVICE COMPANY, L.L.C.**

**Procedure Qualification Record (PQR)**

PQR No.: 99-010016-2

Page 2 of 2

**Tensile Test (QW-150)**

Specimen No.	Width (in.)	Thickness (in.)	Area (in <sup>2</sup> )	Ultimate Total Load (lb)	Ultimate Unit Stress (PSI)	Failure Type and Location
1	0.743	0.399	0.296	24110	81500	Ductile - BM
2	0.745	0.384	0.286	23890	83500	Ductile - BM

**Guided Bend Tests (QW-160)**

Type and Figure No.	Result	Type and Figure No.	Result
QW-462.2 Side bend	Satisfactory	QW-462.2 Side bend	Satisfactory
QW-462.2 Side bend	Satisfactory	QW-462.2 Side bend	Satisfactory

**Hardness Test - Brinell hardness**

Location	Readings							
SA-106 BM	150	150	160					
SA-106 HAZ	185	185	190					
Weld Metal	190	190	185					

Welder's Name: Jesse Hobbs I.D.: \_\_\_\_\_ Stamp No.: JH

PQR was done and welding of coupon was witnessed by: Cust-O-Fab Service Co.

Test conducted by: Sherry Laboratories Lab Test No.: 99-010016-2

We certify that the statements in this record are correct and that the test welds were prepared, welded, and tested in accordance with the requirements of Section IX of the ASME Code.

By: David S. Glaves Date 1/8/1999 QC Manager

David S. Glaves

Date





INTEGRATED SERVICE COMPANY, L.L.C.

1900 N. 161st. E. AVENUE  
TULSA, OKLAHOMA 74116

Welding Procedure Specification (WPS)

WPS No.: 1-S-4 Date: 1/8/1999 Rev. No.: 0

Page 1 of 2

Supporting PQR(s): 99-010016-2

Weld Type: Groove and fillet welds

<b>BASE METALS (QW-403)</b>						
P-No. <u>1</u> Thickness Range: <u>0.1875 in. to 0.8640 in.</u>						
to P-No. <u>1</u>						
<b>PREHEAT (QW-406)</b>		<b>POSTWELD HEAT TREATMENT (QW-407)</b>				
Minimum Preheat Temperature: <u>60</u> °F		PWHT Type: <u>No PWHT will be performed</u>				
Maximum Interpass Temperature: <u>350</u> °F		PWHT Temperature: <u>None</u> °F				
Preheat Maintenance: <u>None</u>		PWHT Holding Time: <u>None</u>				
Weld Process / Method Weld Deposit Limit <b>POSITION (QW-405)</b> Position of Joint Weld Progression <b>FILLER METAL (QW-404)</b> AWS Classification SFA Spec. / F-No. A-No. or Chemical Composition Pass Greater Than 1/2": Filler Metal Size (in.) <b>ELECTRICAL (QW-409)</b> Welding Amperage Range Welding Voltage Range Travel Speed (in/min) Max. Heat Input (J/in) Current Type and Polarity <b>TECHNIQUE (QW-410)</b> Peening Stringer or Weave Bead Multiple / Single Pass (per side)	<b>1st Process</b>		<b>2nd Process</b>			
	<b>SMAW / Manual</b>		<b>SMAW / Manual</b>			
	0.2500 in. maximum		0.6140 in. maximum			
	All Positions		All Positions			
	Any		Vertical up			
	E6010		E7018			
	5.1 / 3		5.1 / 4			
	1		1			
	No		No			
	3/32	1/8	5/32	3/32	1/8	5/32
	60-90	80-120	110-165	70-110	90-160	130-220
	n/r	n/r	n/r	n/r	n/r	n/r
	Var.	Var.	Var.	Var.	Var.	Var.
	None		None			
	DCEP (reverse)		DCEP (reverse)			
None		None				
Stringer bead		Stringer bead				
Multipass		Multipass				

INTEGRATED SERVICE COMPANY, L.L.C.

Welding Procedure Specification (WPS)

WPS No.: 1-S-4

Rev. No.: 0

Page 2 of 2

**JOINT DESIGN (QW-402)**

Weld Type: Groove and fillet welds

Joint Type	Backing	Root Opening	Groove Angle	Root Face	Groove Radius
Single-V groove	No backing	3/16" max	50 deg min	1/8" max	
Single bevel	No backing	3/16" max	45 deg min	1/8" max	
Single-V groove	Gouged & back welded	1/4" max	50 deg min	3/16" max	
Double bevel	Gouged & back welded	1/4" max	45 deg min	3/16" max	
Double-V groove	Gouged & back welded	1/4" max	45 deg min	3/16" max	
Square groove	T-joint	1/32" max			
Square groove	No backing	3/32" max			

Fillet Welds: All fillet sizes on all base metal thicknesses and all diameters.

Retainers: None

WELD JOINT DESCRIPTIONS SHOWN ARE NOT INCLUSIVE OF ALL THOSE FOUND ON A JOB. WELD JOINT DESIGN REFERENCE IN AN ENGINEERING SPECIFICATION OR A DESIGN DRAWING SHALL TAKE PRECEDENCE OVER WELD JOINTS SHOWN IN THIS WPS.

Initial and Interpass Cleaning: With wire brush clean 1 inch (25 mm) on both sides of weld joint

Method of Back Gouging: When required, grind until all defects are removed.

Minimum preheat must be maintained during thermal cutting, tacking, and welding operations.

Welds shall be cleaned between each pass. When completed, remove all slag and projections.

We certify that the statements in this specification are correct and in accordance with the requirements of Section IX of the ASME Code.

By: *David S. Glaves*

David S. Glaves

1/8/1999

Date

QC Manager



**INTEGRATED SERVICE COMPANY, L.L.C.**

1900 N. 161st. E. AVENUE  
TULSA, OKLAHOMA 74116

**Procedure Qualification Record (PQR)**

PQR No.: **99-010016-2**

Date: **1/8/1999**

WPS No.: **1-S-4**

Page 1 of 2

<p><b>JOINT DESIGN (QW-402)</b>  Weld Type: <u>Groove weld</u>  Groove Type: <u>Single-V groove</u>  Backing: <u>Open butt, no back weld</u>  Root Opening: <u>1/8</u> in.    Root Face: <u>1/16</u> in.  Groove Angle: <u>75</u> °</p>	<p><b>BASE METALS (QW-403)</b>  Specification Type and Grade:  <u>SA-106, Grade B</u> to <u>SA-106, Grade B</u>  P-No. <u>1</u> Group No. <u>1</u> to P-No. <u>1</u> Group No. <u>1</u>  Thickness (in.): <u>0.4320</u>  Diameter (in.): <u>6.6250</u></p>	
<p><b>PREHEAT (QW-406)</b>  Minimum Preheat Temperature: <u>60</u> °F  Maximum Interpass Temperature: <u>350</u> °F  Preheat Maintenance: <u>None</u></p>	<p><b>POSTWELD HEAT TREATMENT (QW-407)</b>  Type: <u>No PWHT performed</u>  PWHT Temperature: <u>None</u> °F  PWHT Holding Time: <u>None</u> hr.</p>	
<p><b>Weld Process / Method POSITION (QW-405)</b>  Position of Joint  Weld Progression  <b>FILLER METAL (QW-404)</b>  AWS Classification  SFA Spec. / F-No.  A-No. or Chemical Composition  Filler Metal Trade Name  Weld Deposit 't' (in.)  Pass Greater Than 1/2":  Filler Metal Size (in.)  <b>ELECTRICAL (QW-409)</b>  Amperage Used  Voltage Used  Travel Speed (in/min)  Max. Heat Input (J/in)  Current Type and Polarity  <b>TECHNIQUE (QW-410)</b>  Stringer or Weave Bead</p>	<p><b>1st Process</b>  <b>SMAW / Manual</b>   <u>6G - 45 degree pipe</u>  <u>Vertical up and down</u>   <u>E6010</u>  <u>5.1</u> / <u>3</u>  <u>1</u>  <u>n/r</u>  <u>0.1250</u>  <u>No</u>  <u>3/32</u>   <u>-</u>   <u>-</u>  <u>90</u>   <u>-</u>   <u>-</u>  <u>23</u>   <u>-</u>   <u>-</u>  <u>Var.</u>   <u>-</u>   <u>-</u>  <u>None</u>  <u>DCEP (reverse)</u>   <u>Stringer bead</u></p>	<p><b>2nd Process</b>  <b>SMAW / Manual</b>   <u>6G - 45 degree pipe</u>  <u>Vertical up and down</u>   <u>E7018</u>  <u>5.1</u> / <u>4</u>  <u>1</u>  <u>n/r</u>  <u>0.3070</u>  <u>No</u>  <u>1/8</u>   <u>-</u>   <u>-</u>  <u>100</u>   <u>-</u>   <u>-</u>  <u>24</u>   <u>-</u>   <u>-</u>  <u>Var.</u>   <u>-</u>   <u>-</u>  <u>None</u>  <u>DCEP (reverse)</u>   <u>Stringer bead</u></p>
<p>(1) Peening was not used with this weld test.  Revised to define root pass progression up, fill passes down.</p>		



INTEGRATED SERVICE COMPANY, L.L.C.

Procedure Qualification Record (PQR)

PQR No.: 99-010016-2

Page 2 of 2

Tensile Test (QW-150)

Specimen No.	Width (in.)	Thickness (in.)	Area (in <sup>2</sup> )	Ultimate Total Load (lb)	Ultimate Unit Stress (PSI)	Failure Type and Location
1	0.743	0.399	0.296	24110	81500	Ductile - BM
2	0.745	0.384	0.286	23890	83500	Ductile - BM

Guided Bend Tests (QW-160)

Type and Figure No.	Result	Type and Figure No.	Result
QW-462.2 Side bend	Satisfactory	QW-462.2 Side bend	Satisfactory
QW-462.2 Side bend	Satisfactory	QW-462.2 Side bend	Satisfactory

Hardness Test - Brinell hardness

Location	Readings								
SA-106 BM	150	150	160						
SA-106 HAZ	185	185	190						
Weld Metal	190	190	185						

Welder's Name: Jesse Hobbs

I.D.:

Stamp No.: JH

PQR was done and welding of coupon was witnessed by: Cust-O-Fab Service Co.

Test conducted by: Sherry Laboratories

Lab Test No.: 99-010016-2

We certify that the statements in this record are correct and that the test welds were prepared, welded, and tested in accordance with the requirements of Section IX of the ASME Code.

By: *David S. Glaves*

David S. Glaves

1/8/1999

Date

QC Manager



**INTEGRATED SERVICE COMPANY, L.L.C.**

1900 N. 161st. E. AVENUE  
TULSA, OKLAHOMA 74116

**Welding Procedure Specification (WPS)**

WPS No.: 1-TS-1 Date: 7/20/1994 Rev. No.: 0

Page 1 of 2

Supporting PQR(s): 92-159-1

Weld Type: Groove and fillet welds

<b>BASE METALS (QW-403)</b>				
P-No. <u>1</u> Thickness Range: <u>0.1875 in. to 1.5000 in.</u>				
to P-No. <u>1</u>				
<b>PREHEAT (QW-406)</b>		<b>POSTWELD HEAT TREATMENT (QW-407)</b>		
Minimum Preheat Temperature: <u>200</u> °F		PWHT Type: <u>No PWHT will be performed</u>		
Maximum Interpass Temperature: <u>550</u> °F		PWHT Temperature: <u>None</u> °F		
Preheat Maintenance: <u>None after weldment</u>		PWHT Holding Time: <u>None</u>		
Weld Process / Method Weld Deposit Limit <b>POSITION (QW-405)</b> Position of Joint Weld Progression <b>GAS (QW-408)</b> Shielding Gas / CFH Trailing Gas / CFH Backing Gas / CFH <b>FILLER METAL (QW-404)</b> AWS Classification SFA Spec. / F-No. A-No. or Chemical Composition Filler Metal Trade Name Filler Metal Product Form Consumable Insert Pass Greater Than 1/2": Filler Metal Size (in.) <b>ELECTRICAL (QW-409)</b> Welding Amperage Range Welding Voltage Range Travel Speed (in/min) Max. Heat Input.(J/in) Current Type and Polarity Tungsten Type / Size Pulsed Current <b>TECHNIQUE (QW-410)</b> Peening Stringer or Weave Bead Multiple / Single Pass (per side) Nozzle / Gas Cup Size	<b>1st Process</b>			
	<b>GTAW / Manual</b>		<b>2nd Process</b>	
	0.0000 in. to 0.3750 in.		<b>SMAW / Manual</b>	
	0.0000 in. to 1.1250 in.			
	All Positions		All Positions	
	Any		Vertical up	
	100% Argon	/	27-36	
	None	/	-	
	None	/	-	
	ER70S-2		E7018	
	5.18	/	6	
	1		1	
	n/r		n/r	
	Bare (Solid)			
	None		No	
	1/16		3/32	
			1/8	
	5/32		3/16	
		7/32		
70-150		80-180		
		130-275		
130-220		200-300		
		250-350		
n/r		n/r		
		n/r		
Var.		Var.		
		Var.		
None		None		
DCEN (straight)		DCEP (reverse)		
EWTh-2	/	1/16" - 3/16"		
None				
None		None		
Stringer and weave bead		Stringer and weave bead		
Multipass				
# 5 to # 10				
(1) <u>No peening done with this procedure.</u>				
<u>No pass greater than 1/2" allowed.</u>				
<u>Preheat to 200 Deg.F.for repairs.</u>				
<u>Preheat to 175F if "T" &gt; 1" and C &gt; 0.30%;To 200F if 1.25 &lt; "T" &lt;= 1.5"</u>				

INTEGRATED SERVICE COMPANY, L.L.C.

Welding Procedure Specification (WPS)

WPS No.: 1-TS-1

Rev. No.: 0

Page 2 of 2

**JOINT DESIGN (QW-402)**

Weld Type: Groove and fillet welds

Joint Type	Backing	Root Opening	Groove Angle	Root Face	Groove Radius
Single-V groove	no backing	3/16" max.	50 degree min.	1/8" max.	
Single-bevel groove	no backing	3/16" max.	45 degree min.	1/8" max.	
Single-V groove	gouged & back welded	1/4" max.	50 degree min.	3/16" max.	
Double-bevel groove	gouged & back welded	1/4" max.	45 degree min.	3/16" max.	
Double-V groove	gouged & back welded	1/4" max.	45 degree min.	3/16" max.	
Square groove	T-joint	1/32" max.			
Square groove	no backing	3/32" max.			

Fillet Welds: All (QW-451.4)

Retainers: None

See fabrication drawing.

WELD JOINT DESCRIPTIONS SHOWN ARE NOT INCLUSIVE OF ALL THOSE FOUND ON A JOB. WELD JOINT DESIGN REFERENCE IN AN ENGINEERING SPECIFICATION OR A DESIGN DRAWING SHALL TAKE PRECEDENCE OVER WELD JOINTS SHOWN IN THIS WPS.

Initial and Interpass Cleaning: With wire brush clean 1" both sides of weld joint.

Method of Back Gouging: Grind until all defects are removed.

Minimum preheat must be maintained during thermal cutting, tacking, and welding operations.

Welds shall be cleaned between each pass. When completed, remove all slag and projections.

We certify that the statements in this specification are correct and in accordance with the requirements of Section IX of the ASME Code.

By: *David S. Glaves*

David S. Glaves

7/20/1994

Date

QC Manager





**INTEGRATED SERVICE COMPANY, L.L.C.**

1900 N. 161st. E. AVENUE  
TULSA, OKLAHOMA 74116

**Procedure Qualification Record (PQR)**

PQR No.: 92-159-1

Date: 1/10/1992

WPS No.: 1-TS-1

Page 1 of 3

**JOINT DESIGN (QW-402)**  
 Weld Type: Groove weld  
 Groove Type: Single-V groove  
 Backing: Open butt, no back weld  
 Root Opening: 1/8 in. Root Face: 1/32 in.  
 Groove Angle: 60-70 °  
 None

**BASE METALS (QW-403)**  
 Specification Type and Grade:  
SA-516, Grade 70 to SA-516, Grade 70  
 P-No. 1 Group No. 2 to P-No. 1 Group No. 2  
 Thickness (in.): 0.7500  
 None

**PREHEAT (QW-406)**  
 Minimum Preheat Temperature: 175 °F  
 Maximum Interpass Temperature: 450 °F  
 Preheat Maintenance: None after weldment  
 None

**POSTWELD HEAT TREATMENT (QW-407)**  
 Type: No PWHT performed  
 PWHT Temperature: None °F  
 PWHT Holding Time: None hr.  
 N/A

	1st Process GTAW / Manual	2nd Process SMAW / Manual
Weld Process / Method	GTAW / Manual	SMAW / Manual
POSITION (QW-405)	1G - Flat	1G - Flat
Position of Joint	N/A	N/A
Weld Progression	None	None
Notes		
GAS (QW-408)	100% Argon / 30	
Shielding Gas / CFH	None / -	
Trailing Gas / CFH	None / -	
Backing Gas / CFH		
FILLER METAL (QW-404)	ER70S-2	E7018
AWS Classification	5.18 / 6	5.1 / 4
SFA Spec. / F-No.	1	1
A-No. or Chemical Composition	n/r	n/r
Filler Metal Trade Name	Bare (Solid)	
Filler Metal Product Form	None	
Consumable Insert	N/A	
GTAW Flux	0.1875	0.5625
Weld Deposit 't' (in.)		No
Pass Greater Than 1/2":	3/32   -   -	5/32   3/16   -
Filler Metal Size (in.)		
ELECTRICAL (QW-409)	120   -   -	175   225   -
Amperage Used	18   -   -	24   28   -
Voltage Used	Var.   -   -	Var.   Var.   -
Travel Speed (in/min)		
Max. Heat Input (J/in)	NR	NR
Current Type and Polarity	DCEN (straight)	DCEP (reverse)
Tungsten Type / Size	EWTh-2 / 1/8	
Pulsed Current	None	
TECHNIQUE (QW-410)	No	No
Thermal Processes:	Stringer bead	Stringer bead
Stringer or Weave Bead	Multipass	Multipass
Multiple / Single Pass (per side)	# 8	
Nozzle / Gas Cup Size		

- (1) (1) Peening was not used with this weld test.
- (2) No Pass > 1/2" t.
- 10-20-08; corrected typo "No Thermal Processes".

(2) None

Joint Detail Image

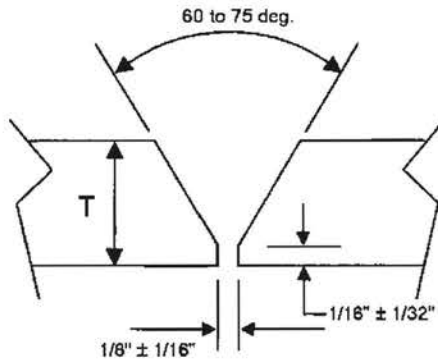

SINGLE VEE GROOVE

INTEGRATED SERVICE COMPANY, L.L.C.

Procedure Qualification Record (PQR)

PQR No.: 92-159-1

Page 3 of 3

**Tensile Test (QW-150)**

Specimen No.	Width (in.)	Thickness (in.)	Area (in <sup>2</sup> )	Ultimate Total Load (lb)	Ultimate Unit Stress (PSI)	Failure Type and Location
1	0.754	0.760	0.573	43400	75700	Base metal
2	0.750	0.755	0.566	43000	76000	Base metal

**Guided Bend Tests (QW-160)**

Type and Figure No.	Result	Type and Figure No.	Result
QW-462.2 Side bend	Satisfactory	QW-462.2 Side bend	Satisfactory
QW-462.2 Side bend	Satisfactory	QW-462.2 Side bend	Satisfactory

**Hardness Test - Brinell hardness**

Location	Readings								
SA-516 BM	140	156	146						
SA-516 HAZ	167	174	174						
Weld Metal	149	140	156						

Visual Examination: Satisfactory

None

Welder's Name: Paul Stokes I.D.: - Stamp No.: R

PQR was done and welding of coupon was witnessed by: Integrated Service Company LLC

Test conducted by: Metlab Testing Services Lab Test No.: 92-159-1

We certify that the statements in this record are correct and that the test welds were prepared, welded, and tested in accordance with the requirements of Section IX of the ASME Code.

By: Roy Laird Roy Laird Date: 1/10/1992 MFG QC Manager





INTEGRATED SERVICE COMPANY, L.L.C.

1900 N. 161st. E. AVENUE  
TULSA, OKLAHOMA 74116

Welding Procedure Specification (WPS)

WPS No.: 1-F-1 Date: 7/13/1994 Rev. No.: 0

Page 1 of 2

Supporting PQR(s): 90-1884-6 ; 92-2474

Weld Type: Groove and fillet welds

**BASE METALS (QW-403)**

P-No. 1 Thickness Range: 0.0625 in. to 1.5000 in.  
to P-No. 1

**PREHEAT (QW-406)**

Minimum Preheat Temperature: 50 °F  
Maximum Interpass Temperature: 600 °F  
Preheat Maintenance: None after weldment

**POSTWELD HEAT TREATMENT (QW-407)**

PWHT Type: No PWHT will be performed  
PWHT Temperature : None °F  
PWHT Holding Time: None

Weld Process / Method	1st Process		
Weld Deposit Limit	FCAW / Semiautomatic		
POSITION (QW-405)	0.0000 in. to 1.5000 in.		
Position of Joint	All Positions		
Weld Progression	Vertical up		
GAS (QW-408)	75% Argon, 25% CO2 / 23-30		
Shielding Gas / CFH	None / -		
Trailing Gas / CFH	None / -		
Backing Gas / CFH	None / -		
FILLER METAL (QW-404)	E71T-1		
AWS Classification	5.20 / 6		
SFA Spec. / F-No.	1		
A-No. or Chemical Composition	n/r		
Filler Metal Trade Name	Flux cored		
Filler Metal Product Form	None		
Supplemental Filler Metal	No		
Pass Greater Than 1/2":	0.035   0.045   1/16		
Filler Metal Size (in.)	120-200   170-270   225-300		
ELECTRICAL (QW-409)	19-24   22-26   25-28		
Welding Amperage Range	Var.   Var.   Var.		
Welding Voltage Range	None		
Travel Speed (in/min)	DCEP (reverse)		
Max. Heat Input (J/in)	Globular arc		
Current Type and Polarity	None		
Transfer Mode	Stringer and weave bead		
TECHNIQUE (QW-410)	Multipass		
Peening	1/2"-3/4"		
Stringer or Weave Bead	1/2"-1"		
Multiple / Single Pass (per side)			
Nozzle / Gas Cup Size			
Contact Tube to Work Distance			

- (1) No peening done with this procedure.  
No pass greater than 1/2" allowed.  
Preheat to 175F if "T" > 1" and C > 0.30%; To 200F if 1.25 < "T" <= 1.5"

INTEGRATED SERVICE COMPANY, L.L.C.

Welding Procedure Specification (WPS)

WPS No.: 1-F-1

Rev. No.: 0

Page 2 of 2

**JOINT DESIGN (QW-402)**

Weld Type: Groove and fillet welds

Joint Type	Backing	Root Opening	Groove Angle	Root Face	Groove Radius
Single-V groove	no backing	3/16" max.	50 degree min.	1/8" max.	
Single-bevel groove	no backing	3/16" max.	45 degree min.	1/8" max.	
Single-V groove	gouged & back welded	1/4" max.	50 degree min.	3/16" max.	
Double-bevel groove	gouged & back welded	1/4" max.	45 degree min.	3/16" max.	
Double-V groove	gouged & back welded	1/4" max.	45 degree min.	3/16" max.	
Square groove	T-joint	1/32" max.			
Square groove	no backing	3/32" max.			

Fillet Welds: All (QW-451.4)

Retainers: None

See fabrication drawing.

WELD JOINT DESCRIPTIONS SHOWN ARE NOT INCLUSIVE OF ALL THOSE FOUND ON A JOB. WELD JOINT DESIGN REFERENCE IN AN ENGINEERING SPECIFICATION OR A DESIGN DRAWING SHALL TAKE PRECEDENCE OVER WELD JOINTS SHOWN IN THIS WPS.

Initial and Interpass Cleaning: With wire brush clean 1" both sides of weld joint.

Method of Back Gouging: Grind until all defects are removed.

Minimum preheat must be maintained during thermal cutting, tacking, and welding operations.

Welds shall be cleaned between each pass. When completed, remove all slag and projections.

We certify that the statements in this specification are correct and in accordance with the requirements of Section IX of the ASME Code.

By: David S. Glaves

David S. Glaves

7/13/1994

Date

QC Manager



**INTEGRATED SERVICE COMPANY, L.L.C.**

1900 N. 161st. E. AVENUE  
TULSA, OKLAHOMA 74116

**Procedure Qualification Record (PQR)**

PQR No.: **90-1884-6**

Date: **4/4/1990**

WPS No.: **1-F-1**

Page 1 of 2

<p><b>JOINT DESIGN (QW-402)</b>  Weld Type: <u>Groove weld</u>  Groove Type: <u>Single-V groove</u>  Backing: <u>Open butt, no back weld</u>  Root Opening: <u>1/8</u> in.    Root Face: <u>1/16</u> in.  Groove Angle: <u>60</u> °</p> <p><b>PREHEAT (QW-406)</b>  Minimum Preheat Temperature: <u>50</u> °F  Maximum Interpass Temperature: <u>400</u> °F  Preheat Maintenance: <u>None after weldment</u></p>	<p><b>BASE METALS (QW-403)</b>  Specification Type and Grade: <u>SA-516, Grade 70</u> to <u>SA-516, Grade 70</u>  P-No. <u>1</u> Group No. <u>2</u> to P-No. <u>1</u> Group No. <u>2</u>  Thickness (in.): <u>0.7500</u></p> <p><b>POSTWELD HEAT TREATMENT (QW-407)</b>  Type: <u>No PWHT performed</u>  PWHT Temperature: <u>None</u> °F  PWHT Holding Time: <u>None</u> hr.</p>																																																															
<p><b>Weld Process / Method</b>  <b>POSITION (QW-405)</b>  Position of Joint  Weld Progression  <b>GAS (QW-408)</b>  Shielding Gas / CFH  Trailing Gas / CFH  Backing Gas / CFH  <b>FILLER METAL (QW-404)</b>  AWS Classification  SFA Spec. / F-No.  A-No. or Chemical Composition  Filler Metal Trade Name  Filler Metal Product Form  Supplemental Filler Metal  Weld Deposit 't' (in.)  Pass Greater Than 1/2":  Filler Metal Size (in.)  <b>ELECTRICAL (QW-409)</b>  Amperage Used  Voltage Used  Travel Speed (in/min)  Max. Heat Input (J/in)  Current Type and Polarity  Transfer Mode  <b>TECHNIQUE (QW-410)</b>  Stringer or Weave Bead  Multiple / Single Pass (per side)  Nozzle / Gas Cup Size  Contact Tube to Work Distance</p>	<p>1st Process  <b>FCAW / Semiautomatic</b></p> <p>1G - Flat</p> <p>N/A</p> <table style="width:100%; border-collapse: collapse;"> <tr><td style="width:50%;">75% Argon, 25% CO2</td><td style="width:10%; text-align: center;">/</td><td style="width:40%; text-align: center;">25</td></tr> <tr><td>None</td><td style="text-align: center;">/</td><td style="text-align: center;">-</td></tr> <tr><td>None</td><td style="text-align: center;">/</td><td style="text-align: center;">-</td></tr> </table> <p>E71T-1</p> <table style="width:100%; border-collapse: collapse;"> <tr><td style="width:50%; text-align: center;">5.20</td><td style="width:10%; text-align: center;">/</td><td style="width:40%; text-align: center;">6</td></tr> <tr><td colspan="3" style="text-align: center;">1</td></tr> <tr><td colspan="3" style="text-align: center;">n/r</td></tr> <tr><td colspan="3" style="text-align: center;">Flux cored</td></tr> <tr><td colspan="3" style="text-align: center;">None</td></tr> <tr><td colspan="3" style="text-align: center;">0.7500</td></tr> <tr><td colspan="3" style="text-align: center;">No</td></tr> <tr><td style="width:50%;">0.0450</td><td style="width:10%; text-align: center;"> </td><td style="width:40%; text-align: center;">-</td></tr> <tr><td style="width:50%;">200-225</td><td style="width:10%; text-align: center;"> </td><td style="width:40%; text-align: center;">-</td></tr> <tr><td style="width:50%;">20-24</td><td style="width:10%; text-align: center;"> </td><td style="width:40%; text-align: center;">-</td></tr> <tr><td style="width:50%;">12-22</td><td style="width:10%; text-align: center;"> </td><td style="width:40%; text-align: center;">-</td></tr> <tr><td colspan="3" style="text-align: center;">27000</td></tr> <tr><td colspan="3" style="text-align: center;">DCEP (reverse)</td></tr> <tr><td colspan="3" style="text-align: center;">Globular arc</td></tr> <tr><td colspan="3" style="text-align: center;">Stringer and weave bead</td></tr> <tr><td colspan="3" style="text-align: center;">Multipass</td></tr> <tr><td colspan="3" style="text-align: center;">5/8"</td></tr> <tr><td colspan="3" style="text-align: center;">1/2"-1"</td></tr> </table>	75% Argon, 25% CO2	/	25	None	/	-	None	/	-	5.20	/	6	1			n/r			Flux cored			None			0.7500			No			0.0450		-	200-225		-	20-24		-	12-22		-	27000			DCEP (reverse)			Globular arc			Stringer and weave bead			Multipass			5/8"			1/2"-1"		
75% Argon, 25% CO2	/	25																																																														
None	/	-																																																														
None	/	-																																																														
5.20	/	6																																																														
1																																																																
n/r																																																																
Flux cored																																																																
None																																																																
0.7500																																																																
No																																																																
0.0450		-																																																														
200-225		-																																																														
20-24		-																																																														
12-22		-																																																														
27000																																																																
DCEP (reverse)																																																																
Globular arc																																																																
Stringer and weave bead																																																																
Multipass																																																																
5/8"																																																																
1/2"-1"																																																																
<p>(1) Peening was not used with this weld test.  No Pass &gt; 1/2" L.  Added Impact Test per Lab#99-050033-1</p>																																																																



INTEGRATED SERVICE COMPANY, L.L.C.

Procedure Qualification Record (PQR)

PQR No.: 90-1884-6

Page 2 of 2

**Tensile Test (QW-150)**

Specimen No.	Width (in.)	Thickness (in.)	Area (in <sup>2</sup> )	Ultimate Total Load (lb)	Ultimate Unit Stress (PSI)	Failure Type and Location
1	0.982	0.760	0.746	66200	88700	Base metal
2	0.982	0.755	0.741	65500	88400	Base metal

**Hardness Test - Vickers hardness**

Location	Readings								
	SA-516 BM	167	156	168	156	167	156		
SA-516 HAZ	174	170	170	173	170	173	175	170	168
Weld Metal	172	176	174	166	167	170	168	165	

Visual Examination: Satisfactory

Liquid Penetrant Test: Satisfactory

Deposit Chemistry: C=0.06, Mn=1.35, P=0.009, S=0.016, Si=0.58, Cu=0.01, Ni=0.05, Cr=0.03, Mo=0.02

No addition/deletion of supplemental filler metal or powder filler metal.

Vickers hardness test performed by Weeks Lab. 8-21-08 for Inserv.

Welder's Name: Ron Cody

I.D.: \_\_\_\_\_

Stamp No.: T

PQR was done and welding of coupon was witnessed by: Cust-O-Fab Inc

Test conducted by: Metlab Testing Services

Lab Test No.: 90-1884-6

We certify that the statements in this record are correct and that the test welds were prepared, welded, and tested in accordance with the requirements of Section IX of the ASME Code.

By: David S. Glaves

David S. Glaves

8/21/2008

Date

QC Manager



Procedure Qualification Record (PQR)

PQR No.: 92-2474

Date: 4/22/1992

WPS No.: 1-F-1

Page 1 of 2

<b>JOINT DESIGN (QW-402)</b> Weld Type: Groove weld Groove Type: Single-V groove Backing: Open butt, no back weld Root Opening: 1/8 in. Root Face: 1/16 in. Groove Angle: 60°		<b>BASE METALS (QW-403)</b> Specification Type and Grade: SA-516, Grade 70 to SA-516, Grade 70 P-No. 1 Group No. 2 to P-No. 1 Group No. 2 Thickness (in.): 0.3750	
<b>PREHEAT (QW-406)</b> Minimum Preheat Temperature: 60 °F Maximum Interpass Temperature: 450 °F Preheat Maintenance: None after weldment		<b>POSTWELD HEAT TREATMENT (QW-407)</b> Type: No PWHT performed PWHT Temperature: None °F PWHT Holding Time: None hr.	
<b>Weld Process / Method</b> <b>POSITION (QW-405)</b> Position of Joint Weld Progression <b>GAS (QW-408)</b> Shielding Gas / CFH Trailing Gas / CFH Backing Gas / CFH <b>FILLER METAL (QW-404)</b> AWS Classification SFA Spec. / F-No. A-No. or Chemical Composition Filler Metal Trade Name Filler Metal Product Form Supplemental Filler Metal Weld Deposit 't' (in.) Pass Greater Than 1/2": Filler Metal Size (in.) <b>ELECTRICAL (QW-409)</b> Amperage Used Voltage Used Travel Speed (in/min) Max. Heat Input (J/in) Current Type and Polarity Transfer Mode <b>TECHNIQUE (QW-410)</b> Stringer or Weave Bead Multiple / Single Pass (per side) Nozzle / Gas Cup Size Contact Tube to Work Distance	1st Process <b>FCAW / Semiautomatic</b>		
	1G - Flat		
	N/A		
	75% Argon, 25% CO2 / 25		
	None / -		
	None / -		
	E71T-1		
	5.20 / 6		
	1		
	n/r		
	Flux cored		
	None		
	0.3750		
	No		
	0.0450   -   -		
	170-270   -   -		
	24-28   -   -		
Var.   -   -			
None			
DCEP (reverse)			
Globular arc			
Stringer and weave bead			
Multipass			
5/8"			
1/2"-3/4"			
(1) Peening was not used with this weld test. Revised to indicate globular arc FCAW transfer mode.			

INTEGRATED SERVICE COMPANY, L.L.C.

Procedure Qualification Record (PQR)

PQR No.: 92-2474

Page 2 of 2

Tensile Test (QW-150)

Specimen No.	Width (in.)	Thickness (in.)	Area (in <sup>2</sup> )	Ultimate Total Load (lb)	Ultimate Unit Stress (PSI)	Failure Type and Location
1	0.758	0.354	0.268	23800	88800	Base metal
2	0.756	0.334	0.253	22400	88500	Base metal

Guided Bend Tests (QW-160)

Type and Figure No.	Result	Type and Figure No.	Result
QW-462.2 Side bend	Satisfactory	QW-462.2 Side bend	Satisfactory
QW-462.2 Side bend	Satisfactory	QW-462.2 Side bend	Satisfactory

Hardness Test - Brinell hardness

Location	Readings						
SA-516 BM	156	170	159				
SA-516 HAZ	163	183	174				
Weld Metal	187	192	200				

Welder's Name: Rick Barbee I.D.: \_\_\_\_\_ Stamp No.: YY

PQR was done and welding of coupon was witnessed by: Cust-O-Fab Inc

Test conducted by: Metlab Testing Services Lab Test No.: 92-2474

We certify that the statements in this record are correct and that the test welds were prepared, welded, and tested in accordance with the requirements of Section IX of the ASME Code.

By: David S. Glaves

David S. Glaves

4/22/1992

Date

QC Manager





## **APPENDIX G**

### **PROJECT DATA – PERSONNEL RESUMES & CERTIFICATIONS**



<b>Project Manager – Engineering, Procurement &amp; Construction</b>	
<b>Tim Anderson</b>	
<b>Summary of Proposed Duties and Responsibilities</b> [002200, ¶ 7.2.1] Develops task order proposals, including estimates project schedules, statements of work, and execution plans. Implements work plans for awarded task orders to ensure successful performance of awarded task orders. Coordinates closely with project engineer and program manager on technical issues. Coordinates daily with Site Manager to identify various risks and schedule inspections, etc. during planning and execution phase. Directs and monitors all field operations to ensure successful performance. Responsible for implementing quality control and safety programs on assigned task orders.	
<b>Education:</b>	B.S. Mechanical Engineering, 1994
<b>Registrations:</b>	DOT Registered Engineer, Tanks and vessels, CT-6199 Certified Inspector : API 570 Piping Inspector #1080, API 653 Tank Inspector #494 and API 510 Pressure Vessel Inspector #5034; AWS-CWI Certified Welding Inspector # 93040861 ASNT Level II, Non-Destructive Testing (NDT) Technician MT,PT,UT,RT & VT
<b>Credentials:</b>	POL specification knowledge includes: ASME, API, AWS, UL, ANSI, NFPA codes and various industry standards in conjunction with OSHA, EPA and DOT government regulations

**Similar Project Experience for Tim Anderson [002200, ¶ 7.2.1 a. through f]**

<b>Relevant Project 1</b>		
<b>Dates Employed:</b>	<b>From:</b> September, 2007	<b>To:</b> Present
<b>Assigned Position [a]:</b>	Construction Project Manager & Senior Projects Engineer during design.	<b>Company Worked For [a]:</b> Willbros, Inc.
<b>Project Title and Location [b]:</b>	BP Petroleum Southeast Atlantic, US – Virginia, South Carolina, Alabama, North Carolina, Florida	
<b>Dollar Value of Construction [c]:</b>	\$58,420,800.00	
<b>Dollar Values Performed by Prime [c]:</b>	\$67,871,400.00	<b>Sub[c]:</b> N/A
<b>Construction/Design Period (month/year start to month/year end) [d]:</b>	September, 2007 thru July, 2009	

**Brief Description of Experience on this Project and explanation of how it is similar to the projects to be performed pursuant to this contract [002200, ¶ 7.2.1 e.]:**  
Responsible for the management of project activities related to site engineering, fabrication, construction, plant modifications & expansion, maintenance and inspection. Planning; scheduling; contract development and execution; efficient utilization of manpower and equipment; cost controls of manpower and equipment across the U.S.A at (16) project locations. This is similar to typical repair projects for this contract, which managed up to approx. 1225 personnel on multiple projects for company and subcontractors at various locations. Directly supervised the engineering, fabrication, construction, maintenance and inspection services, procedures and programs, non-destructive and metallurgical testing, drawings, isometrics, as-builts and P&ID updates for the commercial, oil & gas and petrochemical industries for all types of process units & systems, storage tanks, vessels, rotating equipment, associated piping per relative codes and regulations.

The turnkey POL projects included the installation of new AST and UST tanks, pumps, loading / unloading racks and terminal systems, metering and blending systems, buildings, canopies, structural racks and supports, associated piping systems, electrical and instrumentation control systems and integration into the existing plant / terminal system. The projects also included upgrading and modification of the existing systems and configurations.

<b>Current primary POC for the customer [002200, ¶ 7.2.1 f.]:</b>		
<b>Name</b>	<b>Relationship to project</b>	<b>Agency/firm affiliation, city and state</b>
Peter Rutherford	Project Manager	BP Pipeline and Logistics Engineering and Maintenance, 28100 Torch Parkway Warrenville, IL 60555
<b>e-mail</b> <a href="mailto:peter.i.rutherford@bp.com">peter.i.rutherford@bp.com</a>		<b>Telephone:</b> 630-836-3532

**John Zink, LLC., Tulsa, OK - Apr 2006 - Sept 2007 Sr. Projects Manager/Engineer:** Responsible for the business administration, development & management of project activities related to engineering, fabrication, construction and modifications of code and non-code projects for combustion boilers, burners, turbine & blower systems and associated piping systems. The turn key systems included civil structure, mechanical, electrical, instrumentation and control devices and systems. The control systems were PLC based and integrated into the exiting plant DCS controls.

**AES Industries, Tulsa, OK - Dec 2003 - Apr 2006 Division Manager for Environmental & Engineered Systems:** Responsible for the business development, management of activities related to sales & marketing, engineering, fabrication, construction for new process plant units, systems and retrofit projects. The process systems were code and non-code projects for tanks, pressure vessels, exchangers, combustion heaters, boilers, burners, blower systems and associated piping systems. The turn key systems





included civil foundations and structure; mechanical; electrical; instrumentation; control devices and systems. The control systems were PLC based and integrated into the exiting plant DCS controls.

Matrix Services, Inc. Tulsa, OK - Oct 2002 - Dec 2003 **Division Manager for ASME / Outside Fabrication:** Responsible for the business administration & development, management of activities related to sales & marketing, engineering, fabrication, construction and modifications of code and non-code projects. The process systems included tanks, pressure vessels, process equipment and associated piping systems.

Relevant Project 2		
<b>Dates Employed:</b>	<b>From:</b> January, 2000	<b>To:</b> December, 2002
<b>Assigned Position [a]:</b>	Projects Manager	<b>Company Worked For [a]:</b> Antec Services, Inc.
<b>Project Title and Location [b]:</b>	Sinclair Oil Corporation Oil and Gas Product Terminals - Nationwide	
<b>Dollar Value of Construction [c]:</b>	\$125,000.00	
<b>Dollar Values Performed by Prime [c]:</b>	\$125,000.00	<b>Sub[c]:</b> none
<b>Construction/Design Period (month/year start to month/year end) [d]:</b>	January, 2002 thru December, 2002	
<b>Brief Description of Experience on this Project and explanation of how it is similar to the projects to be performed pursuant to this contract [002200, ¶ 7.2.1 e.]:</b>		
Responsible for management of project engineering, construction, and inspection activities for fabrication, construction, plant modifications, expansions and maintenance of associated systems. Responsible for planning, scheduling, contracts and cost controls of manpower and equipment across the U.S. Evaluate and determine integrity, develop repair or modification plans and oversee repair / modifications. Personally performed API inspections on (18) field erect above and under ground storage tanks ranging from 30 ft to 150 ft in diameters; various cone, external and internal floating roof types. Inspection services included non-destructive, destructive and metallurgical testing. Also include drawings, isometrics, as-builts and P&ID updates for the commercial, oil & gas, petrochemical, power and utility systems for various types of process units & systems, storage tanks, vessels, boilers, exchangers, rotating equipment, associated piping, structures and pipelines per relative codes and regulations such as OSHA CFR 29 Part 1910 (PSM) Process Safety and EPA CFR 40 Part 68 Risked Based Management Inspections, D.O.T. Tanks and vessels. Directly managed up to 55 personnel.		
This is similar to the projects on this contract as it entailed construction management and inspection of terminal facilities and equipment to evaluate system integrity and suitability for service. For various types of process systems and equipment, storage tanks, vessels, rotating equipment, associated piping, structures and pipelines per relative codes and regulations.		
<b>Current primary POC for the customer [002200, ¶ 7.2.1 f.]:</b>		
<b>Name</b>	<b>Relationship to project</b>	<b>Agency/firm affiliation, city and state</b>
Marlin Sutherland	Client Representative	Sinclair Oil Company, Tulsa, OK
<b>e-mail</b> <a href="mailto:marlin.sutherland@sinclairoil.com">marlin.sutherland@sinclairoil.com</a>		<b>Telephone:</b> 918-344-9025

Relevant Project 3		
<b>Assigned Position [a]:</b>	Projects Manager	<b>Company Worked For [a]:</b> Antec Services, Inc.
<b>Project Title and Location [b]:</b>	Sunoco / Sun Oil Corporation Oil and Gas Products Terminal - Nationwide	
<b>Dollar Value of Construction [c]:</b>	\$330,000.00	
<b>Dollar Values Performed by Prime [c]:</b>	\$330,000.00	<b>Sub[c]:</b> N/A
<b>Construction/Design Period (month/year start to month/year end) [d]:</b>	Annual contract (January, 2001 – December, 2001)	
<b>Brief Description of Experience on this Project and explanation of how it is similar to the projects to be performed pursuant to this contract [002200, ¶ 7.2.1 e.]:</b>		
Responsible for the engineering and inspection activities for fabrication, construction, terminal / plant modifications, expansion and maintenance. Planning, scheduling, contracts and cost controls of manpower and equipment across the U.S.A. The company provided engineering services for design, evaluations, structural integrity and stress analysis. Inspection services for non-destructive, destructive and metallurgical testing. Also provided CAD drafting, as-builts and P&ID updates for the fuels & petrochemical facilities per relative codes and regulations; including OSHA CFR 29 Part 1910 (PSM) Process Safety and EPA CFR 40 Part 68 Based Management Inspections, D.O.T. Tanks and vessels.		
This is similar to the projects on this contract as it entailed inspection of terminal facilities and equipment to evaluate system integrity and suitability for service. For various types of process systems and equipment, storage tanks, vessels, rotating equipment, associated piping, structures and pipelines per relative codes and regulations. Evaluate and determine integrity, develop repair or modification plans and oversee repair / modifications. Personally performed API inspections on (46) field erect storage tanks ranging from 50 ft to 200 ft in diameters; various cone, dome, external and internal floating roof types.		
<b>Current primary POC for the customer [002200, ¶ 7.2.1 f.]:</b>		
<b>Name</b>	<b>Relationship to project</b>	<b>Agency/firm affiliation, city and state</b>
Dave Swanson	Project Manager	Sun Oil Company, Tulsa, OK
<b>e-mail</b> <a href="mailto:d.swanson@sunoco.com">d.swanson@sunoco.com</a>		<b>Telephone:</b> 918-859-7210





Other work performed while employed by Antec Services Included:

**General Manager - Field Operations 2000 - 2002:** Responsible for the administration, business development, implementation and management of activities related to sales & marketing, engineering, fabrication, construction, plant modifications and expansion and inspection activities

**Manager of Engineering, Inspection & Field Services 1998 - 2000:** Responsible for the engineering and inspection for fabrication, construction, plant modifications, expansion and maintenance, Planning, scheduling, contracts and cost controls of manpower and equipment across the U.S.A and internationally

**Manager of Projects & Field Superintendent 1993 - 1998:** Responsible for the management of project activities related to site engineering, fabrication, construction, maintenance, inspection, plant modifications & expansion.

Relevant Project 4		
<b>Dates Employed:</b>	<b>From:</b> June, 1991	<b>To:</b> October, 1992
<b>Assigned Position [a]:</b>	Mechanical & Tank Superintendent	<b>Company Worked For [a]:</b> Kellogg Brown & Root
<b>Project Title and Location [b]:</b>	Shell Petroleum Development of Oman/Shell Petrol, London UK - Remote Areas of Omani Desert	
<b>Dollar Value of Construction [c]:</b>	\$550,000,000	
<b>Dollar Values Performed by Prime [c]:</b>	\$805,000,000	<b>Sub [c]:</b> N/A
<b>Construction/Design Period (month/year start to month/year end) [d]:</b>	June, 1991 thru October, 1992	

**Brief Description of Experience on this Project and explanation of how it is similar to the projects to be performed pursuant to this contract [002200, ¶ 7.2.1 e.]:**

Responsible for \$350,000,000 of the project scope including planning, scheduling, cost controls and the efficient utilization of manpower and equipment in the fabrication, erection and testing of piping, pipelines, vessels, above ground field erect storage tanks, rotating and associated equipment, along with instrumentation and controls on a lump sum turnkey construction, expansion and modifications of oil, gas, water treatment and power generation plants in the remote Omani Desert.

The project contained four (4) separate processing facilities & (10) remote well sites with (38) Km of crude oil and water injection pipelines, 450,000 meters of on site piping systems, associated structural supports, (15) field erect tanks (50' to 150' dia) cone and floating roof types, process vessels, associated pumps, equipment, instrumentation and controls. Worked closely with all project disciplines to achieve an efficient flow of construction activities without a lost time accident and finishing four (4) weeks ahead of schedule. The project was remote with a 30-day shipping time line by ocean freight and a \$100,000 per day late penalty & early completion bonus. This is similar to the projects on this contract as I directly managed up to 270 personnel and subcontractors at various locations, and directly supervised the fabrication, construction, maintenance and inspection services, procedures and programs, non-destructive and metallurgical testing, drawings, isometrics, as-builts and P&ID updates for the oil & gas, petrochemical, power generation and utility facilities for all types of process units & systems, storage tanks, vessels, boilers, exchangers, turbines, rotating equipment, associated piping per relative codes and regulations.

**Current primary POC for the customer [002200, ¶ 7.2.1 f.]:**

Name	Relationship to project	Agency/firm affiliation, city and state
Tex Hooker	Project Manager	Kellogg, Brown, & Root
e-mail <a href="mailto:t.hooker@brownrootusa.com">t.hooker@brownrootusa.com</a>		Telephone: (281) 871-2688

<b>Other Relevant Training:</b>	HAZWOPER 40hr / HAZCOM, Confined Space, Respiratory Protection, SCBA, PPE, General Safety, more avail. Upon request.
	Failure Analysis, Mechanical & Structural Integrity Specialist, Metallurgy
	ASNT Level II NDT Certified Technician - UT - Ultrasonic Longitudinal & Shear wave MT - Magnetic Particle Testing, Dry & WFMT PT - Dye Penetrant Testing, Dye & WFPT RT - Radiographic Testing, Gamma Ray LT - Leak & Pressure Testing, Hydro & Pneumatic VT - Visual Inspection



**Project Engineer  
Gene Humes, P.E.**

**Summary of Proposed Duties and Responsibilities [002200, ¶ 7.2.1]**

The Project Engineer reports directly to the Program Manager and is responsible for all technical content of the task order. He is available to diagnose, investigate and analyze technical issues and serves as technical resource to the Project Manager and Site Manager as required. He has over 35 years of civil engineering and design experience with 7 years experience in the POL industry.

<b>Education:</b>	Master of Civil Engineering, Oklahoma State University; B.S. Civil Engineering Oklahoma State University; Arctic Engineering, C.E. 603, University of Alaska.
<b>Registrations:</b>	Professional Engineer- Oklahoma, California, Alaska
<b>Credentials:</b>	37 years of experience, 18 with Willbros. POL specification and recommended practice knowledge including ASME, API and NACE documents concerning piping, pipelines, and pipeline integrity

**Similar Project Experience for Mr. Gene Humes [002200, ¶ 7.2.1 a. through f]**

Willbros Group, Inc - 1991 to present – **Project Engineer:** Engineering and design coordination on multiple projects.

Relevant Project 1	
<b>Assigned Position [a]:</b> Delivery Order Manager	<b>Company Worked For [a]</b> Willbros Group, Inc.
<b>Project Title and Location [b]:</b>	Pipeline Modifications & ILL, Grand Forks ND
<b>Dollar Value of Construction [c]:</b>	\$1,040,000
<b>Dollar Values Performed by Prime[c]:</b> \$205,000	<b>Sub[c]</b> N/A:
<b>Construction/Design Period (month/year start to month/year end) [d]:</b>	Mar 1998 to Oct 1999

**Brief Description of Experience on this Project and explanation of how it is similar to the projects to be performed pursuant to this contract [002200, ¶ 7.2.1 e.]:**

Responsible for all aspects of planning and the supervision of project personnel to perform modifications and inspections of pipelines at DFSP Grand Forks, North Dakota. Used intelligent pigging technologies including geometry, magnetic flux leakage (MFL) and ultrasonic (UT). Inspecting the pipeline at DFSP Grand Forks required special modifications to the tool to permit traversing the dual 9- and 10-inch pipeline. All work was completed in accordance with project work plans including quality control/assurance plan, accident prevention plan, and milestone schedule. This is similar to the projects on this contract as it involved management of complex POL system construction projects in multiple locations under a Task Order Contract.

**Current primary POC for the customer [002200, ¶ 7.2.1 f.]:**

Name	Relationship to project	Agency/firm affiliation, city and state
Terri Regin,	Pipeline Product Leader	Address: 720 Kennon St., Suite 333, Washington, DC
e-mail <a href="mailto:Terri.Regin@navy.mil">Terri.Regin@navy.mil</a>		<b>Telephone:</b> 202-433-5196

Relevant Project 2	
<b>Assigned Position [a]:</b> Delivery Order Manager	<b>Company Worked For [a]</b> Willbros Group, Inc.:
<b>Project Title and Location [b]:</b>	Pipeline Modifications & ILL, Norfolk, VA
<b>Dollar Value of Construction [c]:</b>	\$500,000
<b>Dollar Values Performed by Prime[c]:</b> \$123,000	<b>Sub[c]</b> N/A:
<b>Construction/Design Period (month/year start to month/year end) [d]:</b>	1997 to 1998

**Brief Description of Experience on this Project and explanation of how it is similar to the projects to be performed pursuant to this contract [002200, ¶ 7.2.1 e.]:**

Responsible for all aspects of planning and supervision of project personnel to perform modifications and inspections of pipelines at FISC Norfolk, Virginia. Used intelligent pigging technologies including geometry, magnetic flux leakage (MFL) and ultrasonic (UT). Supervised project personnel responsible. All work was completed in accordance with project work plans including quality control/assurance plan, accident prevention plan, and milestone schedule. This is similar to the projects on this contract as it involved management of complex POL system construction projects in multiple locations under a Task Order Contract.

**Current primary POC for the customer [002200, ¶ 7.2.1 f.]:**

Name	Relationship to project	Agency/firm affiliation, city and state
Terri Regin,	Pipeline Product Leader	Address: 720 Kennon St., Suite 333, Washington, DC
e-mail <a href="mailto:Terri.Regin@navy.mil">Terri.Regin@navy.mil</a>		<b>Telephone:</b> 202-433-5196

Relevant Project 3	
<b>Assigned Position [a]:</b> Delivery Order Manager	<b>Company Worked For [a]</b> Willbros, Inc.
<b>Project Title and Location [b]:</b>	Marine Corps Naval Air Station, Cherry Point, NC
<b>Dollar Value of Construction [c]:</b>	\$200,000



Dollar Values Performed by Prime[c]: \$75,000		Sub[c] N/A:
Construction/Design Period (month/year start to month/year end) [d]: Jan to Mar, 1997		
Brief Description of Experience on this Project and explanation of how it is similar to the projects to be performed pursuant to this contract [002200, ¶ 7.2.1 e.]: Managed all aspects of design and construction for pigging of a 10-inch jet fuel line at MCAS Cherry Point, including the required use of temporary pipeline pumps, air compressors, pig trap and storage tank. Equipment used included a temporary launcher, air compressors to propel the cleaning and gauging pigs and pumps to propel the MFL tool with water, plus tanks to receive the water. The pipeline was 3.8 miles long 10" JP-5 fuel pipeline was from the fuel barge unloading pier to Tank Farm B. This is similar to the projects on this contract as it involved management of complex POL system construction projects under a Task Order Contract		
Current primary POC for the customer [002200, ¶ 7.2.1 f.]:		
Name	Relationship to project	Agency/firm affiliation, city and state
Terri Regin,	Pipeline Product Leader	Address: 720 Kennon St., Suite 333, Washington, DC
e-mail <a href="mailto:Terri.Regin@navy.mil">Terri.Regin@navy.mil</a>		Telephone: 202-433-5196

Relevant Project 4		
Assigned Position [a]:	Project Engineer	Company Worked For [a] Willbros, Inc.
Project Title and Location [b]:	El Paso Field Services, San Antonio, TX	
Dollar Value of Construction [c]:	\$600,000	
Dollar Values Performed by Prime[c]:	\$200,000	Sub[c] N/A:
Construction/Design Period (month/year start to month/year end) [d]: Nov 2002 to February 2004		
Brief Description of Experience on this Project and explanation of how it is similar to the projects to be performed pursuant to this contract [002200, ¶ 7.2.1 e.]: Project Engineer responsible for applying El Paso Field Services Integrity Management Plan to assess integrity of POL liquid pipelines utilizing inline inspection and hydrostatic testing. Responsibilities included pipeline modifications, specifications, assessment method selection, tool selection, coordination, coordination, data review, calculations, repair schedules, repair method selection and documentation.		
Current primary POC for the customer [002200, ¶ 7.2.1 f.]:		
Name	Relationship to project	Agency/firm affiliation, city and state
Don King,	Pipeline Integrity Consultant	Address: 10647 Guldale Rd, San Antonio TX 78216
e-mail		Telephone: 210-528-4034

Relevant Project 5		
Assigned Position [a]:	Project Engineer	Company Worked For [a] Willbros, Inc.
Project Title and Location [b]:	Centennial Pipeline Conversion	
Dollar Value of Construction [c]:	\$3,000,000	
Dollar Values Performed by Prime[c]:	\$500,000	Sub[c] N/A:
Construction/Design Period (month/year start to month/year end) [d]: Jan 2001 to June 2002		
Brief Description of Experience on this Project and explanation of how it is similar to the projects to be performed pursuant to this contract [002200, ¶ 7.2.1 e.]: Project Engineer responsible for inline inspection of 674 miles of 26" pipeline. Responsibilities included development of specifications, selection of contractors, tool running and tracking, anomaly investigation, anomaly repair, and documentation. Specifications included geometry inspection, metal loss inspection, benchmarking (aboveground markers), tracking, anomaly disposition, pipeline repair, and hydrostatic testing. Hydrostatic testing included a spike test for crack assessment.		
Current primary POC for the customer [002200, ¶ 7.2.1 f.]:		
Name	Relationship to project	Agency/firm affiliation, city and state
Curt Simkin,	Willbros Project Manager	Address: 2087 East 71 <sup>st</sup> Street, Tulsa OK 74136
e-mail		Telephone:





<b>Fuel Tanks Expert / Structural Steel Inspection Expert</b> <b>Douglas J. Bayles, P.E. - Hawaii License Number 11128-C</b>	
<b>Summary of Proposed Duties and Responsibilities [002200, ¶ 7.2.1]</b> Mr. Bayles has more than 20 years of experience in the POL fuels infrastructure industry. As a key member of the API standards committee on Above Ground Storage Tanks, he brings the NAVFAC industry the best practices in the latest POL infrastructure standards. His years of experience include inspection of steel plate structures, as well as elevated storage facilities on structural supporting members. His knowledge of steel erection practices allows for evaluations of structures supporting the construction effort.	
<b>Education:</b>	B.S. in Civil Engineering
<b>Registrations:</b>	API-653 Certified Above Ground Tank Inspector; Licensed P.E. in 47 U.S. States, Guam and 2 Canadian Provinces
<b>Credentials:</b>	Over 20 years of experience in the POL fuels infrastructure industry. Key member of the API Standards Committee. POL specification knowledge includes: API, NFPA, UFC, ANSI/ASME B31.3, B31.4, MIL-HDBK-1022A ASME Section IV and IX; ATSM D 3740; ASTM E 329; USACE EM 385-1-1 and EM 1110-1-12; 29 CFR 1910.120

**Similar Project Experience for Mr. Doug Bayles [002200, ¶ 7.2.1 a. through f]**

<b>Relevant Project 1</b>			
<b>Dates Employed:</b>	<b>From</b>	<b>To 2006</b>	
<b>Assigned Position:</b>	Project Engineer	<b>Company Worked For:</b>	HMT, Inc.
<b>Project Title and Location [b]:</b>	Guantanamo Bay, Cuba NAS – Tank 154		
<b>Dollar Value of Construction [c]:</b>	\$2,000,000.00		
<b>Dollar Values Performed by Prime[c]:</b>	N/A		<b>Sub[c]:</b> N/A
<b>Construction/Design Period (month/year start to month/year end) [d]:</b>	N/A		

**Brief Description of Experience on this Project and explanation of how it is similar to the projects to be performed pursuant to this contract [002200, ¶ 7.2.1 e.]:** Responsible for the design and preparation of fabrication drawings. Instrumental in providing value engineering for change in work scope to provide solution for less maintenance and longevity of tank interior lining. Suggested work to be performed with stainless steel rather than painted carbon steel to prevent future maintenance costs while still maintaining desired scope of work. Managed group of engineers who provided all submittals and work plans for field construction services.

<b>Relevant Project 2</b>			
<b>Dates Employed:</b>	<b>From</b>	<b>To Present</b>	
<b>Assigned Position:</b>	Operations Manager	<b>Company Worked For</b>	Willbros
<b>Project Title and Location [b]:</b>	BP Southeast Ethanol, Southeastern United States		
<b>Dollar Value of Construction [c]:</b>	\$2,500,000.00		
<b>Dollar Values Performed by Prime[c]:</b>	N/A		<b>Sub[c]:</b> N/A
<b>Construction/Design Period (month/year start to month/year end) [d]:</b>	N/A		

**Brief Description of Experience on this Project and explanation of how it is similar to the projects to be performed pursuant to this contract [002200, ¶ 7.2.1 e.]:**  
Willbros-InServ is contracting with BP to upgrade their Southeast Facilities to assist in expanding their ability to provide ethanol to Southeastern United States. Tank and piping inspection and repairs, new tank construction, installation of distribution facilities (i.e. pumps, off loading racks, canopies). Includes subcontracting of cleaning and painting of tanks and piping coming to and away from tank facilities.  
As Operations Manager, in charge of project managers, field construction crews, and various subcontractors utilized to clean tanks, inspect tanks, repair and repaint tanks and place tanks back into service. Perform client interface at pre- and post-construction meetings, ensure quality control and safety maintained on all facility improvement projects, gather final data and provide close out documentation.

<b>Relevant Project 3</b>			
<b>Dates Employed:</b>	<b>From</b>	<b>To 2003</b>	
<b>Assigned Position:</b>	Vice President of Maintenance Division	<b>Company Worked For</b>	Pittsburg Tank & Tower, Co., Inc.
<b>Project Title and Location [b]:</b>	General Motors Inspection & Repair of Water & Wastewater Treatment Facilities		
<b>Dollar Value of Construction [c]:</b>	\$3,000,000.00		
<b>Dollar Values Performed by Prime[c]:</b>	N/A		<b>Sub[c]:</b> N/A



<b>Construction/Design Period (month/year start to month/year end) [d]:</b>	N/A
---	-----

**Brief Description of Experience on this Project and explanation of how it is similar to the projects to be performed pursuant to this contract [002200, ¶ 7.2.1 e.]:**

In charge of Project Managers, shop fabrication, field inspectors and field maintenance crews for projects involving inspection and repair of General Motors API 650 tanks located throughout the United States. Responsible for contract review, QC, safety, accounting and managing personnel. Managed subcontractors and provided client interface. Performed structural inspection of facilities and supporting structures as necessary.

Each project consisted of API 653 and API 570 inspections, tank and piping repairs, repainting of tanks and piping, hydro-testing of storage tanks and piping and providing all submittal and close out documentation.

<b>Relevant Project 4</b>	
---------------------------	--

<b>Dates Employed:</b>	<b>From</b>	<b>To</b>	2006
------------------------	-------------	-----------	------

<b>Assigned Position:</b>	Project Manager	<b>Company Worked For</b>	Willbros
---------------------------	-----------------	---------------------------	----------

<b>Project Title and Location [b]:</b>	Colonial Pipeline Clear Skies Greensboro/Austell, North Carolina
--	--

<b>Dollar Value of Construction [c]:</b>	\$7,600,000.00
--	----------------

<b>Dollar Values Performed by Prime[c]:</b>	N/A	<b>Sub[c]:</b>	N/A
---	-----	----------------	-----

<b>Construction/Design Period (month/year start to month/year end) [d]:</b>	N/A
---	-----

**Brief Description of Experience on this Project and explanation of how it is similar to the projects to be performed pursuant to this contract [002200, ¶ 7.2.1 e.]:**

Served as manager on project for construction of five new cone roof tanks: 120-ft. diameter x 51-ft. tall; 134-ft diameter x 48-ft. tall; 140-ft. diameter x 48 ft. tall in Austell, Georgia; 160-ft. diameter x 48-ft. tall; 180-ft. diameter x 48-ft. tall in Greensboro, North Carolina.

<b>Relevant Project 5</b>	
---------------------------	--

<b>Dates Employed:</b>	<b>From</b>	<b>To</b>	2008
------------------------	-------------	-----------	------

<b>Assigned Position:</b>	Manager	<b>Company Worked For</b>	Willbros, Inc.
---------------------------	---------	---------------------------	----------------

<b>Project Title and Location [b]:</b>	Magellan Midstream – Multiple New Tank Constructions throughout the United States
--	---

<b>Dollar Value of Construction [c]:</b>	\$9,400,000.00
--	----------------

<b>Dollar Values Performed by Prime[c]:</b>	N/A	<b>Sub[c]:</b>	N/A
---	-----	----------------	-----

<b>Construction/Design Period (month/year start to month/year end) [d]:</b>	N/A
---	-----

**Brief Description of Experience on this Project and explanation of how it is similar to the projects to be performed pursuant to this contract [002200, ¶ 7.2.1 e.]:**

Served as manager for construction of multiple new cone roof tanks for project service: two 170-ft. diameter x 50-ft. tall in El Dorado, Kansas; two 140-ft. diameter x 50-ft. with suspended aluminum floating roofs and one 140-ft. diameter x 52-ft. tall in Aurora, Colorado; one 170-ft. diameter x 66-ft. tall CRT in Tulsa, Oklahoma; one 113-ft. diameter x 56-ft. tall CRT in Chattanooga, Tennessee.





<b>Site Manager</b> <b>Paul H. Schenk, P.M.P.</b>	
<b>Summary of Proposed Duties and Responsibilities [002200, ¶ 7.2.1]</b> Serves as on-location point of contact for the Government on assigned task orders. Conducts job site visits with customers on assigned new task orders. Implements site specific safety and health program. Manages work in accordance with project schedules, statements of work, and execution plans. Oversees, coordinates, and manages in-house field and subcontract personnel performing construction tasks. Coordinates with Project Manager, Design Project Manager, and Construction Project Manager to ensure compliance with all specifications, codes, quality objectives, etc. Coordinates the activities of the Design QC Manager (who reports directly to the Project Manager) and supervises the activities of the Contracts Administrator, Site Safety and Health Offices (SSHO), and the Manager/Operations Manager. Conducts regular inspections of work in progress and completed work to ensure project and schedule objectives are met.	
<b>Education:</b>	Associate Degree, Petroleum Engineering Technology, Project Management Institute (PMI)
<b>Registrations:</b>	Completed the Construction Quality Management Certification course
<b>Credentials:</b>	Project Management Professional (PMP)

**Similar Project Experience for Mr. Paul Schenk [002200, ¶ 7.2.1 a. through f]**

<b>Relevant Project 1</b>	
<b>Dates Employed:</b>	From 2002 To 2002
<b>Assigned Position:</b>	On Site Construction/Project Manager
	<b>Company Worked For:</b> Wink Engineering, a Willbros Company
<b>Project Title and Location [b]:</b>	Texaco Marine & Fuel Marketing Terminal, New Orleans, LA
<b>Dollar Values Performed by Prime[c]:</b>	\$2.5 Million TIC
<b>Construction/Design Period (month/year start to month/year end) [d]:</b>	03/02-12/02

**Brief Description of Experience on this Project and explanation of how it is similar to the projects to be performed pursuant to this contract [002200, ¶ 7.2.1 e.]:** On-site Construction and Project Manager for the upgrade of the Texaco Marine & Fuel Marketing Terminal in New Orleans, LA. The project consisted of installation of ten (10) new pumps, two 14" pipelines and other associated piping to transfer No. 6 oil and diesel to and from the marine docks and the tank farm. Duties included on-site coordination of contractor activities, approving contractor requests for payment, monitoring project budget and schedule. Responsible for ensuring compliance with Wink and site safety standards and requirements.

<b>Relevant Project 2</b>	
<b>Dates Employed:</b>	From 2007 To 2007
<b>Assigned Position:</b>	On Site Coordinator
	<b>Company Worked For:</b> Wink Engineering , a Willbros Company
<b>Project Title and Location [b]:</b>	Petroleum Products Dock Rehabilitation Chevron Refinery, Pascagoula MS
<b>Dollar Values Performed by Prime[c]:</b>	\$12 Million over 5 years TIC upgrade
<b>Construction/Design Period (month/year start to month/year end) [d]:</b>	01/07 – 12/07

**Brief Description of Experience on this Project and explanation of how it is similar to the projects to be performed pursuant to this contract [002200, ¶ 7.2.1 e.]:** On-site coordination and oversight for structural analysis, and repair/upgrade of the Products Dock at the Pascagoula Refinery. Chevron's Products Dock is a 1500' structure, with five (5) berths handling petroleum and petrochemical products. It is one of the busiest marine docks in the nation. Construction had to be scheduled to coordinate with the Dock Operating Schedule so that the facility remained in operation throughout the upgrade project.

<b>Relevant Project 3</b>	
<b>Dates Employed:</b>	From 2003 To 2003
<b>Assigned Position:</b>	On Site Construction Manager
	<b>Company Worked For:</b> Wink Engineering, a Willbros Company
<b>Project Title and Location [b]:</b>	BNSF Diesel Fueling Facility Upgrade, Barstow, CA
<b>Dollar Values Performed by Prime[c]:</b>	\$3Million TIC
<b>Construction/Design Period (month/year start to month/year end) [d]:</b>	02/03-12/03

**Brief Description of Experience on this Project and explanation of how it is similar to the projects to be performed pursuant to this contract [002200, ¶ 7.2.1 e.]:** Full-time, on-site Construction Manager for the 10-month construction of a locomotive diesel fueling facility upgrade and a 2.5-mile, environmentally encased pipeline for





Burlington Northern Santa Fe Railway at BNSF's Barstow, California Yard. Served as Owner's representative, responsible for compliance of the installation with design drawings and standards and compliance with all safety standards.

Relevant Project 4		
<b>Dates Employed:</b>	<b>From</b> 2004	<b>To</b> 2005
<b>Assigned Position:</b>	On Site Engineering Manager	<b>Company Worked For</b> Wink Engineering , a Willbros Company
<b>Project Title and Location [b]:</b>	Refinery wide Turnaround(Shutdown), Suncor Refinery, Denver CO	
<b>Dollar Values Performed by Prime[c]:</b>	\$28 Million (TAR only)	
<b>Construction/Design Period (month/year start to month/year end) [d]:</b>	06/04-06/05	

**Brief Description of Experience on this Project and explanation of how it is similar to the projects to be performed pursuant to this contract [002200, ¶ 7.2.1 e.]:** On-site Engineering Manager at the Suncor Denver Colorado Refinery, managing a team of 10 to 25 engineers and designers for a twelve month-long, refinery wide turnaround. Responsibilities included schedule and cost reporting; oversight and quality control of the construction process, for compliance with engineering drawings and standards; and compliance with all safety standards and requirements

Relevant Project 5		
<b>Dates Employed:</b>	<b>From</b> 1998	<b>To</b> 2000
<b>Assigned Position:</b>	On Site construction Manager	<b>Company Worked For</b> Wink Engineering, a Willbros Company
<b>Project Title and Location [b]:</b>	Emergency Diesel Generators, Florida Keys Electric, Marathon FL	
<b>Dollar Values Performed by Prime[c]:</b>	\$5 Million TIC	
<b>Construction/Design Period (month/year start to month/year end) [d]:</b>	08/98-12/98 and 08/00-12/00	

**Brief Description of Experience on this Project and explanation of how it is similar to the projects to be performed pursuant to this contract [002200, ¶ 7.2.1 e.]:** On-site Construction Manager for the installation of two projects for the Florida Keys Electric Cooperative at the Marathon, Florida, generation plant:

- Installation of a new, 3.7MW diesel-driven generator in 1998; total project cost \$2 Million
- Installation of a new, 3.7MW diesel generator in 2000; total project cost \$3 Million

For both projects, responsibilities included: coordination of engineering, project scheduling, cost control and reporting from engineering through construction/installation and start-up. Both projects were completed on schedule and under budget.





<b>Field Construction Superintendent/ Site Manager (Rotational / Backup)</b> <b>George Dansby</b>	
<b>Summary of Proposed Duties and Responsibilities</b> [002200, ¶ 7.2.1] Serves as on-location point of contact for the Government on assigned task orders. Conducts job site visits with customers on assigned new task orders. Implements site specific safety and health program. Manages work in accordance with project schedules, statements of work, and execution plans. Oversees, coordinates, and manages in-house field and subcontract personnel performing construction tasks. Coordinates with Project Manager, Design Project Manager, and Construction Project Manager to ensure compliance with all specifications, codes, quality objectives, etc. Coordinates the activities of the Design QC Manager (who reports directly to the Project Manager) and supervises the activities of the Contracts Administrator, Site Safety and Health Offices (SSHO), and the Manager/Operations Manager. Conducts regular inspections of work in progress and completed work to ensure project and schedule objectives are met.	
<b>Education:</b>	High School
<b>Registrations:</b>	Completed the Construction Quality Manager Certification course
<b>Credentials:</b>	Over 40 years of construction management and over eight years of direct CQC experience Credentials for QC include Radiography Inspection, X-Ray Inspection shots, developing, and Interpretations, Level II. Also hold Radiation Safety Course certification - POL specification knowledge includes: API, NFPA, UFC, ANSI/ASME B31.3, B31.4, MIL-HDBK-1022A ASME Section IV and IX; ATSM D 3740; ASTM E 329; USACE EM 385-1-1 and EM 1110-1-12; 29 CFR 1910.120

**Similar Project Experience for Mr. George Dansby [002200, ¶ 7.2.1 a. through f]**

<b>Relevant Project 1</b>			
<b>Dates Employed:</b>	From 2008	To Present	
<b>Assigned Position:</b>	Project Director (corporate)	<b>Company Worked For:</b>	Willbros, Inc.
<b>Project Title and Location [b]:</b>	Corporate office, Tulsa, OK		
<b>Dollar Value of Construction [c]:</b>	N/A		
<b>Dollar Values Performed by Prime[c]:</b>	N/A	<b>Sub[c]:</b>	N/A
<b>Construction/Design Period (month/year start to month/year end) [d]:</b>	N/A		

**Brief Description of Experience on this Project and explanation of how it is similar to the projects to be performed pursuant to this contract** [002200, ¶ 7.2.1 e.]: Responsible at the corporate level for Willbros Downstream Tank and Terminal Group with responsibility for daily oversight and management of multiple projects, work crews, and our own fabrication/production facility. Oversee numerous projects for government and commercial clients with projects of similar size and type to the USACE MATOC. Ensure projects meet all API standards and comply with all construction quality control requirements.

<b>Relevant Project 2</b>			
<b>Dates Employed:</b>	From 2003	To 2008	
<b>Assigned Position:</b>	Project Manager	<b>Company Worked For</b>	TolTest
<b>Project Title and Location [b]:</b>	Andrews AFB, Repair Two Mission Critical ASTs		
<b>Dollar Value of Construction [c]:</b>	\$1,500,000.00		
<b>Dollar Values Performed by Prime[c]:</b>	\$1,500,000.00	<b>Sub[c]:</b>	N/A
<b>Construction/Design Period (month/year start to month/year end) [d]:</b>	Various dates covering 5 years		

**Brief Description of Experience on this Project and explanation of how it is similar to the projects to be performed pursuant to this contract** [002200, ¶ 7.2.1 e.]:  
TolTest QC Manager on all projects, which numbered at least twenty at various job sites, some maintained by myself onsite and some maintained while I was in my office with periodic visits to the jobsite. Samples below.  
**Davis Monthan Air Force Base, Tucson, AZ.** Site Manager /QC Manager on project that consisted of two large AST's, removing bottom and installing liner with cathodic protection and replacing existing bottom with a cone down center sump bottom. Installed New Seals. Removed and replaced suction and discharge external piping from service pit to the tank. Installing containment liners and paving driveways around both tanks. Employer = TolTest. Dollar value = over \$2,000,000.00. Prime performed 100% of project. Materials bought from 8-A Sub CMS. Duration of project; April 2004 – January 2005. POC - Bruce Cada, E-mail = [bruce.cada@dm.af.mil](mailto:bruce.cada@dm.af.mil), Phone = 520/228-4983. LFM Manager Davis Monthan Air Force Base AZ.  
**Andrews AFB, Repair Two Mission Critical ASTs** - Served as Mechanical Operations Manager/Site Manager responsible for all construction and CQC matters for the installation of secondary bottom liners of two above ground storage tanks. Scope of work required replacement of bottoms with slope to center sump and replaced gauge poles and seals. Also installed inserts and new nozzles and coated entire bottom and three feet up the shell. This work was completed in accordance with all applicable API standards, specifications, and project quality objectives. Project completed within timetables and without incident.  
**Wright Patterson AFB, Repair Six ASTs** - Responsible for all construction and CQC matters for work including patching bottoms after API 653 mag flux leakage scan and relocating sumps in mission critical tanks for reduction of contaminants in JP 8





## *Willbros - A Good Job On Time*

fuel. Also replaced seals, gauge poles, geodesic domes, PRTs and installed inserts for nozzles. Recoated entire bottoms and three feet up the shell and recoated bottom of floating roof on mission critical tanks. Re-caulked chime on all tanks and tested cathodic protection and made repairs. This project required phased activities to ensure minimal impact to ongoing operations.

**Davis Monthan AFB, Repair Tanks 23 and 24.** - Responsible for all construction and CQC matters.

Replaced bottoms in both tanks with slope to center sump. Installed secondary liner with anodes for cathodic protection. Installed inserts to allow raising and installation of new nozzles to adjust for change of bottom elevation. Replaced all receiving and discharge lines on both tanks. Installed new seals in both tanks. Coated both bottoms and re-coated exterior. Hydro tested both tanks and returned to service.

**Guantanamo Bay, Cuba NAS Line C & C Tank #154** - Project title Site Manager/QC. POL Fuels systems modification project. Responsibilities included managing all on-site operations and administration of the project quality control and safety program. Responsible for preparing all quality control documentation and inspection reports, inspected work for compliance with applicable standards and ensured that work met project work plan objectives. C= 3,000,000.00. Prime performed 95% Sub 5%.

**Guantanamo Bay, Cuba NAS Pier Quebec and MOD** - POL fuel systems modification project. Responsibilities included managing all on-site operations and administration of the project quality control and safety program. Responsible for preparing all quality control documentation and inspection reports, inspected work for compliance with applicable standards and ensured that work met project work plan objectives. Scope of work included replacement of JP 5, DFM, and potable water lines on Pier Quebec. MOD consisted of replacing DFM lines running up hill to day tanks. Tied JP 5 line into Cross Bay main delivery line for Air Station. POC – LCDR E.J. De'Andrea USNS Guantanamo Bay, Cuba Phone = (011) 53-99-4162/4814/5194 This is similar to the projects on this contract as the projects cited all involved work listed in table I of the solicitation.





**Intentionally Left Blank**  
(Remove page & insert data)