



Land And
Emergency Management
5401R

EPA 510-B-17-003
October 2017
www.epa.gov/ust

How To Evaluate Alternative Cleanup Technologies For Underground Storage Tank Sites

A Guide For Corrective Action Plan Reviewers

Chapter X

In-Situ Groundwater Bioremediation

Contents

Overview	X-1
Initial Screening Of In-Situ Groundwater Bioremediation	X-9
Detailed Evaluation Of In-Situ Groundwater Bioremediation	
Effectiveness	X-11
Site Characteristics That Affect In-Situ Groundwater	
Bioremediation	X-12
Hydraulic Conductivity	X-12
Soil Structure and Stratification	X-13
Groundwater Mineral Content	X-13
Groundwater pH	X-14
Groundwater Temperature	X-15
Microbial Presence	X-15
Terminal Electron Acceptors	X-16
Nutrient Concentrations	X-17
Constituent Characteristics That Affect In-Situ Groundwater	
Bioremediation	X-18
Chemical Structure	X-18
Concentration And Toxicity	X-20
Solubility	X-21
Treatability Testing	X-22
Bench-Scale Treatability Testing	X-22
Pilot-Scale Treatability Testing	X-23
Groundwater Modeling	X-24
Evaluations Of In-Situ Groundwater Bioremediation System Design	X-24
Rationale For The Design	X-25
Components Of An In-Situ Groundwater Bioremediation System ..	X-27
Well Placement	X-29
Electron Acceptor and Nutrient Addition System	X-30
System Controls and Alarms	X-31
Evaluation Of Operation And Monitoring Plans	X-31
Start-up Operation	X-32
Normal Operation	X-32
Remedial Progress Monitoring	X-32
References	X-35
Checklist: Can In-Situ Groundwater Bioremediation Be Used At This Site?	X-36

List Of Exhibits

Number	Title	Page
X-1	Schematic Diagram Of Typical In-Situ Groundwater Bioremediation System Using Infiltration Gallery	X-2
X-2	Schematic Diagram Of Typical In-Situ Groundwater Bioremediation System Using Injection Wells	X-3
X-3	Advantages And Disadvantages Of In-Situ Groundwater Bioremediation	X-5
X-4	In-Situ Groundwater Bioremediation Evaluation Process Flow Chart	X-6
X-5	Initial Screening For In-Situ Groundwater Bioremediation Effectiveness	X-10
X-6	Key Parameters Used To Evaluate The Effectiveness Of In- Situ Groundwater Bioremediation	X-11
X-7	Dissolved Iron And In-Situ Bioremediation Effectiveness	X-14
X-8	Heterotrophic Bacteria And In-Situ Groundwater Bioremediation Effectiveness	X-16
X-9	Chemical Structure And Biodegradability	X-19
X-10	Constituent Concentration And In-Situ Groundwater Bioremediation Effectiveness	X-20
X-11	Cleanup Concentrations And In-Situ Groundwater Bioremediation Effectiveness	X-21
X-12	Schematic Diagram Of Typical In-Situ Groundwater Bioremediation System Using Injection Wells	X-28
X-13	Idealized Layout Of Extraction, Injection, And Monitoring Wells For In-Situ Groundwater Bioremediation	X-30
X-14	System Monitoring Recommendations	X-33

Chapter X

In-Situ Groundwater Bioremediation

Overview

In-situ groundwater bioremediation is a technology that encourages growth and reproduction of indigenous microorganisms to enhance biodegradation of organic constituents in the saturated zone. In-situ groundwater bioremediation can effectively degrade organic constituents which are dissolved in groundwater and adsorbed onto the aquifer matrix.

Bioremediation generally requires a mechanism for stimulating and maintaining the activity of these microorganisms. This mechanism is usually a delivery system for providing one or more of the following: An electron acceptor (oxygen, nitrate); nutrients (nitrogen, phosphorus); and an energy source (carbon). Generally, electron acceptors and nutrients are the two most critical components of any delivery system.

In a typical in-situ bioremediation system, groundwater is extracted using one or more wells and, if necessary, treated to remove residual dissolved constituents. The treated groundwater is then mixed with an electron acceptor and nutrients, and other constituents if required, and re-injected upgradient of or within the contaminant source. Infiltration galleries or injection wells may be used to re-inject treated water, as illustrated in Exhibits X-1 and X-2, respectively. In an ideal configuration, a "closed-loop" system would be established. All water extracted would be re-injected without treatment and all remediation would occur in situ. This ideal system would continually recirculate the water until cleanup levels had been achieved. If your state does not allow re-injection of extracted groundwater, it may be feasible to mix the electron acceptor and nutrients with fresh water instead. Extracted water that is not re-injected must be discharged, typically to surface water or to publicly owned treatment works (POTW).

In-situ bioremediation can be implemented in a number of treatment modes, including: Aerobic (oxygen respiration); anoxic (nitrate respiration); anaerobic (non-oxygen respiration); and co-metabolic (see Abbreviations and Definitions). The aerobic mode has been proven most effective in reducing contaminant levels of aliphatic (e.g., hexane) and aromatic petroleum hydrocarbons (e.g., benzene, naphthalene) typically present in gasoline and diesel fuel. In the aerobic treatment mode, groundwater is oxygenated by one of three methods: Direct sparging of air or oxygen through an injection well; saturation of water with air or oxygen prior to re-injection; or addition of hydrogen peroxide directly

Exhibit X-1
 Schematic Diagram Of Typical In-Situ Groundwater Bioremediation System Using Infiltration Gallery

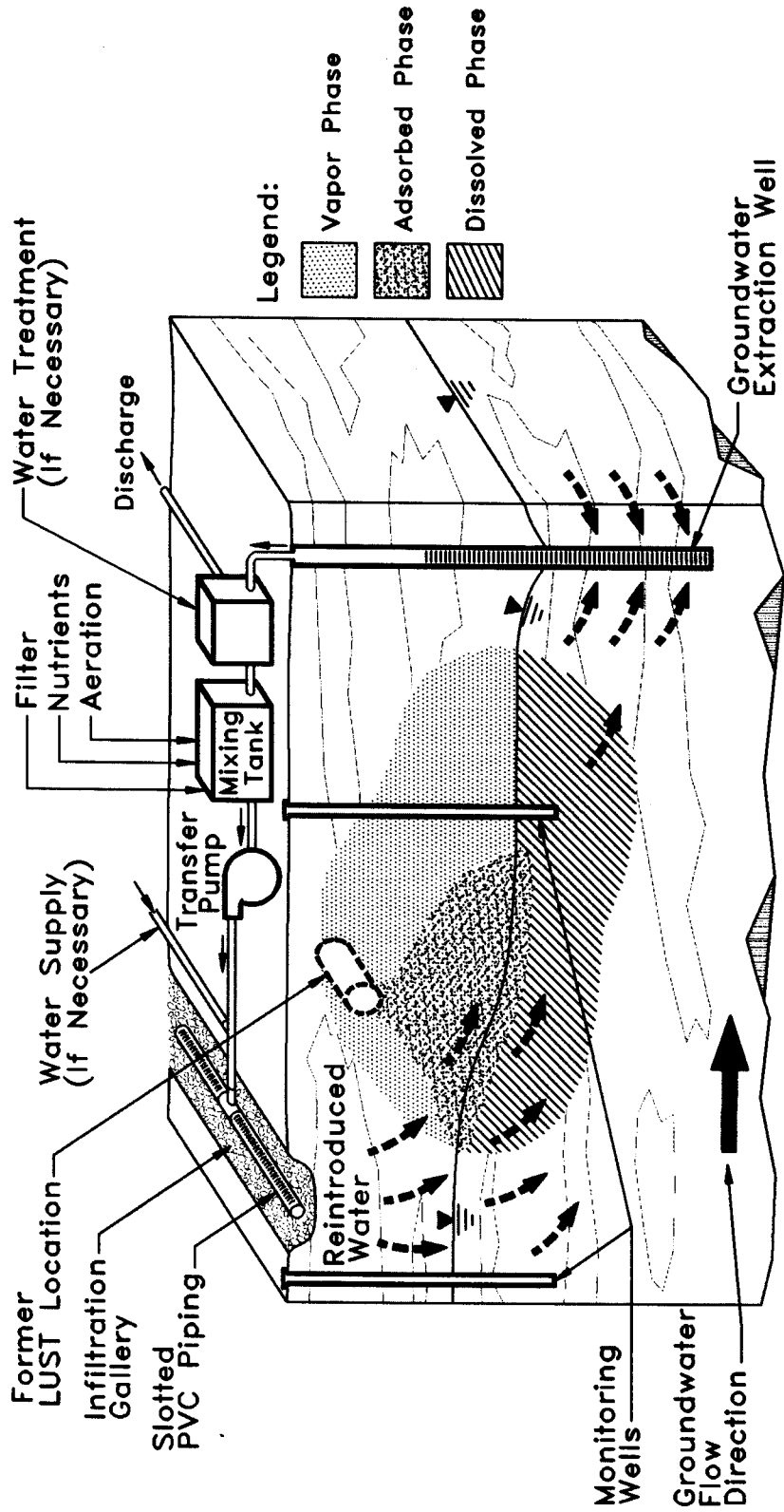
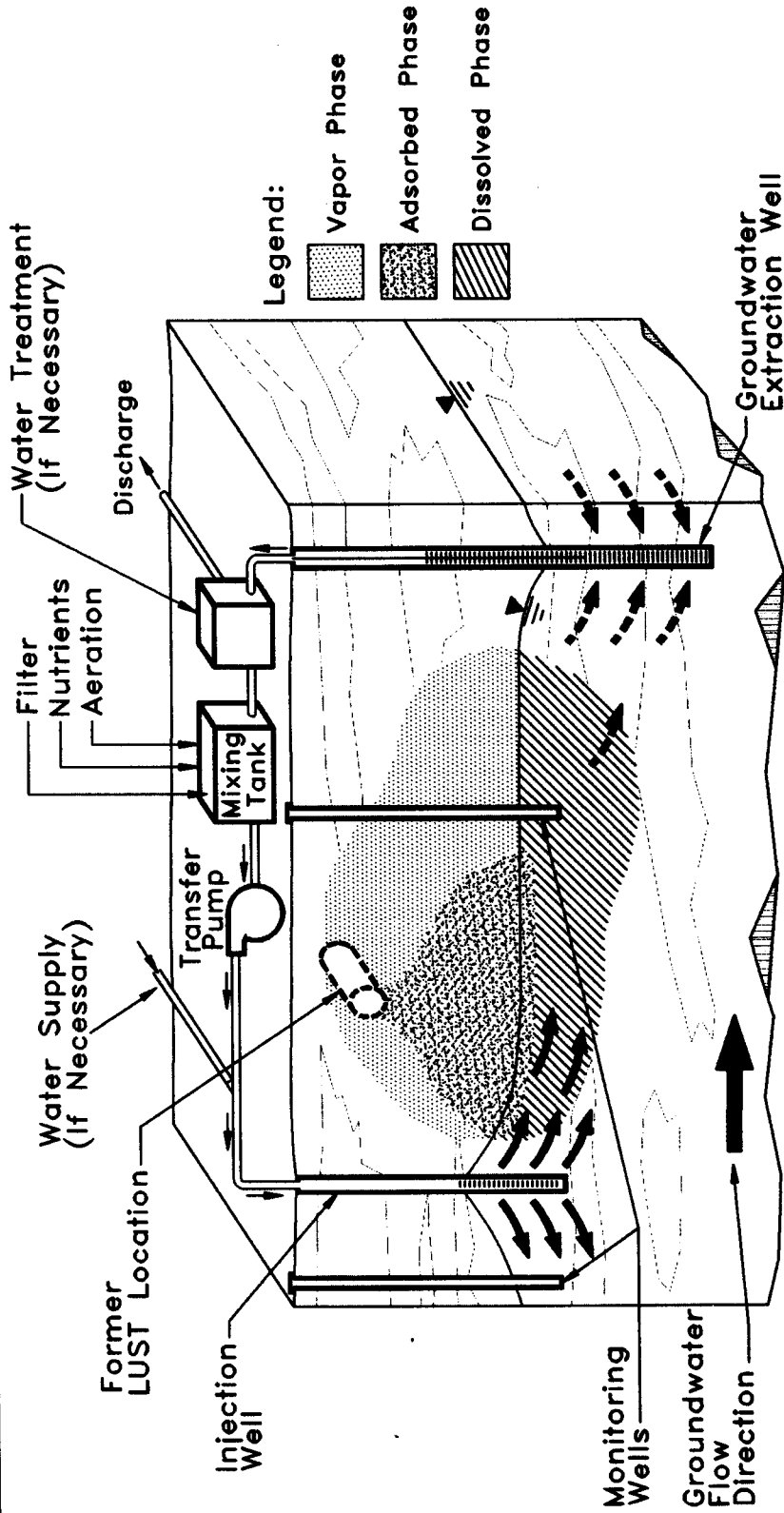

Exhibit X-2
 Schematic Diagram Of Typical In-Situ Groundwater Bioremediation System Using Injection Wells



into an injection well or into reinjected water. Whichever method of oxygenation is used, it is important to ensure that oxygen is being distributed throughout the area of contamination. Anoxic, anaerobic, and co-metabolic modes are sometimes used for remediation of other compounds, such as chlorinated solvents, but are generally slower than aerobic respiration in breaking down petroleum hydrocarbons.

In-situ groundwater bioremediation can be effective for the full range of petroleum hydrocarbons. While there are some notable exceptions, such as MTBE, the short-chain, low-molecular-weight, more water soluble constituents are degraded more rapidly and to lower residual levels than are long-chain, high-molecular-weight, less soluble constituents. Recoverable free product should be removed from the subsurface prior to operation of the in-situ groundwater bioremediation system. This will mitigate the major source of contaminants as well as reduce the potential for smearing or spreading high concentrations of contaminants. A summary of the advantages and disadvantages of in-situ bioremediation of the saturated zone is shown in Exhibit X-3.

In-situ bioremediation of groundwater can be combined with other saturated zone remedial technologies (e.g., air sparging) and vadose zone remedial operations (e.g., soil vapor extraction, bioventing).

This chapter will assist you in evaluating a corrective action plan (CAP) that proposes in-situ groundwater bioremediation for a petroleum-contaminated aquifer. The evaluation process, which is summarized in a flow diagram shown in Exhibit X-4, will serve as a roadmap for the decisions you will make during your evaluation. You can use the checklist at the end of this chapter as a tool to evaluate the completeness of the CAP and to help focus attention on areas where additional information may be needed. The evaluation process can be divided into the following steps:

- **Step 1: An initial screening of in-situ groundwater bioremediation effectiveness**, which will allow to quickly gauge whether this technology is likely to be effective, moderately effective, or ineffective.

- **Step 2: A detailed evaluation of in-situ groundwater bioremediation effectiveness**, which provides further screening criteria to confirm the effectiveness of this technology and develop design standards and operating conditions. To complete the detailed evaluation, you will need to identify specific soil and constituent characteristics and properties, compare them to ranges where in-situ groundwater bioremediation is potentially effective, decide whether

Exhibit X-3
Advantages And Disadvantages Of In-Situ Groundwater Bioremediation

Advantages

- Remediates contaminants that are adsorbed onto or trapped within the geologic materials of which the aquifer is composed along with contaminants dissolved in the groundwater.
- Application involves equipment that is widely available and easy to install.
- Creates minimal disruption and/or disturbance to on-going site activities.
- Time required for subsurface remediation may be shorter than other approaches (e.g., pump and treat).
- Is generally recognized as being less costly than other remedial options (e.g., pump and treat, excavation).
- Can be combined with other technologies (e.g., bioventing, soil vapor extraction) to enhance site remediation.
- In many cases, this technique does not produce waste products that must be disposed of.

Disadvantages

- Injection wells and/or infiltration galleries may become plugged by microbial growth or mineral precipitation.
- High concentrations (TPH > 50,000 ppm) of low solubility constituents may be toxic and/or not bioavailable.
- Difficult to implement in low-permeability aquifers (<10⁻⁴ cm/sec).
- Re-injection wells or infiltration galleries may require permits or may be prohibited. Some states require permit for air injection.
- May require continuous monitoring and maintenance.
- Remediation may only occur in more permeable layer or channels within the aquifer.

treatability studies are necessary to determine effectiveness, and conclude whether this technology is likely to be effective at a site.

- **Step 3: An evaluation of the in-situ groundwater bioremediation system design**, which will allow you to determine if the rationale for the design has been appropriately defined based on treatability study data, whether the necessary design components have been specified, and whether the construction process flow designs are consistent with standard practice.
- **Step 4: An evaluation of the operation and monitoring plans**, which will allow you to determine whether plans for start-up and long-term system operation monitoring are of sufficient scope and frequency, and whether remedial progress monitoring plans are appropriate.

INITIAL SCREENING OF IN-SITU GROUNDWATER BIOREMEDIATION EFFECTIVENESS

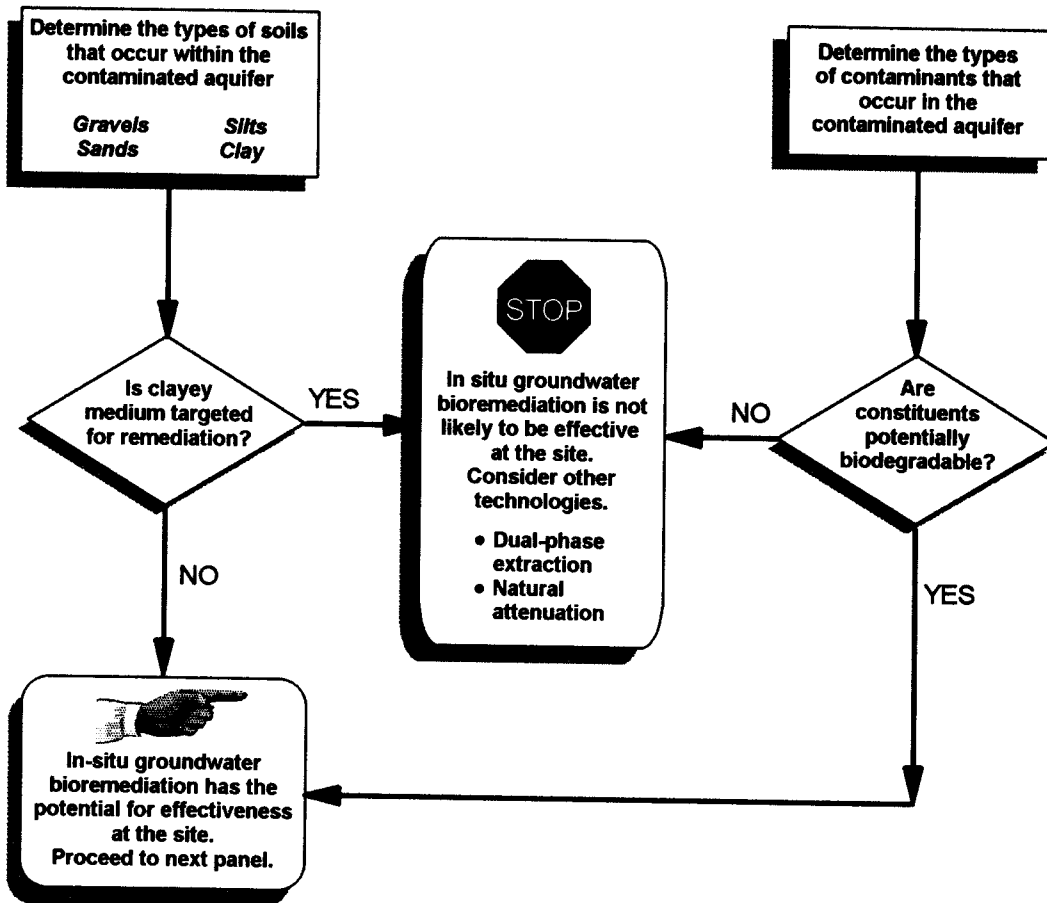

DETAILED EVALUATION OF IN-SITU GROUNDWATER BIOREMEDIATION EFFECTIVENESS

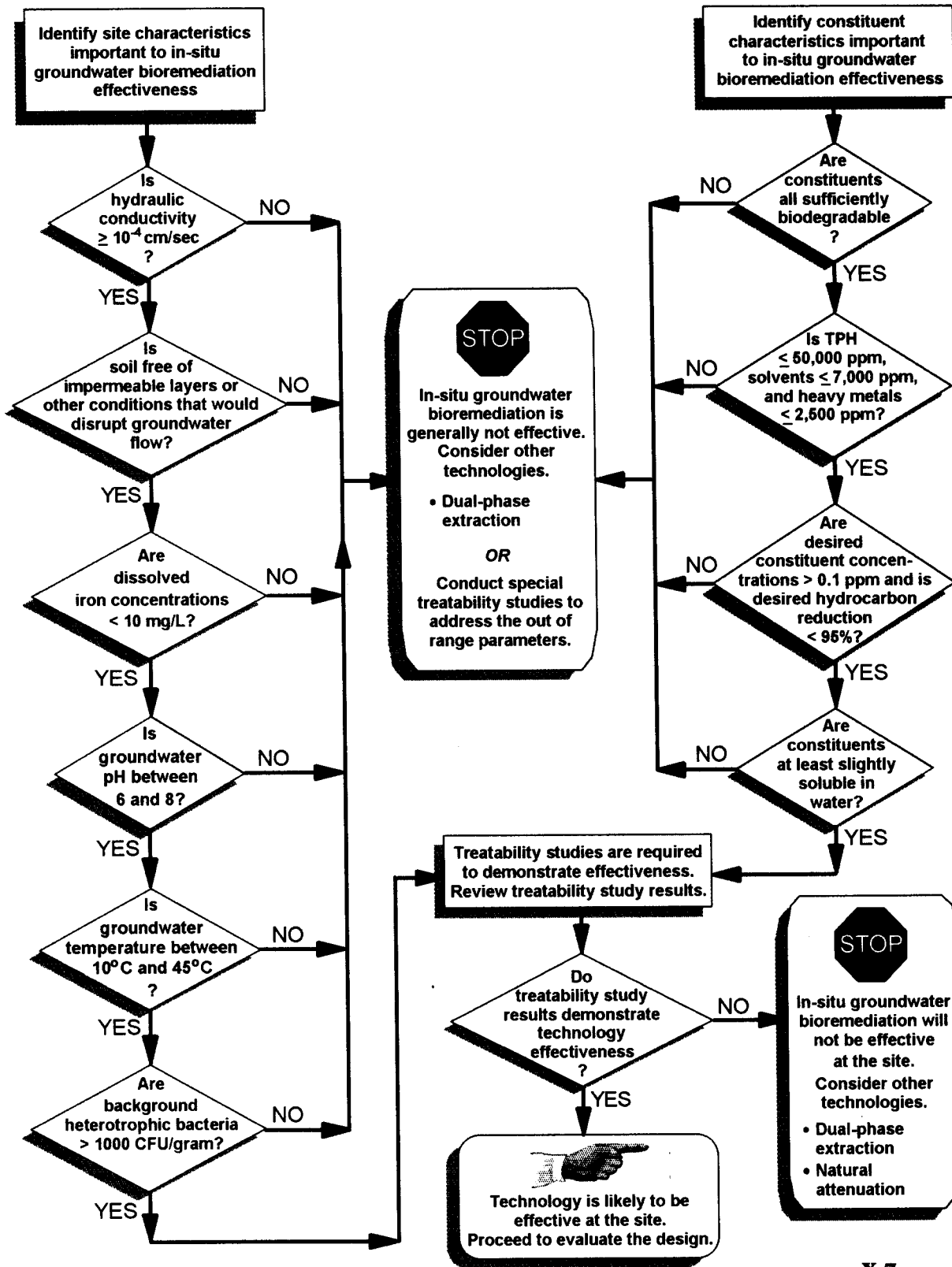

In-situ Groundwater Bioremediation Evaluation Process Flow Chart

EVALUATION OF IN-SITU GROUNDWATER BIOREMEDIATION SYSTEM DESIGN

Determine the design elements

- Volume and area of aquifer to be treated
- Initial concentrations of constituents of concern
- Required final constituent concentrations
- Estimates of electron acceptor and nutrient requirements
- Layout of injection and extraction wells
- Design area of influence
- Groundwater extraction and injection flow rates
- Site construction limitations
- Electron acceptor system
- Nutrient formulation and delivery system
- Bioaugmentation
- Extracted groundwater treatment and disposition
- Rates of injection/infiltration
- Cleanup time
- Free product recovery system

Have design elements been identified, and are they within normal ranges?

YES

NO

Identify & review the conceptual process flow design & the system components

- Extraction and injection well(s) lay-out and construction
- Filtration system
- Electron acceptor delivery system
- Nutrient delivery system
- Instrumentation
- Extracted groundwater treatment and disposition
- System controls and alarms

Has the conceptual design been provided and is it complete?

YES

NO

STOP

In-situ groundwater bioremediation system design is incomplete. Request additional information.

The in-situ groundwater bioremediation system design is complete and its elements are within normal ranges. Proceed to O&M evaluation.

EVALUATION OF IN-SITU GROUNDWATER BIOREMEDIATION SYSTEM OPERATION & MONITORING PLANS

Review the O&M plan for the following:

- Start-Up Operations Plan
- Long-Term Operations & Monitoring Plan
- Remedial Progress Monitoring Plan

Are start-up operations & monitoring procedures described, and are their scope & frequency adequate?

NO

STOP

Request additional information on start-up procedure and monitoring.

YES

Is a long-term O&M plan described; is it of adequate scope & frequency; does it include discharge permit monitoring?

NO

STOP

Request additional information on long-term operation and monitoring.

YES

Is a remedial progress monitoring plan established; is it of adequate scope & frequency; does it include provisions for detecting asymptotic behavior?

NO

STOP

Request additional information on remedial progress monitoring.

YES



The technology is likely to be effective. The design and O&M plans are complete.

Initial Screening Of In-Situ Groundwater Bioremediation

This section allows you to quickly assess whether in-situ groundwater bioremediation is likely to be effective at a site. The key parameters that determine the effectiveness of this technology are:

- The *hydraulic conductivity* of the aquifer, which controls the distribution of electron acceptors and nutrients in the subsurface;
- The *biodegradability* of the petroleum constituents, which determines both the rate and degree to which constituents will be degraded by microorganisms; and
- The *location of petroleum contamination* in the subsurface. Contaminants must be dissolved in groundwater or adsorbed onto more permeable sediments within the aquifer.

In general, the aquifer medium will determine *hydraulic conductivity*. Fine-grained media (e.g., clays, silts) have lower intrinsic permeability than coarse-grained media (e.g., sands, gravels).

Bioremediation is generally effective in permeable (e.g., sandy, gravelly) aquifer media. However, depending on the extent of contamination, bioremediation also can be effective in less permeable silty or clayey media. In general, an aquifer medium of lower permeability will require longer to clean up than a more permeable medium.

The *biodegradability* of a petroleum constituent is a measure of its ability to be metabolized (or co-metabolized) by hydrocarbon-degrading bacteria or other microorganisms.

The chemical characteristics of the contaminants will dictate their biodegradability. For example, heavy metals are not degraded by bioremediation. The biodegradability of organic constituents depends on their chemical structures and physical/chemical properties (e.g., water solubility, water/octanol partition coefficient). Highly soluble organic compounds with low molecular weights will tend to be more rapidly degraded than slightly soluble compounds with high molecular weights. The low water solubilities of the more complex compounds render them less bioavailable to petroleum-degrading organisms. Consequently, the larger, more complex chemical compounds may be slow to degrade or may even be recalcitrant to biological degradation (e.g., asphaltenes in No. 6 fuel oil).

The location, distribution, and disposition of petroleum contamination in the subsurface can significantly influence the likelihood of success for

bioremediation. This technology generally works well for dissolved contaminants and contamination adsorbed onto higher permeability sediments (sands and gravels). However, if the majority of contamination is (1) in the unsaturated zone; (2) trapped in lower permeability sediments, or (3) outside the "flow path" for nutrients and electron acceptors, this technology will have reduced impact or no impact.

Exhibit X-5 is an initial screening tool that you can use to help assess the potential effectiveness of in-situ groundwater bioremediation. To use this tool, you must first determine the type of aquifer medium present and the type of petroleum product released at the site. Information provided in the following section will allow a more thorough evaluation of

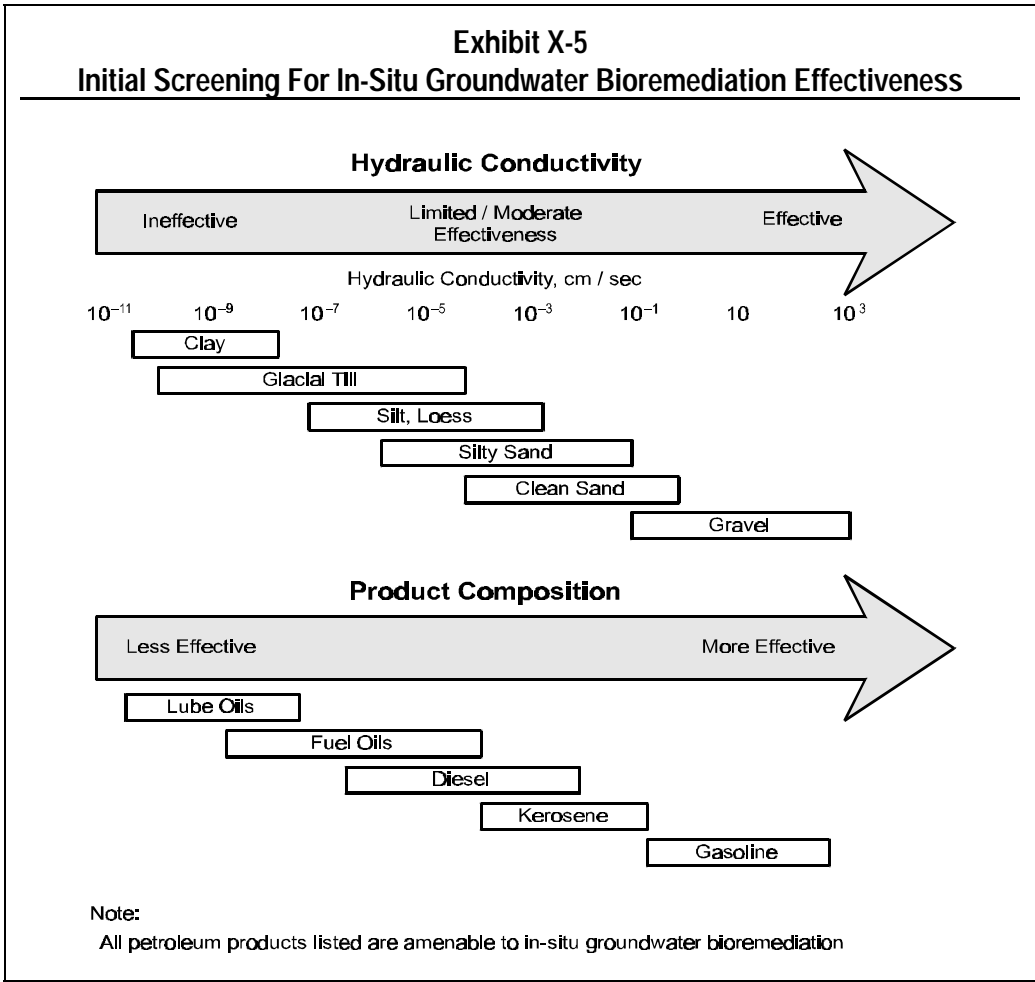

effectiveness and will identify areas that could require special design considerations.

Detailed Evaluation Of In-Situ Groundwater Bioremediation Effectiveness

Once you have completed the initial screening and determined that in-situ groundwater bioremediation may be effective for the aquifer media and petroleum product present, evaluate the CAP further to confirm that the technology will be effective.

While the initial screening focused on hydraulic conductivity and constituent biodegradability, the detailed evaluation should consider a broader range of site and constituent characteristics, which are listed in Exhibit X-6.

Exhibit X-6 Key Parameters Used To Evaluate The Effectiveness Of In-Situ Groundwater Bioremediation	
Site Characteristics	Constituent Characteristics
Hydraulic conductivity	Chemical structure
Soil structure and stratification	Concentration and toxicity
Groundwater mineral content	Solubility
Groundwater pH	
Groundwater temperature	
Microbial presence	
Terminal electron acceptors	
Nutrient concentrations	

The remainder of this section describes each parameter, why it is important to in-situ groundwater bioremediation, how it can be determined, and a range of values over which in-situ groundwater bioremediation is generally effective.

Site Characteristics That Affect In-Situ Groundwater Bioremediation

Site characteristics that influence the potential effectiveness of in-situ groundwater bioremediation are described below.

Hydraulic Conductivity

Hydraulic conductivity, which is a measure of water's ability to move through the aquifer medium, is one of the important factors in determining the potential effectiveness of in-situ groundwater bioremediation. This characteristic controls the rate and the distribution of electron acceptors and nutrients delivered to the bacteria in the aquifer. Hydraulic conductivity can be determined from aquifer tests, including slug tests and pumping tests. These tests must be designed carefully to ensure that contaminants are not forced to spread further in the aquifer and that a large volume of contaminated groundwater is not generated which then requires expensive treatment or disposal. The hydraulic conductivity of aquifer media varies over a wide range depending on the constituent materials (e.g., sand, gravel, silt, clay). In general, fine-grained soils composed of clays or silts offer resistance to water flow. Soils that are highly fractured, however, may have sufficient permeability to use in-situ bioremediation. For aquifers with hydraulic conductivity greater than 10^{-4} cm/sec, in-situ groundwater bioremediation is effective. For sites with lower hydraulic conductivities (e.g., 10^{-4} to 10^{-6} cm/sec), the technology also could be effective, but it must be carefully evaluated, designed, and controlled.

Intrinsic permeability, which is a measure of the ability of soils to transmit fluids, is sometimes reported instead of hydraulic conductivity. If intrinsic permeability is given, you calculate the hydraulic conductivity from the following equation:

$$K = \frac{k(\rho g)}{\mu}$$

where

K = hydraulic conductivity (cm/sec),

k = intrinsic permeability (cm²),

μ = water viscosity (g/cm · sec),

ρ = water density (g/cm³),

g = acceleration of gravity (cm/sec²).

At 20°C: $(\rho g/\mu) = 9.8 \times 10^4 \text{ (cm} \cdot \text{sec)}^{-1}$. To convert k from cm^2 to darcy, multiply by 10^8 .

Soil Structure and Stratification

Soil structure and stratification are important to in-situ groundwater bioremediation because they affect groundwater flowrates and patterns when water is extracted or injected. Structural characteristics such as microfracturing can result in higher permeabilities than expected for certain soils (e.g., clays). In this case, however, flow will increase in the fractured media but not in the unfractured media. The stratification of soils with different permeabilities can dramatically increase the lateral flow of groundwater in the more permeable strata while reducing the flow through less permeable strata. This preferential flow behavior can lead to reduced effectiveness and extended remedial times for less-permeable strata.

The intergranular structure and stratification of aquifer media can be determined by reviewing soil logs from wells or borings and by examining geologic cross-sections. It will be necessary to verify that soil types have been properly identified, that visual observations of soil structure have been documented, and that boring logs are of sufficient detail to define soil stratification. Stratified soils may require special design consideration (e.g., special injection well(s)) to ensure that these less-permeable strata are adequately handled.

Fluctuations in the groundwater table should also be determined. Significant seasonal or daily (e.g., tidal, precipitation-related) fluctuations will submerge some of the soil in the unsaturated zone, which should be considered during design of the system.

Groundwater Mineral Content

Excessive calcium, magnesium, or iron in groundwater can react with phosphate, which is typically supplied as a nutrient in the form of tripolyphosphate, or with carbon dioxide, which is produced by microorganisms as a by-product of aerobic respiration. The products of these reactions can adversely affect the operation of an in-situ bioremediation system. When calcium, magnesium, or iron reacts with phosphate or carbon dioxide, crystalline precipitates or "scale" is formed. Scale can constrict flow channels and can also damage equipment, such as injection wells and sparge points. In addition, the precipitation of calcium or magnesium phosphates ties up phosphorus compounds, making them unavailable to microorganisms for use as nutrients. This effect can be minimized by using tripolyphosphates in a mole ratio of greater than 1:1 tripolyphosphates to total minerals (i.e., magnesium

and calcium). At these concentrations, the triphosphate acts as a sequestering agent to keep the magnesium and calcium in solution (i.e., prevent the metal ions from precipitating and forming scale).

When oxygen is introduced to the subsurface as a terminal electron acceptor, it can react with dissolved iron (Fe^{+2}) to form an insoluble iron precipitate, ferric oxide. This precipitate can be deposited in aquifer flow channels, reducing permeability. The effects of iron precipitation tend to be most noticeable around injection wells, where oxygen concentration in groundwater is highest and can render injection wells inoperable. Exhibit X-7 provides a guide to assessing the potential impact of dissolved iron in groundwater.

Exhibit X-7 Dissolved Iron And In-Situ Bioremediation Effectiveness	
Dissolved Iron Concentration (mg/L)	Effectiveness
$Fe^{+2} < 10$	Probably effective
$10 \leq Fe^{+2} \leq 20$	Injection wells require periodic testing and may need periodic cleaning or replacement
$Fe^{+2} > 20$	Not recommended

Other parameters that could be good indicators of potential groundwater scaling are hardness, alkalinity, and pH. In particular, very hard water (i.e., > 400-500 mg/L carbonate hardness) tends to promote promote scaling. The potential adverse effects caused by excessive mineral content (e.g., calcium, magnesium, iron, total carbonates) in the groundwater warrants careful attention during site characterization activities.

Groundwater pH

Extreme pH values (i.e., less than 5 or greater than 10) are generally unfavorable for microbial activity. Typically, optimal microbial activity occurs under neutral pH conditions (i.e., in the range of 6-8). The optimal pH is site specific. For example, aggressive microbial activity has been observed at lower pH conditions outside of this range (e.g., 4.5 to 5) in natural systems. Because indigenous microorganisms have adapted to the natural conditions where they are found, pH adjustment, even toward neutral, can inhibit microbial activity. If man-made

conditions (e.g., releases of petroleum) have altered the pH outside the neutral range, pH adjustment may be needed. If the pH of the groundwater is too low (too acid), lime or sodium hydroxide can be added to increase the pH. If the pH is too high (too alkaline), then a suitable acid (e.g., hydrochloric, muriatic) can be added to reduce the pH. Changes to pH should be closely monitored because rapid changes of more than 1 or 2 units can inhibit microbial activity and may require an extended acclimation period before the microbes resume their activity.

Groundwater Temperature

Bacterial growth rate is a function of temperature. Subsurface microbial activity has been shown to decrease significantly at temperatures below 10°C and essentially to cease below 5°C. Microbial activity of most bacterial species important to petroleum hydrocarbon biodegradation also diminishes at temperatures greater than 45°C. Within the range of 10°C to 45°C, the rate of microbial activity typically doubles for every 10°C rise in temperature. In most cases, for in-situ groundwater bioremediation, the bacteria living in an aquifer system are likely to experience relatively stable temperatures with only slight seasonal variations. In most areas of the U.S., the average groundwater temperature is about 13°C, but groundwater temperatures may be somewhat lower or higher in the extreme northern and southern states.

Microbial Presence

Soil normally contains large numbers of diverse microorganisms, including bacteria, algae, fungi, protozoa, and actinomycetes. Of these organisms, the bacteria are the most numerous and biochemically active group, particularly at low oxygen levels, and they contribute significantly to in-situ groundwater bioremediation.

At a contaminated site, the natural microbial population undergoes a selection process. First, there is an acclimation period, during which microbes adjust to their new environment and new source of food. Second, those organisms that adapt most quickly tend to grow fastest and can use up nutrients that other microbes would need. Third, as the environmental conditions change and the nature of the food supply changes, the microorganism populations change as well. Organisms capable of withstanding the stress of their changing environment will generally be those that will contribute to the bioremediation of the site.

To determine the presence and population density of naturally occurring bacteria that will contribute to degradation of petroleum constituents, laboratory analysis of soil samples from the site should be completed. These analyses, at a minimum, should include plate counts

for total heterotrophic bacteria (i.e., bacteria that use organic compounds as an energy source) and hydrocarbon-degrading bacteria. Although heterotrophic bacteria are normally present in all soil environments, plate counts of less than 1,000 colony-forming units (CFU)/gram of soil could indicate depletion of oxygen or other essential nutrients or the presence of toxic constituents. However, concentrations as low as 100 CFU per gram of soil can be stimulated to acceptable levels, assuming toxic conditions (e.g., exceptionally high concentrations of heavy metals) are not present. These conditions are summarized in Exhibit X-8.

Exhibit X-8	
<u>Heterotrophic Bacteria And In-Situ Groundwater Bioremediation Effectiveness</u>	
<u>Total Heterotrophic Bacteria</u>	<u>Effectiveness</u>
> 1,000 CFU/gram dry soil	Generally effective.
100 - 1,000 CFU/gram dry soil	May be effective; needs further evaluation to determine whether toxic conditions are present and/or whether population responds to stimulation (e.g., increased supply of electron acceptor and/or nutrients).
< 100	Not generally effective.

Some CAPs propose the addition of microorganisms (bioaugmentation) into the aquifer environment when colony plate counts are low. However, research has shown that most in-situ bioremediation projects have been successfully completed without microbial augmentation. Experience with microbial augmentation shows that it varies in effectiveness. Except in coarse-grained, highly permeable material, microbes tend not to move very far past the point of injection, therefore, their effectiveness is limited in extent. In general, microbial augmentation does not adversely affect bioremediation, but it could be an unnecessary cost.

Terminal Electron Acceptors

Microorganisms require carbon as an energy source to sustain their metabolic functions, which include growth and reproduction. The metabolic process used by bacteria to produce energy requires a terminal electron acceptor (TEA) to enzymatically oxidize the carbon source (organic matter) to carbon dioxide.



where ΔH_f is energy generated by the reaction to fuel other metabolic processes including growth and reproduction. In this example, oxygen serves as the TEA.

Microorganisms are classified by the carbon and TEA sources they use to carry out metabolic processes. Bacteria that use organic compounds as their source of carbon are called *heterotrophs*; those that use inorganic carbon compounds such as carbon dioxide are called *autotrophs*. Bacteria that use oxygen as their TEA are called *aerobes*; those that use a compound other than oxygen (e.g., nitrate, sulfate) are called *anaerobes*; and those that can utilize both oxygen and other compounds as TEAs are called *facultative*. For in-situ groundwater bioremediation applications directed at petroleum products, bacteria that are both *aerobic* (or *facultative*) and *heterotrophic* are most important in the degradation process.

Nutrient Concentrations

Microorganisms require inorganic nutrients such as nitrogen and phosphate to support cell growth and sustain biodegradation processes. Nutrients may be available in sufficient quantities in the aquifer but, more frequently, nutrients need to be added to maintain adequate bacterial populations.

A rough approximation of maximum nutrient requirements can be based on the stoichiometry of the overall biodegradation process:

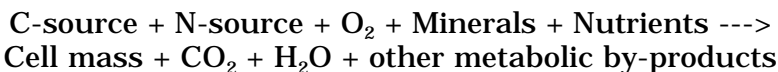

Different empirical formulas of bacterial cell mass have been proposed; the most widely accepted are $\text{C}_5\text{H}_7\text{NO}_2$ and $\text{C}_{60}\text{H}_{87}\text{O}_{32}\text{N}_{12}\text{P}$. Using the empirical formulas for cell biomass and other assumptions, the carbon:nitrogen:phosphorus ratios necessary to enhance biodegradation fall in the range of 100:10:1 to 100:1:0.5, depending on the constituents and bacteria involved in the biodegradation process.

Chemical analyses of soil samples (collected from below the water table) and groundwater samples should be completed to determine the available concentrations of nitrogen (expressed as ammonia) and phosphate. Soil analyses are routinely conducted in agronomic laboratories that test soil fertility for farmers. These concentrations can be compared to the nitrogen and phosphorus requirements calculated

from the stoichiometric ratios of the biodegradation process. Some microbes can use nitrate as a nitrogen source. The drinking water standard for nitrate is 40 mg/L and there may be regulatory prohibitions against injecting nitrate into groundwater. If nitrogen addition is necessary, slow release sources should be used and addition of these materials should be monitored throughout the project to prevent degradation of water quality. In addition, excessive nitrogen additions can lower soil pH, depending on the amount and type of nitrogen added.

Because of water quality and soil chemistry considerations, in situ groundwater bioremediation should be operated at near nutrient-limited conditions.

Constituent Characteristics That Affect In-Situ Groundwater Bioremediation

Chemical Structure

The chemical structures of the constituents to be treated by in-situ groundwater bioremediation are important for determining the rate at which biodegradation will occur. Although nearly all constituents in petroleum products typically found at UST sites are biodegradable, the more complex the molecular structure of the constituent, the more difficult the product is to treat and the greater the time required for treatment. Most low-molecular-weight (nine carbon atoms or less) aliphatic and monoaromatic constituents are more easily biodegraded than higher-molecular-weight aliphatic or polyaromatic organic constituents. Straight chain, aliphatic (i.e., alkanes, alkenes, and alkynes) hydrocarbon compounds are more readily degraded than their branched isomers, and mono-aromatic compounds (e.g., benzene, ethyl benzene, toluene, xylenes) are more rapidly degraded than the two-ring compounds (e.g., naphthalene), which in turn are more rapidly degraded than the larger multi-ringed compounds (i.e., polyaromatic hydrocarbons or polynuclear aromatic hydrocarbons). The larger, more complex chemical structures may be slow to degrade or be essentially resistant to biological degradation (e.g., asphaltenes in No. 6 fuel oil). Exhibit X-9 lists, in order of decreasing rate of potential biodegradability, some common constituents found at petroleum UST sites.

Petroleum hydrocarbon contamination is sometimes accompanied by other organic contaminants, including both non-chlorinated solvents (e.g., alcohols, ketones, esters, acids) and chlorinated compounds (e.g., trichloroethane, chlorinated phenols, polychlorinated biphenyls (PCBs)). The non-chlorinated solvents tend to be readily biodegradable but can exert toxic effects at high concentrations. Lightly chlorinated compounds (e.g., chlorobenzene, dichlorobenzene, chlorinated phenols,

Exhibit X-9
Chemical Structure And Biodegradability

Biodegradability	Example Constituents	Products In Which Constituent Is Typically Found
More degradable	n-butane, l-pentane, n-octane	<input type="radio"/> Gasoline
	Nonane	<input type="radio"/> Diesel fuel
	Methyl butane, dimethylpentenes, methyloctanes	<input type="radio"/> Gasoline
	Benzene, toluene, ethylbenzene, xylenes	<input type="radio"/> Gasoline
	Propylbenzenes	<input type="radio"/> Diesel, kerosene
	Decanes	<input type="radio"/> Diesel
	Dodecanes	<input type="radio"/> Kerosene
	Tridecanes	<input type="radio"/> Heating fuels
	Tetradecanes	<input type="radio"/> Lubricating oils
	Less degradable	Naphthalenes
Fluoranthenes		<input type="radio"/> Kerosene
Pyrenes		<input type="radio"/> Heating oil
Acenaphthenes		<input type="radio"/> Lubricating oils
Resistant	Asphaltenes	<input type="radio"/> Fuel oil no. 6
	MTBE	<input type="radio"/> Gasoline

lightly chlorinated PCBs) are typically degradable under aerobic conditions. The more highly chlorinated compounds tend to be more resistant to aerobic degradation, but they can be degraded by dechlorination under anaerobic conditions. Several common chlorinated solvents (e.g., chlorinated ethanes, ethenes) can be degraded under aerobic conditions if they exist in the presence of another contaminant that can behave as a co-metabolite (e.g., methane, toluene, phenol).

Evaluation of the chemical structure of the constituents proposed for reduction by in-situ groundwater bioremediation at the site will allow you to determine which constituents will be the most difficult to degrade. You should verify that remedial time estimates, treatability studies, and operation and monitoring plans are based on the constituents that are the most difficult to degrade in the biodegradation process.

Concentration And Toxicity

High concentrations of petroleum organics or heavy metals in site soils can be toxic to or inhibit the growth and reproduction of bacteria responsible for biodegradation. In addition, very low concentrations of organic material will result in diminished levels of bacterial activity.

In general, concentrations of petroleum hydrocarbons (measured as total petroleum hydrocarbons) in excess of 50,000 ppm, organic solvent concentrations in excess of 7,000 ppm, or heavy metals in excess of 2,500 ppm in the groundwater or aquifer medium are considered inhibitory and/or toxic to aerobic bacteria. Review the CAP to verify that the average concentrations of petroleum hydrocarbons and heavy metals in the soils and groundwater to be treated are below these levels. Exhibit X-10 provides the general criteria for constituent concentration and bioremediation effectiveness.

Exhibit X-10 Constituent Concentration And In-Situ Groundwater Bioremediation Effectiveness	
Constituent Concentration	In-Situ Groundwater Bioremediation Effectiveness
Petroleum constituents \leq 50,000 ppm, Solvent constituents \leq 7,000 ppm, and Heavy metals \leq 2,500 ppm	Effective.
Petroleum constituents $>$ 50,000 ppm, Solvent constituents $>$ 7,000 ppm, or Heavy metals $>$ 2,500 ppm	Ineffective; toxic or inhibitory conditions to bacterial growth exist. Long remediation times likely.

In addition to maximum concentrations, you should consider the cleanup concentrations proposed for the treated soils. Below a certain "threshold" constituent concentration, the bacteria cannot obtain sufficient carbon from degradation of the constituents to maintain adequate biological activity. The threshold level determined from treatability studies conducted in the laboratory is likely to be much lower than what is achievable in the field under less than optimal conditions. Although the threshold limit varies greatly depending on bacteria-specific and constituent-specific features, constituent concentrations below 0.1 ppm in the total aquifer matrix may be difficult to achieve. However, concentrations in the groundwater for these

specific constituents may be below detection levels. Experience has shown that reductions in petroleum hydrocarbon concentrations greater than 95 percent can be very difficult to achieve because of the presence of "resistant" or nondegradable petroleum constituents. Identify the average starting concentrations and the desired cleanup concentrations in the CAP. If a cleanup level lower than 0.1 ppm is required for any individual constituent or a reduction in petroleum hydrocarbon concentration of greater than 95 percent is required to reach the cleanup level, either a treatability study should be required to demonstrate the ability of bioremediation to achieve these reductions at the site, or another technology should be considered. Another option is to combine one or more technologies to achieve cleanup goals. These conditions are summarized in Exhibit X-11.

Exhibit X-11	
<u>Cleanup Concentrations And In-Situ Groundwater Bioremediation Effectiveness</u>	
<u>Cleanup Requirement</u>	<u>In-Situ Groundwater Bioremediation Effectiveness</u>
Constituent concentration > 0.1 ppm and Petroleum hydrocarbon reduction < 95%	Effective.
Constituent concentration ≤ 0.1 ppm or Petroleum hydrocarbon reduction ≥ 95%	Potentially effective; pilot studies are required to demonstrate reductions.

Solubility

Solubility is the amount of a substance (e.g., hydrocarbon) that will dissolve in a given amount of another substance (e.g., water). Therefore, a constituent's solubility provides insight to its fate and transport in the aqueous phase. Constituents that are highly soluble have a tendency to dissolve into the groundwater and are more available for biodegradation. Conversely, chemicals that have low water solubilities tend to remain in the adsorbed phase and will biodegrade more slowly. In general, lower molecular weight constituents tend to be more soluble and biodegrade more readily than do higher molecular weight or heavier constituents.

In the field, aqueous concentrations rarely approach the solubility of a substance because dissolved concentrations tend to be reduced through competitive dissolution of other constituents and degradation processes such as biodegradation, dilution, and adsorption.

Treatability Testing

To implement an in-situ groundwater bioremediation system at a site contaminated with compounds other than BTEX, treatability testing should be performed to verify applicability of the proposed remedial approach and to develop site specific design criteria and operating conditions. Treatability testing is probably not necessary at typical gasoline station sites. This is because the microbes capable of degrading BTEX compounds are ubiquitous and the contaminants are known to be degradable. This treatability testing can be accomplished in two phases – bench-scale and pilot-scale testing. Bench-scale tests are conducted in the laboratory (using apparatus sufficiently small to be placed on a laboratory bench) to evaluate the feasibility of a process, while pilot-scale tests simulate full-scale operations and are often conducted in the field. The extent and scope of the treatability testing will depend greatly on the volume of groundwater to be remediated.

For a relatively small volume of water with fairly well defined site and constituent characteristics, bench-scale testing may suffice. However, for large, more complex sites, it is recommended that both bench- and pilot-scale treatability testing be performed.

Bench-Scale Treatability Testing

The purposes of a bench-scale treatability study are to determine the following treatability characteristics:

- Presence of a responsive microbial population;
- Biodegradability of the groundwater contaminants;
- Degradation rate;
- Oxygen and nutrients required to sustain the biodegradation;
- Likely interactions between the introduced and generated compounds and the aquifer media (plugging potential); and
- Achievable cleanup levels.

There are two basic types of bench-scale studies, the flask (slurry) study and the column study. For flask studies, samples of aquifer material and contaminated groundwater are analyzed to determine the presence of organic, inorganic, and heavy metal compounds, and to estimate the numbers of microbes present. A minimum of three treatment conditions are generally tested – some combination of nutrients, a supply of

electron acceptors, and possibly an introduction of commercially available microorganisms. Tests are conducted over a 4- to 12-week period (most commonly 8 to 10 weeks) in both sterile and unamended control conditions. During this time, analyses are periodically performed to determine the rate of biodegradation. Results of flask studies should be considered as representing optimal conditions because the flask microcosm does not consider the effects of variables such as limited oxygen and nutrient delivery or soil heterogeneity. At the completion of the study, a preliminary treatment design is prepared that specifies the anticipated rate of contaminant reduction (cleanup time) and the quantities of oxygen and nutrients required.

Column studies employ the same approach as flask studies. Glass columns are filled with aquifer material, and contaminated groundwater is percolated through the columns; sterile and nutrient-amended columns are also evaluated as controls. While the columns do not accurately re-create actual in-situ conditions, they do provide an indication of the likely effects of adsorption and precipitation within the aquifer medium.

Pilot-Scale Treatability Testing

Pilot-scale treatability testing is a simulation of the full scale operation. The objective of this type of treatability testing is to verify treatability of constituents of concern under actual field conditions and to generate data to design the full-scale system. At small, typical gasoline stations, the pilot-scale system will be the same as the full-scale system. This pilot testing could extend from a few weeks to several months depending on the data generation requirements. Longer study times are required to track contaminant reduction to project the time required to attain clean-up goals.

A pilot testing program could also include the following:

- Pumping test to determine sustained groundwater extraction rate and general aquifer response;
- Aquifer recharge response tests (tracer test);
- Microbial response to injection of electron acceptor and nutrients; and
- Long-term operability of the system (aquifer and/or injection well fouling).

Information from these tests will be generated from measurements collected from a network of monitoring wells. The results of these tests will enable determination of (1) groundwater flow velocities and flow

paths in the vicinity of the injection well or infiltration gallery and extraction well, (2) potential zones of anisotropy within the aquifer (i.e., areas where properties, such as hydraulic conductivity, vary depending on the direction in which they are measured), (3) the distribution and concentrations of electron acceptors and nutrients, and (4) site specific remediation rates. Long-term operation of the pilot system also will provide information on potential fouling/plugging of the aquifer matrix in the vicinity of injection and extraction wells. Monitoring wells should be sampled at a frequency which will allow statistical validation of data generated.

Groundwater Modeling

For large, complex sites and even for some smaller sites, groundwater modeling can be a valuable tool to develop a more accurate conceptualization of the site and analyze the impacts of varying the locations and pumping rates of injection and extraction wells. This can be very important in determining whether the system can achieve and maintain hydraulic containment of the contaminant plume. The complexity and sophistication of the model used will depend on the site characteristics and the amount of data available to develop the model. The cost of groundwater modeling needs to be evaluated against the total remediation costs of the site. The data generated in the site characterization and pilot testing can be incorporated into a model that provides projections and predictions of aquifer conditions with time. Typical factors that can be determined by modeling include:

- Aquifer conditions, including flow rates and direction, water levels, extraction/injection points, aquifer sensitivity;
- Numbers, locations, and configurations of injection, extraction, and monitoring wells that will maximize system efficiency; and
- Fate and transport of contaminants, including concentration, distribution, and degradation with time.

Evaluations Of In-Situ Groundwater Bioremediation System Design

Once you have verified that in-situ groundwater bioremediation has the potential to be effective, you can evaluate the design of the proposed remedial system. The CAP should include a discussion of the rationale for the design and present the conceptual engineering design. Detailed engineering design documents might also be included, depending on state requirements.

Rationale For The Design

The following design elements are presented in the order in which design information might typically be collected.

- *Volume and area of aquifer to be treated* is generally determined by site characterization combined with regulatory action levels or a site-specific risk assessment.
- *Initial concentration of constituents of concern* can be measured during initial site characterization and during treatability studies. These concentrations will be used to predict likely toxic effects of the contaminants on indigenous microorganisms and to estimate electron acceptor and nutrient requirements, and the extent of treatment required.
- *Required Final Constituent Concentrations* are generally defined by your state as remediation action levels or determined on a site-specific basis using transport models and/or risk assessment calculations. These limits will define the areal extent of the aquifer to be remediated.
- *Estimates of electron acceptor and nutrient requirements.* As a rule of thumb, 3 lbs of oxygen are added per pound of hydrocarbon as an electron acceptor. For nutrients, a maximum ratio of 100:10:1 for C:N:P is typically used (assume 1 pound of hydrocarbon is equal to 1 pound of carbon). Often systems require substantially less, on the order of 100:1:0.5, especially if plugging of injection wells/galleries is a problem.
- *Layout of injection and extraction wells.* Probably the most critical factor is ensuring that the contaminant plume is hydraulically controlled. This will prevent it from spreading and concentrate bioremediation efforts on the contaminants. For large complex sites, designing this layout can be facilitated by groundwater modeling. Injection wells/infiltration galleries can be located upgradient of the contaminant source, with extraction wells located downgradient of the source. Alternatively, injection points can be located along the centerline of the plume axis, with extraction wells located on the edges of the plume. The latter arrangement can typically achieve shorter remediation times, but at greater expense.
- *Design Area of Influence.* (AOI) is an estimate of the volume/area of aquifer to which an adequate amount of electron acceptor and nutrient can be supplied to sustain microbial activity. Establishing the design AOI is not a trivial task because it depends on many

factors including intrinsic permeability of the soil, soil chemistry, moisture content, and desired remediation time. Although the AOI should usually be determined through field pilot studies, it can be estimated from groundwater modeling or other empirical methods. For sites with stratified geology, the area of influence should be defined for each soil type. The AOI is important in determining the appropriate number and spacing of extraction or injection wells or infiltration galleries.

- *Groundwater extraction and injection flow rates* can vary from a few to a few hundred gallons per minute, depending primarily on the hydraulic conductivity of the aquifer. Although flow rates can be estimated by groundwater modeling, they are best determined by pilot studies. In general, only about 75 percent of extracted water can be readily re-injected using either injection wells or infiltration galleries.
- *Site Construction Limitations.* Locations of buildings, utilities, buried objects, etc. must be identified and considered in the design process.
- *Electron Acceptor System.* For aerobic processing, air, oxygen or hydrogen peroxide can be used; for anaerobic processing, alternative electron acceptors (e.g., nitrate, sulfate, or ferric iron) can be used. The electron acceptors may be introduced using a direct air/oxygen sparge system into the injection well (air sparging) or a water injection system.
- *Nutrient Formulation and Delivery System.* Site characterization and bench-scale treatability studies will determine if nutrients are required. The nutrients selected should be compatible with aquifer chemistry to minimize precipitation and flow-channel fouling.
- *Bioaugmentation.* Microorganisms can be added to the injected or infiltrated water to increase microbial activity. However, as discussed earlier, bioaugmentation is usually not necessary.
- *Extracted Groundwater Treatment and Disposition.* The above ground treatment system for extracted groundwater should be of sufficient size to process the volume of water extracted. Disposition of treated groundwater will depend on specific state policies. Some states discourage reinjection, although in most instances, re-injection makes good technical sense without causing adverse impacts on the receiving groundwater. Groundwater treatment systems could entail biological, chemical, and/or physical treatment. The selection of the appropriate extracted groundwater treatment technology will depend on the proposed duration of operation, size of treatment system, and cost.

- *Remedial Cleanup Time.* Imposed remedial cleanup time could affect the design of the remedial system. Ultimately, the duration of the cleanup will depend on the rate of biological activity attainable, the bio-availability of the contaminants of concern, and the locations and spacings of the injection/extraction wells.
- *Ratio of Injection/Infiltration to Extraction.* The percentage of the treated water that is reinjected or re-infiltrated should be based on hydraulic control. Because dispersion and diffusion at the boundary the AOI is likely to allow some migration of contaminated groundwater, less groundwater is generally injected or recharged to the aquifer than is extracted. This provides for better hydraulic containment of the contamination.
- *Free Product Recovery System.* A system designed to recover free product should be used to reduce "source" input effects to the groundwater and generally optimize saturated zone remediation.

Components Of An In-Situ Groundwater Bioremediation System

Once the design rationale is defined, the design of the in-situ groundwater bioremediation system can be developed. Exhibit X-12 is a schematic diagram of a typical in-situ groundwater bioremediation system using injection wells. A typical in-situ groundwater bioremediation system design includes the following components and information:

- Extraction well(s) orientation, placement, and construction details;
- Injection well(s) or infiltration gallery(ies) orientation, placement, and construction details;
- Filtration system to remove biomass and particulates that could promote clogging of injection wells or galleries;
- Extracted groundwater treatment system (e.g., biological, chemical oxidation, granular carbon adsorption) and methods for disposal or re-use of treated groundwater (surface discharge, discharge to a sewer, re-injection);
- Nutrient solution preparation system and storage;
- Microorganism addition system (if required);
- Electron acceptor system (e.g., air, oxygen, hydrogen peroxide);

Exhibit X-12
Schematic Diagram Of Typical In-Situ Groundwater Bioremediation System
Using Injection Wells

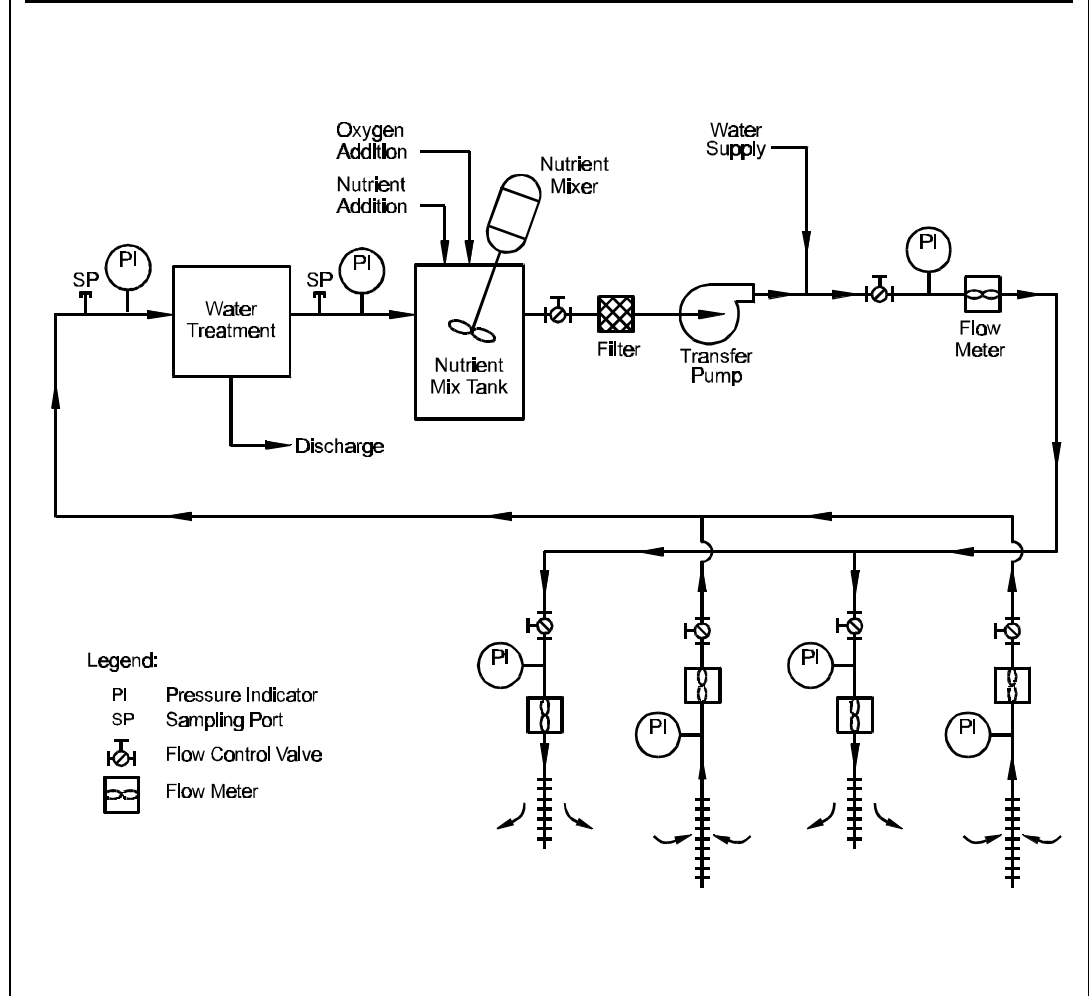

○ Monitoring well(s) orientation, placement, and construction details;
 and

○ System controls and alarms.

Extraction wells are generally necessary to achieve hydraulic control over the plume to ensure that it does not spread contaminants into areas where contamination does not exist or accelerate the movement toward receptors. Placement of extraction wells is critical, especially in systems that also use nutrient injection wells or infiltration galleries. These additional sources of water can alter the natural groundwater flow patterns which can cause the contaminant plume to move in an unintended direction or rate. Without adequate hydraulic control, this

situation can lead to worsening of the original condition and complicate the cleanup or extend it.

Nutrient injection systems may not be necessary at all, if the groundwater contains adequate amounts of nutrients, such as nitrogen and phosphorus.

The following sections provide more detailed descriptions of the electron acceptor and nutrient addition systems and system control alarms. For a detailed explanation of suggested well construction guidelines, see Chapters VII and VIII, "Air Sparging" and "Biosparging." In some cases, electron acceptor and nutrient supply systems are combined rather than discrete systems (i.e., both the electron acceptor and nutrients are added to the same stream for injection into the aquifer).

Well Placement

Location of extraction wells, injection wells (or infiltration galleries), and monitoring wells can vary substantially depending on site-specific conditions. However, the essential goals in configuring these wells are as follows:

- Extraction wells should be located such that hydraulic control is achieved at the outer limits of the contaminant plume. In other words, the cones of depression created by the pumping wells should intersect so that hydraulic gradients throughout the plume are inward in the direction of the pumping wells;
- Injection wells (and/or infiltration galleries) should be located to provide distribution of the electron acceptor and nutrients throughout the area targeted for remediation; the impacts on water table gradients caused by injection well location and rate of liquid injection should be considered carefully. Excessive mounding of the water table could induce migration of contaminants in unintended directions, or alter the effectiveness of the extraction well in achieving hydraulic control; and
- Monitoring wells should be located outside the plume in each direction and within the plume to track remedial progress and to ensure that the extraction wells are achieving the desired hydraulic control and preventing further migration.

One possible configuration of extraction, injection, and monitoring wells is shown in Exhibit X-13.

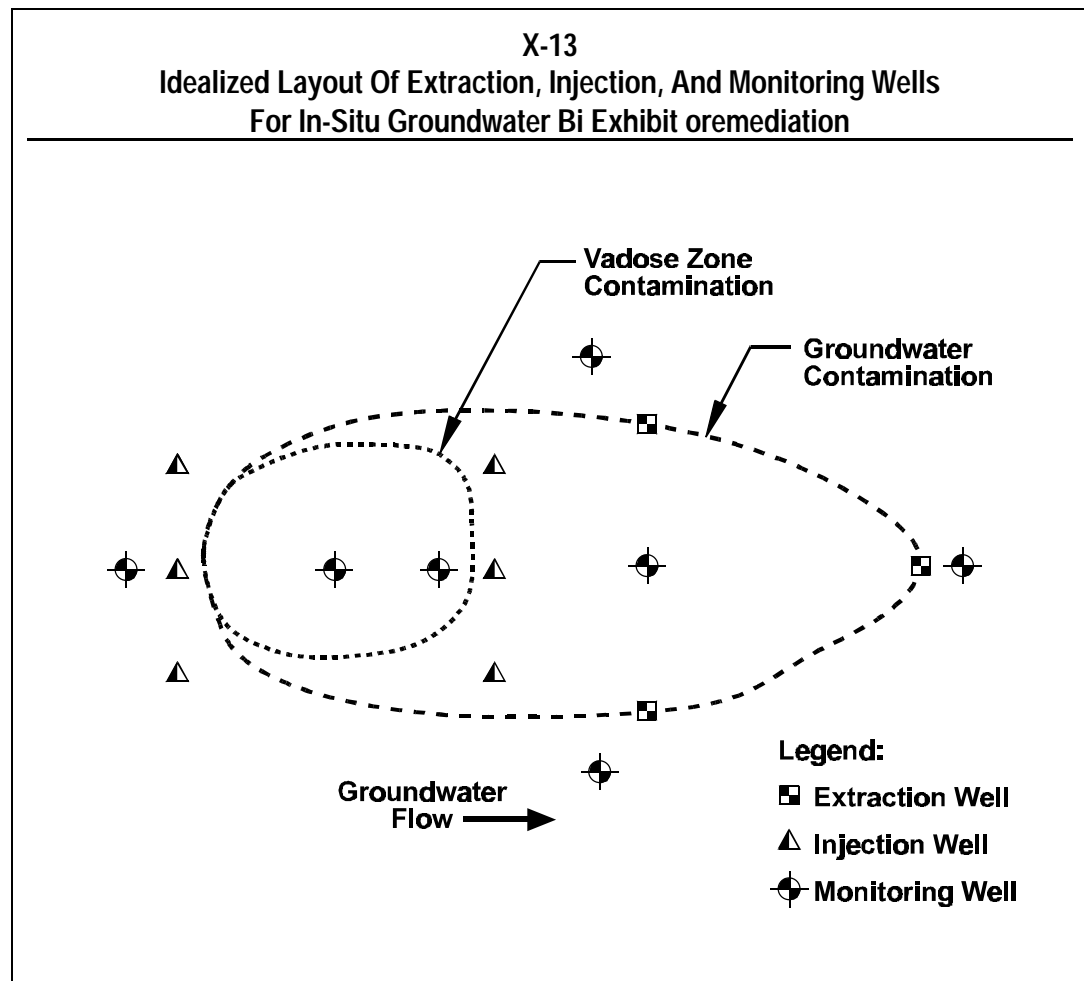

The design area of influence of extraction and injection wells will determine the number of wells needed. The area of influence of neighboring extraction wells should overlap to achieve hydraulic control.

Electron Acceptor and Nutrient Addition System

For a given site, selection of an appropriate electron acceptor will depend on the results of the treatability studies. The most widely used electron acceptor in the remediation of petroleum hydrocarbons is oxygen, which enhances the aerobic biological process. Oxygen can be delivered by either a "carrier stream" of water which has been enriched with atmospheric air or pure oxygen or by air or oxygen sparging. Air sparging is covered in Chapter VII. Water saturated with atmospheric air (20 percent oxygen) contains dissolved oxygen concentrations of 8-10 mg/l. Water saturated with pure oxygen can attain dissolved oxygen concentrations of approximately 40 mg/l.

Higher dissolved oxygen concentrations in groundwater are attainable with hydrogen peroxide. However, at levels greater than 500 to 1,000 mg/l, hydrogen peroxide behaves like a biocide; therefore, it should be used with caution. Hydrogen peroxide degrades relatively rapidly and is very difficult to disperse through the aquifer. Also, hydrogen peroxide is very expensive, and its use may not be cost-effective.

A typical electron acceptor addition system would include:

- Oxygen Enriched Stream, including an air blower or pure oxygen source and contacting chamber;
- Injection Well Sparging System, including an air blower or pure oxygen source; or
- Hydrogen Peroxide System, including a hydrogen peroxide supply, storage, and metering pump system.

A typical nutrient addition system could include the following components:

- Reagent (e.g., hydrogen peroxide, ammonium salt, phosphate) storage facilities
- Mixing tanks for reagent solutions (i.e., solutions of ammonium or urea and phosphorus salt solutions)
- Meters to measure rate of introduction of nutrient solutions into carrier streams
- Control system for metering systems

System Controls and Alarms

In many cases, remediation sites are remote and have minimal operation and maintenance staff. In these cases, equipment is fitted with control devices to shut down the system in the event of failure or unusual conditions (e.g., high water levels in injection wells because of plugging). When these systems shut down, alarms are triggered. These alarms can notify personnel on-site, or can be relayed to a remote station from which control personnel can be summoned.

Evaluation Of Operation And Monitoring Plans

Monitoring operations of the in-situ groundwater bioremediation system is necessary to ensure that equipment functions according to

specification, that nutrients and electron acceptors are being effectively supplied and distributed, and that contaminant removal is proceeding according to projections. A system operating and monitoring plan which covers both start-up and normal operations must be developed.

Start-up Operation

Initial start-up should entail hydraulic balancing of rates of extraction and injection of water. Depending on the system size and complexity, this hydraulic balancing can take 1 to 3 days. Once the extraction and injection flows are balanced and stabilized, addition of nutrients and the electron acceptor should be initiated. After about two or three days, the groundwater electron acceptor levels should be checked. In highly contaminated areas, the electron acceptor concentration will be depressed. Start-up adjustments are generally needed for the first 1 to 2 weeks of operation. Concentrations of the electron acceptor should be measured daily; water levels across the site should be measured every two to three days.

At the end of this start-up period, a set of samples (groundwater and soils) should be collected for detailed analysis for constituents of concern.

Normal Operation

The normal operation of the system should consist of weekly routine checking of (a) the operation and maintenance of equipment (e.g., pumps, blowers, mixers and controllers); (b) groundwater levels; (c) extraction and injection flow rates; (d) groundwater electron acceptor concentrations; (e) nutrient levels (ammonium, phosphate, nitrate); (f) pH; and (g) conductivity. System monitoring parameters can be measured using field test kits. Nutrient addition can be an intermittent operation and can be scheduled to coincide with routine operation checks. Exhibit X-14 provides a brief synopsis of system monitoring requirements.

Remedial Progress Monitoring

It is assumed that the objective of in-situ groundwater bioremediation processing is remediation of the saturated zone. To monitor remedial progress, samples of both groundwater and aquifer media (soil) should be collected on a routine basis and analyzed for parameters of concern. Groundwater samples should be collected and analyzed monthly to quarterly. Soil samples should be collected prior to site closure to demonstrate that cleanup objectives have been achieved.

Exhibit X-14
System Monitoring Recommendations

Phase	Monitoring Frequency	What To Monitor	Where To Monitor
Start-up (1-2 weeks)	At least daily	<input type="radio"/> Extraction volume <input type="radio"/> Injection volume <input type="radio"/> Electron acceptor concentration	<input type="radio"/> Extraction and injection well heads or manifolds <input type="radio"/> Monitoring wells
	Every 2-3 days	<input type="radio"/> Groundwater levels	<input type="radio"/> Monitoring wells
Remedial (ongoing)	Weekly	<input type="radio"/> Groundwater levels <input type="radio"/> Extraction and injection flow rates <input type="radio"/> Concentration of electron acceptor, ammonia, phosphate, nitrate, pH, and conductivity	<input type="radio"/> Monitoring wells <input type="radio"/> Extraction and injection wellheads or manifolds <input type="radio"/> Monitoring wells
	Monthly to quarterly	<input type="radio"/> Constituent concentrations in soil and groundwater	<input type="radio"/> Extraction, injection, and monitoring wells <input type="radio"/> Soil borings

In developing the monitoring plan, it will be necessary to identify potential monitoring points. Sampling points could be extraction, injection and monitoring wells. In sampling at the injection wells, the injection system should be shut down for approximately 24 hours to allow ambient conditions to be re-established. This delay will help ensure that the samples are representative of conditions in the aquifer without the effects of dilution.

Groundwater sampling and analysis can be scheduled about once every 1 to 3 months. Procedures for the collection of groundwater samples should be described in a sampling and analysis plan provided in the CAP. Analyses must be conducted according to prescribed or approved procedures as required by state regulations. In addition, water table maps can be useful in assessing whether injected water is flowing toward extraction wells as predicted. These maps should be prepared on a monthly to quarterly basis.

During remediation, contaminant levels decrease until they reach an asymptotic level. Once asymptotic conditions are reached for several successive sampling periods, continuing remediation activities generally

results in little further decrease of contaminant concentrations. However, frequently when active remediation is ceased, levels of dissolved contaminants abruptly increase. This increase is caused by the diffusion into solution of contaminants that were previously adsorbed onto the surfaces of individual grains that comprise the aquifer media. When asymptotic behavior begins, the operator should evaluate alternatives that will facilitate aquifer biodegradation. Alternatively, you may need to re-evaluate the rates and concentrations of nutrients and electron acceptors being injected, examine other remedial alternatives, or consider changing from active to passive (natural attenuation) remediation.

If asymptotic behavior is persistent for periods greater than about 6 months and the concentration rebound is sufficiently small following periods of pulsing (i.e., varying the extraction rate or turning the system off and on), the performance of the in-situ groundwater bioremediation system should be reviewed to determine whether remedial goals have been reached. If further contaminant reduction is necessary, another remedial technology may need to be considered.

References

- Brubaker, G.R. "In-situ Bioremediation of Groundwater." *in* D.E. Daniel, ed., *Geotechnical Practice for Waste Disposal*. London/New York: Chapman & Hall, 1993.
- Kinsella, J.V. and M.J.K. Nelson. "In-situ Bioremediation: Site Characterization, System Design and Full-Scale Field Remediation of Petroleum Hydrocarbon- and Trichloroethylene-Contaminated Groundwater." *in* P.E. Flathman and D.E. Jerger, eds., *Bioremediation Field Experience*. Boca Raton, FL: CRC Press, 1993.
- Norris, R.D. "In-situ Bioremediation of Soils and Groundwater Contaminated with Petroleum Hydrocarbons." *in* R.D. Norris, R.E. Hinchee, R.A. Brown, P.L. McCarty, L. Semprini, J.T. Wilson, D.H. Kampbell, M. Reinhard, E.J. Bower, R.C. Borden, *Handbook of Bioremediation*. Boca Raton, FL: CRC Press, 1994.
- Norris, R.D., R.E. Hinchee, R. Brown, P.L. McCarty, and L. Semprini. *In-situ Bioremediation of Groundwater and Geologic Material: A Review of Technologies*. Washington, DC: U.S. Environmental Protection Agency, EPA/600/R-93/124, (NTIS: PB93-215564/XAB), July 1993.
- Norris, R.D. and K.D. Dowd. "In-situ Bioremediation of Petroleum Hydrocarbon-Contaminated Soil and Groundwater in a Low-Permeability Aquifer." *in* P.E. Flathman and D.E. Jerger, eds., *Bioremediation Field Experience*. Boca Raton, FL: CRC Press, 1993.
- Sims, J.L., J.M. Suflita, and H.H. Russell. *In-situ Bioremediation of Contaminated Groundwater*. Washington, DC: U.S. Environmental Protection Agency, EPA/540/S-92/003, (NTIS: PB92-224336/XAB), February 1992.
- Staps, S.J.J.M. *International Evaluation of In-Situ Bioremediation of Contaminated Soil and Groundwater*. Washington, DC: U.S. Environmental Protection Agency, Office of Emergency and Remedial Response. EPA 540/2-90/012, 1990.
- Van der Heijde, P.K.M., and O.A. Elnawawy. *Compilation of Groundwater Models*. Washington, DC: U.S. Environmental Protection Agency, Office of Research and Development, EPA/600/R-93/118, (NTIS: PB93-209401), May 1993.

Checklist: Can In-Situ Groundwater Bioremediation Be Used At This Site?

This checklist can help you evaluate the completeness of the CAP and identify areas that require closer scrutiny. As you go through the CAP, answer the following questions. If the answer to several questions is no, you should request additional information to determine if in-situ groundwater bioremediation will accomplish cleanup goals at the site.

1. Site Characteristics

Yes No

- Is the aquifer hydraulic conductivity greater than 10^{-4} cm/sec?
- Have impermeable layers or other conditions that would disrupt groundwater flow been considered in the design of the remediation system?
- Has the groundwater mineral content been quantified and taken into consideration?
- Are dissolved iron concentrations < 10 mg/l?
- Is the groundwater pH between 6 and 8?
- Is the groundwater temperature between 10°C and 45°C ?
- Is the total heterotrophic bacteria count $> 1,000$ CFU/gram in dry soil?
- Is the carbon:nitrogen:phosphorus ratio between 100:10:1 and 100:1:0.5?

2. Constituent Characteristics

Yes No

- Have all constituents of concern been identified?
- Are constituents all sufficiently biodegradable?
- Is the concentration of total petroleum hydrocarbon $\leq 50,000$ ppm and heavy metals $\leq 2,500$ ppm?
- Are organic solvent concentrations $\leq 7,000$ ppm?

- Are desired constituent concentrations > 0.1 ppm and is the desired hydrocarbon reduction < 95%?
- Are the constituents present soluble in groundwater?

3. Evaluation Of The In-situ Groundwater Bioremediation System Design

Yes No

- Has treatability testing been performed?
- Has groundwater modelling been used to calculate aquifer conditions over time?
- If not, has some other method been used to calculate cleanup times?
- Will the processing rates achieve cleanup in the time allotted for remediation in the CAP?
- Have remediation rates been established for the project?
- Has the area of influence for the proposed extraction or injection wells been determined?
- Is the proposed well placement appropriate, given the total area to be cleaned up and the area of influence of each injection/extraction well system?
- Has the amount of the contaminant to be remediated been determined?
- Has the quantity and type of electron acceptors required for the remediation been determined?
- If an electron acceptor system will be needed, is a design for that system provided?
- Will aboveground treatment of groundwater be required?
- Has the quantity of nutrients required for remediation been determined?
- If nutrient delivery systems will be needed, are designs for those systems provided?
- Is bioaugmentation addressed, if needed, in the design?

- Have groundwater extraction rates been determined?
- Is a system control/alarm system included in the design?
- Is a free product recovery system needed?

4. Operating and Monitoring Plans

Yes No

- Is hydraulic balancing proposed as the first activity in start-up?
- Is routine system operation and monitoring proposed?
- Is subsurface soil and groundwater sampling proposed for tracking constituent reduction and biodegradation conditions?
- Is a schedule for tracking constituent reduction proposed?
- Is nutrient addition (if necessary) proposed to be controlled on a periodic rather than continuous basis?