

Final Report

EXPLORATION OF PERINATAL PHARMACOKINETIC ISSUES

**Contract No. 68-C-99-238
Task Order No. 13**

Prepared for:

**Risk Assessment Forum
Office of Research and Development
U.S. Environmental Protection Agency
Washington, D.C. 20460**

Prepared by:

**Versar, Inc.
6850 Versar Center
Springfield, VA 22151**

May 10, 2001

NOTICE

Although the development of this report has been funded by the U.S. Environmental Protection Agency (EPA) under Contract Number 68-C-99-238 to the National Center for Environmental Assessment, it does not necessarily reflect the views or policies of the EPA, and no official endorsement should be inferred. Mention of trade names or commercial products does not constitute endorsement or recommendation for use.

TABLE OF CONTENTS

LIST OF TABLES	ix
LIST OF FIGURES	x
AUTHORS	xi
EXPLORATION OF PERINATAL PHARMACOKINETIC ISSUES	xii
INTRODUCTION AND PURPOSE	xii
TECHNICAL TASK CHARGE	xiii
SPECIFIC ISSUE AREAS	xiv
1.0 ISSUE AREA 1: RELATIVE BIOTRANSFORMATION CAPACITIES IN INFANTS, CHILDREN, AND THE UNBORN	1-1
1.1 INTRODUCTION	1-1
1.1.1 Role of Maternal (Placental) Metabolism in the Exposure of Fetus to Xenobiotics	1-1
1.1.2 Evaluation of Biotransformation in Children	1-1
1.1.3 Why Should the Fetus Have Biotransformation Capacity?	1-2
1.2 METHODOLOGICAL ASPECTS OF RESEARCH	1-2
1.2.1 Procuring Representative Tissue Material	1-2
1.2.2 Detecting XME Expression	1-2
1.2.3 Identification of Gestational Ages	1-2
1.2.4 Sensitivity Issues	1-3
1.3 DETERMINATION OF RELATIVE ACTIVITIES AND MATURATION OF XMEs	1-3
1.3.1 Cytochrome P450 (CYP) Enzymes: CYP Genes and Enzymes in Adult Liver (Levels, Regulation, etc.)	1-3
1.3.2 Cytochrome P450 (CYP) Enzymes: CYP1 Subfamily	1-4
1.3.2.1 <i>CYP1A1</i>	1-4
1.3.2.2 <i>CYP1A2</i>	1-4
1.3.2.3 <i>CYP1B1</i>	1-5
1.3.3 Cytochrome P450 (CYP) Enzymes: CYP2 Subfamily	1-5
1.3.3.1 <i>CYP2A6</i>	1-5
1.3.3.2 <i>CYP2B6</i>	1-5
1.3.3.3 <i>CYP2C</i>	1-6
1.3.3.4 <i>CYP2D6</i>	1-6
1.3.3.5 <i>CYP2E1</i>	1-7
1.3.4 Cytochrome P450 (CYP) Enzymes: CYP3 subfamily	1-7
1.3.4.1 <i>CYP3A7</i>	1-7
1.3.4.2 <i>CYP3A5</i>	1-8
1.3.4.3 <i>CYP3A4</i>	1-8
1.3.5 Developmental (Perinatal) Transition of CYP3A Subfamily Expression	1-9
1.4 REGULATION OF DEVELOPMENTAL P450 EXPRESSION	1-9
1.4.1 Transcriptional Regulation	1-9
1.4.2 Induction by Exogenous Chemicals	1-9
1.4.3 Use of Fetal Hepatocytes	1-9
1.5 OTHER PHASE I ENZYME SYSTEMS	1-9
1.5.1 Epoxide Hydrolase (EH)	1-9
1.5.2 Flavin-containing Monooxygenase (FMO)	1-10
1.5.3 Alcohol Dehydrogenase (ALD)	1-10
1.5.4 Reductases	1-10

TABLE OF CONTENTS (continued)

	1.5.5 Hydrolases/Esterases	1-10
1.6	PHASE II ENZYME SYSTEMS	1-10
	1.6.1 UDP-glucuronosyl Transferases (UGT)	1-11
	1.6.2 Glutathione S-transferases (GST)	1-11
	1.6.3 Sulfotransferases (SULT)	1-11
	1.6.4 N-acetyltransferases (NAT)	1-11
	1.6.5 Amino Acid (Glycine) Conjugation	1-12
	1.6.6 Thiopurine S-methyltransferase (TPMT)	1-12
1.7	EXTRAHEPATIC BIOTRANSFORMATIONS	1-12
1.8	SPECIES DIFFERENCES	1-13
1.9	ENZYME POLYMORPHISMS	1-13
1.10	LIVER STRUCTURE, METABOLIC ZONATION, AND METABOLISM	1-14
1.11	SEX DIFFERENCES	1-14
1.12	THE SIGNIFICANCE OF FETAL XENOBIOTIC METABOLISM	1-14
	1.12.1 Metabolic Activation (Transplacental Mutagenesis, Carcinogenesis, and Teratogenesis)	1-14
	1.12.2 Expression and Toxicological Significance of CYP1A1	1-15
	1.12.3 Metabolism of Endogenous Compounds	1-15
1.13	CONCLUSIONS	1-16
	1.13.1 General Findings	1-16
	1.13.2 Specific Findings in Different Age Groups	1-17
1.14	REFERENCES	1-20
2.0	ISSUE AREA 2: RELATIVE TISSUE DISTRIBUTION AND EXCRETION CAPACITIES IN INFANTS, CHILDREN, AND THE UNBORN	2-1
2.1	INTRODUCTION	2-1
	2.1.1 Quantitative Description of Physiological Changes	2-1
	2.1.2 Published PK Models	2-1
	2.1.3 Modeling Lead Exposures in Growing Children	2-2
	2.1.3.1 <i>Descriptive PK Model</i>	2-2
	2.1.3.2 <i>Predictive PK Model</i>	2-2
2.2	PB/PK MODELING OF DIFFERENT STAGES IN HUMAN DEVELOPMENT	2-3
	2.2.1 Pregnancy Models	2-3
	2.2.1.1 <i>Changes in Maternal Pharmacokinetics During Pregnancy</i>	2-4
	2.2.1.2 <i>Transplacental Transfer</i>	2-4
	2.2.1.3 <i>Fetal Pharmacokinetics</i>	2-5
	2.2.2 Neonatal Models	2-5
	2.2.2.1 <i>Lactational Transfer</i>	2-5
	2.2.2.2 <i>Neonatal Pharmacokinetics</i>	2-6
	2.2.2.3 <i>Metabolic Clearance</i>	2-6
	2.2.3 Infant Models	2-7
	2.2.3.1 <i>Exposure Routes</i>	2-8
	2.2.3.2 <i>Clearance</i>	2-8
	2.2.3.3 <i>Tissue Distribution and Partitioning of Chemical Compounds</i>	2-9
	2.2.4 Sources of Nonlinearities and Discontinuities in PB/PK Models for Children	2-9
	2.2.4.1 <i>Nonallometric Body Weight Changes</i>	2-10
	2.2.4.2 <i>Metabolic Clearance Changes</i>	2-10
	2.2.4.3 <i>Adolescent Physiology and Exposure Activity Patterns</i>	2-10

TABLE OF CONTENTS (continued)

2.3	CONCLUSIONS	2-11
	2.3.1 General Findings	2-11
	2.3.2 Specific Findings in Different Age Groups	2-12
	2.3.2.1 <i>Fetus</i>	2-12
	2.3.2.2 <i>Neonates</i>	2-12
	2.3.2.3 <i>Children</i>	2-12
2.4	REFERENCES	2-13
APPENDIX (AREA 2): PHARMACOKINETICS AND COMPUTER-AIDED QUANTITATIVE		
	MODELING IN DEVELOPMENTAL TOXICOLOGY	2-20
A.1	INTRODUCTION	2-20
	A.1.1 Definition of Terms	2-20
	A.1.2 Factors Leading to Nonlinearities in PK	2-20
	A.1.2.1 <i>Absorption</i>	2-20
	A.1.2.2 <i>Distribution</i>	2-21
	A.1.2.3 <i>Metabolism</i>	2-21
	A.1.2.4 <i>Excretion</i>	2-22
	A.1.2.5 <i>Protein Binding</i>	2-22
	A.1.2.6 <i>Additional Factors</i>	2-23
	A.1.3 Collection of Pharmacokinetic Data in Developmental Toxicology	2-24
	A.1.4 Application of PK Modeling of a Potential Developmental Toxicant in Infant-based Risk Assessment	2-24
	A.1.5 Types of Pharmacokinetic Models Applicable to Developmental Toxicology	2-25
	A.1.5.1 <i>Descriptive PK/TD Models</i>	2-25
	A.1.5.2 <i>Predictive PK/TD Models</i>	2-27
A.2	PB/PK MODELING OF CHEMICAL DISTRIBUTION IN TISSUES	2-28
	A.2.1 When Is It Feasible to Develop a PB/PK Model?	2-28
	A.2.2 PB/PK Modeling of Transplacental Transfer	2-28
	A.2.3 PB/PK Modeling of Fetal Growth	2-28
	A.2.4 PB/PK Modeling of Neonatal Growth	2-29
	A.2.5 Milk Volume Changes – Proposed Allometry	2-29
	A.2.6 PB/PK Modeling of Tissue Distribution of Chemicals in Children	2-30
A.3	REFERENCES	2-34
3.0 ISSUE AREA 3: PARAMETERS DETERMINING TRANSPLACENTAL TRANSFER		
	3.1 INTRODUCTION	3-1
	3.2. TOXICOKINETIC ISSUES AND CROSS-SPECIES COMPARISONS	3-1
	3.3 TOXICOKINETIC ISSUES: MOTHER, PLACENTA, AND EMBRYO/FETUS	3-4
	3.3.1 Toxicokinetic Issues	3-4
	3.3.2 Maternal-Fetal Placental Transport and Maternal-Embryonic Placental Transport	3-4
	3.3.2.1 <i>Maternal Considerations</i>	3-4
	3.3.2.2 <i>Placental Transfer</i>	3-6
	3.3.2.3 <i>Cellular Storage or Binding of Molecules</i>	3-8
	3.3.2.4 <i>Specific Transport Processes</i>	3-9
	3.3.3 Fetal Distribution	3-10

TABLE OF CONTENTS (continued)

3.4	PLACENTAL RESEARCH TECHNIQUES: <i>IN UTERO/IN VITRO</i>	3-11
3.4.1	<i>In Utero</i> Techniques	3-11
3.4.1.1	<i>Animal Studies</i>	3-11
3.4.1.2	<i>Human Studies</i>	3-12
3.4.2	<i>In Vitro</i> Techniques	3-12
3.4.2.1	<i>Isolated Trophoblast Cells</i>	3-12
3.4.2.2	<i>Ussing Chamber</i>	3-13
3.4.2.3	<i>Placental Explants/Slices</i>	3-13
3.4.2.4	<i>Placental Perfusion/Lobule Perfusion</i>	3-14
3.5	EFFECTS OF TOXIC AGENTS ON THE PLACENTA	3-14
3.5.1	Metals	3-14
3.5.1.1	<i>Arsenic</i>	3-14
3.5.1.2	<i>Cadmium</i>	3-17
3.5.1.3	<i>Lead</i>	3-22
3.5.1.4	<i>Mercury</i>	3-25
3.5.1.5	<i>Selenium</i>	3-29
3.5.2	Environmental Agents	3-31
3.5.2.1	<i>Diethylstilbestrol (DES)</i>	3-31
3.5.2.2	<i>Organochlorine Pesticides</i>	3-32
3.5.2.3	<i>Organophosphorous Insecticides</i>	3-33
3.5.2.4	<i>Viruses, HIV, and CMV Infection</i>	3-34
3.6	PLACENTAL MULTIDRUG TRANSPORTERS, DYSFUNCTION, AND EVALUATION	3-36
3.7	CONCLUSIONS	3-37
3.8	BIBLIOGRAPHY	3-40
4.0	ISSUE AREA 4: TRANSFER FROM PLASMA TO MILK	4-1
4.1	INTRODUCTION	4-1
4.2	CHEMICALS TRANSFERRED TO BREAST MILK	4-1
4.3	LACTATIONAL TRANSFER PATHWAY	4-2
4.3.1	Milk Synthesis and Release	4-2
4.3.2	Mechanisms of Lactational Transfer of Chemicals	4-4
4.3.3	Physicochemical Factors Affecting Lactational Transfer of Chemicals	4-5
4.3.3.1	<i>Lipid:Water or Octanol:Water Partition Coefficients</i>	4-5
4.3.3.2	<i>Molecular Weight of Chemical Compounds</i>	4-6
4.3.3.3	<i>Degree of Ionization</i>	4-6
4.3.3.4	<i>Maternal Plasma Protein Binding</i>	4-7
4.3.4	Classification of Typical Breast Milk Contaminants According to Their Solubility	4-7
4.4	MATERNAL PHARMACOKINETIC PARAMETERS	4-9
4.4.1	Body Weight	4-9
4.4.2	Water Consumption Rate	4-10
4.4.3	Milk Yield	4-10
4.5	LACTATIONAL FACTORS	4-10
4.5.1	Milk-to-Plasma Ratio	4-12
4.5.2	Milk Fat to Body Fat Ratio	4-12

TABLE OF CONTENTS (continued)

4.6	INFANT PHARMACOKINETIC FACTORS AND PATTERNS	4-13
4.6.1	Milk Ingestion Rate	4-13
4.6.2	Other Physiological and Pharmacokinetic Factors	4-14
4.7	QUANTITATIVE MODELING OF LACTATIONAL TRANSFER OF CHEMICALS	4-14
4.7.1	Steady-State Modeling Employing Milk Biotransfer Factor	4-15
4.7.1.1	<i>Derivation of Milk Biotransfer Factor</i>	4-15
4.7.1.2	<i>Milk Transfer Coefficient</i>	4-16
4.7.1.3	<i>Quantitative Structure-Activity Relationship Model</i>	4-16
4.7.2	Steady-State Modeling Employing Milk-to-Plasma Ratio	4-17
4.7.2.1	<i>Exposure Index</i>	4-19
4.7.2.2	<i>Pitfalls of the M/P Modeling Approach</i>	4-19
4.7.3	Compartmental Pharmacokinetic Models	4-19
4.7.3.1	<i>Hoover's Model for TCDD</i>	4-20
4.7.3.2	<i>Models of Smith and Sullivan</i>	4-21
4.7.4	Physiologically Based Pharmacokinetic Models	4-22
4.7.4.1	<i>PB/PK Modeling of Lactational Transfer of Volatile Chlorinated Hydrocarbons</i>	4-22
4.7.4.2	<i>Calibration of PB/PK Models for Lactational Transfer with Experimental Data from Laboratory Animals</i>	4-23
4.7.4.3	<i>PB/PK Modeling of Lactational Transfer of Mercury</i>	4-24
4.7.4.4	<i>Problems Encountered in PB/PK Modeling of Lactational Transfer</i>	4-25
4.8	CONCLUSION	4-25
4.9	REFERENCES	4-27
5.0	ISSUE AREA 5: FUNCTION OF THE BLOOD-BRAIN BARRIER IN INFANTS, CHILDREN, AND THE UNBORN	5-1
5.1	INTRODUCTION	5-1
5.1.1	Definition of the Term "Blood-Brain Barrier"	5-1
5.1.2	Barriers in the Developing Brain	5-1
5.1.3	Species Differences: The Need for Caution	5-3
5.2	LITERATURE REVIEW	5-4
5.2.1	Supposed Immaturity of Barriers in the Developing Brain	5-4
5.2.2	Vulnerability of the Developing Brain	5-5
5.3	NEUROTOXICOLOGY IN THE FETUS AND NEWBORN	5-6
5.3.1	Acrylamide	5-7
5.3.2	Organochlorines	5-7
5.3.3	Pipelicolic Acid	5-7
5.3.4	[¹⁴ C]-2,4-Dichlorophenoxyacetic Acid	5-7
5.3.5	L-Carnitine	5-8
5.3.6	Heavy Metals	5-9
5.3.6.1	<i>Lead</i>	5-9
5.3.6.2	<i>Mercury</i>	5-9
5.3.7	Steroids and the Developing Brain	5-10
5.3.8	Opiates	5-11
5.3.9	Theophylline and Related Xanthines	5-12

TABLE OF CONTENTS (continued)

5.4	CONCLUSIONS	5-13
5.5	REFERENCES	5-15
	CONCLUSIONS	C-1

LIST OF TABLES

Table 1-1.	Postulated Developmental Expression of Individual P450 Forms in the Human Liver . . .	1-25
Table 1-2.	Developmental Patterns of Some Drug-metabolizing Enzymes	1-26
Table 1-3.	Metabolism of Xenobiotics by CYP3A7	1-27
Table 1-4.	Glucuronidation of Several Substances in Human Fetal Liver <i>In Vitro</i>	1-27
Table 1-5.	Sulfotransferase Activity Toward Several Substrates in Human Fetal Liver	1-28
Table 1-6.	Human Teratogens That Are Also Substrates for CYP Enzymes	1-28
Table A2-1.	PB/PK Model Simulation Parameters for Mother and Infant	2-39
Table A2-2.	PB/PK Model Simulation Parameters for Child (defaults for 1 year and older)	2-40
Table A2-3.	Water and Lipid Composition of Human Tissues (defaults for child 1 year and older) . . .	2-40
Table 3-1.	Concentrations of Endogenous Proteins and Other Molecules Produced by Mother, Placenta Yolk Sac, or Embryo, or Available from Mother in Embryonic Fluids and Maternal Serum	3-72
Table 3-2.	Mean Concentration of Selected Drugs and Environmental Agents in Maternal Serum and Embryonic Fluids	3-74
Table 3-3.	Xenobiotic and Hormone-Metabolizing Enzymes and Isoenzymes in the Human Placenta	3-75
Table 3-4.	Placental Transporters Involved in the Transfer of Nutrients and Xenobiotics	3-76
Table 3-5.	Criteria for Dual Perfusion of the Human Placenta	3-77
Table 3-6.	Maternal Blood, Placenta, and Cord Blood Concentrations of Cadmium from Different Regions of the World and Under Selected Urban, Industrial, and Environmental Conditions	3-78
Table 3-7.	Maternal Blood and Cord Blood Concentrations of Lead from Different Regions of the World and Under Selected Urban, Industrial and Environmental Conditions	3-82
Table 3-8.	Maternal Blood, Placenta and Cord Blood Concentrations of Mercury from Different Regions of the World and Under Selected Urban, Industrial and Environmental Conditions	3-84
Table 3-9.	Maternal Blood, Cord Blood and Placental Selenium Concentrations	3-87
Table 3-10.	Role of P-glycoproteins (Multidrug transporters) in the Transfer of Molecules from Mother to Fetus	3-87
Table 3-11.	Biomarkers of Exposure and Effect in the Human Placenta	3-88
Table 3-12.	Xenobiotics Observed to Alter Placental and Yolk Sac Function	3-89
Table 4-1.	Infant Conditions for Which Risk Is Reduced by Breast-Feeding	4-34
Table 4-2.	Some Occupationally Derived Toxic Chemicals That May Present Hazards to Nursing Infants of the Exposed Mothers	4-35
Table 4-3.	Ranges of Water Solubility and Octanol/Water Partition Coefficients for Typical Chemical Contaminants of Breast Milk	4-43
Table 4-4.	Major PCB Congeners in Human Milk from Upstate New York and Their Milk : Blood Concentration Ratios	4-44
Table 4-5.	Exogenous Factors Affecting Milk Yield in Humans	4-45
Table 4-6.	Milk Transfer Coefficients (F _m , expressed in day/kg) Estimated for Some Ubiquitous Radionuclides	4-46

LIST OF FIGURES

Figure 2-1. A diagram of the conceptual framework for the physiologically based pharmacokinetic (PB/PK) model of gestational/lactational transfer of a potential developmental toxicant from the exposed mother to her nursing infant	2-19
Figure A2-1. Proposed decision tree for pharmacokinetic (PK) modeling of a potential developmental toxicant, aimed at the infant-based risk assessment	2-41
Figure A2-2. Proposed paradigm for experimental construction of physiologically based pharmacokinetic (PB/PK) model of a potential developmental toxicant	2-42
Figure 3-1a. Species Comparisons	3-99
Figure 3-1b. Cross-section of placentae from different species	3-100
Figure 3-2. Comparative perinatal development in the human, rat and opossum	3-101
Figure 3-3. Doppler Ultrasound of Early Pregnancy	3-102
Figure 3-4. Anatomical barriers/membrane compartments inside the first trimester gestational sac	3-103
Figure 3-5. Concentration profiles for red blood cells: (!), sucrose (), water ("), antipyrine (–) and propranolol (◇) in the dual perfused human placental lobule	3-104
Figure 3-6. Bidirectional movement across the placenta	3-105
Figure 3-7. Diagram of the trophoblast proliferation and differentiation to extravillous trophoblast representing the fundamental processes in implantation	3-106
Figure 3-8. Toxicokinetics of cadmium chloride administered to the near-term pregnant rat	3-107
Figure 3-9. Sequence of observed responses in the near-term pregnant rat following a single subcutaneous administration of 40 µmoles/kg of cadmium chloride	3-108
Figure 3-10. Cadmium concentrations in maternal, placental and fetal compartments during 6 hours of dual human placental perfusion	3-109
Figure 3-11. MT mRNA and protein expression	3-110
Figure 3-12. The life cycle of HIV-1 and possible sites for anti-HIV action of agents.	3-111
Figure 4-1. A scheme of a lactational transfer of a chemical from maternal blood (redrawn with permission from Wilson et al., 1980)	4-48
Figure 4-2. Essential factors and pharmacokinetic variables affecting pharmacological/toxic response in an infant to drugs or other chemicals transferred to breast milk	4-49
Figure 4-3. A relationship between the daily milk yield and body weight for different species (data from Peaker 1976)	4-50
Figure 4-4. A steady-state model of quantitative relations in the multimedia chemical exposure pathways to human child with lactational transfer emphasized	4-51
Figure 4-5. A relationship between biotransfer factors (Bm) and octanol/water partition coefficients (Kow) for organic chemicals in human breast milk fat and cow milk fat (data from Travis et al. 1988).	4-52
Figure 4-6. Schematic diagram of the linear, two compartment open classical pharmacokinetic model applicable to lactational transfer of lipophilic drugs and other chemicals	4-53
Figure 4-7. Schematic diagram of the linear, one-compartment open pharmacokinetic system described mathematically by Hoover et al. (1991)	4-54
Figure 4-8. Schematic diagram of the PB/PK model of lactational transfer of drugs and other chemicals developed by Byczkowski and Fisher (1994) for tetrachloroethylene	4-55
Figure 4-9. Combined results of MeHgLac PB/PK model simulations of total Hg concentrations	4-56

AUTHORS

Janusz Z. Byczkowski, Ph.D., DABT
Consultant
Ohio Environmental Protection Agency

Sam Kacew, Ph.D.
University of Ottawa, Canada

Richard K. Miller, Ph.D.
University of Rochester, New York

Olavi Pelkonen, M.D., Ph.D.
University of Oulu, Finland

Norman Saunders, Ph.D.
University of Tasmania, Australia

EXPLORATION OF PERINATAL PHARMACOKINETIC ISSUES

INTRODUCTION AND PURPOSE

Young children and the developing fetus may be more susceptible to the effects of exposure to some environmental chemicals than adults, as a result of different exposure patterns and developmental immaturities. For the adult, fully developed organism, intake of chemicals from the environment occurs via three main routes of exposure: oral ingestion, inhalation, and absorption through the skin. In the developing fetus, the exclusive route of exposure is transplacental transfer from the mother's blood. On the other hand, in the nursing infant, in addition to inhalation and absorption through the skin, lactational transfer of chemicals with the breast milk plays a crucial role. In adults, body weight, relative volume of internal organs, and metabolic clearances remain relatively stable for most of the adult life, whereas in the developing fetus and young children these physiological parameters undergo dramatic changes that affect absorption, distribution, metabolism, and excretion of chemicals (ADME). These changes, accompanied by dynamic developmental reorganization in morphology and physiology of tissues, result in nonlinearities and discontinuities of the kinetics of ADME. Thus, the concentration of chemicals in blood and at the target tissue (internal dose and biologically effective dose) in fetuses and young children cannot be adequately described by linear pharmacokinetics because the steady state cannot be achieved. This characteristic of developing organisms may be of concern to risk assessors for at least two reasons. First, chemical concentrations attained at fetal and neonatal target organs may achieve much higher levels than expected. Second, the target organs in question may be unusually vulnerable as a result of ongoing developmental changes. Therefore, to evaluate the special susceptibility of infants, children, and the unborn to environmental chemicals, and to understand their overall pharmacokinetics, it is necessary first to understand and account for phenomena specific to pregnancy, parturition, lactation, and development.

The Environmental Protection Agency (EPA) tasked Versar, Inc., to convene a team of five expert scientists to assist the Agency in exploring how it might improve risk assessment and toxicity-testing paradigms currently in use, and ways to improve the evaluation of pharmacokinetic data in immature animals at various stages of development. A task was defined whose purpose was to develop a White Paper that would review the current state of pharmacokinetic knowledge in the animal and human perinatal population, defined as the unborn, infants, and young children. Each technical expert addressed one of five different issue areas or aspects of the scope of work. This report was developed with an eye toward (1) identifying information that would inform the development of future test guidelines and/or guidance documents related to this topic, and (2) identifying information or approaches that would assist EPA in improving existing noncancer risk assessment methodologies.

EPA's Risk Assessment Forum is a standing committee of senior EPA scientists who study and report on issues from an Agency-wide scientific perspective. The Forum was established to promote Agency-wide consensus on difficult and controversial risk assessment issues and to ensure that this

consensus is incorporated into appropriate Agency risk assessment guidance. Forum consensus-building activities may include developing science policy to address technical issues, definitive risk assessment guidance, and risk assessment methodology for use in ongoing and prospective Agency actions, as well as conducting scientific and technical analysis upon which to base risk assessment positions. The Risk Assessment Forum outlined the Scope of Work for this task as follows:

In the process of reviewing toxicology testing paradigms currently in use within the Agency for hazard characterization, the Forum's Reference Dose (RfD) Technical Panel has identified several areas for which adequate approaches for risk assessment may not be available. One of these areas is the evaluation of pharmacokinetic data in immature animals, at various stages of development.

At present guidance for designing animal toxicology studies that address potential metabolic and enzymatic differences between adults, fetuses, infants, and young in both experimental animals and humans is not available. The most recently issued metabolism testing guideline, which is used to support the regulation of pesticides and toxic substances (OPPTS 870.7485, August 1998), is designed to evaluate single chemicals, primarily in the young adult rat. It contains no guidance for obtaining data to evaluate central issues pertaining to hazard characterization in immature animals, such as the following:

1. The extent and nature of exposure of the fetus by transplacental transfer of chemicals.
2. Exposure of the young to the chemical through excretion in maternal milk.
3. Changes in permeability of the blood:brain barrier and distribution to the brain, and the resultant differences in potential for toxicity to the central nervous system in adults, fetuses, infants and young.
4. Changes in distribution and excretion and the resultant differences in chemical sensitivities between adults, fetuses, infants, and young.
5. Ontogeny and development of biotransformation capacities and the resultant differences in chemical sensitivities between adults, fetuses, infants and young.

At the present time, Agency scientists often can only evaluate these issues by inference, or by recourse to analogies with other chemicals. Furthermore, the OPPTS metabolism guideline, in its present form, lacks guidance for the selection of parameters (e.g., dose selection, route of administration, timing of exposure) which would be useful in the design of studies that are intended to provide an adequate assessment of toxicity in the perinatal animal.

TECHNICAL TASK CHARGE

A team of four technical experts with specialized expertise related to aspects of perinatal pharmacokinetics was recruited to address the five issue areas. The team members are identified below.

The four members are recognized experts and have contributed significantly to the literature in their fields. A project Lead was also named, whose function was to coordinate development of the integrated final report. Each issue area author was screened for potential conflicts of interest, and each attested, to the best of his or her knowledge and belief, that they had no personal conflicts of interest with regard to the work assignment.

The task was organized into the following parts:

- C Literature Search: In conjunction with the issue area authors, an initial search of the published literature and other appropriate sources was carried out in five issue areas (described below). The literature searches relied on the National Library of Medicine's PUBMED, DIALOG, and other Internet search techniques. Results of the five literature searches were provided to the issue area authors, as well as to EPA as a deliverable. EPA reviewed these results in consultation with the Forum's RfD Technical Panel, and in some cases, proposed that Versar consider additional sources of information known to the Agency. Versar revised the literature searches, which identified between 1,500 and 2,000 items of potential interest, and secured hard copies of specific references requested by the issue area authors.
- C Literature Summary: The issue area authors reviewed both their own literature collections in their assigned areas, and any documents provided by Versar. Each author produced an outline and annotated a list of key references that were felt to be particularly pertinent for the development of the overall White Paper. These annotated lists were also submitted to EPA for review. EPA reviewed these results in consultation with the Forum's RfD Technical Panel, and once again, in some cases, proposed consideration of additional sources of information known to the Agency.
- C Draft and Final Issue Papers: The primary objective of the task was to develop a single White Paper that covers five different aspects of perinatal pharmacokinetics issues.

SPECIFIC ISSUE AREAS

This paper presents crucial contemporary issues pertinent to the absorption, distribution, metabolism, and excretion of environmental chemicals in pregnancy and infant development, based on the review of relevant literature. (An appendix to Issue Area 2 contains quantitative relationships useful in pharmacokinetic models that account for nonlinear physiological changes during fetal development, lactation, and maturation. Possible numerical values are suggested, obtained from currently available literature, for critical parameters necessary for construction of physiologically based pharmacokinetic models of developmental toxicants.) The information is organized into five chapters addressing the five issue areas.

- C **Issue Area 1: Relative biotransformation capacities in infants, children, and the unborn.** In this issue area, EPA asked for information on the relative activities and maturation of Cytochrome P450, flavin monooxygenases, glucuronidation, sulfation, glutathione conjugation, and other Phase I and II activities. Qualitative and quantitative comparison to the metabolic capabilities of adults was also sought, together with information on the toxicological consequences of these differences. (Author: Dr. Olavi Pelkonen, University of Oulu, Finland)
- C **Issue Area 2: Relative tissue distribution and excretion capacities in infants, children, and the unborn.** In this issue area, EPA was particularly interested in information related to differences in enzymatic and pharmacodynamic processes or in developmental anatomy. EPA asked for guidance on how the possible consequences of these differences might be conducted by means of specific, physiologically based pharmacokinetic (PB/PK) models that are clearly applicable to pregnancy and pre- and postnatal development. (Author: Dr. Janusz Byczkowski, Consultant, Fairborn, Ohio)
- C **Issue Area 3: Parameters determining transplacental transfer.** In this issue area, EPA sought information on the extent of transfer of parent compound and metabolites across the placenta, in both the maternal-fetal and fetal-maternal directions. Information on metabolic activation or deactivation during passage through the placenta was also sought, together with information on structural features associated with transferable metabolites. (Author: Dr. Richard K. Miller, University of Rochester, New York)
- C **Issue Area 4: Transfer from plasma to milk.** In this issue area, EPA asked for information on plasma-to-milk ratios, and structure activity relationships (SAR) that may determine the efficiency of excretion in milk. EPA also sought information on the excretion in milk of such chemicals as drugs and pesticides. Procedures for predicting or estimating infant exposure from maternal blood levels or other data was also solicited. (Author: Dr. Janusz Byczkowski, Consultant, Fairborn, Ohio)
- C **Issue Area 5: Function of the blood-brain barrier in infants, children, and the unborn.** In this issue area, EPA sought information concerning potential alterations in permeability of the blood-brain barrier, distribution to the brain, and the resultant differences in potential for toxicity to the central nervous system. Also, EPA sought information on the influence of developmental anatomy on, and the ontogeny of, the blood-brain barrier. (Author: Dr. Norman Saunders, University of Tasmania, Australia)

The next five sections of this report address each of these five issue areas. Each section presents a summary of current issues, research methods, state of the science, and modeling information pertinent to the Task. Overall conclusions follow, summarizing the main findings of this literature research effort.

1.0 ISSUE AREA 1: RELATIVE BIOTRANSFORMATION CAPACITIES IN INFANTS, CHILDREN, AND THE UNBORN

1.1 INTRODUCTION

The most pertinent review articles published on this subject are Klinger (1996), Hakkola et al. (1998), Juchau et al. (1998), Ring et al. (1999), and Gow et al. (2001). Earlier comprehensive surveys of most xenobiotic metabolizing enzymes (XMEs) can be found in Juchau et al. (1980) and Pelkonen et al. (1980). This section reviews the following:

- Methodological aspects of research
- Determination of relative activities and maturation of XMEs
- Other phase I enzyme families
- Phase II enzyme systems
- Extra-hepatic biotransformation
- Species differences
- Enzyme polymorphisms
- Liver structure, zonation, and metabolism
- Sex differences

1.1.1 Role of Maternal (Placental) Metabolism in the Exposure of Fetus to Xenobiotics

On the basis of the time-dependence of pharmacokinetic processes in the mother, it is clear that maternal biotransformation and excretion processes play a large, maybe determining role in the exposure of the fetus to foreign chemicals. Also, placental biotransformation may become, at least in certain cases, a limiting factor in fetal exposure (see Issue Area 3).

1.1.2 Evaluation of Biotransformation in Children

There are very few direct studies that measure enzyme activities or expression at the mRNA or protein level in either hepatic or extrahepatic tissues, and it is questionable whether really representative material has been obtained. On the other hand, there are a large number of *in vivo* studies, some more controlled than others (e.g., caffeine studies by Olive's and Leroux's group), and most of them are pharmacokinetic analyzes (i.e., based on therapeutic monitoring and inferring biotransformation aspects of studied drugs on the basis of their known modes of clearance). There is no comprehensive and careful assessment of biotransformation development in toddlers, children, and teenagers, as compared to adults.

1.1.3 Why Should the Fetus Have Biotransformation Capacity?

From the pharmacokinetic point of view, fetal biotransformation capacity is of lesser importance because excretion of products into urine and bile (even less to exhalation) does not have the same meaning as in postnatal life. One could even argue that fetal metabolism is counterproductive, because metabolites, being relatively water soluble and thus presumably less suitable for placental backtransfer to the mother, would be trapped on the fetal side and potentially cause problems. Also, metabolic activation reactions could potentially be harmful to the developing organism. However, as is well known, some enzymes have important functions as hormonal or biological response modifiers of metabolism, which might make them indispensable during early development.

1.2 METHODOLOGICAL ASPECTS OF RESEARCH

1.2.1 Procuring Representative Tissue Material

The most problematic matter is the “opportunistic” design of *in vitro* studies, because human biological material is difficult to obtain and often the quality is in question. Rigorous studies employing *in vitro* measurements are thus difficult (this is especially true with postnatal studies). Also, the conduct of *in vivo* studies is problematic for obvious reasons. (See Juchau et al. 1980, Hakkola et al. 1998, Juchau et al. 1998.)

1.2.2 Detecting XME Expression

Detection of XME expression has been discussed in Hakkola et al. (1998) and Juchau et al. (1998). XME expression can be studied at several levels: (1) at mRNA levels, using Northern blotting, reverse transcriptase-polymerase chain reaction (RT-PCR), and RNA-ase protection; (2) at protein levels, using Western blotting and immunohistochemistry, and (3) at activity levels. It is clear that from the functional point of view, it is the activity that should be demonstrated, because activity determines the possible outcomes (e.g., pharmacokinetic behavior, metabolic activation, toxic effects).

1.2.3 Identification of Gestational Ages

For obvious reasons, most prenatal studies have been performed on tissues that have come from relatively advanced fetuses (fetal period: approximately 58 days of gestation until parturition). Studies of tissues obtained at the embryonal stage (before 58 days), including the stage of principal organogenesis (from the appearance of the primitive streak at 17 days of gestation until the beginning of the fetal period) are necessarily more difficult to perform.

1.2.4 Sensitivity Issues

Detection of expression (e.g., mRNA, protein, activity) is naturally dependent on the sensitivity of the method used. Thus, the RT-PCR methodology is far more sensitive than either the Northern blotting or the RNA-ase protection assay for detecting the expression of mRNA, which are in turn more sensitive than immunological methods to detect the protein. However, from the outcome point of view, function (i.e., metabolism of a substance) is the most important issue. In determining enzyme activity, sensitivity permitting, another problem arises: What determines functional, or biological, significance? What is pharmacologically or toxicologically significant? Is a 1 percent change in adult activity level significant, or is 10 percent the threshold for significance of the effect? Obviously, there is no generally applicable answer to this problem, since the assessment depends on the compound, the activity, the enzyme, the outcome and so on. For example, a series of studies from Juchau's laboratory have shown that even extremely low CYP1 levels produced in cultured rat conceptuses are enough to catalyze the conversion of 2-acetylaminofluorene to sufficient quantities of dysmorphogenetic metabolites, which can elicit gross malformations in the cultured conceptuses (Juchau et al. 1998). In Juchau's assessment, "absolute quantities/levels of conceptual tissue P450s were of far lesser consequence than bioactivation/inactivation ratios." Unfortunately, currently it is not known how to measure these ratios reliably.

1.3 DETERMINATION OF RELATIVE ACTIVITIES AND MATURATION OF XMEs

1.3.1 Cytochrome P450 (CYP) Enzymes: CYP Genes and Enzymes in Adult Liver (Levels, Regulation, etc.)

Good descriptions of adult P450 enzymes (variability, regulation, and other aspects) can be found in a large number of recent review articles (Gonzalez and Lee 1996, Guengerich 1995, Ingelman-Sundberg and Johansson 1995, Nelson et al. 1996, Pelkonen et al. 1998). A useful presentation of CYPs (and other XMEs) in connection with developmental drug metabolism can be found in Leeder and Kearns (1997). (See Tables 1-1 and 1-2).

Because adult CYPs have been extensively characterized, it is easier to predict the ability of the fetus to metabolize a given compound if: (1) the fetal CYP pattern is known, *and* (2) the adult CYP metabolic profile for a given compound is known. With the current *in vitro* approaches, pinpointing the most important CYP enzymes in the metabolism of practically all exogenous (and endogenous) chemicals is relatively straightforward even before *in vivo* elucidation of their fate.

The most extensive series of studies dealing with the development of CYP enzymes has come from Cresteil's laboratory. They have collected a fairly large human liver tissue bank (fetal livers: 14-30 weeks, about 50 individuals; fetal livers: > 30 weeks, about 10 individuals; neonatal livers: 1-7 days and 7-28 days, about 10 individuals each; 1-3 months, about 20 individuals; 3-12 months, about 15 individuals; > 1 year, 4 individuals; adults, more than 10 individuals). The most detailed account of this

tissue bank can be found in Vieira et al. (1996). This series of studies constitutes the backbone for our understanding of developmental behavior of CYP enzymes. For example, the semiquantitative assessment of the development of CYP enzymes in humans (shown in Table 1-1) is based largely on the studies of Cresteil's group.

In the liver, the total P450 content is relatively constant, about 30 percent of the adult level, from the end of the first trimester of gestation up to 1 year of age (Cresteil et al. 1985, Lacroix et al. 1997). However, the total amount gives only a very limited and narrow view of CYP-associated metabolism, and with individual substances it may give a completely wrong picture.

1.3.2 Cytochrome P450 (CYP) Enzymes: CYP1 Subfamily

On the basis of extensive studies going back 20 years, it is known that most CYP enzymes are polymorphic, i.e., CYP genes contain mutations or deletions that lead to the lack of active enzymes. If an individual has two inactive alleles in the genome, she or he will be (phenotypically) a "poor metabolizer," with obvious consequences for xenobiotic metabolism and kinetics and for metabolic activation. Also, some variant alleles produce proteins that have changed activities and, consequently, gene amplifications leading to multiple alleles may result in manifestation of "ultrarapid" metabolism.

1.3.2.1 *CYP1A1*

Fetus and neonate. In adults, CYP1A1 is regarded principally as an extrahepatic enzyme, which is readily inducible by polynuclear aromatic hydrocarbons (PAHs) and dioxin-type inducers. There is some evidence that CYP1A1 mRNA can be detected in human fetal liver by very sensitive RT-PCR methods, but not by less sensitive methodology (Juchau et al. 1998, Hakkola et al. 1999). However, CYP1A1 protein is most probably very low or absent; but there are also discrepant results (Rich and Boobis 1997). This uncertainty is reminiscent of the adult situation: controversy still remains as to whether CYP1A1 is present at all in adult human liver and whether it is even inducible by PAH-type inducers. The situation is complicated, both in adults and fetuses, by the similarity of CYP1B1, in terms of substrate specificity and inducibility, because earlier studies used probes that were not strictly specific for either of the enzymes.

1.3.2.2 *CYP1A2*

Fetus. The study of Sonnier and Cresteil (1998) indicated that the CYP1A2 protein or its known associated activities (methoxyresorufin demethylase or N-demethylation of imipramine) were absent in both fetal and neonatal (< 1 month) liver preparations, and that levels increased in infants ages 1-3 months, to attain 50 percent of the adult value at 1 year. This confirms the earlier studies, which have failed to find any evidence for the expression of CYP1A2 in fetal liver (Mäenpää et al. 1993, Hakkola et al. 1994, Yang et al. 1995, Shimada et al. 1996b).

Neonate and infant. Discrepant findings are reported, although CYP1A2 is most probably present at low levels and gradually rises (Cazeneuve et al. 1994, Shimada et al. 1994, Treluyer et al. 1996; see also Sonnier and Creteil 1998).

Child (3 years and older). Levels at this stage are comparable to adults (Ratanasavanh 1991). On the basis of pharmacokinetic studies, adult levels may even be exceeded (Leeder and Kearns 1997).

In vivo studies (caffeine). Pharmacokinetics and CYP1A2-associated caffeine metabolite formation conform with results from *in vitro* studies (Carrier et al. 1988, Cazeneuve et al. 1994). Levels gradually increase over several months (up to 1 year) to attain adult levels.

1.3.2.3 CYP1B1

In adult humans, CYP1B1 is expressed mainly in extrahepatic tissues. It resembles CYP1A1 in terms of substrate specificity and inducibility by PAHs and dioxins. Although CYP1B1 mRNA has been detected by the sensitive RT-PCR method in embryonic human hepatic[,] adrenal, cephalic, pulmonary, renal, and cardiac tissues, it is not detectable with less sensitive mRNA detection methods or at the protein or activity level (Juchau et al. 1998). CYP1B1 is expressed, presumably constitutively, during the fetal period; however, it is expressed mainly extrahepatically, and very little expression is found in the liver tissue (Shimada et al. 1996a, Hakkola et al. 1997, Juchau et al. 1998). CYP1B1 may also be inducible by PAHs and TCDD, because increases in mRNA have been demonstrated in human fetal liver explants in culture (Juchau et al. 1998).

1.3.3 Cytochrome P450 (CYP) Enzymes: CYP2 Subfamily

1.3.3.1 CYP2A6

Fetus. CYP2A6 is not expressed in fetal liver as measured by enzymatic activity, immunoblotting, or RT-PCR (Mäenpää et al. 1993, Hakkola et al. 1994, Shimada et al. 1996b). CYP2A7 mRNA is not expressed prenatally (Hakkola et al. 1994). CYP2A13 is expressed in fetal olfactory mucosa (Ding et al. 2000).

Infant. Low but detectable levels of CYP2A6 immunoreactive protein and coumarin 7-hydroxylation activity were measured in a single infant liver sample (Shimada et al. 1994).

In vivo studies. The urinary excretion of 7-hydroxycoumarin is at the adult level in children of 6-13 years of age (Pelkonen et al. 1997).

1.3.3.2 CYP2B6

Fetus. CYP2B6 has not been detected in fetal liver by RT-PCR or Western blotting (Mäenpää et al. 1993, Hakkola et al. 1994). Otherwise, very little is known about the development of CYP2B6, because this enzyme is one of the less well studied CYPs.

Infant. A single infant liver contained high levels of CYP2B6 compared with adult livers (Shimada et al. 1994).

1.3.3.3 CYP2C

Fetus. Expression of CYP2C members in fetal liver seems to be very low or negligible (Cresteil et al. 1985, Umberhauer et al. 1987, Ratanasavanh et al. 1991, Shimada et al. 1996b), although some evidence has been published for the expression of CYP2C members (e.g., CYP2C8), on the basis of Western blotting and RT-PCR studies (Mäenpää et al. 1993, Hakkola et al. 1994). The most definitive study thus far is that of Treluyer et al. (1997), in which the development of CYP2C mRNA and protein(s) and some associated activities (i.e., tolbutamide hydroxylation and diazepam N-demethylation) were investigated. CYP2C expression was negligible before birth, then rose during the first postnatal month to roughly one third of the adult levels, which were reached sometime after 1 year of age. Quantitative mRNA measurements of CYP2C8, CYP2C9, and CYP2C18 indicated that they all developed in parallel.

Neonate. Relatively high mRNA and protein levels have been found (Ratanasavanh et al. 1991, Treluyer et al. 1996). Treluyer et al. (1996) analyzed samples from infants who had died of Sudden Infant Death Syndrome. Results indicated a several-fold increase (2- to 10-fold) in the expression of CYP2C as measured by Western blotting and diazepam N-demethylation. The authors noted that some CYP2C enzymes catalyze the formation of epoxyeicosatrienoic acids, which have effects on lung vasculature. The association between increased CYP2C expression and Sudden Infant Death Syndrome remains purely hypothetical.

There is some evidence that neonatal treatment with barbiturates and prednisolone induces immunochemically measurable CYP2C and associated activities such as tolbutamide hydroxylation and diazepam N-demethylation (Treluyer et al. 1997).

Infant. Higher CYP2C immunostaining and RNA levels were detected in neonates and infants who had died from Sudden Infant Death Syndrome compared with controls (Treluyer et al. 1996).

Child. On the basis of kinetics obtained with the probe drug, phenytoin, it seems that children of 3-4 years of age may exhibit higher CYP2C9 levels (Leeder and Kearns 1997).

1.3.3.4 CYP2D6

Fetus. Controversial findings on the expression of CYP2D6 in fetal liver have been reported in the literature (Ladona et al. 1991, Treluyer et al. 1991, Hakkola et al. 1994, Shimada et al. 1996b). However, the most definitive study is from Cresteil's group (Treluyer et al. 1991), in which both protein and associated activity (dextromethorphan O-demethylase) were measured, indicating that CYP2D6 is either absent, or present at only a very low level before birth. In livers obtained from fetuses of over 30 weeks gestational age, protein and activity were present in about half of the livers, but they never

exceeded 10 percent of the adult level. Bearing in mind that CYP2D6 is polymorphic, with about 7 percent of Caucasians being deficient, one could conclude that this polymorphism has no potential consequences prenatally, because of a (relative) lack of expression, but may have functional consequences postnatally.

Neonate. A clear increase in CYP2D6 protein expression was found during the first postnatal week (Treluyer et al. 1991).

Infant. In a group of samples from infants and children up to 5 years of age, levels had reached about two thirds of the average adult levels (Treluyer et al. 1991).

1.3.3.5 *CYP2E1*

Fetus. Contradictory data exist concerning expression of CYP2E1 in fetal liver (Wrighton et al. 1988, Komori et al. 1989a, Jones et al. 1992, Hakkola et al. 1994, Shimada et al. 1996b, Vieira et al. 1996, Carpenter et al. 1996). Carpenter et al. detected the expression of CYP2E1 at the mRNA, protein, and activity levels, although at a far lower level than in adults, beginning from 16 weeks of gestation, but not earlier. Other studies cited above did not find any expression at the fetal stage. Especially convincing in this respect is the study by Vieira et al. (1996) from Cresteil's laboratory, in which very little or no expression of CYP2E1 at the mRNA, protein, and activity levels could be found before birth. In conclusion, it seems relatively clear that CYP2E1 is not expressed in the embryonic liver (Juchau and Yang 1996), but the situation during the fetal period seems more unclear.

Neonate. CYP2E1 protein levels, combined with chlorzoxazone hydroxylation activity, rapidly increases during the first 24 hours after birth (Vieira et al. 1996).

Child. CYP2E1 protein levels and chlorzoxazone hydroxylation activity observed in samples from children between 1 and 10 years of age were comparable to adults (Vieira et al. 1996).

1.3.4 Cytochrome P450 (CYP) Enzymes: CYP3 subfamily

A review summarizing earlier studies concerning the development of CYP3A enzymes has been published by Kitada and Kamataki (1994).

1.3.4.1 *CYP3A7*

Fetus. In adults, the CYP3A subfamily is the most abundant, consisting of about 30 to 50 percent of total P450 content on a protein basis. It also is probably the most significant in terms of substrates metabolized (roughly 50 percent of all drugs metabolized). Also, induction and inhibition interactions involving CYP3A enzymes are well recognized (Pelkonen et al. 1998). The CYP3A enzymes also predominate in fetal liver, constituting at least 30 percent, but maybe even 60 to 70 percent of the total P450 pool (Kitada et al. 1996). In contrast to the adult liver, the major form is CYP3A7, which constitutes

more than 50 percent of the total fetal liver P450 content (Kitada et al. 1985, Kitada and Kamataki 1994, Shimada et al. 1996). CYP3A7 is the *only* fetal CYP enzyme that has been unequivocally identified and functionally characterized. The CYP3A7 protein has been purified by two different laboratories (Kitada et al. 1985, Wrighton and VandenBranden, 1989). CYP3A7 cDNA has been cloned, and the sequence was confirmed to correspond to the N-terminal amino acid sequence of the purified proteins (Komori et al. 1989b). The expression of CYP3A7 begins during embryogenesis at a very early stage of pregnancy (Yang et al. 1994).

CYP3A7-related activities have been studied in fetal liver microsomal fractions and homogenates as well as in many genetically engineered cell lines and even in transgenic mice (Kitada et al. 1987a, Kitada et al. 1987b, Kitada et al. 1991, Kitamura et al. 1992, Sakuma et al. 1995, Li et al. 1996). CYP3A7 metabolizes numerous xenobiotics, including many clinically used drugs, and activates several procarcinogens (Kitada and Kamataki, 1994; see Table 1-3). CYP3A7 catalyzes metabolism of endogenous compounds like testosterone hydroxylation and 6 β -hydroxylation and dehydroepiandrosterone 3-sulfate 16 α -hydroxylation (Kitada et al. 1987a, Kitada et al. 1987b, Rane et al. 1992).

When specific CYP3A7-catalyzed activities are compared with those of CYP3A4, sometimes large differences can be observed despite the fact that there are two enzymes belonging to the same subfamily (Table 1-3). Thus, given that there is no conspicuous change in total CYP3A proteins during fetal and neonatal (up to 1 year) periods, metabolic conversions of substrates may still profoundly change, depending on specific activities involving these substrates by CYP3A7 and CYP3A4.

1.3.4.2 CYP3A5

Fetus. CYP3A5 is expressed in fetal liver, although the expression of this protein has only been seen in a few individuals (Wrighton et al. 1990, Schuetz et al. 1994, Yang et al. 1994). The level of expression, as measured by quantitative RT-PCR, is about 700-fold lower than that of CYP3A7 (Hakkola et al. 2001).

1.3.4.3 CYP3A4

Fetus. Extremely small amounts of CYP3A4 mRNA are found in fetal liver (Hakkola et al. 1994, Greuet et al. 1996).

Infant and child. CYP3A4 levels are close to those of adults, and there are some pharmacokinetic indications from studies using CYP3A4 probe drugs that adult levels are exceeded at 1-4 years of age (Leeder and Kearns 1997).

1.3.5 Developmental (Perinatal) Transition of CYP3A Subfamily Expression

Transition probably occurs within a relatively narrow time window around (probably after) the time of birth (Kitada et al. 1987b, Wrighton et al. 1990, Ratanasavanh et al. 1991, Lacroix et al. 1997). *In vivo* findings (e.g., 6-hydroxycortisol excretion) support this view (Vauzelle-Kervroedan et al. 1996).

1.4 REGULATION OF DEVELOPMENTAL P450 EXPRESSION

1.4.1 Transcriptional Regulation

In animals, developmental expression of the liver-enriched transcription factors appears to account for the activation of the CYP gene expression during maturation (Umeno et al. 1988, Gonzalez 1992, Gonzalez and Lee 1996, Vieira et al. 1996). However, because of differences between humans and animals (and lack of relevant data), it is difficult at present to draw firm conclusions about the situation in humans.

1.4.2 Induction by Exogenous Chemicals

Some XME activities are inducible in fetal rodents by transplacental exposure to chemicals (Raucy and Carpenter 1993). In principle, CYP3A7 is inducible in adult hepatocytes by rifampicin, but whether it is inducible in fetal liver is not known (Greuet et al. 1996). The potential induction of CYP1A(B?) genes was discussed earlier.

1.4.3 Use of Fetal Hepatocytes

Fetal hepatocytes or explants in culture have been used for investigating regulation and induction of XMEs. For example, PAH-type inducers have been shown to induce CYP1A (1B?)-associated activities in fetal hepatocytes and explants (Juchau et al. 1998), and ethanol increases the expression of CYP2E1 in fetal hepatocytes (Carpenter et al. 1996). However, one should keep in mind that there are problems in using hepatocytes as a model for the *in vivo* situation.

1.5 OTHER PHASE I ENZYME SYSTEMS

1.5.1 Epoxide Hydrolase (EH)

Hepatic microsomal EH activity, protein, and mRNA were detectable in all fetal livers assayed from 50 days of gestation onwards (Cresteil et al. 1985, Omiecinski et al. 1994). EH activity also was detectable in the adrenals, lungs, and kidney, although at a lower level than in the liver. EH expression increases with increasing gestational age, between 50 and 160 days of gestation (Omiecinski et al. 1994), but the largest increase probably occurs postnatally (Klinger 1996).

1.5.2 Flavin-containing Monooxygenase (FMO)

There are at least six FMO genes in humans. Dolphin et al. (1996) studied expression at the mRNA level of three of these genes in human fetal and adult tissues. FMO1 was expressed in fetal liver and kidney, but expression was absent in the adult liver. The mRNA encoding FMO3 was abundant in adult liver and was also present, at low levels, in fetal liver, kidney, and lung. FMO mRNA was present at low levels in fetal and adult liver and kidney. Because there is considerable overlap in the substrates used by CYPs and FMOs, it is difficult to tell on the basis of earlier activity studies whether FMO proteins are present and active in fetal tissues.

1.5.3 Alcohol Dehydrogenase (ALD)

In all species studied, ALD activity is low or absent in fetal liver and increases postnatally (Juchau et al. 1980, Klinger 1996).

1.5.4 Reductases

Old (mainly) animal data are available (Juchau et al. 1980, Klinger 1996). Activities are absent or very low before birth and develop at variable rates postnatally.

1.5.5 Hydrolases/Esterases

Old (mainly) animal data are available (Juchau et al. 1980, Klinger 1996). There are a large number of hydrolases that have not been studied in any systematic way, either in animal or human fetuses or neonates. Old studies suggest that at least those esterase activities present in blood are low in the fetus and neonate.

1.6 PHASE II ENZYME SYSTEMS

The principal problem in forming a coherent description of the development of phase II enzymes is that the characterization of individual forms has not advanced nearly to levels of CYP enzymes characterization. Thus, we are still dealing mainly with individual activities that might be catalyzed by several differentially regulated forms. For this reason, “predictive” treatment of the subject is difficult, but should be realized within the next few years.

1.6.1 UDP-glucuronosyl Transferases (UGT)

The reviews covering earlier work on UGTs include those of Coughrie and Burchell (1989) and Burchell et al. (1989); a more recent review by Burchell et al. (2001) will soon be published. Currently, 15 human liver members of the UGT superfamily have been cloned and have been classified into two subfamilies based on sequence relatedness (Tukey and Strassburg 2000). Many of these UGTs have been characterized, but not a single one to the extent achieved with most of the hepatic CYP enzymes. Developmental profiles of individual forms have not yet been published. In animals (rodents), various UGT activities develop at different times, some before birth, some very quickly after birth, and some more slowly during the postnatal period. These different activity groups are sometimes referred to as “fetal clusters,” “perinatal clusters,” and neonatal clusters,” depending on at which time point a major increase occurs. It is probable that these clusters represent the development of various UGT isoenzymes. The situation is not so clear in humans, although there is some evidence of clustering, suggesting isoenzymic basis (see Ring et al. 1999). In humans, late fetal and newborn liver samples contain from “very low” to “low” activity (probably due to the relative deficiency of UGT1A isoenzymes, see Table 1-4) and the development to adult levels occurs during the first 3-4 months of life, although there probably are large differences between different UGT enzymes.

1.6.2 Glutathione S-transferases (GST)

There are at least five families of GST genes in humans, and GSTM1 and GSTT1, especially, demonstrate significant polymorphism. However, there is very little good isoform-specific information available about the expression of these isoenzymes in human fetal tissues. In humans, postnatal development of some activities and protein patterns have been studied. The adult pattern is achieved by about 1 year after birth (Davis et al. 1985).

1.6.3 Sulfotransferases (SULT)

Although several members of the sulfotransferase family have been characterized, very little exact information exists about the development of individual forms. In human fetal liver, levels of SULT activity groups (see Table 1-5) are reasonably high, and may be described as close to, or even higher than, adult levels (Ring et al. 1999). For example, harmol sulfation in fetal liver is almost at the adult level, whereas harmol glucuronidation is absent in the fetus (Steiner et al. 1982). As for activity level, sulfation seems to play a compensatory role in newborn humans with regard to glucuronidation (Rane and Thomson 1980).

1.6.4 N-acetyltransferases (NAT)

There are two NAT genes in humans, both of which are polymorphic, with a number of variant alleles. To date, there are no definitive studies of the expression of NAT1 or NAT2 enzymes in the human fetus. Peng et al. (1984) studied acetylation of 7-aminoclonazepam, a known NAT2 substrate, in human

fetal liver *in vitro* and found that although NAT2 activity was absent at 11-14 weeks of gestation, some activity was detectable at 16 weeks. Information about the postnatal development of NAT2 polymorphism may be found in Pariente-Khayat et al. (1991).

1.6.5 Amino Acid (Glycine) Conjugation

The literature on these phase II enzymes is very scanty and old.

1.6.6 Thiopurine S-methyltransferase (TPMT)

TPMT catalyzes the S-methylation of aromatic and heterocyclic sulfur-containing compounds, such as mercaptopurine, azathioprine, and thioguanine. It is also polymorphic, and this is of some significance to the therapeutic efficacy and toxicity of thiopurine therapy of cancer and immunosuppression (Leeder and Kearns 1997). TPMT can be detected in fetal liver, although at a lower level than in adults (Pacifici et al. 1991). In newborns, TPMT activity is higher than that found in adults (McLeod et al. 1995).

1.7 EXTRAHEPATIC BIOTRANSFORMATIONS

Most of the earlier studies of prenatal extrahepatic biotransformation were based on measurements of enzyme activities using nonspecific and insensitive methods that are now considered outdated. Results of these studies have been summarized by Klinger (1996). In general, activities are extremely low or absent, although there have also been contradictory findings. Many of the positive findings can most probably be explained by the use of outdated and flawed methods applied to tissues containing very low inherent activities.

Older, activity-based studies indicated that CYP1A-related enzymes might be present in human fetal tissues. On the basis of more recent studies it seems especially clear that CYP1A- and 1B-associated activities are inducible in fetal, and also possibly embryonal, extrahepatic tissues (Juchau et al. 1998). However, for the reasons given earlier, it is difficult to associate biotransformation data with specific CYP enzymes.

Studies of the expression of other CYP enzymes in fetal extrahepatic tissues are more scarce. The presence of CYP2A13 in fetal olfactory mucosa at relatively high concentrations may have implications for olfactory toxicants in fetal life (Gu et al. 2000). The expression of CYP2E1 has been studied in human fetal kidney and lung; no expression at the mRNA level has been demonstrated (Vieira et al. 1998). As a probable mechanism of repression, methylation of the 5'-region sites of the gene was suggested. However, based on RT-PCR studies, Boutelet-Bochan et al. (1997) indicated that CYP2E1 is expressed during embryogenesis and fetogenesis in cephalic tissue, and hypothesized a role in the etiology of neuroembryotoxic effects of prenatal ethanol exposure.

Studies of the expression of phase II enzymes are even more scarce (or very old, see Klinger 1996). Until isoenzyme-specific probes are developed and applied, it is probably pointless to attempt to summarize these data.

1.8 SPECIES DIFFERENCES

The key reviews on this topic are those recently published by Rich and Boobis (1997) and Juchau et al. (1998). The principal problem is that even if the homologous (ortologous) enzyme is expressed in two species, they may differ with respect to substrate specificity and enzyme kinetics (e.g., K_m , V_{max}). Thus, the compound metabolized by an enzyme present in human fetal liver is not necessarily metabolized by the ortologous enzyme present in the liver of the other species, or if it is metabolized, this occurs with different kinetic characteristics. The only direct way to tell whether a compound is metabolized in two species is to study its metabolism in those two species. For this reason, it is difficult to use old literature to create the necessary descriptive framework for confident extrapolation from animals to humans. Klinger (1996) summarizes a large number of earlier activity studies. It may be that the most productive way to use animals in developmental drug metabolism research is in mechanistic and regulation studies.

Interspecies comparisons concerning some enzyme activities in human fetal liver *in vitro* can be found in older articles (see Juchau et al. 1977, 1980; Pelkonen et al., 1980), but these older studies with “outdated” substrates (aminopyrine, aniline, hexobarbital) are difficult to interpret in the light of the current knowledge regarding expression (or lack thereof) of orthologous CYP enzymes.

1.9 ENZYME POLYMORPHISMS

Two relatively recent reviews have explored the potential implications of pharmacogenetics in pediatric drug therapy (Kearns 1995, Leeder and Kearns 1997) and include some discussion of the development of drug-metabolizing enzymes. It is clear that the relevance of polymorphic pharmacogenetic conditions depends on the developmental phase of an enzyme’s expression; if an enzyme is not present or is severely inadequate, the expression of a polymorphic trait is not possible. Not much pertinent information is available. However, there is evidence that by 10-12 months of age, polymorphic NAT2 activity may have developed to the extent that the frequency distribution of slow and rapid acetylation phenotypes corresponds to that of adults (Pariente-Khayat et al. 1991). Before this age range, all individuals are slow acetylators. CYP2D6 polymorphism has been measured in infants several months of age, by which time it seems the polymorphic trait (i.e., poor metabolizer trait) is detectable. Before that age, CYP2D6 expression is too low for the polymorphism to exit.

1.10 LIVER STRUCTURE, METABOLIC ZONATION, AND METABOLISM

The key reviews on this topic are those recently published by Ring et al. (1999) and Gow et al. (2001). The clear “zonation” that exists in adult liver does not exist in the livers of fetal rats, mice, or humans, except near to term (Ring et al. 1999). The zonation (as in adults) of hepatic CYPs develops only after birth (Ratanasavahn et al. 1991, Murray et al. 1992). There is some lobar heterogeneity in fetal mouse liver (Chianale et al. 1988). The significance of functional zonation, or a lack thereof in the fetal liver, remains to be explored. A thorough discussion of these anatomical and functional aspects can be found in Ring et al. (1999).

1.11 SEX DIFFERENCES

Although well-known development-dependent sex differences in XMEs have been documented to exist in rats (less in mice), very little information exists for human, even for adults. In rats especially, CYP2C members undergo complex sex-dependent developmental changes. It seems that sex differences in human XMEs are relatively minor, if they exist at all for most enzymes, but there may be a modest difference in CYP3A4 expression (see Pelkonen et al. 1998). Whether a similar difference exists in CYP3A7 expression and activity during fetal life is not known. The most recent review available (for rodents) is by Rich and Boobis (1997).

1.12 THE SIGNIFICANCE OF FETAL XENOBIOTIC METABOLISM

1.12.1 Metabolic Activation (Transplacental Mutagenesis, Carcinogenesis, and Teratogenesis)

The key review articles are those recently published by Juchau et al. (1992), Wells et al. (1996), Hakkola et al. (1998), and Juchau et al. (1998). Animal models demonstrate unequivocally that both maternal and conceptual metabolism affect the toxicity of some compounds (Juchau et al. 1998). However, the situation in man is not yet understood. Because oxidative xenobiotic metabolism and activation occur in the human embryo during organogenesis, activation to teratogenic intermediates could take place in humans. Many teratogens are metabolized (activated) by human fetal liver (see Table 1-6), presumably by CYP enzymes. However, direct demonstration is lacking that would show that the enzymes, especially CYP3A7, are actually involved in metabolic activation of teratogens (shown in Table 1-6).

Risk assessment of potential fetotoxicity should follow a defined sequence:

1. Enzyme-specific metabolism and metabolic activation of a compound of interest (e.g., a pesticide) is studied in human liver microsomes/preparations and recombinant expressed systems, as well as in induction systems.
2. The desired outcome is knowledge of the balance between enzyme-specific activation and detoxification processes for a specific compound.

3. The risk assessor looks at the expression (presence or absence) of this or those particular enzymes in human embryonic, fetal, or neonatal tissues, which has been elucidated earlier.
4. The risk assessor estimates or determines whether a compound would pose a hazard to the human embryo or fetus.

Although this scheme is obviously incomplete (e.g., one could easily imagine the presence of fetal-specific enzymes metabolizing and activating xenobiotics), it should be useful to risk assessors in many situations.

1.12.2 Expression and Toxicological Significance of CYP1A1

Key reviews are those by Hakkola et al. (1998) and Juchau et al. (1998). CYP1A1 is the only enzyme found unequivocally to be expressed, albeit at a low level, during the period of organogenesis in animal fetuses, which may be of importance in toxicity caused by environmental carcinogens (see above). However, it has also been suggested that CYP1A1 has a role in modulating cell division, growth, and morphogenesis (Nebert 1991).

1.12.3 Metabolism of Endogenous Compounds

In the adult, XMEs participate in the metabolism of some endogenous substances; the following discussion presents several examples concerning the human fetus.

Epoxyeicosatrienoic acids, which are active prostanoids, are formed by CYP2C enzymes, which is of interest in the light of possible expression of CYP2C8 in fetal liver. Also, retinoids are oxidized by CYP2C enzymes. Whether or not CYP2C8 is really expressed in the fetal liver, and whether its endogenous functions have any biological significance, remains to be elucidated.

Testosterone and some other steroids, such as cortisol, are oxidized at various carbon atoms by several CYPs, but the principal 6B-hydroxylation is catalyzed by CYP3A enzymes. CYP3A7 is not particularly active in this respect, but whether this has any meaning in the prenatal life is not known.

Bilirubin is glucuronidated in the liver, principally by UGT1A enzyme(s). However, glucuronidation of bilirubin is very low or absent in the fetal and neonatal liver and develops during the first weeks of life. This finding is in agreement with the absence or very low expression of (presumably) UGT1A enzymes during the fetal and neonatal periods.

1.13 CONCLUSIONS

Despite considerable methodological and practical difficulties, a relatively clear picture of the development of xenobiotic-metabolizing enzymes, especially with respect to CYP enzyme levels, has been emerging during the past decade. CYP3A7 is a major enzyme expressed at fetal period, and there is a rapid switch between CYP3A7 and CYP3A4 perinatally. Specific activities toward various substrates of these two CYP3A enzymes show considerable differences, so substrate specificity and specific activity of CYP3A7 have to be studied separately to make useful predictions. All other studied CYP enzymes are either absent prenatally or present at low levels; the major development occurs postnatally in an enzyme-dependent fashion. There is no consistent pattern of expression of phase II enzymes during the fetal period; some are practically absent (such as most UGTs) and some are close to adult levels (such as some SULTs).

For risk assessment purposes, two pieces of information should be especially useful: knowledge of developmental expression of each enzyme/isoform, and knowledge of substrate specificity and the specific activity of each enzyme/isoform. In experiments with animals, development of xenobiotic metabolism generally resembles that in humans; that is, there is a relative paucity of activities during the fetal period and more or less rapid development of enzymes postnatally. However, use of animal data for chemical risk extrapolation is hampered by known differences in enzymatic properties of orthologous enzymes in different species and by lack of comparative information. Future research on developmental expression of transcription factors and other factors regulating xenobiotic-metabolizing enzymes in humans and animals should give new tools and information to risk assessors.

Risk assessment of potential fetotoxicity should follow a defined sequence: (1) enzyme-specific metabolism and metabolic activation of a compound of interest (e.g. a pesticide) should be studied in human liver microsomes and recombinant expressed systems, as well as in induction systems; (2) the desired outcome should be knowledge of the balance between enzyme-specific activation and detoxification processes for a specific compound; (3) risk assessors should carefully examine the expression (presence or absence) of this or those particular enzymes in human embryonic, fetal, or neonatal tissues; (4) risk assessors may then estimate whether a compound would pose a hazard to the human embryo or fetus. Although this scheme is obviously incomplete, (for example, one could easily imagine the presence of fetal-specific enzymes metabolising and activating xenobiotics), it should be useful to risk assessors in many situations.

1.13.1 General Findings

1. Older studies in this area are less likely to be useful because of methodological limitations. Expression of xenobiotic metabolizing enzymes (XME) can be studied at several levels; however, studies that measure activity are the most useful, because this determines metabolic clearance and/or bioactivation and ultimately, toxic effects.

The most sensitive methodology for detecting XME activity is RT-PCR (reverse transcriptase-polymerase chain reaction). However, the biological significance of changes in activity levels detected is not always clear. Also, a very little quantitative information exists about XMEs that might be translated into enzymatic maximum velocity (V_{max}) and affinity to xenobiotic substrate (K_m).

2. Most prenatal studies have been performed on relatively advanced fetuses, and the gestational age of the source fetal tissue is not always clearly identified. Studies on tissues before 58 days of gestation are more difficult to perform, and therefore, there is less information available.
3. Adult cytochrome P450 (CYP) enzymes have been extensively characterized. The most extensive series of studies on the development of cytochrome P450 (CYP) enzymes comes from Cresteil et al. For a given compound, as long as the fetal CYP pattern is known and the adult CYP metabolic profile is known, the most important CYP enzymes can be inferred using *in vitro* approaches.
4. The most abundant CYP in adults and fetuses are the CYP3A subfamily; a period of transition occurs within a relatively narrow time window around, or after, birth. In adults, this group constitutes 30 to 50 percent of total P450 content, in fetuses the fraction is higher, possibly 60 to 70 percent of the total content. The major form in fetal liver is CYP3A7, which constitutes >50 percent of the total P450 content. At present, it is not clear whether CYP3A7 is inducible in human fetuses.
5. There is very little information available on sex differences in the expression of XMEs.
6. The clear zonation that exists in adult liver does not exist in the livers of fetal rats, mice, or humans.
7. Although there are more than 15 human liver members of the UDP-glucuronosyl transferases, developmental profiles for individual forms have not yet been published.

1.13.2 Specific Findings in Different Age Groups

Fetus

1. It is probable that maternal pharmacokinetics play a large, maybe the determining, role in fetal exposure to foreign chemicals. Placental biotransformation may become, in certain cases, a limiting factor in fetal exposure.
2. Total fetal liver CYP content is relatively constant from the end of the first trimester of gestation up to 1 year of age, and during this period is about 30 percent of the adult level.
3. The following CYP enzymes seem to be present in significant amounts in fetuses:
 - CYP1B1: present at low levels, extra-hepatic predominates over hepatic, inducible.
 - CYP3A7: constitutes >50 percent of the total P450 content of fetal liver
4. Epoxide Hydrolases are detectable in fetal liver, and lower levels are also found in the adrenals, lungs, and kidney. It is difficult at present to tell whether flavin-containing mono-oxygenases are

present and active in fetal tissues. Alcohol dehydrogenases are not expressed in the fetal liver. Little is known about the expression of reductases or hydrolases or esterases.

5. Sulfotransferase levels in fetal liver are as high, or even higher than, in adult liver. Glucuronidase levels, by contrast, are extremely low.

Neonate

1. Besides CYP3A7, the following CYP enzymes seem to be present in significant amounts in neonatal liver:
 - C CYP1A2: increases in children 1-3 months to 50 percent of adult levels within 1 year
 - C CYP2B6: possibly present at levels comparable to adults (1 sample only)
 - C CYP2C: increases in children 1-3 months to 33 percent of adult levels within 1 year; associated with SIDS
 - C CYP2D6: increases during the first post-natal week.
 - C CYP2E1: increases rapidly during the first 24 hours after birth
2. The expression of epoxide hydrolases increases dramatically shortly after birth. This is also true of alcohol dehydrogenases.
3. The expression of glutathion-S-transferases increases to the adult pattern and level by 1 year.
4. The expression of glucuronidase enzymes increases postnatally to attain adult levels by about 3-4 months of age.
5. Thiopurine S-methyltransferase enzyme expression and activity may be higher in newborns than in adults.

Child

1. There is no comprehensive and careful assessment of the development of biotransformation in toddlers, older children, or teenagers, as compared to adults.
2. The following CYP enzymes seem to be present in significant amounts in livers of children (3 yrs onward):
 - C CYP1A2: levels comparable to adults
 - C CYP2C9: levels comparable to or higher than in adults
 - C CYP2D6: increases to attain two-thirds adult levels by age 5
 - C CYP2E1: levels comparable to adults sometime between 1 and 10 years of age

- C CYP3A4: levels comparable to adults; possibly higher between 1-4 years of age Despite considerable methodological and practical difficulties, a relatively clear picture of the development of xenobiotic-metabolizing enzymes, especially with respect to CYP enzyme levels, has been emerging during the past decade. CYP3A7 is a major enzyme expressed at fetal period, and there is a rapid switch between CYP3A7 and CYP3A4 perinatally. Specific activities toward various substrates of these two CYP3A enzymes show considerable differences, so substrate specificity and specific activity of CYP3A7 have to be studied separately to make useful predictions. All other studied CYP enzymes are either absent prenatally or present at low levels; the major development occurs postnatally in an enzyme-dependent fashion. There is no consistent pattern of expression of phase II enzymes during the fetal period; some are practically absent (such as most UGTs) and some are close to adult levels (such as some SULTs). For risk assessment purposes, two pieces of information should be especially useful: knowledge of developmental expression of each enzyme/isoform, and knowledge of substrate specificity and the specific activity of each enzyme/isoform. In experiments with animals, development of xenobiotic metabolism generally resembles that in humans; that is, there is a relative paucity of activities during the fetal period and more or less rapid development of enzymes postnatally. However, use of animal data for chemical risk extrapolation is hampered by known differences in enzymatic properties of orthologous enzymes in different species and by lack of comparative information. Future research on developmental expression of transcription factors and other factors regulating xenobiotic-metabolizing enzymes in humans and animals should give new tools and information to risk assessors.

1.14 REFERENCES

- Boutelet-Bochan H, Huang Y, Juchau MR. (1997). Expression of CYP2E1 during embryogenesis and fetogenesis in human cephalic tissues: Implications for the fetal alcohol syndrome. *Biochem. Biophys Res Commun* 238:443-447.
- Burchell B, Coughtrie M, Jackson M, Harding D, Fournel-Gigleux S, Leakey J, Hume R. (1989). Development of human liver UDP-glucuronosyltransferases. *Dev Pharmacol Ther* 13:70-77.
- Burchell B, Ethell B, Coffey M, Findlay K, Jedlitschky G, Soars M, Smith D, Hume R. (In press). Inter-individual variation of UDP-glucuronosyltransferases and drug glucuronidation in man. In: *Variability in Drug Metabolism*, eds., Pacifici GM, Pelkonen O); London: Taylor & Francis, 2001; in press.
- Carpenter SJ, Lasker JM, Raucy JL. (1996). Expression, induction, and catalytic activity of the ethanol-inducible cytochrome P450 (CYP2E1) in human fetal liver and hepatocytes. *Mol Pharmacol* 49:260-268.
- Carrier O, Pons G, Rey E, Richard M-O, Moran C, Badoual J, Olive G. (1988). Maturation of caffeine metabolic pathways in infancy. *Clin Pharmacol Ther* 44:145-151.
- Cazeneuve C, Pons G, Rey E, Treluyer J-M, Cresteil T, Thiroux G, D'athis P, Olive G. (1994). Biotransformation of caffeine in human liver microsomes from fetuses, neonates, infants and adults. *Br J Clin Pharmacol* 37:405-412.
- Chianale J, Dvorak C, Farmer DL, Michaels L, Gumucio JJ. (1988). Cytochrome P-450 gene expression in the functional units of the fetal liver. *Hepatology*.8: 318-326.
- Cresteil T, Beaune P, Kremers P, Celier C, Guengerich FP, Leroux JP. (1985). Immunoquantification of epoxide hydrolase and cytochrome P-450 isozymes in fetal and adult human liver microsomes. *Eur J Biochem* 151: 345-350.
- Gillam EMJ, Wunsch RM, Ueng Y-F, Shimada T, Reilly PEB, Kamataki T, Guengerich FP. (1997) Expression of cytochrome P450 3A7 in *Escherichia coli*: Effects of 5' modification and catalytic characterization of recombinant enzyme expressed in bicistronic format with NADPH-cytochrome P450 reductase. *Arch Biochem Biophys* 346:81-90.
- Gonzalez FJ. (1992). Control of constitutively-expressed developmentally-activated rat hepatic cytochrome genes. *Keio J. Med.* 41:68-75.
- Gonzalez FJ, Lee Y-H. (1996). Constitutive expression of hepatic cytochrome P450 genes. *FASEB J*.10:1112-1117.
- Gow PJ, Ghabrial H, Smallwood RA, Morgan DJ, Ching MS. (2001). Neonatal hepatic drug elimination, *Pharmacol Toxicol* 88:3-15.
- Greuet J, Pichard L, Bonfils C, Domergue J, Maurel P. (1996). The fetal specific gene CYP3A7 is inducible by rifampicin in adult human hepatocytes in primary culture. *Biochem. Biophys. Res. Commun* 225:689-694.
- Gu J, Su T, Chen Y, Zhang QY, Ding X. (2000). Expression of biotransformation enzymes in human fetal olfactory mucosa: potential roles in developmental toxicity. *Toxicol Appl Pharmacol* 165:158-162.
- Guengerich FP. (1995). Cytochromes P450 of human liver. Classification and activity profiles of the major enzymes. In: *Advances in Drug Metabolism in Man*, eds. Pacifici GM, Fracchia GN, European Commission. Office for the Official Publications of the European Communities, Luxembourg. pp. 179-231.

- Hakkola J, Pasanen R, Purkunen S, Saarikoski S, Pelkonen O, Maenpaa J, Rane A, Raunio H. (1994). Expression of xenobiotic metabolising cytochrome P450 forms in human adult and foetal liver. *Biochem Pharmacol* 48:59-64.
- Hakkola J, Pasanen M, Pelkonen O, Hukkanen J, Evisalmi S, Anttila S, Rane A, Mäntylä M, Purkunen R, Saarikoski S, Tooming M, Raunio H (1997) Expression of CYP1B1 in human adult and fetal tissues and differential inducibility of CYP1B1 and CYP1A1 by Ah receptor ligands in human placenta and cultured cells. *Carcinogenesis* 18:391-397.
- Hakkola J, Pelkonen O, Pasanen M, Raunio H. (1998). Xenobiotic-metabolizing cytochrome P450 enzymes in the human feto-placental unit: role in intrauterine toxicity. *Crit Rev Toxicol* 28:35-72.
- Hakkola J, Raunio H, Purkunen S, Saarikoski S, Vähäkangas K, Pelkonen O, Edwards RJ, Boobis AR, Pasanen M. (In press). Cytochrome P450 3A expression in the foetal liver. Evidence that CYP3A5 is expressed in only a limited number of fetal livers. *Biol Neonate* 2001; in press.
- Hakkola J, Tanaka E, Pelkonen O (1998). Developmental expression of Cytochrome P450 Enzymes in the Human Liver. *Pharmacol Toxicol* 82:209-217.
- Ingelman-Sundberg M, Johansson I. (1995). The molecular genetics of the human drug metabolizing cytochrome P450s. In: *Advances in drug metabolism in man*. Eds. Pacifici GM, Fracchia GN, Office for Official Publications of the European Communities, Luxembourg pp. 534-585.
- Jones SM, Boobis AR, Moore GE, Stanier PM. (1992). Expression of CYP2E1 during human fetal development: methylation of the CYP2E1 gene in human fetal and adult liver samples. *Biochem Pharmacol* 43:1876-1879.
- Juchau MR, Boutelet-Bochan H, Huang Y. (1998). Cytochrome-P450-dependent biotransformation of xenobiotics in human and rodent embryonic tissues. *Drug Metab Rev* 30:541-568.
- Juchau MR, Chao ST, Omiecinski CJ. (1980). Drug metabolism by the human fetus. *Clin Pharmacokin* 5:320-339.
- Kearns GL. (1995). Pharmacogenetics and development: are infants and children at increased risk for adverse outcomes? *Curr Opin Pediatr* 7:220-233.
- Kitada M, Kamataki T. (1994). Cytochrome P450 in human fetal liver: Significance and fetal specific expression. *Drug Metab Rev* 26:305-323.
- Kitada M, Kamataki T, Itahashi K, Rikihisa T, Kato R, Kanabuko Y. (1985). Purification and properties of cytochrome P-450 from homogenates of human foetal livers. *Arch Biochem Biophys* 241:275-280.
- Kitada M, Kamataki T, Itahashi K, Rikihisa T, Kanakubo Y. (1987a). Significance of cytochrome P-450 (P-450 HFLa) of human fetal livers in the steroid and drug oxidations. *Biochem Pharmacol* 36:453-456.
- Kitada M, Kamataki T, Itahashi K, Rikihisa T, Kanakubo Y. (1987b). P-450 HFLa, a form of cytochrome P-450 purified from human fetal livers, is the 16 α -hydroxylase of dehydroepiandrosterone 3-sulfate. *J Biol Chem* 262:13534-13537.
- Kitada M, Taneda M, Itahashi K, Kamataki T (1991). Four forms of cytochrome P-450 in human fetal livers: purification and their capacity to activate promutagens. *Jpn J Cancer Res* 82:426-432.
- Kitamura R, Sato K, Sawada M, Itoh S, Kitada M, Komori M, Kamataki T. (1992). Stable expression of cytochrome P450III λ 7 cDNA in human breast cancer cell line MCF-7 and its application to cytotoxicity testing. *Arch Biochem Biophys* 292:136-140.

- Klinger W. (1996). Biotransformation of drugs and other xenobiotics during postnatal development. *Exp Toxic Pathol* 48 (suppl. 1):1-88.
- Komori M, Nishio K, Fujitani T, Ohi H, Kitada M, Mima S, Itahashi K, Kamataki T. (1989a). Isolation of a new human fetal liver cytochrome P450 cDNA clone: evidence for expression of a limited number of forms of cytochrome P450 in human fetal livers. *Arch Biochem Biophys* 272:219-225.
- Komori M, Nishio K, Ohi H, Kitada M, Kamataki T. (1989b). Molecular cloning and sequence analysis of cDNA containing the entire coding region for human fetal liver cytochrome P-450. *J Biochem* 105:161-163.
- Komori M, Nishio K, Kitada M, Shiramatsu K, Muroya K, Soma M, Nagashima K, Kamataki T. (1990). Fetus-specific expression of a form of cytochrome P-450 in human livers. *Biochemistry* 29:4430-4433.
- Lacroix D, Sonnier M, Moncion A, Cheron G, Cresteil T. (1997). Expression of CYP3A in the human liver. Evidence that the shift between CYP3A7 and CYP3A4 occurs immediately after birth. *Eur J Biochem* 247:625-634.
- Ladona MG, Lindström B, Thyr C, Dun-Ren P, Rane A (1991). Differential foetal development of the O- and N-demethylation of codeine and dextromethorphan in man. *Br J Clin Pharmacol* 32:295-302.
- Leeder JS, Kearns GL. (1997). Pharmacogenetics in pediatrics. Implications for practice. *Pediatr Clin North Am.* 44:55-77.
- Li Y, Yokoi T, Kitamura R, Sasaki M, Gunji M, Katsuki M, Kamataki T. (1996). Establishment of transgenic mice carrying human fetus-specific CYP3A7. *Arch Biochem Biophys* 329:235-240.
- McLeod HL, Krynetski EY, Wilimas JA, Evans WE. (1995). Higher activity of polymorphic thiopurine S-methyltransferase in erythrocytes from neonates compared to adults. *Pharmacogenetics* 5:281-286.
- Mäenpää J, Rane A, Raunio H, Honkakoski P, Pelkonen O. (1993). Cytochrome P450 isoforms in human fetal tissues related to phenobarbital-inducible forms in the mouse. *Biochem Pharmacol* 45:899-907.
- Murray, GI, Foster CO, Barnes TS, Weaver RJ, Snyder CP, Ewen SWB, Melvin WT, Burke MD. (1992). Cytochrome P450IA expression in adult and fetal human liver. *Carcinogenesis* 13:165-169.
- Nebert DW. (1991). Proposed role of drug-metabolising enzymes: Regulation of steady-state levels of the ligands that effect growth, homeostatis, differentiation, and neuroendocrine functions. *Mol Endocrinol* 5:1203-1214.
- Nelson DR, Koymans L, Kamataki T, Stegeman JJ, Feyereisen R, Waxman DJ, Waterman MR, Gotoh O, Coon MJ, Estabrook RW, Gunsalus IC, Nebert DW. (1996). P450 superfamily: update on new sequences, gene mapping, accession numbers and nomenclature. *Pharmacogenetics* 6:1-42.
- Omicinski CJ, Aicher L, Swenson L. (1994). Developmental expression of human microsomal epoxide hydrolase. *J Pharmacol Exp Ther* 269:417-423.
- Omicinski CJ, Redlich CA, Costa P. (1990). Induction and developmental expression of cytochrome P450IA1 messenger RNA in rat and human tissues. *Cancer Res* 50:4315-4321.
- Pacifici GM, Back DJ, Orme ML. (1988). Sulphation and glucuronidation of paracetamol in human liver: assay conditions. *Biochem Pharmacol* 37:4405-4407.
- Pacifici GM, Franchi M, Giuliani L. (1990). Development of glucuronyltransferase and sulphotransferase toward 2-naphthol in human fetus. *Dev Pharmacol Ther* 14:108-114.
- Pacifici GM, Kubrich M, Giuliani L, de Vries M, Rane A. (1993). Sulphation and glucuronidation of ritodrine in human foetal and adult tissues. *Eur J Clin Pharmacol* 44:259-264.

- Pacifici GM, Santerini S, Giuliani L, Rane A. (1991). Thiol methyltransferase in humans: development and tissue distribution. *Dev Pharmacol Ther* 17:8-15.
- Pariante-Khayat A, Pons G, Rey E, Richard MO, D'Athis P, Moran C, Badoual J, Olive G. (1991). Caffeine acetylator phenotyping during maturation in infants. *Pediatr Res* 29:492-495.
- Pelkonen O. (1980). Biotransformation of xenobiotics in the fetus. *Pharmacol Ther* 10:261-281.
- Pelkonen O, Taavitsainen P, Rautio A, Raunio H, Mäenpää J. (1998). Inhibition and induction of human cytochrome P450 (CYP) enzymes. *Xenobiotica* 28:1203-1253.
- Peng D, Birgersson C, von Bahr C et al. (1984) Polymorphic acetylation of 7-aminoclonazepam in human liver cytosol. *Pediatr Pharmacol* 4:155.
- Rane A, Henningson S, Ask B, Ladona MG. (1992). Comparison of human fetal hepatic and adrenal cytochrome P450 activities with some major gestational steroids and ethylmorphine as substrates. *J. Steroid. Biochem Molec Biol* 43:335-341.
- Ratanasavanh D, Beaune P, Morel F, Flinois J-P, Guengerich FP, Guillouzo A. (1991). Intralobular distribution and quantitation of cytochrome P-450 enzymes in human liver as a function of age. *Hepatology* 13:1142-1151.
- Raucy JL, Carpenter SJ. (1993). The expression of xenobiotic-metabolizing cytochromes P450 in fetal tissues. *J. Pharmacol Toxicol Meth* 29:121-128.
- Rich KJ, Boobis AR. (1997). Expression and inducibility of P450 enzymes during liver ontogeny. *Microscopy Research and Technique* 39:424-435.
- Ring JA, Ghabrial H, Ching MS, Smallwood RA, Morgan DJ. (1999). Fetal hepatic drug elimination. *Pharmacol Ther* 84:429-445.
- Sakuma T, Kitamura R, Yokoi T, Kamataki T. (1995). Efficient complementary DNA directed expression of human fetal liver cytochrome P450 (CYP3A7) in insect cells using baculovirus. *Arch Biochem Biophys* 11520:22828-4654.
- Schuetz JD, Beach DL, Guzelian PS. (1994). Selective expression of cytochrome P450 CYP3A mRNAs in embryonic and adult human liver. *Pharmacogenetics* 4:11-20.
- Shimada T, Yamazaki H, Mimura M, Wakamiya N, Ueng Y-F, Guengerich FP, Inui Y. (1996). Characterization of microsomal cytochrome P450 enzymes involved in the oxidation of xenobiotic chemicals in human fetal livers and adult lungs. *Drug Metab Dispos* 24:515-522.
- Sonnier M, Cresteil T. (1998). Delayed ontogenesis of CYP1A2 in the human liver. *Eur J Biochem* 251:893-898.
- Steiner E, Von Bahr C, Rane A. (1982). Sulphate and glucuronic acid conjugation of harmol in human fetal and adult liver tissue. *Dev Pharmacol Ther* 5:14-20.
- Treluyer JM, Cheron G, Sonnier M, Cresteil T. (1996). Cytochrome P-450 expression in sudden infant death syndrome. *Biochem Pharmacol* 52:497-504.
- Treluyer JM, Gueret G, Cheron G, Sonnier M, Cresteil T. (1997). Developmental expression of CYP2C and CYP2C-dependent activities in the human liver: in- vivo/in-vitro correlation and inducibility. *Pharmacogenetics* 7:441-452.
- Treluyer JM, Jacqz-Aigrain EJ, Alvarez F, Cresteil T. (1991). Expression of CYP2D6 in developing human liver. *Eur J Biochem* 202:583-588.

- Tukey RH, Strassburg CP. (2000). Human UDP-glucuronosyltransferases: Metabolism, expression and disease. *Annu Rev Pharmacol Toxicol* 40:581-616.
- Umberhauer DR, Martin MV, Lloyd RS, Guengerich FP. (1987). Cloning and sequence determination of a complementary DNA related to human liver microsomal cytochrome P-450 S-mephenytoin 4-hydroxylase. *Biochemistry* 26:1094-1099.
- Umeno M, Song BJ, Kozak C, Gelboin HV, Gonzalez FJ. (1988). The rat P450 IIE1 gene: complete intron and exon sequence, chromosome mapping and correlation of developmental expression with specific 5' cytosine demethylation. *J Biol Chem* 263:4956-4962.
- Vauzelle-Kervroedan F, Rey E, Pariente-Khayat A, Bienvenu T, Badoual J, Olive G, Pons G. (1996). Non-invasive in vivo study of the maturation of CYP IIIA in neonates and infants. *Eur J Clin Pharmacol* 51:69-72.
- Vieira I, Sonnier M, Cresteil T. (1996). Developmental expression of CYP2E1 in the human liver. Hypermethylation control of gene expression during the neonatal period. *Eur J Biochem* 238:476-483.
- Wells PG, Winn LM. (1996). Biochemical toxicology of chemical carcinogenesis. *Crit Rev Biochem Mol Biol* 31:1-40.
- Wrighton SA, Molowa DT, Guzelian PS. (1988). Identification of a cytochrome P-450 in human fetal liver related to glucocorticoid-inducible cytochrome P-450HLp in the adult. *Biochem Pharmacol* 37:3053-3055.
- Wrighton SA, Brian WR, Sari MA, Iwasaki M, Guengerich FP, Raucy JL, Molowa DT, VandenBranden M. (1990). Studies on the expression and metabolic capabilities of human liver cytochrome P450IIIA5 (HLp3). *Mol Pharmacol* 38:207-213.
- Wrighton SA, VandenBranden M. (1989). Isolation and characterization of human fetal liver cytochrome P450HLp2: a third member of the P450III gene family. *Arch Biochem Biophys* 268:144-151.
- Yang, H-YL, Lee QP, Rettie AE, Juchau MR. (1994). Functional cytochrome P4503A isoforms in human embryonic tissues: expression during organogenesis. *Mol Pharmacol* 46:922-928.
- Yang H-YL, Namkung MJ, Juchau MR. (1995). Expression of functional cytochrome P4501A1 in human embryonic hepatic tissues during organogenesis. *Biochem Pharmacol* 49:717-726.

Table 1-1. Postulated Developmental Expression of Individual P450 Forms in the Human Liver

Form		Fetus (1st tri- mester)	Neonate (<4 wks)	Infant (<12 mo)	Child (<15 yrs)	Adult	Principal Stage of Upsurge
CYP1A1	mRNA	+	?	?	?	+	expression low or absent in adult liver
	protein	+	?	?	?	?	
CYP1A2	mRNA	-	+	+	+++	+++	during the first postnatal year
	protein	-	+	+	+++	+++	
CYP2A6	mRNA	-	?	+	++	++	?
	protein	-	?	+	++	++	
CYP2A7	mRNA	-	?	?	?	+	?
	protein	-	?	?	?	?	
CYP2B6/7	mRNA	-	?	++	?	+	?
	protein	-	?	++	?	+	
CYP2C	mRNA	+	++	++	+++	+++	rapid postnatal rise followed by slow maturation during the first year
	protein	?	+	++	+++	+++	
CYP2D6	mRNA	+	++	+	+	+	rapid postnatal rise followed by slow maturation during the first year
	protein	±	+	+	+	+	
CYP2E1	mRNA	±	±	12	++	++	rapid postnatal rise followed by slow maturation during the first year
	protein	±	+		++	++	
CYP3A4	mRNA	+	?	++	+++	+++	during the first postnatal months, possibly overlapping with CYP3A7
	protein	-	?	++	+++	+++	
CYP3A5	mRNA	+	+	+	++	++	?
	protein	+	+	+	++	++	
CYP3A7	mRNA	+++	?	?	?	+	downregulated in the late gestation and postnatally
	protein	+++	?	?	?	-	

Symbols:

- ? unknown
- not detected
- ± possibly present in small quantities
- + present in low level
- ++ present in moderate concentrations
- +++ present in high concentrations

Source: Hakkola et al. 1999.

Table 1-2. Developmental Patterns of Some Drug-metabolizing Enzymes

Enzyme	Known Developmental Pattern in Humans
Phase I enzymes	
CYP2D6	Not present or very low in fetal liver Uniformly present at 1 week of postnatal age About 20% of adult level at 1 month of age Adult levels attained by 3-5 years of age
CYP2E1	Not present or very low in fetal liver. Rapidly increases during first 24 hours after birth. Levels comparable to adults in children 1 to 10 years of age.
CYP3A4	Not present or very low in fetal liver Upsurge during 1 week of age Adult levels reached by 6-12 months of age Adult levels exceeded at 1-4 years of age
CYP3A5	Not present or very low in fetal liver No other information
CYP3A7	Major fetal hepatic form Functional activity approx 30 to 75% of adult levels of CYP3A4
Phase II enzymes	
UGT	Ontogeny is isoform specific Adult activities achieved by 6-18 months of age
SULT	Ontogeny is isoform specific Some activities: fetus>adult Generally, relatively higher than UGTs
NAT2	Some fetal activity present by 16 weeks 100% slow phenotype between birth and 2 months of age Adult phenotype distribution reached by 4-6 months Adult activity by 1-3 years of age

Source: Adapted and updated from Leeder and Kearns, 1997.

Table 1-3. Metabolism of Xenobiotics by CYP3A7

Compound	Activity/Endpoint	Approximate “specific” activity in comparison to CYP3A4 (%)
Testosterone	6 β -hydroxylation	< 20
Dehydroepiandrosterone	16A-hydroxylation	200-300
Midazolam	1' and 4-hydroxylation	10-20
Nifedipine	oxidation	< 10
Erythromycin	N-demethylation	140
Ethylmorphine	N-demethylation	80
R-warfarin	10-hydroxylation	Not known
Aflatoxin B ₁	Metabolic activation	800
Sterigmatocystin	Metabolic activation	100
6-aminochrysin	Metabolic activation	100
2-amino-3-methylimidazo(4,5-f)quinoline (IQ)	Metabolic activation	250
2-amino-6-methylidipyrido-(1,2-a:3',2'-d)imidazole (Glu-P-1)	Metabolic activation	70

Source: Adapted from Hakkola et al. 1998; Kitada et al. 1985, 1992; Yang et al. 1994; Shimada et al. 1996; Lacroix et al. 1997; Gillam et al. 1997.

Table 1-4. Glucuronidation of Several Substances in Human Fetal Liver *In Vitro*

Substrate	Activity (compared to adult)	Reference¹	Probable UGT Enzyme²
1-Naphthol	<1 %	Leakey et al. 1987	UGT1A6
2-Naphthol	<1 %	Pacifici et al. 1990	
2-Aminophenol	<1 %	Leakey et al. 1987	UGT1A4?
4-Nitrophenol	<1 %	Pelkonen et al. 1971	
4-Methylumbelliferone	<1 %	Burchell 1974	UGT1A6
Bilirubin	<1 %	Kawade and Onishi 1981	UGT1A1
Testosterone	<1 %	Leakey et al. 1987	
Oestriol	<1 %	Burchell 1974	
Androsterone	<1 %	Leakey et al. 1987	
Harmol	1-10 %	Tan et al. 1990	
Morphine	1-10 %	Pacifici et al. 1990	UGT2B7
Ritordrine	1-10 %	Pacifici et al. 1993	
Oestrone	30 %	Leakey et al. 1987	
5-Hydroxytryptamine	adult	Leakey et al. 1987	

¹Table is modified from Ring et al. (1999), where the original references can be found.

²Potential assignments based on Burchell et al. (2001).

Table 1-5. Sulfotransferase Activity Toward Several Substrates in Human Fetal Liver

Substrate	Activity (compared to adult)	Reference ¹
P-Phenolsulfotransferase (P-PST)		
4-Nitrophenol	<adult	Cappiello et al. 1991
Paracetamol		Pacifici et al. 1988a
1-Naphthol		Gilissen et al. 1994
2-Naphthol		Cappiello et al. 1990
N-hydroxy-4-aminobiphenyl		Gilissen et al. 1994
N-hydroxy-4-acetylamino-biphenyl		Gilissen et al. 1994
M-Phenolsulfotransferase (M-PST)		
Dopamine	>adult	Cappiello et al. 1991
Ritodrine		Pacifici et al. 1993
Hydroxysteroid sulfotransferase		
Dehydroepiandrosterone	< adult; increases during gestation	Forbes et al. 1995
Androsterone		Forbes et al. 1995
Pregnenolone		Forbes et al. 1995
Testosterone		Forbes et al. 1995
Cortisol		Forbes et al. 1995
17a-Ethinylestradiol		Forbes et al. 1995
Estrogen sulfotransferase		
Estrogen		Forbes-Bamforth and Coughtrie 1994

¹Table is modified from Ring et al. (1999), where the original references can be found.

Table 1-6. Human Teratogens That Are Also Substrates for CYP Enzymes

Compound	Principal defect	Principal CYP form involved
Androgens	Masculinization	CYP3A4(?)
Benzene		CYP2E1
Carbamazepine	Neural tube defects	CYP3A4(?)/CYP2C9
Chlorinated biphenyls	Cola baby syndrome	?
Cyclophosphamide	Multiple	CYP3A4(?)
Diethylstilbestrol	Vaginal adenocarcinoma	CYP3A4(?)
Ethanol	Fetal alcohol syndrome	CYP2E1
Methylmercury	CNS lesions	?
Phenytoin	Fetal hydantoin syndrome	CYP2C9(8?)
Retinoic acid	Craniofacial abnormalities	CYP2C8
Thalidomide	Phocomelia	?
Valproic acid	Neural tube defects	?
Warfarin	Saddle nose	CYP2C9(8?)

Source: Hakkola et al. 1998. Data adapted and updated from Juchau et al. 1992, Park et al. 1995, and Wells et al. 1996.

2.0 ISSUE AREA 2: RELATIVE TISSUE DISTRIBUTION AND EXCRETION CAPACITIES IN INFANTS, CHILDREN, AND THE UNBORN

2.1 INTRODUCTION

2.1.1 Quantitative Description of Physiological Changes

In a fully developed organism, ADME (absorption, distribution, metabolism, and excretion) kinetics of drugs and environmental chemicals is governed mainly by chemical-specific physicochemical parameters (such as partition coefficients and tissue protein binding). However, in developmental toxicology the uptake and distribution of chemicals within the target tissue are affected by the rapid and pronounced anatomical and physiological changes that take place during pregnancy and maturation. Therefore, both tissue distribution and the internal dose of chemicals change over time, often in a nonlinear fashion. These nonlinear changes, inherent to developmental toxicology, can be best addressed by physiologically based pharmacokinetic (PB/PK) modeling (Bruckner 2000). PB/PK models of developmental toxicants must take into account changes in physiological parameters occurring during pregnancy, lactation and fetal/neonatal development. The parameters that are most affected by these changes are: (1) body weights, (2) maternal tissue and fluid volumes, (3) weight of the embryo/fetus/infant and volume of its developing organs, (4) metabolic clearance, (5) pulmonary ventilation, (6) cardiac output, (7) renal function, and (8) maternal intestinal motility.

The majority of PB/PK models described in the peer-reviewed literature were developed in rodents and predict internal doses in the rat and mouse fetus (O'Flaherty 1994). Recently, two PB/PK models have been developed and validated in primates and humans for the developmental neurotoxicant methylmercury (MeHg) (Clewell et al. 1999, Byczkowski and Lipscomb 1999).

2.1.2 Published PK Models

Published PK models that address physiological changes during some developmental stages were recently reviewed by Dorman et al. (2001). A number of PB/PK models designed to model tissue distribution of various chemicals in animals during pregnancy have been reported in the peer-reviewed literature (Fisher et al. 1989, Clarke et al. 1993, Gray 1995, Terry et al. 1995, Ward et al. 1997, O'Flaherty et al. 1992, Clewell et al. 1999). For example, O'Flaherty et al. (1992) developed a PB/PK model for 5,5'-dimethyloxazolidine-2,4-dione (DMO) and calibrated it in the pregnant rat and mouse. The model accounted for physiological changes that occur throughout gestation. This PB/PK model accurately simulated DMO levels in embryo plasma and embryo homogenate on gestational days 10, 11, and 13 following the maternal exposure. More sophisticated models simulated levels of active toxicant within various tissues of the conceptus or infant (e.g., in brain, in the case of MeHg, Clewell et al. 1999, Byczkowski and Lipscomb 1999). Similarly, lactational transfer in rats and humans has been modeled successfully for certain volatile organic chemicals (VOCs) (Byczkowski et al. 1994, Fisher et al. 1997). Fisher et al. developed a PB/PK model for lactating women that estimated the amount of certain VOCs

(trichloroethylene – TCE) ingested by a nursing infant for a given nursing schedule following maternal occupational exposure. Important features of the model included a milk compartment that changed in volume in response to the nursing infant. Another PB/PK model for lactational transfer, this one for a potentially carcinogenic VOC (perchloroethylene – PERC), has been successfully applied to cancer risk assessment in nursing infants of occupationally exposed mothers (Byczkowski 1996).

2.1.3 Modeling Lead Exposures in Growing Children

2.1.3.1 Descriptive PK Model

The EPA has developed a descriptive, “integrated exposure uptake biokinetic” (IEUBK) model for lead exposure in children, which provides plausible blood lead distributions corresponding to particular combinations of multimedia lead exposure (White et al. 1998). The model was based on a set of equations that convert lead intake (expressed as micrograms per day) to blood lead concentration (expressed as micrograms per deciliter) by quantitatively following the biokinetic processes that determine blood lead concentration. Amounts of lead absorbed were modeled independently for air, food, water, and soil/dust, then combined as a single input to the blood plasma reservoir of the body. Lead in the blood plasma reservoir was mathematically allocated to all tissues of the body using age-specific biokinetic parameters. The model calculation provided an age-specific estimate for blood lead concentration (initially up to 6 years). Either the geometric mean of possible values for a single child, or the geometric mean of expected values for a population of children exposed to the same lead concentrations, may be obtained. The distribution of blood lead concentrations around this geometric mean was estimated using a geometric standard deviation (typically 1.6) derived from the analysis of well-conducted community blood studies (White et al. 1998).

2.1.3.2 Predictive PK Model

A predictive, physiologically based model of lead kinetics in children and adults has been developed and tested by O’Flaherty (1998). Because 95 percent or more of the body burden of lead in adults is found in the bone, bone metabolism was central to this model. Bone volumes were expressed as functions of body weight. Bone formation and resorption rates were estimated from human studies of stable labeled calcium kinetics. Cortical and trabecular bone were modeled separately, with their surface-to-volume ratios taken into account. Standardized growth curves were used to relate body weight to age. Other model features, such as organ volumes and physiological functions, were related to the body weight, based on measurements made in human subjects over a range of ages. The model outputs were shown to be compatible with those generated by the IEUBK model (O’Flaherty 1998).

2.2 PB/PK MODELING OF DIFFERENT STAGES IN HUMAN DEVELOPMENT

An example of a PB/PK model that addresses physiological changes during pregnancy and lactation is schematically presented in Figure 2-1, drawing on a PB/PK model for MeHg (Byczkowski and Lipscomb 1999). In this model, most of the physiological parameters were scaled according to the body weight. In other words, all tissue volumes and blood flow rates were linked to body weight by means of growth functions that reproduced physiological measurements (U.S. EPA 1988). Similarly, infant breast milk intake was expressed as a function of the age-dependent, growing body weight. Different body weight growth curves were used for male and female infants (Byczkowski and Lipscomb 1999). Analogously, some other physiological functions also may require different scaling in males and females, even after body weight has been taken into account (O'Flaherty 1998).

2.2.1 Pregnancy Models

A PB/PK model for MeHg in the pregnant rat and its fetus has been developed by Gray (1995). Essentially this rodent model was a conventional, 14-compartment, diffusion-limited PB/PK model, featuring brain, hepatobiliary recirculation, placenta, and fetus. The cell membrane, blood-brain barrier, and maternal/fetal placental barrier were assumed to be the primary limitations to the distribution of MeHg in the pregnant rat and fetus. Five individual fetal organs were modeled, including the fetal brain. Model results compared well with experimental data, indicating that the model could be used to predict maternal or fetal organ MeHg concentrations for many dosing regimes. Important features of Gray's PB/PK model were the description of linear tissue binding of Hg and the algorithms for MeHg diffusion across the membrane barriers. Gray's model also incorporated two important improvements over the previous Farris et al. (1993) model for a growing rat. First, Gray introduced a separate compartment for red blood cells (RBC). Second, Gray's model includes a pharmacokinetic description of the fetoplacental system. However, Gray's model did not address the kinetics of mercury transport between blood/plasma and milk.

Gargas et al. (2000) have developed another successful PB/PK model, this one for ethylene glycol monomethyl ether and its metabolite, 2-methoxyacetic acid. They have applied an approach described previously by Fisher et al. (1989) for TCE disposition in the pregnant rat. Their approach was to include the developing fetuses and the placental tissue in a "richly perfused" compartment, and to include the mammary tissue into the "fat" compartment. This simplification was based on the observation that concentrations of 2-methoxyacetic acid in rat fetuses were proportional (or nearly identical to) maternal rat blood concentrations or maternal richly perfused tissues, following both oral and intravenous administration of glycol monomethyl ether or 2-methoxyacetic acid (Gargas et al. 2000).

Currently, one of the best PB/PK models for gestational transfer of MeHg in humans, and one of and most applicable for risk analysis, is a model originally developed by Gearhart et al. (1995, 1996) and reparameterized by Clewell et al. (1999). However, while this model adequately describes the

transplacental transfer of MeHg, it does not address lactational transfer. However, this model was recently used as a template for development of the comprehensive MeHgLac PB/PK model by Byczkowski and Lipscomb (1999), which simulates both pregnancy and lactation.

2.2.1.1 *Changes in Maternal Pharmacokinetics During Pregnancy*

In Fisher et al.'s PB/PK model for TCE (and its metabolite trichloroacetic acid), changes in mammary, placental and fetal tissue volumes during pregnancy were accounted for using empirical equations describing growth of the various compartments over the duration of pregnancy (1989). These changes were encoded in the PB/PK model's tables of physiological parameters, which contain arrays derived from the body weight regression line. Similarly, in the PB/PK model by Clewell et al. (1999), these changes were described by growth functions linked with the duration of pregnancy.

Duration of pregnancy is one of the crucial physiological factors that complicates interspecies allometric scaling of other parameters in the PB/PK model. Another complicating factor is the activity of hepatic microsomal drug-metabolizing enzymes, which increase during human pregnancy, leading to an increase in hepatic clearance of certain drugs and chemicals (Tanaka 1999). Conversely, activity of hepatic microsomal metabolizing enzymes in rats decreases during gestation to approximately 50 percent of the control levels (Oesterheld 1998). However, the total metabolic capacity of the rat liver may remain constant or even increase during pregnancy because of hypertrophy leading to increased (~ 40 percent) liver weights in pregnant rats (Symons et al. 1982).

2.2.1.2 *Transplacental Transfer*

Most of the chemicals that can affect the conceptus after maternal exposure gain access to the developing tissues either through the yolk sac at the early stage of pregnancy, or later through the placenta (Mihaly and Morgan 1984, Hakkola et al. 1998), although some chemical exposure can occur even pre-implantation. Transplacental transfer of chemicals was reviewed by Pelkonen (1985).

Factors that influence the rate of chemical transfer across the placenta are the thickness and surface area of the placental membrane, placental blood flow, molecular size and lipid solubility of the chemical, plasma protein binding of the chemical, and pH of the maternal and fetal circulation (Pratt 1990). Most chemicals cross the placenta by passive diffusion, in accordance with their solubility characteristics and concentration gradient (Morgan 1997). Low-molecular-weight lipophilic chemicals (including many pesticides) are fully capable of crossing the placental membranes, and their rate of transfer is limited by placental blood flow (flow-limited transfer). The flow-limited transplacental transfer of anticholinesterase pesticides has been well documented in the peer-reviewed literature (Ackerman and Engst 1970, Budreau and Singh 1973, Harbison 1975, Strother and Wheeler 1980, Berge and Nafstad 1986, Hunter et al. 1999). In contrast, high-molecular-weight (> 1000 Daltons) or ionized hydrophilic compounds cross the placenta very poorly or not at all, depending on their molecular radii and the presence or absence of charged functional groups (membrane-limited transfer), and the permeability of

the membranes determines the rate of transfer (diffusion-limited transfer). Some xenobiotics may be more readily transported across the placenta during late gestation than during early gestation. Factors that contribute to increased placental transport during late gestation may include elevated unbound fraction in maternal circulation, enhanced uteroplacental blood flow, increased placental surface area, and acidic fetal circulation capable of trapping basic compounds (conversely, acidic compounds may accumulate in the alkaline milieu of the early embryo).

2.2.1.3 Fetal Pharmacokinetics

In the most comprehensive PB/PK model for gestational transfer of MeHg in humans (Clewell et al. 1999), the module for the fetus consists of four compartments, growing during the time of gestation according to the time-dependent growth algorithms for fetal body weight of humans. The at-term amounts of MeHg present in these four fetal compartments at the time of parturition were subsequently used in the infant module developed by Byczkowski and Lipscomb (1999) as the initial amounts for neonatal compartments.

2.2.2 Neonatal Models

Essentially, the neonate may be described by the same pharmacokinetic compartments as an adult, except that the tissue volumes must be linked to the increasing body weight by an appropriate growth function. The neonate module may be simplified by lumping several compartments, especially when not enough experimental data are available to calibrate all tissue compartments. On the other hand, it may sometimes be necessary to expand the conventional PB/PK model to account for specific tissue compartments that behave differently in the newborn than in adults (e.g., the gastrointestinal tract in the PB/PK model for lactational transfer of PERC; Byczkowski et al. 1994).

2.2.2.1 Lactational Transfer

In most species studied, a selective blood-milk barrier for the mammary ducts exists. A variety of factors are known to affect the entry of compounds into breast milk, including molecular size, lipophilicity, and pH (Wilson et al. 1980, 1985). The transfer of drugs, chemicals, and some nutrients from blood to the milk occurs via transport mechanisms analogous to those that operate in other membranes (Byczkowski et al. 1994a). Such transport mechanisms include (1) diffusion through water-filled pores, (2) diffusion of lipid-soluble compounds through lipid membranes, and (3) active, or carrier-mediated, transport. Passive diffusion is affected mainly by the blood plasma chemical concentration in lactating mothers, the physicochemical properties of the chemical, and the protein and lipid content of breast milk.

In general, lipophilic chemicals penetrate membrane barriers easily and are preferentially concentrated in the milk fat globules, which can lead to development of a high concentration ratio of the chemical between milk and blood plasma. Since lipophilic compounds partition into fat, the fat content of

breast milk is a major determinant of the chemical level in whole milk. The concentration of fat and other nutrients in the milk varies among species and period of lactation. Mature human milk contains approximately 3.2 to 3.6 percent fat. The pKa of a weak acid or base is a primary determinant of its ability to enter breast milk. The pH of breast milk is generally around 7.0 in the human; therefore, breast milk is more acidic than plasma. Thus, basic compounds are often trapped in the milk and may reach higher concentrations there, while acidic compounds are reabsorbed into blood, resulting in lower concentrations in milk. Breast milk can be considered as a compartment with bidirectional transfer rather than as a reservoir in which drugs accumulate. Lactational transfer of both MeHg and inorganic mercury has been described in mice by Sundberg et al. (1998) using a simplified three-compartment linear pharmacokinetic model. Although this model has been found useful for developing a quantitative description of the blood/plasma-milk pharmacokinetics in mice, its applicability for human modeling seems to be limited.

In a comprehensive model by Byczkowski and Lipscomb (1999), the breast milk compartment was described as a fraction of the rapidly perfused compartment, with 10 percent of the rapid blood flow being equilibrated with milk (see Figure 2-2). It has been assumed that a constant volume of milk, equal to the 1-hour initial yield, is always present in the mammary glands throughout the lactation period (Byczkowski et al. 1994) and is in continuous rapid equilibrium with maternal blood plasma. Physiological parameters that were needed to describe lactational transfer in the PB/PK model of Byczkowski and Lipscomb (1999) are listed in the Appendix (Table A2-1).

2.2.2.2 Neonatal Pharmacokinetics

Two important physiological processes that affect pharmacokinetics in newborns and adults are tissue partitioning and xenobiotic metabolism. For some chemicals, the parameters describing these two processes are different in the newborn than in the adult. Hepatic clearance values (CL_H) that reflect metabolism may vary between children and adults for some chemicals, but their ratio is close to 1.0 for highly metabolized chemicals, such as the VOCs (Pelekis et al. 2000). Analogously, age-related differences in tissue lipid content and water composition (i.e., the determinants of the blood/tissue partitioning of xenobiotics) seem to be insignificant for VOCs (Pelekis et al. 1995), even though newborn tissues contain more water than adult tissues do. The calculated partition coefficients for VOCs in children remained within the range of normal interindividual variability for the respective partition coefficients in adults (Pelekis, personal communication).

2.2.2.3 Metabolic Clearance

Establishing whether metabolic clearance is qualitatively and quantitatively similar among different species is important when making interspecies extrapolations in PB/PK modeling. For example, differing susceptibilities of various inbred mouse strains and humans to the developmental effects of

phenytoin may involve genetically determined differences in phenytoin biotransformation (Finnell and Chernoff 1987, Buehler 1990), and different sensitivities to retinoid developmental toxicity among species can be attributed, in part, to differences in metabolism (Creech-Kraft 1990). The rates of metabolic activation and deactivation of chemicals are related to the stages of maturation and development of enzyme activity (Besunder et al. 1988). Unless an organ-specific, nonhepatic biotransformation process is known to exist, chemical metabolism is lumped in the liver compartment in PB/PK models.

As with other organs, development of the liver involves a series of integrated structural and functional changes that continue postnatally. This includes tissue cell composition, hepatocyte differentiation, and the appearance of hepatic enzyme activity. After birth, the parenchymatous cells outnumber all other types of cells in the liver (WHO 1986). Another important cell type in the neonatal liver is the hematopoietic cell, as the liver is the site of hematopoiesis prior to birth (Owen 1972). Biotransformation of organic chemicals via phase I and phase II metabolic reactions is generally slower in the neonate than in the adult. Consequently, chemical degradation and elimination via these biotransformation reactions are generally reduced in infants compared with adults. Different isoenzymes and enzymes also mature at different ages. Maturation of mechanisms responsible for the biotransformation of organic chemicals varies for each reaction and chemical (Klinger 1982). Examples of toxicity associated with the newborn's decreased ability to conjugate and eliminate chemicals include chloramphenicol (Sutherland 1959), diazepam (Nau et al. 1984), and hexachlorophene (Tyralla et al. 1977). Since little information exists in the peer-reviewed literature about age-dependent variations of human CL_H or hepatic cytochrome P450 activities (V_{max} and K_m), *in vitro* assays may be useful in establishing the metabolic parameters applicable to PB/PK modeling of chemicals in children (Lipscomb et al. 1998, Snawder and Lipscomb 2000).

2.2.3 Infant Models

The nursing infant module in Byczkowski and Lipscomb's successful and comprehensive PB/PK model for MeHg was composed of six compartments (1999). In addition to the diffusion-limited infant red blood cell compartment, other compartments (also diffusion-limited) were added for hair, brain tissue, and organic and inorganic mercury. Moreover, two flow-limited compartments were added to the lumped "body" compartment (other infant body tissue), namely, kidney and gut. No inorganic mercury was expected to be produced in the infant intestine, since it was assumed that intestinal microflora in the exclusively milk-fed infant do not metabolize MeHg to inorganic mercury. A growth algorithm for human infant body weight was adopted from O'Flaherty (1991), and the breast milk intake algorithm was calibrated with data from Neville et al. (1988). Tissue volumes were scaled in proportion to infant body weight, while blood flow and kinetic parameters were allometrically scaled in proportion to infant body weight raised to the 0.75 power (Clewell et al. 1999).

2.2.3.1 Exposure Routes

The lungs are the major portal of entry for volatile and airborne chemicals. In neonates, the lungs are structurally immature and continue to mature during early childhood. The full complement of mature cells in the lungs is achieved several years after birth (Langston 1983). There is little information available on the pulmonary absorption and bioavailability of inhaled chemicals in infants and children.

Ingestion is a major route by which infants and children are exposed to environmental chemicals. Absorption of chemicals from the gastrointestinal tract is influenced by factors such as the total mucosal surface area, pH, perfusion rate, blood supply, and gastric emptying and intestinal transit times. All of these factors change during postnatal development (WHO 1986). Consequently, the absorption of some chemicals is greater in infants than in adults. For example, lead is absorbed to a greater extent by infants than by adults (Ziegler et al. 1978).

Chemicals also enter the body by absorption through the skin. The ratio of surface area to body weight of children is much greater than that of adults. As such, the total body dermal dose of a chemical can be as much as two to three times greater for a young child, on a per-unit-body-weight basis, than for an adult (Wester and Maibach 1982). EPA's interim report on dermal exposure assessment (U.S. EPA 1992) indicates that this may be the primary difference between adults and children with respect to dermal absorption. Data on childhood or comparable laboratory animal exposures via the dermal route are limited (NRC 1993).

2.2.3.2 Clearance

Children are more vulnerable to the adverse health effects of some chemicals because they have less ability to metabolize and excrete xenobiotics. It has been known for some time that the structure and function of the kidneys are immature at birth (Dean and McCance 1947). This is an important consideration, given that the elimination of most chemicals from the body occurs primarily through renal excretion. Both glomerular and tubular function increase with age in the infant, with glomerular function somewhat more advanced than renal tubular function in the neonate (NRC 1993). Reabsorption of chemicals from the tubular lumen into tubular cells also varies with age. Weak organic acids are more readily reabsorbed by the infant than the adult. Some metals (i.e., cadmium, mercury, and manganese) depend on the kidneys for their elimination. The elimination of these metals by neonatal rats is less than that in adult rats (Kostial et al. 1978). Smaller proportions of absorbed lead are also excreted via the renal route in infants compared with adults (WHO 1986). Because chemical excretion by the kidneys is dependent primarily on glomerular filtration, tubular secretion, and reabsorption, a decrement due to the immaturity of any of these functions in the infant may result in delayed clearance of a chemical from the body. Consequently, the risk of toxicity may increase from the prolonged presence in the body of a chemical or its active metabolite(s) (Braunlich 1981). Unfortunately, at this time, information on age-related differences in elimination of environmental chemicals in experimental animals, let alone in humans, is extremely limited (NRC 1993).

2.2.3.3 Tissue Distribution and Partitioning of Chemical Compounds

Partition coefficients for xenobiotics between air, blood and tissues can be either determined experimentally (Gargas et al. 1989, Jepson et al. 1994) or estimated from physicochemical properties, using solubility of the chemical in lipid and water, and tissue lipid and water composition (Poulin and Krishnan 1995, 1996; Pelekis et al. 1995).

Experimentally, partition coefficients for VOCs and gases may be measured using the vial equilibration method described by Gargas et al. (1989). A convenient filtration method for measuring tissue partition coefficients of nonvolatile chemical compounds was described by Jepson et al. (1994). Both experimental methods require harvesting and preparation of the human tissue, blood and plasma; thus, their usefulness in modeling tissue distributions of developmental toxicants and their application in risk assessments are limited. As a surrogate for human fetal, neonatal or adolescent tissue, the appropriate animal tissue preparations can be used. Since tissue partitioning of chemical compounds is due to lipophilic and hydrophilic interactions with tissue components (Meulenberg and Vijverberg 2000), quantitative empirical relations may also be established using oil (or octanol), saline, and tissue partition coefficients. For VOCs, it has been determined that the regression coefficient associated with the hydrophilic component of VOC partitioning in rat tissues is systematically higher than that in human tissues. For the human model, tissue concentrations calculated from predicted partition coefficients are generally within a factor of 4 of tissue concentrations calculated from experimentally observed partition coefficients. These results demonstrate that even without prior knowledge of tissue composition, it is possible to estimate human tissue partition coefficients of VOCs with an accuracy that was within the same range as that commonly used in risk assessment (Meulenberg and Vijverberg 2000). Predictive modeling of chemical distribution in tissues gave even more realistic results when tissue composition was taken into account (Pelekis et al. 2000).

2.2.4 Sources of Nonlinearities and Discontinuities in PB/PK Models for Children

Normal child development cannot be considered to be a linear function of time. The most obvious on-off discontinuities occur during conception, parturition, lactation, and weaning. Moreover, in addition to nonlinear growth of body mass and organ volumes, the embryo is qualitatively different from the fetus, the fetus is qualitatively different from the neonate, and neonate is different from the older child. Growth and development proceed in stages, causing steps or “jumps” in the quantitative relations between physiological and metabolic parameters, and thus causing discontinuities in PB/PK models.

At certain developmental stages, children may be more vulnerable to specific environmental pollutants because of differences in ADME. For example, elevated rates of gastrointestinal absorption of nitrates in infants, and lead in young children, are well documented. Similarly, percutaneous absorption is elevated during the first few days of life until keratinization of the skin occurs (U.S. EPA 2000c).

2.2.4.1 *Nonallometric Body Weight Changes*

During the first 4 to 6 months of its life, an infant gains weight more rapidly than during the rest of its life (Tanner et al. 1966). Adolescent children are also growing and adding new tissue at a more rapid rate than adults. Because of rapid growth during infancy and puberty, the accumulation of chemicals in the body may be greater than it is during adulthood, when growth is less rapid. Young children have higher resting metabolic and oxygen consumption rates than adults, which are related to the child's rapid growth and larger cooling surface area per unit weight (Hill 1964). Respiratory and circulatory flow rates, as well as energy and fluid requirements, are greater in infants and young children than in adults, giving rise to a greater potential for respiratory and intestinal exposure to chemicals per unit body weight (WHO 1986).

2.2.4.2 *Metabolic Clearance Changes*

Age-related differences in both the rates and the pathways of metabolism affect excretion rate and the half-life of a chemical in the body. Developmental regulation of metabolic pathways can result in the activation and deactivation of a pathway as individuals pass through life stages, affecting internal dosages (Bearer 1995). For example, the exposure of newborns to chloramphenicol resulted in cyanosis, progressive circulatory collapse, and ultimately death, which was attributed to decreased clearance of this chemical (Weiss et al. 1960). Decreased metabolic and excretory capacity of newborns has also been associated with the increased toxicity of other chemicals during the postnatal period. These include the "gaspings syndrome" associated with benzol alcohol-preserved drugs (Gershanik et al. 1982) and neurological damage and death as a result of dermal application of hexachlorophene-contaminated talcum powder (Hay 1982). Cases of infant poisoning and death by hexachlorobenzene have also been reported following ingestion of highly contaminated human milk (Peters 1976).

2.2.4.3 *Adolescent Physiology and Exposure Activity Patterns*

Older children and adolescents have received little attention as special subgroups at risk from exposure to toxic and carcinogenic chemicals (Bruckner and Weil 1999). In addition to being a time of behavioral changes, adolescence is the second most rapid period of growth and development, after infancy. Several organ systems experience substantial structural and functional changes during puberty. Specific diet, exercise, and experimentation with or abuse of "recreational" drugs all affect the disposition and metabolism of chemicals in the body. For these reasons, adolescents are most likely to exhibit aberrant responses to toxicants.

Opportunities available for contact with hazardous substances change with age. Children's exposures to environmental pollutants are often different from those of adults because of different diets and activities, such as playing on floors and in soil and mouthing their hands, toys, and other objects, which can bring them into greater contact with environmental pollutants (Bearer 1995). Children, in particular, may ignore or fail to notice warning signs, find openings in fences, or otherwise gain access to

restricted places on or near a contaminated site. Often, there is considerable variation in exposures received with climate, season, and time of day. Some children display a habit disorder, pica, in which they deliberately ingest soil or other non-food matter that might be contaminated (U.S. EPA 1997).

Because children consume proportionately more food and fluids, have a greater skin surface area relative to their body weight, and breathe more air per unit body weight than adults, they may receive greater exposure to environmental substances. For example, an infant weighs about one-tenth as much as a typical adult, but consumes about one-third as much water daily (Goldman 1995). The diets of infants and young children are very different from adult diets. Certain food types, such as juices, for example, can make up a larger proportion of the child's diet, resulting for instance in a higher exposure to pesticides (NRC 1993).

2.3 CONCLUSIONS

Risk assessment of potential developmental toxicants depends on evaluating the biologically effective dose of drugs or other chemicals that can reach the target organ. In infants, children, and the unborn, the internal dose of chemical ultimately responsible for health effects is different over time, often changing in a nonlinear fashion. These nonlinear changes in tissue distribution, which are inherent in developmental toxicology, require a computational method that can account for changes in the structure and function of the developing organism. From this review of the published pharmacokinetic tools, it seems that PB/PK models are the most successful tools available for improving the existing risk assessment methodologies for the unborn, infants, and children. PB/PK models of developmental toxicants must take into account changes in physiological parameters occurring during pregnancy, lactation, and fetal/neonatal development. The parameters that are most affected by these changes are (1) body weights, (2) maternal tissue and fluid volumes, (3) weight of the embryo/fetus/infant and volume of the developing organs, (4) metabolic clearance, (5) pulmonary ventilation, (6) cardiac output, (7) renal function, and (8) maternal intestinal motility.

2.3.1 General Findings

1. Simple proportionality equations that may approximate relatively well distribution of chemicals in adult organisms under a near steady-state conditions often fail in developing organisms. Normal child development cannot be considered to be a linear function of time. The most obvious on-off discontinuities occur during: conception, parturition, lactation and weaning. Moreover, in addition to nonlinear growth of body mass and organ volumes, the embryo is qualitatively different from the fetus, the fetus is qualitatively different from the neonate, and neonate is different from the older child. Growth and development proceed in stages, causing steps or "jumps" in the quantitative relations between physiological and metabolic parameters, and thus causing discontinuities in PK models.

2. Existing descriptive pharmacokinetic models (e.g., IEUBK model for lead) that account for by developmental nonlinearities describe reliably concentrations of chemicals in blood and certain tissues, but require extensive numerical data base and lack predictive capability, thus, they cannot be used for extrapolations below the exposure doses that were used for their calibration.
3. From published PK models that address physiological changes during some developmental stages the most successful were PB/PK models.
4. The majority of PB/PK models described in the peer-reviewed literature were developed in rodents, and predict internal doses in the rat and mouse fetus.
5. Only a few PB/PK models were validated in primates an/or humans but there is an example of a PB/PK model that has been successfully applied to cancer risk assessment in nursing infants of occupationally exposed mothers.

2.3.2 Specific Findings in Different Age Groups

2.3.2.1 Fetus

A successful PB/PK model for fetus should account for:

- C Changes in maternal pharmacokinetics during pregnancy
- C Transplacental transfer of chemicals
- C Developmental changes in fetal pharmacokinetics

2.3.2.2 Neonates

A successful PB/PK model for the neonate may use the same pharmacokinetic compartments as an adult, except that the tissue volumes must be linked to the increasing body weight by an appropriate growth function. Additionally, the model should account for:

- C Lactational transfer of chemicals
- C Neonatal pharmacokinetics, including changes in tissue lipid and water contents
- C Developmental changes in renal and metabolic clearance

2.3.2.3 Children

A successful PB/PK model for children should account for:

- C Changes in routes of exposure
- C Changes in renal and metabolic clearance
- C Tissue distribution and partitioning of chemical compounds

2.4 REFERENCES

- Ackerman H, Engst R. (1970). Presence of organophosphate insecticides in the fetus. *Arch. Toxicol.* 26:17-22.
- Bearer CF. (1995). How are children different from adults? *Environ. Health Perspect.* 103(Suppl. 6):7-12.
- Berge GN, Nafstad I. (1986). Distribution and placental transfer of trichlorfon in guinea pigs. *Arch. Toxicol.* 59:26-29.
- Besunder JB, Reed MD, Blumer JS. (1988). Principles of drug biodisposition in the neonate. A critical evaluation of the pharmacokinetic-pharmacodynamic interface (Part I). *Clin. Pharmacokinet.* 14:189-216.
- Braunlich H. (1981). Excretion of drugs during postnatal development. *Pharmacol. Ther.* 12:299-320.
- Brown RP, Delp MD, Lindstedt SL, Rhomberg LR, Beliles RP. (1997). Physiological parameter values for physiologically based pharmacokinetic models. *Toxicol. Ind. Health.* 13:407-484.
- Bruckner JV. (2000). Differences in sensitivity of children and adults to chemical toxicity: The NAS panel report. *Regul. Toxicol. Pharmacol.* 31:280-285.
- Bruckner JV, Weil WB. (1999). Biological factors which may influence an older child's or adolescent's responses to toxic chemicals. *Regul. Toxicol. Pharmacol.* 29:158-164.
- Budreau CH, Singh RP. (1973). Transplacental passage of demeton in CF-1 mice. *Arch. Environ. Health.* 26:161-163.
- Buehler BA, Delimont D, Van Waes M, Finnell RH. (1990). Prenatal prediction of risk for the fetal hydantoin syndrome. *N. Engl. J. Med.* 322:1567-1572.
- Byczkowski JZ. (1996). Linked physiologically based pharmacokinetic model and cancer risk assessment for breast-fed infants. *Drug Inf. J.* 30:401-412.
- Byczkowski JZ, Gearhart JM, Fisher JW. (1994). "Occupational" exposure of infants to toxic chemicals via breast milk. *Nutrition* 10:43-48.
- Byczkowski JZ, Kinkead ER, Leahy HF, Randall GM, Fisher JW. (1994). Computer simulation of the lactational transfer of tetrachloroethylene in rats using a physiologically based model. *Toxicol. Appl. Pharmacol.* 125:228-236.
- Byczkowski JZ, Lipscomb JC. (1999). Application of PB/PK model for assessment of the lactational transfer of MeHg to nursing infant. Society for Risk Analysis Annual Meeting, Atlanta, GA, 1999. Final Program P1-17, p. 47. Abstract on-line.
<<http://www.riskworld.com/Abstract/1999/SRAam99/ab9ab047.htm>>.
- Clarke DO, Elswick BA, Welsch F, Conolly RB. (1993). Pharmacokinetics of 2-methoxyethanol and 2-methoxyacetic acid in the pregnant mouse: a physiologically based mathematical Model. *Toxicol. Appl. Pharmacol.* 121:239-252.
- Clewell HJ, Gearhart JM, Gentry PR, Covington TR, VanLandingham CB, Crump KS, Shipp AM. (1999). Evaluation of the uncertainty in an oral reference dose for methylmercury due to interindividual variability in pharmacokinetics. *Risk Analysis* 19:547-558.
- Creech-Kraft J, Slikker W, Bailey JR, Roberts LG, Fischer B, Wittfoht W, Nau H. (1990). Plasma pharmacokinetics and metabolism 13-cis- and all-transretinoyl-glucuronides: a comparison to one humans case study with isotretinoin. *Drug. Metab. Disp.* 19:317-324.

- Dean RFA, McCance RA. (1947). Insulin, iodine, creatinine, and urea clearance in newborn infants. *J. Physiol.* 106:431-439.
- Dorman DC, Allen SL, Byczkowski JZ, Claudio L, Fisher JW, Harry GJ, Li AA, Makris SL, Padilla S, Sultatos LG, Mileson BE. (2001). Methods to identify and characterize developmental neurotoxicity for human health risk assessment: III. Pharmacokinetic and pharmacodynamic considerations. *Environ Health Perspect* 109(suppl 1):101-111.
- Farris FF, Dedrick RL, Allen PV, Smith JC. (1993). Physiological model for the pharmacokinetics of methyl mercury in the growing rat. *Toxicol. Appl. Pharmacol.* 119:74-90.
- Finnell RH, Chernoff GF. (1987). Gene-teratogen interactions. An approach to understanding the metabolic basis of birth defects. In: *Pharmacokinetics in Teratogenesis* (Nau H and Scott WJ, eds.). Boca Raton, Fla.: CRC Press, 97-109.
- Fisher JW, Whittaker TA, Taylor DH, Clewell HJ, Andersen ME. (1989). Physiologically based pharmacokinetic modeling of the pregnant rat: a multiroute exposure model for trichloroethylene and its metabolite, trichloroacetic acid. *Toxicol. Appl. Pharmacol.* 99:395-414.
- Fisher J, Mahle D, Bankston L, Greene R, Gearhart J. (1997). Lactational transfer of volatile chemicals in breast milk. *Am. Indust. Hyg. Assoc. J.* 58:425-431.
- Gargas ML, Burgess RJ, Voisard DE, Cason GH, Anderson ME. (1989). Partition coefficients of low-molecular-weight volatile chemicals in various liquids and tissues. *Toxicol. Appl. Pharmacol.* 97:87-99.
- Gargas ML, Tyler TR, Sweeney LM, Corley RA, Weitz KK, Mast TJ, Paustenbach DJ, Hays SM. (2000). A toxicokinetic study of inhaled ethylene glycolmonomethyl ether (2-ME) and validation of a physiologically based pharmacokinetic model for the pregnant rat and human. *Toxicol. Appl. Pharmacol.* 165:53-62.
- Gearhart JM, Clewell III HJ, Crump KS, Shipp AM, Silvers A. (1995). Pharmacokinetic dose estimates of mercury in children and dose-response curves of performance tests in a large epidemiological study. *Water, Air, and Soil Pollution.* 80:49-58.
- Gearhart J, Covington T, Clewell III H. (1996). Application of a physiologically based pharmacokinetic model for MeHg in a dose reconstruction of the Iraqi accidental exposures. (Paper presented at the Fourth International Conference on Mercury as a Global Pollutant, August 4-8, 1996, Congress Centre, Hamburg, Germany).
- Gershanik J, Boecler B, Ensley H, McCloskey S, George W. (1982). The gasping syndrome and benzyl alcohol poisoning. *N. Engl. J. Med.* 307:1384-1388.
- Goldman L. (1995). Children – unique and vulnerable: environmental health risks facing children and recommendations for response. *Environ. Health Perspect.* 103(6):13-18.
- Gray DG. (1995). A physiologically based pharmacokinetic model for methyl mercury in the pregnant rat and fetus. *Toxicol. Appl. Pharmacol.* 132:91-102.
- Hakkola J, Pelkonen O, Pasanen M. (1998). Xenobiotic-metabolizing cytochrome P450 enzymes in the human fetoplacental unit: role in intrauterine toxicity. *Crit. Rev. Toxicol.* 28(1):35-72.
- Harbison RD. (1975). Parathion-induced toxicity and phenobarbital-induced protection against parathion during prenatal development. *Toxicol. Appl. Pharmacol.* 32:482-493.
- Hay A. (1982). Hexachlorophene. In: *The Chemical Scythe* (Hay E, ed.), New York, NY: Plenum Press, 69-76.

- Hill JR. (1964). The development of thermal stability in the newborn baby. In: *The Adaptation of the Newborn to Extrauterine Life*. The Netherlands: H.E. Stenfert Kroese NV, 223-228.
- Hunter DL, Lassiter TL, Padilla S. (1999). Gestational exposure to chlorpyrifos: Comparative distribution of trichloropyridinol in the fetus and dam. *Toxicol. Appl. Pharmacol.* 158:16-23.
- Jepson GW, Hoover DK, Black RK, McCafferty JD, Mahle DA, Gearhart JM. (1994). A partition coefficient method for non-volatile and intermediate volatility chemicals in biological tissues. *Fund. Appl. Toxicol.* 22:519-524.
- Kostial K, Kello D, Jugo S, Rabar I, Maljkovic T. (1978). The influence of age on metal metabolism and toxicity. *Environ. Health Perspect.* 25:81-86.
- Klinger W. (1982). Biotransformation of drugs and other xenobiotics during postnatal development. *Pharmacol. Ther.* 16:377-429.
- Langston C. (1983). Normal and abnormal structural development of the human lung. In: *Abnormal Functional Development of the Heart, Lungs and Kidneys: Approaches to Functional Teratology* (Kavlock RJ, Grabowski CT, Eds.). New York, NY: Alan R. Liss, 75-91.
- Lipscomb JC, Fisher JW, Confer PD, Byczkowski JZ. (1998). In vitro to in vivo extrapolation for trichloroethylene metabolism in humans. *Toxicol. Appl. Pharmacol.* 152:376-387.
- Meulenberg CJW, Vijverberg HPM. (2000). Empirical relations predicting human and rat tissue:air partition coefficients of volatile organic compounds. *Toxicol. Appl. Pharmacol.* 165:206-216.
- Mihaly GW, Morgan DJ. (1984). Placental drug transfer: Effect of gestational age and species. *Pharmacol. Ther.* 23:253-266.
- Morgan DJ. (1997). Drug disposition in mother and foetus. *Clin. Exp. Pharmacol. Physiol.* 24:869-873.
- Nau H, Luck W, Kuhnz W. (1984). Decreased serum protein binding of diazepam and its metabolite in the neonate during the first postnatal week relate to increased free fatty levels. *Br. J. Clin. Pharmacol.* 17:92-98.
- Neville MC, Keller R, Seacat J, Lutes V, Neifert M, Casey C, Allen J, Archer P. (1988). Studies in human lactation: milk volumes in lactating women during the onset of lactation and full lactation. *Am. J. Clin. Nutr.* 48:1375-1386.
- NRC. (1993). National Research Council. *Pesticides in the Diets of Infants and Children*. Washington DC: National Academy Press.
- Oesterheld JR. (1998). A review of developmental aspects of cytochrome P450. *J. Child. Adolesc. Psychopharmacol.* 8(3):161-174.
- O'Flaherty EJ. (1991). Physiologically based models for bone-seeking elements: III: Human skeletal and bone growth. *Toxicol. Appl. Pharmacol.* 111:332-341.
- O'Flaherty EJ, Scott W, Schreiner C, Beliles RP. (1992). A physiologically based kinetic model of rat and mouse gestation: Disposition of a weak acid. *Toxicol. Appl. Pharmacol.* 112:245-256.
- O'Flaherty EJ. Physiologically based pharmacokinetic models in developmental toxicology. *Risk Analysis* 14: 605-611 (1994).
- O'Flaherty EJ. (1998). A physiologically based kinetic model for lead in children and adults. *Environ. Health Perspect.* 106(Suppl. 6):1495-1503.
- Owen JJT. (1972). The origins and development of lymphocyte populations. In: *Ontogeny of Acquired Immunity*, (Porter R, Knight J, eds.), New York, NY: Elsevier, 35-54.

- Pelekis M, Gephart LA, Lerman SE. (2001). Physiological model-based derivation of the adult and child pharmacokinetic intraspecies uncertainty factors for volatile organic compounds. *Regulat. Toxicol. Pharmacol. J.* 33:12-20.
- Pelekis M, Poulin P, Krishnan K. (1995). An approach for incorporating tissue composition data into physiologically based pharmacokinetic models. *Toxicol. Ind. Health* 11:511-522.
- Pelkonen O. 1985. Fetoplacental Biochemistry – Xenobiotic Metabolism and Pharmacokinetics. In: *Occupational Hazards and Reproduction. International Course, Helsinki, Finland* (Hemminki K, Sorsa M, Vainio H, eds.). Chapter 8. Washington DC: Hemisphere Publishing Corporation, 113-126.
- Peters HA. (1976). Hexachlorobenzene poisoning in Turkey. *Fed. Proc.* 35:2400-2403.
- Poulin P, Krishnan K. (1995). A biologically-based algorithm for predicting human tissue: blood partition coefficients of organic chemicals. *Human Exp. Toxicol.* 14: 273-280.
- Poulin P, Krishnan K. (1996). A tissue composition-based algorithm for predicting tissue:air partition coefficients of organic chemicals. *Toxicol. Appl. Pharmacol.* 136:126-130.
- Pratt WB. (1990). The entry, distribution, and elimination of drugs. In: *Principles of Drug Action*, 3rd edition (Pratt WB, Taylor P, eds.). New York: Churchill Livingstone, 201-296.
- Snawder JE, Lipscomb JC. (2000). Interindividual variance of cytochrome P450 forms in human hepatic microsomes: correlation of individual forms with xenobiotic metabolism and implications for risk assessment. *Regulat. Toxicol. Pharmacol.* 32:200-209.
- Strother A, Wheeler L. (1980). Excretion and disposition of [¹⁴C]carbaryl in pregnant, nonpregnant and foetal tissues of the rat after acute administration. *Xenobiotica* 10:113-124.
- Sundberg J, Jonsson S, Karlsson MO, Hallen IP, Oskarsson A. (1998). Kinetics of methylmercury and inorganic mercury in lactating and nonlactating mice. *Toxicol. Appl. Pharmacol.* 151:319-329.
- Sutherland JM. (1959). Fatal cardiovascular collapse of infants receiving large amounts of chloramphenicol. *J. Dis. Child.* 97:761-767.
- Symons A, Turcan R, Parke D. (1982). Hepatic microsomal drug metabolism in the pregnant rat. *Xenobiotica* 12:365-374.
- Tanaka, E. (1999). Gender-related differences in pharmacokinetics and their chemical significance. *Clin. Pharm. Ther.* 24(5):339-346.
- Tanner JM, Whitehouse RH, Takaishi M. (1966). Standards from birth to maturity for height, weight, height velocity, and weight velocity, Part II British children. *Arch. Dis. Child.* 41:613-635.
- Terry K, Elswick B, Welsch F, Conolly R. (1995). Development of a physiologically based pharmacokinetic model describing 2-methoxyacetic acid disposition in the pregnant mouse. *Toxicol. Appl. Pharmacol.* 132:103-114.
- Tyralla EE, Hillman LS, Hillman RE, Dodson WE. (1977). Clinical pharmacology of hexachlorophene in newborn infants. *J. Pediatr.* 91:481-486.
- U.S. EPA. (1988). U.S. Environmental Protection Agency. Recommendations for and Documentation of Biological Values for Use in Risk Assessment. (February 1988). EPA-600-6-87-008. Reproduced by U.S. Department of Commerce, National Technical Information Service, Springfield, VA. 1988.
- U.S. EPA. (1992). Dermal Exposure Assessment: Principles and Applications. Interim report. Washington DC: U.S. Environmental Protection Agency. Office of Research and Development.

- U.S. EPA. (1997) Exposure Factors Handbook, Volume I - General Factors. Washington DC: U.S. Environmental Protection Agency. (August 1997). EPA-600-P-95-002Fa. Published on-line. <<http://www.epa.gov/ncea/pdfs/efh/front.pdf>> .
- U.S. EPA. (2000). Strategy for Research on Environmental Risks to Children. Washington DC: U.S. Environmental Protection Agency. Office of Research and Development. EPA-6000-R-00-068. Published on-line. <<http://www.epa.gov/nceawww1/risk2kids.htm>>.
- Ward K, Blumenthal G, Welsch F, Pollack G. (1997). Development of a physiologically based pharmacokinetic model to describe the disposition of methanol in pregnant rats and mice. *Toxicol. Appl. Pharmacol.* 145:311-322.
- Weiss CF, Glazko AJ, Weston JK. (1960). Chloramphenicol in the newborn infant: a physiological explanation of its toxicity when given in excessive doses. *N. Engl. J. Med.* 252:787-794.
- Wester RC, Maibach HI. (1982). Percutaneous absorption: neonate compared to the adult. In: *Environmental Factors in Human Growth and Development*, Banbury Report No. 2 (Hunt VR, Smith MK, Worth D, eds.), New York, NY: Cold Spring Harbor Laboratory, 73-84.
- White PD, Van Leeuwen P, Davis BD, Maddaloni M, Hogan KA, Marcus AH, Elias RW. (1998). The conceptual structure of the integrated exposure uptake biokinetic model for lead in children. *Environ. Health. Perspect.* 106(Suppl. 6):1513-1530.
- WHO. (1986). Principles for Evaluating Health Risks from Chemicals During Infancy and Early Childhood: The Need for a Special Approach. *Environmental Health Criteria* 59. Geneva, Switzerland: World Health Organization.
- Wilson JT, Brown RD, Cherek DR, Dailey JW, Hilman B, Jobe PC, Manno BR, Manno JE, Radetzki HM, Stewart JJ. (1980). Drug excretion in human breast milk: principles, pharmacokinetics and projected consequences. *Clin. Pharmacokinet.* 5:1-66.
- Wilson JT, Brown RD, Hinson JL, Dailey JW. (1985). Pharmacokinetic pitfalls in the estimation of the breast milk/plasma ratio for drugs. *Ann. Rev. Pharmacol. Toxicol.* 25:667-689.
- Ziegler EE, Edwards BB, Jensen RL, Mahaffey KR, Fomon SJ. (1978). Absorption and retention of lead by infants. *Pediatr. Res.* 12:29-34.

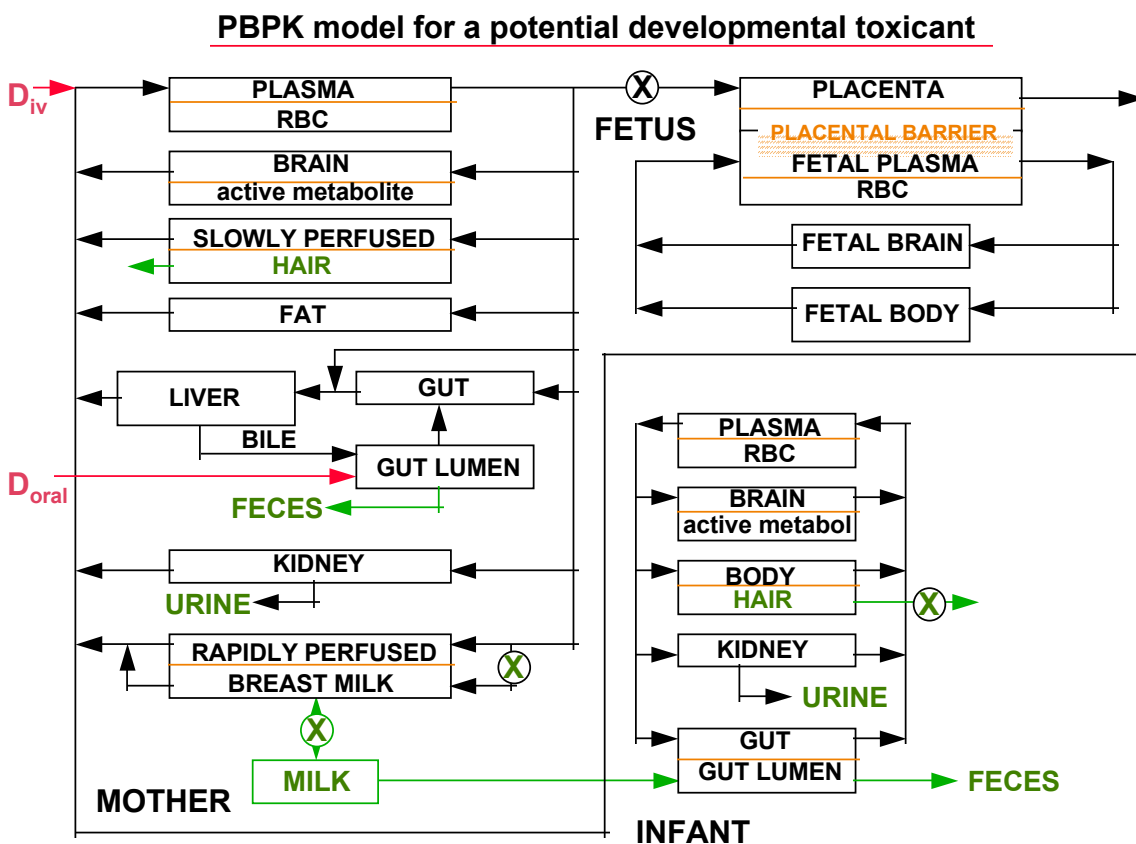

Figure 2-1. A diagram of the conceptual framework for the physiologically based pharmacokinetic (PB/PK) model of gestational/lactational transfer of a potential developmental toxicant from the exposed mother to her nursing infant

Notes: Based on PB/PK model for methylmercury (Byczkowski and Lipscomb 1999). X = time-dependent on-off switches to account for discontinuities; D_{oral} is oral dose rate of chemical (mg/kg/day); D_{iv} is intravenous dose rate of chemical (mg/hr); RBC is red blood cells. Lung compartments for both mother and infant should be added for volatile organic chemicals (Byczkowski and Lipscomb 1999; also <<http://members.spree.com/education/tnproj/PeriPBPK.htm>>).

This page left blank

APPENDIX (AREA 2): PHARMACOKINETICS AND COMPUTER-AIDED QUANTITATIVE MODELING IN DEVELOPMENTAL TOXICOLOGY

A.1 INTRODUCTION

Pharmacokinetic models and biological markers of exposure offer the potential of quantitative dosimeters of the internal dose and/or indices of the health effects associated with fetal/childhood exposures to drugs and other chemical compounds (U.S. EPA 2000c).

A.1.1 Definition of Terms

The term *pharmacokinetics* (PK) refers to the way a drug or a chemical is handled by the body. Pharmacokinetic measures include: area under the curve (AUC), concentration at the maximum (C_{max}) and parameters calculated from those measures, such as clearance (CL), half-life ($t_{1/2}$), and volume of distribution (VD). All of these measures reflect the absorption (A), distribution (D), and elimination (E) of a drug from the body. A drug or other chemical compound can be eliminated by both metabolism (M) to one or more active and inactive metabolites and excretion (EX) of the unchanged drug. The overall set of processes is often referred to as ADME, which ultimately controls the internal dose and systemic exposure of target organs to a chemical and its metabolites after administration (FDA 1998; Anderson 2000).

A.1.2 Factors Leading to Nonlinearities in PK

Specific aspects of the developing anatomy, physiology and metabolism of fetus, infant and child affect pharmacokinetics in a nonlinear fashion (according to FDA 1998). Also, several factors alter an individual's risk for an environmentally related illness (Bearer 1995). A major determinant is the age of the individual. In the pediatric population, growth and developmental changes in factors influencing ADME also lead to changes in pharmacokinetic measures and/or parameters (Rane and Wilson 1976). Among the characteristics leading to children's sensitivity to certain chemicals are their limited diets, dividing cells, differentiating organs and organ systems, slow or absent detoxification mechanisms, long life expectancy with the resulting ability to express damage with delayed consequences, and the severe metabolic demands of growth (FDA 1998). The pharmacokinetic and toxicodynamic (TD) processes that determine exposure, absorption, metabolism, excretion, and tissue vulnerability are all age related (Bearer 1995).

A.1.2.1 Absorption

Developmental changes in the pediatric population that can affect absorption include effects on gastric acidity, rates of gastric and intestinal emptying, surface area of the absorption site, gastrointestinal enzyme systems for drugs that are actively transported across the gastrointestinal mucosa, gastrointestinal permeability, and biliary function (FDA 1998). Similarly, developmental changes in skin, muscle, and fat,

including changes in water content and degree of vascularization, can affect absorption patterns of drugs delivered via intramuscular, subcutaneous, or percutaneous absorption (Yaffe and Aranda 1992).

Gastric pH is neutral at birth, but drops to 1-3 within hours of birth. Gastric acid secretion then declines on days 10-30, and does not approach adult values until approximately 3 months of age. The increased bioavailability of penicillins in the newborn has been attributed to lower levels of gastric acid secretion (FDA 1998). Gastric emptying is delayed and irregular in the newborn, but approaches adult values by 6-8 months. Intestinal motility is also irregular, and highly dependent on feeding patterns in newborn. The decreased gastrointestinal (GI) motility in newborns can delay drug absorption and result in lower peak plasma drug concentrations, but does not alter overall bioavailability of most drugs. GI transit time may be increased in children. The absorptive surface area relative to body surface area is greater in infants and children than in adults. The newborn intestine is colonized with bacteria within days of birth, but the spectrum of bacterial flora may change over the first few years of life (Balis 2000).

A.1.2.2 Distribution

Distribution of a drug may be affected by changes in body composition, such as changes in total body water and adipose tissue, that are not necessarily proportional to changes in total body weight (FDA 1998). Plasma protein binding and tissue binding changes arising from changes in body composition with growth and development may also influence distribution (Gilman 1990).

Factors that affect drug distribution include: physicochemical properties of the drug, cardiac output, regional blood flow, the degree of protein and tissue binding, and body composition (extracellular water and adipose tissue). Body composition, especially water and fat content, are also highly age dependent (FDA 1998). In newborns, total body water accounts for a larger fraction of body weight than in older children and adults. There is also a predominance of extracellular water. As a result, the volume of distribution for water-soluble drugs is greater in newborns and infants than in older children and adults when normalized to body weight or surface area. Lipid soluble drugs may also have a larger volume of distribution in infants than in older children and adults, because of the higher proportion of body fat (Balis 2000).

A.1.2.3 Metabolism

Drug metabolism usually occurs in the liver, but may also occur in the blood, gastrointestinal wall, kidney, lung, and skin (FDA 1998). Developmental changes in metabolizing capacity can affect both absorption and elimination, depending on the degree to which intestinal and hepatic metabolic processes are involved (Brown 1989). Although developmental changes are recognized, information on drug metabolism of specific drugs in newborns, infants, and children is limited. In general, it can be assumed that children will form the same metabolites as adults via pathways such as oxidation, reduction, hydrolysis, and conjugation, but rates of metabolite formation can be different.

The capacity of the liver to metabolize drugs is lower at birth, and the rate of development of the various metabolic pathways is highly variable and may be influenced by exposure to drugs *in utero* and postnatally (FDA 1998). Because of the variation in the maturation of drug metabolizing enzymes systems, the primary metabolic pathway for some drugs may differ in newborns and infants compared with adults. For example, glucuronide conjugation is reduced at birth and does not approach adult levels until 3 years of age, whereas sulfate conjugation is active *in utero* and at birth and declines in importance with age (Balis 2000). Therefore, drugs that are eliminated by conjugation with glucuronide in adults (e.g., acetaminophen) may be cleared primarily as sulfate conjugates in newborns and infants. Oxidative capacity is reduced at birth, but appears to develop over days, as evidenced by the decline in the half-life of phenytoin ($t_{1/2}$ >200 hrs in the first 5 days of life compared with 50 hrs by 30 days of life). During childhood, oxidative capacity for drugs exceeds that in adults, especially when expressed per body weight. In contrast, alcohol dehydrogenase does not approach adult levels until 5 years of age. The development of other phase I reactions (e.g., hydrolysis, demethylation) has not been well characterized (FDA 1998).

A.1.2.4 Excretion

Drug excretion by the kidney is controlled by glomerular filtration (GFR), tubular secretion, and tubular reabsorption. Because these processes mature at different rates in the pediatric population, age can affect systemic exposure for drugs where renal excretion is a dominant pathway of elimination. Consideration should also be given to the maturation of other excretory pathways, including biliary and pulmonary routes of excretion (Brown 1989).

At birth renal function is limited, because the kidneys are anatomically and functionally immature (FDA 1998). Renal blood flow is 40 mL/min/kg in newborns (16 percent of cardiac output), and reaches adult values by 1 year of age (20-25 percent of cardiac output). In full term newborns, glomerular filtration rate is 10-15 mL/min/m² and in premature infants the GFR is only 5-10 mL/min/m². GFR doubles by 1 week of age, because of a postnatal decrease in renal vascular resistance. GFR reaches adult values by 1 year of age. A glomerular/tubular imbalance is present at birth, because of the greater maturity of glomerular function in newborns. Renal tubular secretory function is impaired at birth, and approaches adult values by 1 year of age. Renal clearance of drugs is delayed in newborns and young infants, necessitating dose reductions, but after 8-12 months of age, the renal excretion of drugs is comparable with that observed in older children and may even exceed that in adults. In young children, renal size relative to body surface area is larger than in adults, and drug clearance normalized to body surface area can exceed that in adults. For example, the dose of aminoglycosides in children required to achieve equivalent plasma drug concentrations is usually 1.5- to 2-fold higher than in adults, because of the more efficient renal clearance in children (Balis 2000).

A.1.2.5 Protein Binding

Protein binding may change with age and concomitant illness. In certain circumstances, an understanding of protein binding may be needed to interpret the data from a blood level measurement and to determine appropriate dose adjustments (Rane et al. 1971). Serum albumin and total protein concentrations are decreased at birth and during infancy, and approach adult levels by 1 year of age. Decreased protein binding can enhance drug delivery to tissues, which is dependent on free drug concentrations. For example, the myocardium to plasma digoxin concentration ratio is 2- to 3-fold higher in neonates than in adults (Balis 2000). *In vitro* plasma protein binding studies can determine the extent of binding of the parent and the major active metabolite(s) and identify specific binding proteins, such as albumin and alpha-1 acid glycoprotein. Optimal estimates of the degree to which protein binding is linear may be obtained by testing maximum and minimum observed concentrations (FDA 1998).

A.1.2.6 Additional Factors

In addition to the influence of growth and developmental changes on ADME, growth and development in the pediatric population can create substantial changes in body size and function (FDA, 1998). For this reason, pharmacokinetic measures and/or parameters for a drug may need to be described as a function of age and be related to some measure of body size, such as height, weight, and/or surface area (Kearns 1989).

During pregnancy, exposure of the conceptus to drugs and chemicals depends on the function and structure of the placental barrier. Although there are marked interspecies differences in types of placenta, orientation of exchanging vessels, and number of exchanging layers, these differences do not play a dominant role in the placental transfer of most drugs and chemicals. In spite of this generality, significant species differences have been shown for placental permeability of hydrophilic molecules. For example, in sheep there is no significant diffusional flux for hydrophilic compounds with a molecular weight over 400 Daltons. In the guinea pig, however there is no restriction in diffusion for molecules with a weight up to 5000 Daltons. The permeability of the human placenta is considerably higher than the sheep placenta; the human placenta is more comparable to the guinea pig placenta (Leiser and Kaufmann 1994).

The observed species differences in placental transfer of xenobiotics are predominantly due to placental structural differences. Both the human and rat placentae are hemochorial, that is, the fetal chorionic villi bathe in lacunae of maternal blood. In the human placenta, the villous capillary is separated from maternal blood by three layers of cells (Goyer 1990). The layers of the rodent chorionic villus are similar, however, they have an additional layer of cytotrophoblasts (Goyer 1990). The villous nature of the human placenta also leads to a haphazard arrangement resulting in a cross-current exchange between the maternal and fetal circulations. In rodents, the flow system is mainly countercurrent, resulting in more efficient exchange. The high permeability of the human and guinea pig placentae, as compared with the sheep placenta, may be due to the fact that the human and guinea pig have a thin hemochorial type of placenta, whereas the sheep has a epitheliochorial placenta, in which more tissue layers separate the

maternal and fetal bloodstreams. In the human hemochorial placenta, the trophoblast and the endothelium are responsible for the diffusional resistance to hydrophilic compounds. The trophoblastic components determine the overall diffusion barrier, and intercellular spaces in the endothelium restrict the diffusion of larger molecules. Trophoblasts within the placenta also express p-glycoprotein, which may protect the fetus from xenobiotic exposure (Smit et al. 1999).

In addition to differences in placental anatomy, both human and rodent placentae undergo considerable changes throughout gestation as the normal developmental process proceeds (Maranghi et al. 1998). For example, enhanced blood flow to the placenta, increased fetal vasculature size, and proliferation of maternal vascular microvilli all contribute to increased efficiency of transplacental transport in guinea pigs during late gestation (Firth and Farr, 1977). The enhanced placental transfer of 13-cis-retinoic acid observed in rodents during later stages of gestation has been attributed to such maturational changes (Tzimas et al. 1995).

A.1.3 Collection of Pharmacokinetic Data in Developmental Toxicology

From the point of view of clinical pharmacokinetics and pharmacotherapy, the process of development and growth represents an unstable and dynamic condition. Because body weight, organ volumes and metabolic clearance are changing with age in a nonlinear fashion, a steady-state cannot be achieved and thus the developing child cannot be described in terms of a linear pharmacokinetic paradigm, since rates of mass transfer are not directly proportional to the chemical concentration. Therefore, age-related changes in drug absorption, distribution, and metabolism among neonates, infants, and prepubescent children create a unique situation that may increase drug toxicity of some agents and protect from toxicity of other agents (Loebstein and Koren 1998). Recently, particular attention has been focused on establishing the efficacy and safety of drugs in children and on assessing potential risks of environmental contaminants to infants and young children. Guidelines for collecting data useful in evaluation of developmental toxicity have been compiled by regulatory agencies (FDA 1998; U.S. EPA 1991, 1996 a-d, 2000 a, b; NRC 2000). The Environmental Protection Agency (EPA) has proposed the development of a “Children's Health Test Program” under the Toxic Substances Control Act. The EPA’s proposal for a children's health test battery includes 12 different assays, including: general toxicity, genotoxicity, carcinogenicity, neurotoxicity, and developmental and reproductive toxicity (Lamb and Brown 2000). The reproduction, fertility, and developmental toxicity testing guidelines were reviewed extensively by Claudio et al. (1999).

A.1.4 Application of PK Modeling of a Potential Developmental Toxicant in Infant-based Risk Assessment

Maturational changes in drug absorption, distribution, and metabolism are difficult to predict. The net effect of immaturity on pharmacokinetics and toxicodynamics may be modeled using computer-aided computational programs. Measurements of physiological functions in different age groups can be made and input into PK models. Recently, the National Academy of Sciences (NAS) *Committee on Pesticides*

in the Diets of Infants and Children suggested that physiologically based pharmacokinetic (PB/PK) models could be effectively utilized for different exposure scenarios, to predict the time course of potentially toxic chemicals and metabolites in different organs of children (Bruckner 2000). The decision whether or not to perform PK modeling for an infant-targeted risk assessment for a given chemical depends on the quality and quantity of available experimental data. A summary of the proposed decision tree for PK modeling of a potential developmental toxicant, aimed at the infant-based risk assessment is presented in Figure A2-1.

A.1.5 Types of Pharmacokinetic Models Applicable to Developmental Toxicology

The information in this subsection is taken from Byczkowski 2000. In developmental toxicology, both pharmacokinetic (PK) and toxicodynamic (TD) models may be useful for exposure and dose-response assessment, route-to-route extrapolations, interspecies extrapolation, derivation of toxicity values (ADI, BMD, MRL, RfC, RfD, TLV), etc. Since biological responses of tissues and organs are mechanistically linked to the local concentration of the active form of chemical compound, the internal dose of chemical that reaches a particular physiological compartment must be used for any meaningful risk characterization in children, infants and unborn. Several modeling and computing methods have been used in developmental toxicology for analysis and presentation of PK/TD data, estimation of PK parameters, extrapolations between the experimental data points and simulations of disposition of chemicals (ADME). Mathematical methods used in PK/TD modeling can be sub-divided into (1) **descriptive** and (2) **predictive** models (Byczkowski 2000).

A.1.5.1 Descriptive PK/TD Models

A nonlinear regression analysis is an example of a descriptive mathematical method, in which parameters of the equation for a continuous curve are fit into the experimental data points (Byczkowski 2000). The pitfall of **curve-fitting** in pharmacokinetics is that, even if one succeeds in finding equations that duplicate the behavior of the PK/TD system, their internal workings may be very different from the internal mechanism of the real biological system. The simulations only “mimic” kinetic behavior of the chemical and do not provide insight into the quantitative or mechanistic relations between the internal components of the real system. Parameters of the fitted equations are often artificial and arbitrary, without physicochemical and/or physiological meaning. Descriptive models may be valuable for extrapolating the system variables between the experimental data points, but they often fail to provide extrapolations beyond the range of experimental calibrations, especially in the high to low dose extrapolations. Calculations of PK/TD parameters based on **phenomenological** data analysis, such as curve fitting, curve stripping or feathering, AUC calculation, etc., are sometimes called “model-independent” because they are apparently free of any assumption about the underlying compartmental model that the chemical obeys.

Descriptive pharmacokinetic parameters, and consequently, intakes or dose rates in children, are commonly related to body weight and presented in “per kilogram body weight” units. Most body size relations can be expressed mathematically as an allometric equation (Peters 1983):

$$Y = a * W^b \quad (1)$$

where Y is the biological characteristic to be predicted, W is the body mass (kg), and a and b are empirically derived constants.

This allometric equation has been used successfully for cross species scaling in pharmacokinetics (Paxton et al. 1993; Cruze et al. 1995; Lave et al. 1995). It may be applied to a metabolic process such as drug clearance (CL) using a power parameter of 0.75 (nonlinear scaling). Therefore, in an individual of body weight W_i (kg):

$$CL_i = CL_{std} * (W_i / W_{std})^{0.75} \quad (2)$$

where CL_i is the clearance in the individual and CL_{std} (mL/min) is the clearance in a standardized individual with body weight W_{std} (Holford 1996).

The weight standard for an adult human male is usually 70 kg (U.S. EPA 1997). When applied to physiological volumes of organs (V), the power parameter is 1 (linear scaling):

$$V_i = V_{std} * (W_i / W_{std}) \quad (3)$$

where V_i is the physiological volume in the individual and V_{std} is the physiological volume in a standardized individual with body weight W_{std} (kg).

This equation has been verified for blood volume, vital capacity and tidal volume (Prothero 1980; Adolf, 1949; Guyton 1947; Stahl 1967).

Almost 100 years ago, Moore (1909) suggested that for the great majority of drugs, the method of expressing dosage per kilogram body weight is inaccurate in the lower age ranges. In humans, an underprediction of clearance of more than 10 percent occurs at body weights less than 47 kg (Holford 1996). This error increases as size decreases and approaches 50 percent for a new-born human of 3.4 kg. However, this gross underprediction in the very young is not always seen clinically because of immaturity of enzyme systems. An alternative method, based on body surface area rather than weight as a measure of size, is sometimes used to predict dosing schedules for medications with narrow therapeutic indices (e.g. cytotoxic agents; Anderson 2000).

The surface area method requires the measure of height as well as weight to estimate size, and is usually determined from nomograms (which introduce additional error). The original surface area model proposed by Du Bois and Du Bois (1916) was developed from 9 individuals. When a standard surface area of 1.9 m² is used in this model, clearances estimates are reasonable except at body weights below 7 kg. If a standard surface area of 1.73 m² is used, this method consistently overpredicts by 10 percent (Holford 1996). This may be expected because the body area of animals rise more slowly than the surface law would suggest as larger animals are stockier. (The “surface law” refers to an animal’s skin.) Surfaces used for nutrient absorption or gas exchange, such as gut villi or respiratory alveoli, bear only a distant relation to this external skin surface. Nevertheless, the simplicity of the surface law has led to its widespread use and misuse (Kleiber 1961).

Reference texts such as the *British National Formulary* (1995) and Martindale’s *Pharmacopoeia* (1989) recommend use of the body surface area method for calculation of children’s drug doses. Surface area can be estimated from body weight using a power parameter of 0.67 (nonlinear) in the allometric equation (Peters 1983). Drug dosage rules for children have been constructed which use percentage of an adult dose to calculate an appropriate child’s dose. The aim was to reduce the relative dose as body size increases. However, most of the physiological variables scale predictably with a weight exponential of 0.75, not 0.67 (the surface area exponential). If pediatric doses are based on a power exponential of 0.75, then:

$$CL_{\text{child}} = CL_{\text{adult}} * (Wt/70)^{0.75} \quad (4)$$

$$\text{Percent Adult Dose} = 100 * CL_{\text{child}} / CL_{\text{adult}} \quad (5)$$

where CL_{child} is the clearance in the child, CL_{adult} (mL/min) is the clearance in a “reference adult individual” with body weight (Wt/kg).

In a 6-month-old infant, the surface area model overpredicts the dose by 22 percent, while the per kilogram model underpredicts by 57 percent. However, the therapeutic ratio for most drugs is more than 50 percent, and consequently the impact of the difference between the two models is usually inconsequential. The usefulness of the surface area scaling method when applied to anti-neoplastic drugs has been questioned (Reilly and Workman 1993). Dose is dependent on pharmacokinetic factors such as clearance and volume of distribution, and pharmacodynamics, which may change with age and progress of disease (Anderson 2000).

A.1.5.2 Predictive PK/TD Models

A physiologically based pharmacokinetic (PB/PK) model is an example of the predictive method, in which parameters of the PB/PK model quantitatively describe relations between the internal workings and correspond to the physicochemical and physiological properties of the PK system (Byczkowski, 2000). The PB/PK model provides insight into the mechanism of disposition of the chemical within the

biological system, and reflects as well as describes the real physiological phenomena of interaction between the chemical and the organism, usually expressed by nonlinear relationships. In contrast, classical **compartmental PK** models describe linear systems in which the rate of transfer of the chemical from one compartment to another is directly proportional to the total mass of the chemical in this compartment. However, in reality, biological systems are nonlinear and can not be accurately described by a single elimination rate constant for a wide range of concentrations. These nonlinearities are well handled by PB/PK models but not by classical compartmental PK models.

In PB/PK modeling there is no need for assumptions of a steady state or first order kinetics. These predictive models, when properly calibrated and validated, may be used beyond the range of experimental data points, and thus they can still reliably predict the behavior of PK/TD systems in regions where no information is available. This is often impossible with classical PK models which are data-based, and easily fail in extrapolations (Byczkowski, 2000).

A.2 PB/PK MODELING OF CHEMICAL DISTRIBUTION IN TISSUES

A.2.1 When Is It Feasible to Develop a PB/PK Model?

In addition to the extensive physiological parametrization, the PB/PK models require chemical-specific experimental data. While most of the necessary physiological parameters may be found in the relevant literature (Brown et al. 1997), the decision whether or not to develop a PB/PK model for a particular chemical should be based on the availability of experimental evidence of developmental toxicity and data collected from laboratory animals and/or clinical information collected from children. For many chemicals and drugs there is simply not enough information available to justify the construction and calibration of a PB/PK model. In these cases, a classical pharmacokinetic (PK) description of the available data or a qualitative evaluation may be the only feasible approach. A summary of the decision tree paradigm for the experimental construction of a PB/PK model for a potential developmental toxicant is presented in Figure A2-2.

A.2.2 PB/PK Modeling of Transplacental Transfer

The volume of the placenta and placental blood flow were adequately described by the following growth function (Clewel et al. 1999):

$$VPI = VplA * \exp(VplB * (\exp(VplC * \text{Time}))) \quad (6)$$

$$QPI = QplM * Vpl \quad (7)$$

where VPI is the volume of placenta (kg), VPIA = 0.85, VPIB = -9.434, and VPIC = -5.23e-4 are placental weight logistic constants, and Time is the time that elapsed from the moment of conception (hrs), QPI is the blood flow through placental tissue (L/hr), and QPIM = 58.5 is the allometric placental blood flow constant (L/hr/kg^{3/4}).

A.2.3 PB/PK Modeling of Fetal Growth

The volume of fetus was adequately described by the following growth function (Clewel et al. 1999):

$$VFe = BWP * \exp(VfeB * (\exp(VfeC * Time))) + VfeD * \exp(VfeE * (\exp(VfeF * Time))) \quad (8)$$

where VFe is the volume of the fetus (kg), BWP is the final fetal weight, equal to the neonatal body weight at birth, VFeB = -16.081, VFeC = -5.67e-4, VFeD = 3.50, VFeE = -140.178, and VFeF = -7.01e-4 are all fetal weight logistic constants, and Time is the time that elapsed from the moment of conception (hrs).

While in this model the fetal red blood cell compartment (RBCFe) was described as diffusion-limited, the remaining three compartments: fetal plasma (PFe), fetal brain (BrFe) and "other fetal tissues" (BtFe), were described as flow-limited. The terminal amounts of MeHg present in these four fetal compartments at the time of parturition (ARBCFe, APFe, ABrFe and ABtFe; all in mg) were subsequently used in the infant module developed by Byczkowski and Lipscomb (1999) as the initial amounts for neonatal compartments (ARBC0, AP0, ABr0 and ABt0, respectively).

A.2.4 PB/PK Modeling of Neonatal Growth

Neonatal body weight was adequately described by the following growth function (O'Flaherty 1991):

$$WBODY = BWP + WCHILD * AGE * FAIG / (HALF + AGE) + WADULT / (1.0 + KAPPA * \exp(-LAMBDA * WADULT * AGE)) \quad (9)$$

where WBODY is body weight of a human as a function of age (kg), BWP is the neonatal body weight at birth (kg), WCHILD is the maximum weight for early hyperbolic section of growth curve (kg), AGE is the age of the child at which the simulation begins (yr), FAIG is the fraction of average infant growth (default = 1.0), HALF is the age at which weight is half WCHILD (yr), WADULT is the maximum

weight for later logistic section of growth curve (kg), KAPPA is the logistic constant kappa, and LAMBDA is the logistic constant lambda (1/(kg-yr)). For default values of these parameters, see Table A2-1.

A.2.5 Milk Volume Changes – Proposed Allometry

Although, according to Byczkowski and Lipscomb (1999), the PB/PK model is insensitive to the initial volume of milk (sensitivity coefficients of infant outputs were between -10^{-3} and -10^{-5}), this estimated variable (VMILK) was scaled allometrically, just to reflect the physiological reality of the breast milk compartment:

$$VMILK = VMILKC * (BW * PNO)^{0.75} \quad (10)$$

where VMILK is volume of blood-equilibrated milk present in mammary glands at any given time during the lactation period (L); VMILKC = 0.0014 (L/kg BW/PNO) is a constant; BW is the initial maternal body weight (kg); PNO is the number of simultaneously nursed infants or pups. This semi-empirical approximation was based on fitting both the hourly milk yield measured in rats and 1/24th of the average daily breast milk yield in humans.

Milk yield (OUTI in L/hr) was assumed to be equal to the milk intake by the infant (pups) and was experimentally determined as $OUTI = 0.00233 \text{ L/hr}$ ($PNO = 8$) in rats, or estimated in humans from the time-dependent infant body weight growth algorithm (adopted from O'Flaherty, 1991, and fitted to data from Neville et al., 1988). Accordingly, the rate of breast milk intake by the human infant was best described by the following growth equation:

$$OUTI = INTAKE * ((PNO * (WBODY - BWP))^{0.2}) / (1.15 * 24) \quad (11)$$

where OUTI is the rate of consumption of breast milk by a human infant (L/hrs), INTAKE is a fraction of milk yield (default = 1.), PNO is the number of simultaneously nursed infants, WBODY is the body weight of human as a function of age (kg), BWP is the neonatal body weight at birth (kg). On average, the rate of consumption of breast milk by a human infant is 0.67 L/day, at age 10.5 days ($WBODY = 3.78 \text{ kg}$), and 0.98 L/day, at age 97.5 days ($WBODY = 5.36$). The breast milk intake for USA was calibrated with data from Neville et al. (1988); the typical range was from 0.5 to 0.88 L/day.

A.2.6 PB/PK Modeling of Tissue Distribution of Chemicals in Children

The main physiological parameters necessary for PB/PK model simulation of tissue distribution of chemicals in children are listed in Table A2-2 (defaults for child 1 year of age and older).

Predictive modeling of tissue distributions of chemical compounds gave realistic results when tissue composition was taken into account (see Table A2-3). Even though tissues of very young children contain more water than in adults, Pelekis et al. (2001) suggested that no significant adult-child differences in the parent chemical concentrations of the VOCs are likely to be observed during inhalation exposures. The approach of Pelekis et al. (2001) utilized PB/PK models and simplified physiological model-based algebraic equations to translate the ambient exposure concentration to internal (tissue) dose in adults and children. Based on interindividual variability of input parameters, uncertainty factors (UF) were calculated for adults (UF_{HH-PK}) and for children (UF_{HC-PK}). The modeling results suggested that:

1. The UF_{HH-PK} and UF_{HC-PK} are chemical specific;
2. For the chemicals used in this study, there was no significant difference between UF_{HH-PK} and UF_{HC-PK} ;
3. The magnitude of UF_{HH-PK} and UF_{HC-PK} varies between 0.033 and 2.85 with respect to tissue and blood concentrations;
4. The body weight (BW), rate of ventilation (QPC), fraction of cardiac output flowing to the liver (QLC), blood:air partition coefficient (PB) and the hepatic extraction ratio (E) are the only parameters that play a critical role in the variability of internal doses within species; and
5. The magnitude of the UF_{HH-PK} and UF_{HC-PK} obtained with the simplified steady-state equations is essentially the same with that obtained with PB/PK models.

The physiological model-based approaches used in this study to estimate the UF_{HH-PK} and UF_{HC-PK} provided a scientific basis for their magnitude. They can replace the currently used default approaches (interindividual uncertainty UF_{HH-PK} of 10X, in addition to pre- and post-natal toxicity uncertainty UF_{HC-PK} of 10X, resulting in the aggregated uncertainty factor = 100) to provide chemical-specific UFs in future risk assessments (Pelekis et al. 2000).

The pharmacokinetic modeling study of Poulin and Krishnan (1996) and Pelekis et al. (2001) demonstrated that a PB/PK module calculating blood and tissue partition coefficients can be constructed and substituted for the defaulted "constant" parameters in the PB/PK model for VOCs. The tissue solubility algorithms were provided by Poulin and Krishnan (1996), based on tissue composition. A Hill (1910) binding constant (k_{pr}) should be added to the algorithm for blood:air partition coefficient to account for the protein (hemoglobin) binding of VOC, however, at very low VOC concentrations (well below saturation), protein binding could be described by a first order (linear) process. Accordingly, the Hill equation may be reduced to a simple linear term.

The solubility of chemicals in blood and tissue was adequately described by equations provided by Poulin and Krishnan (1996):

$$VNB = TLIB * FVNB \quad (12)$$

where VNB is a volume of neutral lipid in blood, TLIB is fractional total lipid in blood (0.0065), and FVNB is fractional volume of neutral lipid in blood (0.68).

$$VPB = TLIB * FVPB \quad (13)$$

where VPB is a fraction volume of phospholipid in blood, TLIB is fractional total lipid in blood (0.0065), and FVPB is fractional volume of phospholipid in blood (0.32).

$$SB = ((SW * VWB) + (SO * VNB) + (SW * 0.7 * VPB) + (SO * 0.3 * VPB))/kpr \quad (14)$$

where SB is solubility of the chemical compound in blood, SW is solubility in water or saline, VWB is fractional volume of water in blood (0.80), SO is solubility in vegetable oil, VNB is a volume of neutral lipid in blood, SW is solubility in water or saline, VPB is fraction volume of phospholipid in blood, kpr is a linear approximation of Hill binding constant at low concentration.

A similar set of equations described chemical solubility in the liver tissue:

$$VNLI = TLILI * FVNLI \quad (15)$$

where VNLI is a volume of neutral lipid in the liver, TLILI is fractional total lipid in liver (0.060), and FVNLI is fractional volume of neutral lipid in liver (0.58).

$$VPLI = TLILI * FVPLI \quad (16)$$

where VPLI is a volume of phospholipid in the liver, and FVPLI is fractional volume of phospholipid in liver (0.42).

$$SLI = ((SW * VWLI) + (SO * VNLI) + (SW * 0.7 * VPLI) + (SO * 0.3 * VPLI)) \quad (17)$$

where SLI is solubility in the liver, SW is solubility in water or saline, VWLI is fractional volume of water in liver (0.700), SO is solubility in vegetable oil, VNLI is fractional volume of neutral lipid in liver.

$$PLI2 = SLI/SA \quad (18)$$

where PLI2 is liver:air partition coefficient, and SA is saturable vapor pressure of chemical in air:

$$SA = P/(R * TE) \quad (19)$$

where P is vapor pressure in Pa at 37 °C, R is gas constant (8.310 Pa(m³)/mole), and TE is absolute temperature (310 °K) .

$$PL = PLI2/PB \quad (20)$$

where PL is liver:blood partition coefficient, and PB is partition coefficient blood:air:

$$PB = SB/SA \quad (21)$$

Analogous equations may be developed to calculate partitioning of chemicals in all other tissue compartments in the PB/PK model.

A.3 REFERENCES

- Adolf EF. (1949). Quantitative relations in the physiological constitutions of animals. *Science* 109:579-585.
- Anderson B. (2000). Drugs and the neonate and children. Published on-line.
<http://www.phm.auckland.ac.nz/Courses/565722/Drugs_neonate_child/drugs_neonate_child.htm>.
- Balis F. (2000). Module 4: Drug therapy in special populations. In *Principles of Clinical Pharmacology*. Published on-line by NIH. <<http://www.cc.nih.gov/ccc/principles/>>.
- Bearer CF. (1995). How are children different from adults? *Environ. Health Perspect.* 103 (Supplement 6):7-12. Available on-line at <<http://ehpnet1.niehs.nih.gov/docs/1995/Suppl-6/bearer-abs.html>>.
- British National Formulary. (1995). London: British Medical Association, 11.
- Brown R D, Campoli-Richards D. (1989). Antimicrobial therapy in neonates, infants and children. *Clin. Pharmacokinet.* 17 (Suppl 1):105-115.
- Brown RP, Delp MD, Lindstedt SL, Rhomberg LR, Beliles RP. (1997). Physiological parameter values for physiologically based pharmacokinetic models. *Toxicol. Ind. Health* 13:407-484.
- Bruckner JV. (2000). Differences in sensitivity of children and adults to chemical toxicity: The NAS panel report. *Regul. Toxicol. Pharmacol.* 31:280-285.
- Byczkowski JZ. (1996). Linked physiologically based pharmacokinetic model and cancer risk assessment for breast-fed infants. *Drug Inf. J.* 30:401-412.
- Byczkowski JZ. (2000). Pharmacokinetic/Dynamic Modeling. In: *Standard Handbook of Environmental Science, Health and Technology*, Chapter 8.6. (Lehr J, ed.), New York: McGraw-Hill.
- Byczkowski JZ, Kinkead ER, Leahy HF, Randall GM, Fisher JW. (1994). Computer simulation of the lactational transfer of tetrachloroethylene in rats using a physiologically based model. *Toxicol. Appl. Pharmacol.* 125:228-236.
- Byczkowski JZ, Lipscomb JC. (1999). Application of PB/PK model for assessment of the lactational transfer of MeHg to nursing infant. Society for Risk Analysis Annual Meeting, Atlanta, GA, 1999. Final Program P1-17, p. 47. Abstract on-line.
<<http://www.riskworld.com/Abstract/1999/SRAam99/ab9ab047.htm>>.
- Claudio L, Bearer CF, Wallinga D. (1999). Assessment of the U.S. Environmental Protection Agency methods for identification of hazards to developing organisms, Part I: The reproduction and fertility testing guidelines. *Am. J. Ind. Med.* 35:543-553.
- Claudio L, Bearer CF, Wallinga D. (1999). Assessment of the U.S. Environmental Protection Agency methods for identification of hazards to developing organisms, Part II: The developmental toxicity testing guideline. *Am. J. Ind. Med.* 35:554-563.
- Clewell HJ, Gearhart JM, Gentry PR, Covington TR, VanLandingham CB, Crump KS, Shipp AM. (1999). Evaluation of the uncertainty in an oral reference dose for methylmercury due to interindividual variability in pharmacokinetics. *Risk Analysis* 19:547-558.
- Cruze CA, Kelm GR, Meredith MP. (1995). Interspecies scaling of tebufelone pharmacokinetic data and application to preclinical toxicology. *Pharm. Res.* 12:895-901.
- Du Bois D, Du Bois EF. (1916). Clinical calorimetry. Tenth paper. A formula to estimate the approximate surface area if height and weight be known. *Arch. Intern. Med.* 17:863.

- FDA. (1998). Guidance for Industry: General Considerations for Pediatric Pharmacokinetic Studies for Drugs and Biological Products. U.S. Department of Health and Human Services. Food and Drug Administration. Center for Drug Evaluation and Research (CDER). Center for Biologics Evaluation and Research (CBER). Published on-line by the Food and Drug Administration, November 1998. <<http://www.fda.gov/cber/guidelines.htm>>.
- Firth JA, Farr A. (1977). Structural features and quantitative age-dependent changes in the intervacular barrier of the guinea-pig haemochorial placenta. *Cell Tissue Res.* 184(4):507-516.
- Gilman J. (1990). Therapeutic drug monitoring in the neonate and pediatric age group, problems and clinical pharmacokinetic implications. *Clin. Pharmacokinet.* 19(1):1-10.
- Goyer RA. (1990). Transplacental transport of lead. *Environ. Health Perspect.* 89:101-105.
- Guyton AC. (1947). Measurement of the respiratory volumes of laboratory animals. *Am. J. Physiol.* 150:70-77.
- Holford NHG. (1996). A size standard for pharmacokinetics. *Clin. Pharmacokinet.* 30:329-332.
- Kearns GL, Reed MD. (1989). Clinical pharmacokinetics in infants and children: a reappraisal. *Clin. Pharmacokinet.* 17(Suppl 1):29-67.
- Kleiber M. (1961). *The Fire of Life: An Introduction to Animal Energetics.* New York: Wiley.
- Lamb JC, Brown SM. (2000). Chemical testing strategies for predicting health hazards to children. *Reprod. Toxicol.* 14:83-94.
- Lave T, Schmitt-Hoffmann AH, Coassolo P. et al. (1995). A new extrapolation method from animals to man: application to a metabolised compound, nefarotene. *Life Science* 56:473-478.
- Leiser R, Kaufmann P. (1994). Placental structure: in a comparative aspect. *Exp. Clin. Endocrinol.* 102:122-134.
- Loebstein R, Koren G. (1998). Clinical pharmacology and therapeutic drug monitoring in neonates and children. *Pediatr. Rev.* 19:423-428.
- Maranghi F, Macri C, Ricciardi C, Stazi AV, Mantovani A. (1998). Evaluation of the placenta: suggestion for a greater role in developmental toxicology. *Adv. Exp. Med. Bio.* 444:129-136.
- Martindale. (1989). *The Extra Pharmacopoeia.* London: The Pharmaceutical Press.
- Moore B. (1909). The relationship of dosage of a drug to the size of an animal treated, especially in regard to the cause of the failure to cure trypanosomiasis, and other protazoan diseases in man and in other large animals. *Biochem. J.* 4:322-330.
- Neville MC, Keller R, Seacat J, Lutes V, Neifert M, Casey C, Allen J. Archer P. (1988). Studies in human lactation: milk volumes in lactating women during the onset of lactation and full lactation. *Am. J. Clin. Nutr.* 48:1375-1386.
- NRC. (2000). National Research Council. Committee on Developmental Studies and Toxicology, Commission on Life Sciences. *Scientific Frontiers in Developmental Toxicology and Risk Assessment.* Washington DC: National Academy Press. Published on-line. <<http://www.nap.edu/openbook /0309070864/html/R1.html>>.
- O'Flaherty EJ. (1991). Physiologically based models for bone-seeking elements: III Human skeletal and bone growth. *Toxicol. Appl. Pharmacol.* 111:332-341.
- Paxton JW, Young D, Robertson IG. (1993). Pharmacokinetics of acridine-4-carboximide in the rat, with extrapolation to humans. *Cancer Chemother. Pharmacol.* 32:323-325.

- Pelekis M, Gephart LA, Lerman SE. (2001). Physiological model-based derivation of the adult and child pharmacokinetic intraspecies uncertainty factors for volatile organic compounds. *Regulat. Toxicol. Pharmacol. J.* 33:12-20.
- Peters HP. (1983). *The ecological implications of body size.* Cambridge: Cambridge University Press, 48-53.
- Poulin P, Krishnan K. (1996). A tissue composition-based algorithm for predicting tissue:air partition coefficients of organic chemicals. *Toxicol. Appl. Pharmacol.* 136:126-130.
- Prothero JW. (1980). Scaling of blood parameters in mammals. *Comparative Biochemistry and Physiology A*67:649-657.
- Rane A, Wilson J. (1976). Clinical pharmacokinetics in infants and children. *Clin. Pharmacokinet.* 1(1):2-24.
- Rane A, Lunde PKM, Jallin B, et al. (1971). Plasma protein binding of diphenylhydantoin in normal and hyperbilirubinemic infants. *J. Pediatr.* 78(5):877-882.
- Reilly JJ, Workman P. (1993). Normalisation of anti-cancer drug dosage using body weight and surface area: is it worthwhile? A review of theoretical and practical considerations. *Cancer Chemother. Pharmacol.* 32:411-418.
- Smit JW, Huisman MT, van Tellingen O, Wiltshire HR, Schinkel AH. (1999). Absence of pharmacological blocking of placental P-glycoprotein profoundly increases fetal drug exposure. *J. Clin. Investigation* 104:1441-1447.
- Stahl WR. (1967). Scaling of respiratory variables in mammals. *J. Appl. Physiol.* 22:453-460.
- Tzimas G, Collins M, Nau H. (1995). Developmental stage-associated differences in the transplacental distribution of 13-cis and all-trans-retinoic acid as well as their glucuronides in rats and mice. *Toxicol. Appl. Pharmacol.* 133:91-101.
- U.S. EPA. (1991). Guidelines for Developmental Toxicity Risk Assessment. Federal Register, Part 5, vol. 56, pp. 63798-63828. Washington DC: U.S. Environmental Protection Agency (December 5, 1991). 4, EPA-600-R-91-001. Published on-line. <<http://www.epa.gov/cgi-bin/claritgw>>.
- U.S. EPA. (1996a). Guidelines for Reproductive Toxicity Risk Assessment. Washington DC: U.S. Environmental Protection Agency (September 1996). EPA-630-R-96-009. Published on-line. <<http://www.epa.gov/ORD/WebPubs/repro/>>.
- U.S. EPA. (1996b). Health Effects Test Guidelines. OPPTS 870.3500. Preliminary Developmental Toxicity Screen. Washington DC: U.S. Environmental Protection Agency (June 1996). 7101, EPA-712-C-96-205. Published on-line. <http://www.epa.gov/opptsfrs/OPPTS_Harmonized/870_Health_Effects_Test_Guidelines/Drafts/870-3500.txt.html>.
- U.S. EPA. (1996c). Health Effects Test Guidelines. OPPTS 870.3700. Prenatal Developmental Toxicity Study. Washington DC: U.S. Environmental Protection Agency. Office of Pollution Prevention and Toxics (February 1996). 7101, EPA-712-C-96-207. Published on-line. <http://www.epa.gov/opptsfrs/OPPTS_Harmonized/870_Health_Test_Guidelines/Drafts/870-3700.txt.html>.
- U.S. EPA. (1996d). Health Effects Test Guidelines. OPPTS 870.3600. Inhalation Developmental Toxicity Study. Washington DC: U.S. Environmental Protection Agency (June 1996). 7101, EPA-712-C-96-206. Published on-line. <http://www.epa.gov/opptsfrs/OPPTS_Harmonized/870_Health_Effects_Test_Guidelines/Drafts/870-3600.txt.html>.

- U.S. EPA. (1997). Exposure Factors Handbook, Volume I - General Factors. Washington DC: U.S. Environmental Protection Agency (August 1997). EPA-600-P-95-002Fa. Published on-line. <<http://www.epa.gov/ncea/pdfs/efh/front.pdf>>.
- U.S. EPA. (2000a). Health Effects Test Guidelines. OPPTS 870.3550. Reproduction/Developmental Toxicity Screening Test. Washington DC: U.S. Environmental Protection Agency (July 2000). 7101, EPA-712-C-00-367. Published on-line. <http://www.epa.gov/docs/OPPTS_Harmonize/870_Health_Effects_Test_Guidelines/Series/870-3550.pdf>.
- U.S. EPA. (2000b). Health Effects Test Guidelines. OPPTS 870.3650. Combined Repeated Dose Toxicity Study with the Reproduction/Developmental Toxicity Screening Test. Washington DC: U.S. Environmental Protection Agency (July 2000). 7101, EPA-712-C-00-368. Published on-line. <http://www.epa.gov/docs/OPPTS_Harmonized/870_Health_Effects_Test_Guidelines/Series/870-3650.pdf>.
- U.S. EPA. (2000c). Strategy for Research on Environmental Risks to Children. Washington DC: U.S. Environmental Protection Agency. Office of Research and Development. EPA-600-R-00-068. Published on-line. <<http://www.epa.gov/nceawww1/risk2kids.htm>>.
- Yaffe SJ, Aranda JV. (1992). Introduction and historical perspectives. In: Pediatric Pharmacology, Therapeutic Principles in Practice, 2nd ed. (Yaffee SJ, Aranda JV, eds.). Philadelphia: Saunders, 3-9.

Table A2-1. PB/PK Model Simulation Parameters for Mother and Infant

Input Parameter	Value	Description	(Units)	Source
Blood Flows				
QCC	20.0	Cardiac output	(L/hr/kg ^{3/4})	A
QFeC	54.0	Fetal	(L/hr/kg ^{3/4})	B
QPIM	58.5	Placenta	(L/hr/kg ^{3/4})	B
Plasma Flows (fraction of QCC)				
QbrBC	0.114	Brain plasma	(ratio)	B
QFC	0.052	Fat	(ratio)	B
QGC	0.181	Gut	(ratio)	B
QKC	0.175	Kidney	(ratio)	B
QLC	0.046	Liver	(ratio)	B
QRC	0.183	Rapidly perfused	(ratio)	B
fQMT	0.1	Mammary tissue	(fraction of QRC)	C
QSC	0.249	Slowly perfused	(ratio)	B
Body Weights				
BW	67.77	Body weight mother	(kg)	B
BWP	3.5	Initial body weight Infant	(kg)	B
Tissue Volume (fraction of BW)				
VbrC	0.02	Brain	(ratio)	B
VbrBC	0.007	Brain plasma	(ratio)	B
VFC	0.273	Fat	(ratio)	B
VGC	0.017	Gut	(ratio)	B
VHC	0.002	Hair	(ratio)	B
VIC	0.014	Intestine	(ratio)	B
VKC	0.004	Kidney	(ratio)	B
VLC	0.026	Liver	(ratio)	B
VPC	0.041	Plasma	(ratio)	B
VRBCC	0.024	Red blood cells	(ratio)	B
VRC	0.10	Rapidly perfused tissues	(ratio)	B
VSC	0.35	Slowly perfused tissues	(ratio)	B
Vremain	0.122	Remainder of body	(ratio)	B
VGI	0.0836	GI tract infant	(ratio)	C
VMILKC	0.0014	Initial volume of milk	(L/kg/PNO)	C
Infant Growth				
WCHILD	22.	Max. weight for early section of growth curve, Female	(kg)	D
	23.	Max. weight, Male	(kg)	D
HALF	3.	Age at which weight is half WCHILD	(yr)	D
WADULT	34.	Max. weight for later section of growth curve, Female	(kg)	D
	50.	Max. weight, Male	(kg)	D
KAPPA	600.	Logistic constant kappa		D
LAMBDA	0.017	Logistic constant lambda, Female	(1/(kg-yr))	D
	0.0095	Logistic constant lambda, Male	(1/(kg-yr))	D
OUTI = OUTX		Milk yield = milk intake	(from growth curve)	E

Sources: A - Brown et al. (1997); B - Clewell et al. (1999); C - Byczkowski (1996); D - O'Flaherty (1991); E - Byczkowski et al. (1994).

Table A2-2. PB/PK Model Simulation Parameters for Child (defaults for 1 year and older)

Input Parameter	Value	Description	(Units)	Source
QPC	31.3	Pulmonary ventilation rate	(L/h/kg)	A
Blood Flows				
QCC	22.6	Cardiac output	(L/h/kg)	A
Tissue Blood Flows (fraction of QCC)				
QFC	0.1	Fat	(ratio)	A
QSC	0.22	Slowly perfused	(ratio)	A
QLC	0.24	Liver	(ratio)	A
QRC	0.44	Rapidly perfused, determined from difference in the total body volume ($QRC=1.0 - S Q_i$)	(ratio)	A
Body Weight				
BW	10.0	Body weight	(kg)	A
Tissue Volume (fraction of BW)				
VFC	0.167	Fat	(ratio)	A
VSC	0.46	Slowly perfused tissues, determined from difference in the total body volume ($VSC=0.91 - S V_i$)	(ratio)	A
VLC	0.025	Liver	(ratio)	A
VRC	0.178	Rapidly perfused tissues	(ratio)	A

Source: A - Pelekis et al. (2001)

Table A2-3. Water and Lipid Composition of Human Tissues (defaults for child 1 year and older)

Tissue Compartment	Fraction of tissue weight		
	Water	Neutral lipids	Phospholipids
Liver	0.720	0.039	0.0280
Fat	0.150	0.798	0.00200
Richly perfused	0.720	0.039	0.00280
Slowly perfused	0.750	0.0100	

Source: Pelekis et al. (2001)

Decision tree for application of PK modeling in developmental toxicity

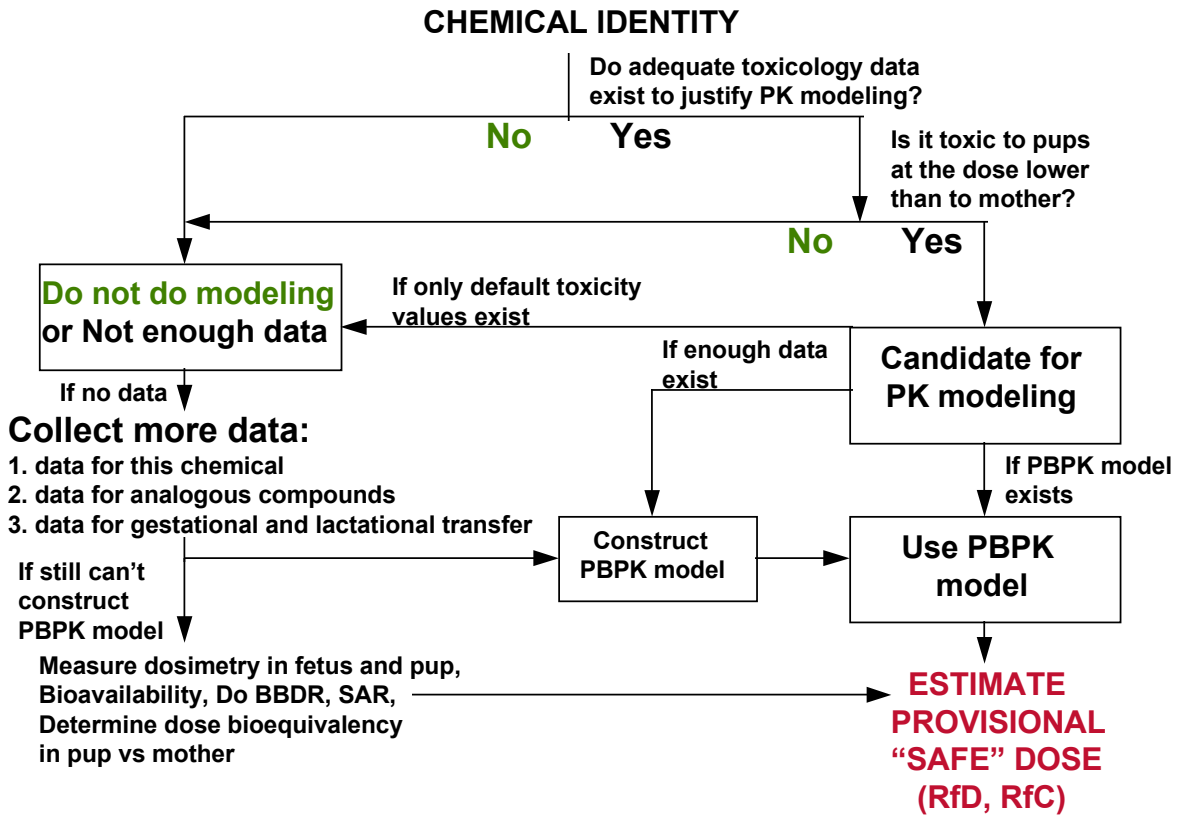

Figure A2-1. Proposed decision tree for pharmacokinetic (PK) modeling of a potential developmental toxicant, aimed at the infant-based risk assessment

Source: (Byczkowski and Lipscomb 1999; available on Web at <<http://members.spree.com/education/tnproj/PeriPBPK.htm>>).

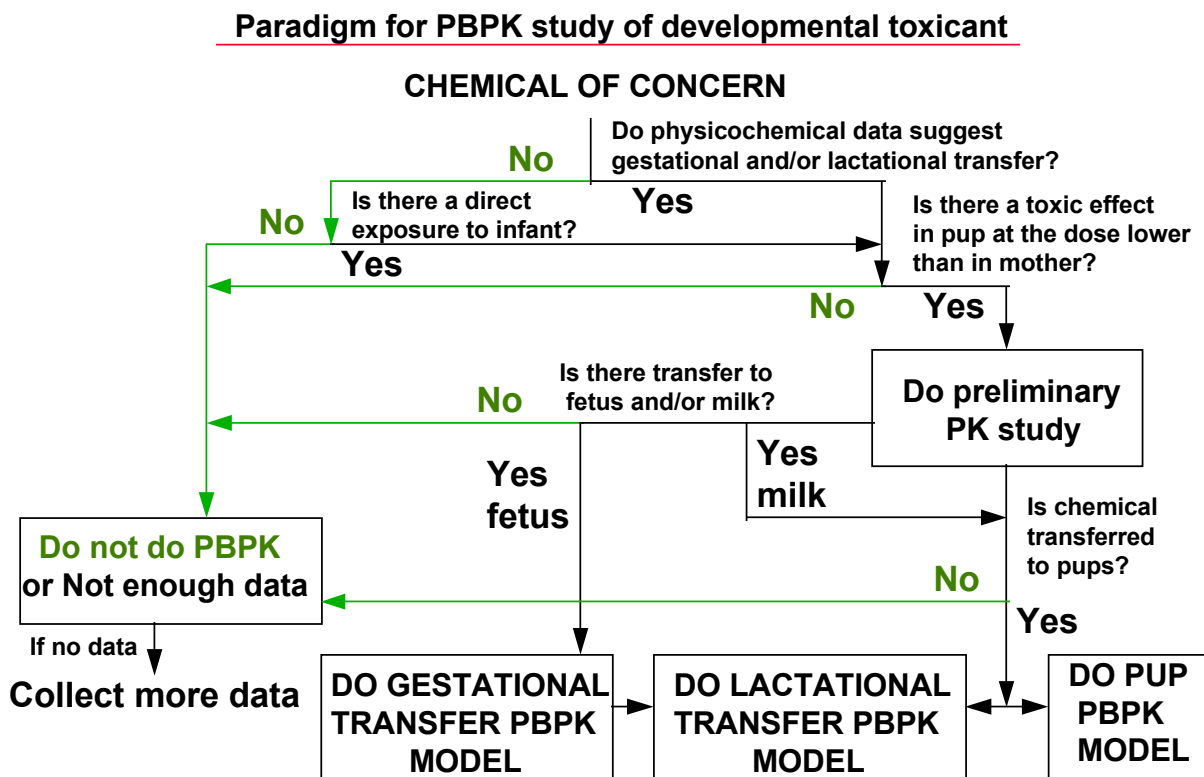

Figure A2-2. Proposed paradigm for experimental construction of physiologically based pharmacokinetic (PB/PK) model of a potential developmental toxicant

Source: Adapted from Byczkowski and Lipscomb 1999; available on Web at <<http://members.spree.com/education/tnproj/PeriPBPK.htm>>).

3. ISSUE AREA 3: PARAMETERS DETERMINING TRANSPLACENTAL TRANSFER

3.1 INTRODUCTION

The placenta, with its associated membranes, represents a unique organ system in mammals. Not only the conduit for the movement of nutrients, waste products, trace elements, environmental agents, therapeutics, and toxicants, it also is the controller and anchor for each pregnancy. Because of these broad functions, the placenta, a maternally foreign body, plays a pivotal role in the success of the pregnancy and birth of the offspring. Further, the placenta is a site for the biotransformation of molecules and is an important component in the consideration of toxicokinetics and to what the embryo and fetus may be exposed – metabolites more toxic or perhaps less toxic. Early in gestation, as well as throughout pregnancy, the issues of cellular proliferation, differentiation, and invasion (as reflected in the implantation process for trophoblast cells) are critical considerations. As this section concentrates on the toxicokinetic interactions among xenobiotics, nutrients, waste products, and other endogenous molecules, it is important to remember that the placenta is also controlling the mother in terms of hormone production (e.g., progesterone by the corpus luteum via human chorionic gonadotropin), and converting the mother to being a fatty acid utilizer via human placental lactogen. Thus, while the principal concerns are the toxicokinetic issues, this section will also explore considerations of direct placental toxicity and implications for normal embryonic and fetal development.

This section examines placental toxicokinetic issues as they relate to:

- Species comparisons
- Gestational development
- Research methods and models both *in utero* and *in vitro*
- Classes of agents
- Placental dysfunction

3.2 TOXICOKINETIC ISSUES AND CROSS-SPECIES COMPARISONS

It is common knowledge that across species, substantial differences exist not only in placental structure but also in placental metabolic function across species (see Figures 3-1a and 3-1b; also Miller and Thiede 1981, Panigel 1978, Benirschke and Kaufmann 2000). Within a species, structural and biochemical diversity is also noted during the course of gestation. Thus, the validity of cross-species extrapolation may be substantially affected by the availability of the molecule to the site of embryonic/fetal action as altered by the placenta for each species. Second, it is essential to understand the unique nature of placental transport issues across species. Even though some species have an abbreviated gestation, they may pass through many of the same stages that humans do, except for differences in gestational length and maturity at birth (e.g., rat, guinea pig, mouse, rabbit). Other species (marsupials) may manifest an entirely different birthing process and length of gestation, and have in fact only a

visceral yolk sac (see Figure 3-2). Thus, the toxicokinetics for these animals are in fact nonplacental post-delivery (approximately 8 days for the opossum). The following discussions will concentrate on rodents, lagomorphs and primates.

Of concern for many years has been the diversity of cellular layers molecules have to passage in different species, from two cell layers to as many as six cell layers between the maternal and fetal blood supplies (see Figure 3-1b). It is significance that small molecules (e.g., oxygen and carbon dioxide, amino acids, carbohydrates, and selected proteins) do cross from mother to conceptus (Longo et al. 1974, Miller et al. 1976). Operative mechanisms may include (1) **facilitated transport** (e.g., d-glucose), (2) **active or coupled transport** (e.g, neutral amino acids and sodium), and (3) **receptor-mediated endocytosis** (e.g., transcobalamin II-vitamin B₁₂, and immunoglobulin G). For xenobiotic transport, mechanisms are likely to be different, and may be more a function of such factors as lipid solubility, ionization state, molecular weight, and ability to mimic a substance that will bind to trophoblast receptors, e.g, methylmercury-cysteine (Clarkson 1993).

Another critical factor in understanding transplacental toxicokinetics is the stage of gestation and the relationship between two different circulatory systems and membranes. In early rodent gestation, the chorioallantoic placenta is just beginning to function and its primary role is that of anchor rather than conduit. Substantial maternal blood flow and transplacental exchange only begin to be manifested after 12 days.

In humans, it has been assumed for generations that early maternal blood flow in lacunae is critical to normal embryonic development (Ramsey and Donner 1983). Obviously, after the first trimester there is no question that the maternal blood circulates around the placental villi and is critical to normal development. Of growing interest is the idea that normoxic conditions may lead to poor development of the human placenta with poor invasion of the trophoblast into the endometrium. Such hypotheses have been supported by evaluations of early placental tissue following terminations of pregnancies for psychosocial reasons, where no maternal blood is noted to be surrounding the placental villi (Hustin et al. 1986). Further evidence has evolved exploring the nature of the oxidant stress enzymes, which have entirely different placental cellular distribution patterns early in gestation than are found at term, e.g., glutathione peroxidase (Avissar et al. 1994 , Graham et al. 1999). Finally, early Doppler ultrasound evaluations have noted that in some pregnancies, maternal blood flow is noted close to the implantation site, and many of these pregnancies demonstrate reduced invasion into the endometrium and a high incidence of pre-eclampsia (Jaffe et al. 1997; and see Figure 3-3). The question may be asked: Is hypoxia actually a positive factor during early human placental development and invasion? Such maternal circulatory observations early in pregnancy give comparative developmental and reproductive toxicologists exciting possibilities for examining the obvious similarities between early rodent and primate placentation.

During the past few years, a few investigations of transport processes during very early gestation in the human have been undertaken. The entire concept of histotrophic versus hemotrophic function as related to both animals (rodents) and humans requires careful reconsideration. Burton et al. (1999) have presented morphologic evidence from Dixon Boyd's original histology collection for a histotrophic transport/metabolism in the very early human placenta. Consistent with the pioneering research of Felix Beck, John Lloyd, Robert Brent, Thomas Koszalka, and David Beckman, this work demonstrates that the metabolism of large proteins by the yolk sac contributes the largest percentage of nutrients for embryonic protein synthesis, and that neither active transport nor simple diffusion of these amino acids from mother to embryo contributes sufficient amounts (Brent et al. 1990). Furthermore, these investigators demonstrated that by altering this endocytotic process with trypan blue and antisera, they could produce pregnancy loss and birth defects in the embryos (Brent et al. 1990, Freeman et al. 1987). Thus, classical considerations of toxicokinetics during development and how the molecules may be entering the embryo and/or fetus require reevaluation.

Jauniaux et al. (1996, 1997, 1998, 1999) have performed a unique set of investigations by obtaining coelomic fluids from early human embryos at the time of pregnancy termination (see Figure 3-4). These investigators have carefully evaluated these fluids and compared them with other fluids and tissues following exposure to inulin and some other drugs. demonstrates that many of the basic nutrients and waste products normally found in the mother, e.g., creatinine, urea, and glucose, do appear to equilibrate across these membranes. Other molecules from the mother, e.g., iron, IgG, relaxin, prolactin, thyroxine, albumin, and complement factors, do not equilibrate. Molecules produced by the placenta also do not appear to equilibrate, e.g., human chorionic gonadotropin (hCG) and human placental lactogen, but rather have lower concentrations in the embryo. Levels of embryonic molecules, e.g., α -fetoprotein and ovarian cancer antigen (CA125) are, in fact, much higher in the embryo than in the maternal serum (as would be expected). Finally, it appears that cyanocobalamin (vitamin B₁₂) is concentrated in the embryo, which is consistent with other *in vitro* studies (Ng et al. 1981, Perez-D'Gregorio and Miller 1998). As noted in Table 3-2, in many instances, xenobiotics do demonstrate rapid entrance into the conceptus with equilibration with maternal serum within 25 minutes following a bolus injection. These studies are difficult to perform; however, the initial results invite reconsideration of such issues as (1) What are the kinetics of drug transfer during the time for maximal sensitivity to teratogenic action in the human? (2) Are the kinetics the same for rodent and human for early transplacental transfer? (3) What is the role of the early human yolk sac? and (4) Is its role the same as in the rodent?

3.3 TOXICOKINETIC ISSUES: MOTHER, PLACENTA, AND EMBRYO/FETUS

This section examines important contributions from mother and embryo/fetus that can modulate the transplacental movement of molecules bidirectionally.

3.3.1 Toxicokinetic Issues

When considering placental toxicokinetics, one must appreciate that there are two independent blood supplies and a number of cell types requiring transit before chemical compounds enter the fetus. For the embryo, the toxicokinetic issues become even more complex because of recent observations that maternal blood may not surround the placental villi until after 10 weeks of gestation (as noted above). Thus, two different models must be considered.

3.3.2 Maternal-Fetal Placental Transport and Maternal-Embryonic Placental Transport

Considering maternal-fetal placental transport kinetics first, there are three general compartments: (1) the mother, (2) the placenta, and (3) the fetus. All contribute to the kinetic patterns observed. This discussion will focus on the principal factors that control the toxicokinetic profiles noted for environmental and other molecules. Additional reviews and basic discussions can be found in the following review articles: Bernus et al. 1999, Longo 1973, Faber and Thornburg 1983, Levin et al. 1983.

3.3.2.1 Maternal Considerations

Time does not permit a complete review of all of the issues related to administration, exposure, uptake, metabolism, and excretion by the mother. (These issues are addressed to some extent in Issue Areas 2 and 4.) Rather, placental transport is dependent upon the presentation of the molecule to the placenta via the uterine arteries and the nature of the concentration profile for the agent and its metabolites. Thus, when using *in vitro* models for studying placental perfusions, mimicking the plasma concentration curve is of principal concern. However, *blood protein binding*, protein concentration, pH and uterine blood flow are all critical. Contained within this assessment of blood/plasma concentrations is the actual distribution of the molecule under study.

For example, study of the transfer of carbon monoxide across the placenta requires an appreciation of the nature and concentration of both the maternal and fetal red blood cells and their binding sites for carbon monoxide and oxygen (Delivoria-Papadopoulos et al. 1972, Longo et al. 1972). In addition to placental diffusing capacity, gas partial pressures in the maternal and fetal arteries, hemoglobin affinity for the gas in both maternal and fetal blood, and blood flow rates for both maternal and fetal blood supplies are all important. However, other agents that may displace binding, e.g., carbon monoxide/oxygen, carbon dioxide (as well as with Haldane and Bohr Effects) may be of importance.

Measuring only plasma concentrations of carbon monoxide for comparison would be inappropriate. It is critical to know what plasma constituents bind the molecule and to evaluate that relationship both *in utero* and *in vitro*. This is also true for other compounds, e.g., dioxin. For dioxin, use of fresh human plasma containing low-density lipoproteins (LDLs) is critical to understanding the dynamics of TCDD (dioxin) transport, as noted in the human placental perfusion studies (Dencker et al. 1987). Normally, the assumption is made that if the molecule is bound to a plasma protein, it must be bound to albumin. Obviously, however, there may be many exceptions to such a rule.

As is well known, normally it is the unbound or “free” concentration of a molecule that is taken up by a tissue, and the protein bound molecule is held in reserve (Goodman and Gilman 1998). Interestingly, for the human placenta, protein binding to selected proteins can in fact enhance the uptake of the molecule because of the presence of specific binding sites on the surface of the placenta. Examples include immunoglobulin G and transcobalamin II proteins that bind vitamin B₁₂ (Polliotti et al. 1993, Perez-D’Gregorio and Miller 1998). Macrolide antibiotics, such as erythromycin, roxithromycin, and azithromycin, do not readily transit the placenta either *in utero* or under *in vitro* perfusion conditions, demonstrating how certain classes of molecules may be restricted from the fetal compartment and reducing potential for fetal toxicity (Heikkinen et al. 2000). This has been noted also for the anticoagulant Rheopro®, a chimeric Fab fragment, (Miller et al. 1997).

Acid-base status can also dramatically affect the transfer of agents, e.g., local anesthetics, or any charged molecule (Nau 1985). Such issues grow in importance when the fetus may be compromised (acidosis) and during labor and delivery (Rooth et al. 1972).

Therefore, a number of maternal blood factors must be considered; however, *uterine blood flow* may affect the transfer of molecules as much as any other factor. Much has been written about the nature of the transfer of molecules based upon blood flow from concurrent to counter-current to pool flow (Long and Bartels 1972, Assali and Brinkman 1972, Faber 1977, Miller et al. 1976, Bernus et al. 1999). Species differences have provided a rich array of possible models from the sheep to the rodent to the primate. In all probability, the principal issue is this: How much of the chemical reaches the placenta during a given period of time? Some contend that the area under the curve (AUC) addresses all these issues. However, for some agents, peak concentration in the fetus/embryo may be the principal concern (one example would be the salicylates; Kimmel et al. 1983), yet, the pharmacologic action of the molecule or associated molecules in circulation may in fact completely change the transfer characteristics by producing uterine vasoconstriction or dilation resulting in altered blood flow to the placenta. Such pharmacologic interventions can result in a rapid change in fetal status, producing an unstable environment with altered pH, oxidant stress, and modified blood flow and leading to major impacts on normal placental transfer and associated kinetics (Gautieri 1972, Longo and Bartels 1972, Miller et al. 1976, Wier et al. 1990, Malek et al. 1998).

Thus, maternal factors — absorption, metabolism, excretion, protein binding, acid-base status, uterine blood flow, and pharmacologic actions of the molecules — can all affect the transfer of molecules from mother to fetus.

3.3.2.2 *Placental Transfer*

Diffusing capacity in the placenta, the biotransformation of the molecules by the placenta, as well as the ability of the placenta to store the molecule are all critical to understanding how molecules may transfer from mother to fetus. Of equal importance is how the molecules may enter the fetus. There are at least two possibilities: (1) Umbilical circulation and the chorioallantoic placenta or (2) Vitelline circulation and the visceral yolk sac. Species differences in route of entry can be remarkable because of the specialized cell functions in the yolk sac and in the chorioallantoic placenta, e.g., specific receptors/binding sites for specific molecules (Hemmings et al. 1970, Malek et al. 1998, Miller et al. 1976, cf. Slikker and Miller 1994).

Examples of the differences in transfer from mother to fetus or vice versa can be noted for red blood cells, sucrose, water, antipyrine, and propranolol under human placental dual perfusions (Figure 3-5). Of particular note is the fact that erythrocytes were not detected in the opposite circuit under either maternal or fetal administration conditions, while water and antipyrine did rapidly transit (as would be expected). Sucrose did not rapidly transfer but was detectable as has been noted for inulin. Propranolol did cross and was dependent upon the lipid solubility of the compound (Bernus et al. 1999). Note how different the transfer characteristics are for the neutral amino acid, alpha amino isobutyric acid (AIB), which is concentrated in the fetal circuit when equal concentrations are added to both maternal and fetal circuits. Also note that the fetal amino acid does appear on the maternal side. Thus, even while there is active transport that can be inhibited with ouabain, there is bidirectional transfer of the molecule at the same time (Wier et al. 1983). These results are contrasted with cyanocobalamin (vitamin B₁₂), which is transported by transcobalamin II, which circulates in the maternal blood and is also produced by the human placenta (Ng et al. 1981). The human placenta has specific receptors for binding transcobalamin (Friedman et al. 1982). Under placental perfusion conditions, cyanocobalamin was transferred from mother to fetus with the appearance of the the transcobalamin-bound cyanocobalamin appearing in the fetal circuit (Perez-D'Gregorio et al. 1998).

3.3.2.2.1 *Placental diffusing capacity.* Placental diffusing capacity is dependent upon the membrane diffusing capacity (area, thickness, solubility, diffusivity), blood volume, diffusing capacity of the blood for the molecule, and protein binding capacity (if molecule is protein bound). Molecular diffusion is based upon Fick's First Law:

$$[AMT \text{ of chemical crossing placenta/unit time}] = [area \text{ of exchange}] * [permeability \text{ of the membrane}] * [diffusivity \text{ of the molecule}] * [difference \text{ in concentration across the placenta / membrane thickness}].$$

The difficulty with accurately determining the placental diffusing capacity (for a gas, for example) is that the placenta is a complex structure with variable thickness and permeability (Longo et al. 1972).

Placental diffusing capacity can be calculated as:

$$D_p \text{ (ml/(min} \times \mu\text{g difference))} = \text{(amount of chemical crossing per minute)/concentration difference for mother-fetus}$$

This equation was first used to calculate gas diffusion across the placenta by Barron (Barron and Alexander 1952).

3.3.2.2.2 Biotransformation. Biotransformation by the placenta can become an important factor in regulating the appearance of molecules (especially toxicants) in the fetal circulation. For at least 50 years, it has been known that in sheep, glucose does not appear in the fetus even though glucose is circulating in the mother; the placenta of the sheep converts glucose to fructose, which appears in and is utilized by the fetus. (Alexander et al. 1955). This is a good example of the placenta's specific metabolic capability to metabolize endogenous molecules and xenobiotics resulting in a different pattern of appearance in the conceptus compared with the mother. Additional examples of specific kinetic differences will be helpful to understand the importance of placental biotransformation, not only in transfer processes, but also for mechanisms of toxicity. (Issue Area 1 on biotransformation goes into substantial depth on specific enzymes and their levels of activities in the mother, embryo, and fetus.) The human placenta also possesses both active oxidative and active conjugative enzymes (Table 3-3). Some examples of specific kinetic differences will be helpful to understanding the importance of placental biotransformation not only to transfer but also to toxicity.

The role of arylhydrocarbon induction of cytochrome P450 enzymes (see Table 3-3) demonstrates also the selectivity of the induction process in the placenta. Even though the focus of attention has been on arylhydrocarbon hydroxylase (CYP1A1) and its induction, Hakkola et al. (1997) demonstrated that the Ah receptor-regulated cytochrome P450 1B1 (CYP1B1) gene was constitutively detected at low levels in first and full-term placentae. Interestingly, CYP1B1, having different regulatory properties from CYP1A1, was not induced by cigarette smoking but could be induced by TCDD. This data set provides evidence for differential regulatory responses within the human placenta for benzo(α)pyrene from TCDD, which has been noted in other functions such as induction of hCG expression (see below). Other forms present in full-term placenta include CYP4B1 and CYP19 (steroid aromatase), which also contribute to the oxidation of other agents. At earlier stages of pregnancy, the placenta may express a wider array of CYP genes, including CYP2C, CYP2D6, and CYP3A7. Due to the small size of the fetus and low abundance of CYPs in placenta, the contribution of fetoplacental metabolism to overall gestational pharmacokinetics of drugs is probably minor (Hakkola et al. 1998). In contrast, several toxic outcomes have been ascribed to altered metabolic patterns in the fetoplacental unit, including a putative association between reduced placental oxidative capacity and birth defects. Examples of human teratogens that are

substrates for CYP enzymes include thalidomide, phenytoin, retinoids, and several hormonal agents (cf, Hakkola et al. 1998).

Induction of these monooxygenases can influence the toxicity of these molecules on the placenta itself as well as modifying transfer. Human placental arylhydrocarbon hydroxylase is induced by cigarette smoking (Welsh et al. 1968). This enzyme metabolizes a number of xenobiotics, most especially benzo(α)pyrene (BZ). Interestingly, BZ appears to alter human placental function by down-regulating the Epidermal Growth Factor (EGF) receptors that control secretion of human chorionic gonadotropin by the syncytiotrophoblast. Such adverse effects can affect the continuation of pregnancy. It should be noted that BZ did not decrease cytotrophoblast proliferation or differentiation to extravillous trophoblast cells (Angelkovic et al. 1997). This is consistent with the fact that no EGF receptors were noted on cytotrophoblast cells (Genbacev et al. 1994).

Other examples are the retinoids, which have been associated with a specific embryopathy resulting in pregnancy loss and specific birth defects (Lammer et al. 1983, Collins et al. 1999, Miller et al. 1998, Arafa et al. 2000). Current research has shown that the endogenous morphogen, all-trans-retinoic acid (TRA, aka the drug Retin-A), plays a key role in teratogenicity when levels of TRA greatly exceed “normal” circulating levels (Miller et al. 1998). (It should be noted that a TRA isomer, 13-cis retinoic acid [CRA, aka the drug Accutane], does not appear to be teratogenic in itself, but rather requires isomerization to TRA or oxidization to 4-oxo-metabolites, which are known to be teratogenic in mice [Kochhar et al. 1994, cf. Collins 1999].) Interestingly, the human placenta has the ability to both enhance isomerization of these retinoids and to form the 4-oxo-metabolites (Asai et al. 1993, Miller et al. 1992, 1993, 1998). Thus, the biotransformation of these retinoids can directly affect development. Differences in placental transfer, as well as receptor binding in mice, were attributed to exposure to three retinoids (CD 336, CD2019, CD437) with differing teratogenic potency (Arafa et al. 2000). Such data support multiple sites for the actions of retinoids in the embryo as well as the placenta depending upon both transfer and biotransformation.

Thus, biotransformation of molecules by the placenta can modulate the transport parameters for a specific molecule. It should be kept in mind that with such exposures, other molecules may modulate the biotransformation characteristics of the placenta, leading to further alterations in the transfer of the original molecules and how its metabolites reach the fetus.

3.3.2.3 Cellular Storage or Binding of Molecules

It is remarkable how often the placenta can become a storage site or depot for xenobiotics as well as nutrients. Perhaps the most obvious example is the human placenta's conversion of glucose to glycogen. However, from an environmental perspective, the issues are more often related to the availability of specialized binding sites and proteins, e.g, metallothionein. The placenta, whether primate or rodent, can be induced to produce high levels of this metal-binding protein. Normally, copper and zinc

are the endogenous binding metals; however, mercury and especially cadmium have high affinity for this protein. It appears that metallothionein can sequester maternal cadmium, resulting in a reduction in the transport of cadmium into the fetus.

On the other hand, such binding molecules can transform a freely soluble chemical into a bound molecule that is more amenable to transport into the fetal circulation (e.g., vitamin B₁₂ binding to transcobalamin proteins (Ng et al. 1982, Polliotti et al. 1996, Perez-D'Gregorio et al. 1998).

3.3.2.4 *Specific Transport Processes*

Transport of molecules across and into the placenta are essential processes, not only for the embryo/fetus but also for the placenta. Specific transporter processes present the opportunity for recognition of selected molecules and utilize one of four mechanisms:

- Facilitated diffusion – D-glucose
- Active transport – sodium and potassium, calcium
- Coupled transport with sodium – neutral amino acids, D-alanine
- Receptor-mediated endocytosis – IgG intact

Species differences in which tissues mediate these transport processes have been reported. For example, the human placenta will transfer immunoglobulins and transcobalamin II with vitamin B₁₂ via receptor-mediated endocytosis. However, the rodent and lagomorph chorioallantoic placentae will not perform such transport activities. Instead, in the rodent and rabbit, the visceral yolk sac performs these tasks (Human: Malek et al. 1998, Miller et al. 1998; Rodent and lagomorph: Brambell 1970, Wilde 1981, Polliotti et al. 1996). Disruption of the visceral yolk sac will also inhibit these transport processes (Brent et al. 1990; Beckman et al. 1990, 1998; Williams et al. 1975).

Such specificity for transport has been attributed to the presence of transporters. In the human placenta, the syncytiotrophoblast is a critical cell layer for such functions. Both the maternal brush border and the fetal basal membranes have unique transporters controlling the transfer of nutrients as well as xenobiotics (see Table 3-4). Ganapathy et al. (2000) have reviewed this topic in substantial detail as it applies to drugs and toxicants.

Both the localization of the transporter in the placenta and the direction in which the substances may be directed are important. Of special note are the p-glycoprotein transporters (also called multi-drug transporters (see Section 3.6) and the organic proton antiporters. These transporters are actually efflux transporters moving molecules out of the placenta into the maternal circulation. As noted in Table 3-4, multiple xenobiotics are controlled by these transporters. Such regulation of xenobiotic transfer may have important species differences and genetic diversity with populations.

Furthermore, a number of different xenobiotics have the affinity for different transporters (as noted in Table 3-4), which provides the opportunity for entry into the placenta and subsequently the fetus via multiple transporter sites. Such xenobiotics, e.g., anticonvulsants, may also play an important role as competitors for entry of normal nutrients, resulting in deficiencies within the fetoplacental unit. One example proposed would be biotin transfer (Ganapathy et al. 2000).

Of special significance is how environmental molecules may combine with or mimic their identity with a normal nutrient. Cysteine-methylmercury can bind with the amino acid transporters for entry into brain and fetoplacental unit (Clarkson et al. 1993).

The formation of glucuronides is an important mechanism for the inactivation of water-soluble agents as forms for easy elimination by the kidney. The placenta plays an important role in limiting the transfer of glucuronides, which is why bilirubin is not conjugated by the fetus to a large degree before birth and depends upon the mother for glucuronidation and elimination of this toxic metabolite of hemoglobin degradation. Dancis and colleagues (1958) first demonstrated that estrogen glucuronides do not easily transfer from mother to fetus across the placenta. Others have demonstrated this for valproic acid, retinoic acids, and phenytoin in the perfused human placenta (Fowler et al. 1989; Nau 1995; Dickinson et al. 1989). More recently, St. Pierre et al. (2000) demonstrated that multi-drug-resistance proteins (MRPs, P-glycoproteins) protect the fetal blood from organic ions and promote the excretion of glutathione and glucuronide conjugates, as noted in their studies with dinitrophenyl-glutathione and estradiol-glucuronide in human syncytiotrophoblast apical membrane vesicles.

Structure-activity relationships are just as important for the placenta as for any other organ; however, the transfer of the molecule may also be dependent on metabolism or the presence of specific transport mechanisms. Embryonic and fetal damage endpoints (teratogenicity, lethality, or growth restriction) may be dependent on the placenta's role in providing the toxicant to the conceptus in sufficient amounts and with the appropriate structural relationship. As noted earlier for retinoids, the placenta does perform an essential role in biotransforming these retinoids to either less toxic or more toxic metabolites (Nau 1995; Asai et al. 1993, Miller et al. 1992, 1993, 1998). Species differences in terms of placental transfer may provide an important regulatory step in preventing or reducing toxicity as noted for 13-cis-retinoic acid placental transfer in the Monkey/Human >> Rabbit/Mouse/Rat (cf. Nau 1995). The ability to isomerize, oxidize, or deconjugate the parent component places the placenta in a pivotal role in either protecting or enhancing the developmental toxicity of the chemical under investigation.

3.3.3 Fetal Distribution

Many of the same factors that apply to maternal distribution also apply to the fetus, but often in the reverse order. Such factors as umbilical blood flow, blood protein binding, excretion, acid-base status, absorption into fetal tissues, biotransformation, and pharmacologic actions of the molecules can all affect the transfer of molecules from mother to fetus itself. Confounding fetal pathology can modify the

characteristics as well. Of particular interest can be the excretion of products by the fetus. Usually these molecules will either be filtered by the kidney and appear in the amniotic fluid or be transferred back across the placenta. (See also Issue Area 2.)

Summarizing, then, there are numerous overlapping issues involving the function of the placenta in the relationship to the mother and embryo/fetus, and the impact of this relationship on the transfer of molecules from mother to fetus and vice versa. Opportunities to study the fetal period both *in utero* and *in vitro* have provided a much better understanding of this transfer. As noted above, it has often been assumed that in the human, transport processes in the first trimester and near term are similar. There certainly are similarities (Ng et al. 1983); however, complete understanding of the kinetics for transfer of molecules to the embryo is complicated by the inaccessibility of the embryo for study. However, with the advent of amniocentesis and coelocentesis, new opportunities for sampling embryonic compartments have developed (Jurkovic et al. 1993). Many of these techniques have been used in concert with terminations of pregnancies for psychosocial reasons to obtain information about the distribution of endogenous molecules and xenobiotics (Jauniaux et al. 1994, 1996, 1997, 1998a, b; 2000; Jauniaux and Gulbis 2000a, b; Gulbis et al. 1994; Ward et al. 1998; Maymon et al. 1998, 2000; Shannon et al. 1998; Cooper et al. 1999).

3.4 PLACENTAL RESEARCH TECHNIQUES: *IN UTERO/IN VITRO*

This section reviews methods used in recent investigations for examining the toxicokinetics of various toxic agents during pregnancy. Of particular interest is the ability to study placentae from different species under *in vitro* conditions and then compare those assessments with *in utero* observations within and across species. It is often undesirable or impractical to study the toxicokinetics in the human because of the characteristics of the molecules under study. Thus, it has been necessary to develop *in utero* and *in vitro* approaches that allow the *in vitro* studies to be pursued in the human without risk to mother or baby. Furthermore, *in vitro* studies often allow for multiple conditions to be examined in the same placenta. Such capabilities allow for better extrapolations across species based upon the kinetics as well as biotransformation for each molecule in different species.

3.4.1 *In Utero* Techniques

3.4.1.1 *Animal Studies*

The most commonly used animal models for reproductive and developmental toxicity studies are the rat and the rabbit. Sometimes, for specific reasons, ferrets, dogs, sheep, or nonhuman primates are used. In studying the physiology of transfer processes, multiple species have regularly been utilized, e.g., guinea pig, sheep, and goat (Wallenburg et al. 1981, Young et al. 1981). Of particular note has been the development of a method, used in goats and sheep, allowing for long-term placement of indwelling catheters (cf. Longo et al. 1976, Young et al. 1981). Catheters may be maintained for weeks in these species, allowing for direct and repeated sampling of fetal compartments for nutrients, drugs, and

toxicants (Woods and Plessinger 1989). On occasion the pig has been used for placental transport studies (Kelman et al. 1982); however, because of its size, the pig has not been as popular as the sheep or goat.

The nonhuman primate has become an important animal for comparison studies with the human. Pharmacokinetic and toxicokinetic studies have been pursued simultaneously with teratogenicity and developmental toxicity studies for pharmaceuticals as well as a number of toxic molecules (Hendrickx et al. Patterson et al. 1997, 2000, Poirer et al. 1999, cf. Slikker and Miller 1994).

In addition to the large animal studies, direct fetal injection techniques have been used to study bidirectional transfer from fetus to mother for nutrients (Miller et al. 1977, White et al. 1982, Henry and Miller 1986). The guinea pig has also proven useful for kinetic studies of toxicants, e.g., plutonium, methylmercury, lead, and cadmium (Kelman et al. 1979, 1980a, 1980b, 1981, 1982), and nutrients, e.g., vitamin C and nucleotides (Leichtweiss et al. 1987, van Kreel et al. 1987).

3.4.1.2 Human Studies

Human studies usually fall into two categories: (1) a single sampling of tissues (placenta) and bloods at delivery or termination following environmental exposure or therapeutic administration, and (2) multiple fetal blood samples obtained by fetal scalp sampling, amniocentesis, or peri-umbilical blood sampling (PUBS) during the pregnancy. The latter category is beset with substantial limitations in that the type of study is usually related to a therapeutic administration around the time of delivery. Maternal kinetics examining absorption, distribution, metabolism, and excretion are all possible, as long as the investigator can be sure that if a chemical or drug is administered to the mother, it will do no harm to the conceptus.

During the past few years, early amniocentesis and coelocentesis have provided a gateway to the exploration of the appearance and concentration of nutrients and therapeutics in the early embryo (Jauniaux et al. 1993). Such selective investigations are beginning to unravel the mysteries of the unique pharmacokinetics that are occurring early in gestation compared with at term. In combination with *in vitro* studies, these *in utero* investigations have become powerful adjuncts to understanding developmental toxicology in the human.

3.4.2 In Vitro Techniques

In vitro investigations have been important tools for understanding of human placental function because these techniques offer the ability to avoid exposing either mother or conceptus to any additional risk. Direct comparisons of placental function in a number of species can be made using identical or similar methods. Thus, such investigations provide a range of models to study human function and comparative placental toxicology. Many of these methods were reviewed a number of years ago (Miller and Berndt 1976); however, advances made in the development of new techniques since then have

provided for *in situ* perfusions in rodents and sheep (Stulc et al. 1988) as well as human placental perfusions for 12-48 hrs (Miller et al. 1985, Polliotti et al. 1996).

A number of methods can be used that are applicable in many species. Examples include use of:

- Isolated trophoblast cells
- Ussing Chamber
- Placental explants/slices
- Placental perfusions/lobular perfusions

3.4.2.1 *Isolated Trophoblast Cells*

Isolated cells or cell sheets can be used to study cellular transport processes and diotransformation processes in individual cell types. A limitation of this method has been the ability to develop the equivalent of the syncytiotrophoblast in culture. The difficulty is that the syncytiotrophoblast is a true syncytium. Thus, by definition, isolated single nuclei trophoblast cells do not represent syncytiotrophoblast; however, these cells can be induced to form syncytia. The difficulty has been to create a large enough sheet of syncytiotrophoblast to reflect what is present *in utero*. Some success has been noted by Kliman et al. (1987). Among issues of concern with using these isolated trophoblast cells is the origin of these cells, whether from primary cells or from established cell lines. Many issues continue to be discussed about the isolation of these cells, which can be reviewed in recent workshop reports (Frank et al. 2000, Frank and Morrish 2001, King et al. 2000, Shiverick and Schneider 2001). The principal concern about using isolated cells is that they do not closely represent the *in utero* situation and therefore may not provide the information sought related to toxicokinetics.

3.4.2.2 *Ussing Chamber*

The Ussing Chamber has been instrumental in developing an understanding of transport processes across epithelial layers of cells, e.g., toad skin, urinary bladder. Such clamped epithelia between two pools of solutions can be manipulated to study not only transfer of molecules but also potential differences across these membranes. It is possible to use human chorioamnion under these conditions (Seeds et al. 1972, cf. Miller and Berndt 1976). Further adaptations of these chambers have been used to study the tensile strength of the human membranes in relationship to issues related to premature rupture of membranes (Woods et al. 2001, Woods 2001).

3.4.2.3 *Placental Explants/Slices*

These short-term culture techniques have been widely used to identify how compounds are transported into the villus of the placenta (Dancis et al. 1972; Miller et al. 1974, cf. Miller and Berndt 1976; Ng et al. 1981). Of significance is the fact that not only uptake, but also efflux can be examined (Miller et al. 1974); however, tissue efflux examined from the tissue does not reflect transport into the

fetal circulation and out, but rather uptake from the maternal lacunae and release into the maternal lacunae. These techniques provide invaluable information about the kinetics of the uptake processes for molecules in the villus. In particular, such issues as specificity of uptake, receptor dependence, energy dependence of the uptake process, associated molecules for possible coupled transport can all be studied. Most importantly, these transport and metabolism processes can be studied under identical conditions for a number of different molecules at different stages of gestation (Ng and Miller 1983). Also, the transport processes for molecules from different species can be compared (cf. Miller 1986, Slikker and Miller 1994).

Adaptations of incubations in beakers to periperfusion of the slices have allowed for assessment of transport and placental utilization and production of molecules on a continuing basis (Kay et al. 1994). These explant techniques can also be used to study the implantation process (trophoblast proliferation, differentiation to extravillous trophoblast cells, and invasion) using explant cultures on extracellular matrices e.g., matrigel (Genbacev et al. 1992). This technique has been described in detail elsewhere (Genbacev and Miller, 1993b). Of particular note, the explant culture on matrigel has been particularly useful for examining alterations in cell proliferation, differentiation and invasion by toxicants (see Figure 3-7, cf. Genbacev and Miller 1993c, and Genbacev and Miller 2000).

One tremendous advantage of these explant/slice techniques is the ability to create multiple study environments from the same placental tissue, allowing for duplication of results and testing of multiple toxicants or other conditions, while having controls for comparisons. The principal limitation with these explant/slice techniques related to transport is the inability to examine the transplacental movement from mother to fetus or fetus to mother. To do so requires dual perfusion of the human placental lobule *in vitro*.

3.4.2.4 Placental Perfusion/Lobule Perfusion

For more than 50 years, placentae have been perfused from the fetal side only, as the entire placenta (Krantz 1954, Maulik 1978) and as one or two lobules (Panigel 1960, Schneider et al. 1972). Dual perfusion techniques have evolved over the years and require an intact lobule at a minimum. Criteria have been established for the proper use of these techniques (see Table 3-5; and Schneider and Dancis 1987; Wier and Miller 1989; Miller et al. 1989, 1993).

3.5 EFFECTS OF TOXIC AGENTS ON THE PLACENTA

3.5.1 Metals

From an environmental risk assessment perspective, the toxicological role played by metals has been found to be important both in adults and to the conceptus. It has been observed that some metals rapidly transfer to the conceptus while different ionic forms of the same metal do not. Thus, the characteristics of each metal must be examined and evaluated not only for transport across the placenta

but also for actions on the placenta, e.g., with metallothionein. Characteristics of a selection of metals are reviewed below.

3.5.1.1 *Arsenic*

In the environment, arsenic is found primarily in the pentavalent form (arsenate), except under reducing conditions, e.g., in deep well water, in which it may be present as the trivalent form (arsenite). Human exposure to arsenic occurs through water and food, with marine seafood containing significant amounts. Arsenic in seafood is found in organic compounds, including methyl- and dimethylarsenic acids, arsenobetaine, arsenocholine, and arsonium phospholipids (WHO 1981). Arsenic exposure can also occur through cigarette smoking, although the arsenic content of tobacco has been reduced in recent years. Occupational exposure to arsenic is a concern among smelter workers and individuals involved in the use and production of arsenic-containing pesticides. Arsenic compounds have also been used in medicine.

Both oxidation and reduction of arsenic can occur biologically; pentavalent arsenic can be found after treatment of animals with trivalent arsenic, and trivalent arsenic is recovered following treatment with pentavalent arsenic (Goyer 1986). The principal form of arsenic found in the urine following inorganic arsenic exposure is dimethylarsenic acid (Goyer et al. 1986). The methylation of arsenic, which occurs via B₁₂ independent pathways (Chen et al. 1992), is considered to detoxify arsenic (note that S-adenosylmethionine is *not* the methyl donor). The organic arsenic compounds found in fish are thought to be excreted primarily in the urine without being biotransformed (WHO 1981).

In general, trivalent arsenic is retained in organs to a greater degree than pentavalent arsenic, and trivalent arsenite is considered to be the toxic form. Arsenic has high affinity for sulfhydryl groups, which contributes to the accumulation of arsenic in keratin-containing tissues, skin, and hair. Hair arsenic levels have been used to assess human arsenic exposure (WHO 1981). The affinity of arsenic for sulfhydryl groups results in inhibition of numerous enzymes. In particular, arsenic interferes with enzymes of respiration and uncouples mitochondrial respiration (WHO 1981).

Arsenic in drinking water is regulated on the basis of skin effects (50 mg/L in the U.S.). These effects are described as hyper- and hypopigmentation, hyperkeratosis on palms and soles, and punctate keratoses. Skin cancer (multicentric basal cell and squamous cell carcinoma) is observed only in populations in which other skin effects are observed. Based on epidemiology studies completed in Taiwan and Bengal, reviewed by Stöhrer (1991), the threshold drinking water concentration for these effects appears to be 100 µg/L (400 mg/day based on tropical water intake of 4 L/day), with hyperpigmentation observed in almost everyone exposed to 200 µg/L arsenic for 1 year in the Bengal study.

3.5.1.1.1 *Animal investigations.* Arsenic does cross the placenta, and single injection doses of arsenic are teratogenic in hamsters (Ferm and Carpenter 1968) and mice (Hood et al. 1977). Methylated arsenic

compounds are less teratogenic than inorganic arsenic (Harrison et al. 1980, Hood et al. 1982) and trivalent arsenic is more teratogenic than pentavalent arsenic. The differences in teratogenicity of trivalent and pentavalent arsenic are thought to result from differences in the toxicity of the two forms, rather than from differences in the placental pharmacokinetics (Dencker et al. 1983).

Hood et al. (1987, 1988) have examined the uptake, distribution, and metabolism of sodium arsenite (25 mg/kg) and sodium arsenate (40 mg/kg) given by gavage to pregnant mice on gestation day 18. Following treatment, placental arsenic concentrations peaked 4 and 2 hours after dosing with arsenite and arsenate, respectively. Fetal levels peaked 6 hours after mice were treated with arsenate, while after arsenite treatment, the highest fetal arsenic concentrations were observed at the last time point, 24 hours after treatment. Greater than 80 percent of the arsenic in the fetuses was methylated (mono and dimethyl arsenic) following treatment with either arsenic form. The source of the methylated arsenic found in fetuses was not established.

Hanlon and Ferm (1987) studied the concentration and chemical state of arsenic in the placentae of hamsters treated with sodium arsenate via osmotic mini-pumps for 48 hours. The animals were treated beginning on gestation day 6 and euthanized on gestation day 8. The doses used ranged from minimally (106-114 $\mu\text{mol/kg}$) to frankly teratogenic (200-223 mmol/kg). Total placental arsenic concentrations were higher than maternal blood concentrations at all doses. As a percentage of total arsenic, dimethylarsenate accounted for about 11 percent. Approximately 70 percent of the placental arsenic was bound to macromolecules, with reversibly bound arsenic accounting for two-thirds. The remaining arsenic was inorganic. Chromatography of inorganic arsenic at the high dose indicated that 40 percent was in the form of arsenate and 60 percent as arsenite.

3.5.1.1.2 Human investigations. Arsenic crosses the human placenta. In relatively unexposed populations, maternal and cord blood arsenic levels were similar in two studies. In a study completed in the United States (Kagey et al. 1977), the geometric mean of maternal blood levels were 3.0 ng/mL (N = 52) and 1.17 ng/mL (N = 49) in Charlotte, North Carolina, and Birmingham, Alabama, while cord blood concentrations were 2.23 ng/mL (N = 51) and 1.69 ng/mL (N = 48) in the two cities. The placental levels were 1.32 ng/g in Charlotte, and 1.87 ng/g in Birmingham, indicating that in persons without known occupational exposures to arsenic, the placenta does not accumulate arsenic relative to concentrations found in the blood. No difference in arsenic in maternal or cord blood was observed among smokers and nonsmokers. In a study from Taiwan (Soong et al. 1991), 82 pairs of maternal and cord blood were examined. Mean arsenic concentrations were 6.98 ± 5.25 and 7.89 ± 6.07 ng/mL for maternal and cord blood, respectively. A positive correlation ($R = 0.57$) between maternal and cord blood arsenic was noted. Placental arsenic levels were not reported in this study.

A preliminary report (Tabacova et al. 1992) suggests that placental arsenic concentrations reflect environmental exposure. Placental arsenic concentrations averaged 7.4 ng/g in placentae from individuals

living in areas of Bulgaria with no industrial sources of metal pollution, in contrast to 26.6 ng/g in placentae from individuals living near copper smelters.

At high levels, acute exposure to arsenic can result in adverse fetal effects. In a case report (Lugo et al. 1969), a woman 30 weeks pregnant attempted suicide with arsenic (about 30 mL arsenic trioxide solution containing 1.32 percent arsenic). Despite treatment with the chelator, BAL, 24 hours after the ingestion, symptoms became worse during the following 3 days and on the third day she delivered a 1,100 g live infant. The infant had progressive respiratory distress, and primarily as a result of prematurity, died at 11 hours of age. Arsenic content of fetal liver, kidney, and brain were 7.4, 1.5, and 0.22 mg As₂O₃/g of wet tissue. Unfortunately, the placenta was discarded before it was examined.

There is some evidence to suggest that adverse reproductive outcomes can occur in humans chronically exposed to arsenic at lower levels. Nordström et al. (1979) reported an increase in multiple malformations in infants born to workers exposed to high concentrations of arsenic at a copper smelter in Sweden. These workers were also reported to have an increased frequency of chromosomal aberrations. An increase in the frequency of spontaneous abortion was observed in women living nearest to the smelter, relative to women living more than 50 km from the plant (Nordström et al. 1978). Unfortunately, exposures at and near the smelter involved a number of heavy metals as well as sulfur dioxide, so the specific cause of the malformation and spontaneous abortion excess cannot be determined (WHO 1981).

Tabacova et al. (1992) noted a reduction in birthweight among infants born to individuals living near copper smelters in Bulgaria, relative to nonexposed individuals. The levels of lipid peroxides in the placentae increased with arsenic, while a decrease in the reduced/total glutathione ratio was observed.

Preliminary data from a study in Hungary (Börzsönyi et al. 1992) provide additional support that arsenic exposure may increase the risk of spontaneous abortion and stillbirths. In this study, rates of spontaneous abortion and stillbirths were 69.57 and 7.68 per 1,000 live births (total live births = 5,218) in a population that drank deep well water containing arsenic at >100 mg/L. In a similar population with low arsenic concentrations in the drinking water (not further defined), rates of spontaneous abortion and stillbirths were 51.14 and 2.84 per 1,000 live births (total live births = 2,112). The differences between the two populations were statistically significant (chi square test) at $p = 0.007$ for spontaneous abortion and $p = 0.028$ for stillbirths. In this study the exposed population was clearly receiving relatively high levels of arsenic; there were many cases of arsenical hyperkeratosis and hyperpigmentation in both children and adults. Ongoing studies of these populations should provide further insight into the human reproductive toxicity of arsenic and the relationship to exposure.

The increase in malformations, spontaneous abortions and stillbirths reported in arsenic-exposed individuals has been in part attributed to arsenic-induced genetic damage (Nordström et al. 1978). These effects have been noted in populations in which other arsenic effects were found, e.g., chromosomal aberrations in the smelter workers and skin effects in individuals consuming arsenic-contaminated

drinking water. The possible contribution of arsenic effects on placental function to the increases in spontaneous abortions and stillbirths, including effects on placental oxidative status and enzymes of respiration, requires further investigation.

3.5.1.2 Cadmium

Cadmium is a well-known nephrotoxic metal. In fact, the monitoring of toxic effects in humans is based upon renal indicators (Friberg et al. 1974). However, the placenta appears to accumulate more cadmium than the kidney and becomes intoxicated at lower tissue concentrations than noted for the kidney (see Table 3-6, and Levin and Miller 1981, Levin et al. 1983, di Sant'Agnes et al. 1983, Parizek 1964, Wier and Miller 1987). Case reports of apparent increased pregnancy loss associated with cadmium intoxication in the human adds further support in the human for reproductive and developmental toxicity of cadmium as has been noted in animals (Eisenmann and Miller 1996, Levin et al. 1980). Numerous investigations have demonstrated a strong correlation between placental levels of cadmium and maternal blood levels as well as smoking (see Table 3-6, and Kunhert et al. 1991, Miller et al. 1986, Miller and Shiakh 1988).

Of particular note, there have been numerous reports in animal studies of alterations in placental transport of zinc, calcium, and vitamin B₁₂, but not of amino acids (Samarawickrama and Webb 1979, Webb and Samarawickrama 1981, Stulc et al. 1990, Danielsson and Dencker 1984). Similar inhibition of zinc transfer has been noted in the human placenta *in vitro* following acute cadmium exposure (Wier et al. 1990). Calcium transport has been decreased in human choriocarcinoma cells (JEG-3) (Lin et al. 1997). The authors believe the alteration in calcium transport is due to modifications in subcellular, cytosolic Ca⁺⁺ binding activities rather than perturbations in calcium channel or membrane calcium pump activities.

3.5.1.2.1. Animal investigations. Relative to the other chemicals discussed in this section, the placental effects of cadmium are the most well-documented. In rats and mice fed up to 100 ppm cadmium in their drinking water throughout gestation, cadmium accumulated in the placenta, and fetal zinc levels were decreased (Webster 1988, Sowa and Steibert 1985). The changes in fetal zinc levels resulting from cadmium exposure may result from the induction of metal-binding metallothionein proteins in maternal tissues and the placenta (Hazelhoff Roelzema et al. 1989). Cadmium is slowly transferred from mother to fetus in the rat with concentrations appearing in the placenta that are in excess of those noted in either the mother or fetus (see Figure 3-8, and Sonnawane et al. 1975, Levin et al. 1987). Metallothioneins may retain metals in maternal tissues and the placenta, reducing cadmium transport to the fetus and altering essential metal transport.

Cadmium is clearly a placental toxicant in animals given an acute subcutaneous injection. Parizek (1965) reported death (maternal and fetal), placental necrosis, and generalized visceral venous congestion and hemorrhages in the kidneys and adrenals in pregnant rats treated with a subcutaneous dose of 20 mmol Cd/kg on gestation day 18. Levin and Miller (1981) observed fetal lethality, placental necrosis, and

alterations in uteroplacental blood flow in pregnant rats treated with cadmium (40 mmol/kg) on gestation day 18. Microscopic examination of placentae from rats euthanized 12-96 hours after treatment revealed hemorrhagic necrosis, congestion of the labyrinthine portion of the placenta, and infiltration by polymorphonuclear leukocytes.

Ultrastructural studies (di Sant'Agnesse et al. 1983, Cho et al. 1988) of placentae from rats treated in a similar manner and euthanized 1-14 hours after cadmium treatment showed that the trophoblast cell layer II (a syncytial layer) was most sensitive. Early effects noted in cell layer II included lysosomal vesiculation, nuclear chromatin clumping, nucleolar changes, and mitochondrial calcification. Later changes included extracellular deposition of fibrin and platelets, congestion of the maternal blood space and fetal capillaries, and necrosis of the trophoblast layers. In contrast, fetal capillaries were often intact.

Placental toxicity was responsible for the fetal deaths observed in rats treated with cadmium on gestation day 18 (see Figure 3-9, and Levin and Miller 1980). Maternal injection (subcutaneous, 40 $\mu\text{mol/kg}$) of cadmium, resulting in fetal cadmium body burdens of 8.6 ± 4.4 nmol, caused the death of 74.9 percent of fetuses. In contrast, direct injection of gestation day 18 fetuses, resulting in fetal body burdens of 74 ± 34.8 nmol, caused death of 11.5 percent of fetuses, which was not substantially different from control injections of solvent. It should be noted that when the directly injected fetuses were examined postnatally, hydrocephalus and edema were noted (White et al. 1988). Such experiments demonstrate that the placenta may actually be accumulating cadmium and acting as a protective sink, preventing the movement of large amounts of cadmium to the fetus, where cadmium could cause direct damage. It is also noted that even though the acute uptake of cadmium by the placenta is second only to the liver on a tissue concentration basis, the placenta can become intoxicated, leading to necrosis in and the eventual demise of the fetus. Interestingly, placental toxic effects in pregnant rats were associated with blood levels that did not produce acute gross nephrotoxicity. However, cadmium-metallothionein injected intravenously *did* produce acute nephrotoxicity in the near-term pregnant rat without any placental toxicity (Levin et al. 1983).

3.5.1.2.2 Human investigations. Human cadmium exposure in the nonsmoking public occurs principally from the ingestion of food, with grains, shellfish, and liver and kidney from contaminated animals containing the highest cadmium concentrations. The disease Itai-Itai is associated with endemic contamination with cadmium. As noted in Table 3-6, patients with this disease have elevated blood, kidney and liver cadmium levels and may develop renal disease, among other morbidity and mortality issues (Nogawa and Kido 1996). The total dietary cadmium intake in the United States is approximately 5-18 mg/day, of which about 5 percent is absorbed (Reddy and Hayes 1989). Cadmium blood levels in adults not excessively exposed to cadmium are usually below 0.009 nmol/ml or 1 ng/mL (Goyer 1986). For comparison, the blood levels attained in Itai-Itai disease ranged between 0.095 and 0.415 nmol/mL (Nogawa and Kido 1996).

Besides the maternal blood level issues, as noted from the animal studies, the critical concentrations for cadmium may in fact be tissue levels, which have been monitored in occupational exposures. If we compare human renal levels and placental levels for toxic action, there is an interesting relationship. As noted in Table 3-6, the renal concentrations of cadmium can range from 50 to 1,932 nmol/gm wet weight (Nogawa and Kido 1996). In current studies of pregnant women without expressed cadmium toxicity, the placental mean cadmium concentrations range from 0.052 to 2.05 nmol/mL. This is 25-fold less than reported tissue levels for the kidney in Itai-Itai victims. Interestingly, both the animal studies (Levin et al. 1986) and the *in vitro* human placental perfusion studies demonstrate that placental levels of cadmium associated with placental toxicity range between 40 and 80 nmol/gm in the rat placenta and between 20 and 40 nmol/gm in the human placenta.

Cigarette smoking is a major source of cadmium exposure, and approximately 15 to 30 percent of inhaled cadmium is absorbed (Goyer 1986). Cigarette smoking is associated with decreased infant birthweight, as well as placental changes including increased subchorionic fibrin deposits and placental calcifications (Christianson 1979). Does cadmium exposure contribute to the adverse developmental effects of smoking? Loiacono et al. (1992) found no association between birthweight and placental cadmium concentrations in women living near a lead smelter. Placental cadmium concentrations in these women (0.73 nmol/g dry weight) were similar to levels reported in smokers, suggesting that factors in addition to cadmium are responsible for the association between smoking and decreased birthweight.

When human placental lobules are dually perfused *in vitro*, the kinetics of cadmium transfer resemble those of the rodent (see Figure 3-8). High concentrations of cadmium are localized in the human placenta (see Figure 3-10), which is associated with toxic actions. A number of different cellular processes have been proposed as sites for the action of cadmium in producing its cellular toxicity. A number of investigations have focused on the placenta as a target site (Parizek 1964, 1965; Levin and Miller 1980; Levin et al. 1981, 1983; Lehman and Poisner 1984; Wier et al. 1990; Miller et al. 1991; Torreblanca et al. 1992; Sorel and Graziano 1992; Page et al. 1992; Eisenmann and Miller 1995).

There are actually two major components to the placental toxicity of cadmium: (1) the direct toxicity of cadmium, and (2) the cellular defense processes available in the placenta to prevent the toxicity. Some responses by the placenta have been reported to be altered, these include **transport processes** for amino acids (decrease), cyanocobalamin (decrease) (Danielsson et al. 1984), copper, iron (decrease) (Sowa and Siebert 1986), zinc (decrease) (Page et al. 1992, Sorel and Graziano 1992, Wier et al. 1990) (increased) (Torreblanca et al. 1992); **cellular metabolism** – ATP levels (no change) (Miller et al. 1991), glucose utilization (no change) (Wier et al. 1990), lactate production (no change) (Wier et al. 1990), human chorionic gonadotropin production (decrease) (Wier et al. 1990), progesterone production (decrease) (Jolibois et al. 1999), oxygen consumption (no change) (Wier et al. 1990), prostacyclin/thromboxane ratio (altered) (Eisenmann and Miller 1995); **enzyme activity** – succinate dehydrogenase (decrease) (Cho and Panigel 1986), glucose-6 dehydrogenase (decrease) (Boadi et al. 1992), glutathione

peroxidase (decrease) (Eisenman and Miller 1995); and **morphology** – ultrastructural damage (Wier et al. 1990).

3.5.1.2.3 Cellular defense mechanisms. Cellular defense mechanisms utilized by the placenta can be important in modulating the toxicity of metals. Two such defenses will be discussed in association with cadmium: (1) glutathione and (2) metallothionein. Both of these molecules have an affinity for binding cadmium, and bound cadmium is not toxic to the placenta. Glutathione can protect against the placental toxicity of cadmium when added exogenously to culture medium (Eisenmann and Miller 1995). The addition of glutathione is thought to prevent the actions of cadmium on the production of 6-keto-prostaglandin $F_{1\alpha}$, the inactive hydrolysis product of prostacyclin. Glutathione also maintains the thromboxane A_2 /prostacyclin ratio.

Metallothionein, a 6,000-kilodalton inducible cysteine-rich protein, has six metal binding sites. It provides intracellular protection against the toxicity of selected metals. It is well known that when metallothionein is induced, it can protect against the cellular toxicity of metals. When metallothionein (MT) is localized to the nucleus, it can protect DNA from oxidative damage (Chubatsu et al. 1993, Klaassen et al. 1999). Metallothionein can be induced in the perfused term human placenta and in cultured human term and early trimester trophoblast cells following exposure to cadmium (Waalkes 1984, Lehman and Poisner 1984, Goyer et al. 1992, Boadi et al. 1991, Breen et al. 1994a, 1995). In the at-term human placenta, cadmium-mediated induction of metallothionein occurs rapidly, as noted by the accumulation of mRNA for MTIIa, an isoform of MT, following 8 hours of exposure to 20 FM of cadmium (see Figure 3-11, and Breen et al. 1994b). In first trimester human placental explants, metallothionein (mRNA and protein) localizes in cells of the villus core and in cytotrophoblast cells (Breen et al. 1994b). Thus, different trophoblast cells can be responding at different times during gestation to the induction of metallothionein by cadmium.

Since metallothionein can be nephrotoxic, Tyl et al. (1979) proposed that MT could be directly toxic to the placenta, and thus responsible for the lesions noted in the placenta. It was certainly a fascinating concept at the time; however, neither the time course for transit of cadmium nor the developmental toxicity for cadmium fit the possibilities for metallothionein. Also, the placenta did not accumulate cadmium as was noted when free cadmium was given. When an amount of Cd-metallothionein equivalent to the cadmium content in an induced adult rat liver was injected intravenously into a near-term pregnant rat, no placental toxicity was noted (Levin et al. 1983). Thus, it appears that even though circulating plasma Cd-metallothionein is nephrotoxic, it does not appear to be toxic to the rodent placenta.

Metallothionein (both mRNA and protein) can be induced in cultured term human trophoblast (JAR) cell lines. (Lehman and Poisner 1984, Wade et al. 1986). Moreover, these trophoblast cells may be exposed chronically to low concentrations of cadmium (2 mM) for months. These human trophoblast cells adapt to this toxic environment of cadmium by altering the expression and intracellular localization

of metallothionein (Breen et al. 1995). Using conventional and confocal microscopy, the cellular localization of metallothionein in cadmium-exposed versus unexposed trophoblast cells is found to be markedly different. In unexposed trophoblast cells, the metallothionein was primarily perinuclear with low-level, punctate expression in the cytosol. Following either chronic or 24-hour exposure to cadmium (2 mM), the metallothionein protein levels increased at least threefold, and the metallothionein was localized inside the nucleus with a lacy, cytoskeletal pattern in the cytosol. Nuclear accumulation of metallothionein is dependent upon new protein synthesis (Breen et al. 1995). Such alterations in the localization of metallothionein, not only in the nucleus but also in the cytoskeleton, may play an essential role in protecting the placenta from acute exposures to cadmium.

Cadmium can produce toxic placental responses in multiple species including the human, both at term and also peri-implantation. Some possible sites of toxic action appear to have been eliminated, e.g., carbohydrate metabolism and ATP generation. However, other possibilities still open to question include, for example, protein synthesis (hCG, hPL), oxidative damage, enzyme inhibition of glutathione peroxidase and prostacyclin synthase, and steps in the regulation of the cell cycle (possibly via cyclins and protein kinases).

In many ways, the investigation of cadmium and its effects on the placenta is similar to the investigation of the teratogenic dose of vitamin A. The studies by Rothman et al. (1995) examined the available population, which reported no toxic responses for vitamin A, nor did the pharmacokinetics fit with the exposure level, which was 10,000-30,000 IU/day (Miller et al. 1998). Berlin et al. (1992) and Loiacono et al. (1994) examined smelter workers; however, there were no reports in the papers that they studied patients who had experienced problem pregnancies, e.g., pregnancy losses, birth defects or IUGR pregnancies. Thus, the regulatory aspects of the workplace may not have placed the workers at greater risk than smoking cigarettes. Of note, there are two brief case reports of cadmium-intoxicated women with nephrotoxicity having repeated miscarriages (Eisenmann and Miller 1996). Two high school welding teachers, who were also cigarette smokers, had elevated cadmium in their urine and increased urinary levels of β -microglobulins. (It was determined that their industrial arts classrooms did not have appropriate ventilation.) Of particular interest was the additional observation that both of these women had suffered multiple miscarriages (at < 8 weeks of pregnancy). The association between the pregnancy losses and cadmium is interesting but inconclusive. Certainly, other exposures and disease processes, which were not identified in these women, might have been involved. Of particular interest is the observation in our laboratory that cadmium can reduce the proliferation and differentiation of cytotrophoblast cell columns in the early first trimester human placenta in explant cultures and in JAr cells (Powlin et al. 1994, 1995).

Thus, the conclusions from this collective set of animal and human data certainly do support the idea that cadmium can be toxic to the placenta at tissue levels that are less than, or at the lower range of, the nephrotoxic tissue concentrations (see Miller 2001).

3.5.1.3 *Lead*

Lead is widely distributed throughout the environment, resulting in a relatively high background exposure. Lead exposures resulting in adverse effects are associated with various human activities, e.g., lead-based paints, lead in plumbing and water distribution systems, and lead in air from combustion of leaded fuels and industrial activities. In countries where leaded gasoline is still used, lead emissions from cars may contribute 20 percent of the lead burden in adults and 35 percent or more in children (Krewski et al. 1989). Human lead exposure is reviewed in detail in Needleman (1992).

The absorption of lead through the gastrointestinal tract varies with age. Children absorb about 41 percent of ingested lead, while only 5-15 percent is absorbed in adults (Goyer 1986). Lead that is deposited in the lungs is almost completely absorbed. Whole blood lead is the most commonly used biological index of systemic lead exposure in human populations. Blood lead may represent recent exposure, as well as a (poorly defined) fraction from lead previously deposited in the skeleton (Mushak et al. 1989). There appear to be at least two kinetic pools of lead: (1) a labile, soft-tissue pool, and (2) lead deposited in the skeleton, which has a half-life of greater than 20 years. Lead does enter the central nervous system and tends to concentrate in gray matter (Goyer 1986). Urinary excretion is the principal route of lead elimination.

At high blood lead concentrations (>400 ng/mL), essentially all body systems, including the reproductive system, will be affected or be at risk for injury (Mushak et al. 1989). High doses of lead causes sterility, abortion, and neonatal mortality and morbidity. Further details of the reproductive effects of lead are reviewed in Miller and Bellinger (1993).

The nervous system, hematopoietic system, and kidneys are the principal targets of lead toxicity, while the developing nervous system is the most sensitive target of lead toxicity. Prenatal and childhood lead exposure is associated with deficits in later neurobehavioral performance, e.g., Bayley Mental Development Index. The prenatal period of exposure is thought to be the most critical (Mushak et al. 1989). Meta-analysis of retrospective studies concerning low-dose lead exposure and intellectual deficit in children supports the link, as do animal studies and prospective human studies (Gatsonis and Needleman 1992). No clear threshold for neurological deficits in children has been identified, and a blood lead concentration of 100-150 ng/mL is considered to be a level of concern for these effects (Mushak et al. 1989).

At the cellular level, lead can interfere with protein synthesis, inhibit membrane and mitochondrial enzymes, as well as impair heme biosynthesis. These effects contribute to the observed organ system effects. For example, inhibition of heme biosynthesis not only results in anemia at high lead doses, but also affects the levels of hemoproteins in the liver, brain, and kidneys. A reduction in heme proteins in the brain may contribute to the nervous system effects, while in the kidneys, a reduction in heme production may affect the levels of 1,25-(OH)₂-vitamin D, which has a role in the regulation of

calcium metabolism (Mushak et al. 1989). Lead, which has properties similar to calcium, may also directly compete with calcium to activate critical regulatory enzymes (Bondy 1989). Lead can produce deficits in neurotransmission via inhibition of cholinergic function. Impairment of dopamine uptake by synaptosomes and impairment of γ -aminobutyric acid have also been noted (Goyer 1986).

3.5.1.3.1 *Animal investigations.* Lead clearly crosses the placenta, and animal studies support human observations of behavioral effects following *in utero* exposure to lead (WHO 1977, Rice 1992). In addition to behavioral effects, lead has also been shown to decrease fetal weight. For example, fetal weight was significantly decreased in rats given lead in the drinking water throughout pregnancy at concentrations of 100 mg/L and greater (Dilts and Ahokas 1979). A pair-feeding study showed that this effect was a result of reduced maternal food intake, as well as a direct effect on the fetus. Gerber et al. (1978) have found that treatment of mice with lead (0.5 percent in the diet on gestation days 8-18) reduced placental blood flow, an effect that may contribute to the fetal effects of lead.

Danielsson et al. (1983) examined the placental transfer of lead (as ^{203}Pb nitrate) given to pregnant mice by intravenous injection at different stages of gestation (days 8-18). Lead was found in embryonic and fetal tissues at all stages of gestation, with the highest fetal uptake observed later in gestation. During early stages of gestation (days 8-11), lead was found predominantly in embryonic blood. Beginning on day 12, lead was taken up by the fetal liver and cartilaginous skeleton, and a large accumulation of lead was observed in calcified bone on days 14-18. This study was qualitative in nature, as lead transfer was assessed by autoradiography.

Nutritional status has been shown to influence the fetal uptake and toxicity of lead. Calcium deficiency increased fetal toxicity (Jacquet & Gerber 1979) and fetal levels of lead in mice (Leonard et al. 1983). Singh et al. (1991) examined the placental and fetal uptake of lead in iron-sufficient and iron-deficient rats. Rats were given lead in the drinking water at 250-2,500 ppm on gestation days 15-20. Lead levels in maternal blood, placenta, and fetuses were higher in iron-deficient relative to iron-sufficient rats. Maternal blood levels showed a dose-dependent increase in lead content. This was not observed in placenta or fetuses, leading the authors to suggest that later in gestation, at high lead exposure levels, the placenta may serve as a partial barrier to lead transfer. Histopathological changes were observed in fetal kidneys at all dose levels. Histology of maternal tissues was not described.

3.5.1.3.2 *Human investigations.* Human data demonstrate that lead crosses the placenta. A number of studies in which lead levels were measured in maternal and cord blood as well as the placenta are summarized in Table 3-7. These studies show that at term, cord blood lead concentrations are generally slightly lower than maternal blood lead concentrations. Reported averages of individual cord/maternal blood lead ratios are 0.7 (Milman et al. 1988) and 0.83 (Troster and Schuartsman 1988). The lower cord blood relative to maternal blood lead concentrations are likely a result of lead uptake by the fetus, rather than the placenta acting as a barrier to lead transfer.

Placental lead levels are variable, but in general, the placenta does not accumulate lead relative to maternal and cord blood (Angel and Lavery 1982; also see Table 3-7). The exception is the study by Loiacona et al. (1992) in which placental lead levels (895.1 ng/g unexposed; 2,871 ng/g exposed) are an order of magnitude greater than blood levels. Blood lead levels reported in this study are in the range of other studies, and no explanation for the high placental lead levels is readily apparent.

The highest cord blood levels in a non-occupationally exposed population, 318 ng/mL, were reported by Creason et al. (1976) in a study completed in the United States. These levels are well above the 100-150 ng/mL level of concern, and because no exposure was described that could account for these high levels, they may be a result of contamination or of analytical and reporting errors.

In general, people living in urban areas tend to have higher blood levels than those living in rural areas. Although there are some exceptions, e.g., Toronto (Koren et al. 1990), the higher urban blood lead concentrations are reflected in Table 3-7. Higher blood levels, above the 100-150 ng/mL level of concern, were found in individuals living near a lead mine (Clark 1977) and a lead smelter (Loiacona et al. 1992).

An interesting case report (Mayer-Popken et al. 1986) has shown that exposure early in gestation can result in fetal lead levels being higher than maternal levels. In this case, conception occurred at the beginning of a 16-day period in which the women were exposed to high concentrations of lead dust for 8 hours/day at a small plant producing decorative lead plates. Production was stopped after 8 weeks because several employees showed symptoms of acute lead intoxication and required hospitalization. Symptoms in other employees prompted blood lead measurements to be completed in the case several weeks after exposure had ended. Based on several blood lead levels determined over a 7-month period, and a half-life of 20 days for the elimination of lead from blood, a maximum maternal blood lead concentration of 1,200 ng/mL was estimated to have occurred near conception. At approximately 3 months of gestation, the pregnancy was terminated for unspecified medical reasons. Measurement of fetal lead content showed that lead accumulated in the skeleton (rib: 1.2 mg/g dry weight) and liver (7.9 mg/g dry weight) with levels of 1.2 mg/g dry weight in the placenta. Cord blood levels, 1,060 ng/mL, were more than twice that of estimated concurrent maternal blood levels (approximately 400 ng/mL).

This case suggests that following acute lead exposure early in gestation, fetal blood levels are not determined by maternal blood levels, but by liberation of fetal lead deposits in the liver and bone. This case also raises the question of the role of the placenta as a barrier to the fetal elimination of lead.

As stated earlier, the developing nervous system is the most sensitive target of lead toxicity. In addition to neurobehavioral effects, EEG profiles as well as decreased hearing acuity have been noted in children exposed to lead *in utero* (Mushak et al. 1989). The effects on the developing nervous system are likely a direct effect of lead rather than a result of placental effects.

A number of epidemiology studies reviewed by Mushak et al. (1989) and Miller and Bellinger (1993) have reported an association of lead levels with preterm labor and decreased birthweight. Both effects occurred at prenatal blood levels below 150 ng/mL, and it has been suggested that the length of gestation is shortened by about one-half week for every 100 ng/mL increment in blood lead (Mushak et al. 1989). Effects of lead on preterm labor and birthweight were not observed in several studies summarized in Table 3-7 (Ernhart et al. 1986, Angell and Lavery 1982, Gersanik et al. 1974, Clark, 1977). The possible contribution to lead effects on placental function, including placental blood flow, leading to preterm labor and decreased birthweight requires further investigation.

3.5.1.4 Mercury

Between 2,700 and 6,000 tons of mercury are released each year from the earth's crust. In addition, it is estimated that 10,000 tons are generated in the mining and manufacturing processes using mercury, e.g., pulp and paper manufacturing and caustic soda manufacturing (Schardein 1985). Additional sources are fossil fuels, combustion, production of cement, smelting of sulfur ores, and refuse incineration (WHO 1990). It is very important to distinguish the chemical form of mercury to which the individual or population has been exposed, whether inorganic (vapor and metallic) or organic. The global cycle for mercury includes emitted mercury vapor being converted to soluble forms (Hg^{++}) and deposited into soil and water via precipitation. Usually mercury vapor has an atmospheric residence time between 0.4 and 3 years, while the soluble mercury has a residence time of only a few weeks.

Methylmercury can be bioaccumulated many fold, and the major source of human exposure is through the food supply. Mercury exposures can also occur via gold mining/extraction and dental amalgams. Water and air can contribute significantly to the daily intake of total mercury depending upon the level of contamination. In most foodstuffs, mercury is in the inorganic form and below the level of detection (20 μg Hg/kg wet weight). Fish and fish products can have levels greater than 1,200 $\mu\text{g}/\text{kg}$, e.g., shark, swordfish, and Mediterranean tuna (WHO 1990). Similar levels have been noted in fresh water fish (bass, pike, and walleyes) in polluted lakes and streams. The consumption of 200 g of fish containing 500 μg Hg/Kg may represent an intake of 100 μg Hg, principally as methylmercury. This amount of methylmercury is one-half of the WHO-recommended tolerable weekly intake (WHO 1989).

3.5.1.4.1 Human investigations. Following dietary methylmercury (MeHg) exposures, practically all of the MeHg is absorbed and distributed to all tissues within 4 days. The blood-to-hair ratio in man is approximately 1:250. Further, cord blood levels are generally greater than maternal blood levels of MeHg. For MeHg the red blood cell to plasma distribution ratios are about 20:1 in humans, monkeys, and guinea pigs, while 7:1 for mice and >100:1 for rats.

Methylmercury is converted to inorganic mercury in humans. The rate of mercury excretion is proportional to the body burden and fits a single-compartment model with a biological half-life of 50

(39-70) days in fish eaters. Interestingly, the biological half-life is significantly shorter in lactating females.

Mean tissue values for total mercury are whole blood – 8 µg/L; hair – 2 µg/g; urine – 4 µg/l; and placenta – 10 µg/kg. In fish eaters, where consumption of mercury is 200 µg/day, the mercury blood levels can be approximately 200 µg/L, with hair levels being about 50 µg/g (WHO 1990).

When reproductive and developmental toxicity are of concern, the organic mercurials are of most concern, especially methylmercury, which may be found in fungicides or environmental contaminants. In industry, a wide array of mercurial exposures may occur from gold mining (now in South America); from manufacture of electrical products, lights, switches, connectors; and in the pulp industry. The inappropriate disposal of industrially produced or waste mercury can lead to substantial environmental exposure not only to inorganic mercury but especially to methylmercury.

The two largest study populations for the toxicity of methylmercury were in Minimata Bay, Japan, and in Iraq. The Japanese exposure was due to the consumption of contaminated fish from Minimata Bay, while the Iraqi exposure was due to the consumption of contaminated grain. It was especially apparent that the newborns and children were more affected by the exposures even though the adults were also affected. Toxic symptoms were observed in the blood of patients exposed to methylmercury. Of even greater significance has been the ability to use hair specimens to identify the exposure spectrum. Therefore, analysis of a single hair specimen allows determination of when during a pregnancy the exposure occurred. Because of mercury's long biological half-life, even if ingestion stops, evidence of exposure to mercury is persistent.

In human adults, no adverse effects have been detected with long-term daily mercury intake (3 to 7 µg/kg body weight). The hair levels of mercury would be 50 to 125 µg/g. It should be noted that pregnant women may suffer effects at lower methylmercury exposure levels than nonpregnant adults, suggesting a greater risk for the pregnant women (Marsh et al. 1987, WHO 1990). Of particular concern is the fact that, based upon the dose-response curves, the conceptus is much more sensitive to the neurotoxic actions of methylmercury than is the mother (Clarkson 1987).

Methylmercury is fetotoxic in mice (single exposure 2.5 to 7.5 mg/kg) and teratogenic in rats and produces behavioral alterations in monkey offspring (50 to 70 µg/kg per day before and during pregnancy). Spermatogenesis in mice is affected at 1 mg/kg methylmercury. Recent quantitative and qualitative assessments in nonhuman primates have been compared with humans who had all been exposed to different concentrations of methylmercury (Burbacher et al. 1990). It is remarkable how well the behavioral and neuropathological effects agree across species at the higher concentrations of methylmercury. Neurobehavioral functioning was similar across species at lower exposure levels for methylmercury; however, because of a lack of information in the human at lower exposure levels for the pathology, no neuropathological correlation can be established at this time (Burbacher et al. 1990).

Severe damage to the developing central nervous system can be caused by prenatal exposure to methylmercury. For severe neurologic effects, the lowest level in maternal hair during pregnancy was 404 $\mu\text{g/g}$ in the Iraqi outbreak, while the highest no-observed-effect level for severe effects was 399 $\mu\text{g/g}$ (WHO 1990). Fish-eating populations currently studied have not demonstrated such severe effects.

Psychomotor retardation in the offspring (history of seizures, abnormal reflexes, delayed achievement of developmental milestones) was noted below maternal hair levels associated with severe effects (WHO 1990). When the data are extrapolated, motor retardation was greater than background frequency at maternal hair levels of 10-20 $\mu\text{g/g}$ (WHO 1990). Abnormal muscle tone or reflexes was reported in boys (but not in girls) of mothers with hair levels during pregnancy of 23.9 $\mu\text{g/g}$ (Canadian). Developmental retardation was found (according to the Denver Test) in 4-year-old children whose mothers had maternal hair levels from 6 to 86 $\mu\text{g/g}$ (the second highest measured was 19.6 $\mu\text{g/g}$).

According to the World Health Organization:

The general population does not face a significant health risk from methylmercury. Certain groups with a high fish consumption may attain a blood methylmercury level (about 20 $\mu\text{g/litre}$, corresponding to 50 $\mu\text{g/g}$ of hair) associated with a low (5 percent) risk of neurological damage to adults. The fetus is at particular risk. Recent evidence shows that at peak maternal hair mercury levels above 70 $\mu\text{g/g}$ there is a high risk (more than 30 percent) of neurological disorder in the offspring. A prudent interpretation of the Iraqi data implies that a 5 percent risk may be associated with a peak mercury level of 10-20 $\mu\text{g/g}$ in maternal hair (WHO 1990).

Of particular concern is the change in dietary habits to reduce the daily intake of cholesterol-containing foods, e.g., meats and dairy products. Fish has been recommended as an alternative. Pregnant women are being exposed to increasing levels of methylmercury through consumption of swordfish, tuna, shark, and the above-named fishes to the exclusion of other protein sources. A case report demonstrates that even today, families can continue to be exposed. A professional family principally eating fish as the dietary source of protein ate swordfish and tuna many times each week. The mercury levels in the blood and hair of both the father and mother exceeded the WHO levels. The mother was 35 weeks pregnant. Upon notification of her mercury levels, the mother immediately discontinued the ingestion of those types of fish. Over the next few weeks, her blood levels did fall; however, the baby's blood and hair levels were 21 $\mu\text{g/L}$ and 11 ppm, while the levels in the mother were 28 $\mu\text{g/L}$ and 18 ppm.

As noted in Table 3-8, methylmercury has been detected in the human placenta. The mechanism of transport of methylmercury into the brain has been associated with amino acid carriers (Clarkson 1993). L-cysteine accelerates methylmercury uptake into brain. The L-cysteine-methylmercury complex is structurally similar to L-methionine, a substrate for the L-neutral amino acid transport system. Preliminary studies in the perfused human placenta have not identified a similar transport mechanism for methylmercury (Czekeridowski et al. 1993).

3.5.1.4.2 Mercury as vapor/amalgams/inorganic. The principal source of exposure to mercury vapor received by the general population is via dental amalgams. Dental amalgams release mercury vapor into the mouth. When fillings are removed, an acute increase in mercury release is noted. The rate of mercury release is increased by stressing the surfaces by chewing and brushing. The released mercury from the dental amalgams is deposited in body tissues and is excreted via the kidney. Increased urinary mercury levels are noted. Estimated release rates from amalgams are consistent with mercury content in autopsy tissue in the general population (Clarkson et al. 1988b).

Occupational exposure to mercury vapor can result in renal, pulmonary and psychomotor toxicity (cf. Clarkson 1988). Current studies of female dentists/dental workers have not demonstrated a mercury-associated increase in birth defects or pregnancy losses (Heidam 1984, Ericson and Kallen 1989, Rowland et al. 1994). Unfortunately, there is limited information available concerning occupational exposures to mercury (vapor/inorganic) and effects on reproduction. Menstrual disorders (hypermenorrhea/dysmenorrhea) and decreased fertility have been associated with women working in mercury plants, especially for women working longer than three years (Goncharuk 1977, Rowland et al. 1994). The mercury levels in the factory fluctuated between trace and 0.08 mg/cubic meters.

Hypermenorrhea/dysmenorrhea were reported in dental workers and women working in mercury rectifier stations. These exposures appear to be substantial since it was reported that mercury was on the patients' hands, on the desks, tables, and floors in the work areas (Marinova et al. 1973, Mikhailova et al. (1971), as reported by Barlow and Sullivan (1982). It is apparent from the descriptions of the working conditions in these occupational settings that substantial mercury exposure was occurring.

It has been well-established that even though organic mercurials rapidly transit the placenta, inorganic mercury does not easily transit and is concentrated by the placenta itself (Table 3-8; cf. Miller et al. 1988). Even with such placental concentration, a recent study in sheep (Vimy et al. 1990) demonstrated the release of mercury from dental fillings with the appearance of mercury in the fetus. Further evidence was presented for the transfer to the newborn via breast milk as well. Thus, issues of the kinetics of mercury transfer in the human require further investigation to establish the method of transfer and specific protein interactions within the placental cells. Still, the fact that one can accurately measure mercury (and its chemical state) in the human placenta can be a useful marker of exposure for the conceptus (especially for inorganic mercury when hair analysis is not appropriate).

3.5.1.5 Selenium

Selenium is an essential element that is found in specific selenoproteins that contain selenocysteine. Important mammalian selenoproteins so far identified include the antioxidant glutathione peroxidase enzymes, selenoprotein P, and type I iodothyronine deiodinase (Burk et al. 1991, Stadtman, 1990). An additional class of selenoproteins (not well defined) binds selenium tightly enough so that the selenium remains attached during protein purification procedures (Sunde 1990). Selenium associated with

proteins is in the form of selenide (-2). Selenide can be formed by the reduction of selenite (-SeO₃, +4) and selenate (-SeO₄, +6), two forms of selenium frequently used in experimental exposure studies. Selenite reacts with glutathione and is reduced to selenide. In this process, reactive oxygen species are produced (Imura et al. 1994, Yan and Spallholz 1993). The pathway of selenate reduction has not been well defined, but reactive oxygen species are not produced in the presence of selenate and glutathione (Yan and Spallholz 1993).

Selenium status in animals and humans has been determined by measuring selenium concentrations and glutathione peroxidase activity in blood or plasma. During pregnancy, both plasma selenium and glutathione peroxidase activity decrease or remain unchanged (Behne and Wolters 1979, Swanson et al. 1983, Zachara et al. 1993).

In humans, selenium concentrations in cord blood are similar to levels in maternal blood, with higher values found in the placenta (Table 3-9). The actual form of selenium that crosses the placenta *in vivo* is not known. Treatment of pregnant mice with selenite or selenate results in selenium transfer to fetal tissues (Danielsson et al. 1990). Selenium from selenate and selenomethionine can also cross the hamster placenta (Willhite et al. 1990). An *in vitro* study using dual perfusion of the human term placenta, in which selenite was added to the maternal circulation, identified selenite in the fetal perfusate, indicating that selenite can cross the human term placenta (Eisenmann and Miller 1994).

Although selenium is an essential nutrient, it is also quite toxic, with adverse effects (including developmental effects) reported in animals following selenium intake of about 100 times larger than levels considered essential (WHO 1987). There is little information about the effects of selenium on placental function. One study showing that an acute dose of selenite can cause abortions in mice suggests that selenite could be a reproductive toxicant possibly acting through effects on the placenta. Yonemoto et al. (1983) studied the effect of a single subcutaneous dose of selenite given to mice on gestation day 12 or 16. Treatment on day 12 with a dose of 58.8 fmol/kg resulted in abortion and maternal deaths within 48 hours. On gestation day 16, abortions were observed at 27 fmol/kg, and abortions and maternal deaths occurred at 40 fmol/kg. Pretreatment of gestation day 12 mice with glutathione (2 or 5 mmol/kg) 20 minutes before selenite treatment increased the toxicity of selenite. No treatment-related malformations were observed in offspring from mice treated with selenite. Histopathological examinations of organs, including the placenta, were not completed. The observed increase of selenite toxicity after glutathione pretreatment is consistent with a free radical mechanism for selenite toxicity.

It is not known how a free radical mechanism of selenite toxicity might lead to abortions and the increased toxicity that was observed later in gestation in mice. One hypothesis is that oxidative stress during late gestation pregnancy may disrupt the balance between the arachidonic acid metabolites, prostacyclin, and thromboxane A₂. Prostacyclin is a vasodilator that also inhibits the aggregation of platelets, while thromboxane A₂ is a vasoconstrictor that stimulates platelet aggregation. Both substances are produced by the placenta, and an increase in the production of thromboxane A₂ and a decrease in the

production of prostacyclin have been observed in placentae from women with preeclampsia (Walsh et al. 1985).

Prostaglandin H synthase enzymes, required for the production of thromboxane A2 and prostacyclin, require small amounts of peroxides for activity, while high concentrations inhibit activity (Reddy et al. 1988). Because of the importance of peroxides to prostaglandin H synthase activity, it has been proposed that selenium in the form of the glutathione peroxidase enzymes may be important in modulating prostaglandin H synthase enzyme activity and in determining the products of the arachidonic acid cascade (Reddy et al. 1988). In addition to affecting prostaglandin H synthase, oxidizing agents can affect other enzymes of the arachidonic acid cascade. For example, prostacyclin synthase activity is also inhibited by oxidizing agents (Ham et al. 1979).

To investigate whether selenium compounds can affect the placental production of thromboxane A2 and prostacyclin, an *in vitro* study was completed in which human term placental explants were exposed to selenium compounds for up to 24 hours, and the production of the inactive hydrolysis products of thromboxane A2 and prostacyclin, thromboxane B2, and 6-keto-PGF1 were monitored (Eisenmann and Miller 1996). The selenium compounds used were (1) *selenite*, which is known to produce free radicals; (2) *selenate*, which does not produce free radicals, and (3) *ebesen*, an organic selenium compound with glutathione peroxidase activity (Morgenstern et al. 1992). Concentrations of selenium used in these investigations did not exceed 40 fM, which is the reported blood concentration associated with selenium toxicity in humans (Yang et al. 1983).

Two 12-hour exposures of human term placental explants to selenite at 20 or 40 fM significantly increased the placental production of thromboxane B2 and decreased the placental production of 6-keto-PGF1, both changes that contributed to a significant increase in the thromboxane B2/6-keto-PGF1 ratio (Eisenmann and Miller, 1996). An increase in the thromboxane B2/6-keto-PGF1 ratio would be conducive to vasoconstriction and blood coagulation. In contrast to selenite, two 12-hour exposures to selenate at 40 fM significantly increased thromboxane B2 production with no significant effects on 6-keto-PGF1 production or the ratio. Ebselen exposure of placental explants tended to decrease both thromboxane B2 and 6-keto-PGF1 production with no significant changes in the thromboxane B2/6-keto-PGF1 ratio.

Based on the results of this study (Eisenmann and Miller 1996), it has been proposed that selenite, which can produce oxidative stress, could lead to an imbalance between thromboxane A2 and prostacyclin. The direction of the imbalance observed following selenite exposure was the same as observed in cases of preeclampsia. How effects of selenite on thromboxane A2 and prostacyclin production contribute to toxicity of selenite during pregnancy still needs to be elucidated.

3.5.2 Environmental Agents

Placental transport of three agents (e.g., diethylstilbestrol, pesticides, and viruses) is discussed in this section. Specific data sets will be reviewed for each compound.

3.5.2.1 *Diethylstilbestrol (DES)*

Diethylstilbestrol (DES) was prescribed beginning in the 1940s-1950s to prevent pregnancy loss (Smith et al. 1946) and has also been used in agricultural settings to promote growth in cattle and poultry (McLachlan 1982). DES was found to be a transplacental carcinogen and teratogen in humans (Herbst et al. 1971, 1981; Kaufmann et al. 1980; cf. Goldberg and Falcone 1999) approximately 25 years after its introduction. Even more time passed before it was demonstrated to be a transplacental carcinogen in three animal species: (1) the mouse (McLachlan et al. 1980, Miller et al. 1998, Walker and Haven 1997); (2) the rat (Baggs et al. 1992, Henry and Miller 1986a, b); and (3) the hamster (Khan et al. 1998). Mechanistically, the study of DES has produced a rich field for investigating mechanisms of teratogenic/carcinogenic action. Such animal and human observations place DES among the agents that, through signal transduction mechanisms (hormones), can modify not only the receptor (estrogen) but also its expression, uterine lactoferrin (Newbold et al. 1997). More recent evidence has implicated chromosomes 3 and 6 as sites for gene control, resulting not only in carcinogenesis but also teratogenesis (cf. Hanselaar et al. 1997). It is especially noteworthy that investigative teams working with animal models have discovered that exposure to DES in one generation can lead to development of clear cell vaginal adenocarcinoma in the next generation. (Walker 1989, et al. 1995, 1997; Newbold et al. 1998).

Recent investigations have found that the effects of DES in the developing mouse female reproductive tract are linked with down-regulation of *Wnt7a*, resulting in abnormal smooth muscle proliferation (Miller et al. 1998). *Wnt7a* is normally expressed in the luminal epithelium of the uterus. Following DES exposure *in utero*, low levels of *Wnt7a* transcripts were detected at birth. Such alterations in the reproductive tract following DES exposure are consistent with knockout mice lacking *Wnt7a* having malformed female reproductive tracts (Miller and Sassoon 1998).

All of these investigations implicate the role of gene control and modification by estrogenic agents, which may be more effective not only because of their estrogenic properties, but due to their toxicokinetics and metabolism (Metzler and McLachlan 1978, Miller et al. 1982, McLachlan et al. 1984, Henry and Miller 1984, 1986). DES is a trans-stilbene molecule that is eventually conjugated; however, the oxidative metabolites formed can be reactive epoxides that may bind to cellular constituents (DNA, proteins). As noted earlier, the principal difference between DES and estradiol is the lack of affinity for DES to bind to plasma proteins. Thus, it appears more rapidly and attains a higher level in the female reproductive tract (Henry and Miller 1984) following direct injections into rat fetuses. The toxicokinetic parameters related to this first synthetic hormone compared to the endogenous estrogen, estradiol, may be principally related to the fact that plasma binding, distribution, and metabolism are different from the endogenous estrogen, while the ability to bind to the estrogen receptor is similar.

In the human, further questions continue to be raised concerning the gene/environmental interactions based upon the collective experience with diethylstilbestrol during pregnancy (Hanselaar et al. 1997).

3.5.2.2 *Organochlorine Pesticides*

Organochlorine pesticide residues, especially DDT, are still ubiquitous in today's environment (Gladen et al. 1999). These compounds cross the human placenta and accumulate in the conceptus, and elevated levels have been associated with perinatal morbidity and mortality (Saxena et al. 1981, Saxena et al. 1983). It is interesting to note that this class of agents inhibits Ca^{++} ATPase in the human placenta at micromolar concentrations for p,p-DDT, p,p-DDD, p,p-DDE, methoxychlor, aldrin, dieldrin, mirex, chlordane, heptachlor, endrin, kepone, and lindane but not for p,p-DDA or p,p-DDOH (Kulkarni et al. 1987). Such inhibition may be related to alterations in calcium transport and is associated with reported increases in the incidence of spontaneous abortions (O'Leary et al. 1970, Saxena et al. 1980), preterm births and stillbirths (Saxena et al. 1983; Siddiqui and Saxena 1985, Wassermann et al. 1982). Reichrtova et al. (1999) reported that placental levels of organochlorinated compounds were elevated in an industrial city compared to a rural population in Slovenia. Such increased levels of organochlorines were also associated with higher levels of total IgE in newborns.

3.5.2.3 *Organophosphorous Insecticides*

Methylparathion and parathion, organophosphorus insecticides, have been widely used in agriculture. Both insecticides have been found to cross the placenta (parathion – Benjaminov et al. 1992) and methylparathion – Abu-Qare et al., 2000). Furthermore, under *in vitro* perfusion conditions, acetylcholinesterase levels in the human placenta were reduced by 50 percent following perfusion with parathion (Benjaminov et al. 1992). In both rats and humans, the metabolism of methylparathion has been demonstrated (Abu-Qare et al. 2000, Radulovic et al. 1986). Glutathione S-Transferase mediates the metabolism of methylparathion in the human preterm or at-term placenta (Radulovic et al. 1986). Desmethylparathion was the only metabolite produced. There was no apparent O-dearylation in these human placental GSH transferases. Of special interest is the fact that this absence of O-dearylation represents both a major species- and tissue-specific difference as reported by Radulovic et al. (1986) and noted in the following study. Abu-Qare et al. (2000) examined the dermal absorption of ^{14}C methyl parathion in pregnant Sprague-Dawley rats at between 14 and 18 days of gestation. This study is particularly important because of the route of exposure and the evaluation of the conceptus. Both the parent compound and its metabolites, i.e., methyl paraoxon (toxic) and p-nitrophenol, were measured by HPLC. Methylparathion was rapidly absorbed and crossed into the conceptus. Interestingly, only the parent compound was detected in both placenta and fetal homogenate. Because of the high levels of methylparathion in the placenta and fetus, the potential for toxicity to the conceptus has been of concern. Unfortunately, in this study it was not possible to monitor the fetal brain levels.

Interestingly, another organophosphate insecticide, chlorpyrifos, has been shown to dramatically inhibit carboxylesterase and cholinesterase in maternal and fetal livers without affecting either enzyme in the rat placenta throughout gestation (Lassiter et al. 1999). This demonstrates that the insecticide does transit the placenta without inhibiting the placental enzymes. The oxon metabolite of chlorpyrifos irreversibly inhibits the serine esterases. The results of this study are an excellent example of the need for toxicokinetic analyses. Is the metabolite present in the fetal liver and in the placenta? Does the placenta produce the metabolite? Are the placental enzymes spared because of the low levels of the metabolites or differences in the enzyme affinities for the metabolite? However, these questions do not change the important observation that the fetal liver is a sensitive biomarker of exposure and effect, while the placental enzymes are not.

3.5.2.4 Viruses, HIV, and CMV Infection

Viruses are discussed here because they appear to have unusual kinetics in the human placenta and are certainly an environmental confounder. Of special significance have been HIV and cytomegalovirus. In this section, discussion of this issue will be limited to consideration of these two viruses because of their clinical significance and effects on the offspring, but brief reference will be made to the coxsackie B and echo 11 viruses.

The great majority of children with AIDS acquire the disease from their mothers during the perinatal period (Minkoff et al. 1987, Curran et al. 1988, Naz and Ellaurie 1990, Lew and Fowler 1998, Kostrikis 2000). The risk for vertical transmission continues to be high because approximately 50 percent of all pregnancies are unplanned, and of the 800,000 to 900,000 U.S. residents who are living with HIV infection, approximately one-third are unaware of their infection (CDC 1999). There is evidence for early and late transmission (Maury et al. 1989, Ehrnst et al. 1991) and for multiple routes and cellular mechanisms for infection (Douglas and King 1992, Miller and Thiede 1994).

Transplacental infection might occur by several routes (Bernirschke and Kaufmann 1990, Valente and Main 1990). For a simple but unlikely possibility, direct cross-placental traffic of free virus or virally infected cells has been proposed. More probable is infection of one or more cell types in the placenta, with subsequent infection of fetal lymphocytes in the capillary network (Miller et al. 1998). The two placental cell types that are most likely to be infected are the placental macrophages and the trophoblast cells themselves. *In vitro* human placental macrophages (Hofbauer cells) can be infected with HIV-1 (Lewis et al. 1990, Kesson et al. 1993, McGann et al. 1994, Melendez-Guerrero et al. 1994, Torres et al. 2000) as well as trophoblast cell line or choriocarcinoma-derived trophoblast (Phillips and Ta 1992, Bourinbaiar and Nagorny 1993). Immunohistochemical localization of p24 antigen and CD4 are supported by several studies (Martin et al. 1992, Mattern et al. 1992, Laimore et al. 1993) with a specificity not always evident (Faulk and Labarrere 1991). Chemokine receptors (CCR5 and CXCR4) (Figure 3-12) are now being associated with infection. *In situ* PCR (Bagasra et al. 1992; Pantaleo et al. 1993; Nuovo et al. 1994a, b, c; Seidman et al. 1994; Sharer et al. 1994; Patterson et al. 1995, Sheikh et al.

1998, 2000) identified infected cells of the placenta as syncytiotrophoblast, cytotrophoblast, and Hofbauer cells.

If the placental role in maternal-fetal transmission of HIV infection seems incontestable, the understanding of this role and of its mechanisms is far from being known. For example, the placental hormones, human chorionic gonadotropin and placental lactogen, seem to have an inhibitory effect on HIV-1 transmission from lymphocytes to trophoblast cells (Bourinbaïar and Nagorny 1992; Polliotti et al. 1999, 2000; Rao 2000). Human chorionic gonadotropin and progesterone production by placental cultures also appears to have decreased when cultures were infected by HIV-1 (Amirhessami and Spector 1991). Can we suspect a feedback mechanism between the production of these placental proteins and the HIV-1 replication (Polliotti et al. 1999)? The placenta may serve as a reservoir for HIV virus during pregnancy, and thus contribute to infection of the fetus, but what happens in the placenta to explain the finding that so few fetuses are infected? Is the placenta more a transfer site or a reservoir of latent virus? Is there a specific cofactor able to awaken the virus from its latent state and activate its replication? It is fascinating to note: in a study by Zevallos (1994), only half of the placentae from HIV-positive mothers were found infected using IS-PCR; in those placentae, trophoblast cells, Hofbauer cells, and stromal cells were all apparently infected. Polliotti et al. (2000) confirm the same finding. Furthermore, Zachar et al. (1994) noted that it was not an insufficiency of basal or TAT-trans-activated LTR activity that accounts for the lower level of HIV-1 replication in the trophoblast.

Under *in vitro* incubation conditions, both term and early human placenta villus explants can be infected, depending upon the strain of HIV (Polliotti et al. 1998). The identical cell types infected under *in utero* conditions were noted in these *in vitro* infected placentae. Furthermore, the production of HIV in the human placenta can be increased by exposure to cytokines (tumor necrosis factor α or interleukin 6; see Ding et al. 2000). Thus, it is possible to study how the infectious process occurs in the placenta and how the placenta may regulate not only its infection but also the infection of the embryo/fetus.

Does the human placenta play a modulatory role in this infectious process? Previously, other viruses, e.g., echo 11, coxsackie B, and CMV, were noted not to directly penetrate through the human term placenta acutely under dual perfusion of the human placental lobule (Amstey et al. 1988; Muehlemann et al. 1995). Certainly, the human placenta can become infected; however, what is the process that leads to the infectivity of the embryo/fetus? Physical breaches of the placenta and extraembryonic membranes, as in premature rupture of membranes with or without bacterial chorioamnionitis, could be understood to be an entry point. Contamination during invasive procedures could be other routes of entry, e.g., amniocentesis. Yet, these breaches of the integrity of the placenta do not account for why only 25 to 40 percent of babies of mothers who are HIV-positive are themselves HIV positive. Numerous studies examining the morphology and pathology of the human placenta from mothers who were HIV positive have not demonstrated any specific pathological condition other than some villitis being associated with HIV infection (Anderson et al. 1994, Jauniaux et al. 1988, Chandwani et al. 1992, Nahmias et al. 1998, Panigel and Nahmias 1994, Popek 1998, Roberts 1998, Miller et al.

1998). Many have assumed that the human placenta of an HIV infected mother must be HIV positive. However, that certainly does not appear to be the case (Polliotti et al. 2000, Miller et al. 2000). Recent publications have raised further questions, Goldenberg et al. (1998), in a hypothesis paper in *Lancet*, raised the possibility that prolonged rupture of membranes is the principal route of HIV infection, with inflammation and bacterial chorioamnionitis being important contributing factors. These factors could be contributors; however, infection of the trophoblast and villus cells *in vitro* and *in utero* (De Andreis et al. 1996; Sheikh et al. 1998, 2000) indicates that direct infection of the placenta can be a major contributor. De Andreis et al. (1996) using variable tandem repeats analysis reported that 70 percent of placentae from all trimesters were infected.

As noted for HIV, CMV also can produce major sequelae in the newborn and increased pregnancy loss especially if it is a primary infection for the mother. In studies similar to the HIV studies *in vitro*, Fisher et al. (2000) beautifully demonstrated that human CMV can infect the human placental villus *in vitro*. Interestingly, they did not find the syncytiotrophoblast infected, but rather the cytotrophoblast cells as determined by viral protein expression. Halwachs-Bauman et al. (1998) noted that cytotrophoblast cells were delayed in their expression of viral proteins compared with fibroblasts, which, like HIV infection, may mean the placenta is attempting to regulate or suppress expression and production of virus. Jun et al. (2000) demonstrated a down-regulation of trophoblast class I MHC molecules by CMV gene products US3 and US6. These gene products inhibit cell surface expression of HLA-G and HLA-C, as well as decrease the intracellular movement of class I molecules. Such actions are certainly suggestive of an increased risk for pregnancy loss.

Therefore, these examples of viral infections demonstrate the important role the placenta may play, not only in infecting the placenta as well as the conceptus, but also in being directly affected. If one superimposes additional environmental or therapeutic burdens on the placenta, enhanced toxicity may be noted.

3.6 PLACENTAL MULTIDRUG TRANSPORTERS, DYSFUNCTION, AND EVALUATION

At issue in this section are the relationships between placental genetics and transport/toxicity. Not only may an agent be transferred, it may also be accumulated in the placenta and produce direct placental pathology and toxicity. Of particular concern in the more recent past have been the differences among species and the genetic issues related to differences in enzyme profiles for xenobiotic metabolism and induction of these enzymes (see Issue Area 1). However, with the recent identification of specific transporters (specific carrier proteins have also been identified), one can examine the genetic profile for many different organs, including the placenta. For an excellent review on multidrug transporters, the reader is referred to Ambudkar et al. (1999). This class of P-glycoproteins is associated with a variety of activities, including resistance to multiple cytotoxic drugs in cancer cells. Even though many cells have demonstrated multidrug resistance (MDR) in culture, clinical data proving that MDR affects cell cycle dynamics, cellular drug metabolism, intracellular compartmentalization or repair of drug-induced damage

(usually for DNA) remains elusive *in vivo* (Ambudkar et al. 1999). The overexpression of the P-glycoprotein (P-gp), known as the multidrug transporter, has been noted in many cell types. Only recently has the placenta been the focus of investigation. Overexpression of mouse *mdr1a* and *mdr1b* cDNAs and of human MDR1 cDNA have been associated with resistance to cytotoxic anticancer drugs as well as hydrophobic therapeutics (cf. Ambudkar et al. 1999). Most compounds known to be transported by P-gp stimulate ATPase activity. Thus, drug efflux pumps are the P-glycoproteins.

Knockout mice for either *mdr1a* or *mdr1b* are not affected for viability of the fetuses; however, *mdr1* knockout mice show a sensitivity for toxicity of drugs on the central nervous system, which may be related to the alteration of the blood-brain barrier (cf. Ambudkar et al. 1999). Smit et al. (1999) demonstrated that *mdr1a* mutant mouse fetuses (CF-1) do not have placental *mdr1a* P-gp. Interestingly, they associated this loss of P-glycoprotein with increased developmental toxicity to the pesticide, avermectin.

Of even greater significance to issues of toxicity is the apparent increase in appearance of selected molecules in the fetus, which is *mdr1a/1b* null compared with wild types or heterozygous mothers. The agents studied were digoxin, saquinavir, and paclitaxel. Of further significance was the observation that administration of PSC833, a known inhibitor of P-gp, to heterozygous mothers produced the more rapid appearance of these molecules in the fetus. An example of the saquinavir data set is presented in Table 3-10.

Biomarkers of exposure and effect present the opportunity to identify risk during pregnancy. The placenta has become a site from which one can evaluate such biomarkers. As noted above, the placental metal content has provided an exposure index during pregnancy for industrial and environmental exposure as well as for smoking (for cadmium). Additionally, DNA adducts in the human placenta have been associated with polycyclic aromatic hydrocarbon exposures (see Table 3-11). Alterations of enzyme response in the placenta may reflect not only exposure but also a compromising of normal function, leading to poor pregnancy outcome.

Evidence of such poor pregnancy outcomes and adverse effects on the placenta itself have been detailed above for cadmium, a placental toxicant in numerous species including the human (see cadmium section). However, many other agents, including antibodies and trypan blue, have been associated with alterations in normal catabolic functions in the yolk sac leading to embryonic death and birth defects (Table 3-12). Such direct actions demonstrate that the placenta is not only the conduit for toxicants (methylmercury) to enter the conceptus but at times the target for direct action due to unusual accumulations of the toxic molecules (cadmium), alteration of enzyme function (benzo(α)pyrene), or modification of nutrient transfer (cadmium, trypan blue, and antisera). The specifics of individual agent responses are summarized in Table 3-12.

3.7 CONCLUSIONS

The placenta performs a critical role in the development of the conceptus not only as conduit, depot, and barrier, but also as anchor and controller. Within this range of activities, the obstetrician, toxicologist, and regulator must appreciate that understanding of the multiple roles played by the human placenta is undergoing a dramatic expansion, not only with regard to toxicokinetics, but to all functions, depending on the stage of gestation. One example is the realization that the unique placental transporters (p-glycoproteins) are often operative, which may alter placental responses with resultant increased transfer of xenobiotics to the conceptus. Such transporters have identified an increased understanding of genetic variability in placental function especially in the placenta's role as a conduit.

As noted above, the placenta at less than 10 weeks of gestation is developing in an entirely different milieu than the near-term or at-term placenta. Such profound observations cause the scientific community to explore in greater detail the similarities between early human and early rodent functions. The similarities appear to be even greater in terms of oxygen environment, the role of the yolk sac, and the nature of the cellular layers separating the maternal environment from the embryo proper. Jauniaux and colleagues have provided a glimpse into the early human embryonic compartment. Obviously, for the human, such studies are far from routine, even for research evaluations. However, the ability to monitor the coelomic cavity directly does identify the ability of molecules to enter and redistribute. Using nonhuman primates for toxicokinetics during these early stages of gestation will also provide for modeling and assessing physiological *in utero* function. These studies would then, in combination with a wide range of *in vitro* explant/slice studies (using early and term human placentae as well as other animal species), provide for detailed characterizations of these transfer processes for specific molecules across species. Just as we believe we have a good understanding of toxicokinetics during pregnancy, study of the early human pregnancy may elucidate a different adaptation compared with the near-term human placenta.

As has been discussed in this section, the transfer of molecules across the placenta in either direction is dependent upon the chemical's characteristics and the ability of the placenta to selectively bind to proteins and transporters and/or metabolize the molecule into a molecule that may or may not have adverse consequences for the embryo/fetus or the placenta itself. Examples have been provided that detail how some molecules may not be easily transferred in either direction across the placenta; however, the fact that the placenta bioaccumulates the molecule may alter the transfer of other nutrients as well as intoxicate the placenta itself. Cadmium is one such example in both animal and human models. Many other molecules may depend on the nature of the serum proteins and binding sites or the genetics of the transporters in the placenta, and of which may influence how rapidly the compound can be transferred. This has been noted for dioxin binding to low-density lipoproteins, vitamin B₁₂ binding to transcobalamin II, immunoglobulin G binding to Fc receptors, and transfer via receptor-mediated endocytosis. Of special note in this capacity has been the estrogen, diethylstilbestrol, which can be metabolized to epoxides and bind differentially (less) to plasma proteins when compared with the endogenous estrogen, estradiol. The

toxicokinetic characteristics of DES cause it to pose the greater risk for adverse events when compared with estradiol. Interestingly, viruses do not easily passage in either direction and appear to cross the placenta only by infecting the placenta first. Of major interest is whether agents can be like amino acids, where the molecule is concentrated in the fetal circulation because of an active transport process for the molecule. Such an example appears to be the molecular conjugate, methylmercury-cysteine, which rides amino acid transporters. Thus, environmental agents in most instances will eventually enter into the conceptus either by diffusion, carrier-mediated processes, or modification of the placental functions, e.g., infection.

Not only can metabolites that are just as or more toxic than the parent compound be presented to the placenta, but they also may be formed by the placenta. Considering the retinoids, for example, the human placenta can form not only all trans-retinoic acid but also the 4-oxo metabolites, which are thought to be teratogenic. The importance of not only inducing monooxygenases with polycyclic aromatic hydrocarbons, but also modifying the conjugation and protein-binding milieu for metallothionein and metals can be influential in the transfer of many different molecules, from amino acids to zinc. This was noted previously for cadmium.

For the development of future test guidelines and guidance documents, it is becoming important to know not only what is happening relative to toxicokinetics in animal models but also what may be occurring in humans. For many environmental agents, there are insufficient clusters of human exposures to determine the placental toxicokinetics. Thus, test guidelines will need to incorporate human model systems, e.g., *in vitro* human placental perfusions, in order to begin to understand not only the transfer of agents but also metabolism, as has been useful for new therapies, eg., Rheopro.

Specifics would include the opportunity to understand how the agents may interact with known nutrients or other combinations of environmental agents, whether the agent will induce xenobiotic metabolism in the placenta or whether there is significant metabolism of the agent based upon known enzyme profiles and testing within a diverse human population.

Such characterization of molecules in both animal and human placental studies (*in utero* and *in vitro*) can provide toxicokinetic as well as toxicity data not only for animals but also for the human providing for improved noncancer risk assessment.

3.8 BIBLIOGRAPHY

- Abu-Qare AW, Abdel-Rahman AA, Kishk AM, Abou-Donia MB. (2000). Placental transfer and pharmacokinetics of a single dermal dose of [¹⁴C]methyl parathion in rats. *Toxicol. Sci.* 53(1): 5-12.
- Ahmed MS, Zhou D, Schoof T, Spong C, Sagduyu K, Agbas A, Maulik D. (1991). Illicit drug use during pregnancy. Effects of opiates and cocaine on human placenta. *NIDA Research Monographs* 119:278-279.
- Ahokas R, Dilts P, Lahaye, E. (1981). Cadmium-induced fetal growth retardation: Protection by excess dietary zinc. *Amer. J. Obstet. Gynecol.* 1981;136:216-221.
- Alexander DP, Andrews RD, Huggett A St. G, Nixon DA, Widdas WF. (1955). The placental transfer of sugars in the sheep: The influence of concentration gradient upon the rates of hexose formation as shown in umbilical perfusion of the placenta. *J. Physiol.* 129:367-383.
- Ambudkar SV, Dey S, Hrycyna CA, Ramachandra M, Pastan I, Gottesman MM. (1999). Biochemical, cellular, and pharmacological aspects of the multidrug transporter. *Annu. Rev. Pharmacol. Toxicol.* 39:361-398.
- Amirhessami-Aghili N, Spector SA. (1991). Human immunodeficiency virus type 1 infection of human placenta: potential route for fetal infection. *J. Virol.* May;65(5):2231-2236.
- Amstey MS, Miller RK, Menegus MA, di Sant'Agnes PA. (1988). Enterovirus in pregnant women and the perfused placenta. *Amer. J. Obstet. Gynecol.* 158:775-780.
- Anderson VM, Zevallos E, Gu J (1994). The HIV-exposed placenta morphologic observations and interpretation - a review -. *Trophoblast Res.* 8:47-65.
- Andjelkovic J, Zhang L, Shiverick KT, Miller RK. (1995). Benzo[α]pyrene reduces epidermal growth factor (EGF) receptor and secretion of human chorionic gonadotropin (hCG) in first trimester human placental explants. *Teratology* 51:160.
- Angell NF, Lavery JP. (1982). The relationship of blood lead levels to obstetric outcome. *Am. J. Obstet. Gynecol.* 142:40.
- Arafa HM, Elmazar MM, Hamada FM, Reichert U, Shroot B, Nau H. (2000). Selective agonists of retinoic acid receptors: comparative toxicokinetics and embryonic exposure. *Arch. Toxicol.* Jan;73(10-11):547-556.
- Asai M, Faber W, Neth L, di Sant'Agnes PA, Nakanishi M, Miller RK. (1993). Human placental transport and metabolism of all-trans retinoic acid in vitro. *Trophoblast Research* 7:25-33.
- Assali NS, Brinkman CR. (1972). Control of systemic and pulmonary vasomotor tone before and after birth. *Adv. Exp. Med. Biol.* 22:13-37.
- Astroff AB, Young AD. (1998). The relationship between maternal and fetal effects following maternal organophosphate exposure during gestation in the rat. *Toxicol. Ind. Hlth.* 1Nov-Dec;14(6):869-889.
- Athanassakis I, Aifantis I, Ranella A, Giouremou K, Vassiliadis S. (1999). Inhibition of nitric oxide production rescues LPS-induced fetal abortion in mice. *Nitric Oxide* Jun;3(3):216-224.
- Avissar N, Eisenmann C, Breen JG, Horowitz S, Miller RK, Cohen H.J. (1994). Human placenta produces and secretes extracellular glutathione peroxidase into the maternal circulation. *Amer. J. Physiol.* 267:E68-E76.
- Bagasra O, Hauptman SP, Lischner HW, Sachs M, Pomerantz RJ. (1992). Detection of human immunodeficiency virus type 1 provirus in mononuclear cells by in situ polymerase chain reaction. *N. Engl. J. Med.* 326(21):1385-1391.

- Baggs RB, Harnish PP, Miller RK. (1983). Radiologic diagnosis of diethylstilbestrol induced teratogenesis in rats. *Lab. Animal Sci.* 33:451-453.
- Baggs RB, Miller RK, Odoroff C. (1991). Carcinogenicity of diethylstilbestrol in the Wistar rat: Effect of postnatal oral contraceptive steroids. *Canc. Res.* 51:3311-3315.
- Baglan RJ, Brill AB, Schulert A, Wilson D, Larsen K, Dyer N, Mansour M, Schaffner W, Hoffman L, Davies J. (1974). Utility of placental tissue as an indicator of trace element exposure to adult and fetus. *Environ. Res.* Aug;8(1):64-70.
- Bajoria R, Contractor SF. (1997). Effect of the size of liposomes on the transfer and uptake of carboxyfluorescein by the perfused human term placenta. *J. Pharm. Pharmacol.* Jul;49(7):675-681.
- Bajoria R, Fisk NM, Contractor SF. (1997). Liposomal thyroxine: A noninvasive model for transplacental fetal therapy. *J. Clin. Endocrinol. Metab.* Oct; 82(10):3271-3277.
- Baranowska I. (1995). Lead and cadmium in human placentas and maternal and neonatal blood (in heavily polluted area). measured by graphite furnace atomic absorption spectroscopy. *Occupational Environ. Med.* 52:229-232.
- Barlow S, Sullivan F. (1982). *Reproductive Hazards of Industrial Chemicals*, New York: Academic Press.
- Barnea E, DeCherney A, Naftolin F. (1987). Placental distribution and the effect of antihypertensive drugs on monoamine oxidase and catechol-O-methyl transferase activity at term. *Trophoblast Res.* 2:305-314.
- Barnea ER, Shurtz-Swirski R. (1991). Carcinogen-induced changes in the secretion of hCG in early placental explants. *Placenta* 12:370.
- Barnwell SL, Sastry BVR. (1983). Depression of amino acid uptake in human placental villus by cocaine, morphine and nicotine. *Trophoblast Res.* 1:101-120.
- Barone A, Ebesh O, Harper RG, Wapnir RA. (1998). Placental copper transport in rats: effects of elevated dietary zinc on fetal copper, iron and metallothionein. *J. Nutr.* Jun;128(6):1037-1041.
- Barron, D.H.Alexander, G.(1952). Supplementary observations on the oxygen pressure gradient between the maternal and fetal bloods of sheep. *Yale J. Biol. Med.* 25:61-66.
- Bawdon RE. (1998). The ex vivo human placental transfer of the anti-HIV nucleoside inhibitor abacavir and the protease inhibitor amprenavir. *Infect. Dis. Obstet. Gynecol.* 6(6):244-246.
- Beaconsfield R, Cemerikic B, Genbacev O, Sulovic V. (1987). The placenta as a model for toxicity screening of new molecules. *Trophoblast Res* 2:343-356.
- Beck F. (1981). Comparative placental morphology and function. In: *Developmental Toxicity*, eds. Kimmel CA, Buelke-Sam J. New York: Raven Press, pp. 35-54.
- Beck F, Lloyd JB. (1967). Griffiths A. Lysosomal enzyme inhibition by trypan blue: A theory of teratogenesis. *Science* 157:1180-1182.
- Beckman DA, Pugarelli J, Koszalka T, Brent R, Lloyd J. (1991a). Sources of Amino Acids for protein synthesis during early organogenesis in the rat. *Placenta* 12:37-46.
- Beckman DA, Ornoy A, Jensen M, Arnon J, Brent RL. (1991b). Ultrastructure and function of the rat yolk sac: damage caused by teratogenic anti-VYS serum and recovery. *Teratology* 44:181-192.
- Beer WH, Hudson J, Guentzel N, Johnson RF, Schenker S. (1991). Zinc transport by the human placenta, effect of alcohol and ligand. *Placenta* 12:371.

- Behne D, Wolters W. (1979). Selenium content and glutathione peroxidase activity in the plasma and erythrocytes of non-pregnant and pregnant women. *J. Clin. Chem. Clin. Biochem.* Mar; 17(3):133-135.
- Benirschke K, Kaufmann P. (2000). *Pathology of the Human Placenta*. New York: Springer-Verlag.
- Benjaminov O, Hoffer E, Taitelman U, Urbach J, Brandes JM. (1992). Parathion transfer and acetylcholinesterase activity in an in-vitro perfused term human placenta. *Vet. Hum. Toxicol.* 34:10-2.
- Berlin M, Blanks R, Catton M, Kazantzis G, Mottet NK, Samiullah Y. (1992). Birth weight of children and cadmium accumulation in placentas of female nickel-cadmium (long-life) battery workers. In: *Cadmium in the Human Environment: Toxicity and Carcinogenicity*, eds., Nordberg GF, Herber RFM, Alessio L, IARC, Lyon, pp. 257-262.
- Bernus I, Roberts MS, Rasiah RL, Mortimer RH. (1999). Statistical moments for placental transfer of solutes in man. *J. Pharm. Pharmacol.* Dec;51(12):1381-1389.
- Boadi WY, Urbach J, Barnea ER, Brandes JM, Yannai S. (1992). Enzyme activities in the term human placenta: In vitro effect of cadmium. *Pharm. Toxicol.* 71:209.
- Boadi W, Yannai S, Urbach J, Brandes J, Sumner J. (1991). Transfer and accumulation of cadmium and the level of metallothionein expression in the human placenta perfused with cadmium. *Arch. Toxicol.* 65:318.
- Boal J, Plessinger MA, Van den Reydt C, RK, Miller RK. (1997). Pharmacokinetic and toxicity studies of AZT (Ziduvudine) in the following perfusion of human placenta for 14 hours. *Toxicol. Appl. Pharm.* 143: 13-21.
- Bonati M. (1996). Placental transfer of valproic acid after liposome encapsulation during in vitro human placenta perfusion. *J. Pharmacol. Exp. Ther.* Apr; 277(1):79-86.
- Bondy S. (1989). Intracellular calcium and neurotoxic events. *Neurotoxicol. Teratol.* 11, 527.
- Börzsönyi M, Bereczky A, Rudnai P, Csanady C, Horvath A. (1992). Epidemiological studies on human subjects exposed to arsenic in drinking water in Southeast Hungary. *Arch. Toxicol.* 66:77.
- Bourinbaiar AS, Nagorny R. (1992). Inhibitory effect of human chorionic gonadotropin (hCG) on HIV-1 transmission from lymphocytes to trophoblasts. *FEBS Lett.* 309(1):82-84.
- Brambell FWR. (1970). *The Transmission of Passive Immunity From Mother to Young*. North-Holland, Amsterdam.
- Breen JG, Eisenmann C, Gardner K, Horowitz S, Miller RK. (1992a). Early induction of metallothionein (MT) in the human term placenta perfused with cadmium. *Teratology* 45:502.
- Breen J, Eisenmann C, Horowitz S, Miller RK. (1994a). Expression of metallothionein protein and mRNA in the human placenta perfused with cadmium. *Reprod. Toxicol.* 8:297-306.
- Breen J, Eisenmann C, Horowitz S, Miller RK. (1994b). Cellular specific increases in metallothionein expression in the human placenta perfused with cadmium. *Reprod. Toxicol.* 8:297.
- Breen JG, Plessinger MA, Miller RK. (1993). Induction of metallothionein mRNA in human trophoblast cells (JAR). *Fed. Proc.* 7:A82.
- Breen J, Powlin S, Miller RK. (1995). Metallothionein mRNA localization and cellular distribution in the human placenta exposed to cadmium in vitro. *Teratology*, 51:266-272.
- Breen JG, Watkins R, Eisenmann C, Horowitz S, Miller RK. (1992b). localization of metallothionein mRNA in the term human placenta after perfusion with cadmium. *Placenta* 13:A6.

- Brent RL. (1964). The production of congenital malformations using tissue antisera. II. The spectrum and incidence of malformations following the administration of kidney antiserum to pregnant rats. *Amer. J. Anat.* 115:525-542.
- Brent RL, Averich E, Drapiewski VA. (1970). Production of congenital malformations using tissue antisera. *Teratology* 3:198.
- Brent RL, Beckman DA, Jensen M, Koszalka TR, Damjanov I. (1983). The embryopathologic effects of teratogenic yolk sac antiserum. *Trophoblast Res* 1:335-346.
- Brent RL, Beckman DA, Jensen M, Koszalka TR. (1990). Experimental yolk sac dysfunction as a model for studying nutritional disturbances in the embryo during early organogenesis. *Teratology* 41:405-413.
- Brunstrom B, Kihlstrom I, Lundkvist V. (1982). Studies of foetal death and foetal weight in guinea pig fed polychlorinated biphenyls (PCB). *Acta Pharm Toxicol* 50:100-103.
- Buchet JP, Roels H, Hubermont G, Lauwerys R (1978). Placental transfer of lead, mercury, cadmium, and carbon monoxide in women. II. Influence of some epidemiological factors on the frequency distributions of the biological indices in maternal and umbilical cord blood. *Environ. Res.* 15, 494-503.
- Bui T, Bark D, Perkins M, Vu H, Unadkat JD, Ho R. (1992). Effect of zidovudine on placental trophoblast and Hofbauer cell functions. *Placenta* 13:A8.
- Burbacher T, Rodier R, Weiss B. (1990). Methylmercury developmental neurotoxicity: a comparison of effects in humans and animals. *Neurotoxicol. Teratol.* 12:191-202.
- Burk RF, Hill KE, Read R, Bellew T. (1991). Response of rat selenoprotein P to selenium administration and fate of its selenium. *Am. J. Physiol.* 261:E26.
- Burton GJ, Jauniaux E, Watson AL. (1999). Maternal arterial connections to the placental intervillous space during the first trimester of human pregnancy: the Boyd collection revisited. *Am. J. Obstet. Gynecol.* Sep;181(3):718-724.
- Bzoskie L, Yen J, Tseng YT, Blount L, Kashiwai K, Padbury JF. (1997). Human placental norepinephrine transporter mRNA: expression and correlation with fetal condition at birth. *Placenta* Mar-Apr;18(2-3):205-210.
- Capelli R, Minganti V, Semino G, Bertarini W. (1986). The presence of mercury (total and organic) and selenium in human placentae. *Sci. Total Environ.* 48:69-79.
- Casey BM, Bawdon RE. (1998). Placental transfer of ritonavir with zidovudine in the ex vivo placental perfusion model. *Am. J. Obstet. Gynecol.* Sep;179 (3 Pt. 1):758-761.
- Cavalleri A, Minoia C, Polzoli L, Polatti F, Bolis PF. (1978). Lead in red blood cells and in plasma of pregnant women and their offspring. *Environ. Res.* 17:403-408.
- Cemerikic BJ, Chang J, Agbas A, Ahmed MS. (1991). Opioids regulate the release of human chorionic gonadotropin from trophoblast tissue. *Life Sci* 49:813-824.
- Cemerikic BJ, Schabbing R, Ahmed MS. (1992). Selectivity and potency of opioid peptides in regulating human chorionic gonadotropin release from term trophoblast tissue. *Peptides* 13:897-903.
- Chandwani S, Greco MA, Krasinski K, Borkowsky W. (1992). Pathology of the placenta in HIV-1 infection. *Prog. AIDS Pathol.* 3(1):65-81.
- Chatterjee MS, Abdel-Rahman M, Bhandal A, Klein P, Bogden J. (1988). Amniotic fluid cadmium and thiocyanate in pregnant women who smoke. *J. Reprod. Med.* 33(5):417-420.

- Chen CY, Lin TH. (1998). Nickel toxicity to human term placenta: In vitro study on lipid peroxidation. *J. Toxicol. Environ. Hlth.* May 8;54(1):37-47.
- Cho YS. (1991). Effects of cadmium chloride on Mg-ATPase activity in the rat placental labyrinth. *Trophoblast Res.* 5:217-.
- Cho YS, Panigel M, Wegmann R. (1988). Effects of cadmium on succinate dehydrogenase and ultrastructure of the cellular constituents of the rat placental labyrinth. *Cell. Mol. Biol.* 34:97.
- Christianson RE. (1979). Gross differences observed in the placentas of smokers and nonsmokers. *Am. J. Epidemiol.* 110(2):178-187.
- Chubatsu LS, Meneghini R. (1993). Metallothionein protects DNA from oxidative damage. *Biochem. J.* 1;291 (Pt 1):193-8.
- Collins MD, Mao GE. (1999). Teratology of retinoids. *Annu. Rev. Pharmacol. Toxicol.* 39:399-430.
- Clark ARL. (1977). Placental transfer of lead and its effect on the newborn. *Postgrad. Med. J.* 53:674.
- Clarkson TW. (1987). The role of biomarkers in reproductive and developmental toxicology. *Environ. Hlth. Persp.* 74:103.
- Clarkson T, Friberg L, Nordberg G, Sager P, eds. (1988). *Biological Monitoring of Toxic Metals.* New York: Plenum Press.
- Clarkson TW. (1993). Molecular and ionic mimicry of toxic metals. *Annu. Rev. Pharmacol. Toxicol.* 32:545-571.
- Cooper J, Jauniaux E, Gulbis B, Quick D, Bromley L. (1999). Placental transfer of fentanyl in early human pregnancy and its detection in fetal brain. *Br. J. Anaesth.* 82(6):929-931.
- Creason JP, Svendsgaard D, Bumgarner J, Pinkerton C, Hinners T. (1976). Maternal-fetal tissue levels of 16 trace elements in 8 selected continental United States communities. *Trace Subs. Environ. Hlth.* 10:53.
- Czekeridowski A, Neth-Jessee L, Miller RK. (1993). The effect of cysteine on methylmercury transfer and distribution in the in vitro perfused human placenta. *Placenta* 14:A13.
- Dancis, J., Money, W.L., Condon, G.P., Mortimer, L. (1958). The relative transfer of estrogens and their glucuronides across the placenta in the guinea pig. *J. Clin. Invest.* 37(10):1373-1378.
- Danielsson B, Dencker L. (1984). Effects of cadmium on the placental uptake and transport to the fetus of nutrients. *Biol. Res. Preg.* 5:93-101.
- Danielsson BRG, Dencker L, Lindgren A. (1983). Transplacental movement of inorganic lead in early and late gestation in the mouse. *Arch. Toxicol.* 54:97.
- Danielsson BR, Dencker L., Khayat A, Orsen I. (1984). Fetotoxicity of inorganic mercury in the mouse: distribution and effects on nutrient uptake by placenta and fetus. *Biol. Res. Preg. Perinatol.* 5(3):102-109.
- Danielsson BRG, Danielson M, Khayat A, Wide M., (1990). Comparative embryotoxicity of selenite and selenate: Uptake in murine embryonal and fetal tissues and effects on blastocysts and embryonic cells in vitro. *Toxicology* 63, 123.
- Davis BM, Miller RK, Brent RL, Koszalka TR. (1978). Placental transport of creatine in the rat. II. The Kinetic Parameters. *Biol. Neonate* 33:43-54.

- De Andreis C, Simoni G, Rossella F, Castagna C, Pesenti E, Porta G, Colucci G, Giuntelli S, Pardi G, Semprini AE. (1996). HIV-1 proviral DNA polymerase chain reaction detection in chorionic villi after exclusion of maternal contamination by variable number of tandem repeats analysis. *AIDS* 10(7):711-715.
- Delivoria-Papadopoulos M, Coburn RF, Forster II RE. (1972). The placental diffusing capacity for carbon monoxide in the pregnant woman at term. In: *Respiratory Gas Exchange and Blood Flow in the Placenta*, eds. Longo L, Bartels H. DHEW Publ. No (NIH) 73-361, pp. 259-265.
- Dencker L, Danielsson B, Khayat A, Lindgren A. (1983). Disposition of metals in the embryo and fetus. In: *Reproductive and Developmental Toxicity of Metals*, eds. Clarkson TW, Nordberg GF, Sager PR. New York: Plenum Press, pp. 607-632.
- Dencker L, Miller RK, Gasiewicz T, Rucci G. (1987). The pharmacokinetics of dioxin (TCDD) in the perfused human placenta. *Teratology* 35:74A-75A.
- Desoye G, Sibley C, Miller RK, eds. (2000). *Cell Biology and Immunology of the Placenta*, Harcourt Publishers.
- di Sant'Agnes PA, Jensen K, Levin AA, Miller RK. (1983). Placental toxicity of cadmium: an ultrastructural study. *Placenta* 4:149-163.
- Dickinson RG, Fowler DW, Kluck RM. (1989). Maternofetal transfer of phenytoin, p-hydroxy-phenytoin and p-hydroxy-phenytoin-glucuronide in the perfused human placenta. *Clin. Exp. Pharmacol. Physiol.* 16(10):789-797.
- Dilts PV Jr, Ahokas RA. (1979). Effects of dietary lead and zinc on pregnancy. *Am. J. Obstet. Gynecol.* 135:940.
- Ding Y, Laughlin T, Polliotti BM, Miller RK. (2000). HIV-1 infection in early human placentae in vitro: effects of tumor necrosis factor (TNF α) and Interleukins (IL-1 & IL-6). *Teratology* 61:436.
- Douglas G, King B. (1993). Colchicine inhibits human trophoblast differentiation in vitro. *Placenta* 14:187.
- Douglas GC, King BF. (1992). Maternal-fetal transmission of human immunodeficiency virus: a review of possible routes and cellular mechanisms of infection. *Clin. Infect. Dis.* 15(4):678-691.
- Ducsay CA, Umezaki H, Kaushal KM, Barrish A, Gilbert J, Manson J. (1996). Pharmacokinetic and fetal cardiovascular effects of enalaprilat administration to maternal rhesus macaques. *Am. J. Obstet. Gynecol.* 175(1):50-55.
- Ehrnst A, Lindgren S, Dictor M, Johansson B, Sonnerborg A, Czajkowski J, Sundin G, Bohlin AB. (1991). HIV in pregnant women and their offspring: evidence for late transmission. *Lancet* 27;338(8761):203-207.
- Eisenmann C, Miller RK. (1994). The placental transfer and toxicity of selenite relative to cadmium in the human term perfused placenta. *Placenta* 15:883-895.
- Eisenmann CJ, Miller RK. (1995a). Cadmium and glutathione: effect on human placental thromboxane and prostacyclin production. *Reprod. Toxicol.* 9:41-48.
- Eisenmann CJ, Miller RK. (1995b). The effect of selenium compounds (selenite, selenate, ebselen) on the production of thromboxane and prostacyclin by the human term placenta in vitro. *Toxicol. Appl. Pharm.* 135:18-24.
- Eisenmann CJ, Miller RK. (1996). Placental transport, metabolism and toxicity of metals, In: *Toxicology of Metals*, ed. Chang LW. Boca Raton, Fla.: CRC Press, pp. 1003-1026.

- Ericson A, Kallen B. (1989). Pregnancy outcome in women working as dentists, dental assistants or dental technicians. *Int. Arch. Occup. Environ. Hlth.* 61:329-333.
- Ernhart CB, Wolf AW, Kennard MJ, Erhard P, Filipovich HF, Sokol RJ. (1986). Intrauterine exposure to low levels of lead: The status of the neonate. *Arch. Environ. Hlth.* 41:287.
- Everson RB. (1987). A Review of approaches to the detection of genetic damage in the human fetus. *Environ. Hlth. Perspect.* 74:109-117.
- Faber JJ. (1977). Steady-state methods for the study of placental exchange. *Fed. Proc.* 36(12):2640-2646.
- Fagher U, Laudanski T, Schuetz A, Sipowicz M, Akerlund M. (1993). The relationship between cadmium and lead burdens and preterm labor. *Int. J. Gynecol. Obstet.* 40:109-114.
- Faulk WP, Labarrere CA. (1991). HIV proteins in normal human placentae. *Am. J. Reprod. Immunol.* 25(3):99-104.
- Ferm VH, Carpenter SJ. (1968). The relationship of cadmium and zinc in experimental mammalian teratogenesis. *Lab Invest.* 18(4):429-432.
- Feuston MH, Scott WJ. (1985). Cadmium induced forelimb ectrodactyly: a proposed mechanism of teratogenesis. *Teratology* 32:407-419.
- Fiala J, Hrubá D, Rezl P. (1998). Cadmium and zinc concentrations in human placentas. *Centr. Eur. J. Publ. Hlth.* 6:241-248.
- Fisher SE, Karl P. (1990). Histidine transfer across the human placenta: characteristics in the isolated perfused human placenta and the effect of ethanol. *Placenta* 11:157-166.
- Fisher SE, Atkinson M, Jacobson S, Sehgal P, Burnap J, Holmes E, Teichberg D, Kahn E, Jaffe R, Van Thiel D. (1983). Selective fetal nutrition: effect of in vivo ethanol exposure upon in vitro placental uptake of amino acids in non-human primate. *Pediatr. Res.* 17:704-707.
- Fisher SE, Atkinson M, Van Thiel D, Rosenblum E, David R, Holzman I. (1981). Selective fetal malnutrition: the effect of ethanol and acetaldehyde upon in vitro uptake of alpha amino isobutyric acid by human placenta. *Life Sciences* 29:1283-1288.
- Fisher SE, Duggy L, Atkinson M. (1986). Selective fetal malnutrition: effect of acute and chronic exposure upon rat placenta Na,K-ATPase activity. *Alcoholism* 10:150-153.
- Fisher S, Genbacev O, Maidji E, Pereira L. (2000). Human cytomegalovirus infection of placental cytotrophoblasts in vitro and in utero: implications for transmission and pathogenesis. *J. Virol.* 74(15):6808-6820.
- Fowler DW, Eadie MJ, Dickinson RG. (1989). Transplacental transfer and biotransformation studies of valproic acid and its glucuronide(s) in the perfused human placenta. *J. Pharmacol. Exp. Ther.* 249(1):318-323.
- Frank HG, Genbacev O, Blaschitz A, Chen CP, Clarson L, Evain-Brion D, Gardner L, Malek A, Morrish D, Loke YW, Tarrade A. (2000). Cell culture models of human trophoblast—primary culture of trophoblast—a workshop report. *Placenta.* 21 Suppl. A:S120-S122.
- Frank HG, Morrish DW. (2001). Cell culture models of human trophoblast – primary culture of trophoblast – a workshop report. *Trophoblast Research* 15, in press.
- Franklin CA, Inskip MJ, Baccanale CL, Edwards CM, Manton WI, Edwards E, O’Flaherty EJ. (1997). Use of sequentially administered stable lead isotopes to investigate changes in blood lead during pregnancy in a nonhuman primate (*Macaca fascicularis*). *Fundam Appl Toxicol.* 39(2):109-119.

- Freeman S, Lloyd J. (1983). Evidence that protein ingested by the rat visceral yolk sac yields amino acids for synthesis of embryonic protein. *J. Embryo. Expt. Morph.* 73:307-315.
- Freeman SJ, Lloyd JB. (1986). Evidence that suramin and aurothiomalate are teratogenic in rat by disturbing yolk sac-mediated embryonic protein nutrition. *Chem. Biol. Interact.* 58(2):149-160.
- Fukasawa Y, Segawa H, Kim JY, Chairoungdua A, Kim DK, Matsuo H, Cha SH, Endou H, Kanai Y. (2000). Identification and Characterization of a Na⁺-independent neutral amino acid transporter that associates with the 4F2 heavy chain and exhibits substrate selectivity for small neutral D and L-amino acids. *J. Biol. Chem.* 275 (13):9690-9698.
- Galicia-Garcia V, Rojas-Lopez M, Rojas R, Olaiz G, Rios C. (1997). Cadmium levels in maternal, cord, and newborn blood in Mexico City. *Toxicol. Lett.* 91:57-61.
- Ganapathy V, Prasad PD, Ganapathy ME, Leibach FH. (2000). Placental transporters relevant to drug distribution across the maternal-fetal interface. *J. Pharmacol. Exper. Therap.* 294(2):413-420.
- Garland M. (1998). Pharmacology of drug transfer across the placenta. *Obstet. Gynecol. Clin. North. Am.* 1998 Mar;25(1):21-42.
- Gatsonis CA, Needleman HL. (1992). Recent epidemiologic studies of low-level lead exposure and the IQ of children: A meta-analytic review. In: *Human Lead Exposure*, ed. Needleman HL, Boca Raton, Fla.: CRC Press, ch. 15.
- Gautieri RF. (1972). Pharmacologic aspects of placental gas exchange. In: *Respiratory Gas Exchange and Blood Flow in the Placenta*, eds. Longo L, Bartels H. DHEW Publ. No (NIH). 73-361, pp. 419-437.
- Genbacev O, Miller RK. (1993). Three-dimensional culture of placental villous tissue explants - an in vitro model for implantation. *Methods in Toxicology* 3B:205-245.
- Genbacev O, Miller RK. (2000). Post-implantation differentiation and proliferation of cytotrophoblast cells: in vitro models--a review. *Placenta* 21:S45-S49.
- Genbacev O, deMesy, Jensen K, Powlin SS, Miller RK. (1993). In vitro differentiation and ultrastructure of human extravillous trophoblast (EVT) cells. *Placenta* 14:463-475.
- Genbacev O, Powlin S, Miller RK. (1994). The effect of epidermal growth factor (EGF) on the regulation of human extravillous trophoblast cell function. *Trophoblast Research* 8:427-443.
- Genbacev O, White, T, Miller RK. (1993). Human trophoblast cultures: models for implantation and reproductive toxicology. *Reprod. Toxicol.* 7:75-94.
- Genbacev O, Schubach S, Miller RK. (1992). Villous culture of first trimester human placenta - model to study extravillous trophoblast (EVT) differentiation. *Placenta* 13:439-461.
- Gerber G, Maes J, Deroo J. (1978). Effect of dietary lead on placental blood flow and on fetal uptake of a-amino isobutyrate. *Arch Toxicol.* 41:125.
- Giurgiovich AJ, Diwan BA, Lee KB, Anderson LM, Rice JM, Poirier MC. (1996). Cisplatin-DNA adduct formation in maternal and fetal rat tissues after transplacental cisplatin exposure. *Carcinogenesis* 17(8):1665-1669.
- Gladen BC, Monaghan SC, Lukyanova EM, Hulchiy OP, Shkyryak-Nyzhnyk ZA, Sericano JL, Little RE. (1999). Organochlorines in breast milk from two cities in Ukraine. *Environ. Hlth. Persp.* 107:459-462.
- Goldberg JM, Falcone T. (1999). Effect of diethylstilbestrol on reproductive function. *Fertil Steril.* 72(1):1-7.

- Goldenberg RL, Vermund SH, Goepfert AR, Andrews WW. (1998). Choriodecidual inflammation: a potentially preventable cause of perinatal HIV-1 transmission? *Lancet* 352(9144):1927-1930.
- Goncharuk G. (1977). Problems relating to occupational hygiene of women in production of mercury. *Gigiena Truda i Professional 'nye Zabolevaniya* 5:17-20 (as reported in Barlow and Sullivan, 1982).
- Goodman Gilman's (1998). *The Pharmacological Basis of Therapeutics*, eds. Hardman JG, Limbird LE, Molinoff PB, Ruddon RW. A Goodman Gilman, 9th Edition.
- Goodman DR, James RC, Harbison RD. (1982a). Placental Toxicology. *Food Chem. Toxicol.* 20:123-128.
- Goodman D, James R, Harbison R. (1982b). Perturbations of alpha-amino isobutyric acid transport in human placental membranes: Direct effects of HgCl₂, CH₃HgCl and CdCl₂. *Terat. Carcino. Mutagen.* 3:89-96.
- Goyer RA. (1986). Toxic effects of metals. In: Casarett and Soull's *Toxicology: The Basic Science of Poisons*, 3d ed, eds. Klaassen CD, Amdur MO, Doull J. New York: Macmillan Publishing Co, chap 19.
- Goyer RA. (1990). Transplacental transport of lead. *Environ. Hlth. Perspect.* 89:101-105.
- Goyer RA, Haust MD, Cherian MG. (1992). Cellular localization of metallothionein in human term placenta. *Placenta* 13:349.
- Gude N, Krishna B, King R, Brennecke S, Boura A. (1989). Effects of opioids on acetylcholine output of perfused human placental cotyleda. *Placenta* 10:445-454.
- Gulbis B, Jauniaux E, Decuyper J, Thiry P, Jurkovic D, Campbell S. (1994). Distribution of iron and iron-binding proteins in first-trimester human pregnancies. *Obstet. Gynecol.* 84(2):289-293.
- Guo Y, Hendrickx AG, Overstreet JW, Dieter J, Stewart D, Tarantal AF, Laughlin L, Lasley BL. (1999). Endocrine biomarkers of early fetal loss in cynomolgus macaques (*Macaca fascicularis*) following exposure to dioxin. *Biol. Reprod.* 60(3):707-713.
- Gupta GS, Singh J, Gupta A. (1997). Trace metals and metalloenzymes in placenta after oral administration of lead acetate. *Biol. Trace Elem. Res.* 60(1-2):145-152.
- Gurtoo H, Williams C, Gottlieb K, Mulhern A, Caballes L, Vaught J, Marinello A, Bansal S. (1983). Population distribution of placental benzo(a)pyrene metabolism in smokers. *Int. J. Cancer* 31:29-37.
- Guvén K, Deveci E, Akba O, Onen A, de Pomerai D. (1998). The accumulation and histological effects of organometallic fungicides Propineb and Maneb in the kidneys of fetus and female rats during pregnancy. *Toxicol. Lett.* Oct 15;99(2):91-98.
- Hahn T, Hahn D, Blaschitz A, Korgun ET, Desoye G, Dohr G. (2000). Hyperglycaemia-induced subcellular redistribution of GLUT1 glucose transporters in cultured human term placental trophoblast cells. *Diabetologia* 43:173-180.
- Hakkola J, Pasanen M, Pelkonen O, Hukkanen J, Evisalmi S, Anttila S, Rane A, Mantyla M, Purkunen R, Saarikoski S, Tooming M, Raunio H. (1997). Expression of CYP1B1 in human adult and fetal tissues and differential inducibility of CYP1B1 and CYP1A1 by Ah receptor ligands in human placenta and cultured cells, *Carcinogenesis* 18: 391-397.
- Hakkola J, Pelkonen O, Pasanen M, Raunio H. (1998). Xenobiotic-metabolizing cytochrome P450 enzymes in the human fetoplacental unit: role in intrauterine toxicity. *Crit. Rev. Toxicol.* 28(1):35-72. Review.

- Hakkola J, Raunio H, Purkunen R, Pelkonen O, Saarikoski S, Cresteil T, Pasanen M. (1996). Detection of cytochrome P450 gene expression in human placenta in first trimester of pregnancy. *Biochem Pharmacol.* Jul 26;52(2):379-383.
- Hallen IP, Breitholtz-Emanuelsson A, Hult K, Olsen M, Oskarsson A. (1998). Placental and lactational transfer of ochratoxin A in rats. *Nat Toxins.* 6(1):43-49.
- Halwachs-Baumann G, Wilders-Truschnig M, Desoye G, Hahn T, Kiesel L, Klingel K, Rieger P, Jahn G, Sinzger C. (1998). Human trophoblast cells are permissive to the complete replicative cycle of human cytomegalovirus. *J. Virol.* 72(9):7598-7602.
- Ham EA, Egan RW, Soderman DD, Gale PH, Kuehl FA Jr. (1979). Peroxidase-dependent deactivation of prostacyclin synthetase. *J. Biol. Chem.* 254:2191.
- Hanlon DP, Ferm VH. (1987). The concentration and chemical status of arsenic in the early placentas of arsenate-dosed hamsters. *Environ. Res.* 42:546.
- Hanselaar A, van Loosbroek M, Schuurbiens O, Helmerhorst T, Bulten J, Bernhelm J. (1997). Clear cell adenocarcinoma of the vagina and cervix. An update of the central Netherlands registry showing twin age incidence peaks. *Cancer* 79(11):2229-2236.
- Haque AK, Vrazel DM, Burau KD, Cooper SP, Downs T. (1996). Is there transplacental transfer of asbestos? A study of 40 stillborn infants. *Ped. Pathol. Lab. Med.* Nov-Dec;16(6):877-892.
- Harrison WP, Frazier JC, Mazzanti EM, Hood RD. (1980). Teratogenicity of disodium methanarsonate and sodium dimethylarsinate (sodium cacodylate) in mice. *Teratology* 21:43A.
- Hassoun EA, Walter AC, Alsharif NZ, Stohs SJ. (1997). Modulation of TCDD-induced fetotoxicity and oxidative stress in embryonic and placental tissues of C57BL/6J mice by vitamin E succinate and ellagic acid. *Toxicology* Dec 19;124(1):27-37.
- Hassoun EA, Stohs SJ. (1996). TCDD, endrin and lindane induced oxidative stress in fetal and placental tissues of C57BL/6J and DBA/2J mice. *Comp. Biochem. Physiol. C Pharmacol. Toxicol. Endocrinol.* Sep;115(1):11-18.
- Heidam L. (1984). Spontaneous abortions among dental assistants, factory workers, painters and gardening workers. *J. Epidemiol. Commun. Hlth.* 38:149-155.
- Heikkinen T, Laine K, Neuvonen P, Ekblad U. (2000). The transplacental transfer of the macrolide antibiotics erythromycin, roxithromycin and azithromycin. *Brit. J. Obs. Gyn.* 107:770-775.
- Hemmings WA, Jones RE, Faulk WP. (1975). Transport across the rabbit foetal yolk sac of fractions of IgG from several mammalian species. *Immunology* 28:411-418.
- Henderson GI, Turner D, Patwardhan R, Lumeng L, Hoyumpa A, Schenker S. (1991). Inhibition of placental valine uptake after acute and chronic maternal ethanol consumption. *J. Pharm. Expt. Therap.* 216:465-472.
- Hendrickx AG, Peterson PE. (1997). Perspectives on the use of the baboon in embryology and teratology research. *Hum. Reprod. Update.* 3(6):575-592.
- Hendrickx AG, Tzimas G, Korte R, Hummler H. (1998). Retinoid teratogenicity in the macaque: verification of dosing regimen. *J. Med. Primatol.* 27(6):310-318.
- Henry EC, Miller RK. (1986a). Disposition of diethylstilbestrol and estradiol in the fetal rat: Correlation with teratogenic potency. *Biochem. Pharm.* 35:1993-2001.
- Henry EC, Miller RK. (1986b). The antiestrogen, LY117018. A potent estrogenic teratogen in the rat. *Teratology* 34:59-63.

- Henry EC, Miller RK, Baggs RB. (1984). Direct fetal injections of diethylstilbestrol and 17-estradiol: a method for investigating their teratogenicity. *Teratology* 29:297-304.
- Herbst AL, Hubby MM, Azizi F, Makii MM. (1981). Reproductive and gynecologic surgical experience in diethylstilbestrol-exposed daughters. *Am. J. Obstet. Gynecol.* 15;141(8):1019-1028.
- Herbst AL, Ulfelder H, Poskanzer DC. (1971). Adenocarcinoma of the vagina. Association of maternal stilbestrol therapy with tumor appearance in young women. *N. Engl. J. Med.* 284(15):878-881.
- Herman JL, Chay SH. (1998). Quantitative whole-body autoradiography in pregnant rabbits to determine fetal exposure of potential teratogenic compounds. *J. Pharmacol. Toxicol. Meth.* 39(1):29-33.
- Hood RD, Harrison WP, Vedel GC. (1982). Evaluation of arsenic metabolites for prenatal effects in the hamster. *Bull. Environ. Contam. Toxicol.* 29(6):679-687.
- Hood RD, Thacker GT, Patterson BL. (1977). Effects in the mouse and rat of prenatal exposure to arsenic. *Environ. Health Perspect.* 19:219.
- Hood RD, Vedel-Macrandner GC, Zaworotko MJ, Tatum FM, Meeks RG. (1987). Distribution, metabolism, and fetal uptake of pentavalent arsenic in pregnant mice following oral or intraperitoneal administration. *Teratology.* 35(1):19-25.
- Hood RD, Vedel GC, Zaworotko MJ, Tatum FM, Meeks RG. (1988). Uptake, distribution, and metabolism of trivalent arsenic in the pregnant mouse. *J. Toxicol. Environ. Health* 25(4):423-434.
- Horowitz RS, Dart RC, Jarvie DR, Bearer CF, Gupta U. (1997). Placental transfer of - acetylcysteine following human maternal acetaminophen toxicity. *J. Toxicol. Clin. Toxicol.* 35(5):447-451.
- Huel G, Godin J, Frery N, Girard F, Moreau T, Nessmann C, Blot P. (1993). Aryl hydrocarbon hydroxylase activity in human placenta and threatened preterm delivery. *J. Expo. Anal. Environ. Epidemiol.* 3 Suppl 1:187-199.
- Hunter ES 3d, Phillips LS, Goldstein S, Sadler TW. (1991). Altered visceral yolk sac function produced by a low-molecular-weight somatomedin inhibitor. *Teratology* 43:331-340.
- Hunter ES 3d, Sadler TW. (1992). The role of the visceral yolk sac in hyperglycemia-induced embryopathies in mouse embryos in vitro. *Teratology* 45:195-203.
- Hustin J, Pereira-Leite L, Van Cauwenberge JR, Franchimont P. (1986). Prolactin in the feto-placental unit. Immunohistochemical data. *Acta Med. Port.* 7(1):7-13.
- Ilekis J, Benveniste R. (1983). The arachidonic acid pathway and the secretion of chorionic gonadotropin (hCG) and progesterone by the cultured human choriocarcinoma JEG-3 cell. *Trophoblast Res* 1:289-300.
- Illsley NP. (2000). Glucose transporters in the human placenta. *Placenta* 21(1):14-22.
- Imura N, Kitahra J, Seko Y, Utsumi H, Hamada A. (1994). Free radicals formed in the reaction of selenite with glutathione in vitro. *The Toxicologist* 14:A1008.
- Itoh N, Fujita Y, Nakanishi H, Kawai Y, Mayumi T, Hwang GS, Min K, Onosaka S, Muto N, Tanaka K. (1996). Binding of Cd to metallothionein in the placenta of Cd- treated mouse. *J. Toxicol. Sci.* Feb;21(1):19-27.
- Iwersen S, Schmoldt A, Schulz F, Puschel K. (1998). Evidence of gestational heroin exposure by comparative analysis of fetal and maternal body fluids, tissues, and hair in a heroin-related death. *J. Anal. Toxicol.* Jul-Aug;22(4):296-298.
- Jacquet P, Gerber GB. (1979). Teratogenic effects of lead in the mouse. *Biomedicine* 30:223.

- Jacob S, Abdel-Aziz AA, Shouman SA, Ahmed AE. (1998). Effect of glutathione modulation of the distribution and transplacental uptake of 2-[14C]- chloroacetonitrile (CAN) quantitative whole-body autoradiographic study in pregnant mice. *Toxicol. Ind. Hlth.* Jul-Aug;14(4):533-546.
- Jaffe R, Jauniaux E, Hustin J. (1997). Maternal circulation in the first-trimester human placenta--myth or reality? *Am. J. Obstet. Gynecol.* 176(3):695-705.
- Jain S.K, Wise R, Bocchini JJ Jr. (1996). Vitamin E and vitamin E-quinone levels in red blood cells and plasma of newborn infants and their mothers. *J. Am. Coll. Nutr.* Feb;15(1):44-48.
- Jaiswal A, Gonzalez F, Nebert D. (1985). Human P-450 gene sequence and correlation of mRNA with genetic differences in benzo(a)pyrene metabolism. *Nucleic Acid Res.* 13:4503-4520.
- Jansson T. (2001). Amino acid transporters in the human placenta. *Ped. Res.* 49(2):141-147.
- Jauniaux E, Gulbis B. (2000a). Fluid compartments of the embryonic environment. *Hum. Reprod. Update* 6(3):268-278.
- Jauniaux E, Gulbis B. (2000b). In vivo investigation of placental transfer early in human pregnancy. *Eur. J. Obstet. Gynecol. Reprod. Biol.* Sep;92(1):45-49.
- Jauniaux E, Burton GJ, Moscoso GJ, Hustin J. (1991). Development of the early human placenta: a morphometric study. *Placenta* 12(3):269-276.
- Jauniaux E, Gulbis B, Jurkovic D, Schaaps JP, Campbell S, Meuris S. (1993). Protein and steroid levels in embryonic cavities in early human pregnancy. *Hum. Reprod.* 8(5):782-787.
- Jauniaux E, Jurkovic D, Gulbis B, Zaidi J, Meuris S, Campbell S (1994a). Biochemical composition of the coelomic fluid in anembryonic pregnancy. *Am. J. Obstet. Gynecol.* 171(3):849-853.
- Jauniaux E, Sherwood RA, Jurkovic D, Boa FG, Campbell S. (1994b). Amino acid concentrations in human embryological fluids. *Hum. Reprod.* 9(6):1175-1179.
- Jauniaux E, Jurkovic D, Gulbis B, Liesnard C, Lees C, Campbell S. (1995). Materno-fetal immunoglobulin transfer and passive immunity during the first trimester of human pregnancy. *Hum. Reprod.* 10(12):3297-3300.
- Jauniaux E, Jurkovic D, Lees C, Campbell S, Gulbis B. (1996). In vivo study of diazepam transfer across the first trimester human placenta. *Hum. Reprod.* 11(4):889-892.
- Jauniaux E, Lees C, Jurkovic D, Campbell S, Gulbis B. (1997). Transfer of inulin across the first-trimester human placenta. *Am. J. Obstet. Gynecol.* 176(1 Pt 1):33-36.
- Jauniaux E, Gulbis B, Gerlo E, Rodeck C. (1998a). Free amino acid distribution inside the first trimester human gestational sac. *Early Hum. Dev.* May 29;51(2):159-169.
- Jauniaux E, Gulbis B, Shannon C, Maes V, Bromley L, Rodeck C. (1998b). Placental propofol transfer and fetal sedation during maternal general anaesthesia in early pregnancy. *Lancet* Jul 25;352(9124):290-291.
- Jauniaux E, Watson AL, Hempstock J, Bao YP, Skepper JN, Burton GJ. (2000). Onset of maternal arterial blood flow and placental oxidative stress: A possible factor in human early pregnancy failure. *Am. J. Pathol.* Dec;157(6):2111-2122.
- Jolibois LS Jr, Burow ME, Swan KF, George WJ, Anderson MB, Henson MC. (1999). Effects of cadmium cell viability, trophoblastic development, and expression of low density lipoprotein receptor transcripts in cultured human placental cells. *Reprod. Toxicol.* Nov-Dec;13(6):473-480.

- Jones CJ, Backlin BM, Stoddart RW, Dantzer V. (1997). Environmental pollutants as aetiological agents in female reproductive pathology: placental glycan expression in normal and polychlorinated biphenyl (PCB)-exposed mink (*Mustela vison*). *Placenta*. Nov;18(8):689-699.
- Jun Y, Kim E, Jin M, Sung HC, Han H, Geraghty DE, Ahn K. (2000). Human cytomegalovirus gene products US3 and US6 down-regulate trophoblast class I MHC molecules. *J. Immunol.* 164(2):805-811.
- Jurkovic D, Jauniaux E, Campbell S, Pandya P, Cardy DL, Nicolaides KH. (1993). Coelocentesis: a new technique for early prenatal diagnosis. *Lancet* 26;341(8861):1623-1624.
- Kagey BT, Bumgarner JE, Creason JP. (1977). Arsenic levels in maternal-fetal tissue sets. In: *Trace Substances in Environmental Health XI*, ed. Hemphill DD. Columbia, Mo.: University of Missouri Press.
- Kantola M, Purkunen R, Kroger P, Tooming A, Juravskaja J, Pasanen M, Saarikoski S, Vartiainen T. (2000). Accumulation of cadmium, zinc, and copper in maternal blood and developmental placental tissue: differences between Finland, Estonia, and St. Petersburg. *Environ. Res.* 2000 May;83(1):54-66.
- Karl PI, Divald A, Diehl AM, Fisher SE. (1998). Altered cyclic AMP-dependent human chorionic gonadotropin production in cultured human placental trophoblasts exposed to ethanol. *Biochem. Pharmacol.* Jan 1;55(1):45-51.
- Karp WB, Robertson AF. (1977). Correlation of human placental enzymatic activity with trace metal concentration in placentas from three geographical locations. *Environ. Res.* 13(3):470-477.
- Kaufmann P, Miller RK, eds. (1988). *Placental Vascularization and Blood Flow - Basic Research and Clinical Application*, Plenum Medical, New York.
- Kaufmann RE, Korhonen MO, Stramm T, Adam E, Kaplan A. (1982). Development of clear cell adenocarcinoma in DES-exposed offspring under observation. *Obstet. Gynecol.* 59:568-572.
- Kaunitz H, Malins D, McKay D. (1962). Studies of the generalized schwartzman reaction by diet. II. *J Expt Med* 115:127-136.
- Kay HH, Grindle KM, Magness RR. (2000). Ethanol exposure induces oxidative stress and impairs nitric oxide availability in the human placental villi: a possible mechanism of toxicity. *Am. J. Obstet. Gynecol.* 182(3):682-688.
- Kay HH, Hawkins SR, Wang Y, Mika DE, Ribeiro AA, Spicer, LD. (1993). Phosphorus 31 magnetic resonance spectroscopy of perfused human placental villi under varying oxygen concentrations. *Am. J. Obstet. Gynecol.* 168(1 Pt 1):246-252.
- Kelman BJ. (1979). Effects of toxic agents on movement of material across the placenta. *Fed. Prod.* 38:2247-2250.
- Kelman BJ, van Kreel BK. (1987). Criteria for standardizing and judging viability of placental perfusions in animals. *Trophoblast Research* 2:515-522.
- Kelman BJ, Sikov MR. (1981). Plutonium movements across the haemochorial placenta of the guinea pig. *Placenta (Suppl. 3)*:319-326.
- Kelman BJ, Walter BK. (1980a). Fetal to maternal cadmium movements across the perfused hemochorial placenta of the guinea pig. *Toxicol. Appl. Pharm.* 52, 400-406.
- Kelman BJ, Walker BK. (1980b). Transplacental movements of inorganic lead from mother to fetus. *Proc. Soc. Exp. Biol. Med.* 163:278-282.

- Kelman BJ, Walter BK, Sasser LB. (1982). Fetal distribution of mercury following introduction of methylmercury into porcine maternal circulation. *J. Toxicol. Environ. Hlth.* 1Aug;10(2):191-200.
- Kenney SP, Kekuda R, Prasad PD, Leibach FH, Devoe LD, Ganapathy V. (1999). Cannabinoid receptors: their role in the regulation of the serotonin transporter in human placenta. *Am. J. Obstet. Gynecol.* 181(2):491-497.
- Kesson AM, Fear WR, Kazazi F, Mathijs JM, Chang J, King NJ, Cunningham AL. (1993). Human immunodeficiency virus type 1 infection of human placental macrophages in vitro. *J. Infect. Dis.* 168(3):571-579.
- Khan SA, Ball RB, Hendry WJ III. (1998). Effects of neonatal administration of diethylstilbestrol in male hamsters: disruption of reproductive function in adults after apparently normal pubertal development. *Biol Reprod.* 58(1):137-142.
- Khera AK, Wibberley DG, Dathan JG. (1980). Placental and stillbirth tissue lead concentrations in occupationally exposed women. *Br. J. Ind. Med.* 37(4):394-396.
- Kiihlstrom I. (1982). Placental transport of non-metabolizable α -aminoisobutyric acid in guinea pigs given a commercial chlorobiphenyl preparation or a defined pure chlorobiphenyl. *Acta Pharm. Toxicol.* 51:428-433.
- Kimmel CA, Young JF. (1983). Correlating pharmacokinetics and teratogenic endpoints. *Fund. Appl. Toxicol.* 3(4):250-255.
- Kimmel CA, Wilson JG, Schumacher HJ. (1971). Studies on metabolism and identification of the causative agent in aspirin teratogenesis in rats. *Teratology* 4(1):15-24.
- King A, Thomas L, Bischof P. (2000). Cell culture models of trophoblast II: Trophoblast cell lines - A workshop report. *Trophoblast Research* 14: S113-S119.
- Klaassen CD, Liu J, Choudhuri S. (1999). Metallothionein: an intracellular protein to protect against cadmium toxicity. *Annu. Rev. Pharmacol. Toxicol.* 39:267-294.
- Kliman HJ, Feinman MA, Strauss JF III. (1987). Differentiation of human cytotrophoblast into syncytiotrophoblast in culture. *Trophoblast Research* 2:407-422.
- Klopov VP. (1998). Persistent organic compounds in women residing in the Russian Arctic. *Int. J. Circumpolar Hlth.* 57 Suppl 1:555-560.
- Kochhar DM, Christian MS. (1997). Tretinoin. A review of the nonclinical developmental toxicology experience. *J. Am. Acad. Dermatol.* 36(3 Pt 2):S47-S59.
- Kochhar DM, Jiang H, Penner JD, Heyman RA. (1995). Placental transfer and developmental effects of 9-cis retinoic acid in mice. *Teratology* 51(4):257-65.
- Kopecky EA, Simone C, Knie B, Koren G. (1999). Transfer of morphine across the human placenta and its interaction with naloxone. *Life Sci.* 65(22):2359-2371.
- Koren G, Chang N, Gonen R, Klein J, Weiner L, Demshar H, Pizzolato S, Radde I, Shime J. (1990). Lead exposure among mothers and their newborns in Toronto. *Can. Med. Assoc. J.* 142:1241.
- Korpela H, Loueniva R, Yrjanheikki E, Kauppila A. (1984). Selenium concentrations in maternal and umbilical cord blood, placenta and amniotic membranes. *Int. J. Vit. Nut. Res.* 54:257.
- Korpela H, Loueniva R, Yrjanheikki E, Kauppila A. (1986). Lead and cadmium concentrations in maternal and umbilical cord blood, amniotic fluid, placenta, and amniotic membranes. *Am. J. Obstet. Gynecol.* 155(5):1086-1089.

- Kostrikis LG. (2000). Impact of natural chemokine receptor polymorphisms on perinatal transmission of human immunodeficiency virus type 1. *Teratology* 61(5):387-390.
- Krewski D, Oxman A, Torrance G W. (1989). A decision-oriented framework for evaluating environmental risk management strategies: A case study of lead in gasoline. In: *The Risk Assessment of Environmental and Human Health Hazards A Textbook of Case Studies*, ed. Paustenbach DJ. New York: John Wiley & Sons, ch. 31.
- Kudo Y, Boyd CAR. (2001). Characterisation of L-tryptophan transporters in human placenta: a comparison of brush border and basal membrane vesicles. *J. Physiol.* 531.2:405-416.
- Kuhnert PM, Erhard P, Kuhnert BR. (1977). Lead and delta-aminolevulinic acid dehydratase in RBC's of urban mothers and fetuses. *Environ. Res.* 14(1):73-80.
- Kuhnert PM, Kuhnert BR, Erhard P. (1981). Comparison of mercury levels in maternal blood, fetal cord blood, and placental tissues. *Am. J. Obstet. Gynecol.* 139(2):209-213.
- Kuhnert PM, Kuhnert BR, Bottoms SF, Erhard P. (1982). Cadmium levels in maternal blood, fetal cord blood, and placental tissues of pregnant women who smoke. *Am. J. Obstet. Gynecol.* 142(8):1021-1025.
- Kuhnert BR, Kuhnert PM, Debanne S, Williams TG. (1987). The relationship between cadmium, zinc and birth weight in pregnant women who smoke. *Am. J. Obstet. Gynecol.* 157:1247-1251.
- Kuhnert BR, Kuhnert PM, Lazebnik N, Erhard P. (1988). The effect of maternal smoking on the relationship between maternal and fetal zinc status and infant birth weight. *J. Am. Coll. Nutr.* 7(4):309-316.
- Kulkarni AP, Treinen KA, Bestervelt LL. (1987). Human placental Ca²⁺-ATPase: Targets for organochlorine pesticides? *Trophoblast Research* 2:329-341.
- Kumar S, Tonn GR, Riggs KW, Rurak DW. (1999). Diphenhydramine Disposition in the Sheep Maternal- Placental-Fetal Unit: Determinants of Plasma Drug concentrations in the mother and the fetus. *J. Pharmaceut. Sci.* 88: 1259-1265.
- Kumar S, Wong H, Yeung SA, Riggs KW, Abbott FS, Rurak DW. (2000). Disposition of valproic acid in maternal, fetal, and newborn sheep. I: placental transfer, plasma protein binding, and clearance. *Drug Metab. Dispos.* Jul;28(7):845-856.
- Kuntz WD, Pitkin RM, Bostrom AW, Hughes MS. (1982). Maternal and cord blood background mercury levels: a longitudinal surveillance. *Am. J. Obstet. Gynecol.* 143(4):440-443.
- Lagerkvist BJ, Nordberg GF, Soederberg HA, Ekesrydh S, Englyst V, Gustavsson M, Gustavsson NO, Wiklund, DE. (1992). Placental transfer of cadmium. In: *Cadmium in the Human Environment: Toxicity and Carcinogenicity*, eds. Nordberg GF, Herber RFM, Alessio L. IARC, Lyon, pp. 257-262.
- Lammer EJ, Chen DT, Hoar RM, Agnish ND, Benke PJ, Braun JT, Curry CJ, Fernhoff PM, Grix AW Jr, Lott IT et al. (1985). Retinoic acid embryopathy. *N. Engl. J. Med.* 313(14):837-841.
- Lampela ES, Nuutinen LH, Ala-Kokko TI, Parikka RM, Laitinen RS, Jouppila PI, Vahakangas KH. (1999). Placental transfer of sulindac, sulindac sulfide, and indomethacin in a human placental perfusion model. *Am. J. Obstet. Gynecol.* 180(1 Pt. 1):174-180.
- Lassiter TL, Barone S Jr, Moser VC, Padilla S. (1999). Gestational exposure to chlorpyrifos: Dose response profiles for cholinesterase and carboxylesterase activity. *Toxicol. Sci.* 52(1):92-100.
- Lassiter TL, Padilla S, Mortensen SR, Chanda SM, Moser VC, Barone S Jr. (1998). Gestational exposure to chlorpyrifos: apparent protection of the fetus? *Toxicol. Appl. Pharmacol.* 152(1):56-65.

- Lau JC, Joseph MG, Cherian MG. (1998). Role of placental metallothionein in maternal to fetal transfer of cadmium in genetically altered mice. *Toxicology* 127(1-3):167-178.
- Lazebnik N, Kuhnert BR, Kuhnert PM. (1989). Zinc, cadmium, and hypertension in parturient women. *Am. J. Obstet. Gynecol.* 161(2):437-440.
- Leake R, Stegner H, Palmer S, Oakes G, Fisher D. (1984). Cortisol facilitates ovine fetal/maternal water transfer. *Pediatr. Res.* 18:631-633.
- Lee AW, Mitra D, Laurence J. (1997). Interaction of pregnancy steroid hormones and zidovudine in inhibition of HIV type 1 replication in monocytoid and placental Hofbauer cells: implications for the prevention of maternal-fetal transmission of HIV. *AIDS Res. Hum. Retroviruses.* 20;13(14):1235-1242.
- Lee SR, Bar-Noy S, Kwon J, Levine RL, Stadtman TC, Rhee SG. (2000). Mammalian thioredoxin reductase: Oxidation of the C-terminal cysteine/selenocysteine active site forms a thioselenide, and replacement of selenium with sulfur markedly reduces catalytic activity. *Proc. Natl. Acad. Sci. USA* 14;97(6):2521-2526.
- Lehman L, Poisner A. (1984). Induction of metallothionein synthesis in cultured human trophoblasts by cadmium and zinc. *J. Tox. Environ. Hlth.* 14:419.
- Leichtweiss HP, Lisboa B, Steinborn C. (1987). Uptake of ascorbic acid and its oxidized products in the isolated guinea pig placenta. *Trophoblast Research* 2:501-514.
- Leonard A, Gerber GB, Jacquet P. (1983). Effect of lead on reproductive capacity and development of mammals. In: *Reproductive and Developmental Toxicity of Metals*, eds. Clarkson TW, Nordberg GF, Sager PR. New York: Plenum Press, p. 357.
- Letcher RJ, van Holsteijn I, Drenth HJ, Norstrom R.J, Bergman A, Safe S, Pieters R, van den Berg M. (1999). Cytotoxicity and aromatase (CYP19) activity modulation by organochlorines in human placental JEG-3 and JAR choriocarcinoma cells. *Toxicol. Appl. Pharmacol.* 160(1):10-20.
- Levin AA, Miller RK. (1980). Fetal toxicity of cadmium: maternal vs. fetal injections. *Teratology* 22:105-110.
- Levin AA, Miller RK. (1981). Fetal toxicity of cadmium in the rat: decreased utero-placental blood flow. *Toxicol. Appl. Pharmacol.* 58:297-306.
- Levin AA, Plautz JR, di Sant'Agnes PA, Miller RK. (1981). Cadmium: placental mechanisms of fetal toxicity. *Placenta* 3:303-318.
- Levin AA, Miller RK, di Sant'Agnes PA. (1983). Heavy metal alterations of placental function: a mechanism for the induction of fetal toxicity by cadmium. In: *Developmental and Reproductive Toxicity of Metals*, eds. Clarkson T, Nordberg G, pp. 663-654.
- Levin AA, Kilpper RW, Miller RK. (1987). The pharmacokinetics of a fetal toxic dose of cadmium chloride administered subcutaneously to the pregnant rat. *Teratology* 36:163-170.
- Lew JF, Fowler MG. (1998). Perinatal HIV-1 Transmission in the United States and Internationally—a review. *Trophoblast Res.* 12:85-101.
- Lewis DE, Minshall M, Wray NP, Paddock SW, Smith LC, Crane MM. (1990). Confocal microscopic detection of human immunodeficiency virus RNA-producing cells. *J. Infect. Dis.* 162(6):1373-1378.
- Lim HH, Ong CN, Domala Z, Phoon WO. (1983). Blood cadmium levels in Malaysian pregnant women. *Southeast Asian J. Trop. Med. Publ. Hlth.* 14(3):394-398.
- Lin FJ, Fitzpatrick JW, Iannotti CA, Martin DS, Mariani BD, Tuan RS. (1997). Effects of cadmium on trophoblast calcium transport. *Placenta* May;18(4):341-356.

- Little BB, van Beveren TT. (1996). Placental transfer of selected substances of abuse. *Semin. Perinatol.* Apr;20(2):147-153. Review.
- Lloyd JB. (1990). Cell Physiology of the rat visceral yolk sac: A study of pinocytosis and lysosome function. *Teratology* 41:383-393.
- Loebstein R, Lalkin A, Koren G. (1997). Pharmacokinetic changes during pregnancy and their clinical relevance. *Clin. Pharmacokinet.* Nov;33(5):328-43. Review.
- Loiacono NJ, Graziano JH, Kline JK, Popovac D, Shmedi X, Mehmeti A, Rajoivic B. (1992). Placental cadmium and birthweight in women living near a lead smelter. *Arch. Environ. Hlth.* 47:250-255.
- Longo LD, Bartels H (eds.). (1972). *Respiratory Gas Exchange and Blood Flow in the Placenta.* US DHEW Publication No. (NIH) 73-361.
- Longo LD, Delivoria-Papadopoulous M, Foster RE II. (1974). Placental CO₂ transfer after fetal carbonic anhydrase inhibition. *Am. J. Physiol.* 226(3):703-710.
- Longo LD, Yuen P, Gusseck DJ. (1973). Anaerobic, glycogen-dependent transport of amino acids by the placenta. *Nature* 243(5409):531-533.
- Longo LD, Yuen P, Gusseck DJ. (1973). Anaerobic, glycogen-dependent transport of amino acids by the placenta. *Nature* 243:531-533.
- Lugo G, Cassady G, Palmisano P. (1969). Acute maternal arsenic intoxication with neonatal death. *Am. J. Dis. Child* 117(3):328-330.
- Mahendran D, Byrne S, Donnai P, D'Souza SW, Glazier JD, Jones CJ, Sibley CP. (1994). Na⁺ transport, H⁺ concentration gradient dissipation, and system A amino acid transporter activity in purified microvillous plasma membrane isolated from first-trimester human placenta: comparison with the term microvillous membrane. *Am. J. Obstet. Gynecol.* Dec;171(6):1534-1540.
- Malek A, Sager R, Schneider H. (1998). Transport of proteins across the human placenta. *Am J Reprod Immunol.* 40(5):347-351.
- Malek A, Miller RK, Mattison DR, Ceckler T, Panigel M, di Sant' Agnese PA, Bryant R, Neth L. (1995). Continuous measurement of ATP by ³¹P NMR in term human dually perfused placenta in vitro: Response to ischemia. *J. Appl. Physiol.* 78:1778-1786.
- Malek A, Miller RK, Mattison DR, Kennedy S, Panigel M, di Sant' Agnese PA, Jessee L. (1996). Energy Charge Monitoring via Magnetic Resonance Spectroscopy ³¹P in the Perfused Human Placenta: Effects of Cadmium, Dinitrophenol and Iodoacetate. *Placenta* 17: 495-506.
- Manchester D, Jacoby E. (1984). Decreased monooxygenase activities associated with birth defects. *Teratology* 30:31-37.
- Manchester D, Gordon S, Golas E, Oakey A. (1987). Ah receptor in human placenta. *Cancer Res.* 47:4861-4868.
- Manchester D, Parker N, Bowman C. (1984). Maternal smoking increases xenobiotic metabolism in placenta but not umbilical vein endothelium. *Pediatr. Res.* 18:1071-1075.
- Marinova G, Osmankova D, Dermendzhieva LL, Khalzhikolev I, Chakurova O, Kaneva I. (1973). Pesticides and their effect on the reproductive function in women (preliminary report). *Akush Ginekol (Sofia)*. 12(2):138-40.
- Martin AW, Brady K, Smith SI, DeCoste D, Page DV, Malpica A, Wolf B, Neiman RS. (1992). Immunohistochemical localization of human immunodeficiency virus p24 antigen in placental tissue. *Hum. Pathol.* 23(4):411-414.

- Marsh DO, Clarkson TW, Cox C, Myers GJ, Amin-Zaki L, Al-Tikriti S. (1987). Fetal methylmercury poisoning. *Arch. Neurol.* 44:1017-1022.
- Mattern CF, Murray K, Jensen A, Farzadegan H, Pang J, Modlin JF. (1992). Localization of human immunodeficiency virus core antigen in term human placentas. *Pediatrics* 89(2):207-209.
- Mattison DR, Kay H, Miller RK, Angtuaco T. (1988). Magnetic resonance imaging: a noninvasive tool for fetal and placental physiology. *Biol. Reprod.* 38:39-49.
- Maulik D, Contractor SFJ, Lippes-Knight A. (1981). Extracorporeal perfusion of the whole human placenta--a new model. *Placenta Suppl.* 3:353-65.
- Maury W, Potts B.J, Rabson AB. (1989). HIV-1 infection of first-trimester and term human placental tissue: a possible mode of maternal-fetal transmission. *J. Infect. Dis.* 160(4):583-588.
- Mayer-Popken O, Denkhaus W, Konietzko H. (1986). Lead content of fetal tissues after maternal intoxication. *Arch. Toxicol.* 58:203.
- Maymon R, Jauniaux E, Greenwold N, Moroz C. (2000). Localization of p43 placental isoferritin in human maternal-fetal tissue interface. *Am. J. Obstet. Gynecol.* 182(3):670-674.
- Maymon R, Jauniaux E, Rodeck C, Zaspin L, Moroz C. (1998). Comparison of placental isoferritin levels in maternal serum and coelomic and amniotic fluids during first trimester human gestation. *Hum. Reprod.* 13(4):1044-1046.
- McCoshen J. (1987). Amnionic association with chorion and prostaglandin E₂ production before and after labor. *Trophoblast Research* 2:61-69.
- McGann KA, Collman R, Kalson DL, Gonzalez-Scarano F, Coukos G, Coutifaris C, Strauss JF, Nathanson N. (1994) Human immunodeficiency virus type 1 causes productive infection of macrophages in primary placental cell cultures. *J. Infect. Dis.* 169(4):746-753.
- McKay D, Wong T. (1962). Studies of the generalized schwartzman reaction produced by diet. *J Expt Med* 115:1117-1126.
- McLachlan JC. (1980). The effect of 6-aminonicotinamide on limb development. *J. Embryol. Exp. Morphol.* 55:307-318.
- McLachlan JA, Fabro SE. (1982). Altered postnatal development following intrauterine exposure to hormonally active chemicals. In: *Advances in Pharmacology and Therapeutics II*, Vol. 5, eds. Yoshida H, Hgihara Y, Ebashi S. New York: Pergamon Press, pp. 211-220.
- McLachlan JA, Korach KS, Newbold RR, Degen GH. (1984). Diethylstilbestrol and other estrogens in the environment. *Fundam. Appl. Toxicol.* 4(5):686-691.
- Melendez-Guerrero L, Holmes R, Backe E, Polliotti B, Ibegbu C, Lee F, Panigel M, Schwartz D, Huddleston J, Nahmias A. (1994). In vitro infection of Hofbauer cells with a monocyte-tropic strain of HIV-1. *Trophoblast Res.* 8:33-45.
- Metzler M, McLachlan JA. (1978). Oxidative metabolites of diethylstilbestrol in the fetal, neonatal and adult mouse. *Biochem Pharmacol.* Apr 1;27(7):1087-94.
- Mikhailova LM, Kobayets GP, Lyubomudrov VE, Braga GF. (1971). The influence of occupational factors on disease of the female reproductive organs. *Ped. Akush. Ginekol* 33 (6):56-58.
- Miller RK. (1983). Perinatal toxicology: its recognition and fundamentals. *Amer. J. Indust. Med.* 4:205-244.

- Miller RK. (1986). Placental transfer and function: The interface for drugs and chemicals in the conceptus, In: *Drug and Chemical Action in Pregnancy - Pharmacologic and Toxicologic Principles*, (eds.), S.E. Fabro A.R. Scialli, Marcel Dekker, New York, pp. 123-152.
- Miller RK, Ballinger D. (1993). Metals and reproduction, In: *Occupational and Environmental Reproductive Hazards: a Guide for Clinicians*, ed. Paul M, Williams and Wilkins, pp. 223-266.
- Miller RK, Berndt WO. (1975). Mechanisms of transport across the placenta: an in vitro approach. *Life Sciences* 16:7-30.
- Miller RK, Berndt, WO. (1973). Evidence of a Mg^{++} -dependent, $Na^{+} + K^{+}$ -Activated ATPase and a Ca^{++} ATPase in the human term placenta. *Proc. Soc. Expt. Biol. Med.* 143:118-122.
- Miller RK, Berndt, WO. (1974). Characterization of neutral amino acid accumulation by human term placenta slices. *Amer. J. Physiol.* 227:1236-1242.
- Miller RK, Kellogg CK. (1985). The pharmacodynamics of prenatal chemical exposure, In: *Prenatal Drug Exposure: Kinetics and Dynamics - NIDA Research Monograph*, eds. Chiang N, Less C, U.S. Government Printing Office, pp. 39-57.
- Miller RK, Myatt, L. eds. (n.d.). *Placenta Pathobiology: HIV, Oxidant Stress*, Harcourt Press, London, UK, in press.
- Miller RK, Shaikh Z. (1983). Perinatal metabolism: metals and metallothionein, In: *Developmental and Reproductive Toxicity of Metals*, eds. Clarkson T, Nordberg G. New York: Plenum Press, pp. 153-204.
- Miller RK, Thiede HA, eds. (1981). *Placenta: Receptors, Pathology and Toxicology*. London: W.B. Saunders.
- Miller RK, Thiede HA, eds. (1991). *Molecular Biology and Cell Regulation of the Placenta*. New York: VERAV Medical.
- Miller RK, Thiede HA, eds. (1994). *HIV, Perinatal Infections and Therapy: Role of the Placenta*. New York: Boydell and Brewer.
- Miller RK, Thiede HA, eds. (1987). *The Cellular Biology and Pharmacology of the Placenta: Techniques and Applications*. New York: Plenum Medical.
- Miller RK, Ferm VH, Mudge GH. (1972). Placental transfer and tissue distribution of iophenoxic acid in the hamster. *Amer. J. Obstet. Gynecol.* 114:259-266.
- Miller RK, Koszalka TR, Brent RL. (1976). Transport mechanisms for molecules across placental membranes. In: *Cell Surface Reviews - The Cell Surface in Animal Development, Volume 1*, eds. Poste G, Nicolson GL. pp. 145-223.
- Miller RK, Davis BM, Brent RL, Koszalka TR. (1977). Placental transport of creatine in the rat: directionality of transport and the role of the extraembryonic membranes. *Amer. J. Physiol.* 223:E308-E315.
- Miller RK, Reich KA, Fox HE, Koszalka TR. (1979). creatine transport and energy metabolism by the human placenta. *Rochester Trophoblast Conference* 7:80-83.
- Miller RK, Heckmann ME, McKenzie RC. (1982). Diethylstilbestrol: placental transfer, metabolism, covalent binding and fetal distribution in the Wistar Rat. *J. Pharmacol. Expt. Therap.* 220:358-365.
- Miller RK, Ng WW, Levin AA. (1983). The placenta: relevance to toxicology, In: *Developmental and Reproductive Toxicity of Metals*, eds. Clarkson T, Nordberg G. New York: Plenum Press, pp. 569-605.

- Miller RK, Mattison D, Filler R, Rice J. (1985). Reproductive and developmental toxicology, In: Drug Therapy During Pregnancy, eds. Eskes T, Finster M. England: Butterworth,, pp. 215-224.
- Miller RK, Mattison DR, Panigel M, Ceckler T, Bryant R. (1987). Kinetics assessment manganese using magnetic resonance imaging (MRI) in the dually perfused human placenta in vitro. *Environ. Hlth. Persp.* 74:81-91.
- Miller RK, Mattison, D.R.Plowchalk, D. (1988). Biological monitoring of the human placenta. In: Biological Monitoring of Toxic Metals, eds. Clarkson T, Friberg L, Nordberg G, Sager P. New York: Plenum Press, pp. 567-602.
- Miller RK, Wier PJ, Shah Y, di Sant'Agnes PA, Perez-D'Gregorio R. (1989). Criteria for in vitro dual perfusion in the human placental lobule: Perfusions in excess of 12 Hours, In: Placenta: Model and Source, eds. Genbacev O, Klopper A, Beaconsfield R, New York: Plenum Press, pp. 27-38.
- Miller RK, Malek A, Kennedy S, di Sant'Agnes PA, Mattison DR, Bryant R, Panigel M, Neth L. (1991). Cadmium toxicity: energy charge monitoring via magnetic resonance spectroscopy ³¹P in the perfused human placenta. *Placenta* 12:420-421.
- Miller RK, Faber W, Asai M, Wier PJ, di Sant'Agnes PA, Shah Y. (1992). Placental toxicity of cadmium and retinoids. *Tropho. Res.* 6:351-367.
- Miller RK, Perez-D'Gregorio R, Faber W, Asai M, Wier PJ, Shah Y. (1993a). The role of the human placenta in embryonic nutrition: impact of environmental and social factors. *Ann. New York Acad. Sci.* 678:92-107.
- Miller RK, Wier PJ, Perez-D'Gregorio R, Eisenmann C, di Sant'Agnes PA, Shah Y, Neth Jessee L. (1993b). Human dual placental perfusions - criteria for toxicity evaluations. *Methods in Toxicology* 3B:246-259.
- Miller RK, Hendrickx AG, Mills JL, Hummler H, Wiegand UW. (1998). Periconceptional vitamin A use: how much is teratogenic? *Reprod. Toxicol.* 12:75-88.
- Miller RK, Jessee L, Barrish A, Gilbert J, Manson J. (1998). Pharmacokinetic studies of enalaprilat in the in vitro perfused human placental lobule. *Teratology* 58:76-81.
- Miller RK, Polliotti B, Shiekh A, Ding Y, Reddy S, Lord K, Carneiro M, Gnall S, Laughlin T. (2000). The role of the placenta in the vertical transmission of HIV. *Teratology* 61:391-394.
- Milman N, Christensen JM, Ibsen KK. (1988). Blood lead and erythrocyte zinc protoporphyrin in mothers and newborn infants. *Eur. J. Pediatr.* 147:71.
- Minkoff H, Nanda D, Menez R, Fikrig S. (1987). Pregnancies resulting in infants with acquired immunodeficiency syndrome or AIDS-related complex: follow-up of mothers, children, and subsequently born siblings. *Obstet. Gynecol.* 69(3 Pt 1):288-291.
- Mirkes, PE, Little SA, Beland FA, Huitfeldt HS, Poirier MC. (1991). Quantitation and immunohistochemical localization of DNA adducts in rat embryos and associated yolk sac membranes exposed in vitro to N-acetoxy-2-acetylaminofluorene (N-Ac-AAF). *Terat. Carcin. Muta.* 11:93-102.
- Moberg Wing A, Wing K, Tholin K, Sjoestroem R, Sandstroem B, Hallmans G. (1992). The relation of the accumulation of cadmium in human placenta to the intake of high-fibre grains and maternal iron status. *Eur. J. Clin. Nutr.* 46:585-595.
- Mongan LC, Ockleford CD. (1996). Behaviour of two IgG subclasses in transport of immunoglobulin across the human placenta. *J. Anat.* 188 (Pt 1):43-51.

- Morgan DJ. (1997). Drug disposition in mother and foetus. *Clin. Exp. Pharmacol. Physiol.* 24(11):869-73.
- Morgenstern, R, Cotgreave, I.A.Engman, L. (1992). Determination of the relative contributions of the diselenide and selenol forms of ebselen in the mechanism of its glutathione peroxidase-like activity. *Chem. Biol. Interactions* 84:77.
- Morrish D, Miller RK, eds. (1998). *Genetic Regulation of Trophoblast Development and Immunology*, Boydell and Brewer.
- Muehleemann K, Miller RK, Metlay L, Menegus MA. (1992). Cytomegalovirus infection of the human placenta: An immunocytochemical study. *Human Pathol.* 23:1234-1237.
- Muehleemann K, Menegus MA, Miller RK. (1995). Cytomegalovirus in the perfused human term placenta in vitro *Placenta* 16: 367-373.
- Mushak P, Davis JM, Crocetti AF, Grant LD. (1989). Review - Prenatal and postnatal effects of low-level lead exposure: Integrated summary of a report to the U.S. Congress on childhood lead poisoning. *Environ. Res.* 50:11.
- Nahmias A, Abramowsky C, Dobronyi I, Ibegbu, C, Henderson S. (1998). Infection and immunity at the maternal-placental-fetal interface: focus on HIV-1 - A Review-. *Trophoblast Res.* 12:103-124.
- Nakajima M, Takahashi H, Sasaki M, Kobayashi Y, Ohno Y, Usami M. (1997). Effects on fetal growth of repeated blood collection for toxicokinetics from pregnant rats. *J Toxicol Sci* 22(5):455-459.
- Nau H. (1985). Clinical pharmacokinetics in pregnancy and perinatology. *Dev. Pharmacol. Ther.* 8:149-181.
- Nau H. (1995). Chemical structure - teratogenicity relationships, toxicokinetics and metabolism in risk assessment of retinoids. *Toxicol. Letts.* 82/83:975-979.
- Nau H, Elmazar MM, Ruhl R, Thiel R, Sass JO. (1996). All-trans-retinoyl-beta- glucuronide is a potent teratogen in the mouse because of extensive metabolism to all-trans-retinoic acid. *Teratology* 54(3):150-156.
- Naz RK, Ellaurie M. (1990). Reproductive immunology of human immunodeficiency virus (HIV-1) infection. *Am J Reprod Immunol.* 23(4):107-114.
- Needleman HL, ed. (1992). *Human Lead Exposure*. Boca Raton, Fla.: CRC Press.
- Newbold RR, Hanson RB, Jefferson WN, Bullock BC, Haseman J, McLachlan JA. (1998). Increased tumors but uncompromised fertility in the female descendants of mice exposed developmentally to diethylstilbestrol. *Carcinogenesis* 19(9):1655-1663.
- Ng WW, Miller RK. (1983). Transport of nutrients in the early human placenta: Amino acid, creatine, vitamin B₁₂. *Tropho. Res.* 1:123-132.
- Ng WW, Miller RK, Catus R. (1981). Macromolecule transfer in the human trophoblast: Transcobalamin II - Vitamin B₁₂. *Placenta* 3:145-169.
- Nogawa K, Kobayashi E, Honda R. (1979). A study of the relationship between cadmium concentrations in urine and renal effects of cadmium. *Environ. Hlth. Persp.* 28:161-168.
- Nordström S, Beckman L, Nordenson I. (1978). Occupational and environmental risks in and around a smelter in northern Sweden. III. Frequencies of spontaneous abortion. *Hereditas* 88:51.
- Nordström S, Beckman L, Nordenson I. (1979). Occupational and environmental risks in and around a smelter in Northern Sweden. VI. Congenital malformations. *Hereditas* 90:297.

- Nuovo GJ, Becker J, Burk MW, Margiotta M, Fuhrer J, Steigbigel RT. (1994). In situ detection of PCR-amplified HIV-1 nucleic acids in lymph nodes and peripheral blood in patients with asymptomatic HIV-1 infection and advanced-stage AIDS. *J. Acquir. Immune Defic. Syndr.* 7(9):916-923.
- O'Leary JA, Davies JE, Feldman M. (1970). Spontaneous abortion and human pesticide residues of DDT and DDE. *Am. J. Obstet. Gynecol.* 108(8):1291-1292.
- Odinecs A, Nosbisch C, Unadkat JD. (1996). Zidovudine does not affect transplacental transfer or systemic clearance of stavudine (2',3'-didehydro-3'-deoxythymidine) in the pigtailed macaque (*Macaca nemestrina*). *Antimicrob. Agents Chemother.* 40(6):1569-1571.
- Olivero OA, Parikka R, Poirier MC, Vahakangas K. (1999). 3'-azido-3'-deoxythymidine (AZT) transplacental perfusion kinetics and DNA incorporation in normal human placentas perfused with AZT. *Mutat. Res.* Jul 16;428(1-2):41-47.
- Ong CN, Phoon WO, Law HY, Tye CY, Lim HH. (1985). Concentrations of lead in maternal blood, cord blood, and breast milk. *Arch. Dis. Child.* 60(8):756-759.
- Osman K, Akesson A, Berglund M, Bremme K, Schutz A, Ask K, Vahter M. (2000). Toxic and essential elements in placentas of Swedish women. *Clin. Biochem.* 33(2):131-138.
- Paakki P, Kirkinen P, Helin H, Pelkonen O, Raunio H, Pasanen M. (2000). Antepartum glucocorticoid therapy suppresses human placental xenobiotic and steroid metabolizing enzymes. *Placenta* Mar-Apr;21(2-3):241-246.
- Paakki P, Stockmann H, Kantola M, Wagner P, Lauper U, Huch R, Elovaara E, Kirkinen P, Pasanen M. (2000). Maternal drug abuse and human term placental xenobiotic and steroid metabolizing enzymes in vitro. *Environ. Health Perspect.* Feb;108(2):141-145.
- Page K, Abramovich D, Aggett P, Bain M, Chipperfield A, Durdy H, McLachlan J, Smale A. (1992). Uptake of zinc by human placental microvillus border membranes and characterization of the effects of cadmium on this process. *Placenta* 13:151-162.
- Panigel M. (1962). Placental perfusion experiments. *Am. J. Obstet. Gynecol.* 84:1664-1683.
- Panigel M. (1981). Placental function: Toxicology and pathology. In *Placenta: Receptors, Pathology and Toxicology*, eds. Miller RK, Thiede HA. London: W.B. Saunders, pp. 275-288.
- Panigel M, Nahmias A. (1994). Methodological approaches for pathological and experimental studies of placental infections – a workshop report. *Trophoblast Res.* 8:263-282.
- Panigel M, Abramowicz JS, Miller RK. (1996). Techniques: Biophysical methods for assessment of placental function, In: *Placental Pharmacology*, ed. Sastry BVR, Boca Raton, Fla.: CRC Press, pp 1-22.
- Pantaleo G, Graziosi C, Fouci AS. (1993). New concepts in the immunopathogenesis of human immunodeficiency virus infection. *N. Engl. J. Med.* 4;328(5):327-335.
- Parizek J. (1964). Vascular changes at sites of estrogen biosynthesis produced by parenteral injection of cadmium salts. *J. Reprod. Fertil.* 7:263.
- Parizek J. (1965). The peculiar toxicity of cadmium during pregnancy: an experimental toxemia of pregnancy induced by cadmium salts. *J. Reprod. Fertil.* 9:111.
- Parry S, Koi H, Strauss JF. (1999). Transplacental drug delivery: gene and virus delivery to the trophoblast. *Adv. Drug Deliv. Rev.* 38(1):69-80.
- Pasanen M. (1999). The expression and regulation of drug metabolism in human placenta. *Adv. Drug Deliv. Rev.* Jun 14;38(1):81-97.

- Pastrakuljic A, Derewlany LO, Koren G. (1999). Maternal cocaine use and cigarette smoking in pregnancy in relation to amino acid transport and fetal growth. *Placenta* 20(7):499-512. Review.
- Pastrakuljic A, Derewlany LO, Knie B, Koren G. (2000). The effects of cocaine and nicotine on amino acid transport across the human placental cotyledon perfused in vitro. *J. Pharmacol. Exp. Ther.* 294(1):141-146.
- Patterson BK, Behbahani H, Kabat WJ, Sullivan J, O’Gorman MR, Landay A, Flener Z, Khan N, Yogey R, Andersson J. (2001). Leukemia inhibitory factor inhibits HIV-1 replication and is upregulated in placentae from nontransmitting women. *J. Clin. Invest.* 107(3):287-294.
- Patterson BK, Till M, Otto P, Goolsby C, Furtado MR, McBride LJ, Wolinsky SM. (1993). Detection of HIV-1 DNA and messenger RNA in individual cells by PCR-driven in situ hybridization and flow cytometry. *Science* 260(5110):976-979.
- Patterson TA, Binienda ZK, Lipe GW, Gillam MP, Slikker W Jr, Sandberg JA. (1997). Transplacental pharmacokinetics and fetal distribution of azidothymidine, its glucuronide, and phosphorylated metabolites in late-term rhesus macaques after maternal infusion. *Drug Metab. Dispos.* 25(4):453-459.
- Perera FP, Jedrychowski W, Rauh V, Whyatt, RM. (1999). Molecular epidemiologic research on the effects of environmental pollutants on the fetus. *Environ. Health Perspect.* Jun;107 Suppl 3:451-60. Review.
- Perez-D’Gregorio R, Miller RK. (1998). Transport and endogenous release of vitamin B₁₂ in the dually perfused human placenta. *J. Ped.* 132:S35-S42.
- Perez-D’Gregorio R, Miller RK. (1988). Teratogenicity of tellurium dioxide: prenatal assessment. *Teratology* 37:307-316.
- Perez-D’Gregorio R, Miller RK, Baggs RB. (1988). Maternal toxicity and teratogenicity of tellurium dioxide: Relationship to pair-feeding. *Reprod. Toxicol.* 2:55-61.
- Phillips DM, Ta X. (1992). HIV-1 infection of the trophoblast cell line BeWo: a study of virus uptake. *AIDS Res. Hum. Retroviruses* 8(9):1683-1691.
- Pinter E, Reece E, Leranath C, Sanyal M, Hobbins J, Mahoney M, Naftolin F. (1986). Yolk sac failure in embryopathy due to hyperglycemia. *Teratology* 33:73-84.
- Plessinger M, Miller RK. (1993). Effect of ddI and AZT upon growth and hormone production in human trophoblast cells (JAR). *FASEB J.* 7:A692.
- Plessinger MA, Miller RK. (1997). Human placental cells do not reduce AZT (Zidovudine) to 3'-Amino-3'-Deoxythymidine (AMT). *Proc. Soc. Expt. Biol. Med.* 215:243-247.
- Plessinger MA, Miller RK. (1999). Effect of zidovudine (AZT) and dideoxyinosine (ddI) upon proliferation and hormone production in human trophoblast cells. *Reprod. Toxicol.* 13: 537-546.
- Plessinger M, Genbacev O, Schubach S, Miller RK. (1992). Effect of anti virals (ddI and AZT) on human placental function. *Rochester Trophoblast Conference* 12: A69.
- Poirier MC, Patterson T, Slikker Jr W, Olivero O. (1999). Incorporation of 3'-azido-3' deoxythymidine (AZT) into fetal DNA and fetal tissue distribution of drug after infusion of pregnant late-term rhesus macaques with a human -equivalent AZT dose. *JAIDS* 22:477-483.
- Polliotti B, Panigel M, Miller RK. (1991). Inhibition of free and transcobalamin II bound vitamin B₁₂ in the rat visceral yolk sac. *Placenta* 12:428-429.

- Polliotti BM, Holmes R, Cornish JD, Hulsey M, Keesling S, Schwartz D, Abramowsky CR, Huddleston J, Panigel M, Nahmias AJ. (1996). Long-term dual perfusion of isolated human placental lobules with improved oxygenation for infectious diseases research. *Placenta* 17(1):57-68.
- Polliotti BM, Panigel M, Miller RK. (1997). Free Vitamin B12 and Transcobalamin II-vitamin B12 complex uptake by the rat visceral yolk sac: Effects of inhibitors. *Reprod. Toxicol.* 11:616-626.
- Polliotti BM, Sheikh A, Subbarao S, Keesling S, Lee GR, Caba J, Panigel M, Reichman R, Nahmias AJ, Miller RK. (1998). HIV-1 infection of human placental villous tissue in vitro. *Trophoblast Res.* 12:205-244.
- Popek EJ. (1998). HIV and the placenta. *Trophoblast Res.* 12:226-228.
- Powlin S, Keng P, Miller RK. (1997). Toxicity of cadmium in human trophoblast cells (JAR choriocarcinoma): Role of calmodulin and the calmodulin inhibitor, zaldaride maleate. *Tox. Appl. Pharm.* 144:225-234.
- Powlin S, Genbacev O, Miller RK. (1994). Cadmium inhibits trophoblast cell proliferation in first trimester human placental explants. *Toxicologist* 14:126.
- Qanungo S, Sen A, Mukherjea M. (1999). Antioxidant status and lipid peroxidation in human fetoplacental unit. *Clin. Chim. Acta.* Jul;285(1-2):1-12.
- Radulovic LL, LaFerla JJ, Kulkarni AP. (1986). Human placental glutathione S-Transferase-mediated metabolism of methyl parathion. *Biochem. Pharm.* 35:3473-3480.
- Ramsey E, Donner MW. (1988). Placental vasculature and circulation in primates, *Trophoblast Res.* 3:217-234.
- Record IR, Dreosti IE, Manuel SJ. (1982). Inhibition of rat yolk sac pinocytosis by cadmium and its reversal by zinc. *J. Nutr.* 112:1994-1998.
- Reddy CS, Whelan J, Scholz RW. (1988). Role of vitamin E and selenium in the arachidonic acid cascade. In: *Cellular Antioxidant Defense Mechanisms*, ed. Chow CK, Boca Raton, Fla.: CRC Press, p. 139.
- Reichrtova E, Ciznar P, Prachar V, Palkovicova L, Veningerova M. (1999). Cord serum immunoglobulin E related to the environmental contamination of human placentas with organochlorine compounds. *Environ. Health Perspect.* 107(11):895-899.
- Rice DC. (1992). Behavioral impairment produced by developmental lead exposure: Evidence from primate research. In: *Human Lead Exposure*, ed. Needleman NL, Boca Raton, Fla.: CRC Press, ch 8.
- Rice PA, Nesbitt REL, Cuenca VG, Zhang W, Gordon GB, Kim TJ. (1986). The effect of ethanol on the production of lactate, triglycerides, phospholipids, and free fatty acids in the perfused human placenta. *Amer. J. Obstet. Gynecol.* 155:207-212.
- Richter J, Hajek Z, Pfeifer I, Subrt P. (1997). Relationship of the concentration of metals and lysozyme in placentae of women with intrauterine foetal growth retardation. *Ces. Gynek.* 62:117-122.
- Roberts D. (1998). Placental pathology in HIV+ pregnancies. *Trophoblast Res.* 12:229.
- Robson JM, Sullivan FM. (1966). Analysis of actions of 5-hydroxytryptamine in pregnancy. *J. Physiol.* 184:717-732.
- Rogers JM, Daston GP, Ebron MT, Carver B, Stefanadis JG, Grabowski C. (1985). Studies on the mechanism of trypan blue teratogenicity in the rat developing in vivo and in vitro. *Teratology* 31:389-399.

- Romero RA, Granadillo VA, Navarro JA, Rodriguez-Iturbe B, Pappaterra J, Pirela H. (1990). Placental transfer of lead in mother/newborn pairs of Maracaibo City (Venezuela). *J. Trace Elem. Electrolytes Hlth. Dis.* 4(4):241-243.
- Rooth G, Jacobson L, Heinrich J, Seidenschur G. (1972). The acid-base status of the fetus during normal labor. Testing a model of maternal-fetal acid-base exchange on two different series of patients. In: *Respiratory Gas Exchange and Blood Flow in the Placenta*, eds. Longo L, Bartels H. DHEW Publication No. (NIH) 73-361, pp. 477-486.
- Rothman KJ, Moore LL, Singer MR, Nguyen UDT, Mannio S, Milunski A. (1995). Teratogenicity of high vitamin A intake. *New Engl. J. Med.* 333:1369-1373.
- Rowland AS, Baird DD, Weinberg CR, Shore DL, Shy CM, Wilcox AJ. (1994). The effect of occupational exposure to mercury vapour on the fertility of female dental assistants. *Occup. Environ. Med.* 51(1):28-34.
- Sahali D, Mulliez N, Chatelet F, Laurent-Winter C, Citadelle D, Roux C, Ronco P, Verroust P. (1992). Coexpression in humans by kidney and fetal envelopes of a 280 kDa-coated pit-restricted protein. Similarity with the murine target of teratogenic antibodies. *Am. J. Pathol.* 140:33-44.
- St. Pierre MV, Serrano MA, Macias RIR, Dubs U, Hoechli M, Lauper U, Meier PmJ, Marin JGG. (2000). Expression of members of the multidrug resistance protein family in human term placenta. *Am. J. Physiol. Reg. Integ. Comp. Physiol.* 279: R1495-R1503.
- Saillenfait AM, Payan JP, Langonne I, Gallissot F, Sabate JP, Beydon D, Fabry JP. (1999). Assessment of the developmental toxicity and placental transfer of 1,2- diethylbenzene in rats. *Food Chem. Toxicol.* Nov;37(11):1089-1096.
- Saltzman R, Miller RK. (1989). Cadmium exposure on day 12 of gestation in the wistar rat: distribution, uteroplacental blood flow, and fetal viability. *Teratology* 39:19-30.
- Samawickarama G, Webb M. (1979). The acute toxicity and teratogenicity of cadmium in the pregnant rat. *Environ. Hlth. Persp.* 28:345-349.
- Sasser LB, Kelman BJ, Levin AA, Miller RK. (1985). The influence of maternal cadmium exposure to fetal cadmium injection on hepatic metallothionein levels in the fetal rat. *Toxicol. Appl. Pharmacol.* 80:299-307.
- Sastry BV. (1999). Techniques to study human placental transport. *Adv. Drug Deliv. Rev.* 38(1):17-39.
- Sastry BVR, Owens LK. (1987). Regional and differential sensitivity of umbilico-placental vasculature to hydroxytryptamine, nicotine and ethyl alcohol. *Trophoblast Research* 2: 289-304.
- Sastry BVR, Olubadewo J, Boehm F. (1977). Effects of nicotine and cocaine on the release of acetylcholine from isolated human placental villi. *Arch. Intl. Pharm. Therap.* 229:23-36.
- Sastry BVR, Moor RD, Barnwell SL, Rowell PP. (1983). Factors affecting the uptake of Alpha-amino acids by human placental villus: Acetylcholine, Phospholipid Methylation, Ca, and cytoskeletal organization. *Trophoblast Res.* 1:81-100.
- Saxena MC, Siddiqui MKJ, Bharagava AK, Seth TD, Krishnamurti CR, Kutty D. (1980). Role of chlorinated hydrocarbon pesticides in abortions and premature labour. *Toxicology* 17:323-331.
- Saxena MC, Siddiqui MKJ, Agarwal V, Kutty D. (1983). A comparison of organochlorine insecticide content in specimens of maternal blood, placenta and umbilical cord blood from stillborn and live born cases. *J. Toxicol. Environ. Hlth.* 11:71-78.
- Schardein JL. (1985). *Chemically Induced Birth Defects*, Marcel Dekker, New York.

- Schenker S, Dicke J, Johnson R, Hays S, Henderson G. (1989). Effect of ethanol on placental transport of model amino acids and glucose. *Alcohol* 13:112-119.
- Scherer G, Richter E. (1997). Biomonitoring exposure to environmental tobacco smoke (ETS): a critical reappraisal. *Hum. Exp. Toxicol.* 16(8):449-459.
- Schramel P, Hasse S, Ovcara-Pavlu J. (1988). Selenium, cadmium, lead, and mercury concentrations in human breast milk, in placenta, maternal blood, and the blood of the newborn. *Biol. Trace Elem. Res.* 15:111.
- Schneider H, Dancis J. (1987). In vitro perfusion of human placenta. *Trophoblast Research* 2: 596-605.
- Schneider H, Panigel M, Dancis J. (1972). Transfer across the perfused human placenta of antipyrine, sodium and leucine. *Am. J. Obstet. Gynecol.* 114(6):822-828.
- Schramel P, Hasse S, Ovcara-Pavlu J. (1988). Selenium, cadmium, lead, and mercury concentrations in human breast milk, in placenta, maternal blood, and the blood of the newborn. *Biol Trace Elem Res.* 15:111-24.
- Seeds AE, Schrufer JJ, Reinhardt JA, Garlid KD. (1973). Diffusion mechanisms across human placental tissue. *Gynecol. Invest.* 4(1):31-37.
- Seidman R, Peress NS, Nuovo GJ. (1994). In situ detection of polymerase chain reaction-amplified HIV-1 nucleic acids in skeletal muscle in patients with myopathy. *Mod. Pathol.* 7(3):369-75.
- Serafini MT, Romeu A. (1991). Nickel interactions with glutathione and related enzyme in 11-day embryo and yolk sac in rat. *Bull. Environ. Contam. Tox.* 47:840-844.
- Shah YG, Miller RK. (1985). The pharmacokinetics of phenytoin in the perfused human placenta. *Pediatr. Pharm.* 5:165-179.
- Shannon C, Jauniaux E, Gulbis B, Thiry P, Sitham M, Bromley L. (1998). Placental transfer of fentanyl in early human pregnancy. *Hum. Reprod.* 13(8):2317-2320.
- Sharer LR, Saito Y, Epstein LG, Blumberg BM. (1994). Detection of HIV-1 DNA in pediatric AIDS brain tissue by two-step ISPCR. *Adv Neuroimmunol.* 4(3):283-5
- Shearman LP, McReynolds AM, Zhou FC, Meyer JS. (1998). Relationship between [¹²⁵I]RTI-55-labeled cocaine binding sites and the serotonin transporter in rat placenta. *Am. J. Physiol.* 275(6 Pt 1):C1621-C1629.
- Sheikh A, Polliotti B, Miller RK. (1998). In situ PCR discriminates between infected and uninfected human placental explants after in vitro exposure to HIV-1. *Trophoblast Research* 12:191-204.
- Sheikh A, Polliotti B, Miller RK. (2000a). HIV infection: in situ PCR localization in human placentae following in utero and in vitro infection. *Amer. J. Obstet. Gynecol.* 182: 207-213, 2000.
- Sheikh AU, Polliotti BM, Miller RK. (2000b). In situ PCR detection of HIV expression in the human placenta. *Methods Mol. Biol.* 137:75-86.
- Shinkawa Y. (1974). Mercury in raw umbilical cord: comparative study of mercury content in maternal blood, placenta, umbilical cord and umbilical cord blood. *Acta Obstet Gynaecol Jpn.* 21(3):185-91.
- Shiverick K, King A, Frank H-G, Whitley G St J, Cartwright JE, Schneider H. (2001). Cell culture models of human trophoblast II: trophoblast cell lines-a workshop report. *Trophoblast Res.* 15, in press.
- Siddiqui MKJ, Saxena MC. (1985). Placenta and milk as excretory routes of lipophilic pesticides in women. *Human Toxicol.* 4:249-254.

- Sideri M, Zannoni E, Challier JC. (1987). Transfer of horseradish peroxidase across the human placental cotyledon perfused in vitro. *Trophoblast Research* 2:573-584.
- Simmons RD, Kellogg CK, Miller RK. (1984). Prenatal diazepam exposure in rats: Long-lasting, receptor-mediated effects on hypothalamic norepinephrine-containing neurons. *Brain Res.* 293:73-83.
- Sikorski R, Paszkowski T, Milart P, Radomanski T Jr, Szkoda J. (1988a). Intrapartum levels of trace metals in maternal blood in relation to umbilical cord blood values: lead, iron, copper, zinc. *Int. J. Gynaecol. Obstet.* 26(2):213-221.
- Sikorski R, Radomanski T, Paszkowski T, Skoda J. (1988b). Smoking during pregnancy and the perinatal cadmium burden. *J. Perinat. Med.* 16(3):225-231.
- Simmons RD, Miller RK, Kellogg CK. (1983). Prenatal diazepam: Distribution and metabolism in perinatal rats. *Teratology* 28:181-188.
- Simone C, Byrne BM, Derewlany LO, Oskamp M, Koren G. (1997). The transfer of cocaethylene across the human term placental cotyledon perfused in vitro. *Reprod Toxicol.* Mar-Jun;11(2-3):215-219.
- Singh US, Saxena DK, Singh C, Murthy RC, Chandra SV. (1991). Lead-induced fetal nephrotoxicity in iron-deficient rats *Reprod. Toxicol.* 5:211.
- Sinjari T, Darnerud PO. (1998). Hydroxylated polychlorinated biphenyls: placental transfer and effects on thyroxine in the foetal mouse. *Xenobiotica* Jan;28(1):21-30.
- Slikker W, Miller RK. (1994). Placental metabolism and transfer - Role in developmental toxicology, In: *Developmental Toxicology*, 2nd edition, eds. Kimmel C, Buelke-Sam J, New York: Raven Press, pp. 245-283.
- Smelt VA, Mardon HJ, Sim E. (1998). Placental expression of arylamine - acetyltransferases: evidence for linkage disequilibrium between NAT1*10 and NAT2*4 alleles of the two human arylamine N-acetyltransferase loci NAT1 and NAT2. *Pharmacol. Toxicol.* Oct;83(4):149-157.
- Smelt VA, Mardon HJ, Redman CW, Sim E (1997). Acetylation of arylamines by the placenta. *Eur. J. Drug Metab. Pharmacokinet.* Oct-Dec;22(4):403-408.
- Smit JW, Huisman MT, van Tellingen O, Wiltshire HR, Schinkel AH. (1999). Absence or pharmacological blocking of placental P-glycoprotein profoundly increases fetal drug exposure. *J. Clin. Invest.* 104(10):1441-1447.
- Smook IW, Amiss TJ. (1997). Chlorobutanol: Maternal serum levels and placental transfer in the mouse. *Vet. Hum. Toxicol.* Oct;39(5):287-290.
- Snyder JE, Filipov NM, Parsons PJ, Lawrence DA. (2000). The efficiency of maternal transfer of lead and its influence on plasma IgE and splenic cellularity of mice. *Toxicol. Sci.* Sep;57(1):87-94.
- Song B, Gelboin H, Park S, Tsokos G, Friedman F. (1985). Monoclonal antibody-directed radioimmunoassay detects cytochrome P-450 in human placenta and lymphocytes. *Science* 228:490-492.
- Sonnawane BR, Nordberg M, Nordberg G, Lucier G. (1975). Placental transfer of cadmium in rats. *Environ. Hlth. Persp.* 28:248-255.
- Soong Y-K, Tseng R, Liu C, Lin P-W. (1991). Lead, cadmium, arsenic, and mercury levels in maternal and fetal cord blood. *J. Formosan Med. Assoc.* 90:59.
- Sowa B, Steibert E. (1985). Effect of oral cadmium administration to female rats during pregnancy on zinc, copper, and iron content in placenta, foetal liver, kidney, intestine, and brain. *Arch. Toxicol.* 56(4):256-262.

- Stadtman TC. (1990). Selenium biochemistry. *Ann. Rev. Biochem.* 59:111.
- Steventon GB, Williams KE. (1987). Ethanol-induced inhibition of pinocytosis and proteolysis in rat yolk sac in vitro. *Development* 99:247-253.
- Stulc J. (1988). Is there control of solute transport at placental level? *Placenta*. 9(1):19-26.
- Stulc J, Stulcova B, Svihovec J. (1990). Transport of calcium across the dually perfused placenta of the rat. *J. Physiol.* 420:295-311.
- Sunde RA. (1990). Molecular biology of selenoproteins. *Ann. Rev. Nutr.* 10:451.
- Sutton C, McIvor RS, Vagt M, Doggett B, Kapur RP. (1998). Methotrexate-resistant form of dihydrofolate reductase protects transgenic murine embryos from teratogenic effects of methotrexate. *Pediatr. Dev. Pathol.* Nov-Dec;1(6):503-512.
- Swanson CA, Reamer DC, Beillon C, King JC, Levander OS. (1983). Quantitative and qualitative aspects of selenium utilization in pregnant and nonpregnant women: An application of stable isotope methodology. *Am. J. Clin. Nutr.* 38:169.
- Tabacova S, Balabaeva L, Petrov I. (1992). Arsenic and lipid peroxidation in the placenta: relation to environmental exposure and neonatal pathology. 12th Rochester Trophoblast Conference Program and Abstract Book, A.61.
- Takayama M, Hata T, Taki I, Miller RK eds. (1999). *The Placenta from Implantation to Trophoblastic Disease: Apoptosis, Proliferation, Invasion, and Pathology*. New York: University of Rochester Press,
- Terlouw GD, Bechter R. (1992). Comparison of the metabolic activity of yolk sac tissue in the whole embryo and isolated yolk sac culture. *Reprod. Toxicol.* 6:85-92.
- Topinka J, Binkova B, Mrackova G, Stavkova Z, Benes I, Dejmek J, Lenicek J, Sram RJ. (1997). DNA adducts in human placenta as related to air pollution and to GSTM1 genotype. *Mutat. Res.* Apr 24;390(1-2):59-68.
- Torreblanca A, Del Ramo J, Bibudhendra S. (1992). Cadmium effect on zinc metabolism in human trophoblast cells: Involvement of cadmium-induced metallothionein. *Toxicology* 72:167-174.
- Troster EJ, Schwartsman S. (1988). Lead exposure in pregnant women and their newborns in the city of São Paulo, Brazil.. *Biomed. Environ. Sci.* 1:64.
- Truska P, Rosival L, Balazova G, Hinst J, Rippel A, Palusova O, Grunt J. (1989). Blood and placental concentrations of cadmium, lead, and mercury in mothers and their newborns. *J. Hyg. Epidemiol. Microbiol. Immunol.* 33(2):141-147.
- Tsuchiya H, Mitani K, Kodama K, Nakata T. (1984). Placental transfer of heavy metals in normal pregnant Japanese women. *Arch. Environ. Hlth.* 39(1):11-17.
- Tsuda H, Asamoto M, Iwahori Y, Hori T, Ota T, Baba-Toriyama H, Uehara N, Schilter B, Perrin I, Cavin C, Huggett AC. (1996). Placental glutathione S-transferase (GST-P) induction as a potential mechanism for the anti-carcinogenic effect of the coffee-specific components cafestol and kahweol. *Carcinogenesis* Nov;17(11):2377-2384.
- Tuntland T, Nosbisch C, Baughman WL, Massarella J, Unadkat JD. (1996). Mechanism and rate of placental transfer of zalcitabine (2',3'-dideoxycytidine) in *Macaca nemestrina*. *Am. J. Obstet. Gynecol.* Mar;174(3):856-863.
- Tuntland T, Odinecs A, Nosbisch C, Unadkat JD. (1998). In vivo maternal-fetal-amniotic fluid pharmacokinetics of zidovudine in the pigtailed macaque: comparison of steady-state and single-dose regimens. *J. Pharmacol. Exp. Ther.* Apr;285(1):54-62.

- Tuntland T, Odinecs A, Pereira CM, Nosbisch C, Unadkat JD. (1999). In vitro models to predict the in vivo mechanism, rate, and extent of placental transfer of dideoxynucleoside drugs against human immunodeficiency virus. *Am. J. Obstet. Gynecol.* Jan;180(1 Pt 1):198-206.
- Tzimas G, Collins MD, Nau H. (1995). Developmental stage-associated differences in the transplacental distribution of 13-cis- and all-trans-retinoic acid as well as their glucuronides in rats and mice. *Tox. Appl. Pharm.* 133:91-101.
- Tzimas G, Nau H, Hendrickx AG, Peterson PE, Hummler H. (1996). Retinoid metabolism and transplacental pharmacokinetics in the cynomolgus monkey following a nonteratogenic dosing regimen with all-trans-retinoic acid. *Teratology*, Nov;54(5):255-265.
- Urbach J, Boadi W, Brandes JM, Kerner H, Yannai S. (1992). Effect of inorganic mercury on in vitro placental nutrient transfer and oxygen consumption. *Reprod. Toxicol.* 6:69-75
- Valdes G, Marinovic D, Falcon C, Chuaqui R, Duarte I. (1992). Placental alterations, intrauterine growth retardation and teratogenicity associated with enalapril use in pregnant rats. *Biol. Neonate* 61:124-130.
- Valente P, Main EK. (1990). Role of the placenta in perinatal transmission of HIV. *Obstet. Gynecol. Clin. North Am.* 17(3):607-616.
- Van der Aa EM, Peereboom-Stegeman JH, Noordhoek J, Gribnau FW, Russel FG. (1998). Mechanisms of drug transfer across the human placenta. *Pharm. World Sci.* Aug; 20(4):139-148. Review.
- van Kreel B, van Dijk JP, Pijnenburg AMCM. (1987). Nucleotide interconversion and breakdown in the dually perfused guinea pig placenta. *Trophoblast Research* 2: 481-499.
- Vimy M. (1990). Maternal-fetal distribution of mercury (203-Hg) released from dental amalgam fillings. *Am. J. Physiol.* 258:R939-945.
- Waalkes M, Poisner A, Wood G, Klaassen K. (1984). Metallothionein-like proteins in human placenta and fetal membranes. *Toxicol. Appl. Pharm.* 74, 179.
- Wade J, Agrawal P, Poisner A. (1986). Induction of metallothionein in a human trophoblast cell line by cadmium and zinc. *Life Sci.* 39:1361.
- Wallenburg HC, Zijlstra FJ, Vincent JE. (1981). Conversion in vitro of prostaglandin endoperoxide into prostaglandins by arteries from pregnant and non-pregnant human uteri. *J. Dev. Physiol.* 3(1):15-20
- Walsh SW, Behr MJ, Allen NH. (1985). Placental prostacyclin production in normal and toxemic pregnancies. *Am. J. Obstet. Gynecol.* 151:110.
- Walsh SW, Romney AD, Wang Y, Walsh MD. (1998). Magnesium sulfate attenuates peroxide-induced vasoconstriction in the human placenta. *Am. J. Obstet. Gynecol.* 178(1 Pt 1):7-12.
- Walsh SW, Wang Y, Killian A. (1999). AA-2414, an antioxidant and thromboxane receptor blocker, completely inhibits peroxide-induced vasoconstriction in the human placenta. *J. Pharmacol. Exp. Ther.* 290(1):220-226.
- Wannag A, Skjaerasen J. (1975). Mercury accumulation in placenta and foetal membranes. A study of dental workers and their babies. *Environ. Physiol. Biochem.* 5(5):348-352.
- Ward S, Jauniaux E, Shannon C, Rodeck C, Boyd R, Sibley C. (1998). Electrical potential difference between exocoelomic fluid and maternal blood in early pregnancy. *Am. J. Physiol.* 274(5 Pt 2):R1492-1495.
- Wassermann M, Ron M, Bercovici B, Wassermann D, Cucos C, Pines A. (1982). Premature delivery and organochlorine compounds. *Environ. Res.* 28:106-112.

- Watanabe C, Yoshida K, Kasanuma Y, Kun Y, Satoh H. (1999). In utero methylmercury exposure differentially affects the activities of selenoenzymes in the fetal mouse brain. *Environ Res.* 80(3):208-214.
- Watson AL, Skepper JN, Jauniaux E, Burton GJ. (1998). Changes in concentration, localization and activity of catalase within the human placenta during early gestation. *Placenta* 19(1):27-34.
- Webb M. (1983). Endogenous metal binding proteins in the control of Zn, Cu, Cd, and Hg metabolism during prenatal and post-natal development. In: *Reproductive and Developmental Toxicity of Metals*, eds. Clarkson T, Nordberg G, Sager P. New York: Plenum Press, pp. 655-674.
- Webb M, Samarawickrama GP. (1981). Placental transport and embryonic utilization of essential metabolites in the rat at the teratogenic dose of cadmium. *J. Appl. Toxicol.* 1(5):270-277.
- Webster WS. (1988). Chronic cadmium exposure during pregnancy in the mouse: influence of exposure levels on fetal and maternal uptake. *J. Toxicol. Environ. Hlth.* 24: 183-192.
- Welch R, Harrison B, Gommi B, Poppers P, Finster M, Conney A. (1969). Stimulatory effect on cigarette smoking and the hydroxylation of benzo(a)pyrene by enzymes in the human placenta. *Clin. Pharm. Therap.* 10:100-110.
- Whipple G. (1912). Pregnancy and chloroform anesthesia. *J. Expt. Med.* 13:246-259.
- White TEK, Baggs RB, Miller RK. (1990). Central nervous system lesions in the wistar rat fetus following direct fetal injections of cadmium. *Teratology* 42:7-15.
- White T, Saltzman R, di Sant'Agnes PA, Kung P, Sutherland R, Miller RK. (1988). Human choriocarcinoma (JAR) in three dimensional culture. *Placenta* 9: 583-598.
- Wier P, Miller RK. (1989). In vitro evaluations of human placental functions and toxic responses, In: *In Vitro Methods In Developmental Toxicology*, eds. Kimmel G, Kochhar D, Boca Raton, Fla.: CRC Press, pp. 1-28.
- Wier PJ, Miller RK. (1985). Oxygen transfer as an indicator of perfusion variability in the isolated human placental lobule. *Contrib. Gynecol. Obstet.* 13:127-131.
- Wier PJ, Miller RK. (1987). The pharmacokinetics of cadmium in the dually perfused human placenta. *Tropho. Res.* 2:357-366.
- Wier PJ, Miller RK, Maulik D. (1983). Bidirectional transfer of alpha-amino-isobutyric acid by the perfused human placental lobule. *Tropho. Res.* 1:37-54.
- Wier PJ, Miller RK, Maulik D, di Sant'Agnes PA. (1990). Cadmium toxicity in the perfused human placenta. *Toxicol. Appl. Pharm.* 105:156-171.
- Wild AE. (1981). Endocytic mechanisms in protein transfer across the placenta. *Placenta (Suppl. 1)*:165-185.
- Williams KE, Kidston EM, Beck F, Lloyd JB. (1975). Quantitative studies of pinocytosis. I. Kinetics of uptake of (125I) polyvinylpyrrolidone by rat yolk sac cultured in vitro. *J. Cell. Biol.* 64(1):112-122.
- Willhite CC, Ferm VH, Zeise L. (1990). Route-dependent pharmacokinetics, distribution, and placental permeability of organic and inorganic selenium in hamsters. *Teratology* 42:359.
- Willhite CC, Lovey A, Eckhoff C. (2000). Distribution, teratogenicity, and embryonic delivered dose of retinoid Ro 23-9223. *Toxicol. Appl. Pharmacol.* 15;164(2):171-175.
- Willis DM, O'Grady JP, Faber JJ, Thornburg KL. (1986). Diffusion permeability of cyanocobalamin in human placenta. *Am. J. Physiol.* 250(3 Pt 2):R459-64.

- Wilson JM, Beaudoin AR, Free HJ. (1959). Studies on the mechanism of teratogenic action of trypan blue. *Anat. Rec.* 133:115-128.
- Wilson DC, Tubman R, Bell N, Halliday HL, McMaster D. (1991). Plasma manganese, selenium and glutathione peroxidase levels in the mother and newborn infant. *Early Hum. Develop.* 26:223.
- Winn LM, Wells PG. (1997). Evidence for embryonic prostaglandin H synthase-catalyzed bioactivation and reactive oxygen species-mediated oxidation of cellular macromolecules in phenytoin and benzo[a]pyrene teratogenesis. *Free Radic. Biol. Med.* 22(4):607-621.
- Wittmaack FM, Gafvels ME, Bronner M, Matsuo H, McCrae KR, Tomaszewski JE, Robinson SL, Strickland DK, Strauss JF III. (1995). Localization and regulation of the human very low density lipoprotein/apolipoprotein-E receptor: Trophoblast expression predicts a role for the receptor in placental lipid transport. *Endocrinology* 136(1):340-348.
- Wolkowski-Tyl R, Preston SF. (1979). The interaction of cadmium-binding proteins (Cd-bp) and progesterone in cadmium-induced tissue and embryo toxicity. *Teratology* 20(3):341-52.
- Woods JR. (1998). Maternal and transplacental effects of cocaine. *Ann. NY Acad. Sci.* Jun 21;846:1-11. Review.
- Woods JR Jr. (2001). Reactive oxygen species and preterm premature rupture of membranes-a review. *Trophoblast Res.* 15, in press.
- World Health Organization (WHO). (1977). Environmental Health Criteria 3, Lead, World Health Organization, Geneva.
- Yan L, Spallholz JE. (1993). Generation of reactive oxygen species from the reaction of selenium compounds with thiols and mammary tumor cells. *Biochem. Pharmacol.* 45:429.
- World Health Organization (WHO). (1981). Environmental Health Criteria 18, Arsenic, World Health Organization, Geneva.
- World Health Organization (WHO). (1987). Environmental Health Criteria 58: Selenium, World Health Organization, Finland.
- World Health Organization (WHO). (1990). Methylmercury, Environmental Health Criteria 101, World Health Organization, Geneva, Switzerland.
- Yan L, Spallholz JE. (1993). Generation of reactive oxygen species from the reaction of selenium compounds with thiols and mammary tumor cells. *Biochem. Pharmacol.* 45(2):429-437.
- Yan B, Matoney L, Yang D. (1999). Human carboxylesterases in term placentae enzymatic characterization, molecular cloning and evidence for the existence of multiple forms. *Placenta* Sep;20(7):599-607.
- Yang G, Wang S, Zhou R, Sun S. (1983). Endemic selenium intoxication of humans in China. *Am. J. Clin. Nutr.* 37:872-881.
- Yang J, Jiang Z, Wang Y, Qureshi IA, Wu XD. (1997). Maternal-fetal transfer of metallic mercury via the placenta and milk. *Ann. Clin. Lab. Sci.* Mar-Apr;27(2):135-141.
- Yonemoto S, Satoh H, Himeno S, Suzuki T. (1983). Toxic effects of sodium selenite on pregnant mice and modification of the effects by vitamin E or reduced glutathione. *Teratology* 28:333.
- You L, Gazi E, Archibeque-Engle S, Casanova M, Conolly RB, Heck HA. (1999). Transplacental and lactational transfer of p,p'-DDE in Sprague-Dawley rats. *Toxicol. Appl. Pharmacol.* Jun 1;157(2):134-144.

- Young M, Boyd RDH, Longo LD, Telegdy G. (eds.). (1981). *Placental Transfer Methods and Interpretations*. W. B. Saunders.
- Zachar V, Thomas RA, Jones T, Goustin AS. (1994). Vertical transmission of HIV: detection of proviral DNA in placental trophoblast. *AIDS* 8(1):129-130.
- Zachara BA, Wardak C, Didkowski W, Maciag A, Marchaluk E. (1993). Changes in blood selenium and glutathione concentrations and glutathione peroxidase activity in human pregnancy. *Gynecol. Obstet. Invest.* 35:12.
- Zetterlund B, Winberg J, Lundgren G, Johansson G. (1977). Lead in umbilical cord blood correlated with the blood lead of the mother in areas with low, medium or high atmospheric pollution. *Acta Paediatr Scand.* 66(2):169-175.
- Zevallos EA, Anderson VM, Bard E, Gu J (1994). Detection of HIV-1 sequences in placentas of HIV-infected mothers by in situ PCR. *Cell Vision* 1:116-121.
- Zadorozhnaja TD, Little RE, Miller RK, Mendel NA, Taylor RJ, Presley BJ, Gladen BC. (2000). Concentrations of arsenic, cadmium, copper, lead, mercury, and zinc in human placentas from two cities in Ukraine. *J. Toxicol. Environ. Hlth. A.* 61(4):255-63.
- Zusman I, Yaffe P, Ornoy A. (1987). The effects of high-sucrose diets and of maternal diabetes on the ultrastructure of the visceral yolk sac endoderm in rat embryos developing in vivo and in vitro. *Acta Anat. (Basel)* 128(1):11-18.

There are no Figures associated with this chapter.

Table 3-1. Concentrations of Endogenous Proteins and Other Molecules Produced by Mother, Placenta, Yolk Sac, or Embryo, or Available from Mother in Embryonic Fluids and Maternal Serum*

Molecules	Maternal Serum	Coelomic Fluid	Amniotic Fluid
Mother			
Total protein (g/L) ^a	71.3	3.5	0.2
Creatinine (μmol/L) ^a	50.1	43.6	27.7
Urea (mmol/L) ^a	7.2	8.3	7.2
Albumin (g/L) ^b	45.5	1.7	ND
Pre-albumin (g/L) ^b	1.14	0.04	ND
Tyroxine (nmol/L) ^c	180	0.9	0.02
Relaxin (ng/L) ^d	1000	122	9
Immunoglobulin G (mg/dL) ^e	907	32	3
Immunoglobulin A (mg/dL) ^e	122	1	ND
Complement factors 3 (mg/dL) ^e	114	ND	ND
Complement factors 4 (mg/dL) ^e	21	ND	ND
Iron (μmol/L) ^f	21	4.8	1.8
Glucose (mmol/L) ^g	3.4	2.7	2.8
IGF-I (μg/L) ^h	233	41	38
Villus tissue			
Intact HCG (mIU/mL) ⁱ	80193	105605	1057
Free α-HCG (mIU/mL) ⁱ	70	11200	169
Free β-HCG (mIU/mL) ⁱ	45	1478	20
hPL (ng/mL) ^j	210	80	30
Progesterone (pg/mL) ^k	17	240	8
Oestradiol (pg/mL) ^k	917	8469	1896
Activin A (ng/mL) ^l	0.68	0.98	0.09
Inhibin B (pg/mL) ^l	5.9	24.3	6.3
β ₂ -microglobulin (mg/L) ^m	0.9	4.7	ND
Lactate (mmol/L) ^g	0.3	0.6	0.9
IGF-II (μg/L) ^h	687	199	40
Decidua			
Vitamin B12 (ng/L) ⁿ	405	3680	987
Prolactin (mIU/L) ^o	709	371	40
Placental protein 14 (μg/L) ^j	642	4416	77
Interleukin-6 (ng/mL) ^p	40	88	17
IGFBP-1 (μg/L) ^h	76	150	16
IGFBP-2 (μg/L) ^h	123	167	49

Table 3-1. Concentrations of Endogenous Proteins and Other Molecules Produced by Mother, Placenta Yolk Sac, or Embryo, or Available from Mother in Embryonic Fluids and Maternal Serum* (continued)

Molecules	Maternal Serum	Coelomic Fluid	Amniotic Fluid
Secondary yolk sac			
AFP (kIU/L) ^k	1.4	21816	27096
Erythropoietin (mIU/mL) ^q	15.4	15.5	5.0
Embryo/fetus			
t-glutamyltransferase (IU/L) ^m	9	2	25
Ferritin (µg/L) ^f	49	287	2.0
Cancer antigen 125 (IU/mL) ^r	35	35	496

Source: Jauniaux and Gelbis 2000

*According to main site of production or origin during the first trimester of human pregnancy.

^aMean value (Jauniaux et al. 1991); ^bmean value (Jauniaux et al. 1994b); ^cmean value (Contempre et al. 1993); ^dmedian value (Johnson et al. 1994); ^emedian value (Jauniaux et al. 1995a); ^fmedian value (Gulbis et al. 1994); ^gmean value (Jauniaux et al. 1994a); ^hmean value (Miell et al. 1997); ⁱmean value (Jauniaux et al. 1995b); ^jmedian value (Wathen et al. 1992); ^kmean value (Jauniaux et al. 1993); ^lmedian value (Luisi et al. 1996); ^mmedian value (Gulbis et al. 1995); ⁿmedian value (Campbell et al. 1992a); ^omedian value (Wathen et al. 1993); ^pmedian value (Jauniaux et al. 1996a); ^qmedian value (Campbell et al. 1992b); ^rmedian value (Campbell et al. 1992c).

ND = not detectable; IGF = insulin-like growth factors; IGFBP = insulin-like growth factor binding proteins; HCG = human chorionic gonadotrophin; AFP = α -fetoprotein.

Table 3-2. Mean Concentration of Selected Drugs and Environmental Agents in Maternal Serum and Embryonic Fluids*

Drugs	Reference	Maternal Serum	Coelomic Fluid	Amniotic Fluid
Diazepam (ng/mL)	Jauniaux et al. 1996b	189.0	6.9	7.4
Fentanyl (ng/mL)	Shannon et al. 1998	1.3	ND	1.1
Propofol (µg/mL)	Jauniaux et al. 1998b	1.96	ND	ND
Inulin (mg/mL)	Jauniaux et al. 1997b	6.9	5.1	3.0
Cotinine (ng/mL)	Jauniaux et al. 1999b	72.0	99.0	108.0

Source: Jauniaux and Gelbis 2000

* Concentrations 5 to 25 minutes after a single IV bolus (Diazepam 0.1 mg/kg, Fentanyl 1.5 µg/kg, Propofol 3 mg/kg, Inulin 5 mg/kg or after chronic intake of cotinine (smoking))

Table 3-3. Xenobiotic and Hormone-Metabolizing Enzymes and Isoenzymes in the Human Placenta

Phase	Type	Reaction (gene)	Substrate	Constitutive	Inducer	Inhibitor
I	MFO	O-deethylase (CYP1A1)	7-Ethoxycoumarin	(+)	Cigarette Smoking	Amniogluthetimide
I	MFO	Arylhydrocarbon Hydroxylase (CYP1A1)	PAH	(+)	Cigarette Smoking	a- Naphthoflavone
I	MFO	? (CYP1B1)	?	(+)	-	-
I	MFO	Aromatase (CYP19)	Androgens	(+)	-	Amniogluthetimide
I	MFO	Cholesterol Side Chain Cleavage (CYP11A1)	Cholesterol	(+)	-	Amniogluthetimide
I	MFO	Estrogen Catechol Formation, 2 Hydroxylation and/or 4-hydroxylation	Estrogens	(+)	Cigarette Smoking	-
I	MFO	25-hydroxycholecalciferol hydroxylase	25-hydroxy-cholecalciferol	(+)	-	-
I	Oxido-reductase	17b-Hydroxydehydrogenase	Estradiol/estrone	(+)	-	16-Methylene estradiol
I	Oxido-reductase	17b-Hydroxydehydrogenase	Cortisol/cortisone	(+)	-	-
I	Oxidation	Dehydrogenase	Alchol/acetaldehyde	(+)	-	-
I	Oxidation	Monoamine	Norepinephrine	(+)	-	MAO inhibitors
II	Sulfatase	Sulfate Cleavage	Steroid Sulfates	(+)	-	-
II	Conjugation	Gluathione-S-transferase	Epoxides	(+)	-	-
II	Conjugation	Catechol-O-methyl-transferase	Catecholamines, catechol estrogens	(+)	-	-

Sources: Modified from Slikker and Miller, 1994 using Boden et al. 1995; Hakkola et al. 1996, 1997, 1998; Paakki et al. 2000; Rasheed et al. 1997; Zhang et al. 2000.

Table 3-4. Placental Transporters Involved in the Transfer of Nutrients and Xenobiotics

Transporter	Abbreviation	Location	Ion Dependent	Non-Nutrients Transported
Amino Acid		Brush Border	Na ⁺	Arginine Analogs (inhibitors of Nitric acid Synthesis) Methyl Mercury gagapentin (anti epileptic) Thyroid hormone mimics
Carnitine	OCTN2	Brush Border	Na ⁺	acetylcarnitine tetraethylammonium verapamil imipramine quinidine amphetamines cephaloridine glibenclamide
Dicarboxylate	NaDC3	Brush Border	Na ⁺	Trans-pyrrolidine-2,4,-dicarboxylate
Equilibrative Nucleoside	ENT1; ENT2	Brush Border Basal		dideoxyinosine gemcitabrine dideoxycytidine fludarabrine cladribine dilazep cytarabine dipyridamole
Extraneuronal monoamine	OCT3	Basal		amphetamines 1-methyl-4-phenylpyridinium tetraethylammonium clonidine cimitedine amiloride
Folate	FOLT1	Brush Border Basal		methotrexate
Monocarboxylates	MCT1 MCT3 MCT4 MCT5 MCT7	Brush Border Basal	H ⁺	benzoic acid acetic acid acetylsalicylic acid cefdinir
Norepinephrine	NET	Brush Border	Na ⁺ ; Cl ⁻	amphetamines cocaine, tricyclic antidepressants bind not transferred
Organic Cation	OCTN1	Unknown		tetraethylammonium quinidine verapamil
Organic Cation Antiporters		Brush Border		benzamil cimitedine clonidine
Prostaglandin	PGT	Unknown		prostaglandin E1 and E2 furosemide thromboxanes
P-glycoprotein	MDR1	Brush Border		digoxin
Efflux transporter	MRP1,2,3			saquinavir progesterone blocks taxol efflux vincristine glutathione morphine Glucuronides
Serotonin	SERT	Brush Border	Na ⁺ ; Cl ⁻	amphetamines cocaine, tricyclic antidepressants bind not transferred
Sodium/Multivitamin	SMVT	Brush Border	Na ⁺	cafamazepine primidone

References: Ganapathy et al. 2000, Ilesley 2000, Fukasawa et al, 2000, St-Pierre et al. 2000, Hahn et al. 2000, Kudo and Boyd 2001, Jansson, 2001.

Table 3-5. Criteria for Dual Perfusion of the Human Placenta

During Perfusion:

- Perfusion Pressure (fetal vein and artery)
- Flow Rate
- Fetal Volume Loss (<2 mL/hr)
- pH, pCO₂, pO₂, [HCO₃]
- Oxygen Consumption
- Net Fetal Oxygen Transfer
- Energy Charge

Post Perfusion:

- Glucose Utilization
- Lactate Production
- Protein Synthesis
- Hormone Production/Directional Release
- Tissue Content
- Tissue Slice Incubation (AIB)
- Enzyme Release (LDH)
- Morphology

Transport Studies:

- Net Oxygen Transfer
- Water or antipyrine
- Inulin

Source: Adapted from Miller et al. 1989

Table 3-6. Maternal Blood, Placenta, and Cord Blood Concentrations of Cadmium from Different Regions of the World and Under Selected Urban, Industrial, and Environmental Conditions

Location	Population	Maternal Blood (nmol/mL)	Placenta (nmol/g)	Cord Blood (nmol/mL)	Comment	Reference
I. Itai-Itai Disease						
Japan	Itai-Itai Patients Not Pregnant (n = 9)	Range 0.095 - 0.415	Range for Kidney 50 - 1832 Range for Liver 58 - 2678		Patients from polluted areas; Patients with significant renal impairment	Nogawa and Kido (1996)
II. Pregnancy Exposures						
A. Americas						
Augusta, GA Birmingham, AL Charlotte, NC	(n = 19) (n = 22) (n = 17)		0.47 ± 0.16 0.27 ± 0.21 0.25 ± 0.15		Placentae rinsed free of blood with 0.25 M sucrose	Karp and Robertson (1977)
Cleveland, OH	Nonsmokers (n = 31) Smokers (n = 41)	0.020 ± 0.0071 0.031 ± 0.0015	0.12 ± 0.057 0.16 ± 0.065	0.017 ± 0.0053 0.02 ± 0.008	More “small-for-date” infants born to smokers	Kuhnert et al. (1982)
Cleveland, OH	Nonsmokers (n = 84) Smokers (n = 65)	0.0089 ± 0.0027 0.013 ± 0.008	0.072 ± 0.44 0.107 ± 0.067		Placentae perfused with 2L saline before analysis	Kuhnert et al. (1988)
Cleveland, OH	Nonsmokers (n = 17) Smokers (n = 9)	0.0053 ± 0.0027 0.011 ± 0.007	0.052 ± 0.02 0.104 ± 0.036		Placentae perfused with 2L saline before analysis. No association of Cd with preeclampsia	Lazebnik et. al. (1989)
Newark, NJ	Nonsmokers Smokers	0.017 ± 0.0075 (n = 9) 0.034 ± 0.0077 (n = 11)		0.01 ± 0.0027 (n = 11) 0.018 ± 0.01 (n = 13)	Amniotic fluid 0.014 ± 0.0045 0.019 ± 0.0079 nmol/mL (n = 15) Cd in bloods significantly higher in smokers	Chatterjee et. al. (1988)
Nashville, TN ^a		0.015 ± 0.0186 (n = 83)	0.151 ± 0.001 (n = 135)	0.0144 ± 0.021 (n = 123)		Baglan et al. (1974)
London, Canada	Nonsmokers (n = 5)		0.27 ± 0.04		Tissue perfused for 5 min before sampling	Goyer et al. (1992)

Location	Population	Maternal Blood (nmol/mL)	Placenta (nmol/g)	Cord Blood (nmol/mL)	Comment	Reference
Mexico City, Mexico	Smoking study Total (n = 49)	0.0151 ± 0.0018 0.0107 ± 0.0010		0.0098 ± 0.0020 0.0089 ± 0.0010	Smokers blood Cd significantly > nonsmokers Birthweight marginally associated with cord blood Cd (p<0.06)	Galicia-Garcia, et al. (1997)
B. Europe						
Belgium	Nonsmokers (n = 331) Smokers (n = 109)	0.011 ± 0.011 0.018 ± 0.011		0.089 ± 0.012 0.0062 ± 0.0080	Significant increase in maternal blood Cd in smokers	Buchet et al. (1978)
Czech Republic	Brno and Znojmo (n = 688)		0.0286 ± 0.069		Increased Cd with maternal age	Fiala et al. (1998)
Czechoslovakia	Urban, industrial (n = 50) Control (n = 50)	RBC 0.060 ± 0.039 0.054 ± 0.049	0.028 ± 0.018 0.036 ± 0.033	RBC 0.039 ± 0.024 0.053 ± 0.051	Truska et al. (1989)	
Czechoslovakia	IUGR (n = 50) Control (n = 27)		0.059 ± 0.026 0.052 ± 0.025		Compared IUGR with Control - not significant	Richter et al. (1997)
Finland	2 smokers (n = 19)	0.0098 ± 0.0080	0.18 ± 0.13 (n = 6)	0.0036 ± 0.0018	Amniotic fluid 0.0089 ± 0.0018 nmol/mL	Korpela et al. (1986)
Germany		0.017 ± 0.0098 (n = 27)	0.044 ± 0.02 (n = 33)	0.0098 ± 0.0036 (n = 17)	Placental Cd 0.093 ± 0.05 nmol/g dry wt	Schramel et al. (1988)
Bailystok, Poland Lund, Sweden	Industrial town (n = 9) University town (n = 15)	0.016 ± 0.012 0.0098 ± 0.015	2.05 ± 1.78 ^{bc} 0.89 ± 0.89 ^{bc}		Cd levels smokers & nonsmokers did not differ significantly; however, pre term labor blood Cd significantly > term labor blood Cd*.	Fagher et al. (1993)
Solna, Sweden	(n = 106)	0.0014	0.046	0.0002	Cd levels smokers & nonsmokers did differ significantly	Osman et al. (2000)
Upper Silesia, Poland	Polluted Industrial town (n = 24)	0.043 ± 0.022**	1.72 ± 1.1	0.0101 ± 0.002	In polluted area Cd elevated but not controlled for smoking levels.	Baranowska et al. (1995)

Location	Population	Maternal Blood (nmol/mL)	Placenta (nmol/g)	Cord Blood (nmol/mL)	Comment	Reference
Karlstad, Sweden	Smoking: serum SCN < 50 (n = 23) 50-69 (n = 12) > 70 (n = 3)		0.18 ± 0.06 ^b 0.2 ± 0.05 ^b 0.32 ± 0.1 ^b		Placental zinc also increased with smoking	Wing et al. (1992)
Northern Sweden	<u>Smelter</u> Smoking (n = 41) Non Smoking (n = 75) <u>Control Region</u> Smoking (n = 16) Nonsmoking (n = 50)	0.010 ± 0.0043 0.008 ± 0.0026 0.0098 ± 0.0033 0.0072 ± 0.0034		0.0074 ± 0.0029 0.0066 ± 0.0024 0.0069 ± 0.002 0.0054 ± 0.0023	Smelter: Cd blood levels in newborns of non-smokers significantly > than in non-smokers from control region. Smokers Cd significantly > non-smoker Cd. Newborn blood Cd 70% of mother's blood Cd.	Lagerkvist et al. (1992)
Kyiv Dniprodzerzhinsk, Ukraine	N = 100 N = 100		0.078 0.088		Study of two industrialized cities	Zadorozhnaja et al. (2000)
Essex, UK	Nickel-Cadmium battery factory (n = 62)	0.068 ± 0.049	0.122 ± 0.191		Placenta Cd correlated with Maternal blood Cd; No signif. effect on birthweight. No morphological effect of Cd on placenta.	Berlin et al. (1992)
Yugoslavia	Nonsmokers near lead smelter (T. Mitrovica) (n = 106) Control - Pristina (n = 55)		1.15 ± 0.86 0.78 ± 0.30		Placental Cd from smelter workers significantly > than from controls; no association between placental Cd & birthweight.	Loiacono et al. (1992)

Location	Population	Maternal Blood (nmol/mL)	Placenta (nmol/g)	Cord Blood (nmol/mL)	Comment	Reference
C. Asia						
Nagoya City, Japan	Smoking status not stated	0.062 ± 0.036 (n = 106)	1.01 ± 0.07 (n = 113)	0.08 ± 0.05 (n = 97)	Placentae washed with tap water.	Tsuchiya et al. (1984)

Values are mean ± SD

^aValues presented as dry weight. Converted to wet weight according to authors directions: placenta divided by 6.0; Maternal blood divided by 5.5; fetal blood divided by 4.7.

^bDry weight

^cDry weight percentage = 18.6 ± 2.92%.

^dDry weight percentage = approximately 20%.

** Maternal levels significantly > than cord blood levels of Cd.

Issue may be distribution of patients in each category from respective regions.

Modified from Eisenmann and Miller (1996) and taken from Miller (2001).

Table 3-7. Maternal Blood and Cord Blood Concentrations of Lead from Different Regions of the World and Under Selected Urban, Industrial and Environmental Conditions

Location	Population	Maternal Blood (ng/mL)	Cord Blood (ng/mL)	Cord/Maternal Blood	Comment	Reference
A. Americas						
USA	8 different sites (n = 187)	333	373	318		Creason et al. (1976)
Cleveland, OH	Urban, disadvantaged (n = 185)	64.8 ± 18.8	58.4 ± 20.2	0.90 ^a	No association of lead with decreased birthweight or anomalies.	Ernhart et al. (1986)
Cleveland, OH	Urban (n = 47)	RBC 491 ± 119	RBC 329 ± 102	0.67 ^a		Kuhnert et al. (1977)
Louisville, KY	Indigent urban (n = 154)	98.5 ± 44	97.3 ± 41	0.99 ^a	No relationship between lead & PROM ^e , preterm delivery, meconium or preeclampsia.	Angell and Lavery (1982)
Nashville, TN		165 ± 140 (n = 84)	123.4 ± 197.8 (n = 130)	0.75 ^a	Placental Lead 305 ± 422 ng/g (n = 234)	Baglan et al. (1974)
Shreveport, LA	Indigent (n = 98)	103	101	0.98 ^a	No effect of lead on birthweight.	Gersanik et al. (1974)
Toronto, Canada	Urban (n = 95)	29.0 ± 10.4	16.6 ± 14.5	0.57 ^a		Koren et al. (1990)
Sao Paulo, Brazil	Urban, disadvantaged (n = 43)	93 ± 27	80 ± 27	0.83 ± 0.22 ^c		Troster and Schuartsman (1988)
Venezuela						1990
B. Europe						
Belgium	Smokers (n = 109) Nonsmokers (n = 333)	105 ± 32 100 ± 40	89 ± 33 81 ± 35	0.85 ^a 0.81 ^a	Smoking associated with decreased birthweight.	Buchet et al. (1978)
Czechoslovakia	IUGR (n = 50) Control (n = 27)		15.2 ± 7.9 11.3 ± 5.8		Compared Intrauterine Growth Restricted babies with controls - No significant differences in this study.	Richter et al. (1997)
Czechoslovakia	Urban, industrial (n =	RBC 109.4 ± 42.4	RBC 74 ± 31.6	0.68 ^a	Placental lead:	Truska et al.

Table 3-7. Maternal Blood and Cord Blood Concentrations of Lead from Different Regions of the World and Under Selected Urban, Industrial and Environmental Conditions (continued)

Location	Population	Maternal Blood (ng/mL)	Cord Blood (ng/mL)	Cord/Maternal Blood	Comment	Reference
	50) Control (n = 50)	RBC 160 ± 63.1	RBC 113.4 ± 57.5	0.71 ^a	urban, 42.9 ± 26.5; Control: 43.2 ± 29.7 ng/g	(1989)
Roskilde, Denmark	Rural	34 (6-63) ^b (n = 78)	23 (6-50) ^b (n = 48)	0.7 ^c (0.2-1.4) ^b (n = 48)		Milman et al. (1988)
Finland	(n = 19)	40.4 ± 18.2	37.1 ± 13.5	0.56 ^a	Placental lead: 22.6 ± 15.7 ng/g (n = 6); Amniotic fluid: 59.6 ± 8.3 ng/mL	Korpela et al. (1986)
Germany		39 ± 14 (n = 27)	30 ± 16 (n = 17)	0.77 ^a	Placental lead: 18.7 ± 7.3 ng/g wet wt; 217 ± 77 ng/g dry wt (n = 33)	Schramel et al. (1988)
Northern Italy	Small town, rural (n = 75)	RBC 264 ± 45 Plasma 6.6 ± 3.5	RBC 254 ± 43 Plasma 6.2 ± 3.1	RBC 0.96 ^a Plasma 0.94 ^a	Correlation between maternal & cord blood greater for plasma than RBCs.	Cavalleri et al. (1978)
Poland	(n = 100)	98 ^d (67-136) ^b	76 ^d (53-109) ^b	0.8 ^c (0.62-1.03) ^b	Sikorski et al., 1988	
Bialystok, Poland Lund, Sweden	Industrial town (n = 24) University town (n = 6)	37.9 ± 17.2 11.2 ± 2.9			Lead levels not related to increased myometrial activity in preterm labor. Placental lead: Bialystok, 0.3 ± 0.2; Lund 0.3 ± 0.1 mg/g dry wt.	Fagher et al. (1993)
Sweden	Atmospheric pollution Low Intermediate High	61 ± 21 (n = 21) 92 ± 37 (n = 173) 84 ± 27 (n = 103)		44 ± 20 (n = 47) 80 ± 38 (n = 391) 73 ± 27 (n = 103)	Significantly lower blood lead in region with low atmospheric pollution.	Zetterlund et al. (1977)
Stoke-on Trent, UK	Pottery workers Lithographers (n = 27) Transferers (n = 2)	190 ± 90 120 240 ± 110			Placental lead: lithographers (n = 16) & transferers (n = 8), 0.34 ± 0.16; painters (n = 6) 0.54 ±	Khera et al. (1980)

Location	Population	Maternal Blood (ng/mL)	Cord Blood (ng/mL)	Cord/Maternal Blood	Comment	Reference
	Painters (n = 11)				0.09 mg/g	
Yugoslavia	<u>Near lead smelter</u> (T. Mitrovica) (n = 106) <u>Nonexposed</u> (Pristina) (n = 55)	217.6 ± 68.4 68.4 ± 47.7	203.1 ± 76.6 55.9 ± 39.4	0.93 ^a 0.82 ^a	Placental lead: (T. Mitrovica), 14.4 ± 14.8; (Pristina), 4.5 ± 3.8 mg/g dry wt; Placental and blood Pb from smelter workers significantly > than in controls.	Loiacona et al. (1992)
C. Africa						
Kabwe, Zambia	3000 mile radius of lead mine (n = 122) controls (n = 31)	412 ± 144 147 ± 75	370 ± 153 118 ± 56	0.9 ^a 0.8 ^a	No effect of lead on birthweight.	Clark (1977)
D. Asia						
Nagoya City, Japan		75 ± 54 (n = 105)	84 ± 77 (n = 95)	1.1 ^a		Tsuchiyq et al. (1984)
Kuala Lumpur, Malaysia	Urban (n = 114)	151.3 ± 41.4	114 ± 31.1	0.75 ^a		Ong et al. (1985)
Taiwan	(n = 147)	64.8 ± 23.8	40.9 ± 15.6	0.63 ^a		Soong et al. (1991)

Values are means ± SD

^aRatio calculated from population means.

^bRange

^cRatio is mean of individual ratios.

^dGeometric mean

^ePROM = premature rupture of fetal membranes

^fValues were presented as dry weight. Converted to wet weight according to authors' directions: Placenta divided by 6.0, maternal blood divided by 5.5; fetal blood divided by 4.70.

Table 3-8. Maternal Blood, Placenta and Cord Blood Concentrations of Mercury from Different Regions of the World and Under Selected Urban, Industrial and Environmental Conditions

Location	Population	Maternal Blood (Total ng/mL)	Placenta (Total ng/g wet wt)	Cord Blood (Total ng/mLs)	Comment	Reference
Des Moines, IA	(n = 57)	1.21 ± 1.06		1.15 ± 1.36	No difference between urban & rural	Kuntz et al. (1982)

Table 3-8. Maternal Blood, Placenta and Cord Blood Concentrations of Mercury from Different Regions of the World and Under Selected Urban, Industrial and Environmental Conditions (continued)

Location	Population	Maternal Blood (Total ng/mL)	Placenta (Total ng/g wet wt)	Cord Blood (Total ng/mLs)	Comment	Reference
Kagoshima, Japan	(n = 38)	17.4 ± 9.8	31 ± 18.3	23.8 ± 10.4	Placentae washed before analysis. One outlier omitted: Maternal blood = 966; placenta = 56; Cord blood = 388	Shinkawa (1974)
Augusta, GA Birmingham, AL Charlotte, NC	(n = 19) (n = 22) (n = 17)		8 ± 4.4 15 ± 14.1 19 ± 12.4			Karp and Robertson (1977)
8 Locations, USA		10 (n = 177-187)	24 (n = 160-169)	13 (n = 177-187)	>10% of samples less than minimum detectable	Creason et al. (1976)
Germany		2.7 ± 0.6 (n = 5)	4.1 ± 2.1 (n = 26)	4.6 ± 2.4 (n = 4)	In most cases blood Hg below detection limit. Placental Hg: 26 ± 12 ng/g dry weight	Schramel et al. (1988)
Taiwan	(n = 85)	19.4 ± 13.8		28.8 ± 26.7	No association of Hg levels with birthweights	Soong et al. (1991)
Japan	(n = 9)	RBC 22.9 ± 11.9 Plasma 12.4 ± 7.3	71.5 ± 27.4	RBC 30.8 ± 21.6 Plasma 11.2 ± 7.2		Suzuki et al. (1971)
RBC/Plasma						
Czechoslovakia	Control (n = 50) Industrial (n = 50)	RBC 5.5 ± 1.7 RBC 6.1 ± 1.8	2.2 ± 1.0 2.0 ± 0.9	RBC 4.4 ± 1.5 RBC 4.6 ± 1.9		Truska et al. (1989)
Oslo, Norway	Controls (n = 26) Dental workers	RBC 7.96 ± 2.5 Plasma 4.62 ± 2.45 RBC 8.84 ± 3.79 Plasma 4.63 ± 2.96 (n = 19)	12 ± 4.74 24.47 ± 17.7 (n = 19)	RBC 8.85 ± 3.78 Plasma 4.31 ± 2.91 RBC 10.18 ± 5.9 (n = 17) Plasma 4.06 ± 2.8 (n = 18)	Exposed group had significantly increased Hg levels in placentae and membranes, but not in blood or amniotic fluid.	Wannag and Skjaerasen (1975)

Table 3-8. Maternal Blood, Placenta and Cord Blood Concentrations of Mercury from Different Regions of the World and Under Selected Urban, Industrial and Environmental Conditions (continued)

Location	Population	Maternal Blood (Total ng/mL)	Placenta (Total ng/g wet wt)	Cord Blood (Total ng/mLs)	Comment	Reference
Total/Organic						
Genova, Italy	None with high seafood consumption		Total 12 ± 8 (n = 22) Organic 8 ± 7 (n = 18)		Placentae washed with deionized water.	Capelli and Minganti (1986)
Methyl/Inorganic						
USA	Industrialized urban area (n = 3)		Methyl 22.3 ± 6.3 Inorganic 16.8 ± 4.4			Cappon and Smith (1981)
Cleveland, OH		Methyl: RBC 3 ± 2.1 (n = 29) Plasma 0.4 ± 0.2 (n = 25) Inorganic: RBC: 2.5 ± 1.8 (n = 28) Plasma: 1.7 ± 1.4 (n = 22)	Methyl: 1.4 ± 1.1 (n = 24) Inorganic: 5.3 ± 3.2 (n = 24)	Methyl: RBC: 3.9 ± 3 (n = 29) Plasma: 0.4 ± 0.3 (n = 25) Inorganic: RBC 1.4 ± 1.2 (n = 28) Plasma 2.6 ± 1.9 (n = 22)	Placentae perfused before analysis	Kuhnert et al. (1981)

Values Means ± SD

^aValues were presented as dry weight. Converted to wet weight according to authors directions: Placenta: divided by 6.0; 5.5, maternal blood: divided by 4.7, fetal blood: divided by 4.7

Table 3-9. Maternal Blood, Cord Blood and Placental Selenium Concentrations*

Location	Maternal Blood (nM/mL)	Cord Blood (nM/mL)	Placenta (nM/g)	Reference
Finland (21)	0.73	0.77	2.2	Korpela et al.1984
Germany (33)	1.0	1.0	2.4	Schramel et al. 1988
N. Ireland (56)	0.59	0.44(a)		Wilson et al. 1991
Sweden (106)	0.91	0.67	2.4	Osman et al. 2000

* Values are means for the number of subjects indicated in parentheses.

(a) Cord blood concentrations significantly different from maternal blood concentrations, $p < 0.01$.

Table 3-10. Role of P-glycoproteins (Multidrug transporters) in the Transfer of Molecules from Mother to Fetus*

Mouse Fetuses	¹⁴ C Saquinavir + vehicle	¹⁴ C Saquinavir + PSC833	PSC833/vehicle Ratio
Wild-type <i>mdr1a</i> ^{+/+} / <i>1b</i> ^{+/+}	4.2±0.6	26.3±8.9 ^B	6.3
Heterozygous <i>mdr1a</i> ^{+/-} / <i>1b</i> ^{+/-}	4.4±1.0	20.9±6.2 ^A	4.6
Null <i>mdr1a</i> ^{-/-} / <i>1b</i> ^{-/-}	21.1±3.4	26.0±6.8 ^C	1.2
Plasma	146±16	790±195 ^B	5.4

*In wildtype (*mdr1a*^{+/+}/*1b*^{+/+}), heterozygous (*mdr1a*^{+/-}/*1b*^{+/-}) and null (*mdr1a*^{-/-}/*1b*^{-/-}) mouse fetuses at 15 minutes following intravenous administration of ¹⁴C saquinavir (1mg/kg).

Note: Results are presented as means ± SD in ng ¹⁴C saquinavir equivalents per gram or per mL. Four pregnant dams (*mdr1a*^{+/-}/*1b*^{+/-}) at 15 GD were gavaged with PSC833 (50 mg/kg) or vehicle alone 2 hr before IV injection of ¹⁴C saquinavir at 1 mg/kg. Four to 27 fetuses for each genotype were analyzed. A = $P < 0.0005$; B = $P < 0.01$; C = $P < 0.05$ versus vehicle treated mice.

Source: From Smit et al. 1999.

Table 3-11. Biomarkers of Exposure and Effect in the Human Placenta

AGENT	BIOMARKER	REFERENCES
Benzo(α)pyrene	DNA Adducts Proteins CYP1a1 Arylhydrocarbon hydroxylase Receptor	
Cigarette Smoking	Cadmium DNA Adducts Pathology Proteins Arylhydrocarbon hydroxylase Metallothionein	Table 3-6
Glucocorticoids	Aromatase CYP 19	Paakki et al. 1999
Metals	Arsenic Cadmium Lead IgE Mercury Selenium Metallothionein	Table 3-6 Table 3-7 Snyder et al. 2000 Table 3-8 Table 3-9
N-Acetoxy-2-acetylaminofluorene	DNA Adducts	
Organochlorine compounds	Organochlorines IgE	Reichrtova et al. 1999

Table 3-12. Xenobiotics Observed to Alter Placental and Yolk Sac Function

Agent	Species	Effects		
		Chorioallantoic Placenta	Visceral Yolk Sac	References
Antiserum (yolk sac)	Animal		Inhibit pinocytosis	Beck 1981, Beckman et al. 1991a, Beckman et al. 1991b, Freeman and Lloyd 1983
			Inhibit intralysosomal digestion of macromolecules	
Antiserum (kidney)	Animal		Decreased amino acid transport	Beck 1981, Beckman 1991b, Brent 1964, Brent et al. 1970, Sahali et al. 1992
Arsenic	Human	Lipid peroxidation		Tabacova et al. 1992
Benzo(a)pyrene	Human	Induction of mono-oxygenases Alteration of protein hormone Secretion		Manchester et al. 1987 Barnea and Shurtz-Swirski, 1991
Cadmium	Human	Placental necrosis		Wier and Miller 1987, Wier et al. 1990, Breen et al. 1992a, Breen et al. 1992b, Breen et al. 1993, Boadi et al. 1991a, Page et al. 1992, Miller et al. 1991
		Reduced release of protein hormones		Manchester et al. 1984, Wier and Miller 1989, Torreblanca et al. 1992, Goodman et al. 1982a, Goodman et al. 1982b
		Loss of placental integrity Induction of metallothionein Rapid accumulation of cadmium		

Table 3-12. Xenobiotics Observed to Alter Placental and Yolk Sac Function (continued)

Agent	Species	Effects		
		Chorioallantoic Placenta	Visceral Yolk Sac	References
Cadmium (cont.)	Animal	Placental necrosis		White et al. 1990; Parizek et al. 1964; Levin and Miller 1980; Saltzman and Miller 1989; Di Sant'Agnese et al. 1983; Danielsson and Dencker 1984; Ahoka et al. 1981; Webb 1983; Cho 1991; Levin and Miller 1981; Levin et al. 1981, 1983, 1987; Samarickarama and Webb 1979; Sonawane et al. 1975
		Increased mitochondrial calcium Altered enzymes Rapid accumulation of cadmium		
			Inhibit pinocytosis	Record et al. 1982 Feuston and Scott 1985
			Reversible by zinc	
Choline acetyltransferase inhibitor 2-Benzolethyltrimethyl ammonium	Human	Inhibited amino acid uptake Lowered choline acetyltransferase Lowered acetylcholine levels Decreased acetylcholine release		Sastry et al. 1983
Chlordane	Human	Alteration of cholinesterase		Kulkarni et al. 1987
Chloroform	Animal	Placental necrosis		Whipple 1912
Cocaine	Human	Reduced amino acid uptake		Ahmed et al. 1991; Barnwell and Sastry 1983; Sastry et al. 1977; Pastrakuljic et al. 2000
Colchicine	Human	Reduced amino acid uptake Inhibits differentiation		Sastry et al. 1983 Douglas and King 1993

Table 3-12. Xenobiotics Observed to Alter Placental and Yolk Sac Function (continued)

Agent	Species	Effects		
		Chorioallantoic Placenta	Visceral Yolk Sac	References
Colchicine (cont.)	Animal		Inhibits pinocytosis	Polliotti et al. 1991
Cortisol	Animal	Alters solvent transfer		Leake et al. 1984
p,p,-DDT DDE	Human	Alterations of cholinesterase Inhibit Ca ²⁺ ATPase		Kulkarni et al. 1987
Dinitrophenol	Animal	Inhibit pinocytosis Inhibit vitamin B ₁₂ uptake		Polliotti et al. 1991 Lloyd 1990
Dinitrophenol/ iodoacetamide	Human	Inhibit glucose metabolism		Miller and Berndt 1973, 1974; Longo et al. 1973, Malek et al. 1989
		Inhibits amino acid transport Produces placental leakiness Decreases ATP levels		
	Animal	Inhibit vitamin B ₁₂ uptake		Polliotti et al. 1991
Enalapril	Animal	Pathology – hypocellular/small		Valdes et al. 1992
Endotoxin	Animal	Placental necrosis		McKay and Wong 1962 Athanasakis et al. 1999
Ethanol	Human	Alter membrane fluidity		Fisher and Karl 1990; Fisher et al. 1981, 1983, 1986; Henderson et al. 1991; Rice et al. 1986; Sastry and Owen 1987; Schenker et al. 1989; Beer et al. 1991
		Inhibit Nutrient Transport		
	Animal	Inhibit pinocytosis		Steventon and Williams 1987
Ethylnitrosourea	Animal	Induce choriocarcinoma		Muehleemann et al. 1992
Hydralazine	Human	Inhibit monoamine oxidase and Catechol-O-methyl transferase		Barnea et al. 1987

Table 3-12. Xenobiotics Observed to Alter Placental and Yolk Sac Function (continued)

Agent	Species	Effects		
		Chorioallantoic Placenta	Visceral Yolk Sac	References
Hyperglycemia	Animal		Reduced protein uptake	Pinter et al. 1986, Hunter and Sadler 1992, Hunter et al., 1991
Iodoacetate	Animal		Inhibit pinocytosis	Lloyd 1990
Indomethacin	Human	Stimulates progesterone secretion		Ilekis and Benveniste 1983
Kepon	Human	Inhibit Ca ²⁺ ATPase		Kulkarni et al. 1987
Leupeptin	Animal		Inhibit lysosomal proteolysis	Serfani and Romeu 1991 Brent et al. 1983
			Does not inhibit pinocytosis	
Lindane	Human	Inhibit Ca ²⁺ ATPase		Kulkarni et al. 1987
Lipoxygenase inhibitor (nordihydroguaiaretic acid)	Human	Inhibits hCG secretion		Ilekis and Benveniste 1983
Lipoxygenase inhibitor N-hydroxy-n-methyl-7-propoxy-2-naphthalin ethanamine	Animal		Altered morphology	Terlouw and Bechter 1992
Mercury	Human	Alters membrane fluidity		Goodman et al. 1982a, b; Miller and Ballinger 1993; Urbach et al. 1992
		Impaired Amino Acid transport		
	Animal	Inhibit transport of zinc and copper		Webb 1983
Methoxychlor	Human	Inhibit Ca ²⁺ ATPase		Kulkarni et al. 1987
Mirex	Human	Inhibit Ca ²⁺ ATPase		Kulkarni et al. 1987
N-acetoxy-2-acetylaminofluorene	Animal		Localization of DNA adducts	Mirkes et al. 1991

Table 3-12. Xenobiotics Observed to Alter Placental and Yolk Sac Function (continued)

Agent	Species	Effects		
		Chorioallantoic Placenta	Visceral Yolk Sac	References
Narcotics	Human	Decreased protein incorporation		Ahmed et al. 1991; Barnwell and Sastry 1983; Sastry et al. 1977; Beaconsfield et al. 1987; Cemerikic et al. 1991, 1992; Gude et al. 1989
		Decreased amino acid uptake		
Nickel	Animal		Inhibited glutathione S-transferase Reduced glutathione reductase	Serfani and Romeu 1991
Nicotine	Human	Decreased glucose utilization		Barnwell and Sastry 1983 Sastry et al. 1977, Fisher et al. 1981
		Decreased lactate production		
		Decreased amino acid uptake		Pastrakuljic et al. 2000
		Increased acetylcholine release		
Nucleosides (Anti-HIV)	Human	Inhibits cell proliferation		Bui et al. 1992, Plessinger et al. 1992 Plessinger and Miller 1993
		Alters progesterone, hCG, hPL release Inhibits cell differentiation		
Ouabain	Human	Inhibit Na, K, ATPase		Miller and Berndt 1973, 1974, 1975; Miller et al. 1976
		Inhibit Amino Acid Transport		
Phorbol	Human	Stimulates hCG Production		Ilekis and Benveniste 1983
Polychlorobiphenyl	Animal	Decreased Amino Acid Transport		Brunstrom et al. 1982 Kiihlstrom 1982

Table 3-12. Xenobiotics Observed to Alter Placental and Yolk Sac Function (continued)

Agent	Species	Effects		
		Chorioallantoic Placenta	Visceral Yolk Sac	References
Polycyclic aromatic hydrocarbons	Human	Induction of AHH, monooxygenases		Jaiswal et al. 1985, Song et al. 1985 Welch et al. 1969, Manchester and Jacoby 1984, Gurtoo et al. 1983 Manchester et al. 1984
		Alter protein secretion		Barnea and Shurtz-Swirski 1991
Ritodrine	Human	Decreased cAMP		Beaconsfield et al. 1987
Serotonin	Animal	Decrease sodium transfer		Robson and Sullivan 1966
Smoking	Human	Altered histology		Welch et al. 1969, Manchester and Jacoby 1984, Gurtoo et al. 1983 Jaiswal et al. 1985, Song et al. 1985 Everson 1987, Barnea et al. 1987 Urbach et al. 1992, Torreblanca et al. 1982
		Induction of mono-oxygenases Elevated cadmium levels		
Somatomedin inhibitors	Animal		Inhibit pinocytosis	Hunter et al. 1991
			Altered protein processing	
Sucrose	Animal		Altered ultrastructure	Zusman et al. 1987
Suramin	Animal		Inhibit pinocytosis	Brent et al. 1990
Trifluoperazine	Human	Inhibit Ca ²⁺ ATPase		Kulkarni et al. 1987

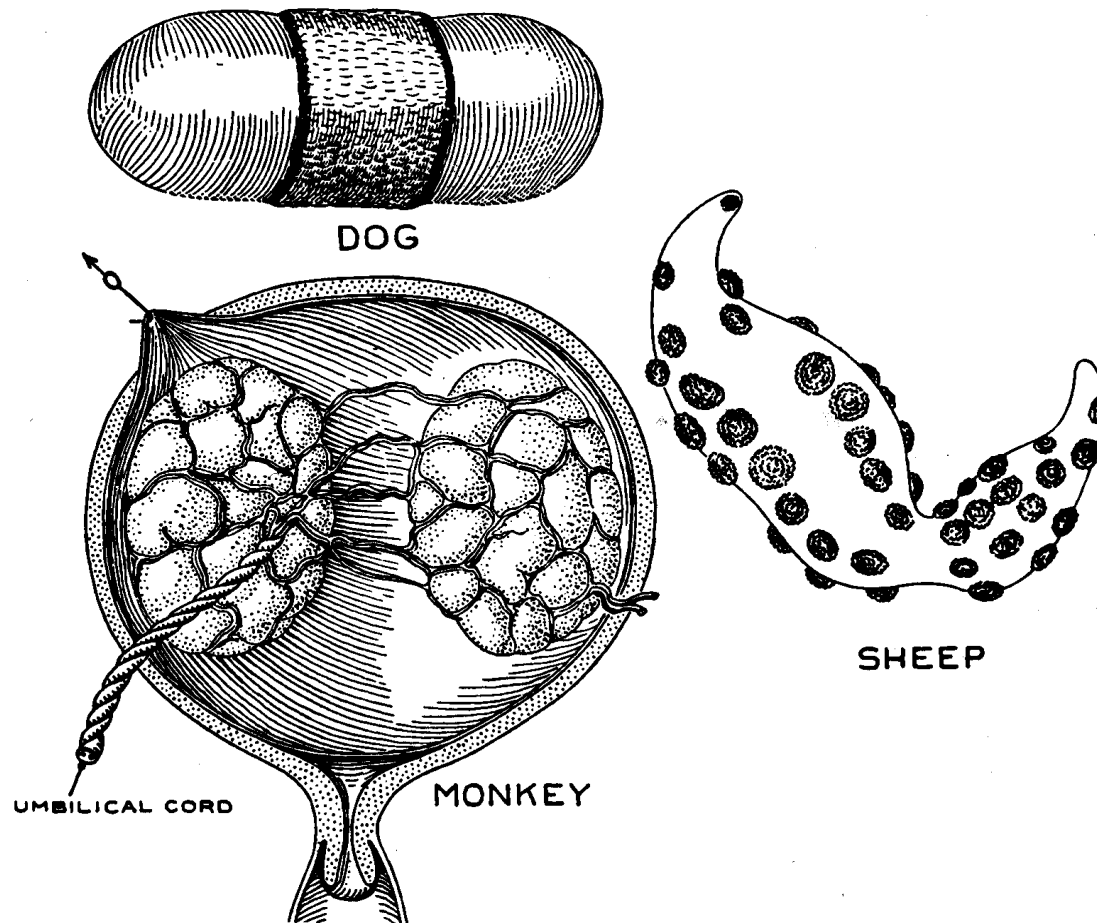

Figure 3-1a. Species comparisons. Gross anatomical differences in placentae from three different mammals. These marked differences are mirrored also in histology and function. (Corner 1944)

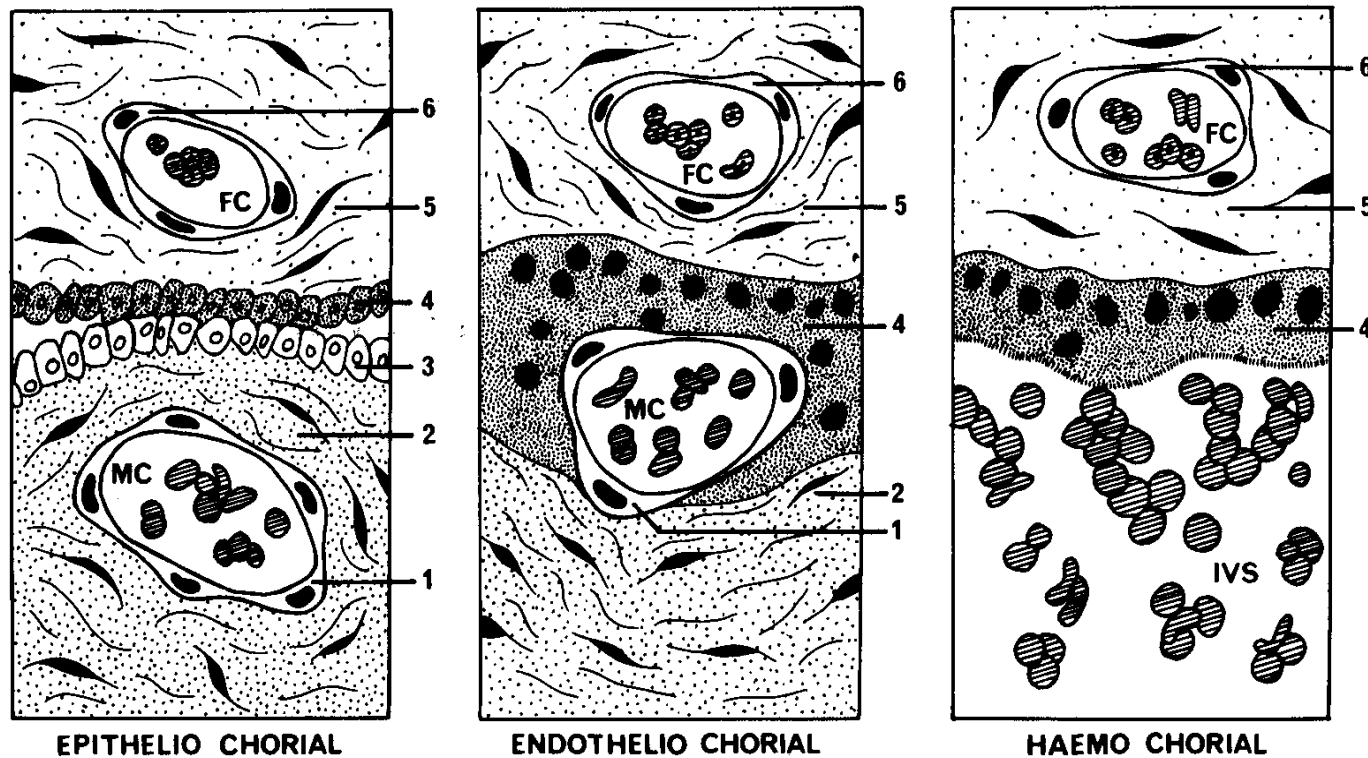

Figure 3-1b. Cross-section of placentae from different species. The constituents of the placental membrane (Grosser's histological criteria): left - the six-layered epitheliochorial placenta of horse and pig; center - the endotheliochorial placenta of cat and dog; right - the hemochorial placenta of human, old and new world monkeys, rat, mouse and guinea pig. 1: maternal capillary endothelium; 2. Maternal connective tissue; 3. Uterine epithelium (endometrium); 4. Chorionic epithelium or trophoblast; 5. Fetal connective tissue; 6. Fetal capillary endothelium; FC: fetal capillary lumen in which fetal erythrocytes circulate; MC: maternal capillary lumen in which maternal erythrocytes circulate; IVS: intervillous space in which maternal erythrocytes circulate. (Panigel 1981)

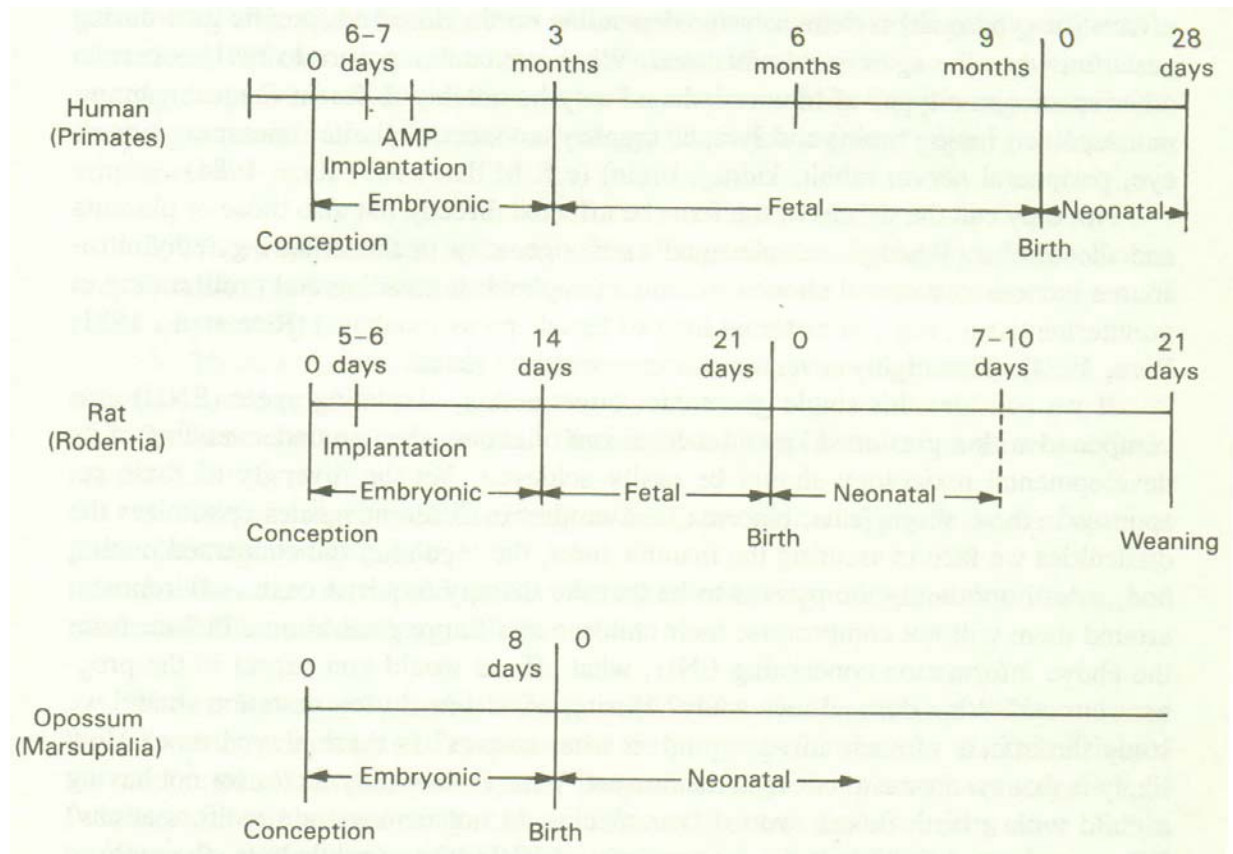

Figure 3-2. Comparative perinatal development in the human, rat, and opossum. The periods of development are defined for each species. LMP, last menstrual period; AMP, anticipated menstrual period. The menstrual cycle in the average human female is 28 days, with ovulation occurring about 14 days. As noted for the rat, since *in utero* development is abbreviated compared to the human (21-22 days versus 9 months), the maturation of the rat newborn is substantially different than in the human. The opossum presents an entirely different development pattern: there is no chorioallantoic placenta, and the neonate is still in embryonic form. Early dependence upon the chorioallantoic placenta as a site for attachment is important in the rat and human but not the opossum, while the yolk sac appears important for all three species. (Miller 1983)

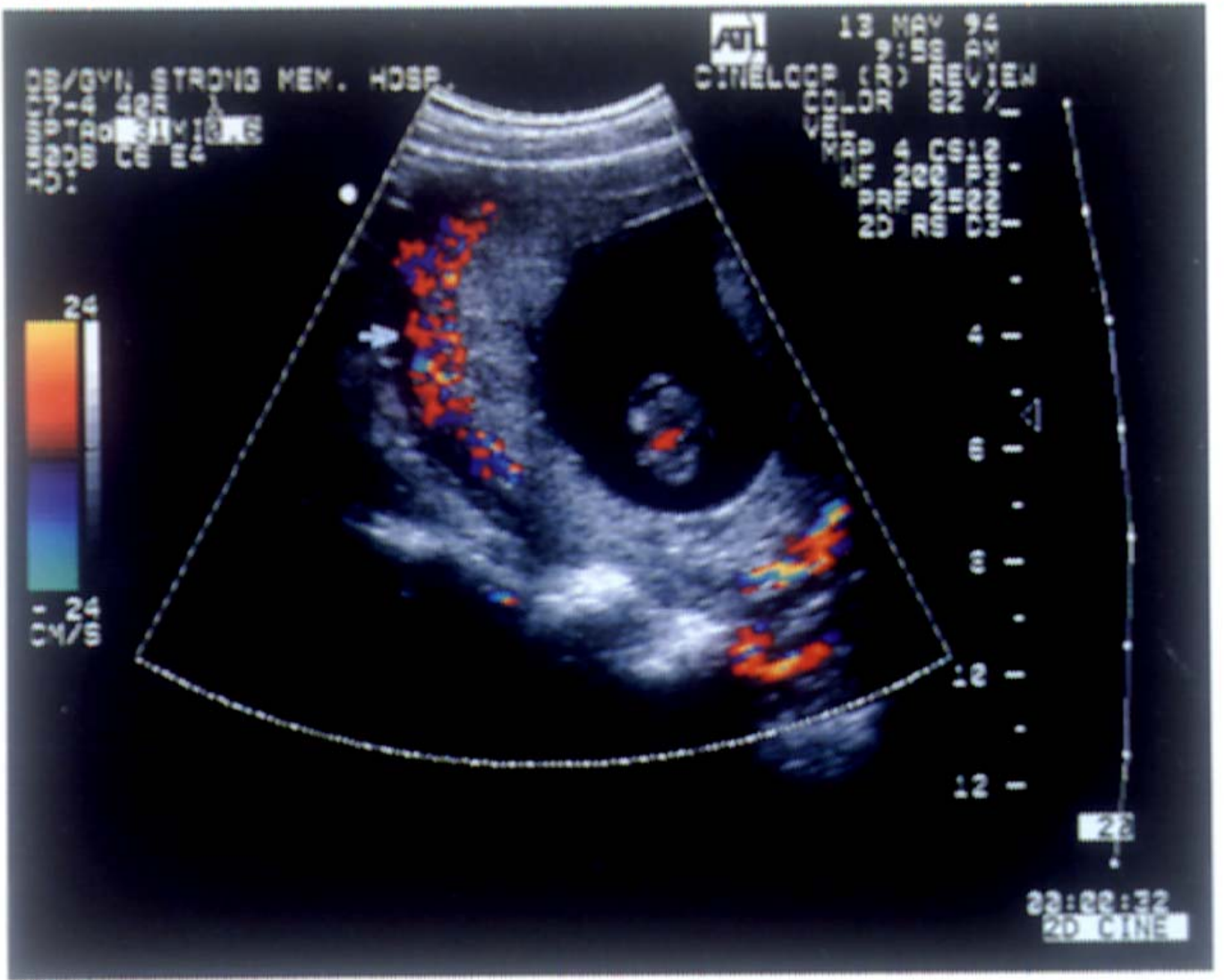

Figure 3-3. Doppler Ultrasound of Early Pregnancy. Note: Embryo blood flow and especially the peripheral localization of the maternal blood flow.

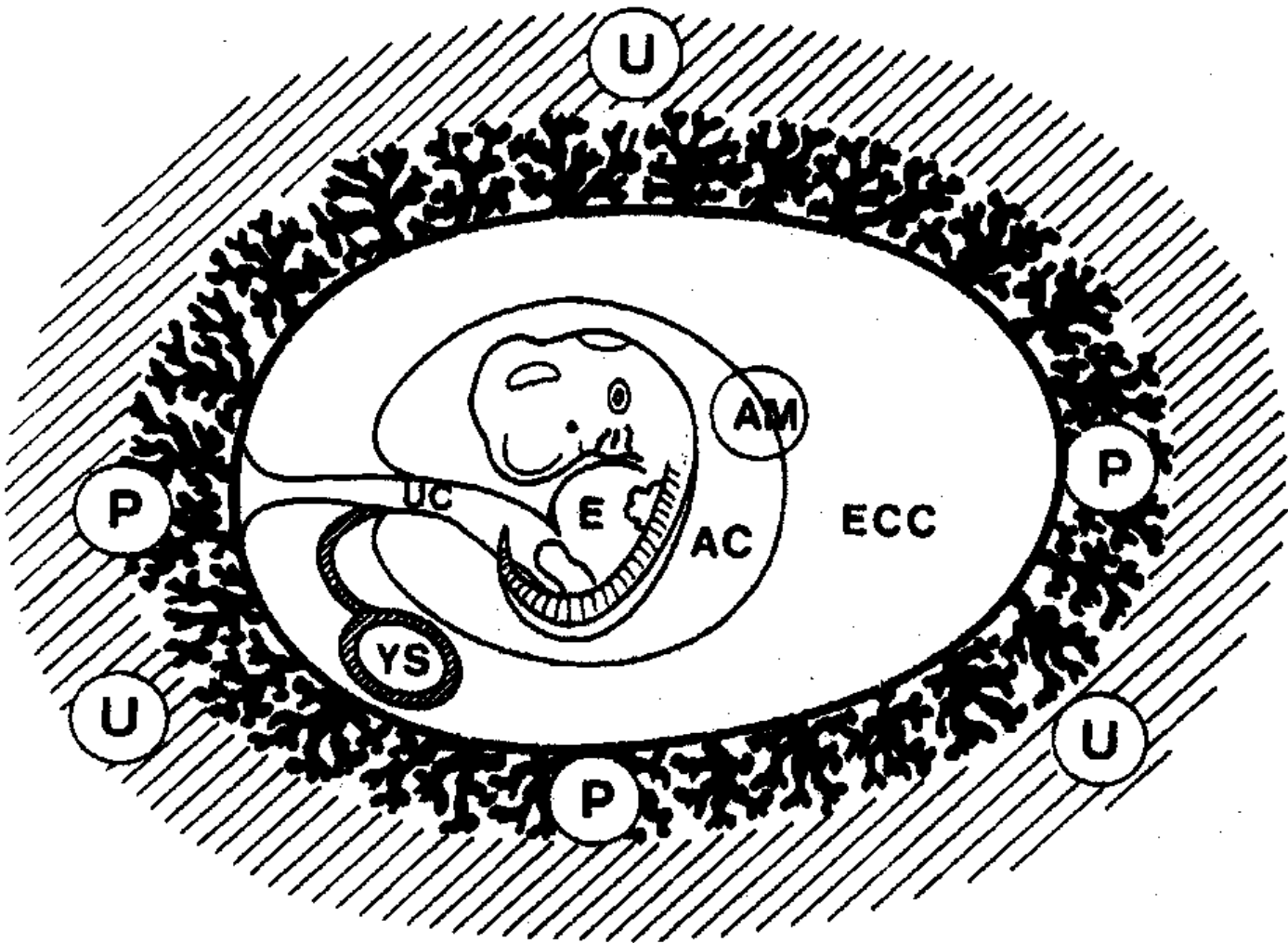

Figure 3-4. Anatomical barriers/membrane compartments inside the first trimester gestational sac. U = uterus; P = chorio placenta; UC = umbilical cord; ECC = exocoelomic cavity; SYS = secondary yolk sac; AC = amniotic cavity; AM = amniotic membrane. (Jauniaux and Gelbis 2000).

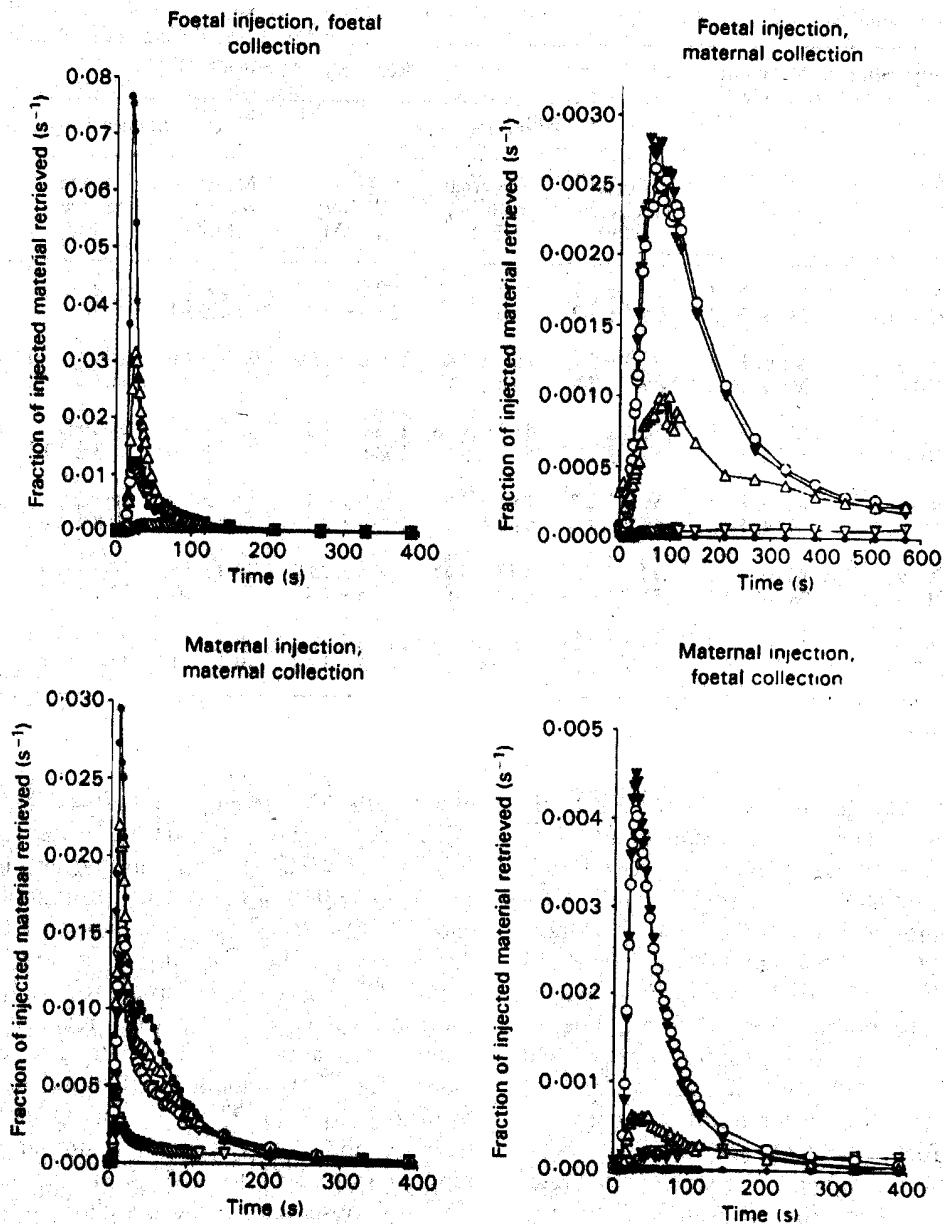

Figure 3-5. Concentration profiles for red blood cells (!), sucrose (○), water (△), antipyrine (—) and propranolol (◇) in the dual perfused human placental lobule. Note differences between injecting the molecules into the fetal circulation versus the maternal circulation in that red blood cells appeared to cross from fetal to maternal but not from maternal to fetal, while water and antipyrine rapidly crossed and sucrose was much slower. Compare these with amino acid transfer (Figure 3-6) or cadmium transfer (Figure 3-10). (Bernus et al. 1999)

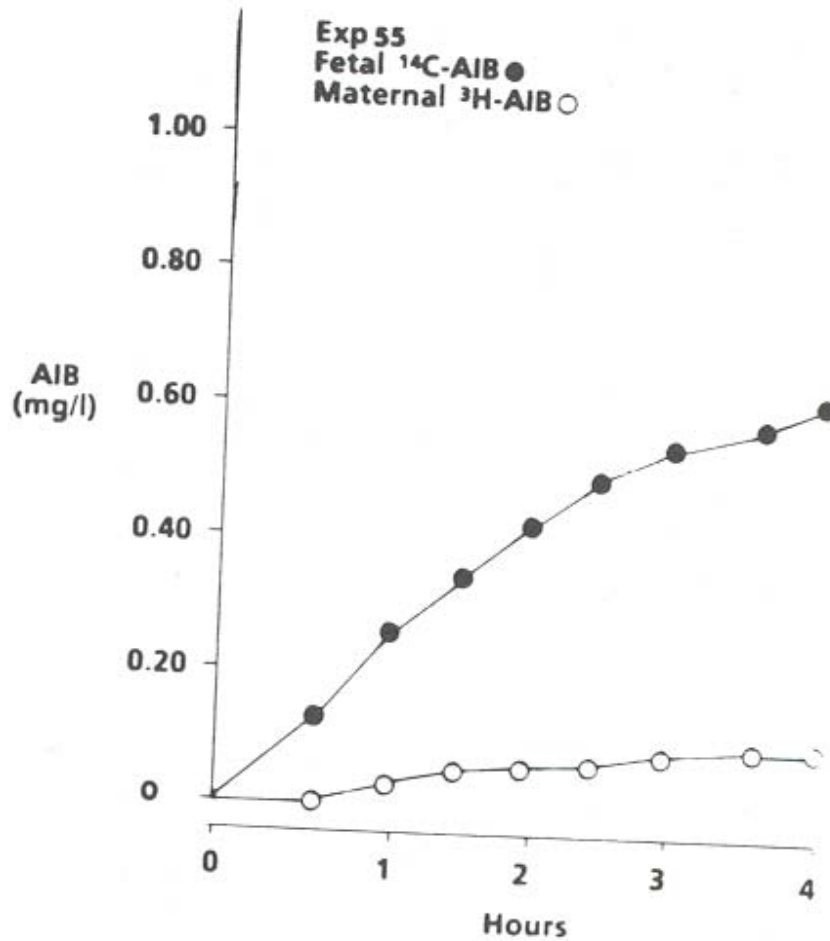

Figure 3-6. Bidirectional movement across the placenta. Concentration profiles for the neutral amino acid (alpha-amino isobutyric acid) when added as ^{14}C -AIB into the maternal circuit and ^3H -AIB into the fetal circuit simultaneously. Note that there is bidirectional movement of the AIB in both directions; however, the ^{14}C -AIB is concentrated to much higher levels in the fetal circuit demonstrating an active transport from mother to fetus. Of special note, ouabain eliminates the concentration of the AIB in the fetal compartment (data not shown). (Wier et al. 1983)

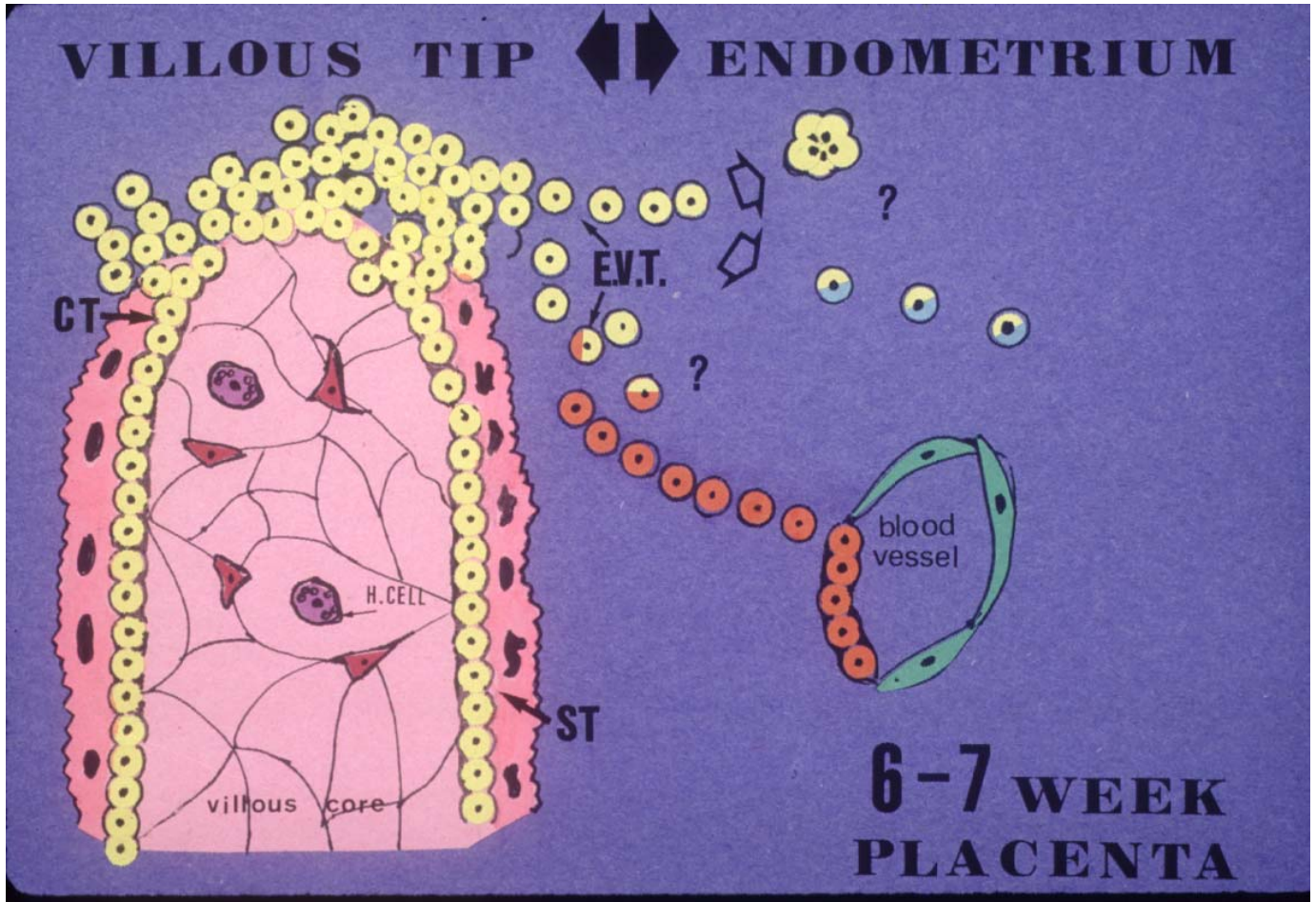

Figure 3-7. Diagram of the trophoblast proliferation and differentiation to extravillous trophoblast representing the fundamental processes in implantation.

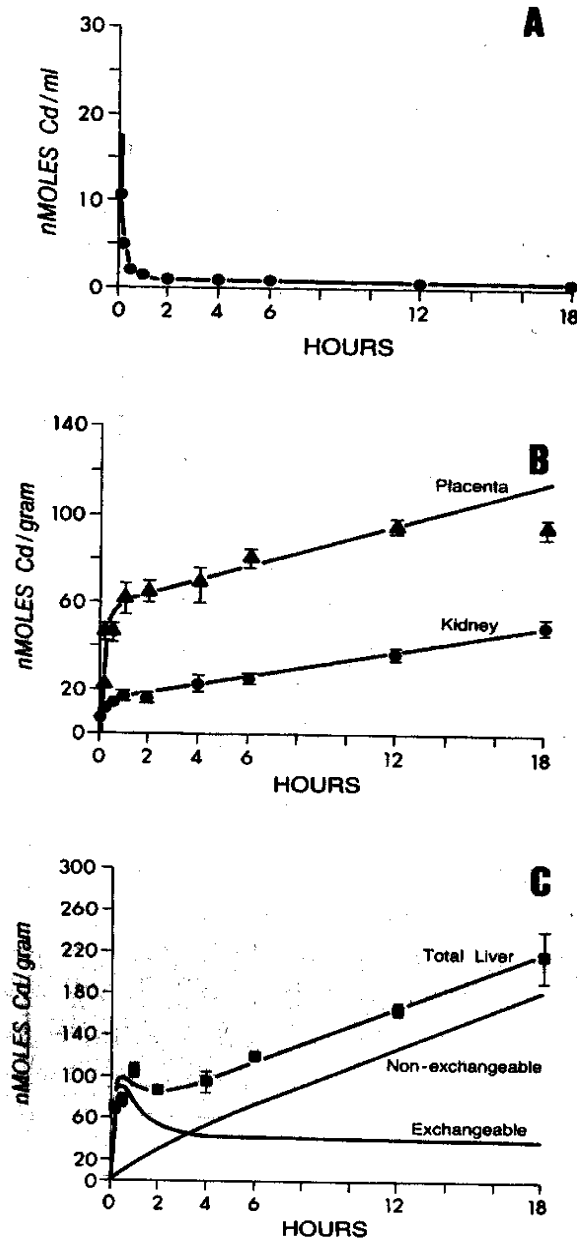

Figure 3-8. Toxicokinetics of cadmium chloride administered to the near-term pregnant rat. Cadmium chloride (40 $\mu\text{mol/kg}$) was injected subcutaneously in pregnant Wistar rats on day 18 of gestation. Toxicokinetic modeling was performed on a Systron Donner 10/29 analog computer using a Hewlett Packard 1310A display. (A) Blood concentration of cadmium with time. The solid line represents the computer simulation of the data. This curve was used to derive all organ compartments except the fetus. (B) Cadmium concentration data for placenta and maternal kidney. The solid lines are computer simulations of the data. Note that the model for the placenta does not predict the 18 hour time point due to the placental toxicity. Mean: SEM. (C) Cadmium concentration data for maternal liver. The lines represent computer simulations of the data. Exchangeable and nonexchangeable compartment concentrations are shown. Mean: SEM (Levin et al. 1987).

Compare this data set from the pregnant rat *in utero* with the *in vitro* human placental perfusion with cadmium chloride (Figure 3-10).

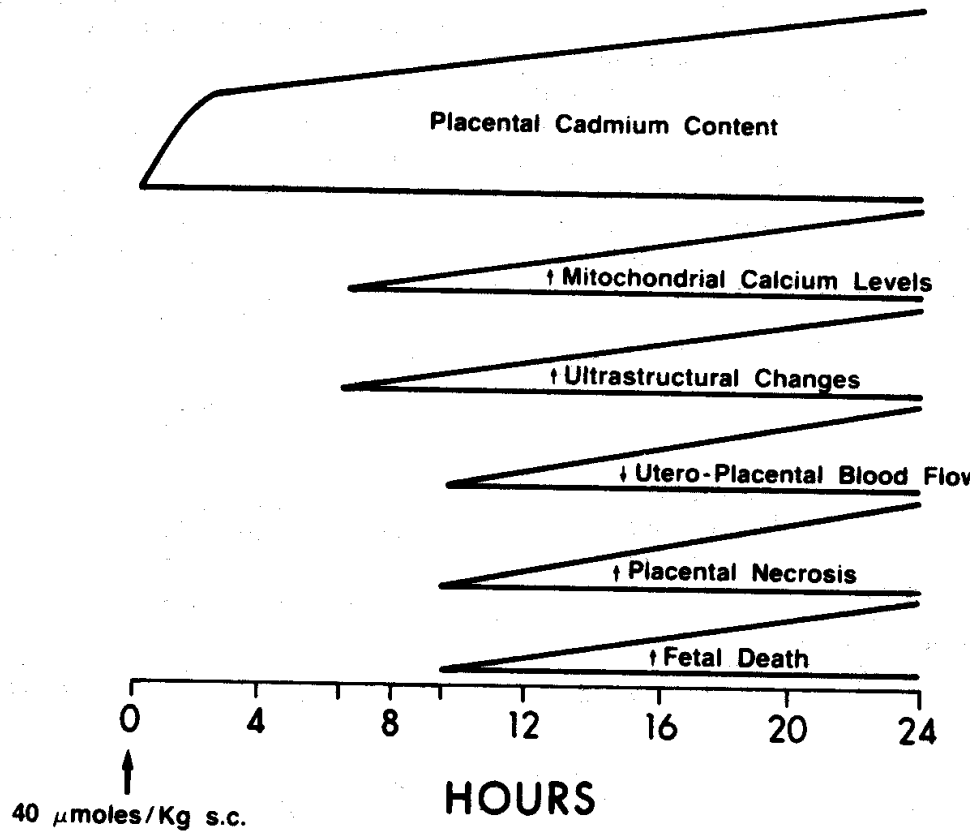

Figure 3-9. Sequence of observed responses in the near-term pregnant rat following a single subcutaneous administration of 40 $\mu\text{moles/kg}$ of cadmium chloride. The lines represent a relative change in structure, concentration or function without direct comparisons to absolute values among the variables measured. Note that a substantial amount of cadmium is concentrated in the placenta (as noted in figure 9; which is greater than that noted for the mother's kidney). Further the sequence of events demonstrate that the placenta is affected early as noted by ultrastructural and mitochondrial effects leading to necrosis and fetal death.

This figure summarizes observations reported by Levin and Miller 1980, 1981; Levin et al. 1981, 1983, 1986; and Miller et al. 1983. (Miller and Kellogg 1985).

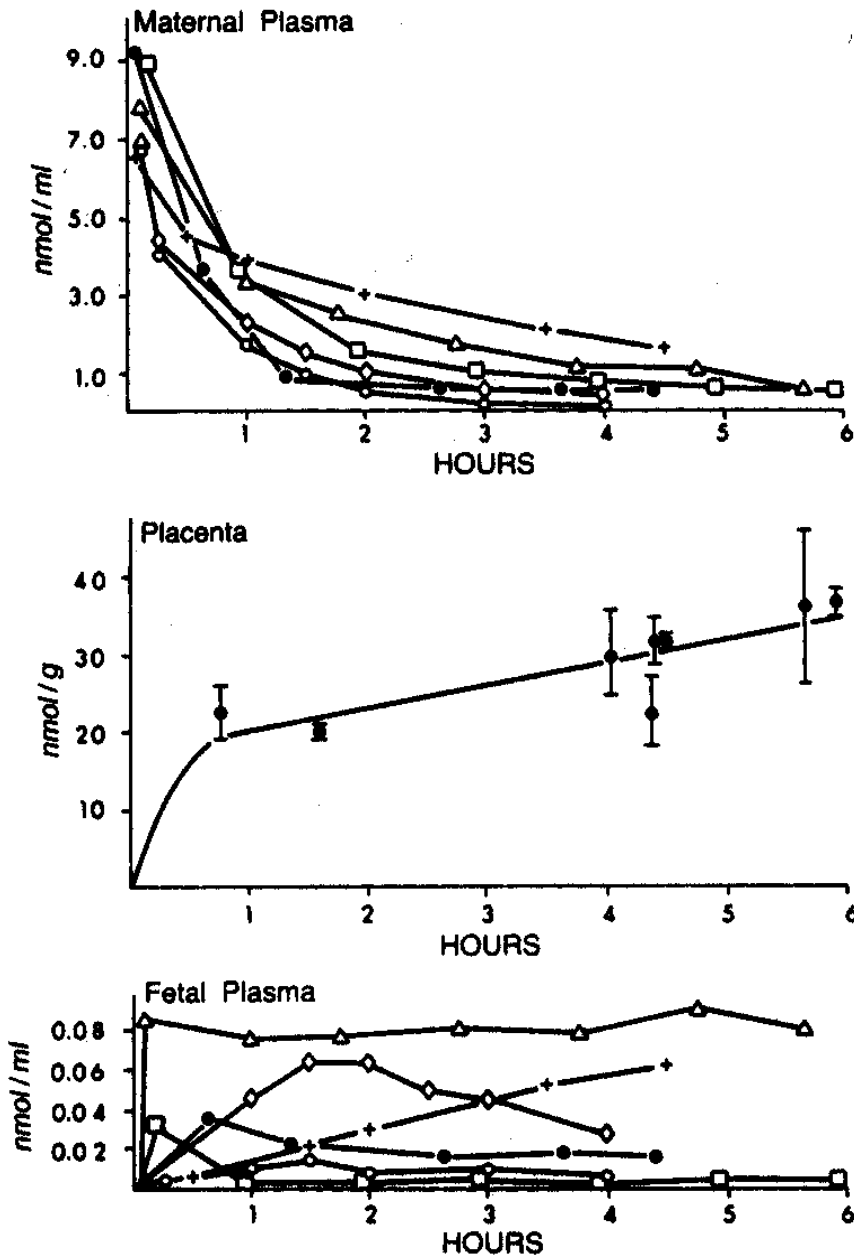

Figure 3-10. Cadmium concentrations in maternal, placental and fetal compartments during 6 hours of dual human placental perfusion. Cadmium was added to the maternal circulation only at 0 hr of perfusion. Placental levels of cadmium (mean \pm sd) were measured at the end of the perfusions lasting 0.75 to 5.9 hours. The average detection limit for cadmium in the fetal perfusate was 0.03 nmol Cd/mL. Note in particular that cadmium levels in the placenta are rapidly rising and demonstrate toxicity at these doses. These placental levels are *less than* those noted for renal toxicity and reported for Itai-Itai disease (See

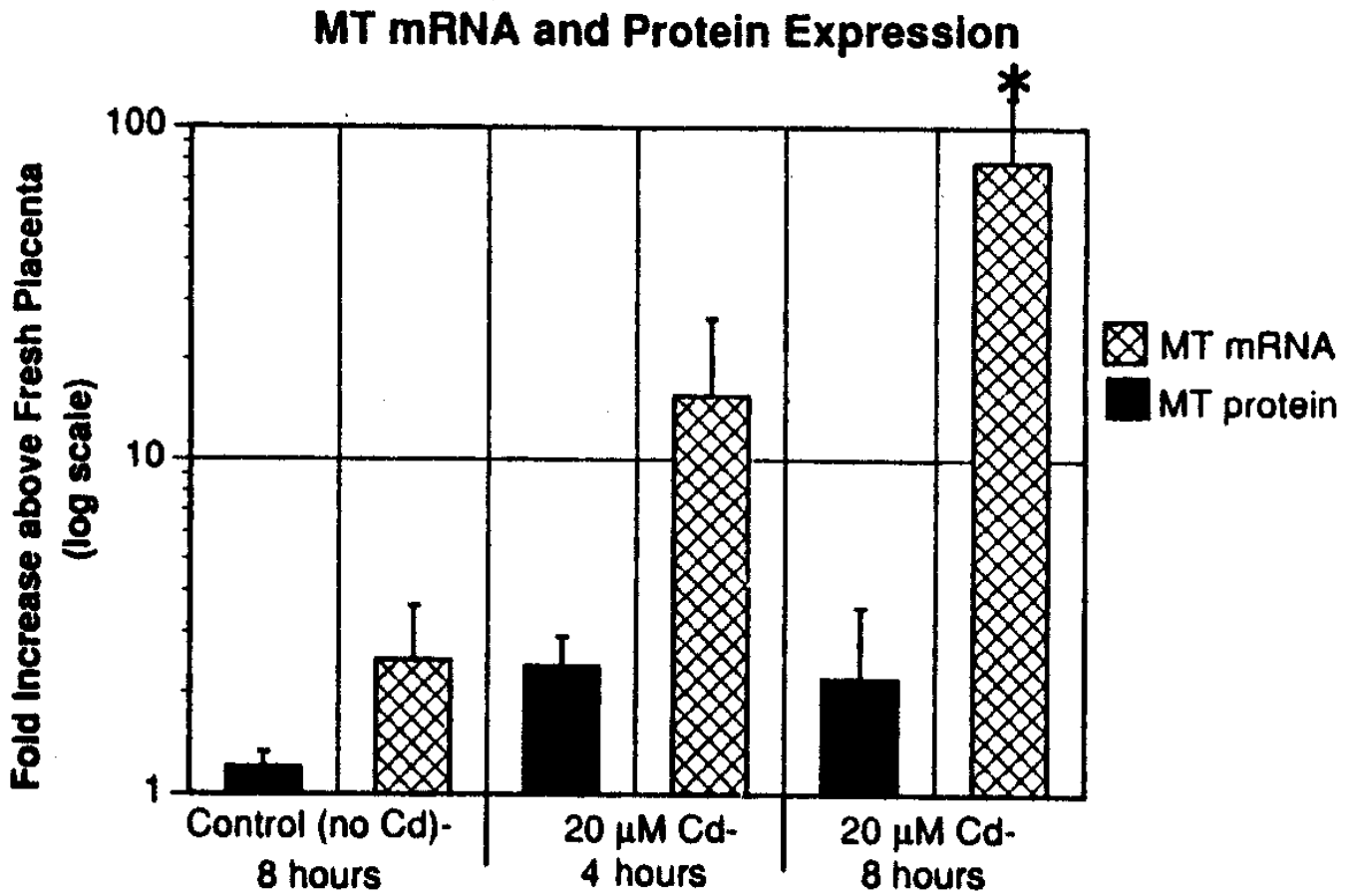
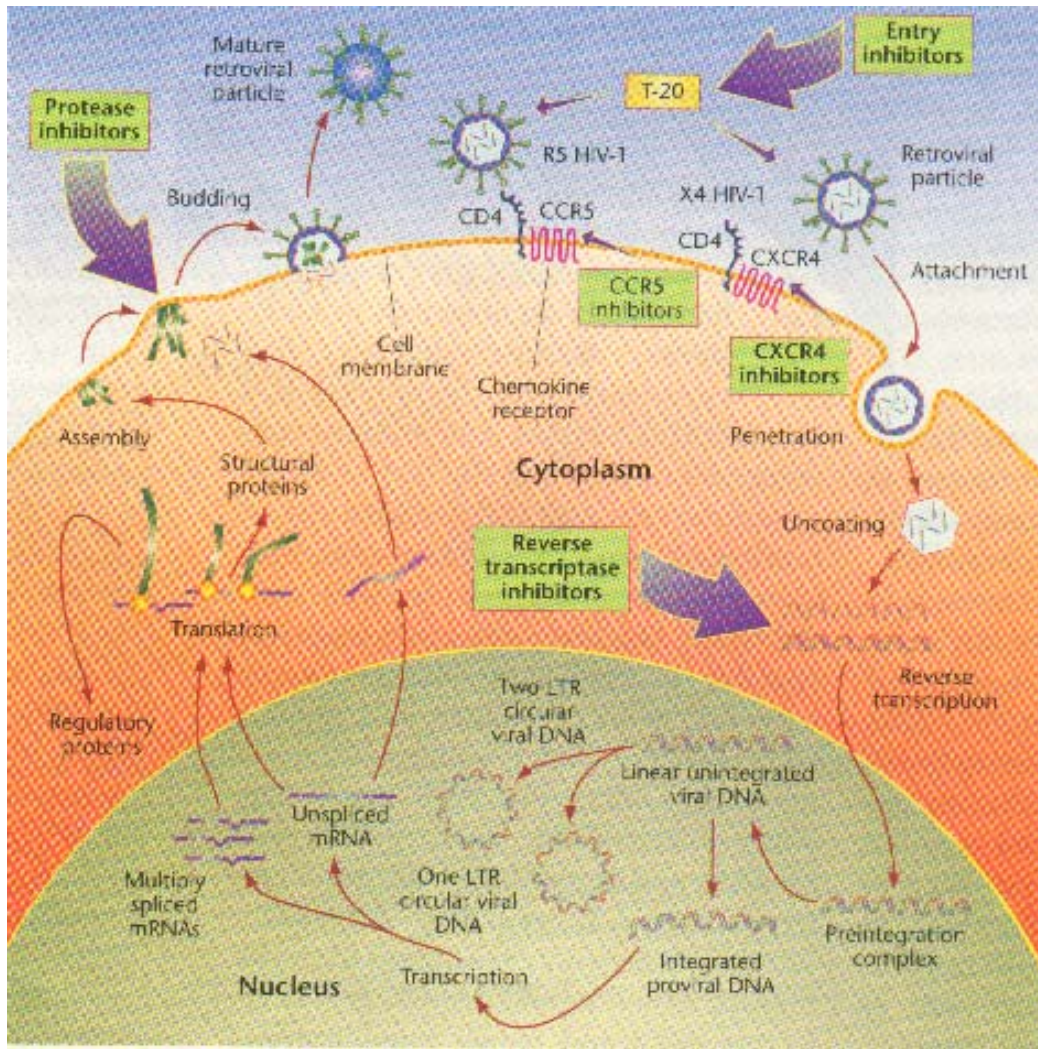

Table 3-6). Also these placental levels for the human are similar to those noted in the pregnant rat (Figure 3-9). (Wier and Miller 1987)

Figure 3-11. MT mRNA and protein expression. (Breen et al. 1994a)



13

Figure 3-12. The life cycle of HIV-1 and possible sites for anti-HIV action of agents. Of particular interest are the cell surface chemokine receptors (CCR5 and CXCR4) and CD4. Note that anti-HIV therapies are listed (e.g., Entry inhibitors, protease inhibitors, reverse transcriptase inhibitors) and have specific actions. A protease inhibitor, saquinavir, will be discussed in the multidrug transporter subsection of Issue Area 3 (see also Table 3-10). (Michael and Moore, 1999).

4.0 ISSUE AREA 4: TRANSFER FROM PLASMA TO MILK

4.1 INTRODUCTION

Breast-feeding is beneficial to both the mother and her infant (Barrett 2001). In addition to its psychological advantages, breast-feeding provides the infant with appropriate nutrition for growth and development, supplies immune factors that prevent common infections, and reduces the risk of several adverse infant conditions (see Table 4-1). Benefits received by the breast-feeding mother include decreased postpartum bleeding, a quicker return to pre-pregnancy weight, and a potentially decreased risk of ovarian and breast cancers (Barrett 2001). However, one apparent benefit to the lactating mother, depuration brought about by the mobilizing of persistent lipid-soluble chemicals and their excretion in breast milk (Jensen 1983, LaKind et al. 2001), represents a disadvantage to the nursing infant. Although in most cases the other benefits of breast-feeding outweigh the infant's risk of low-level chemical exposure (Grandjean et al. 1995), virtually all chemicals and drugs that are administered to lactating mothers, sometimes in high doses, are excreted to some extent in breast milk and thus consumed by a suckling infant (Kacew 1994). The potential adverse effects of drugs and environmental chemicals present in breast milk were described by Kacew (1993, 1996a, 1996b, 1997).

In the United States, interest in breast-feeding as the source of ideal nourishment for infants has been increasing since the 1970s. In 1975, 28 percent of mothers were breast-feeding at the time of discharge from the hospital, while in 1978 the incidence was 48 percent (Berlin 1981). Since 1985, over half of mothers are nursing in the initial weeks of the infant's life (Anderson 1991), however, in any given year the percentage of breast-feeding mothers decreases exponentially from the date of birth. For example, according to the data analyzed by Maxwell and Burmaster (1993) for the period 1985-1989, the percentage of mothers breast-feeding their infants decreased from a rate of 52-58 percent at the time of discharge from the hospital, to 18-22 percent 6 months later, to 6-7 percent at 12 months. Socioeconomic and other demographic factors, such as ethnic background, marital status, maternal age, education, income, and geographic region, also significantly influence the percentage of mothers who initiate breast-feeding or continue it for 5 to 6 months (EPA 1997).

4.2 CHEMICALS TRANSFERRED TO BREAST MILK

A literature review conducted by Cone et al. (1983) for the EPA revealed that many chemical compounds may be transferred to breast milk. Most of these chemicals were either environmental pollutants or drugs. An extensive, alphabetized list of occupational chemicals and drugs detected or excreted in human milk (about 150 compounds) has been compiled by Giroux et al. (1992). Also, a review paper by Byczkowski et al. (1994) focused on occupational chemicals and materials used in the workplace.

Lactational transfer of many drugs has been reviewed by White and White (1980), Riordan and Riordan (1984), and the American Academy of Pediatrics Committee on Drugs (1989). Hussein and Mohamed (1999) evaluated a comprehensive list of 1,380 drugs for their compatibility with breast-feeding.

Table 4-2 presents chemical information relevant to lactational transfer from the list of occupational and environmental chemicals published on the Web site “Drugs and Toxic Chemicals in Breast Milk” (Byczkowski 1997). Although the data provided in the table are qualitative, the solubility characteristics may aid in estimating chemical intake by infants at the threshold limit value for maternal occupational exposure.

4.3 LACTATIONAL TRANSFER PATHWAY

Each female human breast contains 15 to 25 lobes, or glands, that are arranged like wheel spokes and subdivided into lobules. The mammary gland is a blend of glandular tissue embedded in supporting and connective tissue. The glandular tissue is composed of ductal, lobular, and alveolar structures. Each lobule, which is subdivided into 10 to 100 alveoli (small sac-like dilations), drains into a lactiferous duct. The ducts are larger than the lobules and are imbedded in fibrous connective tissue and fat. Each duct dilates into a lactiferous sinus upon reaching the nipple, on which the lactiferous ducts open (Bloom and Fawcett 1975).

The mammary glands are rapidly perfused. The mammary blood supply receives 60 percent of its blood from the internal mammary artery, 30 percent from the lateral thoracic artery, and the remainder from minor arteries (Vorherr 1974). Perforating branches of the thoracic arteries transversely lead to the nipple, while some branches of the internal mammary artery may reach the opposite breast. The veins of the gland follow the same arterial distribution pattern. Mammary blood vessels are very sensitive to vasoconstrictors and sympathetic stimulation (e.g., stress). Stress effects on blood flow are independent of any action on the milk ejection reflex (Wilson et al. 1980).

The nerves of the breast are abundant fibers that reach the skin, the smooth muscle of the areola and nipple, the blood vessels, and the glandular tissue (Vorherr 1974). Free sensory fiber endings are found in the skin of the peripheral part of the breast, the areola, and the nipple.

The lymphatic drainage begins with capillary networks located in the connective tissue layers, surrounding the separate alveoli (Bloom and Fawcett 1975). Several lymphatic capillaries unite to form larger lymphatic vessels. These vessels empty into lymph nodes that are collections of resident lymphocytes held together by connective tissue.

4.3.1 Milk Synthesis and Release

The secretory portions of the gland are contained in the alveolar ducts and alveoli. A selective blood-milk barrier exists for the mammary ducts of most species (Wilson et al. 1980). The ducts consist of a two-cell-layer epithelium (see Figure 4-1). Three different cell types have been described for the alveolar epithelium: superficial cells, basal cells, and myoepithelial cells (Larson 1978). In the superficial cells, protein synthesis takes place using energy provided by the basal cells. Highly branched myoepithelial cells enclose the alveoli in a loosely meshed, basket-like network. Stimulated by the sucking of the infant, the myoepithelial cells contract, forcibly pushing the milk from the alveoli and milk ducts into the lactiferous ducts contained in the nipple (Bloom and Fawcett 1975). The first milk that comes from the breasts after birth is called the colostrum, which has laxative properties and contains antibodies (Larson 1978). The process of milk synthesis is fully established 2 to 5 days after birth. The period of colostrum secretion lasts about 1 week, followed by a transitional period of 1-2 weeks during which production of mature milk begins to occur. During this period, concentrations of lactose, fat, and water-soluble vitamins in milk increase, and concentrations of proteins decrease (Vorherr 1974).

A hormone, prolactin, regulates milk synthesis and milk release. Prolactin secretion is susceptible to modification by drugs and other hormones (Wilson et al. 1980). During pregnancy, estrogens and progesterone stimulate prolactin secretion, mostly at the end of gestation. The breasts greatly enlarge with the formation of new glandular tissue. During the last trimester of pregnancy, an accumulation of fat droplets, along with other secretory products, increases in the alveolar epithelial cells. Formation of colostrum also occurs during this period. As a result of the accumulation of secreting products, cells assume a cylindrical shape containing a nucleus and increased amounts of ribosomes, rough endoplasmic reticula, and enlarged Golgi apparatus between the nucleus and the apex of the cell (Vorherr 1974).

Water and protein secretion in breast milk are mainly the product of a *merocrine* mechanism, a process in which the cells are undamaged by the secretion. To a lesser extent, an *apocrine* secretion takes place when fat droplets and portions of the apically located Golgi complex are pinched off from the cytoplasm (Vorherr 1974). Milk production also may involve a *holocrine* process, in which the disintegrated secretory cells are part of the glandular output. Essentially, secreted milk is a mixture of proteins (in mature human milk, 0.8-0.9 percent), fat (2.1-4.0 percent), lactose (6.9-7.2 percent), and mineral salts with a pH around 7.0 (on average, 7.08 for mature human milk) (Wilson et al. 1980).

Significant species differences exist in fat content and composition of milk, and within one species interindividual variations depend mainly on diet, nutritional status, and age of the nursing pup or infant. In human breast milk, the average fat content varies with the age of infant; in the United States it varies between 3.6 and 3.2 percent (EPA 1997). Maxwell and Burmaster (1993) analyzed data on breast milk fat content and milk intake for infants at 3, 6, 9, and 12 months of age. Their analysis showed that milk fat intake among the nursing infants under 1 year of age is normally distributed around the arithmetic mean of 26.8 g/day per infant (standard deviation \pm 7.4 g/day).

The milk ejection reflex is governed by the hormone oxytocin. Oxytocin released under the stimulus of sucking causes contraction of the myoepithelial cells surrounding the alveoli, resulting in milk ejection. Milk is ejected from alveolar and smaller milk ducts into the larger lactiferous ducts and sinuses from which it can be removed by sucking. Lactation can be maintained for many months or even for several years if sucking is permitted. However, if milk is not removed, the glands become greatly distended and milk production quickly ceases. This is in part due to interruption of the neurohormonal reflex mechanism for maintenance of prolactin secretion, but the engorgement of the breasts may also compress the blood vessels, resulting in diminished access of oxytocin to the myoepithelial cells. After a few days the secretion remaining in the alveolar spaces and ducts is reabsorbed, and the glandular elements gradually return to the resting state (Bloom and Fawcett 1975).

4.3.2 Mechanisms of Lactational Transfer of Chemicals

Many chemicals can be transferred from the body stores and/or from the blood into the breast milk of a lactating mother, and in this way expose a suckling infant to chemicals that may pose a health hazard (Wolff 1983). Furthermore, when the mother is exposed to high concentrations of some chemicals, there is a risk of an adverse effect on the lactation process itself as well as on the content of nutrients in the milk (Jensen and Slorach 1991). On the other hand, attempting to protect the newborn from toxic chemicals contained in breast milk by not breast-feeding must be balanced against the resulting loss of the benefits of breast-feeding. This choice must be weighted against the risk of exposure to the potentially detrimental effects of toxicants (White and White 1980). Thus, understanding the mechanism of lactational transfer of chemicals and quantifying the process are crucial to exposure and risk assessments of children.

The transit path of a chemical from blood to breast milk is shown schematically in Figure 4-1 (Wilson et al. 1980). Since many different drugs or chemicals may undergo lactational transfer that involves different mechanisms, the process is not necessarily a simple diffusion but may be complex, and depends on a number of factors related to the mother, the milk itself, and the infant. Thus, transport of chemicals from blood to breast milk can occur by passive diffusion, active transport, or apocrine secretion (reversed pinocytosis).

Passive diffusion is the natural tendency of molecules to move down a concentration gradient. The net chemical mass transfer (flux) in passive diffusion occurs until equilibrium is reached, that is, a steady-state condition exists in which the concentrations of the diffusing chemical are the same in the aqueous phases on both sides of the membrane (milk and blood plasma). At steady state, the exchange of drug molecules between regions still continues but the net flux is zero.

Active transport involves participation of cellular “pumps” of the membrane in the transfer of drug or chemical molecules. This type of transport mechanism is associated with moving molecules against the concentration gradient, from a region of low concentration to a region of high concentration,

without an equilibrium state being reached as in the passive process (Harvey and Champe 1992). Active transport is generally a one-way process in which energy is expended by the work involved in carrying the drug molecules across membranes.

Apocrine secretion is a process in which larger drug or chemical molecules and proteins may be transported actively into the alveolar cell by pinocytosis and released into the milk by. Some drugs may also enter directly into milk via spaces between alveolar cells (Wilson 1981). These drugs bypass the alveolar structures completely by going from capillary to interstitial space to intercellular cleft and hence directly into milk (see Figure 4-1). This pathway is not very common in most species due to the very tight intracellular structures.

For most un-ionized chemicals, the lactational transfer from blood may be adequately described in terms of a perfusion-limited passive diffusion through the membranes (Rasmussen 1971); however, for some chemicals the diffusion itself may represent a limiting process.

4.3.3 Physicochemical Factors Affecting Lactational Transfer of Chemicals

The passage of chemicals across a biological membrane involves two events: (1) partitioning into, and then out of, the membrane, determined mainly by the partition coefficient, and (2) diffusion within the membrane, determined mainly by molecular weight (Atkinson and Begg 1990). However, due to the pH difference between blood plasma and milk, the electrochemical gradient forms a transmembrane potential across the blood-milk barrier. As a result, bases are often “trapped” in more acidic milk. Conversely, since the plasma proteins have higher affinity and capacity to bind drugs and other chemicals than milk proteins do, some drugs may be “trapped” in blood plasma (Wilson et al. 1980). Therefore, the physicochemical factors that determine the rate of passage of drugs into milk include (1) lipid (or octanol):water partition coefficient, (2) molecular weight, (3) degree of ionization, and (4) maternal plasma protein binding (George and O’Toole 1983; Anderson 1991; Vorherr 1974; Berlin 1981, 1986; Pons et al. 1994).

4.3.3.1 Lipid:Water or Octanol:Water Partition Coefficients

Lipid-soluble chemicals and drugs tend to easily penetrate lipid membranes, whereas water-soluble drugs have to move through the narrow channels between cells (see Figure 4-1). Thus, drugs partition into milk in accordance with their lipophilicity. The readily available indices of lipophilicity are oil:water and octanol:water partition coefficients (Begg and Atkinson 1991). Unlike plasma, milk contains emulsified fat, ranging on average from 3.2 to 3.6 percent in humans (EPA 1997). Milk fat can concentrate lipid-soluble drugs, in some instances producing higher levels in milk than in plasma (Anderson 1991). The lipid content of milk varies considerably within a single feeding of the infant, between feedings, and among individuals. During each feeding, the lipid content of milk varies, with less fat in the beginning and higher quantities of

fat toward the end of the feeding. Consequently, drugs that are lipid soluble may be ingested by the infant in different quantities over the length of each feeding (Wilson 1981, Wilson et al. 1986).

4.3.3.2 *Molecular Weight of Chemical Compounds*

Molecular weight is important because chemical compounds with a molecular weight greater than 200 have difficulty crossing cell membranes (Berlin 1981, 1986; Pons et al. 1994). However, under certain circumstances, large molecules and even whole virus particles can be transferred into milk (Frederick et al. 1986, Minamishima et al. 1994, Black 1996). In general, the smaller the molecule, the easier its transfer through the water-filled pores and channels of the lipid barrier of the alveolar cell (Pecorari 1984, Rasmussen 1973).

4.3.3.3 *Degree of Ionization*

The degree of ionization has been extensively studied as a major factor in the passage of drugs and other chemicals into milk (Berlin 1981, 1986; Pecorari 1984; Wilson et al. 1980; Wilson 1981). Many drugs are either weak acids or weak bases and exist in solution in equilibrium between un-ionized and ionized forms (Harvey and Champe 1992). Acidic drugs (HA) dissociate, releasing a H^+ and an anion A^- :

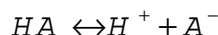

On the other hand, weak bases (B) can accept protons (H^+); however, the protonated form of basic drugs is usually charged (BH^+):

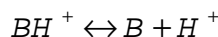

A drug tends to pass through membranes if it is uncharged (Harvey and Champe 1992, Berlin 1986, Pons et al. 1994). Thus, for a weak acid, the uncharged HA can pass through membranes, and A^- cannot. For a weak base, the uncharged form, B, penetrates through the cell membrane, and BH^+ does not. Therefore, the relative concentrations of the charged and uncharged forms determine the overall concentration of the drug in milk. The ratio between the two forms is determined by the pH of the medium and by the dissociation constant of the weak acid or base, pK_a (Harvey and Champe 1992). The pK_a is the measure of the strength of the interaction of a compound with a proton, providing a numerical way to compare the relative acidity or basicity of weakly ionizing compounds in aqueous solutions (Newton and Kluza 1978). The lower the pK_a , the stronger the acid.

The degree of ionization, and hence the percentage of un-ionized drug available to cross the membrane, may be calculated based on the Henderson-Hasselbalch equation (Wilson et al. 1980):

(1)

$$\text{Acids: } \lg \frac{U}{I} = pK_a - pH$$

$$\text{Bases: } \lg \frac{I}{U} = pK_a - pH$$

where U is the concentration of un-ionized drug and I is the concentration of ionized drug. Note that the drug concentration refers to the ultrafiltrate of milk and plasma, i.e., without lipid and protein. As milk contains lipids and the protein-bound fraction of drugs cannot penetrate biological membranes, the ratio of total drug concentration may be determined experimentally in the ultrafiltrates of the two fluids. The pH of milk is more acidic (pH of 7.0) when compared to plasma (pH of 7.4). Hence, the ratio of the concentration of drug in milk and plasma can be predicted based on these pH values, steady-state conditions, and the rearrangement of the two previous equations (Rasmussen 1973, Wilson 1981, Atkinson and Begg 1990):

$$\begin{aligned} \text{Acids : } \frac{M}{P} &= \frac{1+10^{(pH_m - pKa)}}{1+10^{(pH_p - pKa)}} \\ \text{Bases : } \frac{M}{P} &= \frac{1+10^{(pKa - pH_m)}}{1+10^{(pKa - pH_p)}} \end{aligned} \quad (2)$$

where M/P is the milk-to-plasma concentration ratio, pH_m = pH of milk, and pH_p = pH of plasma. The M/P ratio is greater than 1 for basic drugs and less than 1 for acidic drugs (George and O'Toole 1983, Wilson 1981, Begg and Atkinson 1991, Meskin and Lien 1985). As stated earlier, breast milk is more acidic than plasma; therefore drugs that typically pass readily into milk are weak bases that are lipid soluble and do not bind significantly to protein.

4.3.3.4 Maternal Plasma Protein Binding

The binding of drugs and other chemicals to plasma and milk proteins can influence the rate of passage of drugs into the alveolar lumen. By binding to proteins, drugs become trapped, and thus are unavailable for lactational transfer.

Essentially, only unbound free drug molecules diffuse into breast milk regardless of its other physicochemical characteristics (Reinhardt and Richter 1984). Both plasma and milk contain various proteins, but none of the major proteins in milk bind drugs and other chemicals well (Atkinson and Begg 1988, Anderson 1991). The total plasma protein concentration is approximately 75 g/L of protein, whereas milk contains approximately 9 g/L of protein (Atkinson and Begg 1990, Anderson 1991). Of the plasma proteins, 45 g/L is albumin, a major drug-binding protein; however, its concentration in milk is only 0.4 g/L. The major proteins in milk are casein, α -lactalbumin, lactoferrin, and immunoglobulin A, and virtually all the binding of drugs in milk is to albumin and lactoferrin (Begg and Atkinson 1991).

4.3.4 Classification of Typical Breast Milk Contaminants According to Their Solubility

Common chemical contaminants in breast milk may generally can be grouped into three major categories (EPA 1998):

1. Persistent, highly lipophilic organic chemical contaminants, such as polychlorinated biphenyls (PCBs), polychlorinated dibenzofurans (PCDFs), and polychlorinated dibenzo-*p*-dioxins (PCDDs). These chemicals, by virtue of their lipophilicity, are found almost entirely in the milk fat.
2. Organic chemical compounds with relatively low octanol:water partition coefficients such as phenol, benzene, halobenzenes, halophenols, some aldehydes and the more polar congeners and metabolites of PCBs, polyaromatic hydrocarbons (PAHs), and some pesticides. These chemicals may occur in both the aqueous and lipid phases of breast milk.
3. Inorganic chemical compounds, metals, and some organometallics, including the heavy metals (e.g., lead, cadmium, mercury). Trace nutrients such as copper, iron, and zinc may be present at elevated levels if maternal contamination is high. These inorganic chemicals are generally found in the aqueous phase and are mostly bound to proteins, small polypeptides, and free amino acids. Some organometallic compounds and metalloids (e.g., arsenic and selenium) may also be found in the lipid phase.

Table 4-3 presents examples of typical organic contaminants of human milk, with their respective water solubilities and \log_{10} octanol/water partition coefficient ($\text{Log } K_{ow}$) values listed, to aid in assessing their relative solubility in the aqueous or fat phase of breast milk. Identification of some PCB congeners in breast milk is complicated by coelution in the fractionation process. For example, PCB-70 has been reported at concentrations of 1.7 ng/g, but PCB-74, which nearly coelutes with PCB-70, is equally likely to be present and has been found to be prevalent in human samples. Considering the coelution phenonena, whole milk concentrations, and milk/blood ratios for the major PCB congeners (52 percent of total PCBs; Bush et al. 1985), PCB congeners' typical composition in breast milk is probably best represented by the values in Table 4-4.

Lactation may be an efficient way to excrete the maternal body burden of persistent, highly fat soluble chemical pollutants (Fürst et al. 1994). Schechter et al. (1998) analyzed blood and milk from a mother who nursed twins over a 38-month period. In this study, blood and milk samples were taken each month starting in February 1993 (the woman gave birth on December 15, 1992) and ending in September 1995. Overall, PCDD levels in the mother's milk decreased from 309 ppt to 173 ppt, PCDF levels dropped from 21 ppt to 9 ppt, and total coplanar PCB levels decreased from 151 to 21 ppt during that time. Schechter et al. estimated that the mother reduced her dioxin body burden from 310 to 96 ng $\text{TEQ}_{DFP-WHO_{98}}$, or approximately 69 percent, during that period. Overall, the PCDD/PCDF/PCB concentrations in the maternal whole blood dropped from 698 ppt to 262 ppt in lipids during that period. The twins' consumption of PCDD/PCDF and coplanar PCBs from breast-feeding was estimated to be approximately

115 ng TEQ_{DFP}-WHO₉₈ per twin. In addition, drugs and alcohol may increase the level of fat-soluble chemicals in milk (EPA 1998). One possible explanation for this phenomenon may be the direct effect of ethanol on oxytocin release; the oxytocin release decreases the release of milk and increases the lipid content, which would favor higher concentrations of lipophilic compounds (Neville and Walsh 1995).

4.4 MATERNAL PHARMACOKINETIC PARAMETERS

In order to assess possible health effects in the infant and estimate risk from lactational transfer of drugs and other chemicals, first the maternal plasma drug concentration needs to be established. This information is needed to estimate the drug concentration in breast milk, and ultimately, to characterize the exposure of the nursing infant. The assessment has to take into account various pharmacokinetic variables in the mother, including dose, bioavailability, clearance, distribution, and time post-administration of drug (see Figure 4-2). The figure shows schematically the essential factors that modulate the plasma concentration of drug in the infant: (1) *maternal factors*, such as the dose or dosing rate of the drug that is being administered, time of breast-feeding, compliance with the prescribed schedule, and the pharmacokinetics of the drug in the mother; (2) *lactational factors*, which are determined largely by the drug's physicochemical properties, the perfusion rate of the mammary glands, the differential milk/plasma pH, the degree of protein binding, and the volume of milk; and (3) *infant's factors*, which mainly comprise the dosage rate, bioavailability, and pharmacokinetics of the drug in the infant (Rane and Wilson 1976; Wilson et al. 1980, 1985).

In order to assess possible health effects in the infant and estimate risk from lactational transfer of drugs and other chemicals, first the maternal plasma drug concentration needs to be established. This information is needed to estimate the drug concentration in breast milk, and ultimately, to characterize the exposure of the nursing infant. The assessment has to take into account various pharmacokinetic variables in the mother, including dose, bioavailability, clearance, distribution, and time post-administration of drug (see Figure 4-2). The figure shows schematically the essential factors that modulate the plasma concentration of drug in the infant: (1) *maternal factors*, such as the dose or dosing rate of the drug that is being administered, time of feeding, compliance with the prescribed schedule, and the pharmacokinetics of the drug in the mother; (2) *lactational factors*, which are determined largely by the drug's physicochemical properties, the perfusion rate of the mammary glands, the differential milk/plasma pH, the degree of protein binding, and the volume of milk; and (3) *infant factors*, which mainly comprise the dosage rate, bioavailability, and pharmacokinetics of the drug in the infant (Rane and Wilson 1976; Wilson et al. 1980, 1985).

4.4.1 Body Weight

Most maternal physiological and pharmacokinetic parameters, including intake and dose estimates, are normalized over body weight so they can be expressed in a manner that is consistent with dose-response relationships. A body weight of 70 kg has been used traditionally by EPA to represent

average adult body weight. However, according to the data analyzed by Burmaster (1998) for lactating women in the United States, the average body weight is 63.5 kg (versus 62 kg in a control group of nonpregnant, nonlactating American women).

4.4.2. Water Consumption Rate

To compensate for a loss of fluids during lactation, nursing mothers have a greater water ingestion rate than average individuals. The U.S. EPA has traditionally used a value of 2 L/day to represent the average daily water consumption of adults. A value of 2 L/day most likely represents a 90th percentile value for tap water consumption by U.S. adults (U.S. EPA 1997a). Burmaster (1998) analyzed the available data for water intake by pregnant and lactating women in the United States and determined that lactating women ingest more water than do pregnant and control women. On average, lactating women consumed 2.2 L/day totally, including 1.3 L/day of tap water. However, the distributions of tap water intake were lognormally distributed, and the standard U.S. EPA “default” of 2 L/day fell at the 86th percentile of the fitted distribution for tap water ingestion.

4.4.3 Milk Yield

Milk yield depends largely on the blood flow to the breasts. During the lactation period, about 10 percent of the blood flow through the richly perfused tissues is diverted to the breasts, and under normal circumstances, for each 400--500 mL of blood passing through the breasts, about 1 mL of milk is being produced (Wilson et al. 1980). While, in general, the milk yield increases with increasing intake by the infant (see Issue Area 2, Section 4.6.1), a marked interindividual variability exists in milk yield; and in humans, it is affected by many exogenous factors: physical, mechanical, physiological, psychological, hormonal, and iatrogenic (Table 4-5). Even though typically, in an adequately nourished mother, the milk yield exceeds the infant's intake (for an estimate of the amount remaining, see Issue Area 2, Section A.2.5 eq. 10), for quantitative modeling it is usually assumed that the milk yield equals the milk intake rate that can be approximated from the appropriate growth curve (see Issue Area 2, Section A.2.5 eq. 11).

For different species, a correlation exists between the body weight of the lactating mother and the daily volume of milk. Figure 4-3 shows the milk yield as a function of body weight for different species. In humans, a semiempirical regression algorithm (see Issue Area 2, Section A.2.5) proposed by O'Flaherty (1991) adequately described milk output when calibrated with appropriate data from Neville et al. (1988), which had been collected from mothers in the United States.

4.5 LACTATIONAL FACTORS

Breastmilk is a normal and ideal food for infants because it contains all the nutrients that a baby needs for first 6 months of life. It is quickly and easily digested by the nursing infant but also may be a source of drugs and other chemicals passed on by the exposed mother. When lactating mother was or still

is exposed to drugs and other chemicals, breast milk provides a convenient, biologically relevant source of biomarkers or bioindicators of exposure, especially to lipophilic chemicals. Both chemical and cellular constituents of milk may reflect exposure to such environmental toxins, particularly TCDD and dioxin-like compounds (Diehl-Jones and Bols 2000).

The lactational factors that should be considered in assessment of infant's exposure, include milk composition, milk-to-plasma ratio, and time for equilibration of unbound chemical between plasma and milk (Buttar 1994, Berlin and Kacew 1997). However, the composition of human milk varies with the age of infant, stage of lactation, the time of day, the sampling time during a given day's feeding, maternal nutrition, maternal exposure to drugs and other chemicals and individual variation. Breastmilk at different stages of lactation is defined by different terms, namely: *Preterm* milk, *colostrum*, *transition* milk, *mature* milk, *foremilk*, *hindmilk* that differ in their composition (Schreiber 1997).

Mothers who deliver preterm infants (prematurely born at less than 37 weeks gestation) make breast milk that is different from normal (*term*), mature milk. This difference lasts approximately 4 weeks. By the time the preterm infant is 4 weeks old the composition of the maternal breast milk approaches that of normal milk. The *preterm* milk has more protein; minerals, immunoglobulins and lactoferrin than mature milk, making it more suited for the needs of a preterm baby. This milk is essential and best suited for the survival and growth of a preterm baby. The higher proteins content suits the fast growing needs of a premature baby. The preterm milk is ideal food for these low birth weight babies.

The composition of milk changes according to the gestational age or maturity of the baby. So the milk produced by a woman who has a full term delivery (*term milk*) varies in composition to the milk produced by a woman who has a premature delivery.

During the first 5 days after the normal (*term*) delivery a woman produces special milk that is thick, sticky and yellowish or clear in color. This special milk is called *colostrum* (Bailey and Ito 1997). Colostrum contains large quantities of protective substances and growth factors and has more protein and Vitamins A and K than mature milk. It enhances the development and maturation of the baby's gastrointestinal tract. The immunoglobulins and white cells provide the first immunization against the diseases that a baby encounters after delivery. Although colostrum is secreted in small quantities (30-90 mL), it is sufficient to meet the caloric needs of a normal newborn in the first few days of life. Colostrum also has a mild laxative effect, which helps to clear baby's gut of meconium (the first, very dark stools) and helps to prevent jaundice by clearing the bilirubin from the gut. It stimulates the baby's immature intestine to develop in order to digest and absorb milk and to prevent the absorption of undigested protein.

Transition milk (days 6 to 10), and mature milk have notable differences in their composition. During the two weeks that follow the colostrum stage, the milk increases in quantity and changes in appearance and composition. The immunoglobulins and protein contents decrease while fat and sugar contents increase. At this time, the breasts feel full, hard and heavy.

Mature milk increases in quantity and contains all the nutrients needed for healthy physical and mental development of the baby even though it appears thinner, more watery than even cow's milk. Mature milk changes even during the length of a single feed to exactly suit the needs of a baby.

The milk that comes at the start of a feed is called *foremilk*. Foremilk, which is watery and bluish in color, has a low level of fat and is high in lactose, sugar, protein, vitamins, minerals and water. It satisfies the baby's thirst and is produced in larger amounts than hindmilk. It is important for a baby to have foremilk and hindmilk to get a complete meal and all the water that the baby needs.

Hindmilk, which comes later in a feed, is richer in fat and this extra fat makes it look whiter than foremilk. It satisfies the baby's hunger and supplies much of the energy of a breast-feed. There is, no sudden change from foremilk to hindmilk. The fat content increases gradually from the beginning to the end of a feeding.

4.5.1 Milk-to-Plasma Ratio

The milk-to-plasma (M/P) ratio is commonly used to express the relative concentration of a chemical in milk compared to its concentration in maternal plasma (Ito and Koren 1994, Wilson et al. 1980). In an examination of individual drugs, those with a low M/P ratio are likely to cause fewer dose-related adverse effects in the infant (because the concentration in the milk is low) than those with a high M/P ratio.

The M/P ratio has some obvious limitations because concentrations can vary over time and because, as an infant develops, its capacity to handle drugs changes (Wilson et al. 1985). Nevertheless, the M/P ratio can be helpful in estimating a nursing infant's drug consumption. Most therapeutic drugs have an M/P ratio of considerably less than 1.0; however, this is not the case for most chemicals that are environmental contaminants. Persistent environmental contaminants are chemicals that are found in the environment by virtue of their manufacture, use, and distribution by people. Contaminants such as DDT, chlorobenzenes, benzo(a)pyrene, and PCBs are organic molecules with little ionization potential, poor water solubility, and a high degree of lipophilicity (Table 4-3). These factors combine to result in M/P ratios that approach and exceed 1.0 (Berlin and Kacew 1997, Schreiber 1997).

4.5.2 Milk Fat to Body Fat Ratio

Several authors in the reviewed literature assumed that partitioning of lipophilic chemicals to milk fat and adipose tissue should be equal at steady state. For example, for humans, Eyster et al. (1983) reported a milk fat to body fat ratio for polybrominated biphenyl (PBB) of 0.98, and Jan (1983) reported values of 0.96 for hexachlorobenzene (HCB) and 0.91 for hexachloroheptane, all near unity. On the basis of this assumption, some authors constructed pharmacokinetic models of lactational transfer, in which milk fat was considered to be a part of body fat equally equilibrated with a chemical compound

(Schreiber 1992). However, Travis et al. (1988) reported that in humans the milk fat to body fat ratio for some chemicals may be as high as 3.0. Indeed, Laben et al. (1966) reported that the concentrations of DDT in milk fat exceeded those in body fat between 1.7 and 3.3 times. Also, Travis and Arms (1988) estimated that, in dairy cows, some chemicals' concentrations in milk fat may be as much as 21.5 times greater than concentrations in body fat.

4.6 INFANT PHARMACOKINETIC FACTORS AND PATTERNS

The exposure of the nursing infant to lactationally transferred drugs or other chemicals depends on a number of general factors, including the amount of ingested milk, bioavailability of the compound from milk, clearance of chemical from the infant, tissue partitioning, and volume of distribution. The governing pharmacokinetic factors are described in the previous sections (Issue Areas 1 and 2). These factors will, in essence, determine the observed manifestation of a chemical's toxic effects in the infant. Also, equal amounts of chemicals in suckling infants do not necessarily produce equivalent effects, a fact that necessitates consideration of individual factors, such as receptor sensitivity in infants (Kacew 1992). The infant's sucking pattern affects its level of exposure to drugs in milk. The relation of the time of feeding to maternal dosing is an important factor in determining how much drug the infant will ingest. The number of feedings and the amount of milk ingested certainly affect the infant's exposure level. Because the composition of milk changes during one feeding, the time spent sucking at one breast might also influence the amount of drug ingested.

4.6.1 Milk Ingestion Rate

The amount of breast milk consumed daily by an infant (i.e., the ingestion rate of breast milk, L/day or kg/day) varies with numerous factors, predominantly infant weight and nursing frequency, with larger infants and those that nurse more frequently consuming more. From data reviewed by EPA (1998), the estimated average intake rates reported in the literature by different authors varied markedly. For example, EPA (1977) recommended mean intake rates of 742 mL/day for infants between 1 and 6 months of age, and 688 mL/day at 12 months with mean feeding frequency between 5.8 meals/day at 1 month of age to 5.1 meals/day at 3 months. Whitehead and Paul (1981), in a study of 48 British infants aged 1-8 months, found that the breast milk ingestion rate ranged from 677 to 922 mL/day; Smith (1987) used 0.8 kg/day in application of the model. Prentice et al. (1994) compiled milk volume measurements from 41 studies published during 1980-1992 from numerous countries for use in a meta-analysis of body mass and lactation performance. Average breast milk volume ranged from 307 to 961 g/day for infants from 1 to 6 months of age, with most studies showing averages of 600-900 g/day. Using 1.03 g/mL as the density of human milk, conversions can be made between the weight and volume of breast milk consumed.

For infants 1 to 6 months old, the *Exposure Factors Handbook* (U.S. EPA 1997a) recommends using an average breast milk intake of 742 mL/day, with an upper percentile intake of 1,033 mL/day. However, breast milk intake remains relatively constant until approximately 6-9 months of age, after which it decreases, apparently due to dietary supplementation with other food (Whitehead and Paul 1981,

EPA 1997). Therefore, the EPA recommended using 688 mL/day (12-month time-weighted average) as the mean intake for infants up to 1 year of age, with 980 mL/day as the upper percentile rate.

As described for modeling purposes in Issue Area 2, Appendix Section A.2.5., it is estimated that on average, the rate of consumption of breast milk by a human infant is 0.67 L/day at age 10.5 days (WBODY = 3.78 kg), and 0.98 L/day at age 97.5 days (WBODY = 5.36), according to the growth algorithm for breast milk intake calibrated with U.S. data from Neville et al. (1988); the typical range was from 0.5 to 0.88 L/day.

4.6.2 Other Physiological and Pharmacokinetic Factors

Due to differences between infants and adults in absorption, distribution, metabolism, and excretion of drugs and other chemicals (see Issue Area 2), not only the way those compounds are handled by their bodies are different but also the way their bodies respond to drugs may vary significantly.

Gastric acid secretion and overall gastrointestinal transit time are decreased in neonates; gastric emptying time is generally prolonged, but is also variable and unpredictable. In addition, gastroesophageal reflux may result in variable loss of drugs. These factors may potentially reduce drug absorption; however, this reduction may be balanced by a greater small intestine absorptive surface (Kacew 1993, 1997). The tissue distribution of drugs and other chemicals in infants is discussed in detail in the Issue Area 2.

The differences in metabolism and biotransformation of drugs and other chemicals in adults and infants is discussed in depth in the Issue Area 1. Most important are differences in the amount and activities of the Cytochrome P450 (phase I) enzyme system and differences in metabolic conjugation (phase II) pathways. Glucuronidation of drugs, are lower at birth; but this is not true for sulfation, which is well developed in neonates (see Issue Area 1). Moreover, renal blood flow, glomerular filtration rate, and tubular function are all markedly decreased in the newborn and do not reach adult levels until approximately 1 to 6 months of age. This decreased clearance rate is important and may cause some drugs to be incompatible with breast-feeding (Kacew 1992).

4.7 QUANTITATIVE MODELING OF LACTATIONAL TRANSFER OF CHEMICALS

For quantitative risk assessment, modeling is necessary to estimate intakes and/or exposure doses of drugs and other chemicals that the infant receives with breast milk as well as with a cow-milk-based formula. Several algorithms and computer-aided models have been developed for this purpose. Some of them are only rudimentary proportionality approximations of a steady state, treating the entire process of lactational transfer as a black box and considering only the relationship between the input (exposure of milk cow or lactating mother) and the output (concentration of drug in milk or intake by the infant). On the other hand, several realistic mathematical models also have been developed. These models not only describe the physiological process of lactational transfer of drugs and other chemicals but also have a

predictive power, allowing extrapolations beyond the calibration range. In applying those quantitative tools in risk assessment, it is crucial to understand their abilities and limitations and consequently to choose the right tool, adequate to the required level of accuracy and the acceptable level of uncertainty.

4.7.1 Steady-State Modeling Employing Milk Biotransfer Factor

Travis and Arms (1988) defined a chemical's bioconcentration factor (BCF) as the chemical's concentration in an organism or tissue expressed as a proportion of its concentration in water (for aquatic organisms) or in food (for terrestrial organisms). However these scientists recognized that the biotransfer factor (BTF), the ratio of the contaminant concentration in animal tissue (mg contaminant/kg tissue, wet weight) to daily intake (mg contaminant/day), might be more directly applicable than the BCF to quantitative models estimating human health risk from exposure to contaminated milk (Travis and Arms, 1988). An example of how such a biotransfer factor (B_{mi}; day/kg) may be applied to the modeling of multimedia chemical exposure pathways to the human child is shown in Figure 4-4, with lactational transfer emphasized. The BTF (expressed for milk in infant as B_{mi} in day/kg) is multiplied by a species-specific food ingestion rate (kg/day) and by the contaminant concentration in food (mg/kg) to obtain an estimate of the concentration in milk in mg contaminant/kg milk (see Figure 4-4). However, since BTFs are both chemical and species specific and come under the influence of site conditions, the site-specific values would be preferred over defaults, where available.

4.7.1.1 Derivation of Milk Biotransfer Factor

In general, the more fat-soluble a chemical may be, the higher the concentration it can reach in milk. Travis and Arms (1988) used this relationship to correlate the BTFs obtained from experimental data with the compound-specific octanol/water partition coefficient (K_{ow}), presented as a series of geometric mean regression equations, depending on the medium. Figure 4-5 shows examples of the relationship between BTFs and K_{ow} s for fat-soluble chemicals in human and cows' milk. The intercepts and slopes in the linear regression analysis, and thus the resulting BTFs (B_m), were highly species dependent.

A geometric mean regression analysis (Travis et al. 1988) of the relationship between BTFs and K_{ow} s for six chemicals yielded in human milk:

$$B_m = 6.2 \times 10^{-4} K_{ow} \quad n = 6, r = 0.94 \quad (3)$$

where B_m is a BTF for milk (day/kg), K_{ow} is the n-octanol/water partition coefficient (ratio), n is the number of chemicals, and r is a correlation coefficient. Using more data and stratifying chemicals according to their structure and/or solubility may even further improve the correlation. For example, Meylan et al. (1999) obtained a stronger correlation and a better fit to the data for BCFs for as many as 694 chemicals when the chemicals were stratified into groups (nonionic, ionic, aromatic azo-compounds) and the chemical-specific correction factors were introduced to the general regression equations.

Though widely used and recommended as a practical approach to the development of BTFs (EPA 1998), this simple correlation model is inadequate to account for volatile and rapidly metabolizing chemicals, does not address chemical-specific problems (e.g., with biological transport of ionized compounds), and neglects species-specific physiological parameters and intake scenarios.

4.7.1.2 Milk Transfer Coefficient

A model similar to the one shown in Figure 4-4 has been used for linear approximations of the ^{131}I concentrations in fresh cows' milk that would result from nuclear bomb fallout (National Cancer Institute 2001). The transfer of ^{131}I from deposition on the ground to fresh cows' milk and infant formula is relatively well documented. The time-integrated concentration of ^{131}I in milk, corresponding to an estimated deposition density on the ground, on a given day and in a given county was calculated employing the intake-to-milk transfer coefficient (F_m ; day/L), analogous to the BTF.

The time-integrated concentration of ^{131}I in milk ($\mu\text{Ci day/L}$) divided by the ^{131}I (μCi) consumed by the cow is defined as the intake-to-milk transfer coefficient for ^{131}I for cows, in f_m (day/L). This transfer coefficient has been determined experimentally in a large number of studies, including tracer experiments with stable or radioactive iodine and field studies in which pasture grasses were contaminated by ^{131}I resulting from releases from nuclear facilities or from fallout from nuclear weapons tests. Reported literature values for f_m range from 2×10^{-3} to 4×10^{-2} day/L, but it seems that fallout studies yielded values in the lower part of the range (median value of 4×10^{-3} day/L) (National Cancer Institute 2001).

Table 4-6 lists milk transfer coefficients (F_m , expressed in day/kg) that can be used in a modeling, realistically estimated for some ubiquitous radionuclides. These coefficients were developed for a modeling approach that follows the EPA Superfund methodology used for estimating the rate at which a chemical is transferred from soil or water to cows, and then to humans when the cows' milk is consumed (see Risk Assessment Information System 2001).

A separate challenge for PK modelers presents the lactational transfer of radiopharmaceuticals passed by the exposed mother to the nursing infant under the therapeutic scenario (Rubow et al. 1994; Stabin et al. 1995). For example, Stabin et al. used a classical approach to build a nonspecific biokinetic model for broad chemical classes of radionuclides. However, the parameters generated were conceptual and the model was not validated. While the work provided a crude instruction for customizing feeding schedules to protect infants from overexposure to radioactivity, the study could be much improved with a more mechanistic and quantitative approach.

4.7.1.3 Quantitative Structure-Activity Relationship Model

A quantitative structure-activity relationship (QSAR) modeling approach has been used successfully for predicting biotransfer factors and tissue solubilities (Gargas et al. 1988). For example, the structurally dependent molecular connectivity indices (MCI) are more precise estimators of

bioconcentration in plants and animals than are solubility factors (McKone et al. 1995). The MCI provides a reliable, fast, and cost-effective method for predicting the potential bioconcentration of a chemical from soil into above-ground vegetation, and consequently into cows' milk. Statistical analyses have indicated that, while either the K_{ow} or MCI approach is adequate to predict BCFs from soil solution into roots, neither the K_{oa} nor K_{ow} model was a highly reliable predictor of biotransfer from air to plant (Dowdy and McKone 1996).

While QSAR models have the potential for solving the chemical-specific problems in predicting the BTFs, they typically do not address species-specific physiology and differences in intake scenarios by different animals, and usually fail to predict metabolism rates (Gargas et al. 1988).

4.7.2 Steady-State Modeling Employing Milk-to-Plasma Ratio

When the concentration of drug or other chemical in mother's plasma, but not in her milk is known, the milk-to-plasma (M/P) ratio may be used to estimate the dose rate delivered via breast milk to the infant. For therapeutic drugs, determining the M/P ratios may be helpful in assessing whether the drug is likely to be excreted in high concentrations in breast milk when a lactating woman is medicated. Often, the maternal plasma concentration of a drug or other chemical can be measured or is already known based on previous therapeutic experiences, whereas the milk concentration can either be estimated from human or animal data, or predicted using quantitative pharmacokinetic models. The M/P ratios for environmental chemical contaminants can be used as an index of the likelihood of exposing the nursing infants via breast milk, subsequent to the exposure of their mothers.

As discussed above (Section 4.3.3.3), weak bases achieve higher concentrations in breast milk than in plasma (ion trapping). However, the amount of drug available to cross into the milk depends not only on the fractions of un-ionized drugs (as only the unbound fraction that is un-ionized is available to diffuse into milk), but also on the degree of protein binding (Section 4.3.3.4), extent of lipophilicity (Section 4.3.3.1), and molecular weight (Section 4.3.3.2). Fleishaker et al. (1987) developed a skim milk-to-whole milk model based on this notion, in order to account for lipophilicity (expressed as a drug octanol/water partition coefficient) and plasma protein binding. Other models required determination of partition coefficients milk lipid-to-ultrafiltrate (Atkinson and Begg 1990).

The model described below employed the whole milk to plasma ratio, instead of the milk to plasma ultrafiltrate ratio (M_F/P_F), calculated from regression equations (for the data used in parameterization, see Atkinson and Begg 1990):

$$\text{Acidic drugs: } \ln M/P = -0.405 + 9.4 \ln (M_F/P_F) - 0.7 \ln (f_{up}) - 1.5 \ln K \quad (4)$$

$$\text{Basic drugs: } \ln M/P = -0.09 + 2.54 \ln (M_F/P_F) + 0.8 \ln (f_{up}) + 0.46 \ln K$$

where $K = (0.955/f_{um}) + (0.045 \times \text{milk/lipid } P_{app})$, f_{up} is the fraction of drug unbound in plasma, f_{um} is the fraction unbound in milk, and P_{app} is the apparent partition coefficient at pH 7.2. The regression

parameters for basic drugs, shown above, represents a revised algorithm that was fitted to more data than in the first published version of the model (Bailey and Ito 1997). Although the regression parameters of the log-transformed relationships shown in equation 4 depended heavily on the number and quality of data, it was not possible to validate the overall algorithms as all the data existing in the available literature were already used to develop the correlations; therefore, no independent data set was available for validation (Atkinson and Begg 1990).

Once the M/P ratio is obtained, either from a reference or by using the Atkinson and Begg model, it can be used to calculate the drug concentration in milk (C_m):

$$C_m = M/P \times C_{ss} \quad (5)$$

where C_{ss} is the average maternal plasma concentration at steady state. C_{ss} can be measured directly, obtained from a literature, or estimated from clearance and bioavailability, the parameters more easily found in the literature:

$$C_{ss} = (R \times F)/Cl \quad (6)$$

where R is dosing rate, F is bioavailability, and Cl is clearance of the drug.

With the concentration of the drug in the milk estimated (C_m), the infant exposure dose rate (mg/kg/day) can be obtained (D_{inf}):

$$D_{inf} = C_m \times V_m \quad (7)$$

where V_m is the volume of milk ingested by the infant daily, usually approximated at 150 mL/kg/day (for more realistic estimates, see Section 4.6.1).

For comparison with the maternal dose, one can also estimate the percentage of the maternal dose the infant is ingesting using a per body weight basis (F_{inf}):

$$F_{inf} = (D_{inf} \times 100) / \text{maternal daily dose per kg} \quad (8)$$

For most drugs, the fraction of the maternal dose the infant is ingesting is less than 5 percent per body weight, a dose usually low enough so that it does not produce pharmacologic effects in the infant. However, this is not true for lipophilic chemical pollutants. If the infant's maximum no-effect dose or therapeutic dose is known, one can also estimate the fraction of this dose that the infant is ingesting through the breast milk (percent of no-effect or therapeutic exposure).

Alternatively, in a worst-case scenario, the maximum amount of a chemical to which the infant may be exposed can be estimated. For this purpose, the maximum maternal plasma concentration, instead of the average concentration, should be used. The maximum concentration can be estimated by dividing the dose by the volume of distribution reported in the literature.

4.7.2.1 *Exposure Index*

The exposure index, which takes into account not only the M/P ratio but also the clearance of the drug by the infant, may be used in order to prevent misinterpretation of the M/P ratios for drugs and other chemicals (Ito and Koren 1994).

$$\text{Exposure index} = (A \times M/P) / C_{1_i} \quad (9)$$

where A is a coefficient (10 mL/kg/min) representing milk intake multiplied by 100, M/P is the milk-to-plasma drug concentration ratio, and C_{1_i} is the clearance of the drug by the infant.

The exposure index, directly proportional to the M/P ratio and reciprocal to the infant's clearance may be used to explain why for a drug with low infant's clearance, a small interindividual change in pharmacokinetic variables (such as the M/P ratio (e.g., due to plasma protein binding or maternal metabolism), or clearance in the individual infant), can significantly change the exposure of the infant to the drug or other chemical. This, in turn, may explain side effects of drugs reported in some sensitive breast-fed infants, even when such side effects do not occur in the general population, and interindividual variations in sensitivity of infants to some chemical contaminants.

4.7.2.2 *Pitfalls of the M/P Modeling Approach*

Although some authors have found it useful to determine experimentally the M/P ratios of drugs, most often these ratios are useful only for comparative purposes. Because milk/plasma coefficients cannot reflect the time-dependent variations, they are useful only for a steady-state estimation of dose received by the infant. However, the usefulness of an M/P modeling approach may be limited, for instance, by significant variability in single versus multiple dose milk/plasma ratios for most drugs. As emphasized by Wilson et al. (1985), the usage of a single point in time M/P ratio or an average ratio calculated with single dose area under the curve (AUC) data is not sufficient for all drugs. Milk volume and its constituents, drug metabolism rate, maternal disease, and drug interactions all affect the M/P ratio (Wilson et al. 1985).

4.7.3 **Compartmental Pharmacokinetic Models**

A generic classical pharmacokinetic system, used by many authors in modeling of lactational transfer of lipophilic drugs and other chemicals, is shown in Figure 4-6. An advantage of this modeling approach, when compared to the BTF or M/P approach, is that there is no need to assume a steady state because the drug concentrations in fat and milk evolve over time. A basic assumption of classical pharmacokinetic models is that the rate of mass transfer depends linearly on the concentration. However, consideration of the milk fat as a part of the maternal adipose tissue (body fat, see Section 4.5.2) is problematic. Obviously it is possible to append to this system some additional compartments, such as a compartment for mammary tissue and/or milk, but this basic model becomes more and more complicated when additional compartments are considered simultaneously. For the multicompartimental linear system, the concentration in the "i-th" compartment (C_i) will be a sum of exponential terms of the form:

$$C_i = A_i e^{-\alpha t} + B_i e^{-\beta t} + \dots + N_i e^{-\nu t} \quad (10)$$

where each term represents a partial contribution to the total concentration in the “i-th” compartment (represented by proportionality constants A, B, and N in mg/L); α , β , ν are rate constants (microconstants in 1/h); and t is time in h. One disadvantage of the classical approach is that experimental resolution of these biexponential, triexponential, etc., equations becomes progressively difficult. Another disadvantage is that it requires interpretation of several abstract parameters which are usually not directly available for experimental physical measurements and are often counterintuitive (e.g., intercompartmental transport rate constants, compartmental volumes, volume of distribution, clearance, and half-life) (Byczkowski and Fisher 1995).

4.7.3.1 Hoover’s Model for TCDD

Hoover et al. (1991) described what they called a “two compartment model” for lactational transfer of TCDD. Their model described time-weighted average (TWA) intake of TCDD into the mother’s body (i ; pg/kg/day), metabolic elimination (r ; 1/days), and lactational elimination via breast milk (E ; pg/kg/day); volume of fat (V_f ; kg); and volume of the “body compartment” consisting of “all body tissue except fat” (V_b , kg). The model estimated the dose of TCDD received by the infant with mother’s milk fat. The authors used their model as an input to determine a cancer risk to the infant for the various maternal exposure scenarios using the Armitage and Doll algorithm with a carcinogenicity potency (q1 slope) of $133 \text{ (mg/kg/day)}^{-1}$.

However, the authors failed to provide any information regarding the nature of mass transfer between the central and peripheral compartments (diffusion rates, transport with blood, etc.). Because k_{01} and k_{10} were unknown, this reduced the possibility of following the time-dependent progression of the system to just one lumped compartment ($V_b + V_f$). Therefore, the model for lactational transfer of persistent lipophilic compounds, presented by Hoover et al. (1991), appears to be essentially a version of the classical linear one-compartment model for an open system with continuous TCDD intake (i), metabolic clearance (r), and elimination (E). Concentration of TCDD inside of the global compartment was proportionally divided between fat and the other body tissue, using a fat/body partition coefficient of 21 (k_{fb} ; ratio). A schematic diagram of the actual Hoover et al. system and governing equations of their model are shown in Figure 4-7.

The authors stated that both the volume of the fat compartment and volume of the rest of the body compartment were determined from the standard growth curves for adults and children, but they failed to produce these curves or fitting algorithms. From the inspection of the appropriate references (ICRP 1984, for mother, and Fomon et al. 1982, for children) it was not directly apparent how these growth curves were constructed.

As this model does not address the circulating blood or diffusion, the authors must have assumed an immediate, well-mixed equilibration between the fat and the rest of the body, while ignoring diffusion rate and blood flow. Since the authors considered milk fat as a part of mother’s body fat, they must have

assumed a perpetual production and loss of milk fat without changing the total volume of body fat. Since the authors only mentioned but did not describe the standard growth curve for volume of mother's body fat, this cannot be verified.

4.7.3.2 Models of Smith and Sullivan

An improvement over the Hoover et al. (1991) modeling approach was that reported by Smith (1987) and Sullivan et al. (1991). Essentially, their modeling algorithm may be described as:

$$\begin{aligned} \text{Cmlkf2} = & \text{hDI}_{\text{mat}} * \text{ff}/\text{ffm} * (((1-\text{EXP}(-\text{kelim} * \text{TpnS})) \\ & * 1/\text{kelim}-1/\text{kelac}) * \text{Exp}(-\text{kelac} * \text{TbfS}) + 1/\text{kelac}) \end{aligned} \quad (11)$$

where Cmlkf2 is the concentration of TCDD in maternal milk fat (pg/kg of milk fat); hDI_{mat} is daily maternal absorbed dose of TCDD (0.9 * ADD_{mat}; pg/kg BW/day); ff is fraction of TCDD that is stored in maternal fat (0.9; ratio); ffm is fraction of mother's body weight that is fat (0.3; ratio); kelim is the biological elimination rate constant for TCDD in the mother (1/days), calculated as 0.693/thalf (thalf = 2,920 days = 8 years); TpnS is a timing switch (depending on the exposure calendar, TpnS = T (days), or TpnS = (T - duration of mother's exposure prior to nursing), or TpnS = (T - duration of breast-feeding)); kelac is the lactational elimination rate constant (1/days), calculated as kelim + ingestion rate of breast milk (0.75; kg/day) * ff * fraction of fat in breast milk (0.04; ratio)/(ffm * BW); and TbfS is a timing switch (depending on exposure calendar, TbfS = 0, or TbfS = (T - duration of mother's exposure prior to nursing) (days)), and * is a multiplication sign.

An analogous equation without the kelac was of a form:

$$\text{Cmlkf1} = \text{hDI}_{\text{mat}} * \text{ff}/(\text{kelim} * \text{ffm}) * (1-\text{EXP}(-\text{kelim} * t)) \quad (12)$$

where Cmlkf1 is the concentration of TCDD in maternal milk fat (pg/kg of milk fat) without accounting for losses due to breast feeding. The TCDD concentration in milk fat at steady state (zero order kinetics, when $t \rightarrow \infty$) was estimated as:

$$\text{Cmilkf} = \text{hDI}_{\text{mat}} * \text{ff}/(\text{kelim} * \text{ffm}) \quad (13)$$

where Cmilkf is steady-state concentration in milk fat (pg/kg milk fat), and * is a multiplication sign. Equations 11 - 13 are in the form suitable for encoding in the computer program (ACSL, FORTRAN, etc.) for simulations.

A critical analysis of the compartmental modeling approach of Smith (1987) and Sullivan et al. (1991) is provided in the EPA (1998). According to EPA's analysis, the assumption that contaminant concentrations in milk fat will be the same as in general body fat may be reasonable for highly lipophilic compounds (e.g., PCDDs, PCDFs, PCBs, HCBs). They cited Beck et al. (1994), who showed similar breast milk and adipose tissue concentrations for PCDDs/PCDFs. The EPA emphasized, however, that

ignoring the time required to reach near-steady-state concentrations results in an overprediction of the concentration in milk fat. According to the EPA analysis, overpredictions of 10-fold or greater can occur when the half-life is large and the exposure duration is small. Overpredictions of breast milk concentrations will also result if maternal contaminant losses from breast-feeding are not considered. As an example, PCDDs and PCDFs tend to be excreted in breast milk at the highest levels within the first few weeks after delivery; after 1 year of breast-feeding, milk concentrations appear to approach steady-state and are about 30-50 percent of the initial levels (Fürst et al. 1989).

4.7.4 Physiologically Based Pharmacokinetic Models

The implementation of physiologically based pharmacokinetic (PB/PK) models by Shelly et al. (1988, 1989) represented significant progress in estimating the infant's exposure to drugs and other chemicals transferred with breast milk and in assessing the overall risk to the infant. Their approach involved a mathematical description of physiological processes involved in absorption and disposition of a chemical by the mother, partitioning of the chemical to milk, and subsequent exposure of the infant. Their model was capable of simulating, for instance, the distribution of volatile organic solvent from the mother's breathing zone to the nursing infant.

Essentially, the model of Shelly et al. (1988, 1989) consisted of several mass-balance equations, linked by rates of chemical mass transfer via blood and milk. The distribution in tissues and exhalation of chemicals followed the partition coefficients, which can be determined by *in vitro* experimentation (Gargas et al. 1989). The tissue concentrations were estimated by integrating the appropriate mass rate equations over time. The model required an exposure scenario (time, concentration, body weights, etc.) and feeding pattern (milk volume, timing, etc.). Physiological parameters, such as cardiac output, pulmonary ventilation, fat volume, blood flow to the adipose tissue, and other physiological parameters were obtained from the literature and scaled according to the body weight (see discussion on PB/PK modeling in Area 2, Appendix A). The PB/PK model of lactational transfer of chemicals may be scaled up or down across the species, according to the body weight, and the model of Shelly et al. was experimentally validated with trichloroethylene (TCE) using lactating rats (Fisher et al. 1990).

4.7.4.1 PB/PK Modeling of Lactational Transfer of Volatile Chlorinated Hydrocarbons

By the late 1980s and 1990s, PB/PK models had been developed that described the lactational transfer of chemicals in laboratory animals. Fisher et al. (1990) developed a multiroute exposure model of a lactating rat and nursing pup for TCE and its metabolite, trichloroacetic acid (TCA). Similar studies were performed by Byczkowski and Fisher (1994) and Byczkowski et al. (1994), studying tetrachloroethylene (PCE) as a chemical of interest. Subsequently, Byczkowski and Fisher (1995) scaled up the model according to human physiology to describe lactational transfer of PCE to nursing infants. The model of Byczkowski and Fisher was successfully used for cancer risk assessment in nursing infants exposed to PCE (Byczkowski 1996).

A similar attempt to apply PB/PK modeling to cancer risk assessment of infants exposed to PCE via breast milk of mothers employed in dry-cleaning facilities or living in apartments above the dry-cleaning facilities in the New York area was performed earlier by Schreiber (1992, 1997). However, her PB/PK model considered milk as a part of the maternal body fat tissue and was not calibrated with experimental data. In contrast, the PB/PK model of Byczkowski and Fisher (1994) contained an explicit mathematical description of the breast milk compartment (see Figure 4-8 for a compartmental structure) and was calibrated with experimental data from lactating rats treated with PCE and from their nursing pups (Byczkowski et al. 1994).

4.7.4.2 Calibration of PB/PK Models for Lactational Transfer with Experimental Data from Laboratory Animals

As described by Byczkowski et al. (1994), lactating female Sprague-Dawley rats (suitable for cross-fostering) were used as test animals for development and validation of a PB/PK model. After delivery, litters were reduced to 8 pups per dam and kept undisturbed for 10 to 11 days. On day 10 or 11 *post partum*, the lactating females were exposed to PCE. Inhalation was selected as the route of administration most relevant to the real-life exposure scenario for humans. First, during the model development phase, a closed inhalation chamber was used to determine metabolic parameters. Then an open (constant concentration) inhalation chamber was used during the model calibration phase. During the exposures, the lactating females were placed either in the closed gas uptake chamber for up to 6 hours, or in an open (constant concentration) inhalation chamber for 1 to 5 hours. Numbers of rats included in the gas uptake and constant concentration exposures were typically 3 groups of 3 dams for model development and 5 groups of 5 dams for model validation.

At a selected exposure level, time-dependent measurements of PCE were made in dams' milk and blood following 1-, 2-, 3-, 4-, or 5-hour exposure to PCE vapors. Other dams, exposed to high, fixed concentration of PCE for 2 hours, were returned to their nursing pups after exposure, and at selected times, dams' milk and blood PCE levels, as well as pup blood and tissue PCE levels, were measured.

Milk samples were collected from the lactating dams at specified times following the exposure. Each dam was anesthetized with Ketamine/Rompum solution and then given Oxytocin i.p. approximately 5 minutes prior to obtaining the milk sample using glass capillary tubes. Blood samples were taken from the dams at specified times following exposure and immediately following the milk collection. Blood was sampled directly from the *vena cava*. Pups were anesthetized using CO₂ inhalation after which they were opened up and the blood was drawn via *vena cava*.

This protocol allowed Byczkowski et al. (1994) to obtain a coherent set of dose- and time-dependent data from dams and pups, suitable for validation of the PB/PK model, independently from the data used for the model development and calibration.

4.7.4.3 *PB/PK Modeling of Lactational Transfer of Mercury*

Mercury (Hg) is a known developmental neurotoxicant. Exposure of developing neonates to mercury may occur via mother's milk when the lactating female is or has been exposed to Hg compounds, such as methylmercury (MeHg). The mammalian brain continues to develop post-parturition, thus postnatal MeHg exposure via breast milk may affect nervous system development. Mercury compounds present in milk are derived from the maternal blood compartment, and several mechanisms seem to be involved in the path by which mercury compounds enter the milk (Fujita and Takabatake 1977, Grandjean et al. 1994, Oskarsson et al. 1995). The possible detrimental effects of lactational transfer of low levels of methylmercury (Grandjean et al. 1995) must be weighed carefully against the beneficial effects of breast-feeding (Rogan and Gladen 1993). To achieve this goal, health risk assessors should be able to calculate concentrations of Hg transferred to the infant during gestation and lactation and compare them to concentrations producing developmental defects.

A wealth of information on the pharmacokinetics of Hg and MeHg exists in the available literature (extensively reviewed by U.S. EPA, 1997b). Together, the data indicate that the lactational transfer of Hg during the first 15 days of lactation accounts for roughly one-third of the transfer of Hg during gestation. Given that plasma Hg from a dose of MeHg has a much longer half-life than does inorganic Hg, that concentrations in milk remain fairly constant at roughly 10 percent of the concentrations in plasma, and that lactational transfer through suckling may continue in primates for periods longer than gestation, it appears possible that lactational transfer of MeHg may equal or exceed the dose of MeHg encountered by the developing fetus during the transplacental transfer. Unfortunately, conventional bioaccumulation calculations using a linear biotransfer factor (see Section 4.7.1.1) usually fail in the case of Hg compounds in milk. Lactational transfer of both MeHg and inorganic Hg has been described in mice by Sundberg et al. (1998) using a simplified three-compartment classical linear pharmacokinetic model. Although this model is useful for a quantitative description of the blood (plasma)-milk pharmacokinetics in mice, its applicability for human modeling is limited. Thus, to aid in a quantitative assessment of lactational transfer of mercury, numerous pharmacokinetic studies have been carried out in animals (U.S. EPA 1997b), and recently a comprehensive PB/PK model for MeHg has been developed and validated with data from humans (see Area 2, Figure 2-1, according to Byczkowski and Lipscomb 1999).

The PB/PK model of Byczkowski and Lipscomb (1999) addressed both transplacental and lactational transfer of MeHg and simulated tissue disposition of MeHg in infants, including the brain tissue (Lipscomb et al., 2000). This model was initially calibrated with experimental data from lactating rats and their nursing pups (Oskarsson et al. 1995; Sundberg et al. 1991). Next, the algorithms for infant body weight growth and breast milk intake rate were developed and calibrated for human infants (for other species modeled these algorithms were either replaced by average values or substituted with species-specific functions). After re-parameterization for humans, the PB/PK model was validated with data for mother-infant pairs who had been acutely poisoned with MeHg in the 1971 Iraqi MeHg poisoning accident, as described by Amin-Zaki et al. (1976) and with data for Japanese mother-infant

pairs from Fujita and Takabatake (1977). Figure 4-9 presents an example of a predictive simulation of total Hg concentrations in the brain of mothers exposed to 0.1 µg MeHg/kg/day, gestationally exposed fetus, and nursing infant.

4.7.4.4 Problems Encountered in PB/PK Modeling of Lactational Transfer

PB/PK models have proven to be quite useful in predicting the lactational transfer of different types of drugs and other chemicals, and their validated predictions may be applied in risk assessments for exposure characterization in nursing infants.

However, properly designed studies are required to address the kinetics of different chemicals. An example is the experimentally measured blood/air partition coefficient, which is indispensable for proper simulations but is affected by hematocrit and lipid content. For instance, partition coefficients for ethyl ether and acetone decline with increasing hematocrit, but partition coefficients for chloroform, cyclopropane, and ethane increase with increasing hematocrit (Leo et al. 1971). On the other hand, partition coefficients for trichloroethylene and fluroxene are independent of the hematocrit (Leo et al.). Another possible problem represents the validation of mathematical models using laboratory animals. Significant differences may exist between species in the transfer and excretion of lipophilic chemicals in milk. For instance, the transfer of polycyclic aromatic hydrocarbons (e.g., benzo(a)pyrene) from diet to milk in rabbits and sheep is much lower than that in rats (0.003% in rabbit and 0.01% in sheep vs. 0.19% in rat) (West and Horton 1976). Thus, the extrapolation of results from one animal species to another may be sometimes misleading.

The parameters used in PB/PK models for lactational transfer of drugs and other chemicals are derived from normal breast-feeding women. These parameters would need to be adjusted for non-normal conditions such as nutritional deficiencies (e.g., ataxic and malnourished mother after poisoning by organic Hg, in Amin-Zaki et al. (1976) data, successfully simulated by the model of Byczkowski and Lipscomb, 1999, after the adjustment for pathological case was made) or disease states such as diabetes. The main objective is to encourage breast-feeding but, at the same time, to limit drug or chemical exposure during this period adequately to the specific case.

All of these factors must be considered before attempting any risk assessment of breast-fed infants by mothers exposed to the toxic chemical, based on infant exposure characterization by PB/PK modeling. In most cases the risk of exposing the infant to a harmful concentration of a drug or other chemical is only a fraction of the risk for the mother (Jensen and Slorach 1991). On the other hand, for some toxic compounds, even this fractional risk may be unacceptably high.

4.8 CONCLUSION

The preceding review of the literature on the pharmacokinetics of lactational transfer of drugs and other chemicals clearly indicates that PB/PK models, coupled with pharmacokinetic studies in rodents and primates and with laboratory studies on human blood and breast milk, have an important place in providing the framework for improving the estimates for chemical dosimetry to the breast-fed infant. For most chemicals and under most exposure scenarios, PB/PK modeling provides the most accurate tool for adequate exposure characterization in the nursing infant. While these modeling techniques provide a significant advancement in estimating a dose in the nursing infant, PB/PK models will not resolve the toxicological question of dose-response for health effects in human infants. In other words, the sensitivity of the nursing infant to chemicals is usually unknown. Properly designed epidemiological studies of dose and response in infants may help to address this problem. On the other hand, monitoring of blood, breast milk, exhaled breath, hair, or urine in both the mother and infant are needed to document chemical exposure. These data then may be used in human PB/PK models to estimate exposure of the infant and, eventually, to correlate exposure with infant health effects.

In conclusion, improving our ability to estimate the risk to infants exposed via contaminated breast milk, without needlessly discouraging the breast-feeding, will require the involvement of physicians, toxicologists, pharmacokineticists, industrial hygienists, and risk assessors, to provide a multifaceted group of scientists addressing this complex issue.

4.9 REFERENCES

- American Academy of Pediatrics, Committee on Drugs. (1989). Transfer of drugs and other chemicals into human milk. *Pediatrics* 84:924-936.
- American Conference of Governmental Industrial Hygienists. (1991). 1991-1992 Threshold limit values for chemical substances and physical agents and biological exposure indices. ACGIH, Cincinnati, OH.
- Amin-Zaki L, Elhassani S, Majeed MA, Clarkson TW, Doherty RA, Greenwood MR, Giovanoli-Jakubczak T. (1976). Perinatal methylmercury poisoning in Iraq. *Am J Dis Child* 130: 1070-1076.
- Anderson PO. (1991). Therapy review: Drug use during breast feeding. *Clin Pharmacokinetics* 10:594-624.
- Atkinson HC, Begg EJ. (1988). The binding of drugs to major human milk whey proteins, *Br. J. Clin. Pharmacol.* 26:107-109.
- Atkinson HC, Begg EJ. (1990). Prediction of drug distribution into human milk from physicochemical characteristics, *Clin. Pharmacokinetics* 18:151-167.
- Baes CF III, Sharp RD, Sjoreen AL, Shor R W. (1984). A Review and Analysis of Parameters for Assessing Transport of Environmentally Released Radionuclides through Agriculture. ORNL-5786. Oak Ridge National Laboratory, Oak Ridge, Tennessee.
- Bailey B, Ito S. (1997). Breast-feeding and maternal drug use. *Pediat. Clin. N.A.* 44:41-54.
- Barrett JR. (2001). Chemicals in breast milk. *Environ. Health Perspect.* 109:A38.
- Beck H, Dross A, Mathar W. (1994). PCDD and PCDF exposure and levels in humans in Germany. *Environ. Health Perspect.* 102:173-185.
- Begg EJ, Atkinson HC. (1991). Partitioning of drugs into human milk. *Ann. Academy Med.* 20:51-55.
- Berlin CM. (1981). Pharmacologic considerations of drug use in the lactating mother. *Obstetrics Gynecol.* 58:17S-23S.
- Berlin CM. (1986). Drug excretion into human milk. In: *Human Lactation 2: Maternal and Environmental Factors*, (eds. M. Hamosh and AS. Goldman), Plenum Press, New York.
- Berlin CM, Kacew S. (1997). Environmental chemicals in human milk. In: *Environmental Toxicology in Human Development*. (Kacew S, Lambert GH, eds.) Washington DC: Taylor & Francis, 67-93.
- Black RF. (1996). Transmission of HIV-1 in the breast-feeding process. *J. Am. Diet. Assoc.* 96:267-274.
- Bloom W, Fawcett DW. (1975). *A Textbook of Histology*, tenth ed., Philadelphia, Pa.: W.B. Saunders.
- Burmester DE. (1998). Lognormal distributions for total water intake and tap water intake by pregnant and lactating women in the United States. *Risk Anal.* 18:215-219.
- Bush B, Snow J, Connor S, Koblitz R. (1985). Polychlorinated biphenyl congeners (PCBs), *p,p'*-DDE and hexachlorobenzene in human milk in three areas of upstate New York. *Arch. Environ. Contam. Toxicol.* 14:443-450.
- Buttar HS (1994). Neonatal risk of drugs excreted in breast milk. *Can. Pharm. J.* 127:14-18.
- Byczkowski JZ. (1996). Linked PBPK model and cancer risk assessment for breast-fed infants. *Drug Inf. J.* 30: 401-412.
- Byczkowski JZ. (1997). *Drugs and Toxic Chemicals in Breast Milk*. Last update 1997. Published on-line. <<http://members.aol.com/JanuszB/milkpage.htm>>.

- Byczkowski JZ. (2000). Pharmacokinetic/Dynamic Modeling. In: Standard Handbook of Environmental Science, Health and Technology, Chapter 8.6. (Lehr J, ed.), New York: McGraw-Hill.
- Byczkowski JZ, Fisher JW. (1994). Lactational transfer of tetrachloroethylene in rats. *Risk Analysis*, 14: 339-349.
- Byczkowski JZ, Fisher JW. (1995). A computer program linking physiologically based pharmacokinetic model with cancer risk assessment for breast-fed infants. *Computer Meth. Programs Biomed.* 46:155-163.
- Byczkowski JZ, Gearhart, JM, Fisher JW. (1994a). "Occupational" exposure of infants to toxic chemicals via breast milk. *Nutrition* 10: 43-48.
- Byczkowski JZ, Kinkead ER, Leahy HF, Randall GM, Fisher JW. (1994b). Computer simulation of lactational transfer of tetrachloroethylene in rats using a physiologically based model. *Toxicol. Appl. Pharmacol.*, 125: 228 - 236.
- Byczkowski JZ, Lipscomb JC. (1999). Application of PB/PK model for assessment of the lactational transfer of MeHg to nursing infant. Society for Risk Analysis Annual Meeting, Atlanta, GA, 1999. Final Program P1-17, p. 47. Abstract on-line.
<<http://www.riskworld.com/Abstract/1999/SRAam99/ab9ab047.htm>>.
- Cone MV, Baldauf MF, Opresko DM, Uziel MS. (1983). Chemicals identified in human breast milk, a literature search. EPA 560/5-83-009, Washington, DC: EPA.
- Diehl-Jones WL, and Bols N. (2000). Use of response biomarkers in milk for assessing exposure to environmental contaminants: the case for dioxin-like compounds. *J. Toxicol. Environ. Health, Part B, Critical Rev.* 3:79-107.
- Dowdy DL, McKone TE. (1996). Prediction of food chain exposures from contaminated plants using quantitative structure activity relationships. Society for Risk Analysis 1996 Annual Meeting, Final Program.
- Eyster JT, Humphrey HEB, Kimbrough RD. (1983). Partitioning of polybrominated biphenyls (PBBs) in serum, adipose tissue, breast milk, placenta, cord blood, biliary fluid, and feces. *Arch. Environ. Health* 38:47-53.
- Fisher JW, Whittaker TA, Taylor DH, Clewell III HJ, Andersen ME. (1990). Physiologically based pharmacokinetic modeling of the lactating rat and nursing pup: A multiroute exposure model for trichloroethylene and its metabolite, trichloroacetic acid. *Toxicol Appl Pharmacol* 102:497- 513.
- Fleishaker JC, Desai N, McNamara PJ. (1987). Factors affecting the milk-to-plasma drug concentration ratio in lactating women: physical interactions with protein and fat. *J. Pharmaceutical Sci.* 76:189-193.
- Fomon SJ, Haschke F, Ziegler EE, Nelson SE. (1982). Body composition of reference children from birth to age 10 years. *Am. J. Clin. Nutrition* 35:1169 -1175.
- Frederick IB, White RJ, Braddock SW. (1986). Excretion of varicella-herpes zoster virus in breast milk. *Am. J. Obstet. Gynecol.* 154:1116-1117.
- Fujita M, Takabatake E. (1977). Mercury levels in human maternal and neonatal blood, hair and milk. *Bull. Environ. Contam. Toxicol.* 18: 205-209.
- Fürst P, Krüger Chr, Meemken H-A, Grobel W. (1989). PCDD and PCDF levels in human milk-dependence of the period of lactation. *Chemosphere.* 18:439-444.
- Fürst P, Fürst Chr, Wilmers K. (1994). Human milk as a bioindicator for body burden of PCDDs, PCDFs, organochlorine pesticides and PCBs. *Environ Health Perspect* 102(Suppl. 1):187-193.

- Gargas ML, Burgess RJ, Voisard DE, Cason GH, Andersen ME. (1989). Partition coefficients of low-molecular weight volatile chemicals in various liquids and tissues. *Toxicol Appl Pharmacol* 89:87-99.
- Gargas ML, Seybold PG, Andersen ME. (1988). Modeling the tissue solubilities and metabolic rate constant (Vmax) of halogenated methanes, ethanes, and ethylenes. *Toxicol. Lett.* 43: 235-256.
- George DI, O'Toole TJ. (1983). A review of drug transfer to the infant by breast-feeding: concerns for the dentist. *JADA* 106:204-208.
- Giroux D, Lapointe G, Baril M. (1992). Toxicological index and the presence in the workplace of chemical hazards for workers who breast-feed infants. *Am. Ind. Hyg. Assoc. J.*53:471-474.
- Grandjean P, Jorgensen PJ, Weihe P. (1994). Human Milk as a Source of Methylmercury Exposure in Infants. *Environ. Health Perspect.* 102:74-7.
- Grandjean P, Weihe P, White RF. (1995). Milestone development in infants exposed to methylmercury from human milk. *Neurotoxicology* 16:27-34.
- Harvey RA, Champe PC. (1992). *Lippincott's Illustrated Reviews: Pharmacology*, Philadelphia: J.B. Lippincott.
- Hoover S, Zeise L, Krowech G. (1991). Exposure to environmental contaminants through breast milk. In: *The Analysis, Communication, and perception of Risk* (Garrick BJ and Gekler WC, Eds) Plenum Press, NY, pp. 257-266.
- Hussein G, Mohamed F. (1999). Development of the first clinical classification of medications used during lactation and evaluation of 1380 drugs. *Clin. Research Reg. Affairs* 16:1-11.
- ICRP (International Commission on Radiological Protection). (1984). No. 23 Report on Reference Man. (Snyder WS, Cook MJ, Karhausen LR, Howells GP, Tipton IH, eds.). Elmsford, NY: Pergamon Press.
- International Atomic Energy Agency. (1994). Handbook of parameter values for the prediction of radionuclide transfer in temperate environment. Tech. Rep. Ser. No. 364, Vienna, Austria.
- Ito S, and Koren G. (1994). A novel index for expressing exposure of infants to drugs in breast milk. *Rev. J. Clin. Pharmacol.* 38:99-102.
- Kacew S. (1992). General principles in pharmacology and toxicology applicable to children. In: *Similarities and Differences Between Children and Adults: Implications for Risk Assessment* (Gruzellian PS, Henry CJ Olin SS Olin, eds.) Washington DC: Ilsi Press, 24-34.
- Jan J. (1983). Chlorobenzene residues in human fat and milk. *Bull. Environ. Contam. Toxicol.* 30:595-599.
- Jensen AA. (1983). Chemical contaminants in human milk. *Resid. Rev.* 89:1-50.
- Jensen AA, Slorach SA. (1991). *Chemical Contaminants in Human Milk*. CRC Press Inc., Boca Raton, FL.
- Kacew S. (1993). Adverse effects of drugs and chemicals in breast milk on the nursing infant. *J. Clin. Pharmacol.* 33:213-222.
- Kacew S. (1994). Current issues in lactation: advantages, environment, silicone. *Biomed. Environ. Sci.* 7:307-319.
- Kacew S. (1996a). Neonatal toxicology. In: *General and Applied Toxicology, Volume 2* (Ballantyne B, Marrs T, Turner P, eds.), Hants, England: Macmillan, 1047-1068.

- Kacew S. (1996b). Mammary heavy metal content: contribution of lactational exposure to toxicity in suckling infants. In: *Toxicology of Metals* (Chang LW, ed.), Boca Raton, Florida: CRC Press, 1129-1137.
- Kacew S. (1997). General principles in pediatric pharmacology and toxicology. In: *Environmental Toxicology in Human Development* (Kacew S, Lambert GH, eds.), Washington, DC: Taylor & Francis, 1-14.
- Keith HL, Walters DB. (1992). National Toxicology Program's chemical solubility database. Lewis Publishers, Boca Raton, FL.
- Laben RC, Archer TE, Crosby DG, Peoples SA. (1966). Milk contamination from low levels of DDT in diary rations. *J. Dairy Sci.* 49:1488-1494.
- LaKind JS, Berlin CM, Naiman DQ. (2001). Infant exposure to chemicals in breast milk in the United States: what we need to learn from a breast milk monitoring program. *Environ Health Perspect.* 109:75-88.
- Larson BL. (1978). *Lactation: A Comprehension Treatise, Volume IV*, Academic Press, New York.
- Leo A, Hanch C, Elkins D. (1971). Partition coefficients and their uses. *Chem. Rev.* 71:525-550.
- Lipscomb JC, Byczkowski JZ, Harvey T. (2000) Physiologically based pharmacokinetic modeling of the lactational transfer of methylmercury. In: *Metal Ions in Biology and Medicine* (Centeno JA, Collery P, Vernet G, Finkelman RB, Gibb H., Etienne JC, Eds.) Vol. 6, pp. 730-732, John Libbey Eurotext, Paris.
- Maxwell NI, Burmaster DE. (1993). A simulation model to estimate a distribution of lipid intake from breast milk during the first year of life. *J. Exposure Analysis Environ. Engineer.* 3:383-406.
- McKone TE, Maddalena RL, Dowdy DL, Hsieh DPH. (1995). Human exposures to air and soil contaminants through food products: defining and measuring the significant factors. Society for Risk Analysis 1995 Annual Meeting, Final Program.
- Meskin MS, Lien EJ. (1985). QSAR Analysis of drug excretion into human breast milk. *J. Clin. Hospital Pharmacy* 10:269-278.
- Meylan WM, Howard PH, Boethling RS, Aronson D, Printup H., Gouchie S. (1999). Improved method for estimating bioconcentration/bioaccumulation factor from octanol/water partition coefficient. *Environ. Toxicol. Chem.* 18: 664-672.
- Minamishima I, Ueda K, Minematsu T, Minamishima Y, Umemoto M, Take H, Kuraya K. (1994). Role of breast milk in acquisition of cytomegalovirus infection. *Microbiol Immunol* 38:549-552.
- Nation RL, Hotham NH. (1976). Drugs and breast feeding. *Med. J. Australia* 146:308-313.
- National Cancer Institute (on-line): Study of exposure of I-131 from Nuclear Bomb Fallout. Technical Summary TS.3: Estimation of ¹³¹I Concentrations in Fresh Cows' Milk. Published on-line: <<http://rex.nci.nih.gov/massmedia/techsumtoc.html>>.
- National Council on Radiation Protection Measurement. (1989). *Screening Techniques for Determining Compliance with Environmental Standards. Releases of Radionuclides to the Atmosphere.* January 1989. Bethesda, MD.
- Neville MC, Walsh CT. (1995). Effects of xenobiotics on milk secretion and composition *Am. J. Clin. Nutr.* 61(Suppl):687S-694S.

- Neville MC, Keller R, Seacat J, Lutes V, Neifert M, Casey C, Allen J, Archer P. (1988). Studies in human lactation: milk volumes in lactating women during the onset of lactation and full lactation. *Am. J. Clin. Nutr.* 48:1375-1386.
- Newton DW, Kluza RB. (1978). pK_a values of medicinal compounds in pharmacy practice. *Drug Intell. Clin. Pharm.* 12:546-554.
- O'Flaherty EJ. (1991). Physiologically based models for bone-seeking elements: III Human skeletal and bone growth. *Toxicol. Appl. Pharmacol.* 111:332-341.
- Oskarsson A, Hallen IP, Sundberg J. (1995). Exposure to toxic elements via breast milk. *Analyst.* 120: 765-770.
- Peaker M. (1976). Lactation: some cardiovascular and metabolic consequences, and the mechanism of lactose and ion secretion into milk. *Ciba Foundation Symposium* 45:87-101.
- Pecorari D. (1984). Translactal passage and pharmacotherapy of lactation, in: *Clinical Pharmacology in Pregnancy: Fundamentals and Rational Pharmacotherapy*, (eds. HP. Kuemmerle and K. Brendel), New York: Thieme-Stratton, Inc., pp. 252-259.
- Poitrast BJ, Keller WC, Elves RG. (1985). A guide to the estimation of the hazard presented by chemicals in human milk. USAFOEHL Report No. 85-185CO111LCE, USAF Occupational and Environmental Health Laboratory Aerospace Medical Division. US Natl Technical Inform Service, Brooks Air Force Base, TX.
- Pons G, Rey E, Matheson I. (1994). Excretion of psychoactive drugs into breast milk: Pharmacokinetic principles and recommendations. *Clin. Pharmacokinetics* 27: 270-289.
- Prentice AM, Goldberg GR, Prentice A. (1994). Body mass index and lactation performance. *Eur. J. Clin. Nutr.* 48(Suppl.3):S78-S89.
- Rane A, Wilson JT. (1976). Clinical pharmacokinetics in infants and children. *Clin. Pharmacokinet.* 1:2-24.
- Rasmussen F. (1971). Excretion of drugs by milk. In: *Concepts in biochemical pharmacology*, part 1, (eds., Brodie BB and Gillette JR), Springer-Verlag, New York. pp. 390-402.
- Rasmussen F. (1973). The mechanism of drug secretion into milk, in: *Dietary lipids and postnatal development*. (eds., C. Galli, G. Jacini, and A. Pecile), New York: Raven, pp. 231-245.
- Reinhardt D, Richter O. (1984). Pharmacokinetics of translactal passage. In: *Clinical Pharmacology in Pregnancy: Fundamentals and Rational Pharmacotherapy*, (eds. HP. Kuemmerle and K. Brendel), New York: Thieme-Stratton, Inc. pp. 260-268.
- Riordan J, Riordan M. (1984). Drugs in breast milk. *Am. J. Nursing* 84:328-332.
- Risk Assessment Information System: RAIS-ORNL. (2001). Toxicity Values Database, Published online: <<http://risk.lsd.ornl.gov/tox/toxvals.shtml>>.
- Rogan WJ, Gladen BC. (1993). Breast-feeding and cognitive development. *Early Human Develop* 31:181-193.
- Rubow SM, Klopper J, Wassernan H, Baard B, van Niekerk M. (1994). The excretion of radiopharmaceuticals in human breast milk: additional data and dosimetry, *Eur. J. Nucl. Med.* 21:144-153.
- Schecter A, Ryan JJ, Papke O. (1998). Decrease in levels and body burden of dioxins, dibenzofurans, PCBs, DDE, and HCB in blood and milk in a mother nursing twins over a thirty-eight month period. *Chemosphere.* 37(9-12):1807-1816.

- Schreiber JS. (1992). An assessment of tetrachloroethene in human breast milk. *J. Exp. Anal. Envir. Epidem.* 2:15-26.
- Schreiber JS. (1997). Transport of organic chemicals to breast milk: tetrachloroethene case study. In: *Environmental Toxicology in Human Development* (Kacew S, Lambert GH, eds.), Washington DC: Taylor & Francis, 95-143.
- Shelley ML, Andersen ME, Fisher JW. (1988). An inhalation distribution model for the lactating mother and nursing child. *Toxicol Lett* 43:23-29.
- Shelley ML, Anderson ME, Fisher JW. (1989). A risk assessment approach for nursing infants exposed to volatile organics through the mother's occupational inhalation exposure. *Appl Ind Hyg* 4:21-26.
- Smith AH. (1987). Infant exposure assessment for breast milk dioxins and furans derived from waste incineration emissions. *Risk Anal.* 7:347-353.
- Stabin MG, Stubbs JB, Toohey RE. (1995). Radiation doses to a nursing infant from radiopharmaceuticals administered to the mother, Radiation Internal Dose Information Center, Medical Sciences Division, Oak Ridge Institute for Science and Education, Oak Ridge, TN.
- Sullivan MJ, Custance SR, Miller CJ. (1991). Infant exposure to dioxin in mother's milk resulting from maternal ingestion of contaminated fish. *Chemosphere.* 23:1387-1396.
- Sundberg J, Jonsson S, Karlsson MO, Hallen IP, Oskarsson A. (1998). Kinetics of methylmercury and inorganic mercury in lactating and nonlactating mice. *Toxicol. Appl. Pharmacol.* 151:319-329.
- Sundberg J, Oskarsson A, Albanus L. (1991). Methylmercury exposure during lactation: milk concentration and tissue uptake of mercury in the neonatal rat. *Bull. Environ. Contam. Toxicol.* 46: 255-262.
- Travis CC. (1989). *Organic Chemicals in Breast Milk: Risk to the Infant*. U.S. Department of Energy, Conf-8811124-1/ DE89 002207.
- Travis CC, Arms AD. (1988). Bioconcentration of organics in beef, milk and vegetation. *Environ. Sci. Technol.* 22: 271-279.
- Travis CC, Hattemer-Frey HA, Arms A. (1988). Relationship between dietary intake of organic chemicals and their concentrations in human adipose tissue and breast milk. *Arch. Environ. Contam. Toxicol.* 17:437-478.
- U.S. EPA. (1997a) *Exposure Factors Handbook, Volume II - Food Ingestion Factors*. Washington DC: U.S. Environmental Protection Agency. (August 1997). EPA-600-P-95-002Fa. Published on-line. <<http://www.epa.gov/ncea/exposfac.htm>>.
- U.S. EPA. (1997b). *Mercury Study Report to Congress, Volume V: Health Effects of Mercury and Mercury Compounds*. U.S. Environmental Protection Agency, Office of Air Quality Planning and Standards, and Office of Research and Development, EPA-452/R-97-007.
- U.S. EPA. (1998). *Methodology for Assessing Health Risks Associated with Multiple Pathways of Exposure to Combustor Emissions (Update to EPA/600/6-90/003, Methodology for Assessing Health Risks Associated With Indirect Exposure to Combustor Emissions)*. EPA 600/R-98/137, U.S. Environmental Protection Agency, National Center for Environmental Assessment, Cincinnati, OH. Published on-line: <http://www.epa.gov/mcea/pdfs/combust/complet0_11.pdf>.
- Vorherr H. (1974). *The Breast: Morphology, Physiology, and Lactation*, Academic Press, New York.
- West CE, Horton BJ. (1976). Transfer of polycyclic hydrocarbons from diet to milk in rats, rabbits and sheep. *Life Sci.* 19:1543-1547.

- White GJ, White MK. (1980). Breastfeeding and drugs in human milk. *Vet. Hum. Toxicol.* 22:1-44.
- Whitehead RG, Paul AA. (1981). Infant growth and human milk requirements. *Lancet.* ii:161-163.
- Wilson JT. (1981). Pharmacokinetics of drug excretion. In: *Drugs in Breast Milk*, (ed. J.T. Wilson), ADIS Press, Australia.
- Wilson JT, Hinson JL, Brown RD, Smith IJ. (1986). A comprehensive assessment of drugs and chemical toxins excreted in breast milk. In: *Human Lactation 2: Maternal and Environmental Factors*, (eds. M. Hamosh and A.S. Goldman), New York: Plenum Press.
- Wilson JT, Brown RD, Cherek DR, Dailey JW, Hilman B, Jobe PC, Manno BR, Manno JG, Redezkic HM, Stewart JS. (1980). Drug excretion in human breast milk. Principles, pharmacokinetics and projected consequences. *Clin. Pharmacokinet.* 5:1-66.
- Wilson JT, Brown RD, Hinson JL, and Dailey JW. (1985). Pharmacokinetic pitfalls in the estimation of the breast milk/plasma ratio for drugs. *Ann. Rev. Pharmacol. Toxicol.* 25:667-689.
- Wolff MS. (1983). Occupationally derived chemicals in breast milk. *Am. J. Ind. Med.* 4:259-281.

Table 4-1. Infant Conditions for Which Risk Is Reduced by Breast-Feeding

Condition
Infant mortality
Sudden infant death syndrome
Lower respiratory tract disease
Food allergies
Atopic dermatitis
Otitis media
Immune system disorders
(a) Lymphomas
(b) Celiac disease
(c) Insulin-dependent diabetes mellitus
(d) Inflammatory bowel disease
(e) Crohn's disease
(f) HIV-related mortality
Cholera
<i>Giardia lamblia</i> diarrhea
Rotavirus diarrhea
Shigellosis
Bacteremia and meningitis
Chronic liver disease

Source: Kacew 1994

Table 4-2. Some Occupationally Derived Toxic Chemicals That May Present Hazards to Nursing Infants of the Exposed Mothers

Chemical Name:	CAS No.:	NIOSH No.:	M.W.:	TLV - TWA:
Milk:				
Notes:				
1,1,2-Trichloro-1,2,2-trifluoroethane	76-13-1	KJ4000000	187	1000 ppm; 7670 mg/m ³
Detected in human milk				
Acetone	67-64-1	AL3150000	58	750 ppm; 1780 mg/m ³
Detected in human milk				
sw>100mg/ml, logKow -0.24				
Antimony	7440-36-0	CC4025000	122	0.5 mg/m ³
Excreted in human milk				
Antimony oxide (3+)	1309-64-4	CC5650000	292	0.5 mg/m ³ as Sb
Excreted in human milk				
sw<1mg/ml				

Table 4-2. Some Occupationally Derived Toxic Chemicals That May Present Hazards to Nursing Infants of the Exposed Mothers (continued)

Benzene	71-43-2	CY1400000	78	10 ppm; 32 mg/m ³
Detected in human milk				
sw 1-5mg/ml, logKow 1.95, M/P 1.2				
Butanol-1	71-36-3	ED1400000	74	50 ppm; 152 mg/m ³
Detected in human milk				
sw>100mg/ml, logKow 0.88				
Butanol-2 (sec-butyl alcohol)	78-92-2	ED1750000	74	100 ppm; 303 mg/m ³
Detected in human milk				
sw>100mg/ml				
Butanone-2 (Methyl ethyl ketone)	78-93-3	EL6475000	72	200 ppm; 590 mg/m ³
Detected in human milk				
logKow 0.28				
Cadmium (metal)	7440-43-9	EU9800000	112	0.05 mg/m ³
Excreted in animal milk				

Table 4-2. Some Occupationally Derived Toxic Chemicals That May Present Hazards to Nursing Infants of the Exposed Mothers (continued)

Cobalt (metal)	7440-48-4	GF8750000	59	0.05 mg/m ³
Excreted in animal milk				
Cobalt chloride (2+)	7646-79-9	GF9800000	238	0.05 mg/m ³ as Co
Excreted in human milk				
Copper (2+ sulfate)	7758-99-8	GL8900000	250	1 mg/m ³ as Cu
Excreted in human milk				
Copper (metallic)	7440-50-8	GL5325000	64	0.2 mg/m ³ (fume); 1 mg/m ³ (dust & mists)
Excreted in animal milk				
Copper sulfate (anhydrous)	7758-98-7	GL8800000	160	1 mg/m ³ as Cu
Excreted in human milk				
sw 199mg/ml				

Table 4-2. Some Occupationally Derived Toxic Chemicals That May Present Hazards to Nursing Infants of the Exposed Mothers (continued)

Cyclohexane	110-82-7	GU6300000	84	300 ppm; 1030 mg/m ³
Detected in human milk	sw<1mg/ml			
Dichlorodifluoromethane	75-71-8	PA8200000	121	1000 ppm; 4950 mg/m ³
Detected in human milk				
Ethyl alcohol	64-17-5	KD6300000	46	1000 ppm; 1880 mg/m ³
Excreted in human milk	sw>100mg/ml, log Kow -0.32, M/P 0.9			
Ethyl benzene	100-41-4	DA0700000	103	100 ppm; 434 mg/m ³
Detected in human milk	sw<1mg/ml			
Fluorotrichloromethane (Trichlorofluoromethane)	75-69-4	PB6125000	137	1000 ppm; 5620 mg/m ³
Detected in human milk				

Table 4-2. Some Occupationally Derived Toxic Chemicals That May Present Hazards to Nursing Infants of the Exposed Mothers (continued)

Isopropyl alcohol			
67-63-0			
	NI8050000		
		60	
			400 ppm; 983 mg/m ³
Detected in human milk			
sw>100mg/ml			
Lead (inorganic)			
7439-92-1			
	OF7525000		
		207	
			0.15 mg/m ³
Excreted in animal milk			
Lead chromate (oxide)			
18454-12-1			
	OF9800000		
		546	
			0.05 mg/m ³ as Pb; 0.012 mg/m ³ as Cr
Excreted in animal milk			
Lead dioxide			
1309-60-0			
	DG0700000		
		239	
			0.15 mg/m ³ as Pb
Excreted in animal milk			
Lead tetraoxide			
1314-41-6			
	DG5425000		
		686	
			0.15 mg/m ³ as Pb
Excreted in animal milk			

Table 4-2. Some Occupationally Derived Toxic Chemicals That May Present Hazards to Nursing Infants of the Exposed Mothers (continued)

Manganese	7439-96-5	OO9275000	55	5 mg/m ³ (dust and compounds); 1 mg/m ³ (fumes)
Excreted in animal milk				
Mercury (metal)	7439-97-6	OV4550000	201	0.1 mg/m ³ (compounds); 0.01 mg/m ³ (alkyl); 0.05 mg/m ³ (vapor)
Excreted in human milk				
Mercury oxide (2+)	21908-53-2	OW8750000	217	0.1 mg/m ³ as Hg
Excreted in animal milk				
Methylene chloride	75-09-2	PA8050000	85	50 ppm; 174 mg/m ³
Excreted in human milk sw 10-15mg/ml				
Naphthenic acid lead salt (Cyclohexanecarboxylic acid lead salt)	61790-14-5	QK9150000	1579	0.15 mg/m ³ as Pb
Excreted in animal milk				

Table 4-2. Some Occupationally Derived Toxic Chemicals That May Present Hazards to Nursing Infants of the Exposed Mothers (continued)

Phenyl mercuric acetate 62-38-4 OV6475000 337	0.1 mg/m ³ as Hg
Excreted in animal milk	
Styrene 100-42-5 WL3675000 104	50 ppm; 213 mg/m ³
Detected in human milk sw<1mg/ml	
Tetrachloroethylene (Perchloroethylene) 127-18-4 KX3850000 166	50 ppm; 339 mg/m ³
Excreted in human milk A case of exposure through breast milk described: Exposed mother, milk level 1 mg/dL, jaundice in infant, sw 0.15mg/ml, logKow 2.88, M/P 3.3	
Toluene 108-88-3 XS5250000 92	100 ppm; 375 mg/m ³
Detected in human milk sw<1mg/ml, log Kow 2.71	
Xylene 1330-20-7 ZE2100000 106	100 ppm; 434 mg/m ³
Detected in human milk sw<1mg/ml, log Kow 3.15	

Table 4-2. Some Occupationally Derived Toxic Chemicals That May Present Hazards to Nursing Infants of the Exposed Mothers (continued)

Zinc (metal)	7440-66-6	ZG8600000	65	1 mg/m ³ (fume)
Excreted in animal milk	sw < 1 mg/ml			
Zinc chloride	7646-85-7	ZH1400000	136	1 mg/m ³ (fume)
Excreted in animal milk	sw 3620 mg/ml			
Zinc oxide	1314-13-2	ZH4810000	81	5 mg/m ³ (fume); 10 mg/m ³ (dust)
Excreted in animal milk	sw < 1 mg/ml			

Source: Byczkowski (1997).

Notes: TLV - TWA (Threshold Limit Values as listed by ACGIH, 1991). Milk: relevance to lactational transfer (for details, see Byczkowski et al., 1994a). sw = solubility in water (Keith et al. 1992); logK_{ow} = log partition coefficient octanol/water (– negative value = better solubility in water than in octanol); M/P = milk/plasma partition coefficient (Poitras et al. 1985)

Table 4-3. Ranges of Water Solubility and Octanol/Water Partition Coefficients for Typical Chemical Contaminants of Breast Milk

Chemical	Mol. Weight	Water Solubility (mg/L)	Log Kow
Phenol	94.18	6600	1.5
2,4 Dichlorophenol	163	6194	3.1
Benzene	78.1	1780	2.1
Toluene	92.1	515	2.7
Chlorobenzene	112.6	484	2.8
para-Xylene	106.2	215	3.2
1,2,4 Trichlorobenzene	181.4	40	4.1
1,2,3 Trichlorobenzene	181.4	21	4.1
2,3,4,5,6 Pentachlorophenol	266.4	14	5
Biphenyl	154.2	7	3.9
PCB 4 (Cl-2,2')	223.1	1	4.9
1,2,3,4,5 Pentachlorobenzene	250.3	0.65	5
PCB 47 (Cl-2,2',4,4')	292	0.09	5.9
PCB 95 (Cl-2,2',3,5',6)	326.4	0.034	6.1
PCB 52 (Cl-2,2',5,5')	292	0.03	6.1
PCB 99 (Cl-2,2',4,4',5)	326.4	0.018	6.5
PCB 101 (Cl-2,2',4,5,5')	326.4	0.01	6.4
PCB 15 (Cl-4,4' 2)	23.1	0.008	5.3
Hexachlorobenzene	284.8	0.005	5.5
Benzo(a)pyrene	252.3	0.0038	6.1
PCB 138 (Cl-2,2',3,4,4',5')	360.9	0.0017	6.8
PCB 77 (Cl-3,3',4,4')	292	0.001	6.5
PCB 153 (Cl-2,2',4,4',5,5')	360.9	0.001	6.9
PCB 128 (Cl-2,2',3,3',4,4')	360.9	0.0006	7
PCDF 83 (Cl-2,3,7,8)	306	0.00042	5.7
PCDF 114 (Cl-2,3,4,7,8)	340.4	0.00024	6.9
PCDF 131 (Cl-1,2,3,4,6,7,8)	409.3	0.000014	7.9
PCDD 48 2,3,7,8	322	0.000019	6.7
PCB 209 (Cl-23456-2'3'4'5'6')	498.7	0.000001	8.3

Source: EPA (1998).

Table 4-4. Major PCB Congeners in Human Milk from Upstate New York and Their Milk : Blood Concentration Ratios

PCB Congener	Mean + SE (ng/g Whole milk)	Whole Milk:Maternal Blood Ratio
153	3.2 + 0.4	10
118 (not 179)	2.5 + 0.3	9.2
138	2.1 + 0.4	3.5
70 or 74	1.7 + 0.2	>500
180	1.2 + 0.1	9.4
99	1.1 + 0.1	8.9
156	1.0 + 0.1	125
105	1.0 + 0.2	3.8

Source: Bush et al. (1985)

Table 4-5. Exogenous Factors Affecting Milk Yield in Humans

Factors	Description	Effect	
<i>Maternal</i>	Nutritional state - subcutaneous fat gain during pregnancy, frequent meals, adequate caloric intake, adequate fluids intake	Increase	
	- undernutrition, inadequate diet, thirst	Decrease	
	Physical activity - moderate, light work	Increase	
	- hard work, inactivity	Decrease	
	Mechanical - complete expression of milk remaining after each breast-feeding	Increase	
	- incomplete expression of milk	Decrease	
	Physiological factors - conditioning, wet nurses	Increase	
	- menses, sequential reproduction, prolonged lactation, very young age	Decrease	
	Psychological factors - loving, assuring environment	Increase	
	- psychosocial stress	Decrease	
	Hormonal and iatrogenic factors - oxytocin, prolactin, growth hormone, thyroid hormone, cortisol, insulin	Increase	
	- prolactin inhibiting factor, oral contraceptives, nicotine, drugs of abuse	Decrease	
	<i>Infant</i>	Number of offspring - twins and multiple	Increase
		- single	Decrease
Body weight - large infant		Increase	
- small infant		Decrease	
Sucking amount and vigor - frequent and vigorous		Increase	
- infrequent and apathetic		Decrease	
Behavior - loving relationship, good emotional and psychosocial bonds		Increase	
- stress of breast-feeding, lack of emotional bonding	Decrease		

Source: Wilson et al. (1980).

Table 4-6. Milk Transfer Coefficients (F_m, expressed in day/kg) Estimated for Some Ubiquitous Radionuclides

Chemical	CAS #	Milk Transfer Coeff.(day/kg)	Ref.
As	NA	6.0E-05	[B]
Ba	13981414	4.8E-04	[A]
Be	13966024	9.0E-07	[B]
Bi	14331794	5.0E-04	[B]
Br	14686692	2.0E-02	[B]
Cd	14109321	1.0E-03	[B]
Ce	14119198	3.0E-05	[A]
Co	13981505	7.0E-05	[A]
Cr	14392020	1.0E-05	[A]
Cs	14914762	7.9E-03	[A]
Cu	13981254	1.5E-03	[B]
F	13981561	1.0E-03	[B]
Pu	14119336	1.1E-06	[A]
Ra	13981538	1.3E-03	[A]
Rb	14391630	1.2E-02	[A]
Sr	14809508	2.8E-03	[A]
Tc	14808447	1.4E-04	[A]
Te	14269717	4.5E-04	[A]
Th	15594544	5.0E-06	[C]
Tl	14913509	2.0E-03	[B]
U	15117961	4.0E-04	[A]
V	14331976	2.0E-05	[B]

[A] International Atomic Energy Agency (1994); [B] Baes et al. (1984); [C] National Council on Radiation Protection Measurement (1989).

Source: Risk Assessment Information System (on-line)
 <http://risk.lsd.ornl.gov/cgi-bin/tox/TOX_select?select=rad>

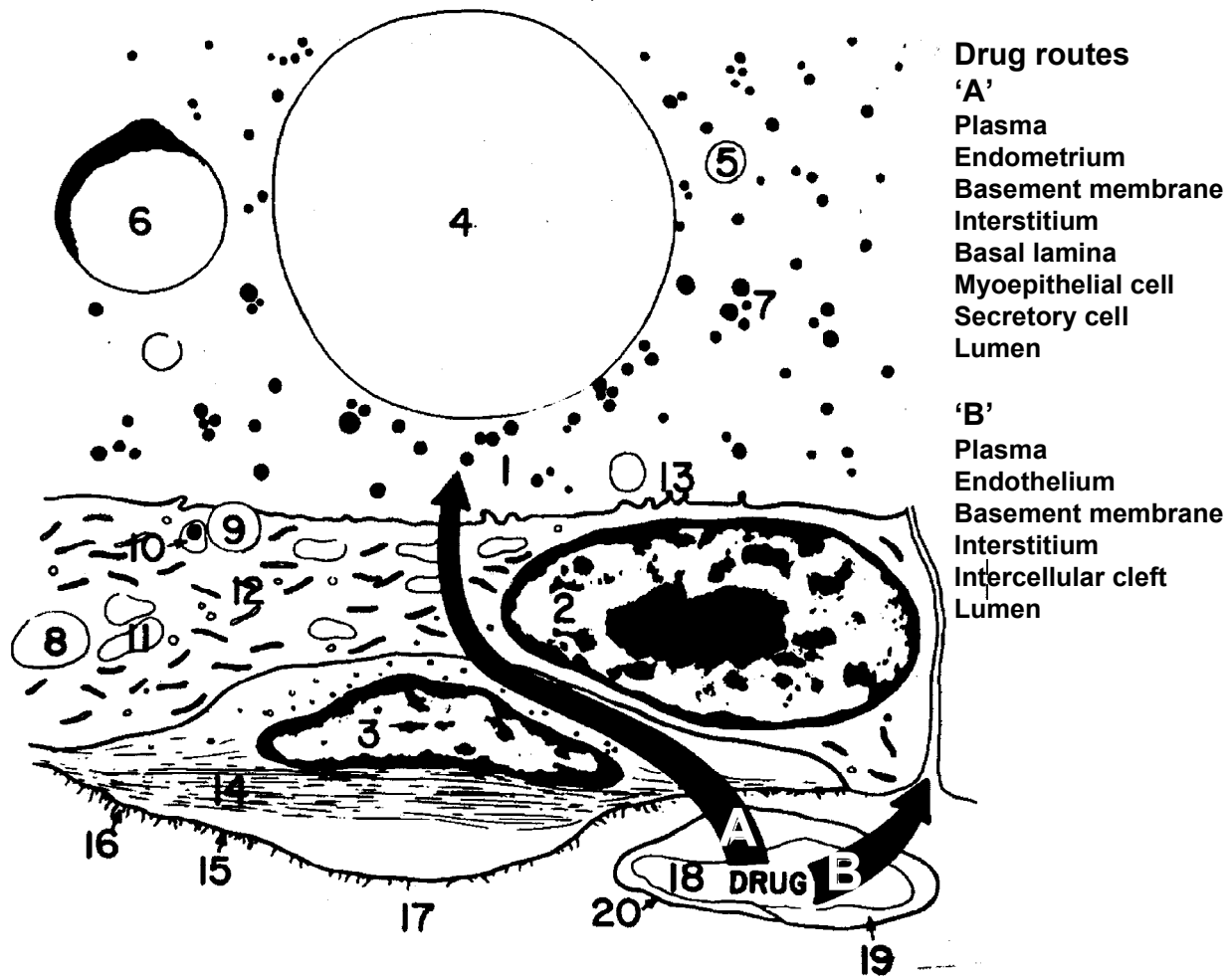

Figure 4-1. A scheme of a lactational transfer of a chemical from maternal blood (redrawn with permission from Wilson et al., 1980)

(1) Lumen of alveolus (2) Nucleus of secretory epithelial cell (3) Nucleus of myoepithelial cell (4) Large milk droplet suspended in luminal fluid (5) Small milk droplet (6) Lipid droplet retaining detached peripheral coast of cytoplasm (7) Milk protein particles (8) lipid droplet in cell cytoplasm (9) Lipid droplet near cell surface (10) Protein particle in a vacuole (11) Mitochondrion (12) Short profiles of granular endoplasmic reticulum (13) Short microvilli (14) Bundle of myofilaments (15) Basal lamina (16) Reticular fibrils (17) loose connective tissue (18) Lumen of blood capillary (19) Endothelium (20) Basal lamina of capillary

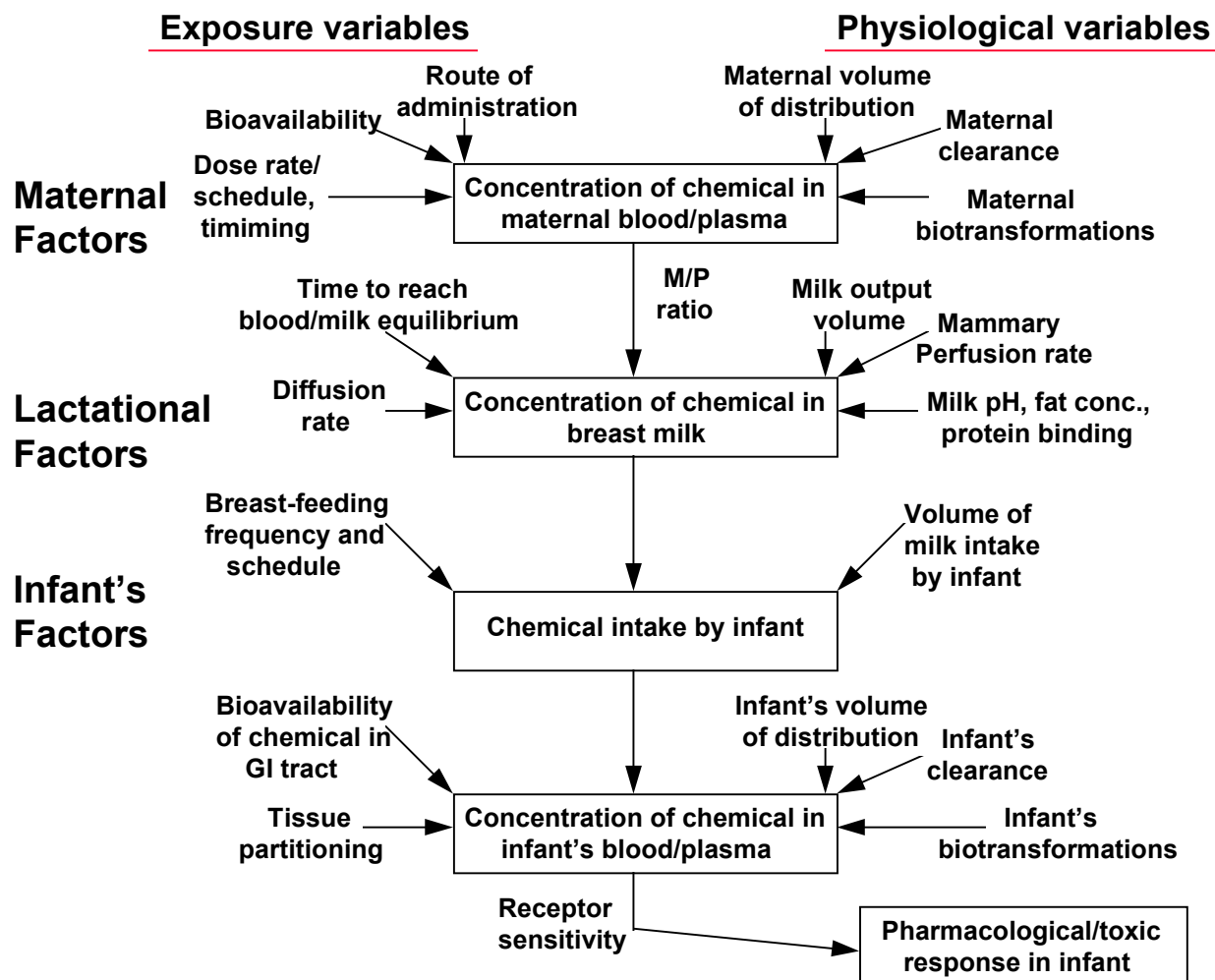

Figure 4-2. Essential factors and pharmacokinetic variables affecting pharmacological/toxic response in an infant to drugs or other chemicals transferred to breast milk.

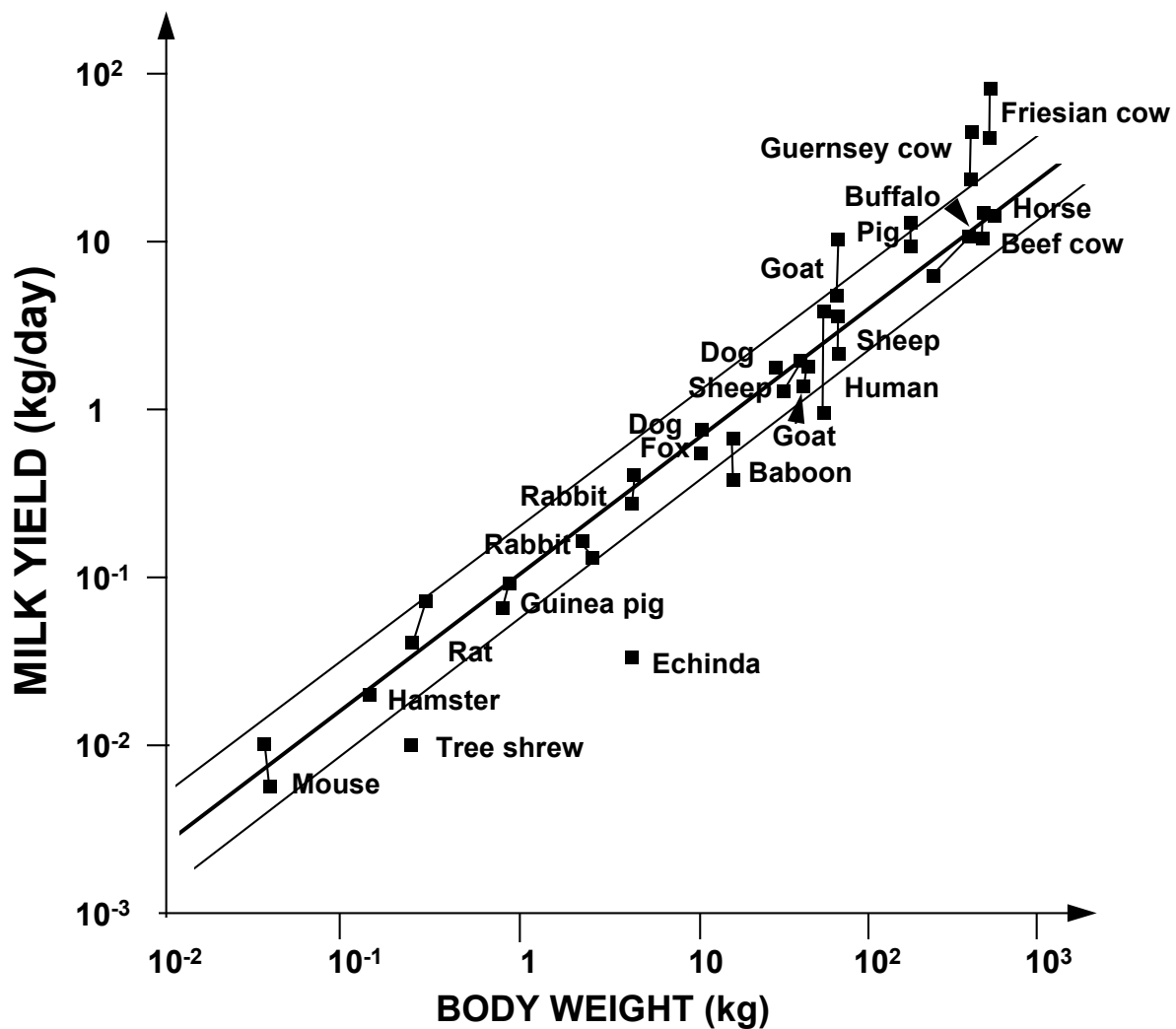

Figure 4-3. A relationship between the daily milk yield and body weight for different species (data from Peaker 1976)

Quantitative steady-state model of lactational transfer as a part of multimedia exposure pathways to human

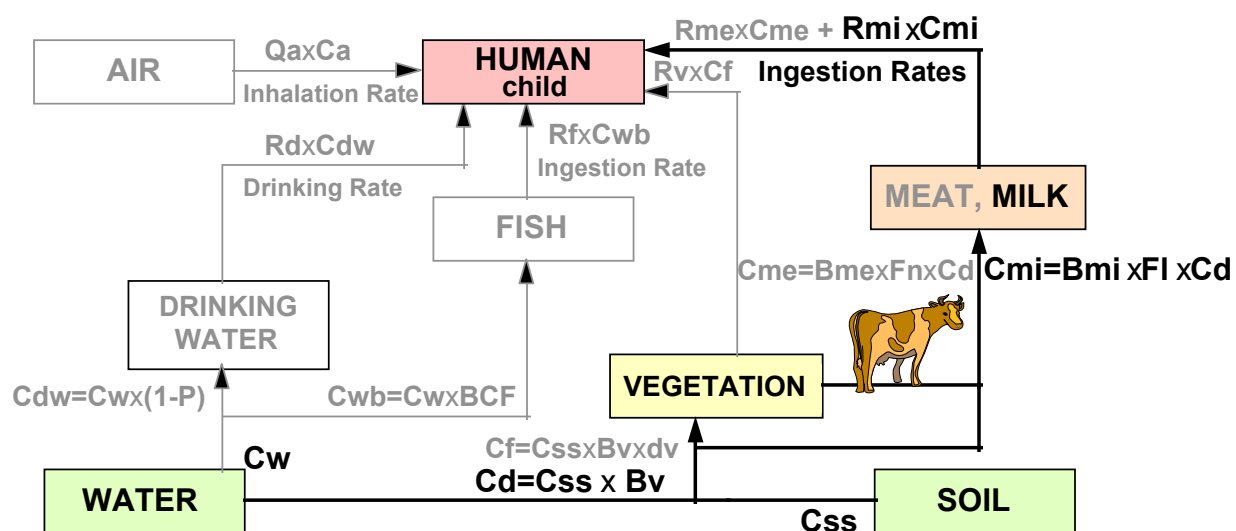

Figure 4-4. A steady-state model of quantitative relations in the multimedia chemical exposure pathways to human child with lactational transfer emphasized

Symbols: Concentrations: C_a - in air (mg/L); C_w - in natural water (mg/L); C_{dw} - in drinking water (mg/L); C_{wb} - in aquatic biota, including fish (mg/kg); C_{ss} - in solid soil (mg/kg); C_f - in fresh vegetation (mg/kg); C_d - in dry vegetation (mg/kg); C_{me} - in meat (mg/kg); C_{mi} - in milk (mg/kg); Bioconcentration factor: BCF - for aquatic biota, including fish (L/kg); Biotransfer factors: B_v - for vegetation (mg/kg dry plant); B_{me} - for meat (day/kg); B_{mi} - for milk (day/kg); Daily Rates: Q_a - alveolar ventilation (L/day); R_d - drinking water ingestion (L/day); R_f - fish ingestion (kg/day); R_v - vegetation ingestion (kg/day); R_{me} - meat ingestion (kg/day); R_{mi} - milk ingestion (kg/day); F_n - dry feed ingestion by nonlactating cow (kg/day); F_l - dry feed ingestion by lactating cow (kg/day); Ratios: P - purification efficiency (ratio); d_v - dry to fresh plant weight (ratio).

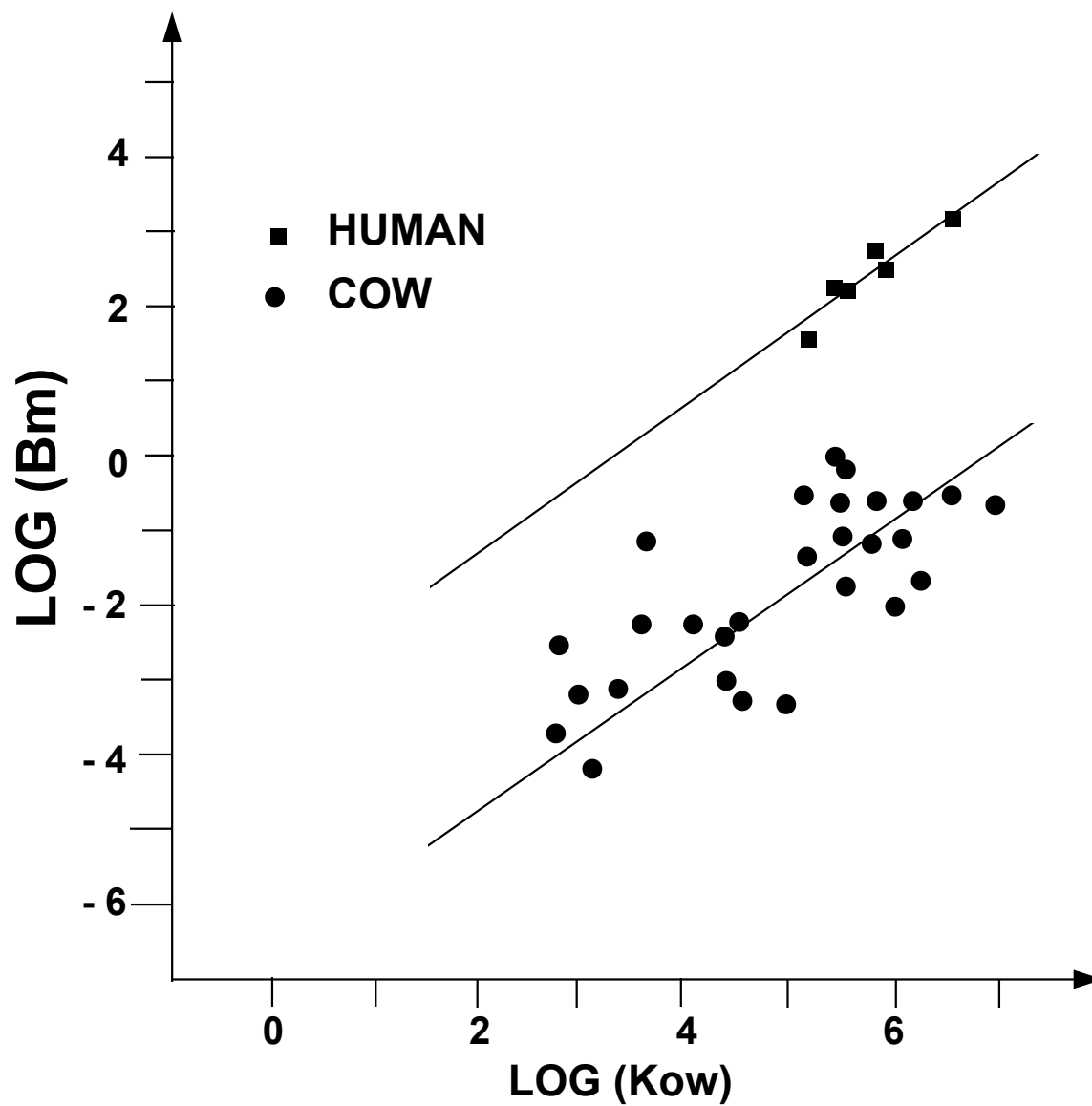

Figure 4-5. A relationship between biotransfer factors (Bm) and octanol/water partition coefficients (Kow) for organic chemicals in human breast milk fat and cow milk fat (data from Travis et al. 1988).

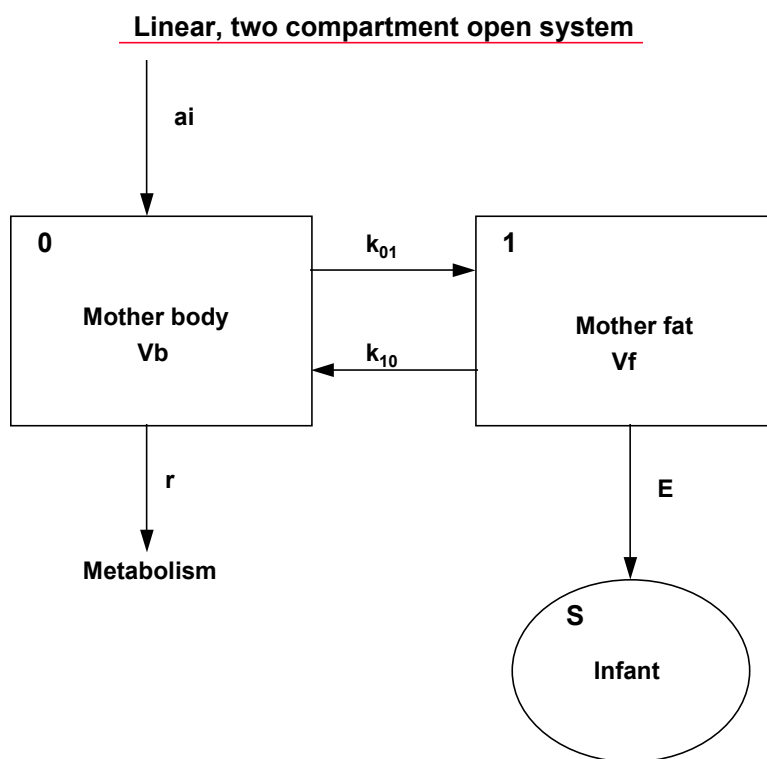

Figure 4-6. Schematic diagram of the linear, two compartment open classical pharmacokinetic model applicable to lactational transfer of lipophilic drugs and other chemicals

0 – central compartment; 1 – peripheral compartment; S sink; k_{01} – transport rate constant from central to peripheral compartment; k_{10} – transport rate constant from peripheral to central compartment; a_i – bioavailability (F) x ingested dose; V_b – volume of mother's body excluding fat; V_f – volume of mother's fat compartment; r – the metabolic elimination rate constant; E – amount eliminated with breast milk.

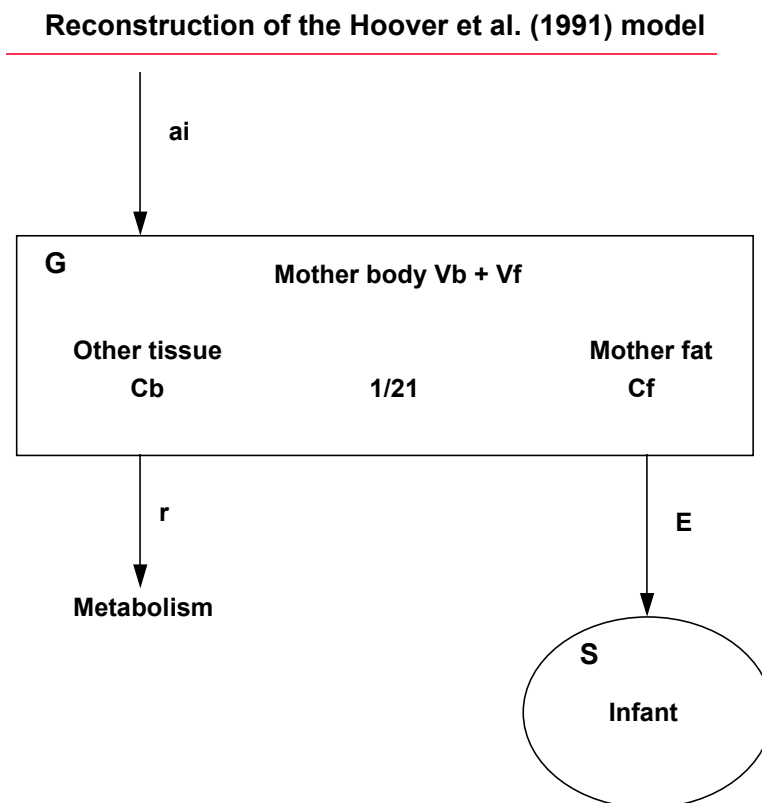

Figure 4-7. Schematic diagram of the linear, one-compartment open pharmacokinetic system described mathematically by Hoover et al. (1991)

G – global compartment; S – sink; ai – 0.9 x ingested dose; Vb – volume of mother’s body excluding fat; Vf – volume of mother’s fat compartment; Cb – concentration in tissues other than fat; Cf – concentration in fat; 1/21 – proportion of TCDD concentration in other tissues to that in fat; r – the metabolic elimination rate constant; E – amount eliminated with breast milk. Governing algorithm for TCDD:

$$C_f = k_{fb} \cdot (C_b \cdot \text{EXP}(-r \cdot V_b \cdot t / (V_b + k_{fb} \cdot V_f)))$$

where Cf is TCDD concentration in fat (milk and/or body fat; pg/kg of fat) without accounting for losses due to breast-feeding; kfb is partition coefficient fat/body (21; ratio); Cb is estimate of initial concentration of TCDD (pg/kg BW) in the body at t=0; r is first order biological elimination rate constant in mother (1/days), calculated as $(1+k_{fb}) \cdot (V_f/V_b) \cdot 0.693/t_{half}$ ($t_{half} = 2920$ days eq. 8 years); Vb is volume of body that is not fat (1-Vf; fraction of BW); Vf is volume of fat (0.3; fraction of BW). The TCDD concentration in fat at steady state (zero order kinetics, when $t \rightarrow \infty$) was estimated as:

$$C_{fss} = (a \cdot k_{fb} \cdot \text{PDOSE}) / (r \cdot V_b)$$

where Cfss is concentration in fat (pg/kg fat); a is fraction of TCDD that is absorbed (0.9; ratio); PDOSE is oral TWA dose of TCDD (pg/kg BW/day). * is a multiplication sign.

Source: Hoover et al. (1991).

Schematic representation of a chemical mass flow in the PBPK model

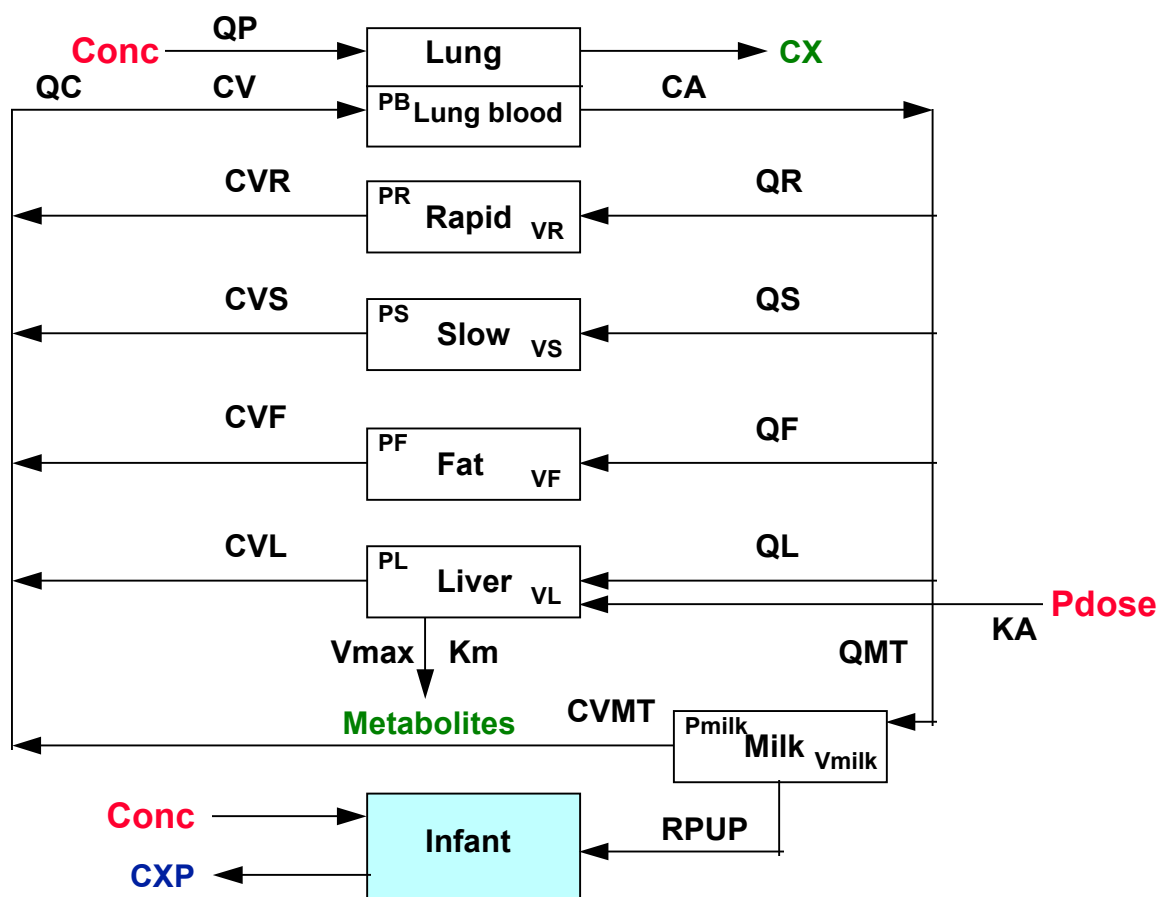

Figure 4-8. Schematic diagram of the PB/PK model of lactational transfer of drugs and other chemicals developed by Byczkowski and Fisher (1994) for tetrachloroethylene

Conc – concentration in inhaled air (mg/L); Pdose – oral dose (mg/kg); KA – gastrointestinal absorption rate constant (1/h); QP – alveolar ventilation rate adjusted for body weight (L/h); CX – concentration in exhaled air (mg/L); QC – cardiac output adjusted for body weight (L/h); CV – concentration in mixed venous blood (mg/L); CA – concentration in arterial blood (mg/L); CVF – venous concentration leaving the fat tissue (mg/L); QF – blood flow to fat (L/h); CVS – venous concentration leaving the slowly perfused tissues (mg/L); QS – blood flow to slowly perfused tissues (L/h); CVR – venous concentration leaving the rapidly perfused tissues (mg/L); QR – blood flow to rapidly perfused tissues (L/h); CVL – venous concentration leaving the liver tissue (mg/L); QL – blood flow to liver (L/h); CXP – concentration in air exhaled by infant (mg/L); CVMT – venous concentration leaving the mammary glands tissue (mg/L); RPUP – elimination rate for PCE from milk to infant (mg/h); Vmax – pseudo-maximal velocity of PCE metabolism (mg/h); Km – apparent Michaelis-Menten constant for PCE metabolism (mg/L); VR – volume of rapidly perfused tissues (kg); VS – volume of slowly perfused tissues (kg); VF – volume of fat (kg); VL – volume of liver tissue (kg); Vmilk – volume of milk (L); PB – partition coefficient blood/air; PR – partition coefficient rapidly perfused tissue/blood (ratio); PS – partition coefficient slowly perfused tissue/blood (ratio); PF – partition coefficient fat tissue/blood (ratio) PL – partition coefficient liver tissue/blood (ratio) Pmilk – partition coefficient milk/blood (ratio). Computer codes of this model are available on-line from the Web site: <<http://members.spre.com/tnatox/PBPK/PBPK.htm>>

Source: Byczkowski (2000).

PBPK simulations of total Hg concentration in brain (CBRTOT in mg/kg) of A. mother exposed to 0.1 μ g MeHg/kg/day; B. gestationally-exposed fetus; and C. nursing infant

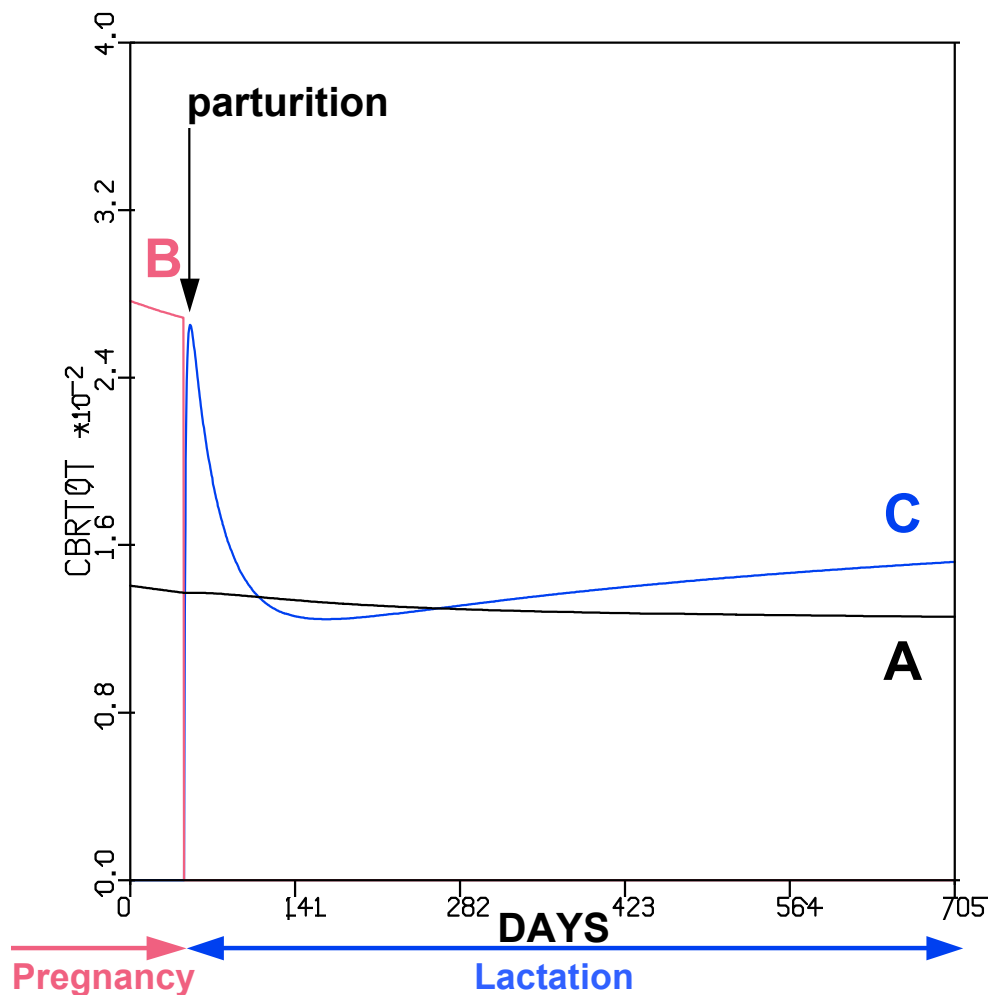

Figure 4-9. Combined results of MeHgLac PB/PK model simulations of total Hg concentrations.

Brain (mg/kg) of mother (A), gestationally exposed fetus at 9th month (B), and lactationally exposed exclusively breast-fed infant (C), under scenario of continuous near steady-state maternal intake of MeHg at RfD level 0.1 μ g/kg/day, starting 500 days before pregnancy and continuing at a constant intake throughout the pregnancy (9 months) and the lactation period (1.5 years).

Source: Byczkowski and Lipscomb (1999). For PB/PK model structure, see Area 2, Figure 2-1.

5.0 ISSUE AREA 5: FUNCTION OF THE BLOOD-BRAIN BARRIER IN INFANTS, CHILDREN, AND THE UNBORN

5.1 INTRODUCTION

5.1.1 Definition of the Term “Blood-Brain Barrier”

The term blood-brain barrier was originally coined to describe the experimental result of the exclusion from the brain of certain dyes (later shown to bind to proteins) injected into an animal. It is now generally used to describe a wide range of physiological mechanisms that control the internal environment of the brain (Saunders et al. 1999b). The stability of this internal environment is essential for normal brain function. The original barrier to macromolecules (protein-bound dyes) is now known to be due to the tight junctions of cerebral endothelial cells of brain blood vessels, which prevent the passage of proteins and all but the smallest molecules through the intercellular spaces between endothelial cells. This blood-brain barrier to protein is a fundamental diffusion restraint, upon which the physiological exchange mechanism now encompassed by the term “blood-brain barrier” depends. Thus, for example, ionic pumps transferring Mg^{++} or Ca^{++} across cerebral endothelial cells to set up ion gradients between brain interstitial fluid and blood, would be ineffective if there were not a diffusion restraint to prevent the gradients from running down. Similarly, iodide (I^-) is kept at a low level in the brain by an outward pump across choroid plexus epithelial cells and cerebral endothelial cells; this can only be achieved in the presence of a diffusion restraint between the brain/cerebrospinal fluid (CSF) and the blood. Thus the only sense in which it is appropriate to refer to “the” blood-brain barrier is with respect to the tight junctions between endothelial cells in brain blood vessels (and between epithelial cells of the choroid plexus, the “blood-CSF barrier”). Otherwise, it is essential that the particular barrier mechanism that is being considered be specified; for example, it might be the iodide pump, which removes iodide from the brain and CSF into the blood, or P-glycoprotein, which transfers many drugs out of the brain into the blood across endothelial cells, thus acting as an effective barrier to these drugs.

5.1.2 Barriers in the Developing Brain

There is a widespread belief, not supported by good-quality experimental data, that the blood-brain barrier in the developing (fetal) brain is immature. This belief often seems to be based on little more than the teleological argument that the developing brain would not “need” a developed barrier because it is within the internal environment of the fetus and therefore well protected by the placenta (e.g., Barcroft 1938). Or alternatively, that because the brain is developing, such mechanisms would necessarily be immature. There are numerous published studies dating back to the 1920s that repeat the original dye injection studies in adult animals and even, in one case, in human fetuses (Grontoft 1954). The results of these experiment are divided more or less equally between those showing the presence of a barrier to protein-bound dye in immature animals of various species and those showing staining of the brain, which was interpreted as evidence of an immature barrier. A review of many such studies demonstrates that the

experimental result showing staining of the brain was due to the injection of huge amounts of dye or protein, in some cases at least doubling the volume of circulating blood within a very short time (Saunders 1992). The human studies by Grontoft showed that the barrier to protein-bound dye was well formed and remained intact for several hours *post mortem*. Intercellular junctions that are “tight” to proteins are present in the blood vessels of the brain (blood-brain barrier) as soon as the brain starts to become vascularized. Similarly, the tight junctions between the epithelial cells of the choroid plexus (blood-CSF barrier) are present as soon as those cells begin to differentiate.

However, some of the physiological barrier mechanisms (e.g., ion pumps; Bradbury et al. 1972), develop sequentially during fetal development, although whether this is a reflection of immaturity or of biological inappropriateness if developed earlier is not clear. What is clear is that the brain develops within a unique environment that is distinct from that of the rest of the fetus and that this internal environment is regulated by some mechanisms that are not present in the adult. Some of these mechanisms involve specialized transfer of specific molecules across the choroid plexuses (which are very large compared with the size of the brain early in its development). These molecules (e.g., some proteins, including growth factors) may then be taken up by neurons or other cells in the developing brain that have processes in contact with CSF (Dziegielewska et al. 2000). Thus, toxic materials or drugs entering a fetus across the placenta or into the circulation of a young infant may reach the brain, not because of immaturity of the blood-brain barrier, but because they may be carried in by a specialized carrier mechanism (e.g., heavy metals combined with plasma proteins).

The quality of the literature available in this Issue Area is generally poor, notwithstanding that almost all of the information comes from peer-reviewed journals. Hodgson and Levi (1997), in their *Textbook of Modern Toxicology*, give an unreferenced description of the adult blood-brain barrier that is remarkable for its inaccuracy: “Foot processes of the astrocytes form tight junctions with the endothelial cells in the brain to prevent passage of dyes or charged molecules from blood to brain.” (Note that tight junctions exist *between the endothelial cells*. Gap junctions exist *between astrocytes*.) “Much of the brain, spinal cord and peripheral nervous system lack this barrier and are not protected.” This is incorrect. Only very restricted regions of the nervous system lack a blood-brain barrier (to protein), i.e., the circumventricular organs, e.g., the area postrema and pineal gland. Concerning the immature brain, it is stated (again without references) that “In the immature brain, the barrier is generally not well-developed and toxic doses of some compounds may accumulate in the CNS of children and not in adults.”

In much of the referenced literature, barrier permeability to a particular drug or toxin under investigation has not been measured. Instead, the finding that such molecules may have effects in immature animals or children but not in the adult is itself taken as evidence of barrier immaturity. The fact that the developing brain might respond differently than the adult brain is often not considered. The oldest and most often quoted example of such a misunderstanding is the explanation given for kernicterus in neonatal jaundice. Kernicterus is not due to any immaturity of the blood-brain barrier to bilirubin (the hemoglobin breakdown product that causes jaundice in the newborn, and even brain damage in severe

cases). The bilirubin causing the problem is both unconjugated (because of liver immaturity) and lipid soluble, and therefore can cross easily into the brain. It does not do so normally because it is bound to plasma albumin. Only if the binding capacity of albumin is exceeded will kernicterus occur. Fortunately, most pediatricians (e.g., Avery et al. 1998, see also Volpe 1995) understand this (many physiologists do not) and act accordingly to try to prevent the binding capacity of albumin for bilirubin from being exceeded. (The most recent review of this topic is by Wennberg (2000).) Another example of this misunderstanding is the neonate's greater susceptibility to respiratory depression when exposed to morphine (see Section 5.3.8, below).

5.1.3 Species Differences: The Need for Caution

The experimental evidence for barrier permeability in the immature brain comes from a wide range of animal species. In addition to the general need for caution when attempting to extrapolate from animals to humans, in the developmental field there is the additional problem that different species develop at very different rates and are born at different stages of brain development. For example "newborn" represents something quite different in a human, sheep, rat or marsupial. If we take the cerebral cortex for comparison, then in rodents its development in terms of neurogenesis and cell migration is largely complete by birth, although other features of its development, such as synaptogenesis, continue well into the postnatal period. In sheep, which have a slowly growing brain and a long gestational period (150 days), the equivalent period is 60-70 days gestation for the end of neurogenesis. In the human cortex, the equivalent period is about 4 months gestation, although a substantial amount of development, especially gliogenesis and synaptogenesis, occur throughout the rest of gestation and on into the first year or so of life (Volpe 1995). At the other extreme, in marsupials, the whole of neocortical development occurs after birth, postnatal day 15 (P15), equivalent to the newborn rat neocortex. Although there are massive differences in rates of brain growth and the time taken to reach maturity, these differences are not just a function of size; marsupial brains grow more slowly than eutherian (sometimes inaccurately referred to as placentals) brains of similar size. Thus, when transferring information from experiments on animals to humans, particular caution is needed with respect to development.

A rational basis for study would seem to be to restrict comparisons to specific systems or features of systems for which enough is known to make a valid comparison of stages of development. With respect to brain barrier mechanisms, this would require specifying the particular barrier mechanism; even then, this might be misleading because of the difficulty of obtaining adequate normal human data. For example, one characteristic of fetuses and newborns of animals born at very early stages of brain development is a high concentration of CSF proteins that originate from plasma by transfer across choroid plexus epithelial cells, and not because of immaturity of the tight junctions that restrict protein entry into CSF in the adult. Thus, a simple comparison between species of total protein concentration in CSF could be a useful index of the protein transfer barrier mechanism. In the newborn human, CSF protein concentration is about 2 to 4 times the adult level (Saunders 1977), but it is very much higher in the fetus (Adinolfi and Haddad 1977; Bell et al. 1991). On this basis, the equivalent stage in the rat is about P10 to

P20 (Dziegielewska et al. 1981; Habgood et al. 1993); in fetal sheep it is late in gestation (Dziegielewska et al. 1980a). Thus, in this respect a newborn rat is quite different from a newborn human. The situation is further complicated by uncertainty about how normal CSF samples are collected from human neonates; samples would presumably only be taken if there were a clinical indication, and “normal” is probably a retrospective diagnosis based on finding no detectable abnormality. However, respiratory problems in neonates, especially if preterm, are common, and retention of carbon dioxide is usually associated with such problems. Elevated carbon dioxide in blood is known to increase penetration of materials, including proteins, in plasma into CSF and brain (see Evans et al. 1976; Habgood 1995). Thus, the estimates of protein concentration in human neonates may be overestimates, resulting in underestimates of age-related species differences.

A further developmental point is that the brain may not be equally vulnerable throughout its growth. There is some evidence (see Rodier 1980) that specific features of brain development occur in spurts at different times in different regions.

5.2 LITERATURE REVIEW

5.2.1 Supposed Immaturity of Barriers in the Developing Brain

The existing literature in this field has been extensively reviewed. Much of this author’s work has focused on the underlying diffusion restraint, the tight junction barrier to proteins in cerebral blood vessels (blood-brain barrier) and choroid plexus epithelial cells (blood-CSF barrier). Work published on some of the barrier exchange mechanisms, e.g., for amino acids in the developing brain (Cornford et al. 1982; Lefauconnier 1992), in many cases provides insufficient evidence to make more than an outline indication of the state of research development on these particular barrier mechanisms. Such outlines are available in the following reviews (Dziegielewska et al. 1999, 2000, 2001; Saunders 1992; Saunders and Dziegielewska 1997; Saunders et al. 1999a, 1999c, 2000).

Much of the research literature deals with descriptions of effects of drugs and toxins that occur only, or at least more prominently, in the immature rather than the mature brain (e.g., Mirmiran et al. 1985). Two examples, bilirubin and morphine, have been given above. However, unless the studies involved direct measurement of entry into the brain and/or CSF, they provide no useful information on the state of maturity of the blood-brain barrier to the compound under investigation. On the other hand, provided that such papers are based on well-conducted experiments, they may provide important evidence that is relevant to the preparation of an environmental risk assessment of possible brain damage in fetuses and infants from exposure to drugs and toxins.

The risk to the immature brain does not lie in either its immaturity or in its having more permeable barrier mechanisms relative to those of the adult. It lies in the fact that transfer mechanisms exist (particularly across the choroid plexuses in the fetus) that are not present in the adult, e.g., for

certain proteins (Dziegielewska et al. 1980, 1991; Habgood et al. 1993; Knott et al. 1997). These mechanisms allow greater macromolecular penetration, possibly associated with bound ligands such as drugs or heavy metals. Once into the CSF, there appears to be uptake into cells, particularly immature neurons that have contact with the CSF, either within the ventricles or in the subarachnoid space over the outer surface of the brain. This route of protein penetration across the choroid plexuses into the immature brain has also recently been shown to explain the greater permeability of both the blood-CSF and blood-brain barriers to small lipid-insoluble molecules during brain development (Saunders et al. 1999[a,]; Ek et al. 2000, Dziegielewska et al. 2001). The finding that both proteins and smaller molecules enter the brain via the CSF and are then taken up into some cells in the immature brain suggests a different mechanism for brain susceptibility to damage from exogenous material during development than the widespread but erroneous view that barriers in the developing brain are immature. Furthermore, the finding that materials of widely differing size and chemical composition are taken up from CSF directly into cells in the developing brain suggests that the brain may be even more vulnerable to exogenous compounds than would be the case were the barriers immature; in the latter case, materials penetrating the brain would enter the brain extracellular space, rather than go directly into cells. Finally, some adult transfer mechanisms (e.g., for amino acids) appear to be more active in the developing brain than in adults (Cornford et al. 1982; Lefauconnier 1992).

5.2.2 Vulnerability of the Developing Brain

Rodier (1995) summarized the features of brain development that render the brain particularly susceptible to toxic agents (e.g., mitosis, migration, synaptogenesis, myelination). The review contains the statement:

Developing brain is distinguished by the absence of a blood-brain barrier. The development of this barrier is a gradual process beginning *in utero* and complete around 6 months after birth in the human (Adinolfi 1985). Thus some toxic agents that never enter the mature brain enter the developing brain freely. Examples include cadmium (Levin and Miller 1980) and monosodium glutamate (Olney et al. 1981).

Adinolfi (1985) measured proteins in human fetal CSF at different gestational ages. CSF protein concentration is much higher in fetal CSF, and Adinolfi interpreted this as evidence of barrier immaturity (however, this would refer to the blood-CSF barrier, not the blood-brain barrier, as stated by Rodier 1995). It has been shown that CSF protein concentration is indeed very high in the fetus but this arises from transfer across the choroid plexus epithelial cells (Dziegielewska et al. 1980a, 1980b, 1991; Habgood et al. 1993; Knott et al. 1997). The tight junctions between choroid plexus epithelial cells form very early and do not change in any way that correlates with the decline in protein concentration in fetal CSF that occurs with age (Møllgård and Saunders 1975; Møllgård et al. 1976; Dziegielewska and Saunders 1988). The blood-CSF barrier to proteins (tight junctions) is well formed in the fetus but is bypassed early in development by transfer across the choroid plexus epithelial cells. Adinolfi's

interpretation of his own work did not take proper account of this earlier literature (Adinolfi 1985). Nevertheless, Adinolfi's work (especially Adinolfi and Haddad 1977) is important because it is one of only two studies of proteins in human fetal CSF that cover a reasonable proportion of the gestation period (the other is Bell et al. 1991). Several older studies had shown that the total protein concentration in CSF from immature brains of a number of species was elevated compared with adults. Adinolfi was the first to measure the concentration of a number of individual proteins. Although in this review he appears to have accepted published evidence that the tight junctions between choroid plexus epithelial cells are already well formed early in fetal life (Møllgård and Saunders 1975) and also the proposition that plasma proteins might be transferred across choroid plexus epithelial cells (now confirmed by a number of studies (e.g., Dziegielewska et al. 1991, Knott et al. 1997, Balslev et al. 1997), Adinolfi nevertheless insisted that the presence of a high concentration of proteins in fetal CSF was a consequence of the immaturity of both the blood-CSF barrier and the blood-brain barrier. He is still sometimes cited as providing evidence for the "immaturity" of the blood-brain barrier. Because Adinolfi mentions that the concentrations of some proteins in fetal CSF reach adult levels at about 6 months of age, this has been taken as evidence that the blood-brain barrier matures by that age in the human.

Oskarsson et al. (1998) have reviewed a risk assessment of neonatal exposure to metals. The review contains the following un-referenced statements: "The blood-brain barrier is not fully developed until around 6 months after birth in man. ... The brain is especially vulnerable during the brain growth spurt ... dendritic and axonal growth, synaptogenesis." As indicated above, the first statement is not supported by evidence, whereas the second is undoubtedly of importance for risk assessment in the fetus and newborn.

5.3 NEUROTOXICOLOGY IN THE FETUS AND NEWBORN

Andersen et al. (2000) have briefly reviewed developmental neurotoxins. The paper includes two useful tables of neurotoxins. The authors point out that only a few compounds have been tested and neurotoxicity testing is not required by national authorities. They describe the placenta as "a dynamic and changeable interface that allows transport of essential compounds between two compartments." It is a pity they do not apply a similar description to the blood-brain barrier. Instead they make the usual statements: "...partial lack of a BBB (blood-brain barrier) in the fetus. ... The fetal BBB develops during pregnancy and in humans the BBB is not fully developed until the middle of the first year of life (Rodier 1995)." (See above for comments on inadequacy of evidence in Rodier supporting this statement.) It was assumed that effects of neurotoxins in fetuses and newborns occur "because of immature blood-brain barrier. ... More data are clearly needed to elucidate the importance for a changed blood-brain barrier for neonatal neurotoxicity as well as neurological dysfunction in later life."

In this section, chemical-specific neurotoxicity information is summarized and evaluated with respect to the issues at hand. Throughout most of the literature evaluated, the same misconceptions in data interpretation may be noted.

5.3.1 Acrylamide

Ikeda et al. (1985) conducted maternal-fetal distribution studies of [¹⁴C] acrylamide in tissues of beagle dogs and miniature pigs in late pregnancy. Pregnant dogs and miniature pigs were given [¹⁴C] acrylamide. Acrylamide was described as moderately lipid soluble. Radioactivity in brains of both mothers and fetuses indicated that it penetrated easily, which would be expected simply on the basis of its lipid solubility. This was apparently not understood by the authors, who explain its presence in fetal brain as due to an absence of a blood-brain barrier. However, since only 30 to 40 percent of the labeled acrylamide was protein bound, there should still have been plenty of free-lipid-soluble acrylamide to distribute into the brain.

5.3.2 Organochlorines

Tilbury et al. (1999) studied the distribution of organochlorines in stranded pilot whales (*Globicephala melaena*) from the coast of Massachusetts. The study included some whale fetuses and young whales. The absolute concentration of all organochlorines measured in whale fetuses was considerably less than in mothers or males or nonpregnant females. Only one fetal brain was examined. Levels were lower than in adults, but as no blood levels were available, this finding is difficult to interpret. Between 0.4 and 2 percent was found in the blubber, suggesting that a significant barrier exists. Nevertheless, in their discussion, the authors refer to “the lack of a blood-brain barrier in fetal mammals and a barrier that is not completely developed in neonates may impact the accumulation of toxic chemicals in the neural tissues of developing mammals.”

5.3.3 Pipecolic Acid

Nishio et al (1983) and Kim and Giacobini (1985) examined the transport of pipecolic acid in adult and developing mouse brain. Pipecolic acid is a plant amino acid found, for example, in some types of beans. Marked hyperpipecolinaemia has been described in a group of human genetic disorders connected with peroxisomal defects such as Zellweger syndrome and has been suggested to be due to the absence of peroxisomal L-pipecolate oxidase (Kramer et al. 1989). These syndromes are associated with brain damage. Kim and Giacobini found that the net uptake at 10 minutes of injected pipecolic acid was more than 2 times greater at P1 than in adult. They interpreted this as evidence of the development of the blood-brain barrier. However, it may reflect a more active carrier mechanism, related to early (growing) brain development, rather than to immaturity (cf Cornford et al. 1982). In addition to more active transport in the developing brain, the finding that the immature brain is more permeable to small molecules such as L-glucose and sucrose (Habgood et al. 1998, Ek et al. 2000) suggests that passive transfer of pipecolic acid (molecular weight = 129) may also be greater in the younger brain.

5.3.4 [¹⁴C]-2,4-Dichlorophenoxyacetic Acid

Kim et al. (1988) described experiments in which [¹⁴C]-2,4-dichlorophenoxyacetic acid

[¹⁴C]-2,4-D) was injected intraperitoneally into pregnant mice at 17 days gestation (E17), following intraperitoneal pretreatment with saline or 40 or 80 mg/kg 2,4-D. No [¹⁴C]-2,4-D was detectable by autoradiography in the brains of mothers or fetuses. For zero pretreatment, maternal brain/plasma ratios were around 3 to 4 percent. Fetal ratio was about 8 percent of maternal plasma concentration, which might have given an overestimate of true brain/blood ratio in the fetus. This finding was interpreted as indicating the existence of a substantial barrier to 2,4-D in both adult and fetus. Pretreating mothers with 2,4-D over 2 days resulted in substantial increases in brain levels for both fetuses and mothers. In similar experiments, adult rabbits were studied, with the addition that the CSF and choroid plexus were sampled. At the lowest dose of [¹⁴C]-2,4-D, the CSF concentration was only about 10 percent of brain concentration. This increased to 50 percent at the highest dose of [¹⁴C]-2,4-D. The level in the choroid plexus was about 7 times the brain concentration at the lowest dose, but only 50 percent higher at the highest dose. Permeability to the small organic solute 2-deoxyglucose (2-DG) was unaffected by 2,4-D administration. This was interpreted as indicating that blood-brain barrier permeability was unaffected by the pretreatment with 2,4-D. Such an interpretation betrays an inadequate understanding of blood-brain barrier mechanisms. 2-DG is a nonmetabolized glucose analogue that is transported into the brain by the glucose transporter. *In vitro* experiments with choroid plexus demonstrated specific inhibition of 2,4-D uptake by increasing concentrations of 2,4-D in the incubation medium. It was concluded that the concentration of 2,4-D in choroid plexus and lower values in CSF indicated that 2,4-D is cleared via the choroid plexus and that the elevated brain levels found at higher exposure levels of 2,4-D were probably due to reduced clearance rather than increased barrier permeability. This is probably an acceptable explanation. In terms of fetal/neonatal brain toxicology, the important conclusion is that in the rat, a significant barrier mechanism to 2,4-D exists in late gestation. Since the blood-brain barrier mechanism appears to involve active exclusion of the compound across the choroid plexus, this presumably develops at an earlier stage of brain development. How much earlier is not known, nor is it clear when this happens in the human fetus.

In a later paper, Kim et al. (1996) describe the construction of a physiologically based pharmacokinetic model for 2,4-D dosimetry in the developing rabbit brain. This is probably the only detailed pharmacokinetic model that describes the entry of a compound into fetal brain. Basic biological data on adult brain and cerebral blood flow were obtained from the literature. The animal experimental data were taken from Sandberg et al. (1995), who was one of the co-authors of the 1996 paper. Modeling results give a reasonably good fit with the experimental data. The Sandberg et al. (1995) data and model fit with the data and conclusions of Kim et al. (1988) that the blood-brain barrier mechanism for 2,4-D involves an exclusion mechanism (outward pump; authors do not mention P-glycoprotein, but the mechanism could be P-glycoprotein or a P-glycoprotein-like mechanism.

5.3.5 L-Carnitine

Kim and Roe (1992) studied the distribution of L-carnitine following injection into E17 pregnant mice. Autoradiographs of tissue sections, as well as tissue/blood ratios, were obtained. There was no

penetration into brain in either adult or fetus, L-carnitine being concentrated in choroid plexuses. The authors suggested that the cause may be operation of an efflux mechanism. This paper is clear evidence for the presence of a specific blood-brain barrier in fetal mice, the presence of which also implies an intact diffusion (tight junction) barrier.

5.3.6 Heavy Metals

5.3.6.1 Lead

In Ford et al. (2001), Kosnett gives a useful summary of the effects of lead toxicity. The only mention of the blood-brain barrier is the statement: “Lead crosses the placenta and blood-brain barrier, although uptake into the CNS is slower than it is for other organs.” Quoting further: “The developing nervous system of the fetus and young child is considered the most susceptible target organ in human lead neurotoxicity.” Mechanisms of lead pathophysiology are outlined. Many appear to be due to disturbances of calcium metabolism.

5.3.6.2 Mercury

Ford et al. (2001) have also reported that elemental, inorganic or organic mercury (especially short chain, e.g., ethyl or methylmercury) crosses the blood-brain barrier. Immature brains are especially vulnerable and manifest more diffuse and widespread effects than adult brains. Methyl mercury inhibits brain cell division and migration, perhaps because of effects on microtubules.

Aschner and Clarkson (1988) examined the distribution of [^{203}Hg] in pregnant rats and their fetuses following systemic infusions with thiol-containing amino acids and glutathione during late gestation. Pregnant rats (E17) received intravenous infusions of L-cysteine, L-leucine or glutathione for 3 days; methylmercury was infused for 1 hour at 1-day intervals during the 3 days of amino acid infusion. Whole body and some organ levels of [^{203}Hg] methylmercury were measured following infusion. Whole body content in nonpregnant animals was less than in pregnant animals. The authors assumed that fetuses acted as sinks, but no fetal measurements were made. It was found that co-infusion of L-leucine reduced brain [^{203}Hg], and that co-infusion of cysteine increased brain [^{203}Hg], but only in nonpregnant animals. (The author Hirayama (1980, 1985) suggested that Hg may enter brain coupled to cysteine.) The inhibitory effect of L-leucine in these experiments was suggested to be due to competition. No measurements were made on fetuses. There are muddled statements in their discussion about blood-brain barrier.

Other researchers (e.g., Cornford & Cornford, 1986) concluded that: “Enhanced transport [*sic*] of [^{203}Hg] in the fetal vs the maternal brain irrespective of treatment may result from the immaturity of the blood-brain barrier. The capillary barrier in the rat is inoperative during late gestation and the carrier systems are not fully developed, although, notably, six of the seven major independent blood-brain nutrient carrier systems are known to exist.” The Cornfords’ work shows that the transport of several

classes of amino acids is greater in the immature brain, but this is interpreted as a developmental specialization reflecting the much higher utilization of amino acids by the developing brain.

Crowe (1995) examined the effect of neurotoxic metals on the uptake of iron into the brain and other organs of the developing rat with normal and altered iron status. This is a carefully conducted detailed study of neurotoxic metal entry into the brains of rats from P15 to adult. It shows that there is a substantially effective barrier to entry of metals (copper, lead, and cadmium) into the brain at least as early as P15. Crowe and Morgan (1996) studied interactions between tissue uptake of lead and iron in normal and iron deficient rats during development. P15 to P63 rats were studied. Brain entry of lead was said to be restricted even in the youngest animals. However, these findings were based on inorganic lead levels and not on actual entry. There might have been mechanisms within the brain that determined amounts accumulated in addition to entry. There was a strikingly greater accumulation in older animals. This reinforces the point that the immature brain is relatively well protected from lead, but that there are other mechanisms involved in accumulation. This study does not deal with mechanisms that might render the immature brain more susceptible to effects of lead, even if the accumulation is less than in the adult. One possible explanation for the greater accumulation of lead and cadmium in older brains is that the turnover of CSF in the adult may be less than in the fetus or newborn when the secretion rate of CSF (sink effect) is related to brain size (see Saunders 1992)

Crowe and Morgan (1997) examined cadmium entry into and accumulation in the brain. Entry was found to be restricted at all ages, but was greater in the youngest animals. Loading with cadmium resulted in greater accumulation of cadmium in the adult animals than in controls. This effect was not apparent in the younger animals. These results suggest that there is a significant barrier to cadmium entry into immature brain at least as early as P15. The immature brain, if anything, appears to be better protected from exposure to cadmium via the circulation than is the adult, but the exact mechanisms are unclear and are not dealt with in the study.

5.3.7 Steroids and the Developing Brain

In view of the widespread use of steroids in prematurely born infants (e.g., as a means of mitigating the effects of the respiratory distress syndrome and intraventricular hemorrhage; see Avery et al. 1998), it is important to know whether steroids have any deleterious effects on brain development or the properties of blood-brain barrier mechanisms. Stonestreet et al. (1996, 1999, 2000) have studied permeability to AIB (α -aminoisobutyric acid, a low-molecular-weight, hydrophilic, inert compound) in fetal sheep from E80 to E130 (term is 150 days). Permeability to AIB was increased by dexamethasone, and the effect was slightly greater in the youngest fetuses. This effect might make the brain more vulnerable to exposure to low-molecular-weight drugs or toxins. An extensive series of studies concerning repeated doses of betamethasone in pregnant sheep has shown deleterious effects on brain growth and myelination in the fetuses (Quinlivan et al. 1998, 2000; Huang et al. 1999; Dunlop et al. 1997).

5.3.8 Opiates

For many years morphine has been considered to have a greater effect in newborns than in adults (Way et al. 1965). This was attributed to immaturity of the blood-brain barrier (Kupfferberg and Way 1965, see below) and still is by some (Rennie and Robertson 1999, Timbrell 2000). Others authorities disagree (Avery et al, 1998); the evidence is not clear-cut, and understanding is not helped by inappropriate citations. Thus, Avery et al. state that "... Recent data suggest that the opioid induced apnea is less common in neonates than in older infants and children at similar plasma concentrations." They cite Hertzka et al. (1989) and Olkkola et al. (1988) (giving the incorrect year for the latter reference). However, only one subject in the study of Olkkola et al. was a neonate (i.e., less than 1 month of age), and the respiratory depressant effect of morphine in this patient was not studied. In the other paper, none of the patients studied was a neonate. This hardly seems a sound basis for such an important conclusion about the sensitivity or otherwise of neonates to respiratory depression caused by morphine.

The studies of Hertzka et al. (1989) and Olkkola et al. (1988) raised an important issue, which was ignored for a long time by neonatal pediatricians and led to a number of disasters (perhaps most notably the potentially lethal "grey syndrome" in neonates from the toxic effects of chloramphenicol). The issue is that of blood levels of a drug, which may be very different (higher) in the neonate because of differences in metabolism. Very often, liver enzymes that metabolize drugs are less active in the newborn, leading to higher blood levels of the drug. Also, the metabolic pathways used may be different, resulting in more active forms of the drug to a greater extent than occurs in adults. The supposed greater susceptibility of the immature brain to morphine, in causing respiratory depression, could relate to a number of different factors, in addition to possible differences in metabolism in neonates. First, at least in animal studies, the level of morphine receptors in a number of key brain areas may be greater in the newborn than later in life (Sircar and Zukin 1983, Barg and Simantov 1991, Rius et al. 1991), although the general level of receptor binding capacity in the developing rat brain has been reported to increase with age (Landymore and Wilkinson 1990). Second, morphine is protein bound (e.g., Lynn et al. 1991), and the concentration of proteins in plasma of immature animals and humans is substantially less than in the adult (Dziegielewska et al. 1980a, 1981; Knott et al. 1997). Third, it has recently been shown that morphine is a substrate for P-glycoprotein (Letrent et al. 1999, Xie et al. 1999, Thompson et al. 2000). This results in a brain level of morphine that is less than would be predicted for its physicochemical characteristics.

The extent to which any greater permeability of the blood-brain barrier to morphine in the neonate might contribute to greater sensitivity to respiratory depression, if this really occurs, is also unclear. This contribution is suspect for many of the same reasons that many other claims of barrier immaturity (discussed in this paper) are suspect as an explanation for drug or toxin effects in the newborn or fetus. The paper by Kupfferberg and Way (1963) is frequently cited as evidence that the greater sensitivity of the newborn to respiratory depression by morphine is due to immaturity of the blood-brain barrier. However, it is not clear to what extent results from a study in neonatal rats can be applied to newborn humans, given differences in maturity of the brain at birth between these species (see earlier). In

the study by Kuppferberg and Way (1963), it seems likely that the greater level of morphine in the brains of younger animals was at least partly due to the greater blood levels in these animals, which presumably results from slower metabolism or clearance.

The factors listed above make it unlikely that any residually greater brain uptake in younger animals can be explained solely by greater barrier permeability to morphine, even in newborn rats. In particular, it is necessary to take into account the fact that the mechanism limiting morphine entry into the brain is P-glycoprotein. P-glycoprotein has been shown to be present in human fetuses at least as early as mid-gestation (Møllgård and Schumacher 1996), but it has not been studied with respect to development and morphine transfer in the immature brain. DeVane et al. (1999) studied the disposition of morphine in tissues of the pregnant rat and fetus following single and continuous intraperitoneal administration to the mother. Morphine entered the fetus rapidly. Maternal plasma and brain concentrations were much lower than placental, fetal liver, brain or whole fetal levels. Because fetal brain morphine levels were 5 times higher than in adult brain, it was assumed this reflected greater permeability of the blood-brain barrier. DeVane et al. cited Stewart and Hayakawa's (1987) fetal rat study with horseradish peroxidase (HRP). These data are not relevant because HRP tests protein (tight junction) permeability. Morphine is a much smaller and more lipid-soluble compound (although only moderately lipid soluble compared with compounds that enter the more brain rapidly). Fetal brain levels could only be interpreted if fetal blood levels were available. It is clear that more morphine goes into fetus, including the brain, but not necessarily because of an immature barrier. Other evidence indicates that in some regions of fetal brain, there is higher expression of opioid receptors early in development than in the adult (Barg and Simantov 1989, 1991; Barg et al. 1992, 1993). Thus, a much more likely explanation for the greater accumulation of morphine in the fetal brain (and for the reportedly greater effect of morphine in depressing respiration in the neonate) is that morphine is metabolized less effectively, and may be bound more in some brain regions, in the immature than the adult brain. Other factors that need to be taken into account are discussed above.

Sandberg and Olsen (1992) studied the uptake of cocaine and metabolites in the fetal guinea pig. Benzoyllecgonine was the only metabolite that was detectable in brain and the levels were too low to quantitate, indicating a substantial barrier mechanism to cocaine and its metabolism in the guinea pig fetus in late gestation (E50; term is E65). The importance of understanding the effects of opiates on the developing nervous system is underscored by the study of Campbell et al. (1989), who showed in an Australia-wide survey of postoperative analgesia in neonates that 75 percent of patients received an opiate.

5.3.9 Theophylline and Related Xanthines

Arnaud et al. (1982) studied the metabolism and distribution of theophylline in the pregnant rat. They injected pregnant rats with labeled theophylline and reported fetal brain/blood ratios of around 1.0 compared with 0.41 in adults. It was proposed that this indicated the lack of a blood-brain barrier in the fetus. The authors do not seem to have realized that theophylline is protein bound, and that since there is a

marked increase in plasma protein concentration during development, this could cause reduced availability of theophylline for exchange in older animals.

Wilkinson and Pollard (1993) studied accumulation of theophylline, theobromine and paraxanthine in the fetal rat brain following a single oral dose of caffeine. Pregnant rats at 20 days gestation (E20) were given a single dose of caffeine (5 or 25 mg/kg). Fetal and maternal concentrations of caffeine were estimated both in the blood and the brain. Substantially higher brain/blood ratios were obtained for theophylline by these researchers than by Arnaud et al. (around 3.0 for theophylline for both doses of caffeine in fetuses), but adult results depended on dose. In adults, the brain/plasma ratio for theophylline at a caffeine dose of 5 mg/kg was about 3.0, whereas at a caffeine dose of 25 mg/kg, the ratio was around 0.1. This was a consequence both of less theophylline getting into the brain and a higher concentration in plasma. Although the authors acknowledged the greater lipid solubility of theophylline and gave figures for protein binding, they still concluded that the greater brain/blood ratios for theophylline found in the fetus are due to differences in the blood-brain barrier between fetuses and adults.

The study by Arnaud et al. (1982) was repeated by Habgood et al. (1998) using postnatal rats. Data were obtained on different brain regions and on CSF. Theophylline and L-glucose were compared. It should be pointed out that although theophylline and L-glucose have similar molecular weights, theophylline is much more lipid soluble, and therefore unlikely to be hindered by a blood-brain barrier. Hypercapnia (abnormally high levels of carbon dioxide in the circulating blood) increased penetration of L-glucose, but not theophylline, into CSF and brain. This supports Habgood et al.'s contention that the difference in lipid solubility means that the route of entry is likely to be different and that an increase in protein binding of theophylline in older animals accounts for the decrease in brain/plasma ratios for theophylline in the older animals.

5.4 CONCLUSIONS

The only sense in which the term “the blood-brain barrier” can be considered to define a single barrier mechanism is with respect to the exclusion of protein (or materials such as dyes that are bound to protein) from the adult brain by the tight junctions existing between endothelial cells in brain blood vessels. However, this barrier mechanism has much more physiological significance than the mere exclusion of proteins from the extracellular fluid of the brain. The tight junctions act as a diffusion restraint for a whole range of molecules, many of which are actively transported into or out of the brain. These active transport mechanisms, such as ion pumps, are responsible for the unique composition and stability of the brain's internal environment, something that is essential to the normal functioning of the brain. *All* of these mechanisms are frequently referred to using the general term “blood-brain barrier.” However, any consideration of such mechanisms requires that the mechanism be identified. In the developing brain, with respect to the underlying diffusion barrier that excludes proteins from the brain's extracellular fluid, this barrier mechanism develops very early, as do the tight junctions between choroid plexus epithelial cells that form the blood-CSF barrier. In addition, even in the fetuses and newborns of

those species that are very immature at birth, there *also* exist other barriers to proteins at the CSF-brain interfaces on the inner and outer surfaces of the developing brain. These barriers consist of membrane specializations between the cells forming these interfaces; they are present only early in development when the concentration of proteins in the CSF is high. The high concentration of proteins in the CSF originates because of transfer mechanisms that cause movement from plasma across a subpopulation of choroid plexus cells. Thus, any drugs or toxic ligands that bind to these proteins will enter the CSF in the fetal brain and may be taken up from the CSF into cells that are in contact with the CSF. The immature brain is also more permeable to low-molecular-weight, lipid-insoluble molecules than is the adult brain. Recent work suggests that the route for this permeability is largely via the choroid plexuses via an intracellular pathway that transfers molecules at least as small as molecular weight 3000 to the CSF. From there the molecules are taken up into cells that have contact with the CSF.

Therefore, using brain/CSF ratios as an index of blood-brain barrier permeability (which implies transfer across the cerebral endothelium of brain blood vessels) is misleading. These mechanisms appear to be part of the specialized mechanisms that control the internal composition of the developing brain (as are mechanisms such as amino acid transport, which are more active in the developing brain than in the adult brain). Thus, although some materials (including some drugs and toxins) may enter the developing brain to a greater extent than the adult, this is probably a reflection of the activity of other factors (e.g., specialized transfer mechanisms, a slower rate of metabolism, or lesser binding to plasma proteins, rather than the immaturity of adult barrier mechanisms. Low-molecular-weight, lipid-insoluble molecules (less than molecular weight = 500) do seem to enter the developing brain, especially early on, to a greater extent than the adult. Recent evidence suggests that this may be predominantly via the CSF. Lipid-soluble molecules will of course enter the brain and CSF at any age, unless bound to proteins, in which case their entry will also be via CSF early in brain development, when protein transfer is occurring across the choroid plexuses. Any greater entry rate of a drug or toxin into the immature brain, by whatever mechanism, may contribute to the greater vulnerability of the developing brain, but the principal reason for this vulnerability does not lie with differences in developmental differences in blood-brain barrier. Instead, it lies in the greater vulnerability of certain ongoing processes in the developing brain, such as mitosis, cell migration, and synaptogenesis, which are susceptible to toxins and some drugs.

Understanding the contribution of barrier permeability to the deleterious effects of drugs and toxins in the developing brain requires direct measurement of permeability under well-controlled experimental conditions. Barrier permeability cannot be inferred from a comparison of effects of a potential toxin on brain function in immature and adult brains.

There seems no doubt that the developing brain is more susceptible to the effects of toxins if exposed to them. In most of the cases discussed here, this greater susceptibility has not been demonstrated to result from greater blood-brain barrier permeability. Substantially more experimental work would be needed in order to provide an adequate description of the mechanisms underlying the developing brain's vulnerability to these and the many unstudied toxins that it might be exposed to.

5.5 REFERENCES

- Adinolfi M. (1985). The development of the human blood-CSF barrier. *Develop. Med. Child. Neurol.* 27:523-537.
- Adinolfi M, Haddad S. (1977). Levels of plasma proteins in human and rat fetal CSF and development of the blood-CSF barrier. *Neuropaed.* 8:345-353.
- Andersen HR, Nielsen JB, Grandjean P. (2000). Toxicologic evidence of developmental neurotoxicity of environmental chemicals. *Toxicology* 144:121-127.
- Arnaud MJ, Braco I, Welsch C. (1982). Metabolism and distribution of theophylline in the pregnant rat. Impairment of theophylline metabolism by pregnancy and absence of a blood-brain barrier in the fetus. *Pediatr. Res.* 16:167-171.
- Aschner M, Clarkson TW. (1988). Distribution of mercury 203 in pregnant rats and their fetuses following systemic infusions with thiol-containing amino acids and glutathione during late gestation. *Teratology* 38:145-55.
- Avery, GB, Fletcher, MA, MacDonald, MG (1998). *Neonatology*, 5th edition, Lippincott, Williams and Wilkins, 787, 792, 1451.
- Balslev Y, Dziegielewska KM, Møllgård K, Saunders NR. (1997). Intercellular barriers to and transcellular transfer of protein albumin in the fetal sheep. *Anat. Embryol.* 195:229-236.
- Barcroft J. (1938). *The Brain and Its Environment*. New Haven: Yale University Press.
- Barg J, Belcheva M, McHale R, Levy R, Vogel Z, Coscia CJ. (1993). Beta-endorphin is a potent inhibitor of thymidine incorporation into DNA via mu- and kappa-opioid receptors in fetal rat brain cell aggregates in culture. *J. Neurochem.*, 60:765-767.
- Barg J, Rius RA, Bem WT, Belcheva MM, Loh YP, Coscia CJ. (1992). Differential development of beta-endorphin and mu-opioid binding sites in mouse brain. *Brain Res. Dev. Brain Res.* 66:71-76.
- Barg J, Simantov R. (1989). Developmental profile of kappa, mu and delta opioid receptors in the rat and guinea pig cerebellum. *Develop. Neurosci.*, 11:428-434.
- Barg J, Simantov R. (1991). Transient expression of opioid receptors in defined regions of developing brain: are embryonic receptors selective? *J. Neurochem.* 57:1978-1984.
- Bell JE, Fryer AA, Collins M, Marshall T, Jones PW, Strange R, Hume R. (1991). Developmental profile of plasma proteins in human fetal cerebrospinal fluid and blood. *Neuropathol. Appl. Neurobiol.*, 17:441-456.
- Bradbury MWB., Crowder J, Desai S, Reynolds JM, Reynolds M, Saunders NR. (1972). Electrolytes and water in the brain and cerebrospinal fluid of the foetal sheep and guinea pig. *J. Physiol.* 227, 591-610.
- Campbell NN, Reynolds GJ, Perkins G. (1989). Postoperative analgesia in neonates: an Australia-wide survey. *Anaesth. Intensive Care*, 17:487-491.
- Cornford EM, Braun LD, Oldendorf WH. (1982). Developmental modulations of blood-brain barrier permeability as an indicator of changing nutritional requirements in the brain. *Pediatr. Res.* 16:324-328.
- Cornford EM, Cornford ME. (1986). Nutrient transport and the blood-brain barrier in developing animals. *Fed. Proc.* 45:2065-2072.

- Crowe AP. (1995). The effect of neurotoxic metals on the uptake of iron into the brain and other organs of the developing rat with normal and altered iron status. PhD Thesis. University of Western Australia.
- Crowe A, Morgan EH. (1996). Iron and copper interact during their uptake and deposition in the brain and other organs of developing rats exposed to dietary excess of the two metals. *J. Nutr.*, 126:183-194.
- Crowe A, Morgan EH. (1997). Effect of dietary cadmium on iron metabolism in growing rats. *Toxicol. Appl. Pharmacol.*, 145:136-146.
- DeVane CL, Simpkins JW, Boulton DW, Laizure SC, Miller RL. (1999). Disposition of morphine in tissues of the pregnant rat and foetus following single and continuous intraperitoneal administration to the mother. *J. Pharm. Pharmacol.*, 51:1283-1287.
- Dunlop SA, Archer MA, Quinlivan JA, Beazley LD, Newnham, JP. (1997). Repeated prenatal corticosteroids delay myelination in the ovine central nervous system. *J. Matern. Fetal Med.*, 6:309-313.
- Dziegielewska KM, Daikuhara Y, Ohnishi T, Waite MP, Ek J, Habgood MD, Lane MA, Potter A, Saunders NR. (2000). Fetuin in the developing neocortex of the rat: distribution and origin. *J. Comp. Neurol.*, 423:373-388.
- Dziegielewska KM, Evans CAN, Fossan G, Lorscheider FL, Malinowska DH, Møllgård K, Reynolds ML, Saunders NR, Wilkinson S. (1980a). Proteins in cerebrospinal fluid and plasma of fetal sheep during development. *J. Physiol.* 300:441-455.
- Dziegielewska KM, Evans CAN, Malinowska DH, Møllgård K, Reynolds ML, Saunders NR. (1980b). Blood-cerebrospinal fluid transfer of plasma proteins during fetal development in the sheep. *J. Physiol.* 300:457-465.
- Dziegielewska KM, Habgood MD, Mollgard K, Stagaard M, Saunders NR. (1991). Species-specific transfer of plasma albumin from blood into different cerebrospinal fluid compartments in the fetal sheep. *J. Physiol.*, 439:215-237.
- Dziegielewska KM, Saunders NR. (1988). The development of the blood-brain barrier: proteins in fetal and neonatal CSF, their nature and origins. In: *Handbook of Human Growth and Developmental Biology (vol 1). Neural, Sensory, Motor and Integrative Development.* (Meisami E, Timiras PS, eds.). Boca Raton, Fla.: CRC Press, 169-191.
- Dziegielewska KM, Saunders NR, Knott GW, Møllgård K. (1999). Neuro-hepatic proteins in brain development. In: *Alfred Benzon Symposium 45, Barriers in the Brain* (Paulson O, Moos Knudsen G, Moos Munksgaard T, eds.). 209-222.
- Dziegielewska KM, Ek J, Habgood MD, Saunders NR. (2001). Development of the choroid plexus. *Micros. Res. Tech.* 52:5-20.
- Ek C J, Habgood M D, Weller WL, Saunders NR (2000). Entry of lipid insoluble molecules into the developing CNS. *Society for Neuroscience Abstracts* 26:793.8
- Ford MD, Delaney KA, Ling LJ, Erickson T. (2001). *Clinical Toxicology.* Philadelphia: Saunders.
- Gröntoft O. (1954). Intracranial haemorrhage and blood-brain barrier problems in the newborn. *Acta. Patholog Microbiol. Scand. Suppl C*, p. 8.
- Habgood MD, Knott GW, Dziegielewska KM, Saunders NR. (1993). The nature of the blood-CSF barrier permeability decrease during postnatal brain development in the rat. *J. Physiol.* 468:73-83.

- Habgood MD, Knott GW, Dziegielewska KM, Saunders KM. (1998). Permeability of the developing and mature blood-brain barriers to a small lipid soluble molecule (theophylline) and the effects of hypercapnia. *Clin. Exper. Pharmacol. Physiol.* 25:361-368.
- Harman JG, Limbird LE. (1996). Goodman & Gilman's, *The Pharmacological Basis of Therapeutics* 9th edition. New York: McGraw-Hill.
- Hirayama K. (1980). Effect of amino acids on brain uptake of methyl mercury. *Toxicol. Appl. Pharmacol.* 55:318-313.
- Hirayama K. (1985). Effects of combined administration of thiol compounds and methyl mercury chloride on mercury distribution in rats. *Biochem. Pharmacol.* 34:2030-2032.
- Hodgson, E, Levi, P. (1997). *A Textbook of Modern Toxicology*, 2nd edition. Stanford, Calif.: Appleton and Lange.
- Huang WL, Beazley LD, Quinlivan JA, Evans SF, Newnham JP, Dunlop SA. (1999). Effect of corticosteroids on brain growth in fetal sheep. *Obstet. Gynecol.* 94:213-218.
- Kim CS, Binienda Z, Sandberg JA. (1996). Construction of a physiologically-based pharmacokinetic model for 2,4-dichlorophenoxyacetic acid dosimetry in the developing rabbit brain. *Toxicol. Appl. Pharmacol.* 136:250-259.
- Kim JS, Giacobini E. (1985). Transport of pipercolic acid in adult and developing mouse brain. *Neurochem. Res.*, 10, 1405-15.
- Kim CS, Keizer RF, Pritchard JB. (1988). 2,4-Dichlorophenoxyacetic acid intoxication increases its accumulation within the brain. *Brain Res.* 440:216-226.
- Kim CS, Roe CR. (1992). Maternal and fetal tissue distribution of L-carnitine in pregnant mice: low accumulation in the brain. *Fundam. Appl. Toxicol.* 19:222-227.
- Knott GW, Dziegielewska KM, Habgood MD, Li ZS, Saunders NR. (1997). Albumin transfer across the choroid plexus of South American opossum (*Monodelphis domestica*). *J. Physiol.* 499:179-194.
- Kupferberg HJ, Way EL (1963). Pharmacologic basis for the increased sensitivity of the newborn rat to morphine. *J. Pharmacol. Exper. Therap.* 141:105-112.
- Landymore KM, Wilkinson M. (1990). Ontogenesis of cell surface mu-opioid ($[^3\text{H}]$ DAGO) binding sites in rat hypothalamus and ex-vivo determination of blood-brain barrier penetration by opioid peptide FK 33-824. *Devel. Brain Res.* 54:169-176.
- Lefauconnier JM. (1992). Transport of amino acids. In: *Physiology and Pharmacology of the Blood-Brain Barrier*. (Bradbury MWB, ed.). Berlin: Springer Verlag, 117-150.
- Letrent SP, Polli JW, Humphreys JE, Pollack GM, Brouwer KR, Brouwer KI. (1999). P-glycoprotein-mediated transport of morphine in brain capillary endothelial cells. *Biochem. Pharmacol.* 58:951-957.
- Levin AA, Miller RK. (1980). Fetal toxicity of cadmium in the rat: maternal versus fetal injections. *Teratology* 22:1-5.
- Mirmiran M, Brenner E, van der Gugten J, Swaab DF. (1985). Neurochemical and electrophysiological disturbances mediate developmental behavioral alterations produced by medicines. *Neurobehav. Toxicol. Teratol.* 7:677-683.
- Møllgård K, Saunders NR. (1975). Complex tight junctions of epithelial and of endothelial cells in early foetal brain. *J. Neurocytol.* 4:453-468.

- Møllgård K, Malinowska DH, Saunders NR. (1976). Lack of correlation between tight junction morphology and permeability properties in developing choroid plexus. *Nature* 264:293-294.
- Nishio H, Giacobini E, Oriz J, Del Carmen Gutierrez M. (1983). Accumulation and metabolism of pipercolic acid in the developing brain of the mouse. *Brain Res.* 282:107-112.
- Oskarsson A, Palminger HI, Sundberg J, Petersson Grawe K. (1998). Risk assessment in relation to neonatal metal exposure. *Analyst* 123:19-23.
- Quinlivan JA, Archer MA, Dunlop SA, Evans SF, Beazley LD, Newnham JP. (1998). Fetal growth retardation, particularly within lymphoid organs, following repeated maternal injections of betamethasone in sheep. *J. Obstet. Gynaecol. Res.* 24:173-182.
- Quinlivan JA, Archer MA, Evans SF, Newnham JP, Dunlop SA (2000). Fetal sciatic nerve growth is delayed following repeated maternal injections of corticosteroids in sheep. *J. Perinat. Med.* 28:26-33.
- Rennie JM, Robertson NRC. (1999). *Textbook of Neonatology*, 3rd edition, Churchill Livingstone, 437.
- Rius RA, Barg J, Bem WT, Coscia CJ, Loh YP. (1991). The prenatal development profile of expression of opioid peptides and receptors in the mouse brain. *Dev. Brain Res.* 58:237-241.
- Rodier PM. (1980). Chronology of neuron development: animal studies and their clinical implications. *Develop. Med. Child. Neurol.* 22:525-545.
- Rodier PM. (1995). Developing brain as a target of toxicity. *Environ. Health Perspect.* 103 (Suppl 6):73-76. Review.
- Sandberg JA, Olsen GD. (1992). Cocaine and metabolite concentrations in the fetal guinea pig after chronic maternal administration. *J. Pharmacol. Exper. Ther.* 260:587-591.
- Sandberg JA, Duhart HA, Lipe G, Slikker W Jr, Kim CS. (1995). Distribution of 2,4-dichlorophenoxyacetic acid (2,4-D) in maternal and fetal rabbits. *J. Toxicol. Environ. Health,* 49:497-509.
- Saunders NR. (1992). Ontogenetic development of brain barrier mechanisms. In: *Physiology and Pharmacology of the Blood Brain-barrier*. Vol. 103. *Handbook of Experimental Pharmacology* (Bradbury MWB ed.). Berlin: Springer-Verlag, 327-369.
- Saunders NR, Dziegielewska KM. (1997). Barriers in the developing brain. *News Physiol. Sci.* 12:21-31.
- Saunders NR, Dziegielewska KM, Ek J, Møllgård K. (1999a). Morphological and physiological aspects of barriers in the developing brain. In: *Alfred Benzon Symposium 45, Barriers in the Brain* (Paulson O, Moos Knudsen G, Moos Munksgaard T, eds.).
- Saunders NR, Habgood MD, Dziegielewska KM. (1999b). Barrier mechanisms in the brain, adult and immature. Part 1: Adult brain. *Clin. Exper. Pharmacol. Physiol.* 26:11-19.
- Saunders NR, Habgood MD, Dziegielewska KM. (1999c). Barrier mechanisms in the brain, adult and immature. Part 2: Immature brain. *Clin. Exper. Pharmacol. Physiol.* 26:85-91.
- Saunders NR, Knott GW, Dziegielewska KM. (2000). Barriers in the developing brain. *Cell. Mol. Neurosci.* 20:29-40.
- Schumacher U, Møllgård K. (1996). The multidrug-resistant P-glycoprotein (Pgp. MDR1) is an early marker of blood-brain barrier development in the microvessels of the developing human brain. *Histochem. Cell. Biol.* 108:179-182.
- Sircar R, Zukin SR. (1983). Ontogeny of sigma opiate/phencyclidine-binding sites in rat brain. *Life Sci.* 33(Suppl 1):255-258.

- Stewart PA, Hayakawa EM. (1987). Interendothelial junctional changes underlie the developmental 'tightening' of the blood-brain barrier. *Develop. Brain Res.* 32:271-281.
- Stewart PA, Hayakawa K. (1994). Early ultrastructural changes in blood-brain barrier vessels of the rat embryo. *Develop. Brain Res.* 78:25-34.
- Stonestreet BS, Patlak CS, Pettigrew KD, Reilly CB, Cserr HF. (1996). Ontogeny of blood-brain barrier function in ovine fetuses, lambs, and adults. *Amer. J. Physiol.* 271:R1594-601.
- Stonestreet BS, Petersson KH, Sadowska GB, Pettigrew KD, Patlak CS. (1999). Antenatal steroids decrease blood-brain barrier permeability in the ovine fetus. *Amer. J. Physiol.* 276:R283-9.
- Stonestreet BS, Sadowska GB, McKnight AJ, Patlak C, Petersson KH. (2000). Exogenous and endogenous corticosteroids modulate blood-brain barrier development in the ovine fetus. *Amer. J. Physiol. Regul. Integr. Comp. Physiol.* 279:R468-477.
- Thompson SJ, Koszidin K, Bernards CM. (2000). Opiate induced analgesia is increased and prolonged in mice lacking P-glycoprotein. *Anesthesiology* 92:1392-1399.
- Tilbury KL, Adams NG, Krone CA, Meador JP, Early G, Varanasi U. (1999). Organochlorines in stranded pilot whales (*Globicephala melaena*) from the coast of Massachusetts. *Arch. Environ. Contam. Toxicol.* 37:125-134.
- Timbrell J. (2000). *Principles of Biochemical Toxicology*. 3rd Edition. Washington DC: Taylor & Francis, 146.
- Volpe JJ. (1995). Bilirubin and brain injury. In: *Neurology of the Newborn*. Chapter 13. 3rd edition. Philadelphia: Saunders.
- Wennberg RP. (2000). The blood-brain barrier and bilirubin encephalopathy. *Cell. Mol. Neurobiol.* 20(1):97-109.
- Wilkinson JM, Pollard I. (1993). Accumulation of theophylline, theobromine and paraxanthine in the fetal rat brain following a single oral dose of caffeine. *Devel. Brain Res.* 75:193-199.
- Xie R, Hammarlund-Udenaes M, de Boer AG, de Lange EC. (1999). The role of P-glycoprotein in blood-brain barrier transport of morphine: transcortical microdialysis studies in *mdr1a* (-/-) and (+/+) mice. *Br. J. Pharmacol.* 128:563-568.

CONCLUSIONS

As requested by EPA, this report was developed with an eye toward (1) identifying information that would inform the development of future test guidelines and/or guidance documents related to perinatal pharmacokinetic issues, and (2) identifying information or approaches that would assist EPA in improving existing noncancer risk assessment methodologies. This section summarizes both general and specific information gleaned from an examination of the literature in the five issue areas explored.

C.1 CONCLUSIONS FROM ISSUE AREA 1: RELATIVE BIOTRANSFORMATION CAPACITIES IN INFANTS, CHILDREN, AND THE UNBORN

Despite considerable methodological and practical difficulties, a relatively clear picture of the development of xenobiotic-metabolizing enzymes, especially with respect to CYP enzyme levels, has been emerging during the past decade. CYP3A7 is a major enzyme expressed at fetal period, and there is a rapid switch between CYP3A7 and CYP3A4 perinatally. Specific activities toward various substrates of these two CYP3A enzymes show considerable differences, so substrate specificity and specific activity of CYP3A7 have to be studied separately to make useful predictions. All other studied CYP enzymes are either absent prenatally or present at low levels; the major development occurs postnatally in an enzyme-dependent fashion. There is no consistent pattern of expression of phase II enzymes during the fetal period; some are practically absent (such as most UGTs) and some are close to adult levels (such as some SULTs).

For risk assessment purposes, two pieces of information should be especially useful: knowledge of developmental expression of each enzyme/isoform, and knowledge of substrate specificity and the specific activity of each enzyme/isoform. In experiments with animals, development of xenobiotic metabolism generally resembles that in humans; that is, there is a relative paucity of activities during the fetal period and more or less rapid development of enzymes postnatally. However, use of animal data for chemical risk extrapolation is hampered by known differences in enzymatic properties of orthologous enzymes in different species and by lack of comparative information. Future research on developmental expression of transcription factors and other factors regulating xenobiotic-metabolizing enzymes in humans and animals should give new tools and information to risk assessors.

Risk assessment of potential fetotoxicity should follow a defined sequence: (1) enzyme-specific metabolism and metabolic activation of a compound of interest (e.g. a pesticide) should be studied in human liver microsomes and recombinant expressed systems, as well as in induction systems; (2) the desired outcome should be knowledge of the balance between enzyme-specific activation and detoxification processes for a specific compound; (3) risk assessors should carefully examine the expression (presence or absence) of this or those particular enzymes in human embryonic, fetal, or neonatal tissues; (4) risk assessors may then estimate whether a compound would pose a hazard to the human embryo or fetus. Although this scheme is obviously incomplete, (for example, one could easily

imagine the presence of fetal-specific enzymes metabolising and activating xenobiotics), it should be useful to risk assessors in many situations.

C.1.1 General Findings

1. Older studies in this area are less likely to be useful because of methodological limitations. Expression of xenobiotic metabolizing enzymes (XME) can be studied at several levels; however, studies that measure activity are the most useful, because this determines metabolic clearance and/or bioactivation and ultimately, toxic effects.

The most sensitive methodology for detecting XME activity is RT-PCR (reverse transcriptase-polymerase chain reaction). However, the biological significance of changes in activity levels detected is not always clear. Also, a very little quantitative information exists about XMEs that might be translated into enzymatic maximum velocity (V_{max}) and affinity to xenobiotic substrate (K_m).

2. Most prenatal studies have been performed on relatively advanced fetuses, and the gestational age of the source fetal tissue is not always clearly identified. Studies on tissues before 58 days of gestation are more difficult to perform, and therefore, there is less information available.
3. Adult cytochrome P450 (CYP) enzymes have been extensively characterized. The most extensive series of studies on the development of cytochrome P450 (CYP) enzymes comes from Cresteil et al. For a given compound, as long as the fetal CYP pattern is known and the adult CYP metabolic profile is known, the most important CYP enzymes can be inferred using *in vitro* approaches.
4. The most abundant CYP in adults and fetuses are the CYP3A subfamily; a period of transition occurs within a relatively narrow time window around, or after, birth. In adults, this group constitutes 30 to 50 percent of total P450 content, in fetuses the fraction is higher, possibly 60 to 70 percent of the total content. The major form in fetal liver is CYP3A7, which constitutes >50 percent of the total P450 content. At present, it is not clear whether CYP3A7 is inducible in human fetuses.
5. There is very little information available on sex differences in the expression of XMEs.
6. The clear zonation that exists in adult liver does not exist in the livers of fetal rats, mice, or humans.
7. Although there are more than 15 human liver members of the UDP-glucuronosyl transferases, developmental profiles for individual forms have not yet been published.

C.1.2 Specific Findings in Different Age Groups

Fetus

1. It is probable that maternal pharmacokinetics play a large, maybe the determining, role in fetal exposure to foreign chemicals. Placental biotransformation may become, in certain cases, a limiting factor in fetal exposure.
2. Total fetal liver CYP content is relatively constant from the end of the first trimester of gestation up to 1 year of age, and during this period is about 30 percent of the adult level.
3. The following CYP enzymes seem to be present in significant amounts in fetuses:
 - CYP1B1: present at low levels, extra-hepatic predominates over hepatic, inducible.
 - CYP3A7: constitutes >50 percent of the total P450 content of fetal liver
4. Epoxide Hydrolases are detectable in fetal liver, and lower levels are also found in the adrenals, lungs, and kidney. It is difficult at present to tell whether flavin-containing mono-oxygenases are present and active in fetal tissues. Alcohol dehydrogenases are not expressed in the fetal liver. Little is known about the expression of reductases or hydrolases or esterases.
5. Sulfotransferase levels in fetal liver are as high, or even higher than, in adult liver. Glucuronidase levels, by contrast, are extremely low.

Neonate

1. Besides CYP3A7, the following CYP enzymes seem to be present in significant amounts in neonatal liver:
 - C CYP1A2: increases in children 1-3 months to 50 percent of adult levels within 1 year
 - C CYP2B6: possibly present at levels comparable to adults (1 sample only)
 - C CYP2C: increases in children 1-3 months to 33 percent of adult levels within 1 year; associated with SIDS
 - C CYP2D6: increases during the first post-natal week.
 - C CYP2E1: increases rapidly during the first 24 hours after birth
2. The expression of epoxide hydrolases increases dramatically shortly after birth. This is also true of alcohol dehydrogenases.
3. The expression of glutathion-S-transferases increases to the adult pattern and level by 1 year.
4. The expression of glucuronidase enzymes increases postnatally to attain adult levels by about 3-4 months of age.
5. Thiopurine S-methyltransferase enzyme expression and activity may be higher in newborns than in adults.

Child

1. There is no comprehensive and careful assessment of the development of biotransformation in toddlers, older children, or teenagers, as compared to adults.
2. The following CYP enzymes seem to be present in significant amounts in livers of children (3 yrs onward):
 - C CYP1A2: levels comparable to adults
 - C CYP2C9: levels comparable to or higher than in adults

- C CYP2D6: increases to attain two-thirds adult levels by age 5
- C CYP2E1: levels comparable to adults sometime between 1 and 10 years of age
- C CYP3A4: levels comparable to adults; possibly higher between 1-4 years of age

C.2 CONCLUSIONS FROM ISSUE AREA 2: RELATIVE TISSUE DISTRIBUTION AND EXCRETION CAPACITIES IN INFANTS, CHILDREN AND THE UNBORN

Risk assessment of potential developmental toxicants depends on evaluating the biologically effective dose of drugs or other chemicals that can reach the target organ. In infants, children and the unborn, the internal dose of chemical ultimately responsible for health effects, changes over time, often in a nonlinear fashion. These nonlinear changes in tissue distribution, inherent to developmental toxicology, require a computational method that can account for by changes in the structure and function of the developing organism. From review of the published pharmacokinetic tools, it seems that PB/PK models are the most successful tools available for improving existing risk assessment methodologies for infants, children and the unborn. PB/PK models of developmental toxicants must take into account changes in physiological parameters occurring during pregnancy, lactation and fetal/neonatal development. The parameters which are most affected by these changes are the following: (1) body weights; (2) maternal tissue and fluid volumes; (3) weight of the embryo/fetus/infant and volume of its developing organs; (4) metabolic clearance; (5) pulmonary ventilation; (6) cardiac output; (7) renal function; and (8) maternal intestinal motility.

C.2.1 General Findings

1. Simple proportionality equations that may approximate relatively well distribution of chemicals in adult organisms under near steady-state conditions often fail in developing organisms. Normal child development cannot be considered to be a linear function of time. The most obvious on-off discontinuities occur during conception, parturition, lactation and weaning. Moreover, in addition to nonlinear growth of body mass and organ volumes, the embryo is qualitatively different from the fetus, the fetus is qualitatively different from the neonate, and neonate is different from the older child. Growth and development proceed in stages, causing steps or “jumps” in the quantitative relations between physiological and metabolic parameters, and thus causing discontinuities in PK models.
2. Existing descriptive pharmacokinetic models (e.g., IEUBK model for lead) that account for developmental nonlinearities reliably describe concentrations of chemicals in blood and certain tissues, but require an extensive numerical data base and lack predictive capability. Thus, they cannot be used for extrapolations below the exposure doses that were used for their calibration.
3. Among the published PK models which address physiological changes during some developmental stages, the most successful were PB/PK models.

4. The majority of PB/PK models described in the peer-reviewed literature were developed in rodents, and predict internal doses in the rat and mouse fetus.
5. Only a few PB/PK models were validated in primates and/or humans but there is an example of a PB/PK model that has been successfully applied to cancer risk assessment in nursing infants of occupationally exposed mothers.

C.2.2 Specific Findings in Different Age Groups

Fetus

A successful PB/PK model for fetus should account for:

- C Changes in maternal pharmacokinetics during pregnancy
- C Transplacental transfer of chemicals
- C Developmental changes in fetal pharmacokinetics

Neonates

A successful PB/PK model for the neonate may use the same pharmacokinetic compartments as an adult, except that the tissue volumes must be linked to the increasing body weight by an appropriate growth function. Additionally, the model should account for:

- C Lactational transfer of chemicals
- C Neonatal pharmacokinetics, including changes in tissue lipid and water contents
- C Developmental changes in renal and metabolic clearance

Children

A successful PB/PK model for children should account for:

- C Changes in routes of exposure
- C Changes in renal and metabolic clearance
- C Tissue distribution and partitioning of chemical compounds

C.3 CONCLUSIONS FROM ISSUE AREA 3: PARAMETERS DETERMINING TRANSPLACENTAL TRANSFER

C.3.1 General Findings

The placenta performs a critical role in the development of the conceptus not only as a conduit, depot, and barrier but also as the anchor and controller. Understanding of the multiple roles played by the human placenta is undergoing a dramatic expansion, not only with regard to toxicokinetics but all functions, which depend upon the stage of gestation. This section examined placental toxicokinetic issues as they relate to the following: (1) *species comparisons*; (2) *gestational development*; (3) *research methods and models*; (4) *classes of agents*; and (5) *placental dysfunction*. Also, specific examples of the effects of metals, diethylstilbesterol, organophosphate and organochlorine pesticides, and viruses on the placenta were discussed.

With regard to future development and/or improvement of future test guidelines and non-cancer risk assessment paradigms which consider placental dynamics, it will be important to know not only what is happening relative to toxicokinetics in animal models, but also what may be occurring in humans. For many environmental agents, there are insufficient clusters of human exposures to determine placental toxicokinetics with any exactitude. Thus, test guidelines will need to incorporate human model systems, (e.g., *in vitro* human placental perfusions) in order to begin to understand not only the transfer of agents but also metabolism.

Specifics would include (1) elucidation of how agents may interact with known nutrients or other combinations of environmental agents, (2) whether the agent will induce xenobiotic metabolism in the placenta, and (3) whether there is significant metabolism of the agent based upon known enzyme profiles and testing within a diverse human population

Such characterization of molecules in both animal and human placental studies (*in utero* and *in vitro*) can provide toxicokinetic and as well as toxicity data not only for animals but also for the human providing for improved non-cancer risk assessment.

C.3.2 Specific Findings

1. Substantial differences exist not only in placental structure but also in placental metabolic function across species. Within a species, structural and biochemical diversity is also noted during the course of gestation. Thus, the validity of cross-species extrapolation may be substantially impacted by the availability of the molecule to the site of embryonic/fetal action as altered by the placenta for each species. Currently, a number of reproductive toxicology issues are under active reconsideration, including: (1) What are the kinetics of drug transfer during the time for maximal sensitivity to teratogenic action in the human? (2) Are the kinetics the same for rodent and human for early transplacental transfer? (3) What is the role of the early human yolk sac? (4) and Is its role the same as in the rodent?
2. A critical factor in understanding transplacental toxicokinetics is the stage of gestation and the relationship between two different circulatory systems and membranes. The placenta at less than 10 weeks of gestation is developing in an entirely different milieu than the near term or at term placenta. Recent observations have indicated that maternal blood may not surround the placental villi until after 10 weeks of gestation. Also, the scientific community has recently begun to explore, in even greater detail, similarities between early human and early rodent functions, including: (1) the oxygen environment, (2) the role of the yolk sac, and (3) the nature of the cellular layers separating the maternal environment from the embryo proper. Obviously, in humans, such studies are far from routine even for research evaluations. However, the ability to monitor the coelomic cavity directly has permitted information to be collected indicating the ability of molecules to enter and redistribute.

3. Even though some species have an abbreviated gestation, they may pass through many of the same stages that humans do, except for differences in gestational length and maturity at birth (e.g., rat, guinea pig, mouse, rabbit). Other species (marsupials) may manifest an entirely different birthing process and length of gestation, and have in fact only a visceral yolk sac. Thus, the toxicokinetics for these animals are in fact non-placental post-delivery (at approximately 8 days for the opossum). In early rodent gestation, however, the chorioallantoic placenta is just beginning to function and its primary role is that of anchor rather than conduit. Substantial maternal blood flow and transplacental exchange only begin to be manifested after 12 days.
4. Chemicals may have to pass through, depending on the species, from two cell layers to as many as six cell layers between the maternal and fetal blood supplies. Small molecules, (e.g., oxygen and carbon dioxide, to amino acids, carbohydrates and selected proteins) are known to cross from mother to conceptus. Operative mechanisms may include: (1) *facilitated transport* (e.g., d-glucose) (2) *active or coupled transport* (e.g., neutral amino acids and sodium); and (3) *receptor-mediated endocytosis* (e.g., transcobalamin II-vitamin B12, and immunoglobulin G). For xenobiotic transport, mechanisms are likely to be different, and may be more of a function of such factors as lipid solubility, ionization state, molecular weight, and ability to mimic a substance that will bind to trophoblast receptors, e.g., methylmercury-cysteine.
5. Unique placental transporters (p-glycoproteins) are present in the placenta, which may alter placental responses and result in increased transfer of xenobiotics to the conceptus. Specific transporter processes represent the opportunity for recognition of selected molecules and utilize one of four mechanisms:
 - Facilitated Diffusion – D-Glucose
 - Active Transport – Sodium and Potassium, Calcium
 - Coupled Transport with Sodium – Neutral Amino Acids, D-Alanine
 - Receptor Mediated Endocytosis – IgG intact

The identification of such transporters has resulted in an increased understanding of genetic variability in placental function, especially with regard to the placenta's role as a conduit. [Placental transport systems also vary across species.] Some molecules may not be easily transferred in either direction across the placenta; however, the fact that the placenta bioaccumulates the molecule may alter the transfer of other nutrients as well as intoxicate the placenta itself. One example of this would be cadmium (in both animal models and in humans). Many other molecules may be dependent upon the nature or presence of the serum proteins and binding sites or the genetics of the transporters in the placenta, which may influence how rapidly the compound can be transferred.

6. The placenta is known to function as a storage site or depot for both xenobiotics and nutrients. From an environmental perspective, this phenomenon is often related to the availability of specialized binding sites and proteins, e.g. metallothionein. The placenta, whether primate or rodent, can be induced to produce high levels of this metal-binding protein. Normally, copper and zinc are the endogenous binding metals; however, mercury and especially cadmium, have high affinity for this protein. It appears that metallothionein can sequester maternal cadmium resulting in a reduction in the transport of cadmium into the fetus. On the other hand, such binding molecules can transform a freely soluble chemical into a bound molecule that is more amenable to transport into the fetal circulation (e.g., vitamin B12 binding to transcobalamin proteins).
7. Not only can certain drug or xenobiotic metabolites (some equally, or even more toxic than, the parent compound) be *presented to* the placenta, but they may be also *formed by* the placenta. The retinoids are a good example of the latter possibility. The human placenta can form not only all trans-retinoic acid but also the 4-oxo metabolites which are thought to be teratogenic. The importance of the induction of not only mono-oxygenases with polycyclic aromatic hydrocarbons, but modification of the conjugation and protein binding milieu for metallothionein and metals can be influential in the transfer of many different molecules from amino acids to zinc as noted for cadmium.
8. Biotransformation by the placenta can become an important factor in regulating the appearance of molecules (especially toxicants) in the fetal circulation. The human placenta possesses both oxidative and conjugative enzyme activity. The ability to isomerize, oxidize, deconjugate the parent component places the placenta in a pivotal role in either protecting or enhancing the developmental toxicity of the chemical under investigation. (Note, however, that the placenta plays an important role in limiting the transfer of glucuronides, which is why bilirubin is not conjugated by the fetus to a large degree before birth and depends upon the mother for glucuronidation and elimination of this toxic metabolite of hemoglobin degradation.) Due to the small size of the fetus and low abundance of CYPs in placenta, the contribution of fetoplacental metabolism to overall gestational pharmacokinetics of drugs is probably generally minor. Nevertheless, several toxic outcomes have been ascribed to altered metabolic patterns in the fetoplacental unit, including a putative association between reduced placental oxidative capacity and birth defects. Examples of human teratogens that are substrates for CYP enzymes include thalidomide, phenytoin, retinoids, and several hormonal agents.
9. Many of the same factors that apply to maternal distribution also apply to distribution within the fetus, but often in the reverse order. Such factors as: umbilical blood flow, blood protein binding, excretion, protein binding, acid-base status, absorption into fetal tissues, biotransformation and pharmacologic actions of the molecules, can all impact the transfer of molecules from mother to fetus itself. Confounding fetal pathology can modify the characteristics as well.

C.4 CONCLUSIONS FROM ISSUE AREA 4: TRANSFER FROM PLASMA TO MILK

C.4.1 General Findings

From the review of the literature on pharmacokinetics of lactational transfer of drugs and other chemicals it seems that clearly, PB/PK models, coupled with pharmacokinetic studies in rodents and laboratory studies on human blood and breast milk, have an important place in providing the framework for improving the estimates for dosimetry to the breast-fed infant. For most chemicals and under most exposure scenarios, PB/PK modeling provide the most accurate tool for adequate exposure characterization in the nursing infant. While these modeling techniques provide a significant advancement in estimating a dose in the nursing infant, PB/PK models will not resolve the toxicological question of dose-response for health effects in human infants. In other words, the sensitivity of the nursing infant to chemicals is usually unknown. Properly designed epidemiological studies may help to address this problem. On the other hand, monitoring of blood, breast milk, exhaled breath, or urine in both the mother and infant are needed to document chemical exposure. These data then may be used in human PB/PK models to estimate exposure of the infant and, eventually, to correlate exposure with infant health effects.

Improving our ability to estimate the risk to infants exposed via contaminated breast milk, without needlessly discouraging the breast-feeding, will require the involvement of physicians, toxicologists, pharmacokineticists, industrial hygienists, and risk assessors, to provide a multifaceted group of scientists addressing this complex issue.

C.4.2 Specific Findings

1. A number of literature reviews provide information on chemicals and drugs which transfer to breast milk. The following resources are recommended: Cone et al. (1983); Giroux et al. (1992); Byczkowski et al. (1994); White and White (1980); Riordan and Riordan (1984); American Academy of Pediatrics Committee on Drugs (1989); and Hussein and Mohamed (1999). Table 4-2 presents the chemical information relevant to lactational transfer from the list of occupational and environmental chemicals published on the Web site "Drugs and Toxic Chemicals in Breast Milk" (Byczkowski 1997).
2. Transport of chemicals from maternal blood to breast milk can occur by passive diffusion, active transport, or apocrine secretion (reversed pinocytosis). Larger drug or chemical molecules and proteins may be transported actively into the alveolar cell by pinocytosis and released into the milk by apocrine secretion. For most un-ionized chemicals, the lactational transfer from blood may be adequately described in terms of a perfusion-limited passive diffusion through the membranes.

3. The physicochemical factors that determine the rate of passage of drugs into milk include (1) lipid (or octanol):water partition coefficient, (2) molecular weight, (3) degree of ionization, and (4) maternal plasma protein binding.
4. Due to the pH difference between blood plasma and milk, the electrochemical gradient forms a transmembrane potential across the blood-milk barrier. As a result, bases are often “trapped” in more acidic milk. Conversely, since the plasma proteins have higher affinity and capacity to bind drugs and other chemicals than milk proteins do, some drugs may be “trapped” in blood plasma.
5. Lipid-soluble chemicals and drugs tend to easily penetrate lipid membranes, whereas water-soluble drugs have to move through the narrow channels between cells. Thus, drugs partition into milk in accordance with their lipophilicity. Unlike plasma, milk contains emulsified fat, ranging on average from 3.2 to 3.6 percent in humans. Milk fat can concentrate lipid-soluble drugs, in some instances producing higher levels in milk than in plasma. Breast milk is more acidic than plasma; therefore drugs that typically pass readily into milk are weak bases that are lipid soluble and do not bind significantly to protein.
6. Molecular weight is important because chemical compounds with a molecular weight greater than 200 have difficulty crossing cell membranes. However, under certain circumstances, large molecules and even whole virus particles can be transferred into milk. In general, the smaller the molecule, the easier its transfer through the water-filled pores and channels of the lipid barrier of the alveolar cell.
7. The binding of drugs and other chemicals to plasma and milk proteins can influence the rate of passage of drugs into the alveolar lumen. By binding to proteins, drugs become trapped, and thus are unavailable for lactational transfer. Essentially, only unbound free drug molecules diffuse into breast milk regardless of its other physicochemical characteristics. Both plasma and milk contain various proteins, but none of the major proteins in milk bind drugs and other chemicals well.
8. The essential factors that modulate the plasma concentration of drug in the infant are: (1) *maternal factors*, such as the dose or dosing rate of the drug that is being administered, time of feeding, compliance with the prescribed schedule, and the pharmacokinetics of the drug in the mother; (2) *lactational factors*, which are determined largely by the drug’s physicochemical properties, the perfusion rate of the mammary glands, the differential milk/plasma pH, the degree of protein binding, and the volume of milk; and (3) *infant factors*, which mainly comprise the dosage rate, bioavailability, and pharmacokinetics of the drug in the infant
9. The milk-to-plasma (M/P) ratio is commonly used to express the relative concentration of a chemical in milk compared to its concentration in maternal plasma. In an examination of individual

drugs, those with a low M/P ratio are more likely to cause fewer dose-related adverse effects in the infant (because the concentration in the milk is low) than those with a high M/P ratio.

10. Some pharmacokinetic models of lactational transfer have considered milk fat as a part of total body fat, and assumed that the chemical of concern is equally equilibrated with a chemical compound. This may be an erroneous assumption. It has been estimated that, in humans, the milk fat to body fat ratio for some chemicals may be as high as 3.0 (one example is DDT). Data from studies in dairy cows have shown that some chemicals' concentrations in milk fat may be as much as 21.5 times greater than concentrations in body fat.
11. Several mathematical models also have been developed which describe the physiological process of lactational transfer of drugs and other chemicals. Some have good predictive power, allowing extrapolations beyond the calibration range. In applying these quantitative tools in risk assessment, however, it is crucial to understand their abilities and limitations and consequently to choose the right tool, adequate to the required level of accuracy and the acceptable level of uncertainty. Several types of models and their limitations are described below:
 - a. One approach is to calculate a biotransfer factor (BTF), which is the ratio of the contaminant concentration in animal tissue (mg contaminant/kg tissue, wet weight) to daily intake (mg contaminant/day). (The more fat-soluble a chemical may be, the higher the concentration it can reach in milk.) BTFs obtained from experimental data have then been correlated with compound-specific octanol/water partition coefficient (K_{ow}), presented as a series of geometric mean regression equations, depending on the medium. However, this simple correlation model is inadequate to account for volatile and rapidly metabolizing chemicals, does not address chemical-specific problems (e.g., with biological transport of ionized compounds), and neglects species-specific physiological parameters and intake scenarios.
 - b. Although QSAR models have the potential for solving the chemical-specific problems in predicting BTFs, they typically do not address species-specific physiology and differences in intake scenarios by different animals, and usually fail to predict metabolism rates
 - c. Another method involves use of steady-state modeling employing milk-to-plasma ratios. Chemical concentration in milk can either be estimated using M/P ratios based on human or animal data, or predicted using pharmacokinetic models. Although some authors have found it useful to determine experimentally the M/P ratios of drugs, most often these ratios are useful only for comparative purposes. Because milk/plasma coefficients cannot reflect the time-dependent variations, they are useful only for a steady-state estimation of dose received by the infant. However, the usefulness of an M/P modeling approach may be limited, for instance, by significant variability in single versus multiple dose milk/plasma ratios for most drugs. The usage of a single point in time M/P ratio or an average ratio calculated with single dose area

under the curve (AUC) data is not sufficient for all drugs. Milk volume and its constituents, drug metabolism rate, maternal disease, and drug interactions all affect the M/P ratio.

- d. The classical compartmental pharmacokinetic system has been used by many authors in modeling of lactational transfer of lipophilic drugs and other chemicals. An advantage of this modeling approach, when compared to the BTF or M/P approach, is that there is no need to assume a steady state. This is important because the drug concentrations in fat and milk evolve over time. However, there are limitations. For example, such models generally assume that the rate of mass transfer depends linearly on the concentration, and consideration of the milk fat as a part of the total maternal adipose tissue can be problematic. Addition of additional compartments may add to complexity of computation, and require interpretation of several abstract parameters which are usually not directly available for experimental physical measurements and are often counterintuitive. For some models, ignoring the time required to reach near-steady-state concentrations results in an overprediction of the concentration in milk fat. According to an EPA analysis, overpredictions of 10-fold or greater can occur when the half-life is large and the exposure duration is small. Overpredictions of breast milk concentrations will also result if maternal contaminant losses from breast-feeding are not considered.
12. PB/PK models have proven to be quite useful in predicting the lactational transfer of different types of drugs and other chemicals, and their validated predictions may be applied in risk assessments for exposure characterization in nursing infants. However, properly designed studies are required to address the kinetics of different chemicals. An example is the experimentally measured blood/air partition coefficient, which is indispensable for proper simulations, but is affected by hematocrit and lipid content. Also, the parameters used in PB/PK models for lactational transfer of drugs and other chemicals are based on normal breast-feeding women, and require adjustment to address non-normal conditions such as nutritional deficiencies or disease states such as diabetes.

C.5 CONCLUSIONS FROM ISSUE AREA 5: FUNCTION OF THE BLOOD-BRAIN BARRIER IN INFANTS, CHILDREN AND THE UNBORN

C.5.1 General Findings

The only sense in which the term “the blood-brain barrier” can be considered to define a single barrier mechanism is with respect to the exclusion of protein (or materials such as dyes that are bound to protein) from the adult brain by the tight junctions existing between endothelial cells in brain blood vessels. However, this barrier mechanism has much more physiological significance than the mere exclusion of proteins from the extracellular fluid of the brain. The tight junctions act as a diffusion restraint for a whole range of molecules, many of which are actively transported into or out of the brain. These active transport mechanisms, such as ion pumps, are responsible for the unique composition and stability of the brain’s internal environment, something that is essential to the normal functioning and development of the brain.

All of these mechanisms are frequently referred to using the general term “blood-brain barrier.” However, any consideration of such mechanisms requires that the mechanism be identified.

In the developing brain, with respect to the underlying diffusion barrier that excludes proteins from the brain’s extracellular fluid, this barrier mechanism develops very early, as do the tight junctions between choroid plexus epithelial cells that form the blood-CSF barrier. In addition, even in the fetuses and newborns of those species that are very immature at birth, there *also* exist other barriers to proteins at the CSF-brain interfaces on the inner and outer surfaces of the developing brain. These barriers consist of membrane specializations between the cells forming these interfaces; they are present only early in development when the concentration of proteins in the CSF is high. The high concentration of proteins in the CSF originates from transfer mechanisms that cause movement from plasma across a subpopulation of choroid plexus cells. Thus, any drugs or toxic ligands that bind to these proteins will enter the CSF in the fetal brain and may be taken up from the CSF into cells that are in contact with the CSF. The immature brain is also more permeable to low-molecular-weight, lipid-insoluble molecules than is the adult brain.

Recent work suggests that the route for this permeability is largely via the choroid plexuses via an intracellular pathway that transfers molecules at least as small as molecular weight 3000 to the CSF. From there the molecules are taken up into cells that have contact with the CSF.

Therefore, using brain/CSF ratios as an index of blood-brain barrier permeability (which implies transfer across the cerebral endothelium of brain blood vessels) is misleading. These mechanisms appear to be part of the specialized mechanisms that control the internal composition of the developing brain (as are mechanisms such as amino acid transport, which are more active in the developing brain than in the adult brain). Thus, although some materials (including some drugs and toxins) may enter the developing brain to a greater extent than the adult, this is probably a reflection of the activity of other factors (e.g., specialized transfer mechanisms, a slower rate of metabolism, or lesser binding to plasma proteins, rather than the immaturity of adult barrier mechanisms).

Low-molecular-weight, lipid-insoluble molecules (less than molecular weight = 500) do seem to enter the developing brain, especially early on, to a greater extent than the adult. Recent evidence suggests that this may be predominantly via the CSF. Lipid-soluble molecules will, of course, enter the brain and CSF at any age, unless bound to proteins, in which case their entry will also be via CSF early in brain development, when protein transfer is occurring across the choroid plexuses. Any greater entry rate of a drug or toxin into the immature brain, by whatever mechanism, may contribute to the greater vulnerability of the developing brain, but the principal reason for this vulnerability does not lie with differences in developmental differences in blood-brain barrier. Instead, it lies in the greater vulnerability of certain ongoing processes in the developing brain, such as mitosis, cell migration, and synaptogenesis, which are susceptible to toxins and some drugs.

Understanding the contribution of barrier permeability to the deleterious effects of drugs and toxins in the developing brain requires direct measurement of permeability under well-controlled experimental conditions. Barrier permeability cannot be inferred from a comparison of effects of a potential toxin on brain function in immature and adult brains.

There seems no doubt that the developing brain is more susceptible to the effects of toxins if exposed to them. In most of the cases discussed here, this greater susceptibility has not been demonstrated to result from greater blood-brain barrier permeability. Substantially more experimental work would be needed in order to provide an adequate description of the mechanisms underlying the developing brain's vulnerability to these and the many unstudied toxins that it might be exposed to.

C.5.2 Specific Findings:

1. The quality of the available literature in this area is generally poor, notwithstanding that almost all of the information reviewed came from peer-reviewed journals. Many textbooks and journal articles betray a fundamental lack of knowledge of the anatomical characteristics of the various systems that constitute the blood-brain barrier.
2. The brain develops within a unique environment that is distinct from the rest of the fetus, and this internal environment is regulated by some mechanisms that are not present in the adult. Examples include: specialized transfer mechanisms across the choroid plexus, and membrane specializations between the cells forming the CSF-brain interfaces on the inner and outer surfaces of the developing brain.
3. In much of the literature reviewed, barrier permeability to a particular drug or toxin has not been measured directly. Instead, effects in immature animals or children have been taken to be *evidence* of barrier permeability.
4. When making cross-species comparisons of specific systems or features of systems, certain pitfalls must be avoided. It is important to consider the particular stage of development of the species in relation to each other, absence of disease or other abnormality of the subjects (e.g., lack of respiratory problems in neonates).



What Did You Think?

We strive to constantly provide the highest level of value for you. Please take a few minutes to tell us about your experience using this product.

To be taken to a short consumer satisfaction survey, please [click here](#) or copy and paste the following URL into your browser:

[https://www.surveymonkey.com/r/OSAconsumerfdbck?
product=Exploration of Perinatal Pharmacokinetic Issues](https://www.surveymonkey.com/r/OSAconsumerfdbck?product=Exploration+of+Perinatal+Pharmacokinetic+Issues)

Thank you for your feedback.

Sincerely,

Office of the Science Advisor
United States Environmental Protection Agency
www.epa.gov/OSA@epa.gov