

United States  
Environmental  
Protection Agency

Office of Ground Water  
and Drinking Water (4601)

EPA/816-R-99-014c  
September 1999



# **The Class V Underground Injection Control Study**

---

## **Volume 3**

## **Storm Water Drainage Wells**

---

# Table of Contents

	<b>Page</b>
1. Summary .....	1
2. Introduction .....	4
3. Prevalence of Wells .....	5
3.1 Review of Literature .....	6
3.2 General Data Collection .....	6
3.3 Inventory Model .....	9
3.4 Factors Affecting Use and Prevalence of Wells .....	11
3.4.1 Housing and Population Density .....	11
3.4.2 Development .....	12
3.4.3 Historical and Political Practices .....	12
3.4.4 Geological Characteristics and Rainfall .....	12
3.5 Future Use of Storm Water Wells .....	13
4. Injectate Characteristics and Injection Practices .....	14
4.1 Injectate Characteristics .....	14
4.1.1 Inorganic Constituents .....	21
4.1.2 Organic Constituents .....	25
4.1.3 Biological/Microorganism Constituents .....	27
4.2 Well Characteristics .....	27
4.2.1 Dug Wells .....	28
4.2.2 Bored Wells .....	33
4.2.3 Lake Level Control Wells .....	35
4.2.4 Improved Sinkholes .....	36
4.3 Operational Issues and Concerns .....	37
4.3.1 The Impacts of Siting and Land Use on Injectate .....	37
5. Potential and Documented Damage to USDWs .....	40
5.1 Injectate Constituent Properties .....	40
5.2 Observed Impacts .....	41
5.2.1 Storm Water Drainage Well Contamination Incidents .....	41
5.2.2 Storm Water Drainage Wells: Other Contamination Incidents and Studies .....	44
5.2.3 Lake Level Control Wells Contamination Incidents .....	45
6. Best Management Practices .....	46
6.1 Siting BMPs .....	46
6.1.1 Minimum Setback Distance from Surface Waters .....	47

## Table of Contents (cont'd)

	Page
6.1.2	Minimum Setback Distance from Drinking Water Wells . . . . . 48
6.1.3	Minimum Separation from Water Table . . . . . 48
6.1.4	Prohibition from Some Areas of Critical Concern . . . . . 48
6.1.5	Minimum Engineering Design/Soil Performance Specifications . . . . . 48
6.2	Design BMPs . . . . . 49
6.2.1	Sediment Removal . . . . . 49
6.2.2	Oil and Grease Separators . . . . . 51
6.2.3	Additional Pretreatment System BMPs . . . . . 55
6.2.4	Studies on the Effectiveness of Pretreatment System BMPs . . . . . 57
6.3	Operational BMPs . . . . . 59
6.3.1	Source Separation . . . . . 59
6.3.2	Pollution Prevention Planning . . . . . 61
6.3.3	Spill Response . . . . . 63
6.3.4	Operational BMPs for Common Site Activities . . . . . 63
6.3.5	Monitoring BMPs . . . . . 64
6.3.6	Maintenance BMPs . . . . . 65
6.4	Education and Outreach BMPs to Prevent Misuse . . . . . 65
6.5	BMPs for Properly Closing, Plugging and Abandoning Storm Water Drainage Wells . . . . . 67
7.	Current Regulatory Requirements . . . . . 68
7.1	Federal Programs . . . . . 68
7.1.1	SDWA . . . . . 68
7.1.2	CWA . . . . . 70
7.1.3	CZMA and CZARA . . . . . 71
7.1.4	FHWA Guidance . . . . . 72
7.2	State and Local Programs . . . . . 72
7.3	Survey of Local Storm Water Utilities . . . . . 73
	Attachment A: State and Local Program Descriptions . . . . . 74
	References . . . . . 88

# STORM WATER DRAINAGE WELLS

---

The U.S. Environmental Protection Agency (USEPA) conducted a study of Class V underground injection wells to develop background information the Agency can use to evaluate the risk that these wells pose to underground sources of drinking water (USDWs) and to determine whether additional federal regulation is warranted. The final report for this study, which is called the Class V Underground Injection Control (UIC) Study, consists of 23 volumes and five supporting appendices. Volume 1 provides an overview of the study methods, the USEPA UIC Program, and general findings. Volumes 2 through 23 present information summaries for each of the 23 categories of wells that were studied (Volume 21 covers 2 well categories). This volume, which is Volume 3, covers Class V storm water drainage wells.

## 1. SUMMARY

Storm water drainage wells are used extensively throughout the country to remove storm water or urban runoff (e.g., precipitation and snowmelt) from impervious surfaces such as roadways, roofs, and paved surfaces to prevent flooding, infiltration into basements, etc. The primary types of storm water drainage wells are bored wells, dug wells, and improved sinkholes. In addition, "lake level control wells" are used to drain lakes to prevent overflow following heavy precipitation. Subsurface disposal of storm water is prevalent in places where there is not enough space for, or site characteristics do not allow, retention basins; where there is not a suitable surface water to receive the runoff; or where near-surface geologic conditions provide an attractive drainage zone.

The runoff that enters storm water drainage wells may be contaminated with sediments, nutrients, metals, salts, fertilizers, pesticides, and/or microorganisms. Storm water sampling data indicate that concentrations of antimony, arsenic, beryllium, cadmium, chromium, cyanide, lead, mercury, nickel, nitrate, selenium, and certain organics (e.g., benzene, benzo(a)pyrene, bis(2-ethylhexyl) phthalate, chlordane, dichloromethane, pentachlorophenol, tetrachloroethylene, and trichloroethylene) in storm water runoff have exceeded primary maximum contaminant levels (MCLs). Available sampling data also show that concentrations of aluminum, chloride, copper, iron, manganese, total dissolved solids (TDS), zinc, and methyl tert-butyl ether have exceeded secondary MCLs or health advisory levels (HALs). Water quality data from Florida indicate that lake level control well injectate has exceeded primary MCLs or HALs for turbidity, arsenic, pentachlorophenol, and fecal coliforms, as well as secondary MCLs for iron, manganese, pH, and color. Some of these same studies, however, report that no adverse effects on ground water were detected. In addition, some industry representatives assert that the quality of storm water drainage should be better today than reported in some of these studies, which predate the use of best management practices (BMPs) required under the National Pollutant Discharge Elimination System (NPDES) program.

In general, the point of injection for most storm water drainage wells is into sandy, porous soils, a permeable coarse-grained unit, karst, or a fractured unit because these types of formations can

readily accept large volumes of fluids. Such hydrogeologic characteristics usually allow contaminants to migrate readily into ground water without significant attenuation.

Contamination related to storm water drainage wells has been reported to various degrees in Ohio, Kansas, Wisconsin, California, Washington, Arizona, Oklahoma, Tennessee, New York, Indiana, Florida, Kentucky, and Maryland. Several studies, however, do not clearly distinguish contamination from storm water drainage wells versus more general, nonpoint source pollution. The following three examples demonstrate cases in which storm water drainage wells have contributed to or caused ground water contamination.

- In 1989, a commercial petroleum facility in Fairborn, Ohio accidentally released 21,000 gallons of fuel oil that overflowed a diked area and entered two storm water drainage wells.
- In 1980, organic solvent contamination was discovered in drinking water supply wells for Lakewood, Washington following the disposal of organic waste solvents and sludge in leach pits and storm water drainage wells at McChord Air Force Base.
- In 1998, the Oak Grove, Kentucky water plant (a ground water system) was shut down due to a sharp increase in raw turbidity following a severe storm event.

Lake level control wells have been associated with two documented contamination incidents. The first occurred in 1993 when private drinking water wells in Lake Orienta, Altamonte Springs, Florida, were contaminated. In 1998, private wells in Lake Johio, Orange County, Florida, were contaminated by fluids released into lake level control wells.

As illustrated by some of these incidents, storm water drainage wells are generally vulnerable to spills or illicit discharges of hazardous substances, as they are often located in close proximity to roadways, parking lots, and commercial/industrial loading facilities where such substances are handled and potentially released. The use of a number of BMPs can reduce the likelihood of contamination, including siting, design, and operation BMPs as well as education and outreach to prevent misuse, and finally, proper closure and abandonment. However, the frequency and pattern of BMP use varies across the country. For example, public commenters on the July 28, 1998 proposed revisions to the Class V UIC regulations cited cases in which citizens have been observed draining used motor oil into storm water drainage wells, where no measures are in place to prohibit illicit discharges. Some lakes that are drained by lake level control wells are also vulnerable to spills or illicit discharges.

Based on the state and USEPA Regional survey conducted for this study, there are approximately 71,015 documented storm water drainage wells and approximately 247,522 storm water drainage wells estimated to exist in the U.S. About 81 percent of the documented wells are in seven western states: Arizona (14,857), California (3,643), Washington (22,688), Oregon (4,148), Idaho (5,359), Montana (>4,000), and Utah (2,890). Five other states contain approximately 15 percent of the total documented wells: Ohio (3,036), Florida (2,153), Michigan (1,301), Maryland (1,678), and Hawaii (2,622). There is considerable uncertainty regarding the exact number of storm

water drainage wells for several reasons, as described in section 3.2.2. There are approximately 200 - 250 lake level control wells in Florida.

In general, the installation of new storm water drainage wells is expected to increase nationwide. Many states are allowing the installation of new wells, and with the increased regulation of surface discharge under the NPDES Program, there may be increased use of underground injection to dispose of storm water runoff.

Some states with the majority of storm water drainage wells have developed and are implementing regulatory programs to address these wells. Examples include the following:

- In Idaho, wells #18 feet deep are authorized by rule, while deeper wells are individually permitted.
- In Arizona, California, Hawaii, Florida, and Maryland, storm water drainage wells are individually permitted.

Other states with large numbers of storm water drainage wells, however, are essentially implementing only the minimum federal UIC requirements. In particular, Washington, Oregon, Montana, Utah, Ohio, and Michigan authorize storm water drainage wells by rule.

The regulatory structure in other states with fewer or no storm water drainage wells in the current inventory is also mixed. For example, Indiana, Illinois, Wyoming, North Dakota, South Dakota, Colorado, Kansas, Tennessee, and Rhode Island also authorize storm water drainage wells by rule. Alabama, Texas, New Hampshire, and Nebraska have a permit and registration system for storm water drainage wells. Georgia and North Carolina ban new and existing wells. In Wisconsin, storm water drainage wells deeper than 10 feet have been prohibited since the 1930's. Shallow storm water drainage wells (less than 10 feet deep) in Wisconsin were authorized by rule until 1994; since 1994, construction of any storm water drainage well has been prohibited. Storm water drainage wells that meet the definition of a "well" in Minnesota are prohibited. This prohibition only applies to wells that reach ground water and not to french drains, gravel pockets, or drainfields, which normally would not meet the definition of a well in Minnesota.

These regulatory programs in the states are augmented to a degree by programs and guidance at the federal level. The Sole Source Aquifer Program has been used by some regions as a way to limit or prevent the use of storm water drainage wells by reviewing federal financially assisted construction projects in sole source aquifer areas. The Federal Highway Administration's (FHWA's) highway runoff water quality standards indirectly reference storm water. Although these are non-enforceable recommendations only, FHWA has issued guidance that discusses BMPs, such as wet and dry detention basins, infiltration trenches and basins, and dry wells, for controlling storm water runoff and infiltration into ground water. The Coastal Zone Management Act and Coastal Nonpoint Pollution Control Program also indirectly reference storm water in nonpoint pollution regulations; however, storm

water discharges controlled under the NPDES Program are exempt from the coastal nonpoint pollution control program.

## 2. INTRODUCTION

The removal of storm water or urban runoff is often accomplished using either detention or retention ponds, which then drain to an underground formation or to an outflow (i.e., stream), a municipal storm or combined sewer system, or a direct subsurface disposal system (including dry wells and improved sinkholes). The subsurface disposal of storm water into dry wells, improved sinkholes, and other devices that qualify as injection wells is prevalent in some regions where (1) space, economic feasibility considerations, or other site characteristics preclude the use of retention basins, storm sewer, or combined sewer systems or (2) where there is no suitable receiving water. In many places, draining excess storm water into wells provides valuable flood control or aquifer recharge benefits.

A well is defined by USEPA in 40 CFR §144.3 as a bored, drilled or driven shaft, or a dug hole, whose depth is greater than the largest surface dimension. The federal UIC regulations also specifically define Class V injection wells to include “drainage wells used to drain surface fluid, primarily storm runoff, into a subsurface formation” (40 CFR 146.5(e)(4)). It should be noted that for some wells, particularly in the Class V category, fluid is introduced into the subsurface through passive infiltration, where it “drains” into the ground at atmospheric pressure utilizing only the head difference (i.e., pressure resulting from the difference in elevation between two points in a body of fluid) between the ground surface and the receiving formation, rather than through forced injection, where fluid is pumped into the ground under pressure.

Although a variety of storm water drainage well configurations exist, dug wells, bored wells, and improved sinkholes are the most common. Lake level control wells, which were categorized as “special drainage wells” in USEPA’s 1987 Class V UIC Report to Congress (USEPA, 1987), are also included in this volume because their primary purpose is to provide flood control by draining storm water that would otherwise overflow from lakes.

“Infiltration galleries” are also considered injection wells. These galleries consist of one or more vertical pipes leading to a horizontal, perforated pipe laid within a trench, often backfilled with gravel or some other permeable material. Such a design is commonly used to return treated ground water at aquifer remediation sites, but is also used to facilitate storm water drainage at some sites. Each of the vertical pipes in such a system, individually or in a series, should be considered an injection well subject to UIC authorities (Elder and Lowrance, 1992).

Other kinds of systems with a drainfield type of design are also likely to be considered injection wells, as long as they release fluids underground as opposed to a surface water body or the land surface. These may include french drains, tiles drains, infiltration sumps, and the like.

Injection wells, however, do not include surface impoundments, trenches, or ditches that are wider than they are deep. Therefore, although such features are commonly used to direct or retain

storm water runoff, they do not qualify as injection wells themselves. Storm water trenches, nevertheless, are discussed in this volume because they are often integral parts of storm water drainage systems.

Storm water drainage well designs vary depending on the soil type, geology, and depth to the water table. For example, storm water drainage wells range in depth from only a few feet to several hundred feet. In some areas, wells tend to be shallower when the bedrock is near the surface. In other areas, well depth is more closely related to permeability of the subsurface than to depth of the bedrock. Section 4.2 discusses common design characteristics of storm water drainage wells.

### **3. PREVALENCE OF WELLS**

Many experts believe that the use of storm water drainage wells is widespread across the nation, despite the fact that less than half of the states report these wells in current inventories. Some state officials say they have failed to identify improved sinkholes accepting storm water runoff as Class V wells and others have had difficulty locating wells that have been operating for decades. Furthermore, the definition of storm water drainage wells may vary by state. For example, Florida classifies lake level control wells as storm water drainage wells. As a result of all of these factors, the present inventory likely does not provide an accurate estimate of the number of storm water drainage wells and may underestimate their use across the country.

The use of storm water drainage wells is more prevalent in areas that have poor surface drainage and intermittent, high intensity storms. Poor drainage can result from flat topography, a closed drainage basin, soil characteristics, or the reduction of natural infiltration due to agricultural or urban activities (Arizona Department of Water Resources, 1993). In addition, storm water wells are found in areas lacking adequate storm sewer systems and where rapid urban expansion has out-paced infrastructure development. Estimates and field observations in Arizona indicate that storm water drainage wells are more likely to occur in industrial or commercial areas where there are more paved surfaces; however, storm water wells may also be located in residential areas (Arizona Department of Environmental Quality, 1988).

USEPA used three different methods to help determine the numbers and patterns of use of storm water drainage wells across the nation. First, a comprehensive review of existing literature was performed to examine historical data on the prevalence of storm water wells. Next, USEPA initiated a general data collection effort to obtain state-specific data on Class V issues, including the use of storm water wells. Finally, site visits to designated census tracts across the country were performed to survey storm water drainage wells and to model their numbers at a national level. Because existing state inventories may underestimate the actual number of storm water wells, this inventory modeling effort was designed to provide a more accurate national picture of the prevalence of storm water wells. Discussion of these efforts and their findings follows.



### **3.1 Review of Literature**

In 1998, USEPA undertook an extensive search and review of existing studies and literature on storm water drainage wells. Studies were gathered from a variety of sources, including federal, state, and local governments, universities, research institutes, and private companies. USEPA reviewed these studies in an effort to gain an understanding of the current prevalence of storm water wells.

Existing literature shows that storm water drainage wells exist in a variety of areas with differing characteristics. Certain areas, including some large cities, use many wells. For example, the City of Modesto, California makes extensive use of drain or “rock wells” to serve 70 percent of the city area (Cadmus, 1999). Data shows that highly urbanized sections of Spokane County, Washington achieve nearly 100 percent of their ground water recharge through dry well injection (Cadmus, 1999).

At the same time, studies found that little documentation of the number of storm water wells nationwide exists and that existing counts likely underestimate the number of active wells. Although there are numerous site-specific studies that describe areas using storm wells, existing literature sheds little light on the national picture.

### **3.2 General Data Collection**

For this study, data on the number of storm water drainage wells were collected through a survey of state and USEPA Regional UIC Programs. The survey methods are summarized in Section 4 of Volume 1 of the Class V Study.

In response to this survey, many state officials estimated that significantly more wells exist in their state than are shown in their official inventory. State officials believe that many storm water wells are not documented for a number of reasons, including:

- Wells may be located on private property where they cannot be readily found by state officials without assistance from the land owner.
- States may not have located wells built before the state environmental agencies had primacy for the Class V program.
- Multiple state and local agencies may track storm water wells and coordination between these agencies is often lacking.
- States may believe that wells have been properly plugged, but have never inspected these wells to ensure that they are not still operating.
- Many people do not consider improved sinkholes to be Class V wells and thus, in some cases, these wells may not be counted.

Table 1 lists the numbers of storm water drainage wells in each state and USEPA Region, as determined from the survey. The Table includes the documented number and the estimated number of storm water drainage wells and the source and basis for any estimate, when noted by survey respondents. For states not listed in Table 1, no survey was returned or the UIC Program responsible

for that state indicated in the survey that no storm water drainage wells were present. The respondents reported 71,015 documented wells nationwide. However, states and USEPA Regions estimate that the actual number of operating storm water wells may be closer to 247,522.

**Table 1. Inventory of Storm Water Drainage Wells in the U.S.**

State	Documented Number of Wells	Estimated Number of Wells	
		Number	Source of Estimate and Methodology <sup>1</sup>
<b>USEPA Region 1</b>			
CT	0	NR	Number is believed to be low, but no reliable estimate is available.
MA	0	NR	No estimate provided, but state suspects some wells exist.
ME	0	NR	No estimate provided, but state suspects some wells exist.
NH	Unknown	Unknown	The true documented number of wells is unknown because they are found only when inspections are performed.
RI	122	NR	State unable to give an estimate because it has not initiated a complete inventory.
VT	NR	NR	N/A
<b>USEPA Region 2</b>			
NJ	NR	NR	N/A
NY	84	30,000	Best professional judgement by USEPA Region 2 based on inspections and availability of permeable soils in the state.
PR	1	NR	N/A
VI	0	1,500	USEPA Region 2 estimate based on review of inspection reports and business directory.
<b>USEPA Region 3</b>			
MD	1,678	NR	N/A
PA	NR	NR	N/A
VA	NR	NR	N/A
WV	94	>94	Best professional judgement.
<b>USEPA Region 4</b>			
AL	13	13	N/A
FL	2,153	>3,112	Best professional judgement and available files. Sinkholes not included. Lake level control wells included in estimate.
GA	61	NR	State has limited information, but believes there may be additional wells at older facilities.

**Table 1. Inventory of Storm Water Drainage Wells in the U.S. (cont'd)**

State	Documented Number of Wells	Estimated Number of Wells	
		Number	Source of Estimate and Methodology <sup>1</sup>
KY	NR	NR	N/A
SC	37	>37	No estimate provided, but state believes more than the documented number exist.
TN	Unknown	Unknown	N/A
<b>USEPA Region 5</b>			
IL	735	NR	No estimate provided, but state believes documented number is inaccurate.
IN	344	NR	No estimate provided, but USEPA Region 5 believes documented number is inaccurate.
MI	1,301	>1,301	No estimate provided, but USEPA Region 5 suspects more than the documented number exist.
MN	0	NR	No estimate provided, but state suspects some wells exist.
OH	3,036	>30,000	Based on surveys of selected communities, discussion with local health departments, knowledge of regional geology, and best professional judgement.
WI	500	500	N/A
<b>USEPA Region 6</b>			
TX	10	10	Based on database.
<b>USEPA Region 7</b>			
KS	10	<100	Best professional judgement.
MO	340	340	N/A
NE	4	4	N/A
<b>USEPA Region 8</b>			
CO	1	NR	N/A
MT	>4,000	5,000	Best professional judgement.
ND	5	5	N/A
SD	0	0 (at most 1 or 2)	Best professional judgement.
UT	2,890	\$2,890	N/A
WY	21	21	N/A

**Table 1. Inventory of Storm Water Drainage Wells in the U.S. (cont'd)**

State	Documented Number of Wells	Estimated Number of Wells	
		Number	Source of Estimate and Methodology <sup>1</sup>
<b>USEPA Region 9</b>			
AZ	14,857	14,857	N/A
CA	3,643	>26,480	Best professional judgement and estimates from three counties.
HI	2,622	2,622	N/A
NV	NR	50 - 100	Best professional judgement.
GU	172	172	N/A
AS	Unknown	NR	N/A
<b>USEPA Region 10</b>			
AK	86	125	Best professional judgement.
ID	5,359	7,675	USEPA Region 10 estimate based on conversation with state personnel.
OR	4,148	20,000	Best professional judgement and draft reports from cities of Portland, Bend, and Canby.
WA	22,688	100,000	Best professional judgement.
<b>All USEPA Regions</b>			
All States	71,015	± 247,522	The total estimated number counts the documented number when the estimate is NR.

<sup>1</sup> Unless otherwise noted, the best professional judgement is that of the state or USEPA Regional staff completing the survey questionnaire.

N/A Not available.

NR Although USEPA Regional, state and/or territorial officials reported the presence of the well type, the number of wells was not reported, or the questionnaire was not returned.

Unknown Questionnaire completed, but number of wells is unknown.

### 3.3 Inventory Model

Because existing data are believed to be inaccurate, USEPA constructed a model to estimate the number of storm water drainage wells nationwide. The inventory model was designed to predict the number of wells nationally based on geologic, demographic, and other characteristics of specific census tracts. However, there is little theory and virtually no empirical research regarding the factors affecting the number and location of these wells. USEPA made assumptions based on geologic and demographic variables in order to pick census tracts to include in the sample. See Section 5 of Volume 1 of the Class V Study and Appendix C of the Class V Study for a complete description of the development and results of this statistical inventory model used by USEPA.

Under the modeling effort, USEPA's national estimate of storm water drainage wells is the combination of two estimates: (1) a model estimate for wells in non-urbanized areas, and (2) state estimates of the number of wells in urbanized areas. This approach is necessary because of the census selection strategy. Urbanized areas were excluded from the survey based on the assumption that very few storm water drainage wells would be found in urbanized areas. While a few cities make extensive use of these wells, USEPA could not adequately represent all urbanized areas in the census survey to account for these wells because of the relatively small sample size. Therefore, USEPA relied on state and other estimates gathered as part of the general data collection effort to account for the wells in urbanized areas, and used the census survey to build a model of the number of wells in non-urbanized areas. The estimate of the total number of wells in the country is the sum of these two estimates. The methods and results for these two estimates are summarized below and discussed in more detail in Appendix C of the Class V Study.

#### *Wells in Non-Urbanized Areas*

The existence of storm water drainage wells in the census survey is a relatively rare event. Of the 99 tracts in the census tract sample, 22 contained storm water drainage wells. Therefore, a two-part model is used to estimate the number of wells in each tract. The first part of the model estimates the probability that a given tract contains storm water drainage wells. The second part of the model estimates the average number of wells in tracts containing wells. The expected number of wells is then equal to the probability estimated in the first part of the model times the average estimated in the second part. The best estimate of the number of wells in non-urbanized areas is approximately 64,000.

#### *Wells in Urbanized Areas*

USEPA used the results from the general data collection described above to estimate the number of storm water drainage wells in urbanized areas. The location of municipalities in each state responding to the survey was mapped to determine which of the reported storm water drainage wells fell into urbanized areas (as defined by the Census Bureau and this study). Approximately 35,000 wells are documented in urbanized areas in these states. States estimate an additional 26,500 wells in urbanized areas. This is likely an underestimate for several reasons. First, the states believe their estimates are lower than the actual number of wells that exist, as discussed in Section 3.2. Second, where a range was provided, USEPA took the lower end of the range. Finally, it could not always be determined if the estimated number of wells was in urbanized or non-urbanized areas. Where this was the case, these estimates were not counted as part of the urbanized total.

#### *Conclusions*

The estimate for the total number of wells in the country is equal to the estimates for urbanized areas plus the model's estimate for non-urbanized areas, which totals approximately 125,500. A breakdown of this total is provided in Table 2.

**Table 2. Inventory Model Results for Storm Water Drainage Wells**

Location	Number of Storm Water Drainage Wells
Non-urbanized areas (data collected through census tract visits; modeled)	64,000
Urbanized areas (data collected through general data collection; no modeling)	
<ul style="list-style-type: none"> <li>• Documented by states</li> </ul>	35,000
<ul style="list-style-type: none"> <li>• Estimated by states</li> </ul>	26,500
National total	125,500

### 3.4 Factors Affecting Use and Prevalence of Wells

At the outset of this study, USEPA gathered information from a variety of sources on factors affecting the use of storm water drainage wells. These sources generally led USEPA to assume that storm water wells are widespread across the nation. The key factors used to determine where storm water wells existed were geology and demographics. USEPA assumed that areas with karst features or other fractured bedrock were most conducive to the use of storm water wells. Furthermore, USEPA assumed areas with very high or low housing or population densities would not have many wells.

The census tract visits shed new light on factors affecting the use and prevalence of wells. This effort showed that storm water drainage wells are not distributed evenly across the nation, but instead are clustered in certain areas with a range of different characteristics. There are several different factors that impact the use of storm water wells. Although the data do not present a clear pattern, several important observations can be made. A discussion of these observations follows.

#### 3.4.1 Housing and Population Density

In the census tract sample, USEPA ruled out tracts with very high or low housing or population densities. For example, areas such as Manhattan were not expected to use storm water wells and were excluded from the modeling effort. This factor, however, did not always turn out to be a reliable indicator of the use of storm water wells. USEPA learned that storm water wells can be found in both urban and non-urban areas. Storm water wells are often found in relatively densely populated small communities and suburban areas lacking adequate storm sewer systems. For these communities, injection wells are a relatively inexpensive method of preventing flooding when the infrastructure is not sufficient to handle storm runoff. Storm water wells in these areas are commonly found on the sides of roads, in parking lots, and in housing developments.

USEPA also found that large cities across the country use storm water wells. Even though these areas are most often sewered, injection wells can be a chosen method of disposal for storm water

runoff. State and local officials claim that storm water wells are relatively inexpensive and may serve a dual purpose of recharging the ground water. Where this has historically been the practice, some larger cities continue to use storm water wells as the city expands. In fact, large numbers of storm water drainage wells are located in urban areas that rely heavily on their use. For example, nearly 12,000 storm water wells are estimated to exist in the Phoenix, Arizona, area. Although most of the city is sewerred, storm water wells are used as a method of recharging ground water in the area because it gets little precipitation. Other cities, such as Miami, Florida, find that storm water wells are an effective means of dealing with significant storm events.

### 3.4.2 Development

Storm water wells are also found in some areas of rapid urban expansion, especially where expansion has outpaced infrastructure development. In these areas, storm water wells help prevent flooding from impervious surfaces such as parking lots and roads. The development of an area limits natural infiltration and increases the potential for flooding; wells are often used as an interim or long-term solution to this problem.

In other cases, development may have occurred in a rural community that traditionally used storm water wells. As a nearby city rapidly developed into surrounding communities, existing storm water wells may not have been properly abandoned or plugged as the area was sewerred. In addition, some users, such as strip mall owners, may have chosen not to connect to the sewer lines because of the cost. The scenario is most plausible in very large cities that have experienced significant urban and suburban development around their perimeters.

### 3.4.3 Historical and Political Practices

USEPA's data collection and site visit efforts show that the historical and political practices of an area significantly impact the use of storm wells. For example, in areas where public awareness of water conservation issues is strong, storm water wells are a politically popular approach to dealing with runoff. Additionally, some cities or communities that do not have the infrastructure or funding to install sewer systems require that storm water be handled onsite. Because other methods of storm water drainage, such as retention ponds, take up significant space, these communities often use wells instead. For example, state officials in Oregon have indicated that cities such as Portland do not use retention ponds because it is too expensive to buy the land needed from private owners to build the ponds (Cadmus, 1999). USEPA found that adjacent communities with similar geologic characteristics and precipitation rates may have widely varying use of storm wells based on historical practices and political perceptions.

### 3.4.4 Geological Characteristics and Rainfall

Geological conditions and the amount of rainfall the area receives are other indicators of where storm water wells exist. For example, clay formations make the use of injection wells ineffective, while karst regions are ideal for their use. The use of storm water drainage wells is prevalent in areas that

have poor drainage and intermittent, high intensity storms. Poor surface drainage can result from flat topography or the elimination of natural infiltration as a result of urban activities. In areas where topographic conditions result in closed drainage basins (e.g., Florida), storm water drainage wells have also been used to drain storm runoff. There are three basic subsurface geologic factors that positively influence the location of storm water wells: karst features, other fractured bedrock, and extensive sandy materials, such as an unconfined alluvial aquifer. The occurrence of such conditions near the land surface can enable the injection and disposal of storm water.

The use of storm water wells in Hawaii, for example, is attributable mainly to geological factors, including slope and grade, and the depth of topsoil. The Island of Hawaii, which is the youngest island geologically, has little topsoil. Digging into rock in order to install culverts and ditches has proven impractical and expensive, so the Island uses many storm water wells instead. On the other hand, Oahu is an older island with more topsoil, making digging easier and less expensive. Oahu operates a well developed storm sewer system and, unlike its sister island, does not rely on storm water wells.

### **3.5 Future Use of Storm Water Wells**

USEPA expects to see a gradual increase in the future number of storm water wells nationwide. This increase can be attributed to several factors. First, many states continue to allow installation of new storm water wells. For example, the Florida Department of Environmental Protection receives about ten new storm water permit applications a month from Dade County alone for injection into aquifers that are not USDWs. Permit applications for storm water drainage wells also continue to be submitted for Monroe County (i.e., Florida Keys) (see Section 7 and Attachment A of this volume for a more complete picture of state programs for storm water drainage wells).

Second, few states have undertaken efforts to close existing storm water drainage wells. While states such as Wisconsin have not allowed the construction of new wells since 1994, wells less than ten feet deep which were built prior to 1994 continue to operate. Therefore, USEPA predicts that the current number of active wells is unlikely to drop significantly. In addition, even when wells are abandoned by the owner or operator, few states perform inspections of these wells to determine if they are properly plugged. Some state and local officials report that wells are often abandoned but not properly plugged and, thus, are still able to accept storm runoff (Cadmus, 1999).

Third, rapidly developing urban areas, such as Phoenix, Arizona and Miami, Florida, plan to continue to build storm water wells as a cost-effective way to dispose of runoff and to recharge ground water (Cadmus, 1999).

Lastly, an increase in the regulation of storm water discharges to surface waters under the NPDES Storm Water Program may make disposal through underground injection a more attractive alternative for storm water runoff.



## 4. INJECTATE CHARACTERISTICS AND INJECTION PRACTICES

### 4.1 Injectate Characteristics

The types and concentrations of contaminants found in storm water are dependent on site-specific conditions and vary greatly based both on the activities and management practices employed at each site and on local rainfall patterns. Storm water can become contaminated when it flows over, or otherwise comes in contact with, substances stored on a site or from surfaces where pollutant residues are found. Storm water runoff can also become contaminated through spills, accidents, or the intentional misuse of drainage wells to dispose of illicit materials (e.g., pouring used motor oil into a storm drain). Automobile residues such as oil, gasoline, antifreeze, and other drippings on pavement also can be transported by storm water. Vehicle-related and atmospheric deposition are the two major sources of constituents that accumulate on highway surfaces, median areas, and adjoining right-of-way (USDOT, 1996). The exposure of vehicles to precipitation may increase levels of heavy metals in storm water (Kobriger, 1984). In addition, substances that readily dissolve in water, such as de-icing salt, also often become incorporated into storm water runoff. Storm water also can sweep away a wide variety of other contaminants, including metals that are often bound to sediments. One study demonstrated that storm water runoff from roads and parking lots contained elevated levels of cadmium and copper, which if located near a drinking water aquifer, could be a long-term source of contamination (Wilde, 1994). Table 3 lists some of these pollutants and the sources with which they are commonly associated.

**Table 3. Common Pollutants and Non-Industrial Pollutant Sources Associated with Storm Water Runoff**

Pollutant	Potential Source
Lead	Vehicles: exhaust, tire wear (filler material), lubricating oil and grease Structures and roads: paint
Zinc	Vehicles: tire wear (filler material), oil and grease (stabilizing additive), brake pads, metal corrosion Paved surfaces: deicing salts Structures: paint, metal corrosion, wood preservative
Copper	Vehicles: parts wear (brakes, metal plating, bearings and bushings), diesel fuel Structures: paint, metal corrosion, wood preservative Other: pesticides
Cadmium	Vehicles: tire wear (filler material) Other: pesticides
Chromium	Vehicles: parts wear (brakes, metal plating, engine parts)
Nickel	Vehicles: diesel fuel, lubricating oil, parts wear (brakes, metal plating, and bushings) Paved Surfaces: asphalt
Manganese	Vehicles: parts wear (engine parts)

**Table 3. Common Pollutants and Non-Industrial Pollutant Sources  
Associated with Storm Water Runoff (cont'd)**

<b>Pollutant</b>	<b>Potential Source</b>
Mercury	Vehicles: fuel combustion Structures: paint Other: coal combustion
Iron	Vehicles: body rust, engine wear Structures: rust
PAHs	Vehicles: exhaust Other: incomplete combustion
Chloride	Paved surfaces: deicing salts
Sulfates	Vehicles: exhaust Paved surfaces: road beds, deicing salts Other: combustion product
Nitrogen, Phosphorus	Vehicles: exhaust Other: combustion product Landscape maintenance: fertilizers Soil erosion: land disturbance, exposed soils Sewage: leaking sanitary systems, septic systems
Sediments, Particulates	Soil erosion: land disturbance, exposed soils
Pesticides	General outdoor application Structures: wood preservatives, paint
Floatables	Litter: residential, commercial, industrial, recreation Waste disposal: residential, commercial, industrial, recreation Vegetation: leaves, branches, trunks
Bacteria	Sewage: leaking sanitary systems, septic systems Other: animal droppings Soil erosion: exposed soils
Oil and Grease	Vehicles: drippings, leaks Paved surfaces: asphalt
PCBs	Vehicles: catalyst in synthetic tires
Benzene	Vehicles: fuel Other: solvent use
Toluene	Vehicles: fuel and asphalt Other: solvent use
Chloroform	Vehicles: resulting from mixing salt, gasoline and asphalt
Oxygen Demand	Vegetation: leaves Litter: various sources Soil erosion: land disturbance, exposed soils
Phthalate, bis(2-ethylhexyl)	Structures: plasticizer Other: plasticizer

Sources: Kobriger et al., 1981; USEPA, 1995b.

Lake level control wells receive a mixture of rainfall, ground water seepage, and storm water during the wet seasons. During the dry season, groundwater seepage is the main injectate (Bradner, 1996). According to the St. Johns River Water Management District, the injectate is generally of better quality than discharged storm water; however, some of the lake fluids still do not meet MCLs at the point of injection (Cadmus, 1999).

The constituents found in storm water runoff and lake level control injectate can be broadly categorized into inorganic constituents, organic constituents, and microorganism contaminants. Sampling results from studies that address the occurrence of these constituents are summarized below in Table 4 for storm water drainage wells. This information is based on data from twenty-one studies of storm water runoff from numerous sites around the U.S. The majority of the studies were conducted in the mid 1980's; however data from as recent as 1998 were also reviewed. Many of the studies examined pollutant concentrations in several sources including storm water runoff, ground water, and injection well sediments. Only data from storm water runoff are included in this summary. While some of these data show constituents detected in storm water runoff that exceed drinking water standards, many of the studies reported that contamination of associated ground water was not detected.

**Table 4. Summary of Constituent Concentrations in Storm Water Runoff**

<b>Constituents</b>	<b>Range</b> (mg/l unless otherwise noted)	<b>Reference**</b>
TDS-Total dissolved solids	18 - 1,436	Woessner and Wogoland, 1987
TSS-Total suspended solids	25 - 8,058	Resnick and DeCook, 1983
Conductivity (micromhos/cm @25°)	12 - 5,540	Shaw and Berndt, 1990
pH (units)	3.4 - 9.9	Resnick and DeCook, 1983
Color (Platinum-cobalt units)	2 - 100	German, 1989
Turbidity (nephelometric units)	2.5 - 25	German, 1989
Aluminum, total recoverable	0.010 - 0.390	Shiner and German, 1983
Ammonia as Nitrogen	<0.01 - 7.2	Nussbaum, 1991
Antimony	0.0026 - 0.050	Wilson et al., 1992
Arsenic	0.001 - 0.0505	Nussbaum, 1991
Barium	0.10*	German, 1989
Beryllium	0.001 - 0.049	Nussbaum, 1991
Biochemical oxygen demand	13 - 66	City of Modesto, 1997
BOD-Biological oxygen demand	<0.01 - 1,425	Campbell, 1985
Bicarbonate	5 - 156	Schmidt, 1985
Boron	0.1 - 0.6	Schmidt, 1985
Cadmium	0.0003 - 0.220	Wilson et al., 1992
Calcium	3.5 - 110	Resnick and DeCook, 1983
Calcium Carbonate, as alkalinity	8 - 120	Nussbaum, 1991
Calcium Carbontate, as hardness	94 - 128	Wilson, 1983

**Table 4. Summary of Constituent Concentrations in Storm Water Runoff (cont'd)**

<b>Constituents</b>	<b>Range</b> (mg/l unless otherwise noted)	<b>Reference**</b>
Carbon, Total organic	11 - 250	Schmidt, 1985
Carbonate	0 - 0.30	Wilson, 1983
Chemical oxygen demand (COD)	8 - 13,800	Resnick and DeCook, 1983
Chloride	1.0 - 3,550	Shaw and Berndt, 1990
Chromium	0.0006 - 0.610	German, 1989
Copper	0.002 - 1.25	Pitt et al., 1994
Cyanides	0.002 - 0.300	USEPA, 1983
Dissolved oxygen	7.8 - 12.2	Nussbaum, 1991
Fluoride	0.20 - 0.97	Wilson, 1983
Iron	0.07 - 27.3	Marsh, 1993
Lead	0.0001 - 1.869	Wilson et al., 1992
Lead, Dissolved	0.001 - 0.076	German, 1989
Magnesium	0.3 - 35	Resnick and DeCook, 1983
Manganese	0.005 - 0.910	Marsh, 1993
Mercury	0.0006 - 0.0023	Wilson et al., 1992
Nickel	0.001 - 0.900	Wilson et al., 1992
Nitrate	0.1 - 43	Resnick and DeCook, 1983
Nitrate & Nitrite	<0.01 - 7.0	Nussbaum, 1991
Nitrogen, Dissolved	0.6 - 6.5	German, 1989
Nitrogen, Total	0.96 - 8.2	Shiner and German, 1983
Nitrogen, Total Kjeldahl (TKN)	0.21 - 45	Nussbaum, 1991
Phosphate	0.38 - 0.91	Wilson, 1983
Phosphorus, Dissolved	0.05 - 0.41	German, 1989
Phosphorus, Total	0.01 - 40	Nussbaum, 1991
Potassium	0.6 - 11	Nussbaum, 1991
Selenium	0.002 - 0.077	USEPA, 1983
Silica	0.1 - 15	Nussbaum, 1991
Silver	0.0002 - 0.020	Wilson et al., 1992
Sodium	1.6 - 988	Shaw and Berndt, 1990
Sulfate	<5 - 75	Schmidt, 1985
Thallium	0.001 - 0.014	Nussbaum, 1991
Zinc	0.0018 - 4.398	Wilson et al., 1992
Zinc, Dissolved	0.170 - 0.190	City of Modesto, 1997
Total Coliform (colonies/ 100mL)	1.6 x 10 <sup>6</sup> - 2.0 x 10 <sup>8</sup>	Resnick and DeCook, 1983
Fecal Coliform (colonies/100 mL)	1.6 x 10 <sup>5</sup> - 2.0 x 10 <sup>7</sup>	Resnick and DeCook, 1983

**Table 4. Summary of Constituent Concentrations in Storm Water Runoff (cont'd)**

<b>Constituents</b>	<b>Range</b> (mg/l unless otherwise noted)	<b>Reference**</b>
Fecal Streptococci (colonies/100 mL)	7.8 x 10 <sup>4</sup> *	Resnick and DeCook, 1983
Acenaphthene	0.00014 - 0.001	Wilson et al., 1992
Acenaphthylene	0 - 0.000104	Wilson et al., 1992
Aldrin	0 - 0.00002	Wilson et al., 1992
Anthracene	0.0007 - 0.021	Wilson et al., 1992
Benzene	0.001 - 0.013	USEPA, 1983
3,4-benzofluoranthene	0.0026 - <0.020	Schmidt, 1985
Benzo (a) anthracene	0.060*	Pitt et al., 1994
Benzo (b) fluoranthene	0.0006 - 0.310	Wilson et al., 1992
Benzo (k) fluoranthene	0.001 - 0.240	Wilson et al., 1989
Benzo (g,h,i) perylene	0.002 - 0.007	Arizona DEQ, 1988
Benzo (a) pyrene	0.001 - 0.300	Pitt et al., 1994
Benzoic acid	0.033 - 0.960	Arizona DEQ, 1988
Bis (2-chloroethyl) ether	0.204*	Pitt et al., 1994
Bis (2-chloroisopropyl) ether	0.217*	Pitt et al., 1994
Bis (2-ethylhexyl) phthalate	0.012 - 0.290	Schmidt, 1985
Butyl benzyl phthalate	0.128*	Pitt et al., 1994
Carbon tetrachloride	0 - 0.0001	Wilson et al., 1992
Chlordane	0.00001 - 0.010	USEPA, 1983
Chloroform	0.002 - 0.008	Wilson et al., 1992
2-Chlorophenol	0 - 0.0011	Wilson et al., 1992
Chrysene	0.0044 - 0.014	Wilson et al., 1992
4,4-DDD	0.000003 - 0.000151	Wilson et al., 1992
4,4-DDE	0.000004 - 0.000354	Wilson et al., 1992
4,4-DDT	0.000002 - 0.000179	Wilson et al., 1992
Diazinon	0.0007 - 0.002	Schmidt, 1985
Dibenzo (a,h) anthracene	0.0003 - 0.003	Arizona DEQ, 1988
Dibromochloromethane	0 - 0.0017	Wilson et al., 1992
1,3-Dichlorobenzene	0.12*	Pitt et al., 1994
1,1-Dichloroethane	0.0015 - 0.003	USEPA, 1983
1,1-Dichloroethene	0.0015 - 0.004	USEPA, 1983
1,2-Dichloroethane	0.004*	USEPA, 1983
Dichloromethane	0.0001 - 0.054	Wilson et al., 1992
2,4-Dichlorophenol	0.00019 - 0.0032	Wilson et al., 1992
1,2-Dichloropropane	0.003*	USEPA, 1983

**Table 4. Summary of Constituent Concentrations in Storm Water Runoff (cont'd)**

<b>Constituents</b>	<b>Range</b> (mg/l unless otherwise noted)	<b>Reference**</b>
1,3-Dichloropropene	0.001 - 0.002	USEPA, 1983
Dieldrin	0.000007 - 0.0001	USEPA, 1983
Diethyl phthalate	0.002 - 0.003	Arizona DEQ, 1988
2,4-Dimethyl phenol	0.014 - 0.020	Arizona DEQ, 1988
4,6-Dinitro 2-methylphenol	0 - 0.021	Wilson et al., 1992
Di-n-butyl phthalate	0.0046 - 0.011	USEPA, 1983
Di-n-octyl phthalate	0.002 - 0.005	Wilson et al., 1992
Dioxathion	0.0076*	Wilson et al., 1989
Endosulfan I	0.00001 - 0.0002	USEPA, 1983
Endosulfan II	0 - 0.0006	Wilson et al., 1992
Endosulfan sulfate	0 - 0.0001	Wilson et al., 1992
Endrin	0.000009 - 0.00001	Wilson et al., 1992
Ethylbenzene	0.001 - 0.002	USEPA, 1983
Fluoranthene	0.128*	Pitt et al., 1994
Heptachlor	0.000002 - 0.0001	Wilson et al., 1992
Heptachlor-epoxide	0.000004 - 0.00001	Wilson et al., 1992
Lindane	0.000005 - 0.00018	Wilson et al., 1992
Malathion	<0.0005 - 0.0019	City of Modesto, 1997
2-Methyl phenol	0.071 - 0.085	Arizona DEQ, 1988
4-Methyl phenol	0.021 - 0.029	Arizona DEQ, 1988
Methyl-tert-butyl-ether (MTBE)	0.0002 - 0.200	Squillace et al., 1996
Naphthalene	0.0001 - 0.296	Pitt et al., 1994
4-Nitrophenol	0.001 - 0.037	USEPA, 1983
Oil and grease	3 - 14	Woessner and Wogsland, 1987
Pentachlorophenol	0.001 - 0.115	USEPA, 1983
Petroleum hydrocarbons, Total	<0.50 - 1.70	City of Modesto, 1997
Phenanthrene	0.00008 - 0.069	Pitt et al., 1994
Phenol	0.001 - 0.013	USEPA, 1983
Pyrene	0.001 - 0.120	Pitt et al., 1994
1,1,2,2-Tetrachloroethane	0.002 - 0.003	USEPA, 1983
Tetrachloroethylene	0.001 - 0.043	USEPA, 1983
Tetrachloromethane	0.001 - 0.002	USEPA, 1983
Toluene	0.003 - 0.009	USEPA, 1983
Toxaphene	0 - 0.0004	Wilson et al., 1992
1,2-Trans-dichloroethene	0.001 - 0.003	USEPA, 1983
1,1,1-Trichloroethane	0.0002 - 0.003	Wilson et al., 1992

Constituents	Range (mg/l unless otherwise noted)	Reference**
1,1,2-Trichloroethane	0.002 - 0.003	USEPA, 1983
Trichloroethylene	0.0003 - 0.012	USEPA, 1983
Trichlorofluoromethane	0.0006 - 0.027	USEPA, 1983
Trichloromethane	0.0002 - 0.012	USEPA, 1983

\* Single values represent maximum detected concentration when range was not given.

\*\* Reference listed is that in which maximum concentration was reported.

Table 5 presents injectate concentrations reported for lake level control wells. This information is based on data from a total of 14 lake level control wells reported in three studies. One study presents results of sampling events that took place in 1978, the second study presents data from a lake level control well and associated monitoring wells sampled from 1987 to 1988. Table 5 is also based on data submitted by the Florida Department of Environmental Protection, which includes the results for two lake level control wells that were sampled in 1998.

**Table 5. Summary of Constituent Concentrations in Lake Level Control Well Injectate**

Constituents	Range (mg/l unless otherwise noted)	Reference**
TDS-Total dissolved solids	92 - 176	Kimrey and Fayard, 1984
TSS-Total suspended solids	1.0 - 3.5	Cadmus, 1999
Conductivity (micromhos/cm @25°)	140 - 173	Cadmus, 1999
pH (units)	6.16 - 9.1	Bradner, 1991
Color (Platinum-cobalt units)	5 - 20	Cadmus, 1999
Turbidity (nephelometric units)	0.9 - 1.6	Cadmus, 1999
Aluminum, Total recoverable	0.040 - 0.500	Kimrey and Fayard, 1984
Ammonia as Nitrogen	0.02 - 2.0	Kimrey and Fayard, 1984
Antimony	<0.0017*	Cadmus, 1999
Arsenic	0.001 - 0.027	Kimrey and Fayard, 1984
Barium	0.005*	Cadmus, 1999
Beryllium	<0.0003*	Cadmus, 1999
Cadmium	<0.0002 - 0.003	Kimrey and Fayard, 1984
Calcium	17.2 - 21	Bradner, 1991
Calcium Carbontate, as hardness	49.5 - 62	Bradner, 1991
Carbon, Total organic	4.7 - 9.2	Bradner, 1991
Chloride	2.8 - 26	Cadmus, 1999
Chromium	<0.001 - 0.020	Kimrey and Fayard, 1984
Copper	<0.002 - 0.012	Cadmus, 1999
Cyanide	<0.006*	Cadmus, 1999
Dissolved oxygen	0.24 - 5.15	Cadmus, 1999
Fluoride	0.10 - 0.20	Bradner, 1991
Iron	0.028 - 2.9	Kimrey and Fayard, 1984
Lead	<0.002 - 0.008	Kimrey and Fayard, 1984
Lead, Dissolved	<0.005*	Bradner, 1991
Magnesium	1.6 - 2.3	Bradner, 1991

**Table 5. Summary of Constituent Concentrations in Lake Level Control Well Injectate (cont'd)**

Constituents	Range (mg/l unless otherwise noted)	Reference**
Manganese	<0.010 - 0.080	Kimrey and Fayard, 1984
Mercury	<0.0005*	Kimrey and Fayard, 1984
Nickel	0.002 - 0.013	Kimrey and Fayard, 1984
Nitrate	0.01 - 2.4	Kimrey and Fayard, 1984
Nitrate & Nitrite	<0.01 - <0.10	Bradner, 1991
Nitrogen, Total	0.78 - 1.60	Bradner, 1991
Phosphorus, Total	0.036 - 0.10	Bradner, 1991
Potassium	1.8 - 2.1	Bradner, 1991
Selenium	<0.001 - 0.003	Kimrey and Fayard, 1984
Silver	<0.009*	Cadmus, 1999
Sodium	4.8 - 16.1	Cadmus, 1999
Strontium	0 - 0.100	Kimrey and Fayard, 1984
Sulfate	0.20 - 39	Kimrey and Fayard, 1984
Thallium	<0.0006*	Cadmus, 1999
Zinc, Recoverable	0.001 - 0.030	Bradner, 1991
Zinc, Dissolved	<0.010 - 0.010	Bradner, 1991
Total Coliform (colonies/ 100mL)	1 - 2,200	Kimrey and Fayard, 1984
2,4-D	0.00001*	Kimrey and Fayard, 1984
Dieldrin	0.00001*	Kimrey and Fayard, 1984
Methyl-tert-butyl-ether (MTBE)	0.002*	Cadmus, 1999
Pentachlorophenol	0.032*	Cadmus, 1999
2,4,5-T	0.0071*	Kimrey and Fayard, 1984

\* Single values represent maximum detected concentration when range was not given.

\*\* Reference listed is that in which maximum concentration was reported.

The following sections summarize the above sampling results for inorganic constituents, organic constituents, and biological/microorganism constituents.

#### 4.1.1 Inorganic Constituents

The most common inorganic constituents found in storm water injectate are sediment, nutrients, metals, and salts. These categories, and specific inorganic contaminants in each, are discussed below.

##### *Sediment*

The principal pollutant in storm water runoff (i.e., present in the largest amount) is typically suspended sediment. The amount of sediment found in storm water runoff is a function of how much exposed ground, construction activity, or soil disturbance is occurring in a specific area and is generally



reported as total suspended solids (TSS). Suspended sediments are composed mainly of relatively inert materials such as quartz and feldspar, but may pose a public health concern because of the adsorption of other pollutants to the sediments, including heavy metals, organic compounds, and microorganisms. Dissolved solids are the minerals, metals, and other compounds in solution in water and are usually reported as total dissolved solids (TDS). This measurement gives a general indication of water quality deterioration characteristics such as hardness, seawater intrusion, corrosive ability, and other mineral concentrations.

Particle size, density, size and pattern of fractures or voids in receiving geologic formations, and local ground water flow conditions are some of the factors affecting the mobility of dissolved and suspended solids in storm water runoff. Lighter, smaller sediments, and the pollutants that may be adsorbed to them, may be transported into ground water when introduced into fractured or porous formations.

The USEPA Nationwide Urban Runoff Program (NURP) study in Bellevue, WA reported a sediment concentration range in storm water runoff samples of 1 - 2,740 mg/l TSS. Samples taken from storm water runoff in the Tucson, AZ region were reported in the range of 25 - 8,058 mg/l TSS (Resnick and DeCook, 1983) while storm water samples from the Phoenix area were reported in the range of 99 - 588 mg/l (Schmidt, 1985). The Idaho Department of Water Resources (1985) collected ground water samples in Boise and Pocatello having TSS concentrations of 17 - 899 mg/l and 226 - 1,190 mg/l, respectively. Woessner and Wogsland (1987) reported TDS levels in storm water runoff from Missoula, MT to be 18 - 1,436 mg/l. The maximum detected levels of TDS in both storm water runoff and ground water samples exceed the secondary MCL of 500 mg/l. This secondary MCL is not health-based, but rather was established to represent a goal that would prevent most adverse taste effects. German (1989) reported MCL exceedances for color and turbidity. Color levels were as high as 100 platinum-cobalt units versus the secondary MCL of 15 platinum-cobalt units. Turbidity levels were as high as 25 NTU versus the MCL of 0.5 - 1.0 NTU.

Lake level control well water quality data for Lake Azalea and Lake Orienta show relatively few exceedances of MCLs and HALs. However, the Lake Orienta drainage well sample exceeded the secondary MCL for color (15 Pt/Co Units), and measurements for turbidity in the Lake Azalea samples exceeded the MCL of 0.5 - 1.0 NTU.

### *Nutrients*

Nutrients of primary interest found in urban storm water are the various forms of nitrogen and phosphorus.<sup>1</sup> Nutrients originate from many different sources including sanitary sewage, fertilizers for landscaping and lawn maintenance, septic tank and sewer system leakage, waste decomposition,

---

<sup>1</sup> Phosphorus is not toxic to humans or animals in the forms commonly found in water; therefore, its presence does not appear to be a significant health concern with regard to ground water contamination by storm water drainage wells. The primary concern with phosphorus in ground water is its discharge to surface water, where it may induce eutrophication and other undesirable changes to aquatic ecosystems.

highway runoff, agricultural practices, animal wastes, eroded soil, organic debris, and atmospheric fallout (Nussbaum, 1991). Prych and Ebbert concluded that one third of total nitrogen in storm water runoff is from rainfall (in Nussbaum, 1991). Nitrogen concentrations are typically reported as either total nitrogen or as nitrate-nitrite. Nitrates are one of the most frequently found contaminants in ground water (Pitt et al., 1994). When nitrogen compounds come in contact with soil, nitrate leaching into ground water is possible because of its high solubility. If nitrate leaves the root zone without being taken up by plants, it can readily percolate into ground water.

Studies by Schmidt (1985) and Resnick and DeCook (1983) detected nitrate concentrations in ground water of 20 - 22 mg/l and in storm water runoff of 0.1 - 43 mg/l respectively; which exceed the MCL of 10 mg/l. In the USEPA NURP study (1983) and in many of the studies mentioned above, nitrates were frequently detected in ground water and storm water samples; however, at levels below the MCL.

### *Metals and Salts*

The metals in storm water presenting the greatest potential for USDW contamination are aluminum, arsenic, cadmium, chromium, copper, iron, lead, mercury, nickel, and zinc (Pitt et al., 1994). These metals are a concern because of their high prevalence and potential toxicity. Many of these metals are associated with the particulate fraction of storm water and can be removed by sedimentation or filtration. However, metals can adsorb onto the surface of suspended sediments and travel through porous or fractured soils into ground water.

Lead, zinc, and copper are the metals found with the highest frequencies and concentrations in urban storm water. The NURP study (USEPA, 1983) analyzed 121 samples at 61 sites for 120 of USEPA's priority pollutants. Lead and zinc were detected in 94 percent of the samples taken, with lead concentrations ranging from 0.006 - 0.96 mg/l, which exceeded the 0.015 mg/l drinking water standard. Wilson et al. (1992) reported lead levels as high as 1.869 mg/l in storm water runoff. Lead concentrations have decreased significantly in urban area and highway storm water runoff due to its elimination as an antiknock additive in gasoline (Lee and Taylor, 1998). Concentrations of zinc were reported from 0.0018 - 4.39 mg/l, exhibiting the highest levels for detected metals and exceeding the HAL of 2 mg/l (Wilson et al., 1992). Copper, detected in 91 percent of the samples taken, was found in concentrations ranging from 0.001 - 0.100 mg/l, with 40 percent of the total copper in soluble form (USEPA, 1983). Pitt et al. (1994) reported copper concentrations as high as 1.25 mg/l, exceeding the secondary MCL of 1 mg/l.

Other metal contaminants frequently detected in the NURP storm water samples included chromium (58 percent), arsenic (52 percent), cadmium (48 percent), and nickel (43 percent) (USEPA, 1983). German (1989) reported chromium levels in the range of 0.0006 - 0.610 mg/l, exceeding the primary drinking water standard of 0.10 mg/l. Levels of cadmium were detected in the range of 0.0001 - 0.220 mg/l, exceeding the primary drinking water standard of 0.005 mg/l (Wilson et al., 1992). Arsenic concentrations frequently exceeded USEPA human carcinogenic HAL ( $10^{-4}$  risk level) of 0.002 mg/l (USEPA, 1983). Nussbaum (1991) reported arsenic concentrations up to 0.0505 mg/l,

exceeding the 0.05 mg/l MCL and the 0.002 mg/l HAL. In the NURP study, selenium concentrations in storm water runoff ranged from 0.002 - 0.077 mg/l, exceeding the 0.05 mg/l drinking water standard in 10 percent of the samples in which it was detected. Shiner and German (1983) reported aluminum concentrations as high as 0.39 mg/l, exceeding the secondary MCL of 0.05 - 0.20 mg/l. Antimony was detected above the primary MCL of 0.006 mg/l at a concentration of 0.05 mg/l by Wilson et al. (1992). Nussbaum (1991) reported beryllium levels of 0.049 mg/l, which exceeded the primary MCL of 0.004 mg/l. The NURP study (USEPA, 1983) reported concentrations of cyanides in the range of 0.002 - 0.300 mg/l, exceeding the primary MCL of 0.200 mg/l. The secondary MCL for iron (0.30 mg/l) was exceeded by concentrations as high as 27.3 mg/l (Marsh, 1993). Wilson et al. (1992) found mercury levels of up to 0.0023 mg/l (exceeding the primary MCL of 0.002 mg/l) and nickel levels of up to 0.900 mg/l (exceeding the primary MCL of 0.100 mg/l).

Water quality analyses of samples taken from the Lake Azalea drainage (lake level control) well indicate that several metals were present but did not violate any HAL or MCL (see Table 5). Only one sample exceeded the secondary MCL of 0.3 mg/l for iron.

Excess salt concentrations including calcium, carbonate, chloride, magnesium, manganese, sodium, and sulfate are often found in storm water runoff. Final health-based (primary) MCLs are not available for many of these chemicals; however, manganese has a secondary drinking water standard of 0.05 mg/l. Chloride also has a secondary MCL of 250 mg/l to prevent negative taste effects. Manganese concentrations in storm water runoff range from 0.005 - 0.91 mg/l in Louisville, Kentucky and Missoula, Montana (Marsh, 1993; Woessner and Wogsland, 1987). Chloride concentrations in samples from storm water runoff collected in Missoula, MT ranged from 1.13 - 819.13 mg/l (Woessner and Wogsland, 1987). Shaw and Berndt (1990) reported chloride concentrations up to 3,550 mg/l. Resnick and DeCook (1983) reported pH levels in storm water runoff as high as 9.9 and as low as 3.4, exceeding the secondary MCL of 6.5 - 8.5. Table 6 presents a comparison of the range of inorganics detected in storm water runoff at concentrations exceeding water quality standards.

**Table 6. Summary of Inorganic Storm Water Contaminants Detected in Excess of Water Quality Standards**

Contaminants	Range of Concentrations	Reference Level	Water Quality Standard <sup>a</sup>	Reference
Aluminum	0.01 - 0.39 mg/l	0.05 - 0.20 mg/l	MCL (S)	Shiner and German, 1983
Antimony	0.0026 - 0.050 mg/l	0.006 mg/l	MCL	Wilson et al., 1992
Arsenic	0.001 - 0.0505 mg/l	0.050 mg/l/0.002 mg/l	MCL\HAL	Nussbaum, 1991
Beryllium	0.001 - 0.049 mg/l	0.004 mg/l	MCL	Nussbaum, 1991
Cadmium	0.0001 - 0.220 mg/l	0.005 mg/l	MCL	Wilson et al., 1992
Chloride	1 - 3,550 mg/l	250 mg/l	MCL (S)	Shaw and Berndt, 1990
Chromium	0.0006 - 0.610 mg/l	0.1 mg/l	MCL	German, 1989
Color	2 - 100 Pt/Co units	15 Pt/Co units	MCL (S)	German, 1989

**Table 6. Summary of Inorganic Storm Water Contaminants Detected in Excess of Water Quality Standards (cont'd)**

Contaminants	Range of Concentrations	Reference Level	Water Quality Standard <sup>a</sup>	Reference
Copper	0.002 - 1.25 mg/l	1 mg/l	MCL (S)	Pitt et al., 1994
Cyanides	0.002 - 0.300 mg/l	0.200 mg/l	MCL	USEPA, 1983
Iron	0.07 - 27.3 mg/l	0.3 mg/l	MCL (S)	Marsh, 1993
Lead	0.0001 - 1.869 mg/l	0.015 mg/l	MCL	Wilson et al., 1992
Manganese	0.005 - 0.910 mg/l	0.05 mg/l	MCL (S)	Marsh, 1993
Mercury	0.0006 - 0.0023 mg/l	0.002 mg/l	MCL	Wilson et al., 1992
Nickel	0.001 - 0.900 mg/l	0.1 mg/l	MCL	Wilson et al., 1992
Nitrate	0.1 - 43 mg/l	10 mg/l	MCL	Resnick and DeCook, 1983
pH	3.4 - 9.9	6.5 - 8.5	MCL (S)	Resnick and DeCook, 1983
Selenium	0.002 - 0.077 mg/l	0.05 mg/l	MCL	USEPA, 1983
Total Dissolved Solids	18 - 1,436 mg/l	500 mg/l	MCL (S)	Woessner and Wogsland, 1987
Turbidity	2.5 - 25 NTU	0.5 - 1.0 NTU	MCL	German, 1989
Zinc	0.0018 - 4.39 mg/l	2 mg/l	HAL	Wilson et al., 1992

<sup>a</sup> (S) denotes a secondary MCL. All other MCLs are primary.

#### 4.1.2 Organic Constituents

Dissolved oxygen in water is commonly used to characterize a receiving water's ability to sustain aquatic life. The amount of dissolved oxygen in water generally decreases as oxygen consuming pollutants, temperature, and salinity increase. Oxygen demanding or consuming pollutants are organic materials that are measured using biological oxygen demand (BOD) and chemical oxygen demand (COD) analytic techniques. These organic materials include human and animal feces, oil and grease, and pesticides. The ranges of BOD reported in the 1983 NURP study were comparable to concentrations found in secondary wastewater discharge, ranging from 2 - 23 mg/l. Campbell (1985) reported BOD levels as high as 1,425 mg/l. The City of Orlando reported BOD ranges from 14.6 - 23.0 mg/l (City of Orlando, 1994). COD levels ranged from 8 - 13,800 mg/l in a study by Resnick and DeCook (1983).

Pesticides found in urban storm water runoff and ground water include 2, 4-D; 2, 4, 5-T, alachlor, aldrin, atrazine, chlordane, DDE, diazinon, dieldrin, ethion, endosulfan, endrin, malathion, methyl trithion, silvex, and simazine, and generally result from municipal and residential use for pest control, weed control, and fungi control (Pitt et al., 1994). While many of these pesticides are found at levels well below drinking water standards, the NURP (1983) study reported concentrations of chlordane in the range of 0.00001 - 0.010 mg/l, exceeding the MCL of 0.002 mg/l.

Between 1991 and 1995, the U.S. Geological Survey (USGS) collected a total of 592 samples of storm water from 16 cities and metropolitan areas required to obtain NPDES permits to discharge storm water from their municipal storm sewer system into surface water (Delzer et al., 1996). Although these data represent storm water that were not injected, they can be used to characterize storm water quality prior to injection. These data indicated that a total of 62 volatile organic compounds (VOCs) were detected at concentrations below primary and secondary MCLs. Other studies reported the following organic concentrations above MCLs (see Table 7 for specific references): benzene (0.013 mg/l versus MCL of 0.005 mg/l); benzo(a)pyrene (0.300 mg/l versus MCL of 0.0002 mg/l); bis(2-ethylhexyl) phthalate (0.290 mg/l versus MCL of 0.006 mg/l); dichloromethane (0.054 mg/l versus MCL of 0.005 mg/l); methyl tert-butyl ether (MTBE) (0.200 mg/l versus HAL of 0.020 mg/l); pentachlorophenol (0.115 mg/l versus MCL of 0.001 mg/l); tetrachloroethylene (0.043 mg/l versus MCL of 0.005 mg/l); and trichloroethylene (0.012 mg/l versus MCL of 0.005 mg/l).

Between 1993 and 1994, the USGS analyzed ground water samples collected from 210 shallow urban wells and springs, 549 shallow agricultural wells, and 412 deep wells as part of their National Water Quality Assessment program (Squillace et al., 1996). The research focused on the presence of MTBE in ground water. Of the 210 shallow urban land use wells and springs sampled, 73 percent had concentrations less than the method detection level of 0.0002 mg/l, 24 percent had MTBE concentrations ranging from 0.0002 to 0.020 mg/l, and three percent had concentrations exceeding 0.020 mg/l. USEPA set a health advisory level for MTBE at 0.020 mg/l. The USGS data indicate that MTBE contamination occurs from point and nonpoint sources of pollution. Although they do not describe MTBE contamination as directly attributable to storm water injection, they mention storm water injection wells as a probable source of contamination.

Lake level control well injectate was also sampled for numerous pesticides and organics, few of which were reported above detection limits. Pentachlorophenol was detected in the Lake Orienta drainage well in Altamonte Springs, Florida at a concentration of 0.0032 mg/l, which exceeded the primary MCL of 0.001 mg/l (Cadmus, 1999). Table 7 presents a summary of organic constituents detected in storm water runoff and lake level control wells at concentrations greater than water quality standards.

**Table 7. Summary of Organic Storm Water Contaminants Detected in Excess of Water Quality Standards**

Contaminants	Range of Concentrations	Reference Level	Water Quality Standard	Reference
Benzene	0.0001 - 0.013 mg/l	0.005 mg/l	MCL	USEPA, 1983
Benzo(a)pyrene	0.001 - 0.300 mg/l	0.0002 mg/l	MCL	Pitt et al., 1994
Bis(2-ethylhexyl) Phthalate	0.012 - 0.290 mg/l	0.006 mg/l	MCL	Schmidt, 1985
Chlordane	0.00001 - 0.010 mg/l	0.002 mg/l	MCL	USEPA, 1983
Dichloromethane	0.0001 - 0.054 mg/l	0.005 mg/l	MCL	Wilson et al., 1992

Contaminants	Range of Concentrations	Reference Level	Water Quality Standard	Reference
Methyl-tert-butyl-ether	0.0002 - 0.200 mg/l	0.020 mg/l	HAL	Squillace et al., 1996
Pentachlorophenol	0.001 - 0.115 mg/l	0.001 mg/l	MCL	USEPA, 1983
Tetrachloroethylene	0.001 - 0.043 mg/l	0.005 mg/l	MCL	USEPA, 1983
Trichloroethylene	0.0003 - 0.012 mg/l	0.005 mg/l	MCL	USEPA, 1983

#### 4.1.3 Biological/Microorganism Constituents

While suspended sediment is the principal pollutant in storm water runoff, fecal coliforms and fecal streptococci have been found at levels greatly exceeding the MCLs. The primary source of bacteria and viruses in urban storm water is pet animal and bird excrement washed off of paved surfaces and yards. Studies comparing urban runoff from different land uses on Long Island, New York, indicate that low-density residential and nonresidential areas contributed the fewest bacteria to storm water runoff, while medium-density residential and commercial areas contributed the most. Coliform counts in urban runoff during warmer periods of the year are approximately 20 times greater than counts in urban runoff during colder periods. Viruses were detected in ground water on Long Island at sites where storm water recharge basins were located less than 35 feet above the aquifer. At other locations, viruses may be removed from percolation water by adsorption and/or inactivation. Bacteria and viruses can remain suspended in water or can adsorb onto sediment which can increase their survival rates. Bacteria and viruses have also been known to migrate through ground water (USEPA, 1983).

Fecal coliform levels in urban storm water runoff routinely exceed drinking water standards by a factor of 50 to 75 (Schueler, 1999). The ranges of fecal coliform found in undiluted storm water in the 1983 Resnick and DeCook study were as high as 20,000,000 colonies/100 ml while fecal streptococci samples were reported as high as 78,000 colonies/100 ml. Pitt (1998) reported a mean fecal coliform concentration in storm water runoff of about 20,000 colonies/100 ml based on 1,600 storm runoff samples collected primarily during the NURP study in the early 1980's. The City of Orlando (1994) reported total coliform levels ranging from 100 - 290,000 colonies /100 ml. The lake level control wells samples from Lake Azalea also indicate the presence of fecal coliforms (see Table 5). The primary drinking water standard for total coliform is a monthly average of 1 colony/100 ml, with individual measurements permitted to exceed this standard; however, no fecal coliform may be present in any sample.

## 4.2 Well Characteristics

Although storm water drainage wells are constructed using a wide variety of siting and design characteristics, they generally fall into three basic categories:

- dug wells
- bored wells
- improved sinkholes

#### 4.2.1 Dug Wells

In many states, the use of dug wells (also called dry wells) is preferable to other types of storm water drainage wells because injected waters are typically filtered by vadose zone soil before reaching ground water, provided they are constructed above the seasonally high ground water table. Thus, the concentration of the contaminants in the effluent that eventually reaches the ground water is reduced (actual reduction depends on the physical and chemical characteristics of the specific contaminants) as the storm water moves through the soil. While infiltration trenches are often categorized with dug wells, they are not Class V wells if their surface dimension is larger than their depth.

##### *Dry Wells*

A dry well is usually dug to a depth above the water table so that its bottom and sides are typically dry except when receiving fluids. Dry wells are constructed by excavating a hole and then building a chamber either by stacking concrete culvert pipe sections on top of each other or by stacking curved concrete blocks. Variations on this general design include placing drainage nets on the bottom of the holes before installing the blocks, constructing a dry well and filling the chamber with gravel, or simply digging a hole and backfilling it with gravel. Figure 1 presents a schematic of a dry well constructed with curved blocks. As shown in Figure 1, this well has no catch basin and receives storm water through a slotted manhole cover.

Dry wells may also be constructed with catch basins, which receive and collect storm water prior to entering the well (see Figure 2). The advantage of including a catch basin upstream of the well is that it allows solids to settle in the catch basin, minimizing the subsequent transport of solids into the well and underlying ground water. However, because many pollutants, such as metals, attach to

**Figure 1. Dry Well**  
(USEPA, 1998c)

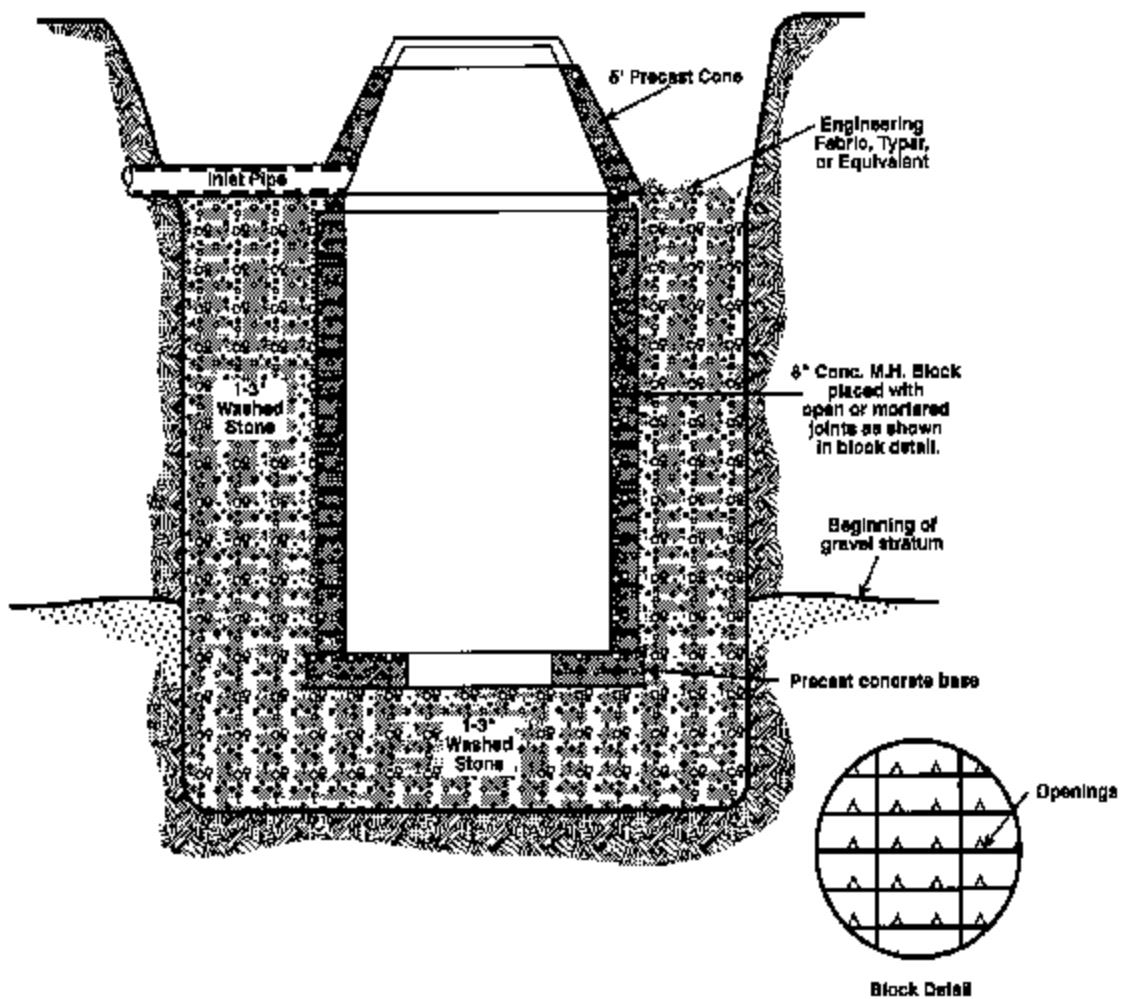

sediments, the catch basin can also retain a variety of pollutants (i.e., by holding settled solids). It is also possible to prevent small spills of floating oil or petroleum if the outlet structure of the catch basin is properly designed. The overall effectiveness of the catch basin to trap and retain various pollutants is dependent on the frequency of inspections and maintenance of the catch basin. Figures 3 and 4 show



storm water drainage wells in USEPA Region 5. As shown in Figure 4, storm water drainage wells can be subject to intentional misuse.

Figure 2. Dry Well with Catch Basin  
(USEPA, 1998c)

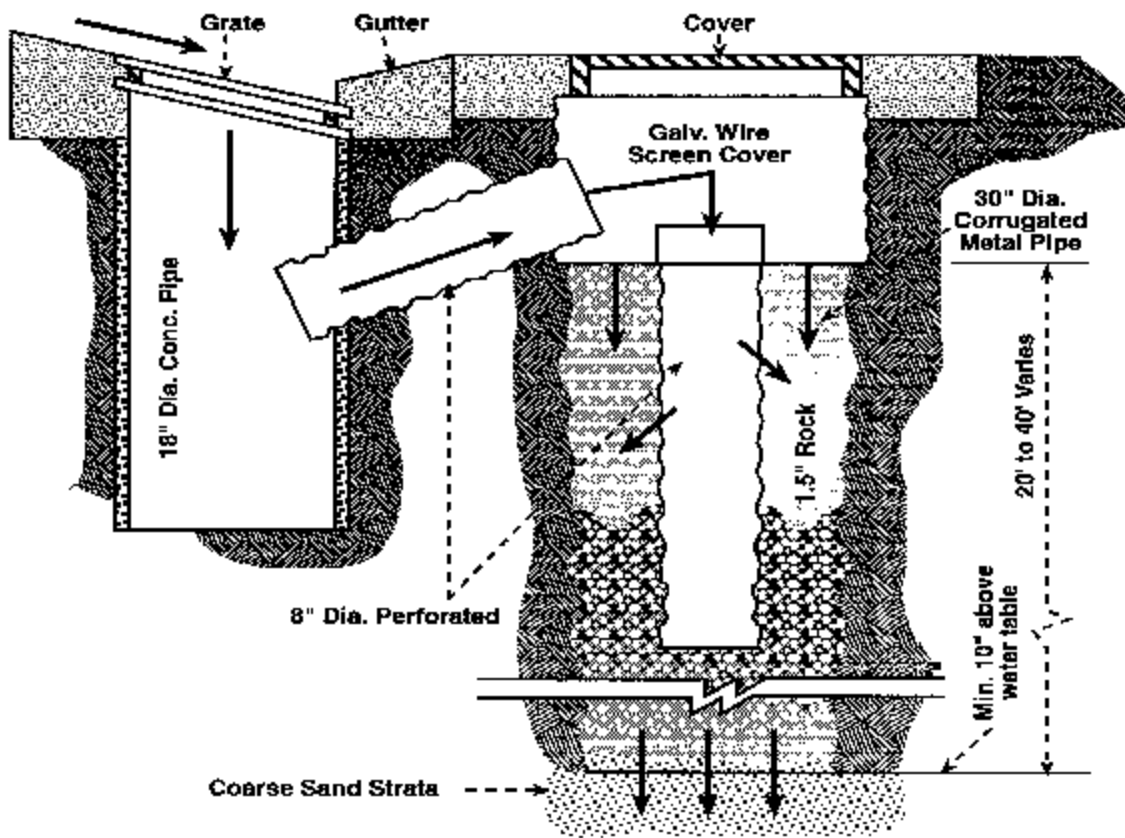

**Figure 4. Storm Water Drainage Well in USEPA Region 5 (USEPA, 1999d)**



**Figure 5. Storm Water Drainage Well in USEPA Region 5 (USEPA, 1999d)**



## Underground Drainfield

Another typical configuration of dug wells is the underground drainfield type of storm water drainage well. This is a very common grouping of designs that are often referred to as french drains, infiltration galleries, leach fields, or percolation areas. Underground drainfield type wells consist of a vertical drainage shaft that is attached to a series of lateral lines of perforated pipe, similar to the typical leach field configuration found in many septic systems.

## Infiltration Trenches

Infiltration trenches are shallow excavated trenches backfilled with gravel to create an underground reservoir (see Figure 5). Most infiltration trenches are wider at their largest surface dimension than they are deep, **and thus are not classified as Class V injection wells**. They are discussed here simply for completeness. Variations in infiltration trench design may include vertical fluid distribution pipes placed in the bottom of the trench (so called “infiltration galleries”). Because these vertical pipes meet the criterion of being deeper than they are wide, an infiltration trench with this configuration **would** be classified as a Class V injection well.

Storm water runoff diverted into the infiltration trench gradually seeps from the bottom of the trench into the subsoil and eventually into the water table. Enhanced trenches typically have pretreatment systems, such as grassed buffers, oil/grit separators, and inlet filters, to remove sediment and oil. This type of design generally has high removal rates for sediments, trace metals, and organic material.

**Figure 5. Infiltration Trench**  
(USEPA, 1998c)

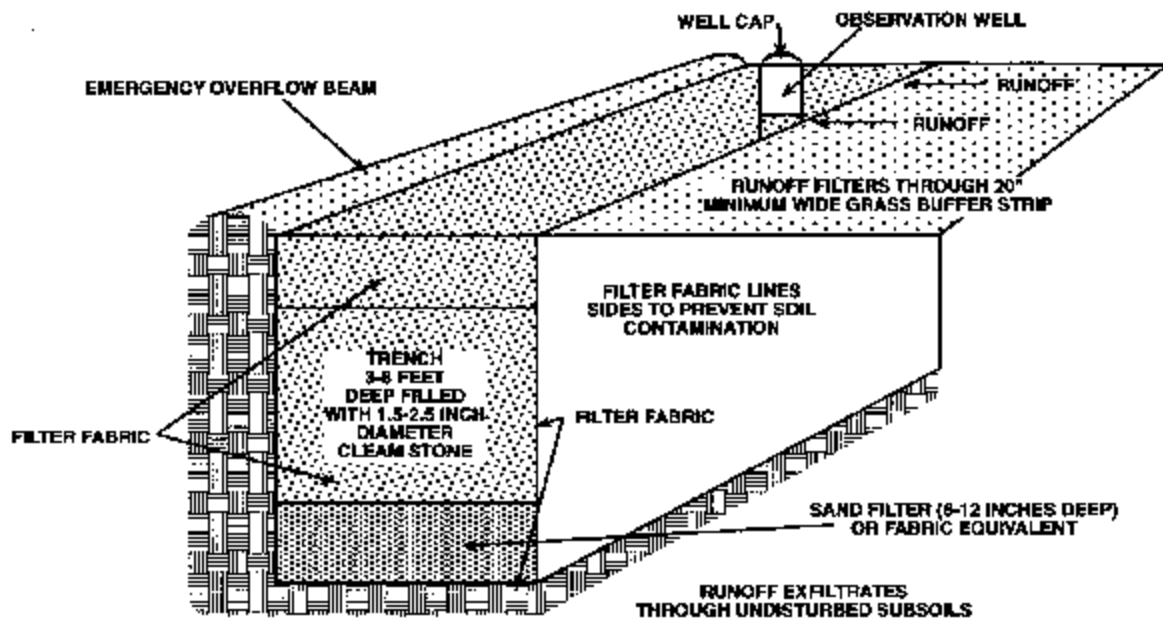

#### 4.2.2 Bored Wells

A basic bored well is typically at least 40 feet deep and is drilled into consolidated strata such as limestone or sandstone (USEPA, 1998c). As shown in Figure 6, storm water may pass through a screen (that filters the injectate), through the well casing, and then seep into underlying aquifers (which often are in either limestone or sandstone formations). Thus, the basic bored well does not provide any opportunity for treatment of the storm water, beyond that which may occur if the storm water passes through the vadose zone and enters the aquifer (e.g., adsorption or filtration by soil). In cases where the well injects storm water directly into the water table, significant potential for contamination of the aquifer exists. As a result, states such as Arizona allow the use of bored wells only when operated with pollution management measures like a catch basin-type settling chamber and inflow pipes outfitted with debris shields and petroleum absorbents (see Figure 7).

**Figure 6. Bored Well  
(USEPA, 1987)**

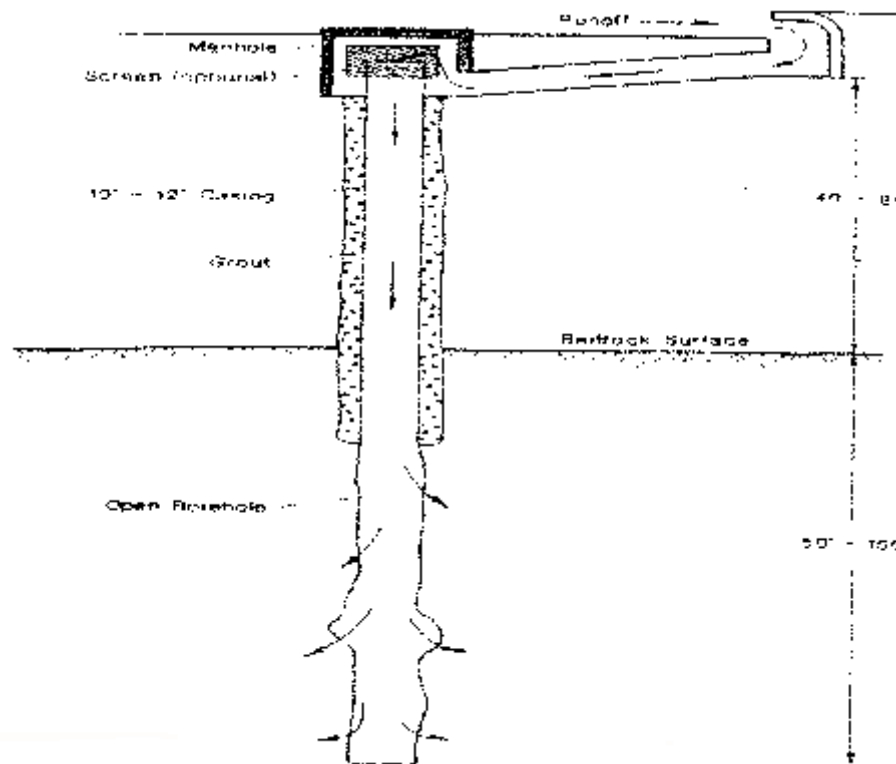
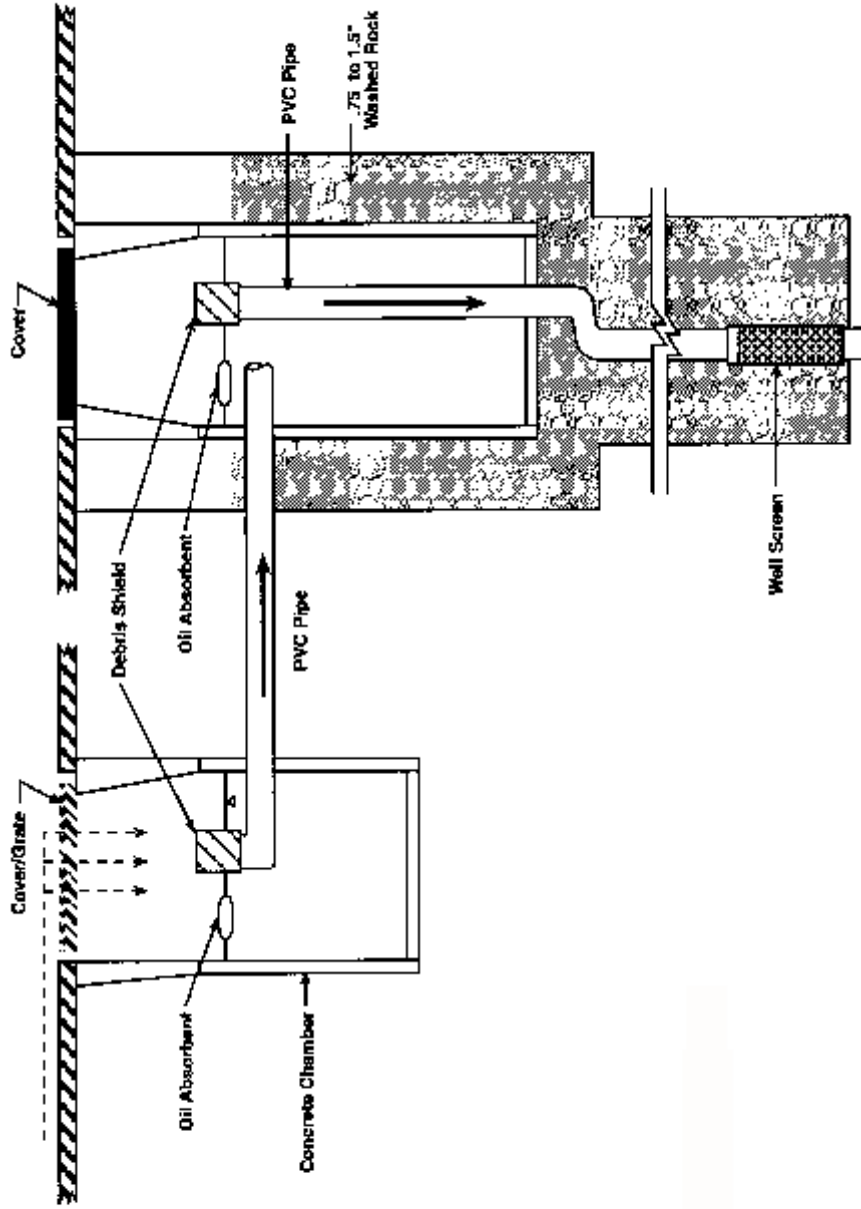

Figure 7. Bored Well with Settling Chamber  
(USEPA, 1998c)



### 4.2.3 Lake Level Control Wells

The typical construction of lake level control wells in Florida is shown in Figure 8. Well casing is placed through the top layer of sediment and the casing is seated in the shallowest zone at the top of the receiving aquifer. Then, an open hole is drilled in the receiving formation until enough permeable zones, usually limestone cavities, have been encountered. It is important that a sufficient number of permeable zones are present to accept the volume of injected water (Kimrey and Fayard, 1984). In Florida, the receiving aquifer is usually the Floridan aquifer, which is also the largest source of drinking water for the state.

**Figure 8. Typical Construction of a Lake Level Control Well in Florida (Kimrey and Fayard, 1984)**

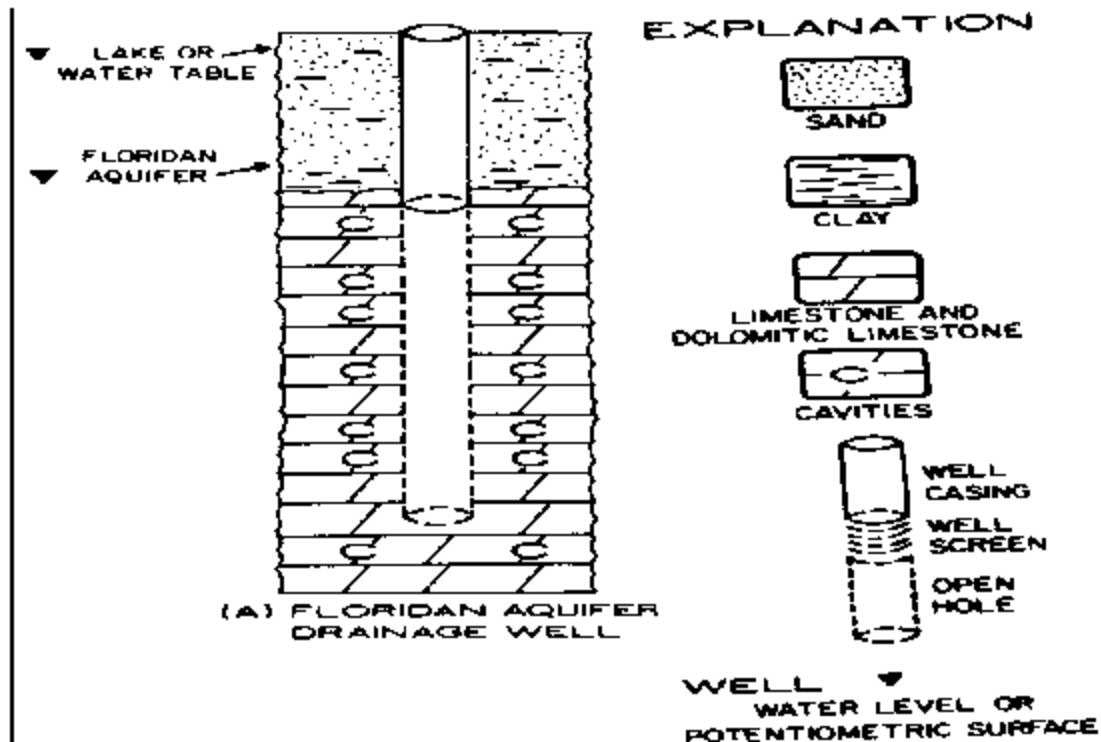

State officials describe lake level control wells as being similar in design to storm water drainage wells. The wells are typically owned and operated by municipalities. Most lake level control wells have diameters of 12 inches or more and about 200 to 400 feet of open hole in the receiving aquifer. Injectate inflow is usually controlled by stop-log weirs (notched barriers which prevent large solids such as tree and tree branches from entering the intake pipe), the intake pipe invert elevation, or the elevation at the top of the casing.

Figure 9 displays the typical configuration of a lake level control well in Orange County, Florida. Lake water enters the manhole junction box, then discharges into the drainwell pipe. The grate at the top of the drainwell pipe (often times resembling a “bird cage”) prevents trash from entering the pipe. These drainwells are connected directly to underground aquifers, increasing the threat of aquifer contamination if the injectate is polluted. Although closing these wells would eliminate this threat, this option is not always feasible given that these wells are the only source of drainage in some areas (Orange County SWMD, 1992).

**Figure 9. Lake Level Control Well Sketch  
Orange County, Florida (Orange County SWMD, 1992)**

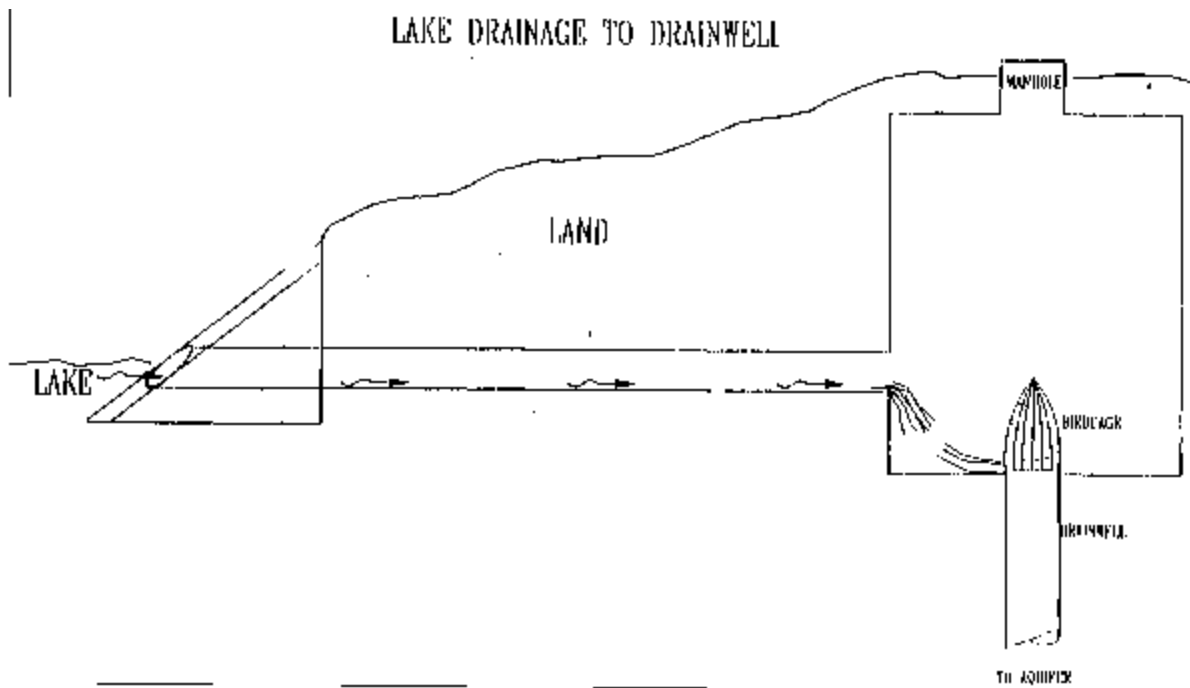

#### 4.2.4 Improved Sinkholes

Improved sinkholes are natural karst depressions that have been altered to enhance the drainage of fluids (see Figure 10), and if they accept storm water runoff, they are classified as Class V storm water drainage wells. Sinkholes typically form in areas underlain by limestone or dolomite, or in areas containing volcanic rock. This type of well can usually accept large volumes of water and is a

popular and cost-effective drainage method in many regions. For example, in Tennessee, highway runoff is diverted into natural cave openings occurring in karst formations. Similar to bored wells, improved sinkholes provide little opportunity for removal of contaminants from injectate prior to it reaching USDWs.

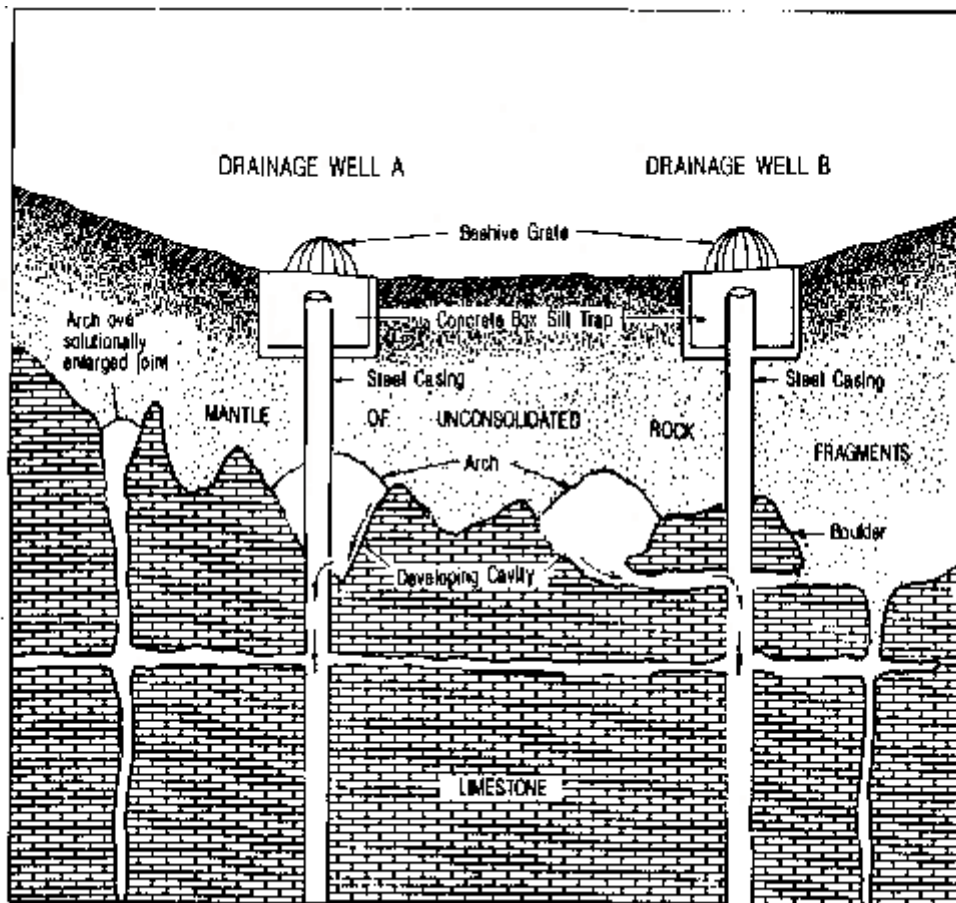

**Figure 10. Improved Sinkhole  
(USEPA, 1987)**

### **4.3 Operational Issues and Concerns**

#### **4.3.1 The Impacts of Siting and Land Use on Injectate**

The effect of siting on storm water constituents has been studied extensively with varied conclusions. A national USEPA-sponsored study of runoff entering conventional sewer collection



systems showed that heavy metals were the most prevalent pollutants found in urban runoff. Organic pollutants were detected less frequently and at lower concentrations than heavy metals (USEPA, 1983). The study concluded, however, that geographic location, land use category, or other factors appear to be of little utility in consistently explaining overall site-to-site variability of runoff pollutants; but rather that high storm event-to-storm event variability eclipsed any site-to-site variability (USEPA, 1983).

A second study showed that while petroleum contamination will vary from site-to-site, some land use related patterns are apparent. Specifically, Schueler (No date) noted higher levels of total hydrocarbons in the water and sediment trapped in separators at gas stations and all day parking areas relative to street and residential areas (see Tables 8 and 9).

In a third study conducted in 1996, Pitt et al. identified urban “hot spots,” which they argued produced significantly greater loadings of trace metals in urban runoff than other areas. Hot spots include industrial sites, scrap yards, boat building and repair sites, gas stations, and convenience store parking lots. The Arizona Department of Water Resources found that injectate quality is generally lower at wells located in industrial land use areas (Arizona Department of Water Resources, 1993). Spills, rather than chronic runoff, may pose a more significant risk to ground water because spills deliver a higher concentration of pollutants to storm water wells. In particular, areas with large numbers of gasoline stations are at high risk for petroleum spills (Brown and Caldwell Consulting Engineers, 1986).

**Table 8. Characterization of the Quality of Trapped Sediments in Oil/Grit Separators - Effect of Land Use**

Parameter	All-Day Parking	Convenience Commercial	Gas Stations	Streets	Townhouse-Garden Apts.
N =	8	6	7	6	6
Total Kjeldahl Nitrogen (mg/kg)	1,951.0	5,528.0	3,102.0	1,719.0	1,760.0
Total Phosphorus (mg/kg)	466.0	1,020.0	1,056.0	365.0	266.7
Total Organic Carbon (mg/kg)	37,915.0	55,617.0	98,071.0	33,025.0	32,392.0
Total Hydrocarbons (mg/kg)	7,114.0	7,003.0	18,155.0	3,482.0	894.0
Cadmium (mg/kg)	13.2	17.1	35.6	13.6	13.5
Chromium (mg/kg)	258.0	233.0	350.0	291.0	323.0
Copper (mg/kg)	186.0	326.0	788.0	173.0	162.0
Lead (mg/kg)	309.0	677.0	1,183.0	544.0	180.0
Zinc (mg/kg)	1,580.0	4,025.0	6,785.0	1,800.0	878.0

Source: Schueler, no date.

Note: All reported data are mean values.

**Table 9. Characterization of Pollutant Concentrations in the Water Column of Oil/Grit Separators - Effect of Land Use**

Parameter	All-Day Parking	Convenience Commercial	Gas Stations	Streets	Townhouse-Garden Apts.
N =	8	6	7	6	6
Ortho Phosphate Phosphorus (mg/l)	0.23	0.16	0.11	not detected	0.11
Total Phosphorus (mg/l)	0.30	0.50	0.53	0.06	0.19
Ammonia Nitrogen (mg/l)	0.20	1.58	0.11	0.19	0.20
Total Kjeldahl Nitrogen (mg/l)	1.18	4.94	2.5	.84	1.00
Oxidized Nitrogen (mg/l)	0.65	0.01	0.21	0.92	0.17
Total Organic Carbon (mg/l)	20.60	26.80	95.51	9.91	15.75
Total Hydrocarbons (mg/l)	15.40	10.93	21.97	2.86	2.38
Total Suspended Solids (mg/l)	4.74	5.70	no data	9.60	7.07
Extractable Cadmium (mg/l)	0.00645	0.00792*	0.01529*	no data	no data
Soluble Cadmium (mg/l)	0.0034*	no data	0.00634*	no data	0.01034*
Extractable Chromium (mg/l)	0.00537	0.01385	0.01763*	0.00552*	no data
Soluble Chromium (mg/l)	no data	no data	0.0064*	no data	0.00479*
Extractable Copper (mg/l)	0.01161	0.02211	0.11263	0.0095*	0.00362
Soluble Copper (mg/l)	0.00822*	no data	0.02564	no data	0.0024
Extractable Lead (mg/l)	0.01342	0.02887	0.16238	0.00823	no data
Soluble Lead (mg/l)	0.0081*	no data	0.0269*	no data	no data
Extractable Zinc (mg/l)	0.190	0.201	0.554	0.092	no data
Soluble Zinc (mg/l)	0.1067	0.0437	0.471	0.069	0.059

Source: Schueler, no date.

Note: All reported data are mean values. Asterisks indicate that the mean is for observations in which the indicated parameter was actually detected.

A fourth study prepared by Woodward-Clyde Consultants (1989) shows that land use has a statistically significant impact on the pollutant discharge in storm runoff. The authors ranked land use categories (industrial, commercial, transportation, residential, and open land) according to the pollutant concentrations found in storm drains in those areas. They then performed statistical analyses on the results to determine whether the concentration of pollutants found in one land-use category was statistically different from the concentration of pollutants found in another category. In-pipe industrial stations had the highest pollutant concentrations. Commercial and transportation land uses had pollutant concentrations that were statistically similar to each other, except in total suspended solids (TSS) and zinc. Both TSS and zinc were present in lower concentrations in commercial land use areas than in transportation land use areas. Residential land showed lower pollutant concentrations than the

in-pipe industrial, commercial, and transportation land use areas. Concentrations from residential land were not statistically different from concentrations found in open land, except for TSS and dissolved copper.

For the purpose of this study, storm water drainage wells are defined as wells that receive primarily storm water. However, some storm water wells that are designed to receive only storm water are located in industrial settings where spills can enter the well or where storm water can pick up contaminants as it flows over a polluted ground surface. This study defines storm water drainage wells in which the incoming storm water is not separated from potential pollutant sources, such as loading docks and process areas, as industrial waste disposal wells rather than storm water wells, even if they were originally designed to receive only non-industrial storm water.

Despite this attempt to differentiate between industrial wells and storm water drainage wells, there continues to be concern with both the potential for spilled materials to mix with storm water and enter a storm water drainage well and with the potential for “clean” storm water to be contaminated as it flows on the ground to the storm water well. Any future UIC rulemaking or guidance development activities addressing storm water drainage wells, if determined to be necessary, will attempt to address the dividing line between these two well types more specifically.

## **5. POTENTIAL AND DOCUMENTED DAMAGE TO USDWS**

Certain storm water pollutants may pose only minimal risks of ground water contamination depending on the type of drainage well used and the characteristics and concentrations of the contaminants in the injectate. According to the 1987 Class V RTC, the majority of storm water drainage wells have been reported to inject surface runoff above USDWs (USEPA, 1987). Storm water drainage wells that inject directly into USDWs are judged to have the highest relative potential to contaminate a USDW because suspended materials in the runoff have no opportunity to be filtered by subsurface sediments or removal through sedimentation before reaching ground water.

### **5.1 Injectate Constituent Properties**

The primary constituent properties of concern when assessing the potential for Class V storm water drainage wells to adversely affect USDWs are toxicity, persistence, and mobility. The toxicity of a constituent is the potential of that contaminant to cause adverse health effects if consumed by humans. Appendix D of the Class V Study provides information on the health effects associated with contaminants found above drinking water standards or health advisory limits in the injectate of storm water drainage wells and other Class V wells. As discussed in Section 4.1, the contaminants that have been observed above drinking water standards or health advisory limits in storm water drainage well injectate are aluminum, antimony, arsenic, beryllium, cadmium, chloride, chromium, color, copper, cyanide, iron, lead, manganese, mercury, nickel, nitrate, pH, selenium, TDS, turbidity, zinc, benzene, benzo(a)pyrene, bis(2-ethylhexyl) phthalate, chlordane, dichloromethane, fecal coliforms, methyl-tert-butyl-ether, pentachlorophenol, tetrachloroethylene, and trichloroethylene.

Persistence is the ability of a chemical to remain unchanged in composition, chemical state, and physical state over time. Appendix E of the Class V Study presents published half-lives of common constituents in fluids released in storm water drainage wells and other Class V wells. All of the values reported in Appendix E are for ground water. Caution is advised in interpreting these values because ambient conditions have a significant impact on the persistence of both inorganic and organic compounds. Appendix E also provides a discussion of mobility of certain constituents found in the injectate of storm water drainage wells and other Class V wells.

University of Arizona researchers analyzed the fate and transport potential of identified pollutants in storm water drainage well injectate (Wilson et al., 1992). Using a computer model, they established a ranking matrix relating runoff chemicals, their properties, the properties of representative vadose zone layers, depth to ground water, and recommended depths of dry wells. Using the interactive model Chemical Modeling in Layered Soils (CMLS), their simulations demonstrated that organic rich layers in the dry well sediments and in the vadose zone retarded the movement of all but the most mobile organic compounds. CMLS predicted that the travel distances of metals are minimal. Wilson et al. (1992) discussed an unpublished master's thesis that simulated drainage from a dry well using the saturated-unsaturated flow model UNSAY 2. Results indicate that greater attenuation and dilution can be expected when dry wells drain into fine-textured materials.

## **5.2 Observed Impacts**

Three distinct types of contamination incidents associated with storm water drainage wells are described in the literature. The first type occurs when residents or commercial businesses intentionally misuse the storm water wells. The second type of contamination incident occurs when industries unintentionally misuse storm water drains and the wells become contaminated. The final type involves the contamination of storm water wells located at or near industrial sites; these wells are contaminated because of the nature of the runoff (Michael, 1997). Studies show that the most serious risks to public health occur when contaminants from industrial sites or spills run into storm water drainage wells.

This section summarizes known contamination incidents involving storm water drainage wells and lake level control wells, and other studies on ground water impacts associated with these wells.

### **5.2.1 Storm Water Drainage Well Contamination Incidents**

Contamination of USDWs by storm water drainage wells has been reported to varying degrees at locations in Ohio, Kansas, Wisconsin, California, Washington, Oklahoma, Tennessee, New York, Indiana, Florida, Kentucky, and Maryland (Cadmus Group, 1991, 1996; Michael, 1997; Orr, 1993; USEPA, 1997; Wilde, 1994). Haney et al. (1989) report fifteen sites in Arizona with ground water contamination directly related to dry wells (i.e., storm water drainage wells). In many cases, both community and noncommunity drinking water supply wells have been contaminated or threatened. Sources of contamination cited in the literature include:

- food waste mixed with storm water effluent prior to discharge
- organic solvents or rinse waters disposed of in storm drains
- a tar and diesel fuel mixture used on a roof
- fuel and/or wastewater spills entering drains
- liquid waste discharged from a sump into a storm drain.

A representative subset of these ground water contamination incidents associated with storm water disposal across the country are described below in Table 10.

**Table 10. Selected Ground Water Contamination Incidents from Storm Water Drainage Wells**

Location	Incident	Contamination Type and Levels	Contamination of USDW?
Fairborn, Ohio (Orr, 1990)	In 1989, a commercial petroleum distributing facility accidentally released 21,000 gallons of fuel oil from an above-ground storage tank, which then overflowed from a diked area and entered two storm wells.	Six months after the spill, monitoring wells showed as much as eight feet of fuel oil on the water table.	Yes
Hutchison, Kansas (Kansas Dept. Of Health & Environment Correspondence, 1986)	A municipal water supply well was temporarily shut down because storm water effluent containing tar and diesel fuel mixture, which was used for roofing on nearby apartment buildings, entered dry wells via roof downspouts. The supply well, serving about 31,900 people, was closed until the dry wells were pumped.	Initial analyses of water from the downspout indicated 0.0006 mg/l xylene and 0.006 mg/l dichloromethane. A sample taken from the dry wells after remediation contained 0.0009 mg/l ethylbenzene, well below Kansas Notification Limit of 0.068 mg/l and Kansas Action Limit of 0.690 mg/l.	Yes
Waupaca County, Wisconsin (USEPA, 1996b)	In 1988, a school drinking water supply well serving 300 persons was contaminated by a storm water drainage well that received runoff from the school roof and waste from the kitchen garbage disposal. The drinking water was chlorinated and pumped, storm water runoff was rerouted to a surface discharge site, and garbage disposal waste was rerouted to a sanitary disposal system. The storm water well was excavated and backfilled.	Total and fecal coliform contamination were detected. A total coliform count of 139/100 ml was found. Fecal coliform contamination of a drinking water source is an acute health hazard.	Yes
McChord Air Force Base in Tacoma, Washington (ATSDR, 1989)	Organic waste solvents and sludge were disposed of in leach pits and in storm drains. In 1980, organic solvent contamination was discovered in drinking water supply wells for the City of Lakewood. Contamination was also found in drinking water wells for the base.	Concentrations in drinking water wells: trichloroethylene, 0.005 mg/l (Base), 0.020 mg/l (Lakewood); chloroform, 0.009 mg/l(Base); trans-1,2-dichloroethylene, 0.101 mg/l (Lakewood); tetrachloroethylene, 0.272 mg/l (Lakewood).	Yes

**Table 10. Selected Ground Water Contamination Incidents  
from Storm Water Drainage Wells (cont'd)**

Location	Incident	Contamination Type and Levels	Contamination of USDW?
Oak Grove, Kentucky	On April 16, 1998, the city water plant was shut down due to a severe storm that caused a sharp increase in raw turbidity. The area has several storm water drainage wells as well as sinkholes and caves. USEPA is directing storm water drainage well owners to run a dye trace to determine which wells are responsible for the siltation problem.	Prior to shutdown the raw turbidity was 6.5 NTU; at start-up the raw turbidity was 1,750 NTU and Alum feed rates were 344 mg/l. By April 19, 1998, the turbidity readings were down to 13 NTU and the plant was operating normally.	Yes
Valparaiso, Indiana	Storm water runoff from road salt piles maintained by the Indiana Department of Transportation entered storm water drainage wells. This resulted in the creation of a chloride plume in the shallow aquifer. The plume is migrating toward Valparaiso's public water supply wells.	Maximum concentrations of sodium chloride found in the ground water thus far is 10,000 mg/l. Sodium chloride concentrations average in the 200 - 400 mg/l range.	Within approximately 12 months.

Source: Cadmus, 1999

Additional examples of contamination events include the following:

- The Southland Corporation's dry wells in Los Gatos, CA, which are a part of the storm water drainage system, caused significant ground water contamination with gasoline. Specifically, ground water was contaminated with gasoline and other chemicals originating from Southland Corporation, a commercial site where it is alleged that surface spills of fuel and other chemicals washed into the dry wells (Cadmus, 1999).
- Industrial waste water and wash water from Glass-Tek in Morgan Hill, CA were discharged into a storm water retention pond with three dry wells in the bottom of the pond. The contaminants were volatile organic solvents, primarily TCE, some cis-1,2-DCE, and a little TCA. TCE concentrations in February 1993 were as high as 2.2 mg/l. (The MCL for TCE is 0.005 mg/l.) The ground water plume is over 2,500 feet long and at least 200 feet deep. As of November 13, 1998, the situation is exacerbated by the presence of several storm water retention ponds and other dry wells in the area above and adjacent to the plume. The potential for damage is high because the well is within the sensitive ground water recharge area for South County where ground water is the only source of water (Cadmus, 1999).
- The presence of chromium, copper, lead, zinc, and motor oil led to the closure of six rock wells (i.e., storm water drainage wells) in Modesto, CA. The rock well monitoring results appear to be fairly comparable to street sweepings in terms of the levels of the metals. Also, motor oil was detected in five of the six rock wells sampled. These motor oil results highlight the importance of the Illicit Discharges Program Element of the City's NPDES Stormwater

Program which has as its primary goal the elimination of illegal dumping into the City's storm drain system. In Mountain View, CA, dry wells led to the contamination of ground water and soil with dichloromethane and pentachlorophenol. The contamination was within three miles of drinking water wells that serve 333,000 people (Cadmus, 1999).

- In Bellevue, Ohio, the disposal of raw sewage in wells began in the late 1800's and continued until 1971. Nearly every dwelling and industrial plant had a well, ranging from 35 to 270 feet deep, for disposing of sewage (Orr, 1990). Despite regulations banning the disposal of raw sewage, several drainage wells in Bellevue, Ohio still continue to receive sewage through the connection of perimeter drains to septic systems. The perimeter drains are then tied into sinkholes or storm water drainage wells. Ground water in an area five miles wide and fifteen miles long was contaminated, affecting municipal wells and private drinking water wells. Rural wells outside the city still show contamination and have coliform levels that exceed safe drinking water limits. As a result of the contamination, alternative supplies of drinking water needed to be distributed in the Bellevue area, including the use of cisterns to capture rain water. In addition, homeowners with private drinking water wells installed settling tanks to reduce the level of mud and debris in their drinking water. Today, only surrounding communities that draw their drinking water directly from underground sources via private wells are still affected; the city of Bellevue now relies on a reservoir for drinking water (Orr, 1990).

#### 5.2.2 Storm Water Drainage Wells: Other Contamination Incidents and Studies

Several contamination incidents have also been reported by the Department of Environmental Protection (DEP) Central District, DEP Southeast District, and Miami-Dade areas in Florida. A total of 607 drainage wells (lake level control and storm water wells) in the Ocala, Live Oak, Orlando, and other areas were tested. Turbidity, color, total recoverable chromium, iron, lead, and manganese were equal to or exceeded the standards. Coliform bacteria was also present in varying concentrations. Storm runoff tested at these sites showed similar results (Cadmus, 1999).

A study by the Ohio Environmental Protection Agency documented several cases of intentional abuse of storm water drainage wells (Orr, 1993). Fairfield, Ohio had an estimated 2,900 storm drainage wells and catch basins in use. Many individuals routinely used these drainage wells to dispose of a wide variety of wastes, some of which may be hazardous. It is reportedly a common practice for individuals to dispose of used oil and antifreeze by dumping it into the drainage basins. Street crews routinely removed a variety of items from the drainage wells. In one instance, a well contained more than 20 used oil filters. The high transmissivity of the sand and gravel aquifer in Fairfield suggested that any contaminants reaching the aquifer are unlikely to be attenuated.

Additionally, Pitt et al. (1993) identified several common “non-storm water” entries to storm water drainage wells. These included:

- Sanitary wastewater sources: wastewater from sewage connections improperly hooked up to storm water drains and exfiltration, leakage, or effluent from improperly operating or designed nearby septic tanks.
- Automobile maintenance and operation sources: car wash wastewater, radiator flushing wastewater, degreasing wastes, improper oil disposal, or leaky underground storage tanks.
- Irrigation sources: lawn runoff from over watering or direct spraying of impervious sources.
- Relatively clean sources: infiltrating ground water, water routed from springs or streams, or leakage from water mains.

Sanitary wastewater is the most significant source of bacteria and oxygen-demanding substances, while automobile maintenance waste is the most significant source of toxicants (Pitt et al., 1993). Possibly 25 percent of separate storm water drains or systems have water flowing in them during dry weather, and as many as 10 percent are grossly contaminated with raw sewage and industrial wastewater (Pitt et al., 1996).

### 5.2.3 Lake Level Control Wells Contamination Incidents

Prior to 1987, a lake level control well was constructed on Lake Johio, in Orange County, Florida, to remove water beneath the land surface and to regulate the lake's level. Although lake level control wells are not constructed for the purpose of moving air beneath the land surface, this sometimes occurs (Watroba, 1999). It was discovered that air pockets trapped beneath the land surface migrated to various wells around Lake Johio and prevented them from yielding water. In 1987, the City of Ocoee annexed properties around Lake Johio, including property containing the lake level control well. Therefore, Orange County transferred custodianship responsibility for the well to the City of Ocoee; however, the city has not accepted responsibility for the well. In early 1998, residents in the Johio Shores area issued complaints with the Orange County Health Department that water from their private wells had the smell and appearance of lake water. The Orange County Health Department sampled five residential wells in the area and detected some background microorganisms but no coliforms. Water quality analyses of a private well sample near Johio Shores indicated the presence of iron and sulfur reducing bacteria (*Crenthrix polyspora* and *Beggiatoa alba*), which have the ability to transform or deposit significant amounts of sulfur, which in turn leads to an objectionable slime in well water. Iron bacteria can be associated with fouling and plugging of wells and may result in customer complaints of red/black and/or gray/tan water. Sulfur bacteria may also cause odor, taste, frothing, and color problems in well water. Colonies of *Aspergillus* and *Acinetobacter*, which are normally found in air and thus not expected to survive for a significant length of time in a well, were also detected. After these bacteria die off, they become a nutrient source for other bacteria, thus increasing the bacteria count in the well water. Analyses also indicated the presence of the following algae: *Microthamnion*, *Aganellum*, *Anacystis*, *Gleotrichia*, and *Cladophora*. When algae becomes discolored or viscous, it can cause clogging in plumbing systems and discolored and/or foul smelling water supplies. Decayed algae can also be a nutrient for many waterborne bacterial contaminants, thus increasing the bacterial count in a water supply (Cadmus, 1999).



The Florida Department of Environmental Protection (DEP) describes another contamination incident that took place near Lake Orienta, Altamonte Springs, Florida (data from this well are included in previous sections). In 1993, flooding occurred in Lake Orienta, causing nearby private drinking water wells to be contaminated. Because the drainage well injectate did not meet MCLs, the State could not issue a permit for the well. To avoid further damage caused by flooding, DEP issued several emergency authorizations to operate the well from March to November 1993, in January 1996, and in November 1996. During November 1996, monitoring was required for the injected fluids during the first 30 days and every three months thereafter while using the drainage wells (Cadmus, 1999).

## **6. BEST MANAGEMENT PRACTICES**

A variety of best management practices (BMPs) can be implemented to minimize the potential for contamination of USDWs resulting from storm water drainage wells. The BMPs can be organized into the following five general categories: (1) siting, (2) design, (3) operation, (4) education and outreach to prevent misuse, and (5) proper closure, plugging and abandonment. The proper design and siting of the storm water drainage well minimizes the likelihood of both accidental and routine contamination resulting from either poor operational practices or misuse. This section assesses some of these BMP techniques and their effectiveness in controlling USDW contamination by storm water runoff. The following discussion is not exhaustive and does not represent a USEPA preference for any specific BMP.

### **6.1 Siting BMPs**

The goal of many agency officials is to minimize the likelihood of contaminants reaching the storm water drainage well in a concentrated form, and to provide separation horizontally and vertically between the storm water disposal device and potential receptors of pollution such as aquifers, drinking water wells, and surface waters. Soil and water table conditions must be suitable for infiltration of storm water runoff and attenuation of contaminant concentrations. The geology, topography, and climate of an area greatly impact the effectiveness of a BMP in controlling contamination due to runoff; therefore, selection of BMPs must be made on a site-by-site basis. As a general guideline, the greater the separation distance between a storm water drainage well and ground water, the less the threat of contamination.

Evidence indicates that proper siting practices have been neglected. For example, in the 1995 San Francisco Bay Region Water Quality Control Plan, a survey conducted by the regional board staff and USEPA indicated that a number of municipalities and industries haphazardly installed storm water drainage wells and that construction and usage had been prevalent in the area and had gone virtually unregulated (San Francisco Bay Region Water Quality Control Plan, no date).

Storm water drainage wells which allow runoff to flow directly into the subsurface (e.g., some dry wells, bored wells, and improved sinkholes) generally pose a greater risk to USDWs than wells that have permeable barriers that can offer filtering mechanisms (e.g., vegetative infiltration basins). Table

11 presents a matrix used by Santa Clara Valley Water District to rate various sources of storm water runoff.

**Table 11. Preliminary Evaluation of Risk and Continued Use for Existing Storm Water Infiltration Devices, Santa Clara Valley Water District**

	Site Use				
	Industrial	Commercial	Residential	Agricultural	Parks/ Open Space
Risk Factor	High	Medium-High	Low-Medium	Low-Medium	Low
Continued Use Allowed	Improbable	Improbable	Possible	Possible	Probable
Monitoring for Continued Use	Yes	Probable	No	Probable	No
Destruction Requirements	Probable	Probable	Undetermined	Improbable	Improbable

Source: Santa Clara Valley Water District, 1993.

#### 6.1.1 Minimum Setback Distance from Surface Waters

Separation of drainage wells from surface waters provides filtration by a minimum layer of soil prior to entering a surface water downgradient from a storm water infiltration system. A second function of horizontal separation is to provide an overland separation if the infiltration device were to clog and cause water to pond at the surface. This separation would help to prevent highly turbulent and potentially contaminated flood waters from entering storm water drainage wells. Separation distance recommendations between storm water infiltration devices and surface waters take the following into account:

- Many local by-laws prohibit building within a buffer zone surrounding water bodies and wetlands. This building prohibition may also include construction of infiltration devices. Buffer zones vary in width, but more effective systems are designed to achieve at least a nine minute residence time. The residence time is the time in which any water molecule in the runoff is in the buffer zone as it travels to the collection zone, such as a water body or wetland.
- Storm water systems permitted under state or NPDES permits, depending on a state's authority, can discharge directly into some surface waters.
- For comparison purposes, local and state regulations contain minimum separation requirements between septic systems and surface waters. While not directly comparable, these regulations may serve as a useful point of reference. Typical separation of septic systems and surface waters is 40 to 100 feet, with greater distances for surface drinking water supplies (NSFC, 1995).

### 6.1.2 Minimum Setback Distance from Drinking Water Wells

The distance that a contaminant will travel from its source to a receptor such as a drinking water well will vary greatly depending on the depth of injection, volume and rate of rainfall, contaminant concentration in the injectate, soil characteristics (e.g., texture, pH, ability to remove contaminants), the direction and velocity of ground water flow, and other factors such as ground water pH and ground water table fluctuations. A site investigation to determine an optimum distance of separation for each affected site may not be practical. Because of the dependence of contaminant transport on local climate, geology and land use, no one value can be given to define separation distances for the entire country. Many states and counties develop guidance on separation distances based on local factors.

### 6.1.3 Minimum Separation from Water Table

Contaminants that are readily removed by attraction to soil particles are less likely to contaminate ground water when the injection well does not directly discharge into ground water. For this reason, several design recommendations include a minimum separation between the bottom of a storm water drainage well and the seasonal high ground water table. The extent to which contaminants are removed by soils depends on numerous factors (see Section 5). The height of ground water can be determined by examining soil strata for evidence of mottling (i.e., orange or dark reddish/brown spots formed from the oxidation of iron and manganese). Direct observation of ground water levels is less reliable because it only provides a snapshot of the ground water level and may not reflect the seasonal high level.

### 6.1.4 Prohibition from Some Areas of Critical Concern

A state or local agency or Indian tribe may find it desirable to prohibit storm water drainage wells from certain critical areas, for example, within drinking water well protection zones (e.g., source water protection areas), near waters of exceptional high quality such as Outstanding National Resource Waters, or adjacent to wetlands. Other areas where storm water wells may be banned include: brownfields, contaminated site clean-ups, and areas prone to landslides or slope instability. Several states actively discourage or prohibit dry wells, depending on site conditions. For example, Washington discourages the use of storm water drainage wells in areas that rely solely on their USDW for drinking water (see Section 7).

### 6.1.5 Minimum Engineering Design/Soil Performance Specifications

Many state or local infiltration regulations are based not on environmental protection, but on engineering and drainage specifications contained in plumbing and building codes. Effective methods for regulating new construction of storm water drainage wells under consideration by several states include changes to existing plumbing and building codes (see Section 7). In general, good design practice dictates that infiltration devices are not to be constructed in fill, in soils with high silt/clay content, and in soils with low infiltration rates. Conversely, the maximum allowed infiltration rate will prevent installation of storm water drainage wells where storm water moves extremely rapidly through

the soil. These design specifications, based on the infiltration rate, are intended primarily to prevent failure of the infiltration device rather than to protect ground water. High clay content in the soil is desirable in filtering contaminants, particularly metals, from the storm water. The designer must balance the infiltration capacity against the filtering ability of the soil when siting an infiltration device. The type and concentration of contaminants must be considered along with the expected flow rates and volumes in determining whether a site is suitable for an infiltration device. Even in soils with adequate infiltration rates, a heavy influx of oils, other organic compounds, and sediments introduced into the storm water drainage well can decrease the infiltration rate and cause an early failure of the well.

As noted in Section 6.1.3, certain contaminants (e.g., chlorides) do not sorb onto soil particles and therefore travel readily with ground water. In locales where storm water drainage wells exist along roadways, the local transportation authority may consider using sand or other gritty materials, rather than salt, to provide traction. To prevent clogging of the storm water drainage well in areas where grit materials are used in place of road salt, large settling basins and/or filter strips may be included in the well design. Operators often schedule more frequent maintenance of storm water drainage structures, particularly in the late winter and spring, in areas where sand or grit is used in place of road salt.

## **6.2 Design BMPs**

Design features can minimize the risk of contaminating drinking water sources and are often less expensive to install during construction than later as a retrofit. The following discussion of well designs and pretreatment systems is intended to provide a brief overview of the types of systems in use that can reduce the potential for pollution of ground water by storm water injection wells.

### **6.2.1 Sediment Removal**

Sediment carried in storm water runoff will enter a storm water drainage well unless the well includes devices for removing that sediment. Sediment poses three problems: (1) it can clog the infiltration system causing it to fail; (2) contaminants including metals, pesticides, and phosphorus, can attach to sediments and be carried into ground water systems, leading to possible contamination; and (3) wells that directly inject into USDWs may have sediment levels that, for hours or days, render the water unfit for human consumption in nearby wells. In many instances where the sediment load is very high, the infiltration system will clog and cause an unplanned discharge to surface waters before a significant amount of contamination can be carried by sediment into the ground water.

Pretreatment methods used for preventing sediment from entering storm water infiltration devices include oil/grit separators, settling basins (catch basins or detention or retention basins), and filter strips and swales.

One of the chief difficulties with many storm water drainage wells lacking pretreatment devices is that they tend to clog with fine sediment, slowing the rate of infiltration into the soil. In many cases, the sediment enters the basin or dry well during construction of the facility. Measures to prevent sediment from entering the infiltration device include temporary diversions such as sediment traps,

roping off the well area to prevent construction equipment or other traffic from compacting soil, and stabilizing the area around the well by planting vegetation. After the site is fully stabilized, the site operator can remove the sediment and excavate the remainder of the well.

### *Oil/Grit Separators*

Oil/grit separators, also called water quality inlets, consist of one or more chambers designed to allow sediments to settle out prior to entering the storm water well. Many separator designs also contain baffles so that the uppermost layer of water in each of the separator chambers is retained. Material such as oil floating on top of the trapped water is retained and can be removed when the separator is cleaned. Sediment that is heavier than water will settle out at a rate determined by the density and size of the sediment particles and the time allowed for settling. The portion of sediment that is removed is determined in part by the speed of water flowing through the separator, relative to the settling speed of the sediment and the depth of the separator. When a separator retains water long enough to allow particles to settle or rise to the surface, it is effective at retaining sediment. If the holding time is too short, particles remain in suspension and are passed to the infiltration system. A typical separator design is shown in Figure 11. If not properly designed and frequently cleaned, separators may also allow trapped sediment to be resuspended and pass out of the separator during subsequent flow events.

**Figure 11. Typical Separator Design  
(USEPA, 1998c)**

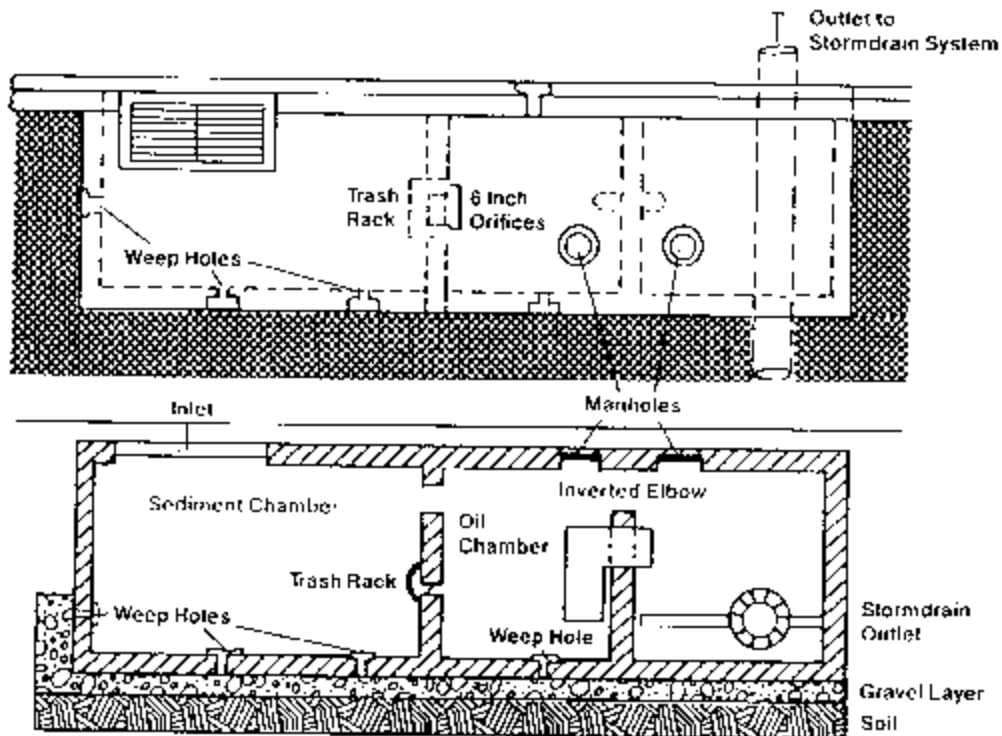

The advantage to using separators is that they employ basic principles that are well understood and are easily incorporated into the design of the system by storm water engineers. They are relatively simple to construct, are available as pre-fabricated units or can be custom built from standard fittings, and are relatively easy to maintain. Disadvantages of separators include: increased cost of a storm water drainage well; required periodic cleaning and maintenance which may necessitate costly equipment such as a jet pump; and questionable effectiveness, particularly in separating dispersed petroleum products (which depends greatly on the separator design and its associated holding time).

### *Filter Strips and Swales*

Filter strips and swales are vegetated buffers that trap sediment before it enters infiltration devices. Filter strips typically are at least 20 feet wide. The width of the strip is based on flow, site characteristics and pollutant loading. Pollutant removal is achieved by the filtering action of vegetation, settling into low velocity areas, or infiltration into the subsoil. Filter strips are generally graded to less than 2 percent so that water flows over them in sheets rather than as a concentrated stream. Sheet flow decreases the possibility of gully erosion and distributes contaminants over a wider area. Level spreaders such as slotted curbs may also be used to facilitate sheet flow. Vegetation also protects soil from being eroded. Roots and fauna in the soil also provide pore space for infiltration. Native vegetation requires less maintenance (e.g., pesticides or fertilizers). Filter strips are generally used in agricultural low density development areas and cannot treat high velocity flows (New Jersey Departments of Environmental Protection and Agriculture, 1994).

### *Catch Basin Inserts*

Catch basins are often used to hold water before it flows to infiltration devices. Catch basin inserts can remove oil, grease, and metals in runoff. The inserts consist of several filtration trays that hang down from the inlet grate. The top tray is an oil/grit separator, and the lower trays may be activated charcoal, which trap pesticides, fertilizers, and metals; reconstituted wood fiber, which traps oil and grease; or fiberglass insulation. While these inserts can remove potential contaminants, they require at least monthly inspection and maintenance and require more frequent inspection during wet periods. Additionally, inserts clog easily, preventing passage of storm water, and are hard to remove without proper equipment.

### 6.2.2 Oil and Grease Separators

Petroleum products contain components such as benzene, which are known human carcinogens, that can potentially contaminate ground water. Petroleum can enter a storm water drainage well from: (1) accidental spills, (2) intentional misuse through disposal of automotive products (e.g., used motor oil), and (3) oil residue washed from pavement. As discussed above, oil/grit separators can remove some oil before it enters infiltration devices. These separators, however, are not very effective in removing oil droplets that are either entrained or dispersed within the flow, as well as miscible oils.

If an oil and grease separator is designed to allow sufficient holding time, oil droplets can also be removed from storm water. Generally, there are two categories of oil separators, those designed to retain small spills, and those designed to provide extended holding time to allow separation of dispersed oil. A specific type of separator in the second category uses "coalescing plates" made of polypropylene or fiberglass to separate dispersed oil. The various types of oil and grease separators are discussed below.

### *Spill Control Separators*

Spill control separators, similar to the oil/grit separators discussed in Section 6.2.1, are chambers that allow oil and grease to float to the top of a chamber, while water from below the oil layer is allowed to pass through to the storm water disposal system (see Figure 12). They are effective at retaining small spills but do not remove dispersed oil droplets because they have a relatively short residence time. These separators are essentially catch basins designed to retain oil and can often be included in a project at little additional expense above a simple catch basin. However, many oil/grit separators (like that in Figure 11) can be expensive to construct and install, and are generally used only in relatively small, impervious areas that have a high potential for oily runoff (e.g., gas stations and industrial areas). Separators must be cleaned frequently (monthly or quarterly) to avoid clogging, or concentrating and resuspending contaminants. Furthermore, it is possible for the oil and sediment removed from these devices to exhibit one of the RCRA hazardous waste characteristics; therefore, it is recommended that these materials are tested prior to disposal.

Figure 12. Spill Control Separator  
(USEPA, 1998c)

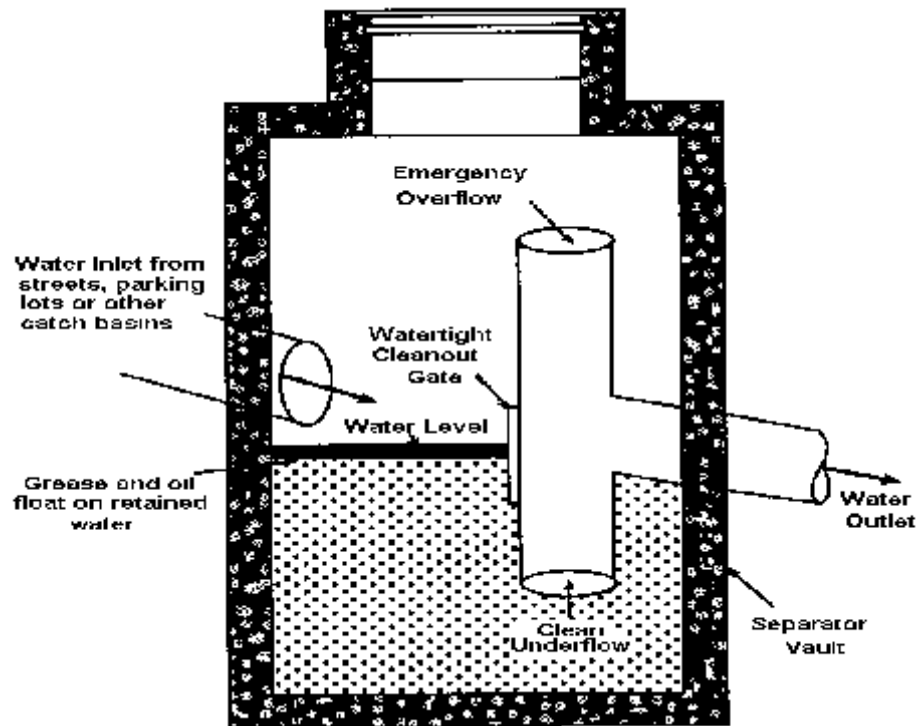

*American Petroleum Institute Oil Separators*

This type of separator consists of long vaults designed to retain storm water long enough for finely dispersed oil droplets to rise to the surface (see Figure 13). Design of these oil separators is discussed in American Petroleum Institute (1991). Because of its relative complexity, use of this type of separator is only recommended where there is a relatively high likelihood of dispersed oil contamination (e.g., petroleum distribution sites). Otherwise, alternative strategies are typically employed to minimize or eliminate the source of the oil prior to its entry into the storm water conveyance system.



Figure 13. Oil Separator  
(USEPA, 1998c)

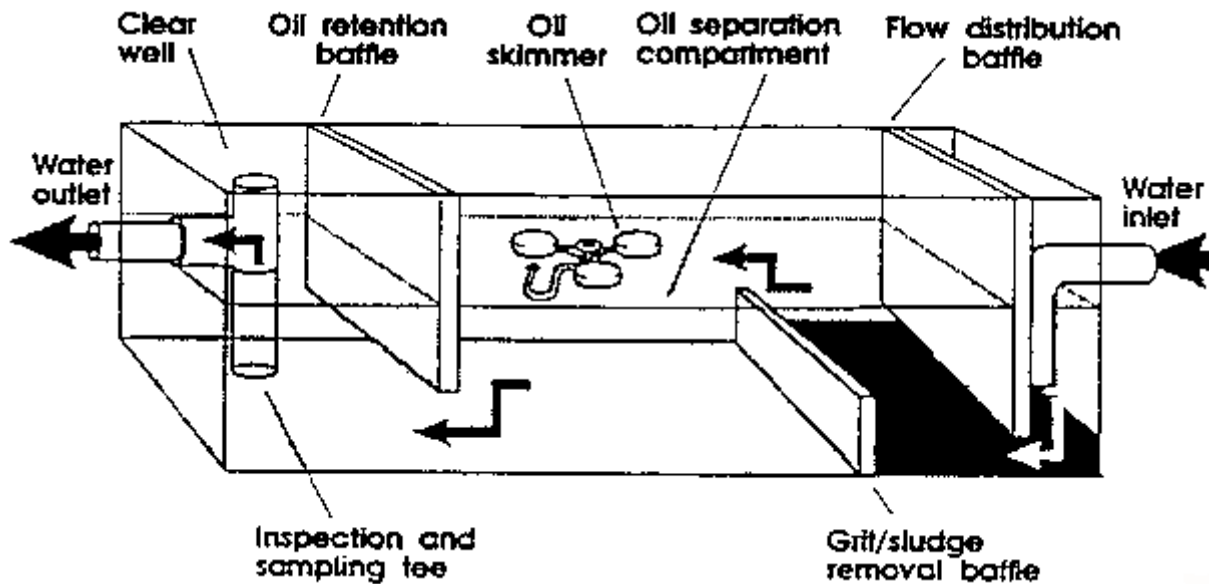

#### *Oil Absorbent Material*

Oil absorbent pillows are simple and inexpensive ways to absorb petroleum products that are present in high concentrations. The pillows are placed in the oil/grit separator, where they float (they do not absorb water), and are later removed during maintenance. One readily available model is roughly 18 inches long and absorbs up to 2 gallons of petroleum-based liquid. In combination with a grease and oil separator, hydrophobic pillows can minimize the amount of petroleum product passed on to an infiltration device. However, due to their relatively small capacity, they are not effective in mitigating large-scale spills. In addition, they do not remove (absorb) dispersed oil.

#### *Coalescing Plates*

Coalescing plates are sets of thin, closely-spaced sheets or plates designed to induce finely mixed oil to coalesce into larger droplets which are more easily separated from water. These plates typically are made from fiberglass or plastic. The primary advantage of this technology is that a separator can be smaller for a given application by more rapidly removing oil droplets from standing water (see Figure 14). Separators incorporating coalescing plates require periodic inspection and cleaning, and they can be expensive. Because of their relative complexity, these types of separators are used where there is a relatively high likelihood of dispersed oil contamination and trained staff are available to perform proper maintenance. They are not routinely used for uncontaminated storm water.

**Figure 14. Coalescing Plate Separator  
(USEPA, 1998c)**

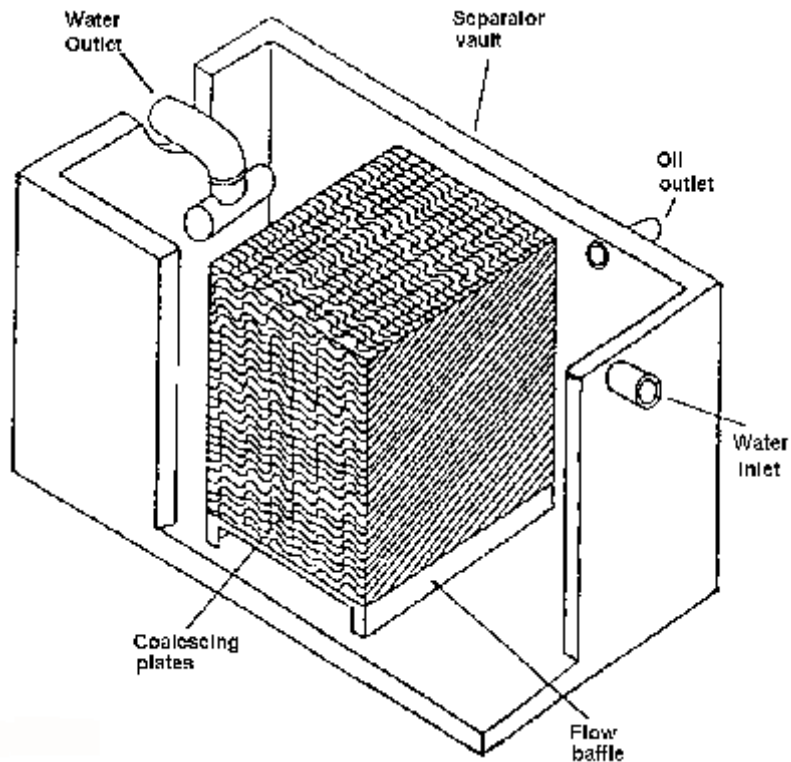

### 6.2.3 Additional Pretreatment System BMPs

Although the risk of ground water contamination can be reduced by following the basic precautions discussed above, further measures may be implemented in some cases. The RTC identified several BMP pretreatment systems including onsite vegetated infiltration basins and sand/gravel filters that may be effective in reducing contamination risks (USEPA, 1987). Additional BMPs commonly used to improve the quality of storm water runoff include wet ponds, storm water wetlands, infiltration trenches, and porous pavement (New Jersey Departments of Environmental Protection and Agriculture, 1994; Scheuler et al., 1992). These additional pretreatment system BMPs are discussed below. This information will aid well owners or operators in selecting appropriate pretreatment systems.

#### *Vegetative Infiltration Basins*

These basins are vegetation-lined impoundments where storm water runoff is stored until it seeps through the soil of the basin floor. Treatment occurs through both infiltration and bio-chemical action in the vadose zone soils. Runoff greater than the capacity of the basin flows into a storm water injection well after a short period of detention during which sedimentation occurs. Miller (1983, 1987) reports that removal rates for contaminants in vegetative infiltration basins are higher than in soil or

gravel-lined systems. These systems require porous soils underlying the basin and careful construction practices to ensure that the surface is not sealed or overly compacted.

### *Sand/gravel Filters*

This system provides for the first flush of runoff to be diverted into a self-contained bed of sand or gravel (Scheuler, 1992). Pollutant removal is achieved as the runoff is strained through the sand/gravel. The runoff is then collected in underground tanks, and returned to the stream bed or channel.

### *Wet Ponds*

Wet ponds are basins that collect incoming runoff in a permanent pool of water. Constituents are removed through gravitational settling, algal settling, wetland plant uptake, and bacterial decomposition. Construction of a wet pond can be enhanced by installing a forebay that traps sediments where they can easily be removed. Wet ponds have a moderate to high degree of effectiveness in removing particulate and soluble pollutants, however, they require significant amount of space and thus cannot often be used in urbanized areas. Wet ponds are also susceptible to clogging (New Jersey Departments of Environmental Protection and Agriculture, 1994; Scheuler et al., 1992; USEPA, 1983).

### *Storm Water Wetlands*

These wetlands consist of a series of shallow pools that create conditions suitable for the growth of marsh plants (Scheuler et al., 1992). Wetlands remove pollutants through gravitational settling, wetland plant uptake, adsorption, physical filtration, and microbial decomposition and have a moderate to high degree of effectiveness in removing sediments. Wetlands, however, are less effective in removing nutrients. Limited use of storm water wetlands occurs in heavily urbanized areas because wetlands are most effective when the wetland area is more than two percent of the watershed area; smaller "pocket wetlands" are difficult to maintain.

### *Infiltration Trenches*

Infiltration trenches are impoundments where incoming storm water runoff is stored until it gradually seeps through the soil of the trench floor (New Jersey Departments of Environmental Protection and Agriculture, 1994; Scheuler et al., 1992). Trenches are most often constructed in areas where surrounding land uses have been stabilized to prevent heavily sedimented runoff (Oregon Department of Environmental Quality, 1997). The removal of pollutants is governed by trench size and can be enhanced by increasing the surface area reserved for exfiltration. Infiltration trenches are prone to clogging and often offer only a short-term solution for effectively filtering runoff. In order to avoid clogging, costly pretreatment systems such as inlet/oil grit separators may be installed to remove sediments and oil.

### *Porous Pavements*

Porous pavements typically divert runoff through a porous asphalt layer into an underground stone reservoir (New Jersey Departments of Environmental Protection and Agriculture, 1994; Scheuler et al., 1992), where the stored water gradually infiltrates into the subsoil. Pollutant removal occurs through adsorption, straining, and microbial decomposition in the subsoil below the underground stone reservoir. A minimum distance of three feet is recommended between the seasonal high water table or bedrock and the stone reservoir. Up to 90 percent of annual rainfall can be diverted to ground water by using porous pavement. Porous pavements can be highly effective in removing heavy metals from storm water runoff and are more feasible on sites with gentle slopes, permeable soils, and deep water table or bedrock levels. They are, however, prone to clogging, with one study estimating that 75 percent of all porous pavement systems become partially or totally clogged within five years (Scheuler et al., 1992). In some cases, porous pavements may actually increase the potential for ground water contamination due to the leaching of the asphalt materials and hydrocarbons.

#### 6.2.4 Studies on the Effectiveness of Pretreatment System BMPs

A study of sites in Maryland examined ground water beneath and down gradient from three vegetated detention ponds, which function in much the same way as conventional wet ponds (Wilde, 1994). The data suggested that pond-bottom materials effectively removed trace metals from storm water, because concentrations of these metals increased significantly in bottom materials. Despite the accumulation of pollutants in the pond, primary or secondary MCLs for aluminum, cadmium, chromium, and lead were periodically exceeded in ground water samples. In addition, uncharacteristically high levels of barium, copper, nickel, strontium, vanadium, and zinc were occasionally detected in the ground water. The author explains the presence of trace metals in the ground water by pointing out that algal photosynthesis increases the pH of pond water. Because many metals are soluble at high pH, high algae levels may contribute to high metal concentrations (Wilde, 1994).

Low concentrations of polyorganic compounds were also found in the pond-bottom materials but not in ground water. This suggests that the basins also successfully removed these compounds. Consistently high levels of chloride were found in ground water, which indicates that chlorides were not being flushed from the aquifers. The study concludes that detention ponds may be effective in removing some pollutants from storm water, but that this removal may have been limited by the fact that the pH of pond water was increased by algal photosynthesis, heightening the solubility of trace metals.

McKenzie and Irwing (1988) compared ground water samples below an exfiltration trench and a vegetated swale in Dade County, Florida. Two sites were studied: (1) an employees' parking lot and (2) a parking lot at a commercial complex of warehouses and businesses. Both sites were drained through an exfiltration trench and a vegetated swale. The exfiltration trenches consisted of a catch basin (which functioned as a sediment filter) and a perforated pipe (which functioned as an exfiltration conduit). The vegetated swales were simply shallow, vegetated depressions used to filter the storm water. Samples were taken from ground water wells in the vicinity of the trenches and the swales.

Results indicated that storm water recharge from the trenches did not significantly affect the ground water. In particular, lead and zinc concentrations were significantly higher in storm water entering the trenches than in the ground water, suggesting that these trace metals were partially removed by the trenches. In the test wells near the swales, results were inconclusive. Researchers found higher concentrations of major ions, iron, and ammonia in ground water near the swales than in ground water near the trenches. The high concentrations of Kjeldahl nitrogen and ammonia nitrogen in the ground water at the swales suggest microbial decomposition, causing a release of nitrogen.

Schiffer (1989) studied the effects of three highway runoff detention methods on the water quality of the surficial aquifer system in central Florida. The three detention methods studied were an exfiltration trench, two ponds (detention and retention), and two swales. Constituent concentrations in ground water near each storm water well were compared to concentrations in ground water from an upgradient control site. This was done to ensure that the difference in ground water pollutant concentrations was not simply due to the difference in background ground water quality. Sampling was conducted at several wells around each structure, one of which was the control well. The control well was located near each storm water well, but far enough away to be out of the zone of influence. In general, the authors concluded that ground water quality tended to be lowest when the swales were used as compared to the other methods tested.

Table 12 summarizes the findings of two study evaluations of the effectiveness of certain BMPs in removing key pollutants from storm water runoff.

**Table 12. Reported Effectiveness of BMPs for Removal of Pollutants**

Best Management Practices (BMPs)	Removal Rate ( percent)							Comments
	Sediments	Total Phosphorus	Lead	Copper	Zinc	Total Nitrogen	Nitrate	
Conventional Wet Ponds	40 - 90	40 - 90	60 - 95	45 - 95	30 - 95	40 - 60	60	Long-term removal rate for sediments may be lower due to clogging. Results for phosphorus fluctuate seasonally. Survival rate of pathogens remains uncertain.
Infiltration Trenches	75 - 90	60	65 - 80	80	65 - 80	60	Low removal rates are expected	Few studies have been completed.
Porous Pavement	80 - 90	60	98 - 99	98 - 99	98 - 99	80	No data	Limited applicability
Sand Filters	60 - 95	40	50 - 75	50 - 75	50 - 75	35	Negative	Negative removal may reflect the nitrification process.

**Table 12. Reported Effectiveness of BMPs for Removal of Pollutants (cont'd)**

Best Management Practices (BMPs)	Removal Rate ( percent)							Comments
	Sediments	Total Phosphorus	Lead	Copper	Zinc	Total Nitrogen	Nitrate	
Grassed Swales	No data	No data	50 - 90	50 - 90	50 - 90	No data	No data	Studies show that swales may be more effective at removing trace metals than nutrients.
Extended Detention Basins	60 - 70	40 - 50	60	45	30 - 50	25	No data	

Sources: Schueler et al., 1992; New Jersey, 1994.

### 6.3 Operational BMPs

The purpose of this section is to discuss BMPs that state and local government officials and Indian tribes can recommend to operators of Class V wells to minimize the threat to USDWs. Ways to reduce or eliminate the contact between storm water runoff and contaminants are discussed. Topics covered include source separation, pollution prevention, and specific examples of BMPs for common site activities.

Industrial sites, construction sites, highway areas, and urban areas may all present varying sources of contaminants to storm water drainage wells; it is important to determine which management practices will be most appropriate and beneficial for a particular site. Wells in these locations may be classified as industrial wells rather than storm water drainage wells. Regardless of their classification, based on their proximity to contaminant sources, the wells might be required to be either permitted or closed.

#### 6.3.1 Source Separation

Contaminants released by industrial activities, either as diffuse contamination or as concentrated spills, could be washed into storm water wells by rainfall and storm water runoff. Separating industrial activities from storm water is a necessary means of minimizing contamination of storm water and ground water. This can be accomplished by moving activities indoors, installing spill containment devices, and covering materials stored outdoors. Basic containment methods including curbing, containment dikes, sumps, and covering are discussed below.

Curbing is a type of barrier, usually made of concrete, metal, or other impermeable substance, that can be used to separate potential spill areas from storm water runoff. Curbing is usually used on a small-scale to prevent spills in areas where liquids are stored or used. Figure 15 shows curbing used to prevent the spread of spills or leaks from storage drums. Grading (i.e., sloping the land surface) within the curbing can help facilitate cleanup by concentrating contaminants in one part of the curbed area. Spills cleaned up promptly help to avoid overflow to non-curbed areas and help to minimize residual

contaminants that can be suspended in runoff. Often, materials spilled in curbed areas can be recycled. While curbing is relatively inexpensive and easy to install, it is not effective in containing larger spills.

**Figure 15. Curbing**  
(USEPA, 1998c)

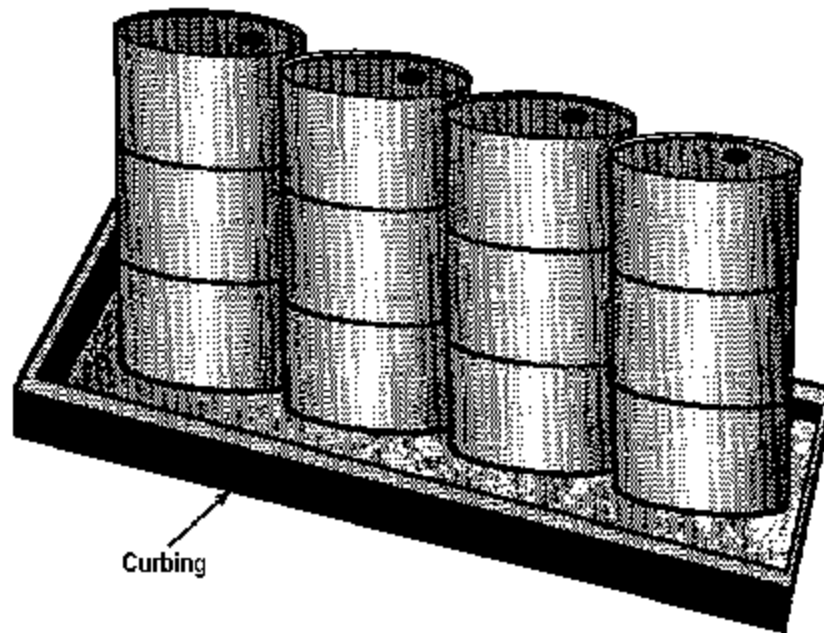

Containment dikes are designed to hold larger spills. They are earth or concrete retaining walls often constructed in loading and unloading areas as well as areas where liquids are stored above ground (see Figure 16). Dikes are typically designed to hold a volume at least equal to the largest storage tank present plus expected rainfall. Some guidance recommends that at least 10 percent of total tank volume or 110 percent of the largest tank be retained. Overflow of containment dikes can be prevented by using a pumping system or vacuum trucks to remove spilled contaminants. Containment diking is an effective method of preventing contamination of storm water runoff, but may be expensive for small facilities because of construction and maintenance costs.

**Figure 16. Containment Dike  
(USEPA, 1998c)**

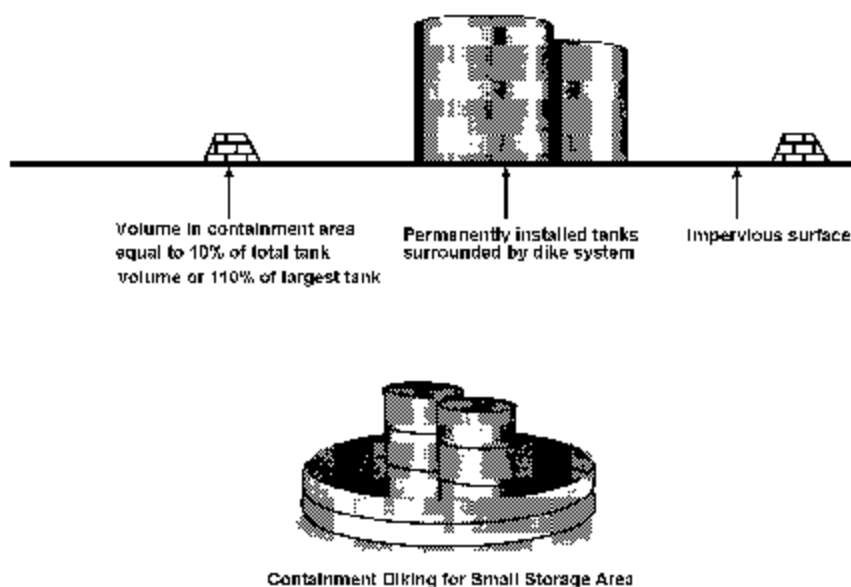

Sumps are holes or low areas graded so that liquid spills or leaks flow toward a particular part of a containment area. Pumps are often placed in the sump to transfer liquids away from the sump as it fills. Sumps are most often constructed of impermeable materials so as to avoid leaks into the surrounding subsoil and are positioned at the lowest point in a containment area for maximum efficiency. Sumps are a practical means of collecting storm water in a containment area, but pumps require periodic maintenance to avoid clogging.

Covering materials stored outside is an effective way to prevent rainfall and storm water runoff from contacting potential contaminants. High-risk areas can be covered by tarpaulins, plastic sheeting, roofs, or awnings, and are most effective when routinely inspected for holes.

### 6.3.2 Pollution Prevention Planning

Proper storm water management is best organized with a pollution prevention plan. A formal storm water pollution prevention plan (SWPPP) is typically included in NPDES industrial storm water permits as required at 40 CFR §122.26 for discharge of industrial site storm water to surface waters. While a formal plan is not required for subsurface discharge of industrial site storm water, organizing storm water management throughout a facility can increase efficiency of managing storm water, increase the likelihood of success, and be used to communicate facility policy to site personnel. Benefits of pollution prevention approaches include reduced future costs of environmental compliance and cleanup. State and local government officials and Indian tribes may find it useful to recommend a SWPPP to well



operators. The development of a successful SWPPP includes several key components (USEPA, 1996b):

- **Planning and Organization:** As a first step, determine who will be responsible for developing the plan. This person first evaluates other environmental facility plans (if they exist) to determine whether there is an overlap of regulations and to establish consistency. For example, some facilities contain a mix of dry wells and surface discharging storm water systems. They may have a National Pollutant Discharge Elimination System SWPPP that addresses the surface discharged storm water.
- **Assessment:** It is important to assess materials and practices that may be contaminant sources. This includes taking an inventory of potential contaminants and identifying potential spill areas; it is often helpful to evaluate past spills to identify potential spill areas. It is helpful to develop a site map showing the location of these contaminant areas and the location of storm water drainage areas, including drainage wells, drinking water wells, rivers, ponds, etc., as appropriate.
- **BMP Identification:** A plan includes both general housekeeping and targeted operational BMPs, as appropriate. Several "baseline" operational BMPs identified in *Storm Water Management for Industrial Activities* (USEPA, 1992) are: good housekeeping, preventative maintenance, visual inspections, spill prevention and response, sediment and erosion control, management of runoff, employee training, and recordkeeping and reporting. Targeted BMPs are specific to the type of activity that may contaminate storm water.
- **BMP Implementation:** BMP implementation often includes annual employee training, education, and hands-on drills for all parts of the SWPPP. Trained employees understand not only how to perform specific tasks, but why their assigned tasks are important in preventing storm water and ground water contamination.
- **Evaluation/Monitoring:** Once the plan has been implemented, it is important to evaluate its success. This includes an annual site inspection, review drills and BMP evaluation by the operators of a facility. It is important that areas near storm water drains be inspected for evidence of contamination.
- **Education/Outreach:** Educating employees and the public about the importance of storm water pollution prevention can not be understated.

In areas adjacent to a water supply well where a Wellhead Protection Plan is required, a storm water plan is part of the Wellhead Protection Plan.

### 6.3.3 Spill Response

It is important that employees are trained and educated in proper spill response procedures including: (1) how to prevent a spill from reaching a drainage well; (2) areas where spilled materials could potentially flow; (3) who to call for additional help in cleaning up a spill; (4) how to use spill cleanup equipment such as booms, barriers, sweeps, and adsorbents; and (5) how to properly dispose of spilled materials. Response times will be shortened when spill cleanup materials are readily available at all times. An organized and easy-to-follow spill prevention plan will result in an efficient response to a spill. It is important for cleanup materials to be disposed of properly and for employees to be aware of any local and/or state spill reporting requirements.

USEPA's regulations in 40 CFR Part 112 (Oil Pollution Prevention) require that a Spill Prevention, Control and Countermeasures (SPCC) plan be prepared and implemented by those facilities that are non-transportation related, are located where a spill could reasonably be expected to discharge oil into or upon navigable waters of the U.S., and that have: (1) a total aboveground oil storage capacity of more than 660 gallons in a single tank; or (2) a total underground oil storage capacity of more than 42,000 gallons. Employees at facilities with SPCC plans can respond more effectively when they are made familiar with the plan. Such plans can be an effective BMP for storm water drainage wells and, in fact, are supposed to include information on whether an oil spill could potentially reach a drainage well.

### 6.3.4 Operational BMPs for Common Site Activities

This section summarizes operational BMPs for common site activities that can contribute to the contamination of storm water including loading and unloading materials and maintenance of vehicles and equipment (i.e., washing, fueling, or painting). Implementing proper operational BMPs is often an effective and inexpensive way of preventing contamination by storm water. USEPA's *Storm Water Management for Industrial Activities* (USEPA, 1992) provides a detailed discussion of BMPs for preventing storm water pollution to surface waters. As noted earlier, wells located in proximity to the activities described below may be classified as industrial wells rather than storm water drainage wells. In any event, property owners are strongly discouraged from siting new storm water drainage wells in areas near the activities described below.

#### *Vehicle and Equipment Fueling*

There are several aspects of fueling activities that can lead to contamination of storm water. These include spills or leaks during the delivery of fuel and oil to above-ground tanks, spills from vehicle tanks during refueling (often caused by "topping off" tanks), contact between rainfall or storm water and the refueling area, and washing the refueling area. BMPs for these problem areas include installing spill and overflow prevention equipment on storage tanks, discouraging "topping off" of vehicle fuel tanks, and covering refueling areas with a roof to prevent direct contact with rainfall. Refueling areas paved with concrete instead of asphalt help to avoid infiltration of spilled fuel and oil into the pavement and underlying soil. If necessary, the refueling area can be graded and dikes or curbs installed to prevent

storm water from flowing across the area (see Section 6.3.1). Best practices include directing storm water runoff from roof downspouts away from refueling areas, avoiding washing or hosing of refueling areas with large amounts of water where adjacent to storm water wells, and using cloths or specialized dry absorbent materials to clean spills in the refueling area.

### *Vehicle and Equipment Maintenance*

Routine maintenance of vehicles and equipment outdoors can release harmful contaminants such as oil and grease, automotive fluids, and battery acid, which can enter storm drains. Other potential problems include leaks from vehicles and equipment in storage areas and improper disposal of maintenance materials such as greasy rags and used oil filters. Best practices include checking vehicles and equipment for leaking fluids such as oil, using drip pans under leaking vehicles, disposing of drip pan contents properly, and separating work areas from areas contacted by rain water.

### *Equipment Washing*

Wash water can contain many harmful contaminants including solvents, oil and grease. These contaminants can migrate to storm water drains after rainfall if vehicles and equipment are washed outside. BMPs for washing vehicles and equipment include using detergents that are biodegradable and contain no phosphates, washing vehicles in designated diked and graded areas where the wash water will flow to a treatment facility, recycling wash water, and preventing underbody washing in areas where runoff enters a storm water drainage well.

### *Material Loading/Unloading*

Loading and unloading materials at terminals or loading docks can be a source of contamination. Materials that are spilled or that leak from vehicles may enter storm water drains. Specific loading and unloading activities that may cause storm water contamination include transferring material by truck, forklift, or conveyor belt; transferring liquids or gases between a truck or railroad car and a storage facility; and transferring dry chemicals between loading and unloading vehicles. BMPs for loading areas include checking loading and unloading vehicles for leaks and performing loading/unloading activities in specially designed areas. Limiting exposure to rainfall can be achieved by covering loading areas with a building overhang or awning. Constructing dikes around loading and unloading areas can greatly reduce the risk of spilled materials reaching storm water drains, as does directing runoff away from loading areas.

### 6.3.5 Monitoring BMPs

An important part of any pollution management strategy is an adequate monitoring system to evaluate contamination. Storm water monitoring will benefit from a consideration of the intermittent nature of runoff events. Defining the hydrology will allow reliable predictions of the direction and rate of flow of ground water impacted by contaminated storm water in the vicinity of the storm water drainage well.

Another important monitoring consideration is the build-up of hazardous or deleterious contaminants in the sediments underlying infiltration or storage basins or in the vadose zone underlying storm water drainage wells. For example, in California, infiltration basin sediments have accumulated sufficient levels of heavy metals to warrant handling of the surface layer as a RCRA hazardous waste (Lee and Taylor, 1998).

#### 6.3.6 Maintenance BMPs

Maintenance of the storm water drainage well is critical to the effectiveness of the system. American National Standards Institute (ANSI) recommends that the following elements be included in a thorough inspection:

- Inspect wells for accumulated debris, rodents, or other obstacles to flow at inlets and outlets
- Check the system interior for roots, mineral deposits, trash, or silt build-up
- Inspect the ground surface for signs of subsurface drainage leaks
- Check inlet and outlet areas for evidence of erosion, which can impede structural and hydraulic performance
- Examine catch basins, headwalls, and culverts for signs of wear or breakage
- Check upstream in the drainage system for backups or ponding of surface water that could indicate reduced injectate flows (ANSI, 1993).

The guidelines also recommend the use of electronic and optical aids like television cameras or fiber optic scopes to detect cracks, displacements, and other interior well problems.

Catch basin trap and drywell inspection and frequency will vary with site activities and the amount of sediment typically carried in the storm water runoff. A main purpose of cleaning is to prevent the buildup of a floating oil layer and a bottom sediment layer, which can be drawn into the well during a significant runoff event. It is also important to remove bulk solids from inlet screens, to remove sediment from catch basins and pretreatment devices, and to revegetate vegetative infiltration basins and grass swales.

Dry wells can be cleaned by a process called jetting, in which wells are partially filled with water, compressed air is injected at the bottom of the well, and the sediment is forced out the top. The frequency with which dry wells are cleaned will vary greatly depending on the sediment load from the site and the depth of the dry well. Operators of dry wells may have a jet-pump available as standard maintenance equipment to perform jetting on an as-needed basis. Chemical cleaning of drainage wells using biodegradable solutions or neutralizing an acid solution used to dissolve mineral deposits may also be used when there is no access for mechanical cleaning (ANSI, 1993).

### **6.4 Education and Outreach BMPs to Prevent Misuse**

Education and outreach to the general public, owners and operators of storm water wells, and state and local officials and Indian tribes is an important element in storm water pollution prevention.

An effective education and outreach program can: (1) disseminate information about the effects of pollution from diffuse sources on ground water, including the loss of drinking water sources; and (2) promote positive environmental results, including the reduction of pollutant loadings from urban and industrial areas. The goal of a storm water education and outreach program is to (1) promote voluntary compliance with regulations designed to protect ground waters from pollution and (2) deter intentional misuse of storm water wells that introduces contaminants into storm water drainage wells.

For storm water wells located in industrial settings, facility owners and operators can implement a formal storm water pollution prevention education program. Under NPDES, staff training on storm water issues is required at facilities. Staff education and training on storm water pollution prevention targeted to drainage wells could be both helpful and combined with NPDES training already being conducted. Specifically, employee education and training can include the following topics:

- The location of nearby storm water wells
- Storm water well contamination leading to the contamination of aquifers
- Spill prevention
- Procedures that minimize chronic pollution caused by routine activities.

In addition to UIC guidances, owners and operators may also consult NPDES and Coastal Zone Act Reauthorization Amendments (CZARA) guidance documents for more information on the above topics.

Public education about storm water drainage wells by state and local officials and Indian tribes can include organized activities such as:

- **Direct Mailings:** Informational pamphlets can be sent to community members. These pamphlets can include information about storm water drainage wells and can answer basic questions such as (1) what is a storm water drainage well, (2) what does a storm water drainage well look like, (3) what can be done to prevent contaminants from reaching a storm water drainage well?
- **Labeling of Storm Water Drainage Wells:** Storm water drainage wells can be clearly labeled (i.e., stenciling) with such phrases as “No Dumping.” The public can be educated that storm water drains usually flow directly to waterways or discharge to ground water without treatment, stressing the importance of keeping pollutants out of the storm water drains.
- **Community Meetings:** Public meetings can be scheduled to inform citizens and local officials about storm water drainage wells. Information can be presented regarding federal and state regulations for Class V storm water drainage wells.

Municipalities required by the regulations at 40 CFR §122.26 to obtain NPDES permits for storm water discharges from their separate storm sewer systems are typically required to develop public education programs for reducing pollutants in storm water discharges to surface waters. These

same programs may be equally effective for educating the public about reducing storm water discharges to ground water.

The city of Charlotte, NC developed a successful storm water education and outreach program based on a four-point action model discussed below (Schumacher, 1992).

(1) Define the issues: An important first step in public education is to determine which issues are most important. Important issues include presenting the need for a storm water program because of federal (i.e., USEPA), state, and local regulations, and because of risk posed to USDWs. It is important for the public to understand the need for pollution prevention in storm water. Past problems in the community due to polluted storm water can be highlighted as well as any cleanup costs associated with these problems. It can be clearly stated how an organized storm water pollution prevention program will be structured and what it will cost.

(2) Set objectives: An education and outreach program with clear basic objectives will have a higher likelihood of success (Beech and Drake, 1992). Example objectives include:

- Educate and inform the public
- Involve and seek input from the public by encouraging frequent public meetings and establishing a citizens task force
- Evaluate the storm water education program by conducting surveys and monitoring media responses.

(3) Identify resources: It is important to determine which organizations, citizens groups, and individuals will work to carry out the objectives of a storm water education and outreach program. A project leader is important to organize and assign responsibilities.

(4) Outline and conduct activities and tasks: The effectiveness of particular education and outreach activities will vary from community to community. However, below is a list of specific activities that can be considered:

- Conduct surveys on public knowledge and perception of storm water issues
- Set up a telephone hot line to answer questions
- Distribute literature such as pamphlets, newsletters, and fact sheets
- Involve the local media and provide reporters with media kits.

## **6.5 BMPs for Properly Closing, Plugging and Abandoning Storm Water Drainage Wells**

Proper closure, plugging and abandonment of storm water drainage wells that either no longer serve their original purpose or are a threat to USDWs is important. Appropriate measures for plugging and abandoning storm water drainage wells may include:

- Complete removal of any surface structures such as settling basins, piping, etc.
- Complete removal of all casing, gravel, and other filter and/or annular sealing materials
- Collection of environmental samples
- Backfill and sealing of the resulting borehole.

With regard to lake level control wells, states and localities may be hesitant to close these wells because they are often the only source of drainage to control flooding in a community. There does not appear to be any feasible alternative for these wells at this time.

## **7. CURRENT REGULATORY REQUIREMENTS**

As discussed below, several federal, state, and local programs exist that either directly manage or regulate storm water drainage wells, or impact them indirectly through broad based water pollution prevention initiatives.

### **7.1 Federal Programs**

On the federal level, management and regulation of storm water drainage wells falls primarily under the UIC program authorized by the Safe Drinking Water Act (SDWA). Some states and localities have used these authorities, as well as their own authorities, to extend the controls in their areas to address endemic concerns associated with storm water drainage wells. Other federal programs that address storm water drainage wells indirectly are implemented under the National Pollutant Discharge Elimination System (NPDES) under the Clean Water Act (CWA), as well as the Coastal Zone Management Act (CZMA), the Coastal Zone Reauthorization Amendments of 1990 (CZARA), and Federal Highway Administration (FHWA) guidelines.

#### **7.1.1 SDWA**

Class V wells are regulated under the authority of Part C of SDWA. Congress enacted the SDWA to ensure protection of the quality of drinking water in the United States, and Part C specifically mandates the regulation of underground injection of fluids through wells. USEPA has promulgated a series of UIC regulations under this authority. USEPA directly implements these regulations for Class V wells in 19 states or territories (Alaska, American Samoa, Arizona, California, Colorado, Hawaii, Indiana, Iowa, Kentucky, Michigan, Minnesota, Montana, New York, Pennsylvania, South Dakota, Tennessee, Virginia, Virgin Islands, and Washington, DC). USEPA also directly implements all Class V UIC programs on Tribal lands. In all other states, which are called Primacy States, state agencies implement the Class V UIC program, with primary enforcement responsibility.

Storm water drainage wells currently are not subject to any specific regulations tailored just for them, but rather are subject to the UIC regulations that exist for all Class V wells. Under 40 CFR 144.12(a), owners or operators of all injection wells, including storm water drainage wells, are prohibited from engaging in any injection activity that allows the movement of fluids containing any

contaminant into USDWs, “if the presence of that contaminant may cause a violation of any primary drinking water regulation . . . or may otherwise adversely affect the health of persons.”

Owners or operators of Class V wells are required to submit basic inventory information under 40 CFR 144.26. When the owner or operator submits inventory information and is operating the well such that a USDW is not endangered, the operation of the Class V well is authorized by rule. Moreover, under section 144.27, USEPA may require owners or operators of any Class V well, in USEPA-administered programs, to submit additional information deemed necessary to protect USDWs. Owners or operators who fail to submit the information required under sections 144.26 and 144.27 are prohibited from using their wells.

Sections 144.12(c) and (d) prescribe mandatory and discretionary actions to be taken by the UIC Program Director if a Class V well is not in compliance with section 144.12(a). Specifically, the Director must choose between requiring the injector to apply for an individual permit, ordering such action as closure of the well to prevent endangerment, or taking an enforcement action. Because storm water drainage wells (like other kinds of Class V wells) are authorized by rule, they do not have to obtain a permit unless required to do so by the UIC Program Director under 40 CFR 144.25. Authorization by rule terminates upon the effective date of a permit issued or upon proper closure of the well.

Separate from the UIC program, the SDWA Amendments of 1996 establish a requirement for source water assessments. USEPA published guidance describing how the states should carry out a source water assessment program within the state’s boundaries. The final guidance, entitled *Source Water Assessment and Programs Guidance* (USEPA 816-R-97-009), was released in August 1997.

State staff must conduct source water assessments that are comprised of three steps. First, state staff must delineate the boundaries of the assessment areas in the state from which one or more public drinking water systems receive supplies of drinking water. In delineating these areas, state staff must use “all reasonably available hydrogeologic information on the sources of the supply of drinking water in the state and the water flow, recharge, and discharge and any other reliable information as the state deems necessary to adequately determine such areas.” Second, the state staff must identify contaminants of concern, and for those contaminants, they must inventory significant potential sources of contamination in delineated source water protection areas. Class V wells, including storm water drainage wells, should be considered as part of this source inventory, if present in a given area. Third, the state staff must “determine the susceptibility of the public water systems in the delineated area to such contaminants.” State staff should complete all of these steps by May 2003 according to the final guidance.<sup>2</sup>

---

<sup>2</sup> May 2003 is the deadline including an 18-month extension.



Another relevant program, established by §1424(e) of the SDWA, is the Sole Source Aquifer (SSA) program. The statute provides that any person may petition USEPA, or the USEPA Administrator may determine, that an area has an aquifer which is the sole or principal drinking water source for the area, and which, if contaminated, would create a significant hazard to public health. Following such a determination, no commitment for federal financial assistance (through a grant, contract, loan guarantee, or other means) may be entered into for any project that the USEPA Administrator determines may contaminate the aquifer through a recharge zone so as to create a significant hazard to public health. Sixty-nine SSAs have been designated since the provision was enacted in 1974, with the latest designated in July 1998.

Some USEPA Regions have used this Sole Source Aquifer provision to help implement the UIC Program (Terada, 1999). For example, USEPA Region 10 reviews construction and development projects that receive Federal Highway Administration (FHWA) funds for potential impacts to sole source aquifers, particularly from storm water drainage wells. USEPA Region 10 has had a 90-95 percent success rate in getting projects not to use dry wells for storm water disposal (Terada, 1999).

#### 7.1.2 CWA

In 1972, the CWA amended the Federal Water Pollution Control Act and prohibited the discharge of any pollutant into waters of the U.S. from a point source unless the discharge is authorized by a NPDES permit. The NPDES permitting program is designed to track point sources, monitor the discharge of pollutants from specific sources to surface waters, and to require the implementation of controls necessary to minimize the discharge of pollutants (USEPA, 1999e).

Because the NPDES program is focused on point source discharges to surface waters, Class V wells are not included within its scope. However, the NPDES Storm Water Program contains provisions specifically relating to reducing pollutants in storm water runoff, and thus may indirectly reduce the threat of ground water contamination through Class V storm water drainage wells.

Initial efforts to improve water quality under the NPDES program primarily focused on reducing pollutants in industrial process wastewater and discharges from municipal sewage treatment plants. As pollution control measures for these sources were implemented and refined, studies showed that more diffuse sources of water pollution were also significant causes of water quality impairment, specifically storm water runoff. Therefore, in 1987, the CWA was amended by Congress to require implementation of a comprehensive national program for addressing problematic non-agricultural sources of storm water discharges. The NPDES program is being implemented in two phases.

Phase I of the NPDES Storm Water Program targets the most likely sources of wet weather pollution: medium and large municipal separate storm water systems (MS4s) and eleven categories of industrial activity including construction in areas of five acres or greater. These regulated entities must obtain an NPDES storm water permit and implement storm water pollution prevention plans (SWPPPs) or storm water management programs, both using BMPs, that effectively reduce or prevent

the discharge of pollutants into receiving waters (USEPA, 1999e). Section 6.3.2 discusses SWPPPs in more detail

Phase II of the NPDES Storm Water Program targets small MS4s (any MS4 not covered by Phase I) in urbanized areas and construction activity covering areas between one and five acres. Additional small MS4s and smaller construction sites may be brought into the NPDES Storm Water Program by the NPDES permitting authority. The requirements for these regulated entities are similar to those for Phase I (USEPA, 1999e).

### 7.1.3 CZMA and CZARA

The CZMA does not contain language specific to storm water, but does address nonpoint pollution. Section 306(d)(16) of the CZMA requires state coastal zone management programs to contain enforceable policies and mechanisms to implement the applicable requirements of the coastal nonpoint programs. In order to satisfy this requirement, states adopt, at a minimum, enforceable policies and mechanisms to implement the guidance management measures and the additional management measures. These enforceable policies and mechanisms may be state and local regulatory controls, and/or non-regulatory incentive programs combined with state enforcement authority.

The CZMA Reauthorization Amendment – Coastal Nonpoint Pollution Control Program also addresses nonpoint pollution. Section 6217 requires states to establish coastal nonpoint programs, which must be approved by both the National Oceanic and Atmospheric Administration (NOAA) and USEPA. Once approved, the coastal nonpoint programs will be implemented through changes to the state nonpoint source pollution program approved by USEPA under section 319 of the CWA and through changes to the state coastal zone management program approved by NOAA under section 306 of the CZMA. Beginning in fiscal year 1996, states that fail to submit an approvable coastal nonpoint program to NOAA and USEPA face statutory reductions in federal funds awarded under both section 306 of the CZMA and section 319 of the CWA. However, Section 6217 excludes all storm water discharges covered by Phase I of the NPDES, and any storm water discharges that become covered by NPDES will be exempt from the coastal nonpoint pollution control program when an NPDES permit is issued.

Guidance prepared by NOAA and USEPA on implementation of the Coastal Nonpoint Pollution Control Program concentrates on nonpoint sources and does not address storm water drainage wells directly. It recommends management measures for agriculture, forestry, urban areas, and marinas. The chapter devoted to urban nonpoint sources discusses over a dozen management measures including measures for situations that would appear to qualify as storm water drainage wells (e.g., septic systems functioning as onsite disposal systems (OSDS) for storm water). The guidance discusses the requirement to maintain protective separation between such OSDS and the ground water table. However, the guidance does not discuss the system's potential impacts on or capacity for protection of ground water. It is intended for reference use and presents recommended management measures rather than enforceable standards for the protection of USDWs. In addition, the guidance

pertains only to those areas included in a coastal state's nonpoint program (i.e., its section 6217 management area) (USEPA, 1993b).

#### 7.1.4 FHWA Guidance

Guidance prepared by FHWA on management of highway runoff water quality discusses wet and dry detention basins, infiltration trenches, infiltration basins, dry wells, and other BMPs for controlling runoff. Some configurations of these systems could include perforated piping that would appear to qualify as a Class V storm water drainage well (e.g., dry wells consisting of vertical perforated pipe within pits backfilled with stone or gravel). The guidance addresses the pollutant removal capabilities of these systems with tables showing pollutant removal rates and limiting factors for different types of infiltration trenches. It also specifies the distance that the bottom of the trench, dry well, or other structure be constructed from the ground water table. However, the guidance does not discuss the system's potential impacts on ground water or capacity for protection of ground water. Although its purpose is to present the available and appropriate tools for predicting and mitigating highway storm water impacts for use during highway project planning and development activities, it is intended for reference use only and presents recommended BMPs rather than enforceable standards for the protection of USDWs (U.S. Department of Transportation, 1996).

## 7.2 **State and Local Programs**

Storm water drainage wells are managed or regulated by a variety of means, ranging from broad guidelines with recommended BMPs to general or specific state or local permits to prohibition at the state or local level. Many local codes prohibit storm water drainage wells within buffer zones surrounding water bodies and wetlands. Setback distances from water supplies required in various state guidelines range from 50 to 400 feet (Cadmus, 1996). Counties may also establish design, construction, and BMP requirements or guidelines based on site-specific concerns. In California, for example, Regional Water Quality Control Boards, counties, and local jurisdictions play the greatest role in storm water regulation. Some of these local jurisdictions prohibit storm water drainage wells, others use permits to regulate such wells, and still others recommend BMPs. New York, in contrast, regulates through State Pollution Elimination System Permits, for wells posing threats to ground water, and through statewide general permits that emphasize BMPs for industrial and construction runoff. Some Direct Implementation states, of which Arizona is an example, also have ground water protection programs that may address storm water runoff wells. Some Primacy states, such as Florida, prohibit storm water drainage wells in regions of the State where they would drain directly into USDWs, but allow such wells where the ambient water is below USDW quality. Florida does allow storm water wells where fluids are discharged into low-quality aquifers. This practice occurs primarily in the Florida Keys and in the coastal areas of southeast Florida (Deurling, 1997). Specific state program descriptions included in Attachment A of this volume focus on those states in which the largest numbers of storm water drainage wells are documented and estimated.

The following states authorize storm water drainage wells by rule consistent with the existing federal UIC requirements: Illinois, Indiana, Michigan, Ohio, Wisconsin (prior to 1994 and less than 10

feet deep only, new wells banned), Montana, Wyoming, North Dakota, South Dakota, Utah, Colorado, Tennessee, Idaho (for wells less than 18 feet deep), Oregon, Washington, Rhode Island, and Kansas. The following states have a permit and registration system for storm water drainage wells: Arizona, Hawaii, Idaho (for wells greater than 18 feet deep), Alabama, Florida, Texas, New Hampshire, Maryland, and Nebraska. North Carolina, Georgia, Minnesota, and Wisconsin (since 1994) prohibit storm water drainage wells.

### **7.3 Survey of Local Storm Water Utilities**

A 1996 survey of 230 municipal utility jurisdictions conducted by the National Association of Flood and Stormwater Management Agencies received 101 responses. Of these, 11 utilities reduced their fee for collecting storm water runoff if sites generating the runoff used storm water controls (six for peak runoff controls, three for implementation of BMPs, and two for obtaining an industrial NPDES permit).

Of 29 local storm water ordinances provided and republished in the survey report, four contained operational requirements. One specified that the utility be provided copies of all plans, drainage studies, and evaluations; two required monitoring and reporting of discharges; and one included maintenance criteria. The balance of the local ordinances concentrated on establishing local storm water utilities, rates, and administrative procedures (NAFSMA, Survey of Local Stormwater Utilities, 1996).

## **ATTACHMENT A STATE AND LOCAL PROGRAM DESCRIPTIONS**

This attachment does not describe every state's program for storm water drainage wells; instead it focuses on the states where the largest numbers of storm water drainage wells are known to exist. The states covered in this attachment (Arizona, California, Florida, Idaho, Montana, New York, Ohio, Oregon, Utah, and Washington) contain a total of 62,958 documented (and 239,034 estimated) storm water drainage wells, accounting for 89 percent of the documented number (and 97 percent of the estimated number) of storm water drainage wells in the U.S.

### **Arizona**

USEPA Region 9 directly implements the UIC program for Class V injection wells in Arizona. In addition, under the State's ground water protection program, found in Arizona Revised Statutes (Title 49, Chapter 2, Article 3 - Aquifer Protection Permits), any facility that "discharges" is required to obtain an Aquifer Protection Permit (APP) from the Arizona Department of Environmental Quality (ADEQ) (§49-241.A). An injection well is considered a discharging facility and is required to obtain an APP, unless ADEQ determines that it will be "designed, constructed, and operated so that there will be no migration of pollutants directly to the aquifer or to the vadose zone" (§49-241.B). However, under Rule 18-9-102.A, drywells that are used solely to receive storm runoff, except those that drain areas in which hazardous substances are used, stored, loaded, or treated, are exempt from the APP requirements. For drywells used solely to receive storm runoff, ADEQ has established special requirements under the authority of Arizona Revised Statutes Title 49, Chapter 3, Article 8 - Dry Wells.

The aquifer protection statute provides that an applicant for an APP may be required to provide information on the design, operations, pollutant control measures, hydrogeological characterization, baseline data, pollutant characteristics, and closure strategy. Operators must demonstrate that the facility will be designed, constructed, and operated as to ensure that discharge will be reduced to the greatest degree and that aquifer water quality will not be reduced or standards violated. By rule, presumptive best available demonstrated control technology, processes, operating methods, or other alternatives, in order to achieve discharge reduction and water quality standards, are established by ADEQ (§49-243).

An APP may require monitoring, recordkeeping and reporting, contingency planning, discharge limitations, a compliance schedule, and closure guidelines. The operator may need to furnish information, such as past performance and technical and financial competence, relevant to its capability to comply with the permit terms and conditions. A facility must demonstrate financial assurance or competence before approval to operate is granted. Each owner of an injection well to whom an individual permit is issued must register the permit with ADEQ each year (§49-243).

ADEQ designates a point or points of compliance for each facility receiving an APP. The statute defines this point as the point at which compliance with aquifer water quality standards shall be

determined and in a vertical plane downgradient of the facility extending through the uppermost aquifer underlying that facility. If an aquifer is not, or reasonably will not foreseeably be a USDW, monitoring for compliance may be established in another aquifer. Monitoring and reporting requirements also may apply for a facility managing pollutants that are determined not to migrate (§49-244).

The requirements pertaining to dry wells that receive storm water runoff, but not from a hazardous waste area, specify that any person who owns an existing dry well that is, or has been, used for disposal must register the well on a registration form provided by ADEQ (§49-332). The ADEQ is authorized to adopt rules establishing standards for new and existing dry wells pertaining to performance, construction, design, closure, location, and inspection (§49-333). New dry well construction, including modifications to existing dry wells, must be performed by a well driller with a dry well driller's license (§49-333.C). The statute exempts from its requirements dry wells used in conjunction with golf course maintenance (§49-336).

### *Permitting*

The Arizona Aquifer Protection Permit Rules (Chapter 19, sub-chapter 9, October 1997) define an injection well as "a well which receives a discharge through pressure injection or gravity flow." Any facility that discharges is required to obtain an individual APP from ADEQ, unless the facility is subject to a general permit or it is a dry well used exclusively to dispose of storm water runoff. Permit applications must include specified information. This includes topographic maps, facility site plans and designs, characteristics of past as well as proposed discharge, and best available demonstrated control technology, processes, operating methods, or other alternatives to be employed in the facility. In order to obtain an individual permit, a hydrogeologic study must be performed. This study must include a description of the geology and hydrology of the area; documentation of existing quality of water in the aquifers underlying the site; any expected changes in the water quality and ground water as a result of the discharge; and the proposed location of each point of compliance (R18-9-108).

Owners of existing dry wells are required by the dry well statutory requirements to register the wells with ADEQ. No regulatory requirements pertaining to registration or permitting of dry wells have been promulgated by ADEQ.

By statute, a general permit covers facilities used solely for the management of storm water and that are regulated by the Clean Water Act, including catchments, impoundments and sumps, provided that the following conditions are met:

- An NPDES permit has been obtained for any storm water discharges at the facility and the facility has so notified ADEQ
- The facility has a storm water pollution prevention plan in place.

If ADEQ determines that discharges of storm water from a facility covered by the general permit are causing a violation of aquifer water quality standards, the general permit may be revoked and the facility required to obtain an individual permit under §49-243 (§49-245.01).

Wells that inject into the vadose zone, and inject only storm water mixed with reclaimed wastewater or ground water, from man-made bodies of water associated with golf courses, parks, and residential common areas, are also granted a general permit, provided that they meet the following conditions:

- The wells are registered pursuant to §49-332;
- The discharge occurs only in response to storm events;
- Water quality analysis, completed initially and at least semiannually, demonstrates compliance (except for microbiological contaminants) with aquifer water quality standards for the reclaimed wastewater;
- The vadose zone injection wells are located at least 100 feet from any water supply well;
- Vertical separation of at least 40 feet exists between the bottom of the vadose zone injection wells and the water table to allow the aquifer water quality standard for microbiological contaminants to be met in the uppermost aquifer; and
- The vadose zone injection wells are not used for any other purpose.

#### *Siting and Construction*

If an APP is required, no injection wells may be constructed unless the APP has been completed and approved. Wells are required to be constructed in such a manner as not to impair future or foreseeable use of aquifers. Specific construction standards are determined on a case-by-case basis.

ADEQ has not promulgated construction standards for dry wells. ADEQ has issued a document, "Guidance for Design, Installation, Operation, Maintenance, and Inspection of Dry Wells," that provides non-mandatory suggested standards and has established a Web site to provide guidance information.

#### *Operating Requirements*

Permit-specific operating requirements will be developed for wells required to obtain an APP. All wells must be operated in such a manner that they do not violate any rules under Title 49 of the Arizona Revised Statutes, including Article 2, relating to water quality standards, and Article 3, relating to APPs. Water quality standards must be met in order to preserve and protect the quality of waters in all aquifers for all present and reasonably foreseeable future uses.

Dry wells draining areas where hazardous substances are used, stored, loaded, or treated will be required by their APP to adopt specified operating practices. An ADEQ publication, "Best Management Practices Plan (BMPP) Guidance for Dry Wells Draining Areas Associated with Industrial Activities that Use, Store, Loan, or Treat Hazardous Substances" is available.

ADEQ has not promulgated operating requirements for dry wells that do not drain areas involving hazardous substances. ADEQ has issued a document, "Guidance for Design, Installation,

Operation, Maintenance, and Inspection of Dry Wells,” that provides non-mandatory suggested standards and has established a Web site to provide guidance information.

### *Monitoring Requirements*

Storm water wells, including dry wells, required to have an APP will have monitoring requirements specified in the APP to ensure compliance with APP conditions. Monitoring may include both injectate monitoring and monitoring of the injection site. The permit establishes, on a case-by-case basis, alert levels, discharge limitations, monitoring, reporting, and contingency plan requirements. Alert level is defined as a numeric value, expressed either as a concentration of a pollutant or a physical or chemical property of a pollutant, which serves as an early warning indicating a potential violation of any permit condition. If an alert level or discharge limitation is exceeded, an individual permit requires the facility to notify ADEQ and implement the contingency plan (R18-9-110).

Dry wells covered by the general permit may not violate aquifer water quality standards, and if the ADEQ determines there is a “reasonable probability” of such violation the general permit may be revoked, but no explicit monitoring requirements are included in the general permit provisions.

### *Plugging and Abandonment*

For wells subject to an APP, temporary cessation, closure, and post-closure requirements are specified on a case-by-case basis. The facilities are required to notify ADEQ before any cessation of operations occurs. A closure plan is required for facilities that cease activity without intending to resume. The plan describes the quantities and characteristics of the materials to be removed from the facility; the destination and placement of material to be removed; quantities and characteristics of the material to remain; the methods to treat and control the discharge of pollutants from the facility; and limitations on future water uses created as a result of operations or closure activities. A post-closure monitoring and maintenance plan is also required. This plan specifies duration, procedures, and inspections for post-closure monitoring (R-18-9-116).

### *Financial Assurance*

For wells subject to an APP, the permit requires that a owner have and maintain the technical and financial capability necessary to fully carry out the terms and conditions of the permit. The owner must maintain a bond, insurance policy, or trust fund for the duration of the permit (R-18-9-117).

## **California**

USEPA Region 9 directly implements the UIC program for Class V injection wells in California. The California Water Quality Control Act (WQCA), however, establishes broad requirements for the coordination and control of water quality in the State, sets up a State Water Quality Control Board, and divides the State into nine regions, with a Regional Water Quality Control Board (RWQCB) that is delegated responsibilities and authorities to coordinate and advance water



quality in each region (Chapter 4 Article 2 WQCA). A RWQCB can prescribe requirements for discharges (waste discharge requirements or WDRs) into the waters of the State (13263 WQCA). These WDRs can apply to injection wells (13263.5 and 13264(b)(3) WQCA). The statute provides that no discharge of waste into the waters of the State, even if pursuant to a WDR, creates a vested right to continue the discharge (13263(g) WQCA). This provision is interpreted as creating authority to require the closing of storm water drainage wells. In addition, the WQCA specifies that no provision of the Act or ruling of the State Board or a Regional Board is a limitation on the power of a city or county to adopt and enforce additional regulations imposing further conditions, restrictions, or limitations with respect to the disposal of waste or any other activity which might degrade the quality of the waters of the State (13002 WQCA).

### *Permitting*

RWQCBs have the authority under the WQCA to require a person proposing to operate an injection well (as defined in §13051 WQCA) to file a report of the discharge, containing the information required by the Regional Board, with the appropriate Regional Board (13260(a)(3) WQCA). Furthermore, the Regional Board, after any necessary hearing, may prescribe requirements concerning the nature of any proposed discharge, existing discharge, or material change in an existing discharge to implement any relevant regional water quality control plans. The requirements also must take into account the beneficial uses to be protected, the water quality objectives reasonably required for that purpose, other waste discharges, and the factors that the WQCA requires the Regional Boards to take into account in developing water quality objectives, which are specified in §13241 of the WQCA ((13263(a) WQCA). However, a Regional Board may waive the requirements in 13260(a) and 13253(a) as to a specific discharge or a specific type of discharge where the waiver is not against the public interest (13269(a) WQCA).

RWQCBs and other local jurisdictions have adopted storm water drainage well provisions in their basin plans or other requirements. Examples of such actions include the following:

- The San Francisco Bay RWQCB adopted the San Francisco Bay Basin Water Quality Control Plan amendment on Shallow Drainage Wells in 1992. It requires local agencies to develop a shallow drainage well control program consisting of locating existing wells and establishing a permitting program for new and existing wells.
- The Lahontan RWQCB issues WDRs to facilities with potential sources of pollutants in storm water runoff. The WDRs incorporate discharge specifications, BMPs, monitoring requirements, and spill contingency plans. The RWQCB also conducts inspections of sites.
- The Santa Clara Valley Water District adopted a Storm Water Infiltration Policy by ordinance. It is also incorporated in the Santa Clara County “Standards for the Construction and Destruction of Wells and Other Deep Excavations in Santa Clara County” (1989). The Water District has developed a special supplement on storm water infiltration devices (1993). It includes general siting and construction requirements and siting restrictions and prohibitions.

Storm water drainage well construction is allowed only in areas where the jurisdiction has adopted a Memorandum of Understanding with the Santa Clara Water District for a control program for storm water drainage wells. Setback distances, depth to the water table, and well marking procedures are specified. The storm water supplement also includes a section on materials and procedures discussing annular space sealing, surface construction features, and required reports. It provides destruction standards and special sealing standards.

- Yolo County regulates storm water drainage wells by ordinance. However, the County does not issue permits for storm water drainage wells. The County does not define storm water as “liquid waste” or “wastewater” and therefore its requirements pertaining to wastewater systems do not apply. The County does not require licensed drillers for the construction of drainage wells.
- Merced County by ordinance prohibits wells from receiving storm water. A permit is required from the County Health Officer prior to construction, reconstruction, deepening, abandonment, or destruction of any well or soil boring. The construction of dry/drainage wells, defined in part as a well constructed for the purpose of disposing of waste water or drainage water, is prohibited. The Health Officer may make exceptions if it can be shown that the quality of the water being introduced into the well will not have an undesirable impact on the ground water or the well’s construction will not permit the intermixing of aquifers or provide a conduit for the vertical movement of known or potential contaminants.
- Stanislaus County establishes standards for construction of dry wells by a policy document, which specifies setback distances and distances from the water table. The County public works staff inspects well installations.
- Riverside County flood control districts and building departments review plans and inspect storm water drainage facilities.

## **Florida**

Florida is a UIC Primacy State for Class V wells. Chapter 62-528 of the Florida Administrative Code (FAC), effective June 24, 1997, establishes the UIC program, and Part V (62-528.600 to 62-528.900) addresses criteria and standards for Class V wells. Class V wells are grouped into eight categories/groups for purposes of permitting. Storm water drainage wells and lake level control wells fall into Group 6.

### *Permitting*

Underground injection through a Class V well is prohibited except as authorized by permit by the Department of Environmental Protection (DEP). Owners and operators are required to obtain a Construction/Clearance Permit before receiving permission to construct. The applicant is required to submit detailed information, including well location and depth, description of the injection system and of

the proposed injectate, and any proposed pretreatment. When site-specific conditions indicate a threat to a USDW, additional information must be submitted. The State currently does not permit the construction of new storm water wells where fluids would be injected directly into a USDW, and therefore is not permitting new wells in the northwest and central regions (e.g., Orlando), while it will permit in the Florida Keys and coastal areas of Broward and Dade counties (e.g., the southeast).

Lake level control wells in Florida inject directly into a USDW and so the state has not permitted any new ones since receiving primacy in 1982. Replacement may be allowed under emergency conditions when methods to remediate an existing well were ineffective and it is determined that construction of the new well is essential to prevent flooding. If a new well is constructed, the old well must be plugged and abandoned (Cadmus, 1999).

### *Siting and Construction*

Specific construction standards for Class V wells have not been enacted by Florida, because of the variety of Class V wells and their uses. Instead, the State requires the well to be designed and constructed for its intended use, in accordance with good engineering practices, and approves the design and construction through a permit. The State can apply any of the criteria for Class I wells to the permitting of Class V wells, if it determines that without such criteria the Class V well may cause or allow fluids to migrate into a USDW and cause a violation of the State's primary or secondary drinking water standards, which are contained in Chapter 62-550 of the FAC. However, if the injectate meets the primary and secondary drinking water quality standards and the minimum criteria contained in Rule 62-520-400 of the FAC, Class I injection well permitting standards will not be required.

Class V wells are required to be constructed so that their intended use does not violate the water quality standards in Chapter 62-520 FAC at the point of discharge, provided that the drinking water standards of 40 CFR Part 142 (1994) are met at the point of discharge.

### *Operating Requirements*

All Class V wells are required to be used or operated in such a manner that they do not present a hazard to a USDW.

### *Monitoring Requirements*

Monitoring generally will be required for Group 6 wells, unless the wells inject fluids that meet the primary and secondary drinking water standards in 62-550 FAC and the minimum criteria in Rule 62-520, and the injection fluids have been processed through a permitted drinking water treatment facility (62-528.615 (1)(a)2 FAC). Monitoring frequency will be based on well location and the nature of the injectate and will be addressed in the permit.

### *Plugging and Abandonment*

The owner or operator of any Class V well must apply for a plugging and abandonment permit when the well is no longer used or usable for its intended purpose. Plugging must be performed by a licensed water well contractor.

### **Idaho**

Idaho is a UIC Primacy State for Class V wells and has promulgated regulations for the UIC program in the Idaho Administrative Code (IDAPA), Title 3, Chapter 3. Deep injection wells are defined as more than 18 feet in vertical depth below the land surface (37.03.03.010.11 IDAPA). Wells are further classified, with Class V Subclass 5D2 defined as storm runoff wells (37.03.03.025.01.g IDAPA).

### *Permitting*

Construction and use of shallow injection wells is authorized by rule, provided that inventory information is provided and use of the well does not result in unreasonable contamination of a drinking water source or cause a violation of water quality standards that would affect a beneficial use (37.03.025.03.d. IDAPA). Construction and use of Class V deep injection wells may be authorized by permit (37.03.03.025.03.c IDAPA). The regulations outline detailed specifications for the information that must be supplied in a permit application (37.03.03.035 IDAPA).

### *Operating Requirements*

Standards for the quality of injected fluids and criteria for location and use are established for rule-authorized wells, as well as for wells requiring permits. The rules are based on the premise that if the injected fluids meet MCLs for drinking water for physical, chemical, and radiological contaminants at the wellhead, and if ground water produced from adjacent points of diversion for beneficial use meets the water quality standards found in Idaho's "Water Quality Standards and Wastewater Treatment Requirements," 16.01.02 IDAPA, administered by the Idaho Department of Health and Welfare, the aquifer will be protected from unreasonable contamination. The State may, when it is deemed necessary, require specific injection wells to be constructed and operated in compliance with additional requirements (37.03.03.050.01 IDAPA (Rule 50)). Rule-authorized wells "shall conform to the drinking water standards at the point of injection and not cause any water quality standards to be violated at the point of beneficial use" (37.03.03.050.04.d IDAPA).

DEQ has prepared a guidance document entitled "Catalog of Storm Water Best Management Practices for Idaho Cities and Counties." As guidance, these BMPs are not mandatory.

Monitoring, recordkeeping, and reporting may be required if the State finds that the well may adversely affect a drinking water source or is injecting a contaminant that could have an unacceptable effect upon the quality of the ground waters of the State (37.03.03.055 IDAPA (Rule 55)).

### *Plugging and Abandonment*

The Idaho Department of Water Resources (IDWR) has prepared “General Guidelines for Abandonment of Injection Wells,” which are not included in the regulatory requirements. IDWR expects to approve the final abandonment procedure for each well.

### *Financial Responsibility*

No financial responsibility requirement exists for rule-authorized wells. Permitted wells are required by the permit rule to demonstrate financial responsibility through a performance bond or other appropriate means to abandon the injection well according to the conditions of the permit (37.03.03.35.03.e IDAPA).

## **Montana**

USEPA Region 8 directly implements the UIC program for Class V wells in Montana. No State regulations apply to storm water drainage wells. Local jurisdictions may regulate storm water drainage wells. For example, by city ordinance, Missoula prohibits construction of new storm water wells, defined as a structure, pit, or hole that primarily receives storm water runoff from paved areas, including, but not limited to, parking lots, streets, residential subdivisions, and highways (Missoula Valley Aquifer Protection Ordinance, §13.26.030.42). The city prohibits storm water injection wells within 50 feet of a community or non-transient non-community public water supply well (§13.26.090).

## **New York**

USEPA Region 2 directly implements the UIC program for Class V wells in New York. In addition, under the State’s Environmental Conservation Law, the Department of Environmental Conservation, Division of Water Resources (DWR) has promulgated regulations in the State Code Rules and Regulations, Title 6, Chapter X, Parts 703, 750 -758. These regulations establish water quality standards and effluent limitations, create a State Pollutant Discharge Elimination system (SPDES) requiring permits for discharges into the waters of the State, specify that such discharges must comply with the standards in Part 703, and provide for monitoring in Part 756.

### *Permitting*

New York has adopted two SPDES general permits for storm water discharges. They are the SPDES General Permit for Storm Water Discharges from Construction Activity, Permit No. GP-93-06 (August 1993) and SPDES General Permit for Storm Water Discharges Associated with Industrial Activity Except Construction Activity, Permit No. GP-98-03 (October 1998). These general permits are issued pursuant to Article 17, Titles 7 and 8 and Article 70 of the Environmental Conservation Law. To come under the coverage of the general permit, a discharger must submit a Notice of Intent, Transfer, or Termination.

Both general permits cover all areas of the State where New York implements § 402 of the Clean Water Act. Discharge is unlawful unless in compliance with the general permit or with an individual SPDES permit. Discharges other than storm water must be in compliance with a SPDES permit. Discharges mixed with sources of non-storm water other than those expressly authorized under the general permit or a different SPDES permit are prohibited.

The discharge authorized by the general permit may not cause or contribute to a violation of water quality standards in Parts 700 through 705 of Title 6 of the New York Code. Operators are required to submit a storm water pollution prevention plan, which must address housekeeping, equipment inspections, training, spill prevention and response, and reporting/ recordkeeping.

### *Operating Requirements*

Water quality standards must be met. The industrial general permit specifies additional requirements for storm water discharges associated with specifically listed industrial activities.

## **Ohio**

Ohio is a UIC Primacy State for Class V wells. Regulations establishing the UIC program are found in Chapter 3745-34 of the Ohio Administrative Code (OAC). Class V injection well definitions include drainage wells used to drain surface fluid, primarily storm runoff, into a subsurface formation (3745-34-04(E)(4) OAC).

### *Permitting*

Any underground injection, except as authorized by permit or rule, is prohibited. The construction of any well required to have a permit is prohibited until the permit is issued (3745-34-06 OAC).

Injection into Class V injection wells is authorized by rule (3745-34-13 OAC). However, a drilling permit and an operating permit are required for injection into a Class V injection well of sewage, industrial wastes, or other wastes, as defined in § 6111.01 of the Ohio Revised Code, into or above a USDW (3745-34-13 OAC and 3745-34-14 OAC). Therefore, if the storm water injectate is anticipated to exceed primary drinking water standards (MCLs) or health advisories (HALs), permits to install and operate the well are required.

Wells required to obtain an individual permit must submit detailed information, including location, formation into which the well is drilled, depth of well, nature of the injectate, and a topographical map showing the facility, other wells in the area, and treatment areas (3745-34-16(E) OAC).

### *Siting and Construction*

There are no specific regulatory requirements for the siting and construction of storm water drainage wells permitted by rule. Wells required to obtain an individual permit must submit siting information and construction records.

### *Operating Requirements*

There are no specific operating or monitoring requirements for storm water drainage wells permitted by rule. Injectate must meet drinking water standards at the point of injection, unless a permit allows otherwise. Permitted wells will have monthly and quarterly monitoring and reporting requirements (3745-34-26 (J) OAC). The State has developed a guidance on BMPs and distributed it to local jurisdictions. It includes design recommendations for siting of wells, elevation of points of entry, installation of standpipes and catch basins for sediment settling, drain markings to discourage dumping, and barriers around well entries. Other recommendations include public education, employee training, spill preparedness plans, measures to prevent sediment infiltration, and measures to eliminate disposal of pollutants through storm water wells.

## **Oregon**

Oregon is a UIC Primacy State for Class V wells. The UIC program is administered by the Department of Environmental Quality (DEQ). Under the State's Administrative Rules (OAR) pertaining to underground injection, a "waste disposal well" is defined as any bored, drilled, driven or dug hole, whose depth is greater than its largest surface dimension, which is used or is intended to be used for disposal of sewage, industrial, agricultural, or other wastes and includes drain holes, drywells, cesspools and seepage pits, along with other underground injection wells (340-044-0005(22) OAR). Construction and operation of a waste disposal well without a water pollution control facility (WPCF) permit is prohibited. Certain categories of wells are prohibited entirely, including wells used for underground injection activities that allow the movement of fluids into a USDW if such fluids may cause a violation of any primary drinking water regulation or otherwise create a public health hazard or have the potential to cause significant degradation of public waters. Oregon has established a groundwater protection goal of preventing contamination of the state's groundwater resource. This nondegradation goal is intended to protect groundwater more stringently than the use of drinking water standards would do.

### *Permitting*

Storm water drains from residential or commercial areas, which are not affected by toxic or industrial wastes, do not require a WPCF permit, but are required to satisfy the requirements in 340-044-0050 OAR (i.e., they may not be located closer than 500 feet from a domestic water well) (340-044-0015 OAR).

Storm water wells that constitute underground injection activity that may cause, or tend to cause, pollution of ground water must be approved by the DEQ, in addition to any other permits or approvals required by other federal, state, or local agencies (340-044-0055 OAR). Permits are not to be issued for construction, maintenance, or use of waste disposal wells where any other treatment or disposal method which affords better protection of public health or water resources is reasonably available or possible (340-044-0030 OAR). Such wells, unless absolutely prohibited, must obtain a WPCF permit (340-044-0035 OAR, 340-045-0015 OAR).

#### *Siting and Construction*

The requirements for waste disposal wells for surface drainage specify that such wells may only be used in those areas where there is an adequate confinement barrier or filtration medium between the well and a USDW, and where construction of surface discharging storm sewers is not practical.

New storm drainage disposal wells must be as shallow as possible but may not exceed a depth of 100 feet. They may not be located closer than 500 feet to a domestic water well (340-044-0050 OAR).

#### *Operating Requirements*

Using a waste disposal well for agricultural drainage is prohibited. Using such a well for surface drainage in areas where toxic chemicals or petroleum products are stored or handled is prohibited, unless there is containment around the product area which will prevent spillage or leakage from entering the well. A means of temporarily plugging or blocking a waste disposal well for storm drainage in the event of an accident or spill must be available. Any parking lot drained by waste disposal wells must be kept clean of petroleum products and other organic or chemical wastes as much as practicable to minimize the degree of contamination of the storm water drainage.

Oregon has prepared guidance, "Oregon Storm Water Management Guidelines (for Surface and Ground Waters," (1998) as well as "Department of Environmental Quality UIC Class V BMPs for Groundwater" (1998).

#### *Abandonment and Plugging*

Upon discontinuance of use or abandonment a waste disposal well is required to be rendered completely inoperable by plugging and sealing the hole.

## **Utah**

Utah is a UIC Primacy State for Class V wells. The Department of Environmental Quality has promulgated regulations addressing injection wells in R317-7 and R655-1-5 and R655-1-6 of the Utah Administrative Code (UAC). The rules incorporate by reference federal requirements in 40 CFR 144, 146, 148, 261, 142, 136 and 124 and 10 CFR Part 20 (R317-7-1 UAC). Drainage wells used



to drain surface fluid, primarily storm runoff, into a subsurface formation are defined as Class V wells (R317-7-3.3.5.C and D UAC).

### *Permitting*

Underground injection is prohibited except as authorized by permit or by rule. No injection may be authorized that endangers a drinking water source. An applicant has the burden of showing that injection will not result in the movement of fluid containing contaminants into a USDW or cause a violation of any primary drinking water regulation (R317-7-5 UAC). Existing and new Class V injection wells currently are authorized by rule (317-7-6.3 UAC).

### *Operating Requirements*

The State does not specify operating requirements for storm water drainage wells. It does recommend to local governments with numerous such wells that they set up local spill response teams. One local government in Utah, the City of Orem, through its storm water utility, charges for storm water discharges. The city also has prepared a BMP guidance document and offers credits toward utility charges for implementing BMPs.

## **Washington**

Washington is a UIC Primacy State for Class V wells. Chapter 173-218 of the Washington Administrative Code (WAC) establishes the UIC program. Under the program, the policy of the Department of Ecology (WDOE) is to maintain the highest possible standards to prevent the injection of fluids that may endanger ground waters which are available for beneficial uses or which may contain fewer than 10,000 mg/l TDS. Consistent with that policy, all new Class V injection wells that inject industrial, municipal, or commercial waste fluids into or above a USDW are prohibited (172-218-090(1) WAC ).

### *Permitting*

A permit must specify conditions necessary to prevent and control injection of fluids into the waters of the State, including all known, available, and reasonable methods of prevention, control, and treatment, applicable requirements in 40 CFR Parts 124, 144, 146, and any conditions necessary to preserve and protect USDW. Any injection well that causes or allows the movement of fluid into a USDW that may result in a violation of any primary drinking water standard under 40 CFR Part 141 or that may otherwise adversely affect the beneficial use of a USDW is prohibited (173-218-100 WAC). The State's Waste Discharge Permit Program, which prohibits the discharge of pollutants into waters of the State (which include ground water) without a permit (Chapter 173-216 WAC) does not apply to the injection of fluids through wells which are regulated by the UIC control program (173-216-010 WAC). Storm water wells that conform to Best Management Practices stipulated by WDOE are considered to be "non-polluting" and are permitted.

### *Siting and Construction*

The DEQ has developed guidance for the Puget Sound Basin, "Storm Water Management for the Puget Sound Basin: the Technical Manual," (1992) and held training workshops for local government staff. The guidance describes recommended construction and siting by individual facility design. It recommends that infiltration facilities on commercial and industrial sites be no closer than 100 feet to drinking water wells, septic tanks or drainfields, and springs used for drinking water supplies. The guidance recommends that such facilities be at least 20 feet downslope and 100 feet upslope from building foundations and that the maximum slope for siting of infiltration facilities be limited.

The State has promulgated minimum standards for construction and maintenance of wells (173-160-010 through -560 WAC). However, injection wells regulated under Chapter 173-218 are specifically exempted from these constructions standards (173-160-010(3)(e) WAC). Storm water drainage wells are specifically identified as exempt from the well construction requirements.

Operators of such facilities must prepare a soils report, conduct periodic monitoring, and log the speed at which the facility dewater after large storms. They are also required to submit complete records describing construction or alteration of a well (173-160-050 and 173-160-055 WAC).

Wells are required to be planned and constructed to be adapted to the geologic and ground water conditions at the well site and designed to facilitate conservation of ground water (173-160-065 WAC).

### *Operating Requirements*

The water quality standards for ground waters establish an antidegradation policy. The injectate must meet the State ground water standards at the point of compliance (173-200-030 WAC).

### *Plugging and Abandonment*

All wells not in use must be securely capped so that no contamination can enter the well (173-160-085 WAC).

## REFERENCES

- 63 Federal Register 40585-40619. July 29, 1998. 40 CFR Parts 144, 145, and 146. Class V Injection Wells Underground Injection Control Regulations, Revisions; Proposed Rule.
- Agency for Toxic Substances and Disease Registry (ATSDR). 1999. Toxicity Frequently Asked Questions (ToxFAQs) Fact Sheets. Atlanta, GA: Agency for Toxic Substances and Disease Registry, Division of Toxicology. <http://www.atsdr.cdc.gov/tfacts.html>. April 1999.
- Agency for Toxic Substances and Disease Registry (ATSDR). 1999. Public Health Statements. Atlanta, GA: Agency for Toxic Substances and Disease Registry, Division of Toxicology. <http://www.atsdr.cdc.gov/ToxProfiles>. April 1999.
- Agency for Toxic Substances and Disease Registry (ATSDR). 1999. Toxicity Frequently Asked Questions (ToxFAQs) Fact Sheets. Atlanta, GA: Agency for Toxic Substances and Disease Registry, Division of Toxicology. <http://www.atsdr.cdc.gov/tfacts.html>. March 1999.
- American National Standards Institute (ANSI). 1993. Standard Guidelines for Operation and Maintenance of Urban Subsurface Drainage. ANSI/ASCE 14-93. New York: American Society of Civil Engineers.
- Arizona Department of Environmental Quality. 1998. Best Available Demonstrated Control Technology (BADCT) Guidance Document for Domestic and Municipal Wastewater Treatment. Draft. Water Quality Division, Aquifer Protection Program.
- Arizona Department of Water Resources. 1993. Drywell Recharge and Contaminant Loading in Metropolitan Phoenix, Arizona. Phoenix, AZ.
- Arizona Department of Environmental Quality. 1988. Dry Wells in Arizona - A Report to the Arizona Legislature. Phoenix, AZ. Hydrologic Report No. 1, Kafura, C.J.
- Bannerman, R.T., D.W. Owens, R.B. Dodds, and N.J. Hornewer. 1993. "Sources of Pollutants in Wisconsin Stormwater," Water Science and Technology. Volume 26, Number 3-5: 241-259.
- Beech, R.M. and A.F. Drake. 1992. "Designing an Effective Communication Program: A Blueprint for Success." USEPA/University of Michigan, September 1992.
- Bradner, L.A. 1991. Water Quality in the Upper Floridan Aquifer in the Vicinity of Drainage Wells, Orlando, Florida. Water Resources Investigations Report 90-4175. Tallahassee, Florida: US Geological Survey.

Bradner, L.A. 1996. Estimation of Recharge Through Selected Drainage Wells and Potential Effects from Well Closure, Orange County, Florida. Open File Report 96-316. Denver, Colorado: U. S. Geological Survey, Branch of Information Services.

Brown and Caldwell Consulting Engineers. 1986. Evaluation of Sump Impacts on Ground Water in East Multnomah County. Portland, OR.

The Cadmus Group. 1991. Storm Water Drainage Wells (5D2). Waltham, MA.

The Cadmus Group. 1996. Storm Water Drainage Well Guidance - Draft. Waltham, MA.

The Cadmus Group. 1999. State-by-State Notebooks Compiling Results from the Class V Underground Injection Control Study. February 1, 1999.

California State Department of Transportation. 1980. Prepared for Federal Highway Administration. Underground Disposal of Storm Water Runoff Design Guidelines Manual. PB83-180257.

Campbell, L.J. 1985. An Assessment of Shallow Injection Wells in Idaho. Idaho Department of Water Resources, February 1985.

City of Orlando. 1994. City of Orlando Drainage Well Protection Plan. Public Works Department.

Delzer, G., J. Zogorski, T. Lopes, and R. Bosshart. 1996. "Occurrence of the Gasoline Oxygenate MTBE and BTEX Compounds in Urban Storm Water in the United States, 1994 -1995." US Geological Survey Water Resources Investigations Report 96. [Denver, CO]: US Geological Survey.

Deuerling, R. 1997. Florida Department of Environmental Regulations. Personal Communication to Anhar Karimjee, Office of Water, US Environmental Protection Agency, November 1997, Tallahassee, FL.

Duchene, M., E. McBean, and N. Thomson. 1994. "Modeling of Infiltration from Trenches for Storm Water Control." Journal of Water Resources Planning and Management. 120: 3: 276-293.

Elder, J.R. and S.K. Lowrance. 1992. Directors, USEPA Office of Ground Water and Drinking Water USEPA Office of Solid Waste (respectively). Classification of Infiltration Galleries Under the UIC and RCRA Programs. Memorandum to USEPA Region 1-10 Water Management Division Directors and Hazardous Waste Management Division Directors.

German, E.R. 1989. Quantity and Quality of Stormwater Runoff Recharged to the Floridan Aquifer System Through Two Drainage Wells in the Orlando, Florida, Area. US Geological Survey Water-Supply Paper 2344, 51 p.

Haney, J., M. Leach, and L. Sobchak. 1989. Dry Wells – Solution or Pollution? An Arizona Status Report. Arizona Department of Environmental Quality, Phoenix, Arizona.

Hopeck, J. 1997. “Adverse Impacts on Ground Water Quality from Stormwater Infiltration at Two Sites in Southern Maine.” Maine Department of Environmental Protection, Bureau of Land and Water Quality, Maine.

Idaho Bureau of Mines and Geology. 1970. Abegglen, D., A. Wallace, and R. Williams. The Effects of Drain Wells on the Ground-water Quality of the Snake River Plain. [Boise, ID]: Pamphlet Number 148.

Idaho Department of Water Resources. Storm Water Injection Wells. [Boise, ID].

Kansas Department of Health & Environment. 1986. Correspondence provided by Larry Knoche, Bureau of Environmental Remediation, dated Nov., Dec., 1986.

Kimrey, J.O. and L.D. Fayard. 1984. Geohydrologic Reconnaissance of Drainage Wells in Florida. Tallahassee, Florida: Geological Survey, Water Resources Division.

Kobriger, N.P., T.L. Meinholz, M.K. Gupta, and R.W. Agnew. 1981. Constituents of highway runoff, Vol. III, Predictive procedure for determining pollutant characteristics in highway runoff: Federal Highway Administration Report, FHWA/RD-81/044, 197 p.

Kobriger, N.P. 1984. Sources and migration of highway runoff pollutants, Volume I: Executive Summary. Federal Highway Administration Report, FHWA/RD-84/057.

Lee, G.F. and S. Taylor. 1998. Development of Appropriate Storm Water Infiltration BMPs: Part 1: Potential Water Quality Impacts, Monitoring, and Efficacy Evaluation. In: Proceedings of the 1998 Ground Water Protection Council Annual Forum,” September 19-23, 1998, Sacramento, CA.

Malmquist, P. and S. Hard. 1981. Groundwater quality changes caused by stormwater infiltration. In: Proceedings of the Second International Conference on Urban Storm Drainage. Urbana, IL; June 15-19, 1981. Littleton, CO, Water Resources Publications. 595 p.

Marsh, J. 1993. “Assessment of Nonpoint Source Pollution Runoff in Louisville,” (Jefferson County) Kentucky, USA.” Archives of Environmental Contamination and Toxicology. Volume 25, Number 5, p. 446-55.

McKenzie, D. and G. Irwin. 1988. “Effects of Two Storm Water Management Methods on the Quality of Water in the Upper Biscayne Aquifer at Two Commercial Areas in Dade County, Fla.” US Geological Survey: Water Resources Investigations Report 88-4069. [Denver, CO.]: US Geological Survey.

Michael, E. 1997. St. Joseph County Health Dept. Letter to Alan Melcer, US Environmental Protection Agency, Underground Control Branch, Chicago, IL, September 18, 1997, Mishawaka, IN.

Miller, S. 1983. The Potential of Ground Water Impacts Resulting from Storm Water Runoff Disposal in Spokane County, Final Project Report, Water Quality Management Planning Grant G 83087, Spokane County Cooperation with the Washington Department of Ecology, Spokane, Washington, as cited in Miller, S.A. and B. Galle (1996). "Identification of Ground Water Impacts from Storm Water Injection and Infiltration Using Direct and Indirect Methods." In Proceedings of the 1996 Ground Water Protection Council Annual Forum. September 22-25, 1996, St. Paul, Minnesota, pp. 11-20.

Miller, S. 1987. The Treatment Effectiveness of Alternative Cover Materials in Storm Runoff Infiltration Basins, Final Project Report, Water Quality Management Planning Grant G-86-046, Spokane County in Cooperation with the Washington Department of Ecology, Spokane, Washington, 25 pp.

Miller, S. and W. Galle. 1996. "Identification of Ground Water Impacts from Storm Water Injection and Infiltration using Direct and Indirect Methods." In: Proceedings of the 1996 Ground Water Protection Council Annual Forum. September 22-25, 1996, St. Paul, Minnesota, pp.11-20.

Morton, L.B. 1987. "Ground Water Contamination Potential of Drainage Wells in Utah: A Preliminary Assessment." In: Proceedings of the International Symposium on Class V Injection Well Technology. 87-119. Underground Injection Practices Council, Inc.

New Jersey Department of Environmental Protection and Department of Agriculture. 1994. Storm Water and Nonpoint Source Pollution Control, December.

Nussbaum, J.C. 1991. Urban Storm Water Runoff and Ground-Water Quality. USEPA Office of the Administrator. Report No. 101/F-90/046.

Oregon Department of Environmental Quality. 1997. Lower Platte South Natural Resources District. Manual of Erosion and Sediment Control and Storm Water Management Standards. In: Draft Literature Review on Storm Water Impacts on Ground Water.

Orr, V. J. 1990. Wellhead Protection - Lessons Learned. Underground Injection Practices Council, Summer Meeting, July 22-25, 1990.

Orr, V. J. 1993. "Wellhead Protection - Lessons Learned." Journal of Applied Ground Water Protection, Volume 1, Number 1.

Pitt, R., M. Lalor, R. Field, D. Adrian, and D. Barbe. 1993. Investigation of Inappropriate Pollutant Entries into Storm Drainage System: A User's Guide. [Washington, DC]: US Environmental Protection Agency, Risk Reduction Engineering Laboratory, Office of Research and Development.

Pitt, R., S. Clark, and K. Parmer. 1994. Potential Ground Water Contamination from Intentional and Non-Intentional Stormwater Infiltration-1993 Research Report. [Washington, DC]: University of Alabama at Birmingham and US Environmental Protection Agency, Risk Reduction Engineering Laboratory.

Pitt, R., S. Clark, K. Parmer, and R. Field. 1996. Ground Water Contamination from Stormwater Infiltration. [Chelsea, MI]: Ann Arbor Press.

Pitt, R. 1998. Epidemiology and Stormwater Management. In Stormwater Quality Management. CRC/Lewis Publishers. New York, NY.

Resnick, S. and K. DeCook. 1983. Hydrological and Environmental Controls on Management on Semiarid Urban Areas - Phase II. University of Arizona. Project Completion Report B-023-ARIZ.

Rochotte, M.L. 1997. Ohio Environmental Protection Agency. Personal Communication to Anhar Karimjee, Office of Water, US Environmental Protection Agency, November 1997, Columbus, OH.

Roth, R. 1998. Wisconsin Department of Natural Resources. Personal communication with The Cadmus Group, Inc. October 1998.

Rutledge, A.T. 1987. Effects of land use on groundwater quality in central Florida – preliminary results. US Geological Survey Toxic Waste - Ground Water Contamination Program: US Geological Survey Water Resources Investigations Report 86-4163. 49 p.

San Francisco Bay Region Water Quality Control Plan. No date.

Santa Clara Valley Water District. 1993. Santa Clara Valley Water District Well Standards. Supplement to “Standards for the Construction and Destruction of Wells and Other Deep Excavations in Santa Clara County.” August 1993.

Scheuler, T., P. Kumble, and M. Heraty. 1992. “A Current Assessment of Urban Best Management Practices: Techniques for Reducing Nonpoint Source Pollution in the Coastal Zone.” [Washington, DC]: Metropolitan Washington Council of Governors. Prepared for the USEPA, Office of Wetlands, Oceans and Watersheds.

Schueler, T. and D. Shepp. “Hydrocarbon Hotspots in the Urban Landscape.” Department of Environmental Programs, Metropolitan Washington Council of Governments, Washington, DC

Schueler, T. 1999. Microbes and Urban Watersheds: Concentrations, Sources, and Pathways. Watershed Protection Techniques. 3(1): pp. 554 - 565.

Schiffer, D. 1989. "Effects of Three Highway Runoff Detention Methods on Water Quality of the Surficial Aquifer System in Central Florida." US Geological Survey: Water Resources Investigations Report 88-4170. [Denver, CO.].

Schmidt, K. 1985. Results of Dry Well Monitoring Project for a Commercial Site in the Phoenix Urban Area. [Phoenix, AZ]: Maricopa Association of Governments.

Schmidt, S. and D. Spencer. 1986. "The Magnitude of Improper Waste Discharges in an Urban Storm Water System," Journal Water Pollution Control Federation (Volume 58, No. 87), as cited in Pitt, R., M. Lalor, R. Field, D. Adrian, and D. Barbe. 1993. Investigation of Inappropriate Pollutant Entries Into Storm Drainage System: A User's Guide. [Washington, DC]: US Environmental Protection Agency, Risk Reduction Engineering Laboratory, Office of Research and Development.

Seitz, A., M. La Sala, and J. R. Moreland. 1977. Effects of Drain Wells on the Ground-Water Quality of the Western Snake Plain Aquifer, Idaho. Idaho: United States Department of the Interior, US Geological Survey.

Shaw, B. and J. Berndt. 1990. An Assessment of the Impact of Stormwater Disposal Wells on Groundwater Quality. Stevens Point, WI: University of Wisconsin.

Shiner, G.R. and E.R. German. 1983. Effects of Recharge from Drainage Wells on Quality of Water in the Floridan Aquifer in the Orlando Area, Central Florida. US Geological Survey, Water Resources Investigations Report 82-4094, 124 p.

Squillace, P., J. Zogorski, W. Wilber, and C. Price. 1996. "Preliminary Assessment of the Occurrence and Possible Sources of MTBE in Ground Water in the United States, 1993-1994." Environmental Science and Technology, Volume 30, Number 5.

Storm Water Infiltration Device (SWID) Destruction and Closure. Santa Clara Valley Water District.

Streaker, E., B. Wu, and M. Lanelli. 1997. Analysis of Urban Runoff Water Quality Monitoring Data Collected from 1990 to 1996. Portland, OR: Woodward-Clyde Consultants. Prepared for The Oregon Association of Clean Water Agencies.

Terada, C. 1999. Environmental Protection Agency. Ground Water Protection Unit, USEPA Region 10. Telephone Conversation with Robert Noecker, ICF Consulting. August 11, 1999.

U.S. Agency for Toxic Substances and Disease Registry. 1989. Health Assessment for McChord Air Force Base. Tacoma Pierce County, Washington, USEPA Region 10. P1390-119454. January 1989.



U.S. Department of Transportation. 1996. Federal Highway Administration, Office of Environment and Planning, *Evaluation of Management of Highway Runoff Water Quality*, FHWA-PD-96-032, June 1996.

USEPA. 1983. Water Planning Division. Results of the Nationwide Urban Runoff Program - Volume 1, Final Report. [Washington, DC], USEPA P1384-185552.

USEPA. 1984. National Secondary Drinking Water Regulations. USEPA Publication No. 570/9-76-000.

USEPA. 1987. Report to Congress: Class V Injection Wells. USEPA 570/9-87-006. Washington, DC: US Environmental Protection Agency, Office of Water, September 1987.

USEPA. 1992. Storm Water Management for Industrial Activities, USEPA 832-R-92-006, Office of Water, September 1992.

USEPA. 1993a. Health Advisories for Drinking Water Contaminants. Office of Water Health Advisories. Lewis Publishers, Ann Arbor, Michigan.

USEPA. 1993b. Guidance Specifying Management Measures for Sources of Nonpoint Pollution in Coastal Waters, Office of Wetlands, Oceans, and Watersheds, January 1993.

USEPA. 1995a. National Primary Drinking Water Regulations Contaminant Specific Fact Sheets Inorganic Chemicals - Technical Version. Washington, DC: Office of Water, Office of Ground Water and Drinking Water. USEPA 811-95-002-T. <http://www.epa.gov/OGWDW/dwh/t-ioc.html>. October 1995.

USEPA. 1995b. Report to Congress - Storm Water Discharges Potentially Addressed by Phase II of the National Pollutant Discharge Elimination System Storm Water Program. USEPA 833-K-94-002, March 1995.

USEPA. 1996a. Drinking Water Regulations and Health Advisories. Office of Water. USEPA 822-B-96-002.

USEPA. 1996b. Guidance on Storm Water Drainage Wells - Draft for Review, Office of Ground Water & Drinking Water. September 1996.

USEPA. 1997. Superfund Web Site. Available at:  
<http://www.epa.gov/superfund/oerr/impm/products/rodsites> and  
<http://www.epa.gov/superfund/oerr/impm/products/Cursites/cercinf.htm>

USEPA. 1998a. National Primary Drinking Water Regulations. 40 CFR §141.32.

- USEPA. 1998b. National Secondary Drinking Water Regulations. 40 CFR §143.
- USEPA. 1998c. Storm Water Drainage Wells, Interim Final Guidance. Office of Ground Water and Drinking Water, September 1998.
- USEPA. 1999a. Health Effects Notebook for Hazardous Air Pollutants. Office of Air Quality and Planning Standards. <http://www.epa.gov/ttn/uatw/hapindex.html>. April 1999.
- USEPA. 1999b. Integrated Risk Information System (IRIS). Cincinnati, OH: Office of Research and Development, National Center for Environmental Assessment. <http://www.epa.gov/ngispgm3/iris/index.html>. March 1999.
- USEPA. 1999c. National Primary Drinking Water Regulations Technical Fact Sheets. Washington, DC: Office of Water, Office of Ground Water and Drinking Water. <http://www.epa.gov/OGWDW/hfacts.html>. April 1999.
- USEPA. 1999d. USEPA Region 5 UIC Program Web Page. Office of Ground Water and Drinking Water. <http://www.epa.gov/r5water/uic.html>. August 1999.
- USEPA. 1999e. USEPA National Pollutant Discharge Elimination System, Storm Water Program Web Page. Office of Water, Office of Wastewater Management. <http://www.epa.gov/owm/sw/about/index.htm>. September 1999.
- Vandike, J.E. and K. Hass. 1987. "Use of Storm Water Drainage Wells in Missouri." In: Proceedings of the International Symposium on Class V Injection Well Technology. 160-177. Underground Injection Practices Council, Inc.
- Washtenaw County Drain Commissioner. 1988. Huron River Pollution Abatement Project, Summary, as cited in Pitt, R., M. Lator, R. Field, D. Adrian, and D. Barbe. Investigation of Inappropriate Pollutant Entries into Storm Drainage System: A User's Guide. [Washington, DC]: US Environmental Protection Agency, Risk Reduction Engineering Laboratory, Office of Research and Development, 1993.
- Watroba, D. 1999. Florida Department of Environmental Protection. Telephone conversation with Stephanie Barrett, ICF Consulting.
- Wilde, F. 1994. "Geochemistry and Factors Affecting Ground Water Quality at Three Storm Water Management Sites in Maryland." US Geological Survey Report of Investigations Number 59, [Washington, DC]: US Geological Survey.
- Wilson, L.G. 1983. A Case Study of Dry Well Recharge. University of Arizona: The Water Resources Research Center, Tucson, Arizona, September, 1983.

Wilson, L.G., M.D. Osborn, K.L. Olson, S.M. Maida, and L.T. Katz. 1989. The Ground-Water Pollution Potential of Dry Wells in Pima County, Arizona. University of Arizona: The Water Resources Research Center, Tucson, Arizona.

Wilson, L., R. Bassett, and R. Wallin. 1992. Depths of Storm-water Wells to Minimize Ground-Water Pollution. University of Arizona: Department of Hydrology and Water Resources, 1992.

Woessner, W. and K. Wogsland. 1987. "Effects of Urban Storm Water Injection by Class V Wells on a Potable Ground Water System." In: Proceedings of the International Symposium on Class V Injection Well Technology, 1987. Underground Injection Practices Council, Inc., pp. 137-159.

Woodward-Clyde Consultants. 1989. Santa Clara Valley Nonpoint Source Study, Volume II: Control Measure Report, Final Draft Report.