

2017

Potable Reuse Compendium



**CDM
Smith**



Office of Ground Water and Drinking Water
Office of Water
Washington, D.C. 20460

EPA/810/R-17/002



75 State Street
Suite 701
Boston, MA 02109

Preface

Appropriate and necessary treatment and reuse of wastewater to augment existing water resources is a rapidly expanding approach for both non-potable and potable applications. EPA recognizes that potable reuse of water can play a critical role in helping states, tribes, and communities meet their future drinking water needs with a diversified portfolio of water sources. Beginning with the first pioneers in water reuse, Los Angeles County Sanitation District (1962), Orange County Sanitation District (1976), and the Upper Occoquan Service Authority (1978), the practice has gained substantial momentum because of drought and the need to assure groundwater resource sustainability and a secure water supply. Long-term water scarcity is expected to increase over time in many parts of the country as a result of drought, growing water demand, and other stressors.

Across the U.S., there has been a notable increase in the deployment of technologies to augment existing water supplies through reuse of wastewater that has been treated and cleaned to be safe for the intended use. Indirect reuse usually involves passage of water through an environmental buffer (e.g., groundwater aquifer, lake, river) before the water is again treated for reuse. Direct reuse refers to those situations where treatment is followed by storage and use, but without the environmental buffer. Many drinking water systems rely on water treatment technologies to support indirect reuse of water (e.g., indirect potable reuse) and some drinking water systems now directly reuse wastewater after treatment (e.g., direct potable reuse).

In 2012, EPA published the *2012 Guidelines for Water Reuse* to serve as a reference on water reuse practices. The document provided information related to indirect potable reuse (IPR), but only briefly described direct potable reuse (DPR). Because of increased interest in pursuing potable water reuse, EPA is issuing the *2017 Potable Reuse Compendium* to outline key science, technical, and policy considerations regarding this practice. This 2017 Compendium supplements the *2012 Guidelines for Water Reuse* to inform current practices and approaches in potable reuse, including those related to direct potable water reuse. EPA recognizes the recent water reuse publications from our stakeholders at the World Health Organization (WHO), the National Research Council of the National Academies of Science, the Water Environment and Reuse Foundation (WE&RF), and the Water Environment Federation (WEF). The 2017 Compendium is a compilation of technical information on potable reuse practices to provide planners and decision-makers with a summary of the current state of the practice. Specific knowledge and experience are drawn from case studies on existing reuse approaches.

EPA supports water reuse as part of an integrated water resources management approach developed at the state and local level to meet the water needs of multiple sectors including agriculture, industry, drinking water, and ecosystem protection. An integrated approach commonly involves a combination of water management strategies (e.g., water supply development, water storage, water use efficiency, and water reuse) and engages multiple stakeholders and needs, including the needs of the environment.

Although EPA encourages an integrated approach to water resources management, it does not require or restrict practices such as water reuse. EPA acknowledges the primacy of states in the

allocation and development of water resources. EPA, State, and local governments implement programs under the Clean Water Act and the Safe Drinking Water Act to protect the quality of source waters to ensure that source water is treated so that water provided to the tap is safe for people to drink (e.g., contaminant specific drinking water standards). The SDWA and the CWA provide a foundation from which states can further develop and support potable water reuse as they deem appropriate.

EPA will continue to engage a broad spectrum of partners and stakeholders for input on where the Agency can provide meaningful support to states, tribes, and communities as they implement potable water reuse projects. EPA will also work with stakeholders, the scientific community, and the States to monitor and evaluate performance of water treatment technologies to ensure that potable reuse projects are implemented in a manner that protects the health of communities. This document is a collaborative effort between EPA, CDM Smith, and other key stakeholders. EPA acknowledges the importance of potable water reuse and looks forward to working with our stakeholders as the practice continues to be developed and deployed as an important approach to ensure a clean, safe, and sustainable water supply for the nation.

Peter Grevatt, PhD
Director
Office of Ground Water and Drinking Water
Office of Water
U.S. Environmental Protection Agency

Notice

This document was produced by the Environmental Protection Agency and CDM Smith Inc. (CDM Smith) under a Cooperative Research and Development Agreement (CRADA). It supplements the 2012 *Guidelines for Water Reuse* published by EPA in collaboration with the United States Agency for International Development (USAID) and CDM Smith. This document underwent EPA review and received approval for publication. Mention of trade names or commercial products does not constitute endorsement or recommendation for use.

The statutes and regulations described in this document may contain legally binding requirements. Neither the summaries of those laws provided here nor the approaches suggested in this document substitute for those statutes or regulations, nor is this document any kind of regulation. This document is solely informational and does not impose legally binding requirements on EPA; other U.S. federal agencies, states, local, or tribal governments; or members of the public. Any EPA decisions regarding a particular water reuse project will be made based on the applicable statutes and regulations. EPA will continue to review and update this document and the 2012 *Guidelines for Water Reuse* as necessary and appropriate.

Development of this Document

EPA and CDM Smith worked collaboratively under a Cooperative Research and Development Agreement (CRADA) (EPA-CDM CRADA 844-15) to produce the *2017 Potable Reuse Compendium* that assesses the current status of potable reuse utilizing the established technical and policy knowledge base.

EPA's Office of Ground Water and Drinking Water co-developed and reviewed the document and invited other EPA offices and external reviewers to provide additional comments to develop this document in a way that it is technically robust, and broadly acceptable to EPA and members of the regulatory community.

Acknowledgments

We would like to express gratitude to the external technical review committee who reviewed this document. The technical review committee included:

Jim Taft
Executive Director
Association of State Drinking Water
Administrators

Cindy Forbes
Deputy Director, Division of Drinking Water
State Water Resources Control Board of CA

Jing-Tying Chao
Division of Drinking Water
State Water Resources Control Board of CA

G. Tracy Mehan III
Executive Director of Government Affairs
American Water Works Association

Steve Via
Director of Federal Relations
American Water Works Association

Melissa Meeker
Executive Director
Water Environment and Reuse Foundation

Julie Minton
Program Director for Water Reuse and
Desalination
Water Environment and Reuse Foundation

Ron Falco
Safe Drinking Water Program Manager
Colorado Department of Public Health and
Environment

Joel Klumpp
Manager, Plans and Technical Review Section
Texas Commission on Environmental Quality

The 2017 Potable Reuse Compendium was developed collaboratively through a CRADA between CDM Smith and EPA. The CDM Smith project management team was led by Project Director Greg Wetterau, and included Jennifer Osgood, Jill Vandegrift, Allegra da Silva, and Katherine Bell. Special thanks go to our colleagues who took their time to share professional experiences and technical knowledge in potable reuse to make this document relevant to the current state of practice of potable reuse. Please note that the listing of these contributors does not necessarily indicate endorsement of this document or represent all of their ideas or opinions on the subject.

Greg Wetterau
CDM Smith
Rancho Cucamonga, CA

Jillian Vandegrift
CDM Smith
Denver, CO

Allegra da Silva
previously with CDM Smith,
now with Stantec
Denver, CO

Katherine Bell
previously with CDM Smith,
now with Stantec
Nashville, TN

R. Bruce Chalmers
CDM Smith
Irvine, CA

James Lavelle
CDM Smith
Phoenix, AZ

Jennifer Hooper
CDM Smith
Bellevue, WA

Phil Singer
CDM Smith
Raleigh, NC

Doug Brown
CDM Smith
Denver, CO

Christopher Schulz
CDM Smith
Denver, CO

Susan Crawford
CDM Smith
Dallas, TX

Michael Stevens
CDM Smith
Bellevue, WA

Jane Madden
CDM Smith
Boston, MA

Katherine Dowdell
CDM Smith
Walnut Creek, CA

Darren Boykin
CDM Smith
Atlanta, GA

Marcia Rinker
CDM Smith

Anna Adams
CDM Smith
Boston, MA

Alma Jansma
CDM Smith
Rancho Cucamonga, CA

Robert Angelotti
Upper Occoquan Sewage
Authority
Centreville, VA

John Albert
WRF
Denver, CO

Thomas J. Grizzard†
Virginia Tech

Mehul Patel
Orange County Water District
Fountain Valley, CA

Paul Fu
Water Replenishment District
of So. California
Lakewood, CA

Chris Stacklin
Orange County Sanitation
District
Orange County, CA

Denise Funk
Gwinnett County Department
of Water Resources
Gwinnett County, GA

Robert Harris
Gwinnett County Department
of Water Resources
Gwinnet County, GA

Mayor David Venable
Village of Cloudcroft, NM

Eddie Livingston
Livingston Associates
Alamogordo, NM

Daniel Nix
City of Wichita Falls
Wichita Falls, TX

Russell Schreiber
City of Wichita Falls
Wichita Falls, TX

Kara Nelson
University of California
Berkeley
Berkeley, CA

Shane Snyder
University of Arizona
Tucson, AZ

Channah Rock
University of Arizona
Maricopa, AZ

Troy Walker
Hazen
Phoenix, AZ

Ben Stanford
American Water
Raleigh, NC

Brian Bernados
California Division of Drinking
Water
San Diego, CA

Jeff Mosher
Water Environment and
Reuse Foundation
Alexandria, VA

The following individuals also developed chapters and text, provided direction, advice, suggestions, or review comments on behalf of EPA:

Michelle Schutz
Project Manager
OGWDW
Washington, D.C.

Ryan Albert
OGWDW
Washington, D.C.

Hannah Holsinger
OGWDW
Washington, D.C.

Lauren Kasparek
ORISE Participant
OGWDW
Washington, D.C.

Rajiv Khera
OGWDW
Washington, D.C.

Mike Muse
OGWDW
Washington, D.C.

Phil Oshida
OGWDW
Washington, D.C.

Stig Regli
OGWDW
Washington, D.C.

Kenneth Rotert
OGWDW
Washington, D.C.

Marisa Tricas
OGWDW
Washington, D.C.

Robert Bastian
OWM
Washington, D.C.

Jan Pickrel
OWM
Washington, D.C.

Ashley Harper
OST
Washington, D.C.

Jeff Lape
OST
Washington, D.C.

Sharon Nappier
OST
Washington, D.C.

Robert Goo
OWOW
Washington, D.C.

Leslie Darman
OGC
Washington, D.C.

Pete Ford
OGC
Washington, D.C.

Carrie Wehling
OGC
Washington, D.C.

Christopher Impellitteri
ORD
Cincinnati, OH

Thomas Speth
ORD
Cincinnati, OH

Bob Brobst, PE,
EPA Region 8
Denver, CO

Jake Crosby
EPA Region 8
Denver, CO

Roger Gorke
OW/EPA Region 9
Los Angeles, CA

Bruce Macler
EPA Region 9
San Francisco, CA

Table of Contents

Preface.....i

Notice.....iii

Development of this Document.....iv

Acknowledgmentsv

Table of Contents.....viii

List of Figuresxii

List of Tables.....xiii

Frequently Used Abbreviations and Acronyms.....xiv

CHAPTER 1 Introduction.....1-1

 1.1 Terminology..... 1-1

 1.2 Target Audience 1-1

 1.3 Objectives of this Document 1-1

 1.4 What is Potable Reuse?..... 1-4

 1.5 Comparing Potable Reuse with Other Alternative Water Supplies and Approaches 1-5

 1.5.1 Conservation 1-5

 1.5.2 Non-Potable Reuse 1-5

 1.5.3 Imported Water..... 1-5

 1.5.4 Desalination..... 1-5

 1.6 Expansion of Potable Reuse..... 1-6

 1.7 Document Organization and Additional Reports..... 1-6

CHAPTER 2 Potable Reuse in the United States and Abroad.....2-1

 2.1 Potable Reuse in the United States 2-1

 2.1.1 Current State of Potable Reuse in the United States..... 2-1

 2.1.2 Water Supply Enhancement..... 2-5

 2.1.3 *De facto* Reuse in the United States 2-6

 2.2 Potable Reuse Worldwide 2-6

CHAPTER 3 Safe Drinking Water Act and Clean Water Act: Opportunities for Water Reuse.....3-1

 3.1 Existing Regulatory Opportunities for Potable Reuse..... 3-1

 3.1.1 Clean Water Act (CWA) 3-2

 3.1.2 Safe Drinking Water Act (SDWA)..... 3-5

 3.1.3 Regulatory Considerations for Planned Potable Reuse..... 3-12

 3.2 Local Regulatory Approaches 3-13

CHAPTER 4 Constituents in Potable Reuse Water Sources.....4-1

 4.1 Constituents in Potable Reuse Water Sources 4-1

 4.1.1 Pathogenic Microorganisms in Potable Reuse Water Sources 4-1

 4.1.2 Chemical Constituents in Potable Reuse Water Sources 4-2

 4.1.3 Inorganic Chemicals in Potable Reuse Water Sources 4-3

 4.1.4 Organic Chemicals in Potable Reuse Water Sources..... 4-3

4.1.5 Trace Chemical Constituents in Potable Reuse Water Sources.....	4-3
4.2 Constituents after Wastewater Treatment.....	4-3
4.2.1 Microbials after Wastewater Treatment	4-3
4.2.2 Chemical Constituents after Wastewater Treatment.....	4-4
4.3 Constituents During Water Treatment.....	4-4
4.4 Constituents After Drinking Water Treatment	4-5
CHAPTER 5 Risk Analysis.....	5-1
5.1 Risk Assessment.....	5-1
5.1.1 Quantitative Risk Assessment.....	5-2
5.1.2 Alternative Risk Assessment Methods	5-3
5.2 Risk Management	5-4
5.2.1 Risk Reduction Concepts and Management.....	5-5
5.2.2 Risk Analysis Framework	5-9
5.3 Summary	5-9
CHAPTER 6 Treatment Technologies for Potable Reuse.....	6-1
6.1 Overview: Five Overall Treatment Objectives for Potable Reuse.....	6-1
6.2 Removal of Suspended Solids	6-2
6.2.1 Media Filtration	6-3
6.2.2 Microfiltration and Ultrafiltration	6-3
6.3 Reducing the Concentration of Dissolved Chemicals	6-5
6.3.1 Reverse Osmosis	6-5
6.3.2 Nanofiltration (NF)	6-7
6.3.3 Electrodialysis/Electrodialysis Reversal (ED/EDR).....	6-7
6.3.4 Ion Exchange.....	6-8
6.3.5 Activated Carbon	6-8
6.3.6 Biologically Active Filtration (BAF)	6-9
6.4 Disinfection and Removal of Trace Organic Compounds	6-9
6.4.1 UV.....	6-9
6.4.2 Chlorine/Chloramines.....	6-10
6.4.3 Peracetic Acid (PAA).....	6-11
6.4.4 Pasteurization.....	6-11
6.4.5 Chlorine Dioxide	6-12
6.4.6 Ozone	6-12
6.4.7 Advanced Oxidation Processes (AOPs)	6-13
6.5 Aesthetics	6-14
6.5.1 Taste and Odor Control.....	6-15
6.5.2 Color	6-15
6.6 Stabilization	6-15
6.6.1 Decarbonation	6-16
6.6.2 Sodium Hydroxide	6-16
6.6.3 Lime Stabilization	6-16
6.6.4 Calcium Chloride	6-16
6.6.5 Blending.....	6-16
6.7 Summary Table of Treatment Technologies	6-17

6.8 Residuals Management 6-18

CHAPTER 7 Alternative Treatment Trains for Potable Reuse..... 7-1

7.1 Overview 7-1

7.1.1 Multiple Barrier Approach 7-2

7.1.2 Source Control..... 7-2

7.1.3 Optimizing Upstream Wastewater Treatment 7-3

7.2 Types of AWT Unit Processes Used in Potable Reuse Treatment Trains..... 7-3

7.2.1 WWTP to Surface Water Discharge 7-3

7.2.2 WWTP to Soil Aquifer Treatment (SAT)..... 7-3

7.2.3 Full Advanced Treatment and Related Models 7-5

7.2.4 Ozone-BAF or the Alternative Treatment Train..... 7-7

CHAPTER 8 Source Control 8-1

8.1 Introduction..... 8-1

8.2 Elements for Potable Reuse – Source Control Program 8-1

8.2.1 California’s IPR Source Control Program Requirements 8-3

8.2.2 DPR Source Control Program Elements 8-3

8.3 National Pretreatment Program 8-3

8.4 Pollution Prevention 8-4

8.5 POTW Chemical Impacts on Reuse Facilities 8-4

CHAPTER 9 Environmental and Engineered Buffers 9-1

9.1 Environmental Buffers 9-1

9.1.1 Aquifer Recharge..... 9-1

9.1.2 Surface Water Storage..... 9-2

9.1.3 Wetlands..... 9-2

9.1.4 Fate and Transport of Pathogens in Subsurface Environmental Buffers..... 9-3

9.1.5 Fate and Transport of Trace Chemical Constituents in Environmental Buffers..... 9-3

9.2 Engineered Storage 9-4

9.3 Response Time in Buffers..... 9-5

9.4 Replacing the Value of the Environmental Buffer 9-5

CHAPTER 10 Training, Operating, and Monitoring..... 10-1

10.1 Operator Training and Licensure 10-1

10.2 Hazard Analysis and Critical Control Points (HACCP) 10-2

10.3 Start-up, Commissioning, and Initial Operation 10-3

10.4 Ongoing Operation and Maintenance 10-4

10.5 Optimization and Improvement 10-5

10.6 Process Control and Monitoring 10-5

10.7 Selecting Monitoring Locations 10-6

10.7.1 Distinguishing Critical Control Points (CCPs) from Critical Operating Points (COPs) .. 10-6

10.8 Phases of Monitoring: Validation and Compliance 10-7

10.8.1 Validation Monitoring..... 10-7

10.8.2 Compliance Monitoring..... 10-7

10.9 Calibration 10-7

10.10 Reporting..... 10-7

10.11 Indicators and Surrogates 10-8

 10.11.1 Microbial Treatment Process Performance Indicators 10-9

 10.11.2 Microbial Treatment Process Performance Surrogates 10-10

 10.11.3 Chemical Treatment Process Performance Indicators 10-11

 10.11.4 Chemical Treatment Process Performance Monitoring Surrogates..... 10-11

CHAPTER 11 Cost of Potable Reuse11-1

 11.1 Introduction..... 11-1

 11.2 Cost Estimates 11-1

 11.2.1 Capital Costs 11-1

 11.2.2 Operations and Maintenance Costs (O&M Costs) 11-2

 11.2.3 Cost of Alternative Treatment Trains 11-3

 11.2.4 Cost of Water..... 11-3

CHAPTER 12 Epidemiological and Related Studies.....12-1

 12.1 Epidemiology of Water Reuse..... 12-1

 12.2 Future Research..... 12-6

CHAPTER 13 Public Acceptance13-1

 13.1 Current State of Public Acceptance 13-1

 13.1.1 Public Awareness and Opinion 13-1

 13.1.2 Shifting Opinions with Public Outreach and Changing Conditions 13-1

 13.2 Important Factors in Stakeholder Engagement for Potable Reuse 13-2

CHAPTER 14 Research.....14-1

 14.1 Current Highlighted Research..... 14-1

 14.1.1 EPA 14-1

 14.1.2 Water Environment & Reuse Foundation (WE&RF) 14-1

 14.1.3 Water Research Foundation (WRF)..... 14-2

CHAPTER 15 References.....15-1

Appendix A: Case Study Examples of IPR and DPR in the United States

A.1 Los Alamitos Barrier Water Replenishment District of So. CA/Leo J. Vander Lans Advanced Water Treatment Facility (LVLAWTF) – Indirect Potable ReuseA.1-1

A.2 Orange County Groundwater Replenishment System (GWRS) Advanced Water Treatment FacilityA.2-1

A.3 Gwinnett F. Wayne Hill Water Resources Center, Chattahoochee River and Lake Lanier Discharge - Indirect Potable ReuseA.3-1

A.4 Village of Cloudcroft PRe Water Project – Direct Potable Reuse.....A.4-1

A.5 Colorado River Municipal Water District Raw Water Production Facility Big Spring Plant - Direct Potable Reuse.....A.5-1

A.6 Wichita Falls River Road WWTP and Cypress WTP Permanent IPR and Emergency DPR ProjectA.6-1

A.7 Potable Water Reuse in the Occoquan Watershed.....A.7-1

List of Figures

Figure 1-1. Planned IPR scenarios and examples (adapted from EPA, 2012a)	1-3
Figure 1-2. Planned DPR scenarios and examples (adapted from EPA, 2012a).....	1-3
Figure 2-1. Planned and constructed IPR and DPR projects in the United States as of 2017	2-5
Figure 2-2. Overview of selected planned and constructed IPR and DPR projects worldwide (not intended to be a complete survey)	2-7
Figure 5-1. Risk mitigation concepts in potable reuse schemes (adapted from WRRF, 2014a).....	5-6
Figure 5-2. States with redundancy regulations or requirements (WERF, 2003).....	5-8
Figure 6-1. Size ranges for various filtration processes (source: GE Osmonics, 2000).....	6-2
Figure 6-2. Submerged MF membranes at OCGWR	6-5
Figure 6-3. RO system at OCGWR.....	6-5
Figure 6-4. Typical breakpoint chlorination curve	6-11
Figure 7-1. Overview of potable reuse treatment trains in existence as of 2015 (not intended to be a complete survey)	7-2
Figure 7-2. Oxelia oxidation-enhanced biologically active filtration system (courtesy of Xylem Inc.).....	7-8
Figure 8-1. Fundamental goals of a DPR source control program	8-1
Figure 8-2. Critical components of a source control program for potable reuse.....	8-2
Figure 9-1. Environmental buffers in potable reuse treatment schemes	9-1
Figure 9-2. Engineered storage buffers in potable reuse treatment schemes.....	9-5
Figure 11-1. Typical O&M cost breakdown of a potable reuse facility using a membrane-based treatment train.....	11-3
Figure 11-2. Full advanced treatment train © Copyright 2014 WasteReuse Research Foundation (project 10-01), used with permission	11-4
Figure 11-3. Ozone-BAF treatment train © Copyright 2014 WasteReuse Research Foundation (project 10-01), used with permission	11-4
Figure 14-1. Barriers to potable reuse research (WRRF figure used with permission).....	14-2

List of Tables

Table 1-1. Document scope	1-2
Table 1-2. Local factors that, if present, may make potable reuse desirable as part of an overall water supply portfolio.....	1-2
Table 1-3. Comparison of IPR and DPR practices	1-4
Table 1-4. Document organization	1-6
Table 1-5. Reports on potable reuse (not intended to be a complete survey).....	1-8
Table 2-1. Overview of selected planned IPR and DPR projects in the United States (not intended to be a complete survey)	2-2
Table 2-2. Overview of selected planned IPR and DPR projects outside of the United States (not intended to be a complete survey)	2-8
Table 3-1. Number of U.S. states or territories addressing potable water reuse as of 2017 (Updated from EPA, 2012a).....	3-13
Table 3-2. Select U.S. states addressing potable reuse as of 2017.....	3-13
Table 4-1. Median infectious dose of waterborne pathogens (Feachem et al., 1983; Messner et al., 2014, 2016; Teunis et al., 2008).....	4-1
Table 4-2. Chemical substances potentially present in wastewaters (not intended to be a complete list)	4-2
Table 4-3. Pathogen Densities in Raw Wastewater and Log10 Reductions Across Unit Treatment Processes (adapted from Soller et al., 2018).....	4-5
Table 6-1. Overall treatment objectives and corresponding unit processes.....	6-1
Table 6-2. Aesthetic compounds potentially present in untreated municipal wastewaters.....	6-14
Table 6-3. Treatment technologies and associated treatment capabilities (adapted from CORPUD, 2014).....	6-17
Table 7-1. IPR application approaches (adapted from EPA, 2012a).....	7-4
Table 7-2. Comparison of pathogen and contaminant reduction in California and Western Australia IPR approaches	7-6
Table 7-3. Reclamation facilities using the ozone-BAF process.....	7-9
Table 8-1. Specific content of potable reuse source control program elements (Adapted from FCM and NRC, 2003).....	8-2
Table 10-1. Microbial monitoring terms (adapted from WHO, 2001; WRF, 2008; NRC, 2012a; EPA, 2012a).....	10-8
Table 10-2. Chemical monitoring terms (adapted from WRF, 2008; NRC, 2012a)	10-8
Table 10-3. Potential indicator compounds with differing physiochemical properties to demonstrate ..	10-12
Table 11-1. Cost of alternative treatment trains for a 20 MGD facility (adapted from WRRF, 2014d)	11-5
Table 11-2. Costs of RO concentrate management options for potable reuse treatment (from Table 10.3 in NWRI, 2015) ¹	11-6
Table 12-1. Epidemiological and related studies on health effects pertaining to reclaimed water consumption (Rock et al., 2016. Reproduced with permission. © Water Research Foundation).....	12-1
Table 14-1. DPR and related research projects	14-3
Table 14-2. WRF biofiltration related research projects (WRF, 2017).....	14-14

Frequently Used Abbreviations and Acronyms

AGB	Alamitos Gap Barrier
AOP	advanced oxidation processes
ASR	aquifer storage and recovery
AWTF	advanced wastewater treatment facility
AWTP	advanced water treatment plant
AWWA	American Water Works Association
BAC	biological activated carbon
BAF	biologically active filtration
BGD	billion gallons per day
BOD	biochemical oxygen demand
CCL	Contaminant Candidate List
CCP	Composite Correction Program
CIP	clean-in-place
COD	chemical oxygen demand
COP	critical operating points
CPE	Comprehensive Performance Evaluation
CRADA	Cooperative Research and Development Agreement
CRMWD	Colorado River Municipal Water District
CTA	Comprehensive Technical Assistance
CWA	Clean Water Act
CWCB	Colorado Water Conservation Board
CWS	community water system
DAF	dissolved air flotation
DBP	disinfection by-product
DBPR	Disinfection Byproducts Rule
DDW	(California) Division of Drinking Water
DOC	dissolved organic carbon
DPR	direct potable reuse
EC	electrical conductivity
EDC	endocrine disrupting compound
EDR	electrodialysis reversal
EEWTP	Estuary Experimental Water Treatment Plant
EPA	Environmental Protection Agency

ESB	environmental storage buffer
FRT	failure response times
FHWRC	F. Wayne Hill Water Reclamation Center
GAC	granular activated carbon
GWR	Ground Water Rule
GWRS	Groundwater Replenishment System
GWUDI	groundwater under the direct influence of surface water
HACCP	Hazard Analysis and Critical Control Points
IAP	Independent Advisory Panel
IESWTR	Interim Enhanced Surface Water Treatment Rule
IPR	indirect potable reuse
ISS	International Space Station
LBWRP	Long Beach Water Reclamation Plant
LPHO	low-pressure high output
LRC	log removal credit
LRV	log reduction value
LSI	Langelier Saturation Index
LVLAWTF	Leo J. Vander Lans Advanced Water Treatment Facility
MAR	managed aquifer recharge
MBR	membrane bioreactor
MCL	maximum contaminant level
MCLG	maximum contaminant level goal
MF	microfiltration
MGD	million gallons per day
NDMA	N-nitrosodimethylamine
NMED	New Mexico Environment Department
NOM	natural organic matter
NPDES	National Pollutant Discharge Elimination System
NPDWR	National Primary Drinking Water Regulation
NTNCWS	nontransient, noncommunity public water system
NTU	nephelometric turbidity unit
NWRI	National Water Research Institute
OCSD	Orange County Sanitation District
OCWD	Orange County Water District
OWMP	Occoquan Watershed Monitoring Program
PAA	peracetic acid
PAC	powdered activated carbon

PCR	polymerase chain reaction
PhACs	pharmaceutically active compounds
POTW	publicly owned treatment works
PPCP	pharmaceuticals and personal care products
QMRA	quantitative microbial risk assessment
QRRR	quantitative relative risk assessment
RO	reverse osmosis
RTCR	Revised Total Coliform Rule
RWPF	raw water production facility
RWQC	Recreational Water Quality Criteria
SAT	soil aquifer treatment
SCADA	Supervisory Control and Data Acquisition
SCMA	South-Central Membrane Association
SDWA	Safe Drinking Water Act
SOP	standard operating procedure
SRT	solids retention time
SWMOA	Southwest Membrane Operator Association
SWTR	Surface Water Treatment Rule
TBL	triple bottom line
TCEQ	Texas Commission on Environmental Quality
TCR	Total Coliform Rule
TDS	total dissolved solids
THM	trihalomethanes
TMDL	total maximum daily load
TOC	total organic carbon
TrOC	trace organic chemicals
TSS	total suspended solids
TTHM	total trihalomethanes
TWDB	Texas Water Development Board
UCMR	Unregulated Contaminant Monitoring Rule
UF	ultrafiltration
UIC	Underground Injection Control
UOSA	Upper Occoquan Service Authority
USDW	underground source of drinking water
UV	ultraviolet radiation
UVT	UV transmittance
VDEQ	Virginia Department of Environmental Quality

VDH	Virginia Department of Health
WE&RF	Water Environment & Reuse Foundation
WEF	Water Environment Federation
WERF	Water Environment Research Foundation
WHO	World Health Organization
WRC	Water Resources Center
WRD	Water Replenishment District
WRF	Water Research Foundation
WRRF	WaterReuse Research Foundation
WRS	water recycling system
WTP	water treatment plant
WWTP	wastewater treatment plant

CHAPTER 1

Introduction

In 2012, the U.S. Environmental Protection Agency (EPA) published *Guidelines for Water Reuse* (2012 *Guidelines*) to facilitate further development of water reuse by serving as an authoritative reference on water reuse practices. The 2012 *Guidelines* document met a critical need: it informed and supplemented state regulations and guidelines by providing technical information and outlining key implementation considerations.

1.1 Terminology

As described in the 2012 *Guidelines*, the terminology associated with treating and reusing municipal wastewater varies both within the United States and globally. For instance, some states and countries use the term “reclaimed water” and “recycled water” interchangeably. Similarly, the terms “water recycling” and “water reuse” are often used synonymously. This document uses the terms reclaimed water and water reuse. Definitions of terms used in this document, except their use in case studies, are provided below.

Planned potable reuse: The publicly acknowledged, intentional use of reclaimed wastewater for drinking water supply. Commonly referred to simply as potable reuse.

De facto reuse: A situation where reuse of treated wastewater is practiced but is not officially recognized (e.g., a drinking water supply intake located downstream from a wastewater treatment plant [WWTP] discharge point).

Direct potable reuse (DPR): The introduction of reclaimed water (with or without retention in an engineered storage buffer) directly into a drinking water treatment plant. This includes the treatment of reclaimed water at an Advanced Wastewater Treatment Facility for direct distribution.

Indirect potable reuse (IPR): Deliberative augmentation of a drinking water source (surface water or groundwater aquifer) with treated reclaimed water, which provides an environmental buffer prior to subsequent use.

1.2 Target Audience

The target audience for this document is similar to that of the 2012 *Guidelines*—policy makers; legislators; water planners; water reuse practitioners including utility staff, engineers, and consultants; and the general public. The document is relevant across the spectrum of geographies in the United States. Specific experiences are drawn from case studies on existing potable reuse approaches in the United States.

1.3 Objectives of this Document

With the increasing interest in potable reuse, there is a need to collect existing data on the state of the industry to inform the decision-making process regarding potable reuse practices. This document will supplement the 2012 *Guidelines* and note current practices and approaches in potable reuse, including the existing technical and policy knowledge base. This document does not intend to provide guidance or norms for potable reuse, but rather to present the current state of practice in the United States to assist planners and decision-makers considering potable reuse approaches (refer to **Table 1-1**).

Table 1-1. Document scope

Not included	Included – state of the industry
National recommendations or regulations for potable reuse	Summary of federal laws impacting potable reuse and state regulatory frameworks for potable reuse
Promotion of potable reuse	Opportunities, challenges, and trends in potable reuse
Design or treatment requirements for potable reuse	Potable reuse applications, treatment technologies, research results, and case studies

Augmenting drinking water supplies with reclaimed water – potable reuse – may help communities meet critical future water demands. **Figure 1-1** and **Figure 1-2** provide graphical representations of IPR and DPR, respectively, including some illustrative examples both within the United States and abroad.

Potable reuse is one option in a diversified portfolio of water supply options. Water reuse can provide a new, sustainable, and local water supply that reduces demands on limited community supplies and improves water supply resiliency. Potable reuse may be desirable as part of a broader water resource portfolio in a variety of circumstances (see **Table 1-2**).

Table 1-2. Local factors that, if present, may make potable reuse desirable as part of an overall water supply portfolio

Factor	Description
Water supply stress	<ul style="list-style-type: none"> • Drought or changes in precipitation patterns • Heightened withdrawals from competing demands such as population growth, agriculture, and/or industry • Local supplies (or imported supplies) are limited for other reasons
Groundwater withdrawal impacts	<ul style="list-style-type: none"> • Limited groundwater withdrawals • Challenges with seawater intrusion into coastal aquifers
Water quality challenges associated with conventional water sources	<ul style="list-style-type: none"> • Risks from unintentional introduction of contaminants • Seasonal water quality disruptions (surface water)
Increasing costs or limitations on discharges	<ul style="list-style-type: none"> • Increasingly restrictive water quality requirements for discharges from municipal WWTPs result in utilities seeking ways to recover costs by creating a value for the treated wastewater • Elimination of ocean outfalls through regulatory action
Opportunities for non-potable reuse are limited	<ul style="list-style-type: none"> • High costs of installation and energy use of non-potable reuse distribution systems (purple pipe, pump stations, and other infrastructure) • Water demands outpace non-potable reclaimed water supply opportunities • Seasonal non-potable reclaimed water demands • Water rights issues may arise when placing water into an environmental buffer (in some locations this may favor DPR over IPR or non-potable reuse)

Since the publication of the 2012 *Guidelines*, a need has been identified for additional documentation of potable reuse practices. The 2012 *Guidelines* provides guidance on IPR and describes DPR, but does not

address current DPR practices. This document expands on the discussion of both IPR and DPR and focuses on centralized municipal reuse; it does not cover stormwater capture and use or on-site potable reuse within a single building or facility.

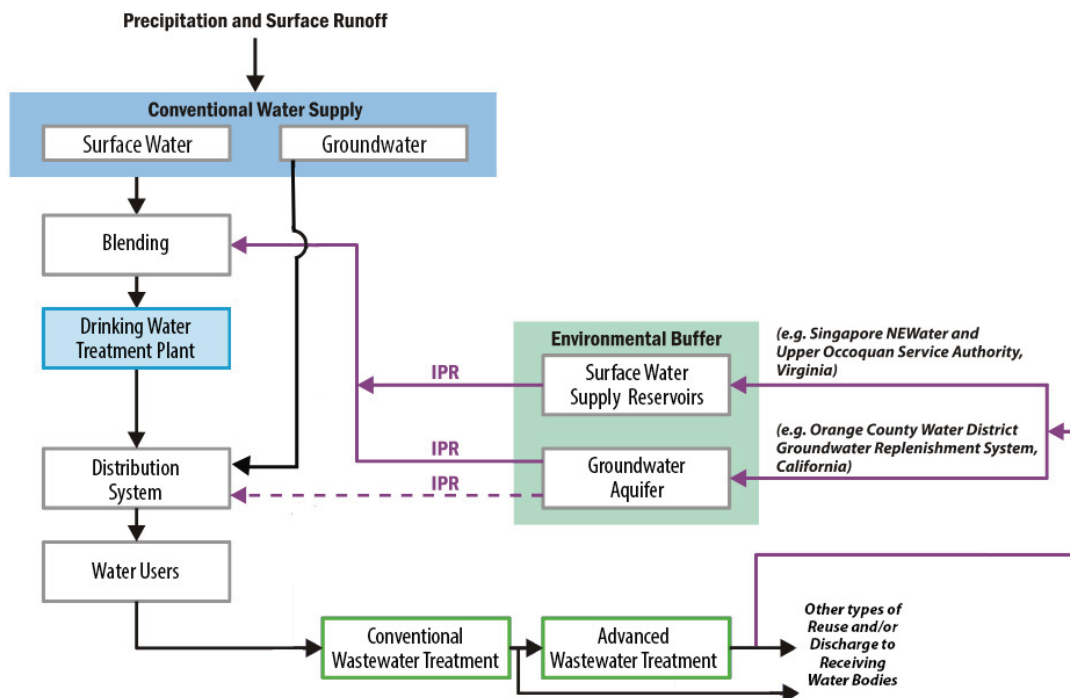

Figure 1-1. Planned IPR scenarios and examples (adapted from EPA, 2012a)

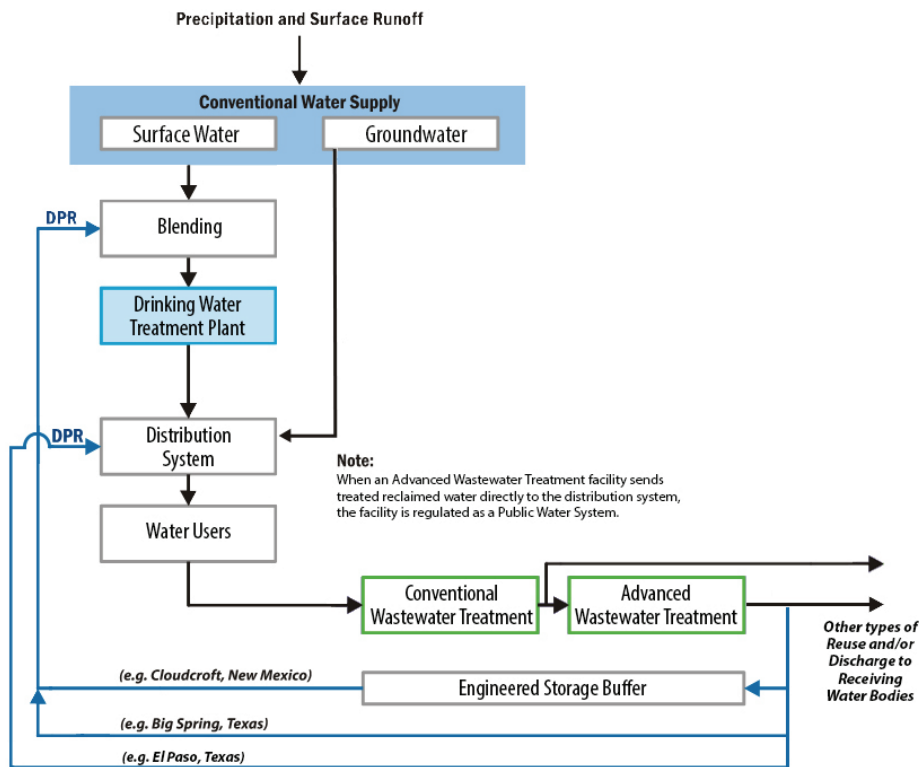

Figure 1-2. Planned DPR scenarios and examples (adapted from EPA, 2012a)

1.4 What is Potable Reuse?

As shown in **Figure 1-1** and **Figure 1-2**, potable reuse involves the indirect (IPR) or direct (DPR) use of highly treated municipal wastewater as a municipal drinking water source. In DPR, a drinking water treatment plant receives reclaimed water directly and often blends it with other water sources before treatment. The drinking water treatment plant, which the Safe Drinking Water Act (SDWA) regulates as described in **Chapter 3**, may be located at the advanced wastewater treatment site or in another location. IPR is similar to DPR, but IPR contains an environmental buffer. See **Table 1-3** for more comparisons between IPR and DPR.

Table 1-3. Comparison of IPR and DPR practices

Factor	IPR	DPR
Public perception	Public perception may favor IPR over DPR, but conditions are site-specific. Public outreach and involvement are important components of any form of potable reuse.	While DPR was previously referred to as “toilet-to-tap” and “flush-to-faucet,” more recent surveys indicate that the public understands that the treated reclaimed water potentially has higher quality than current sources; this is reflected in the San Diego project where some public responses have called for the highly-purified water not to be released to the environment where its quality could be degraded.
Practicality	The lack of a suitable environmental buffer may make IPR impractical.	While the elimination of an environmental buffer provides a higher level of control over the water, there may be a higher level of monitoring and/or treatment complexity required to offset the loss of response time and other potential benefits provided by the buffer.
Costs	Environmental buffers can incur significant costs to protect, maintain, operate, and monitor. Conveyance to the environmental buffer may be costly.	DPR may require a higher level of operator training and may involve additional treatment steps beyond IPR.
Water quality	Environmental buffers have the potential to either enhance or degrade water quality, depending on site-specific conditions.	DPR provides a high level of control; but, the process monitoring and control may be more complicated than IPR because response times are shorter.
Water rights	Water rights issues can complicate IPR potential.	Water rights issues can complicate DPR potential.
Regulations	Several states have regulations or guidelines governing IPR.	While the state of North Carolina recently lifted the regulatory ban on DPR, to date, no states have formal regulations or guidelines governing DPR. DPR facilities are currently considered on a case-by-case basis in the United States
Treatment Requirements	Several states have regulations or guidelines for IPR treatment requirements.	There may be no difference in the treatment objectives between IPR and DPR; but, the level of process monitoring and control and, in some cases, the total level of treatment may be more complex for DPR, due to the absence of an environmental buffer.

1.5 Comparing Potable Reuse with Other Alternative Water Supplies and Approaches

There are a number of approaches to addressing water supply challenges; conservation and other best practices, such as addressing water loss, should be primary goals of any water resources management program. But, when these activities cannot close the gap between supply and demand, other implementation options can offset water demands. Some of these options may include non-potable reuse and desalination, recognizing that both of these options carry implementation challenges. For example, it may be difficult to obtain rights-of-way to construct and permit new purple pipe systems or brine disposal for desalination projects.

1.5.1 Conservation

Conservation, water use efficiency improvements, and water loss control are important components of managing water portfolios and important steps before implementing water reuse. The relative impact of conservation measures is site-specific and largely based on the local history of incentives and education (WRRF, 2014b). In some locations, the “low hanging fruit” of water use reductions already exist, and additional opportunities are of marginal impact and may rely on customers investing in water-saving appliances (WRRF, 2014b). One program that indicates water-saving appliances for interested consumers is EPA’s WaterSense program (EPA, 2017u). Reduced revenues from lower water sales may impact water utilities’ fiscal obligations and may result in higher customer water rates (WRRF, 2014b). Water loss controls, including repair of leaking pipes and reduction of non-metered uses, can provide substantial reductions in water supply demands without negatively impacting water sales.

1.5.2 Non-Potable Reuse

There are many applications within non-potable reuse, as described in depth in the 2012 *Guidelines*. In general, water for non-potable reuse does not require the same level of treatment as potable reuse (AWWA, 2016). Centralized non-potable reuse requires dedicated pipe networks and pumping systems, or an alternate delivery system such as trucking (WRRF, 2014b). Potable reuse scenarios utilize existing water delivery infrastructure, rather than the new purple pipe infrastructure often mandatory in non-potable reuse applications (WRRF, 2014b). This feature can facilitate water reuse in locations where laying new purple pipe infrastructure is infeasible due to cost and other considerations.

1.5.3 Imported Water

Much of the U.S. southwest developed because of the ability to import water from other areas. However, new imported water sources may be difficult to develop and sustain. Imported water sources can experience large interannual variability and exposure to natural disasters, require significant energy, and can impose significant adverse environmental consequences at water extraction sites (WRRF, 2014b).

1.5.4 Desalination

Seawater and brackish water desalination are viable options that provide high-quality, potable supply worldwide (WRRF, 2014b). Seawater desalination offers a water supply resistant to drought, but it can be susceptible to challenges from varying source water quality (red tides, storm events), and it can be costly and energy intensive to operate (WRRF, 2014b). Some seawater desalination facilities, particularly in California, face challenging regulatory requirements due to potential environmental impacts associated with feed water intakes, brine discharges, and construction near sensitive shoreline habitats. Seawater desalination is generally costlier than potable reuse (WRRF, 2014b). Where brackish aquifers exist, inland brackish water desalination tends to be less energy intensive and expensive than seawater desalination.

In locations where brine management cannot include coastal discharges (in both inland and coastal locations), the desalination cost can be high due to energy or land requirements to treat brine; the cost depends on the total dissolved solids (TDS) of the brackish source and disposal options (WRRF, 2014b).

1.6 Expansion of Potable Reuse

Table 1-2 introduced some of the factors that may make potable reuse a valid water supply component for communities. Potable reuse is expected to grow in the coming decades. A report from Bluefield Research (2015) estimates that by 2025, municipal utilities' wastewater reuse will increase by 61 percent and will require \$11.0B of capital expenditures. The report notes that 94 percent of this activity is expected to occur in nine states. Potable reuse installations are expected to grow by 25 – 50 million gallons per day (MGD) per year (100,000 – 200,000 m³/day added per year) (Bluefield Research, 2015). Current estimates suggest that potable reuse could use about one-third of California's wastewater by 2020 (WRRF, 2014b).

1.7 Document Organization and Additional Reports

Table 1-4 provides a brief overview of this document's organization and content. See **Table 1-5** for the scope of additional reports on potable reuse.

Table 1-4. Document organization

Chapter	Overview of Contents
Chapter 1 – Introduction	Provides an overview of the drivers for potable reuse in the United States and the objectives, scope, audience, and structure of the document.
Chapter 2 – Potable Reuse in the United States and Abroad	Describes the history and current extent of IPR, DPR, and <i>de facto</i> reuse practices in the United States and worldwide.
Chapter 3 – Safe Drinking Water Act and Clean Water Act: Opportunities for Water Reuse	Outlines existing federal regulatory structures that govern water, wastewater, and surface water quality in the United States as they relate to potable reuse. Defines regulatory challenges that exist in potable reuse. Describes the approaches that specific states have taken to regulate IPR and DPR.
Chapter 4 – Constituents in Potable Reuse Water Sources	Describes chemical and microbial constituents that are present in potable reuse water sources as the water moves through the potable reuse system.
Chapter 5 – Risk Analysis	Provides an overview of frameworks appropriate to analyze risk in potable reuse.
Chapter 6 – Treatment Technologies for Potable Reuse	Provides an overview of the key categories of treatment unit processes that are applicable to potable reuse.
Chapter 7 – Alternative Treatment Trains for Potable Reuse	Illustrates examples of treatment trains used in the United States for potable reuse.
Chapter 8 – Source Control	Outlines approaches that utilities take to eliminate industrial wastes of concern before they reach the wastewater treatment plant (WWTP), with a special focus on the particular source control concerns in potable reuse.

Chapter	Overview of Contents
Chapter 9 – Environmental and Engineered Buffers	Describes what environmental and engineered buffers are capable of providing in terms of treatment, blending, and retention time, with particular focus on resultant water quality and process upset response times.
Chapter 10 – Training, Operating, and Monitoring	Provides an overview of operational approaches to manage risk, including training requirements, and a brief discussion on monitoring resources and indicators and surrogates.
Chapter 11– Cost of Potable Reuse	Provides a cost comparison between potable reuse and other alternative water sources, including capital and operation and maintenance costs as well as environmental and social elements of the triple bottom line.
Chapter 12 – Epidemiological and Related Studies	Provides an overview of published epidemiological studies on potable reuse.
Chapter 13 – Public Acceptance	Describes the current state of public acceptance for potable reuse in the United States and how utilities have approached public involvement in planning and operations.
Chapter 14 – Research	Documents current research in the field of potable reuse.
Appendix A – Case Study Examples of IPR and DPR in the United States	<p>A-1: Los Alamitos Barrier Water Replenishment District of So. CA/Leo J. Vander Lans Advanced Water Treatment Facility – Indirect Potable Reuse</p> <p>A-2: Orange County Groundwater Replenishment System Advanced Water Treatment Facility</p> <p>A-3: Gwinnett F. Wayne Hill Water Resources Center, Chattahoochee River and Lake Lanier Discharge – Indirect Potable Reuse</p> <p>A-4: Village of Cloudcroft PRe Water Project – Direct Potable Reuse</p> <p>A-5: Colorado River Municipal Water District Raw Water Production Facility Big Spring Plant – Direct Potable Reuse</p> <p>A-6: Wichita Falls River Road WWTP and Cypress WTP IPR and DPR Project</p> <p>A-7: Potable Water Reuse in the Occoquan Watershed</p>

Table 1-5. Reports on potable reuse (not intended to be a complete survey)

Author/Sponsoring Organization	Title	Year	U.S. Overview	Chemicals	Pathogens	Risk Assessment	Regulatory Summary	Treatment	Source Control	Buffers	Monitoring	Operations	Cost	Epidemiology	Public	Research	Case Studies
WaterReuse Association	<i>Innovative Applications in Water Reuse</i>	2004	✓												✓		✓
Water Environment Federation/American Water Works Association	<i>Using Reclaimed Water to Augment Potable Resources</i>	2008		✓	✓		✓	✓				✓			✓		✓
WaterReuse Research Foundation Project 11-00, Bureau of Reclamation, California State Water Resources Control Board	<i>Direct Potable Reuse – A Path Forward</i>	2011						✓	✓	✓	✓				✓	✓	✓
Water Environment Federation, American Society of Civil Engineers	<i>Municipal Wastewater Reuse by Electric Utilities: Best Practices and Future Directions</i>	2012				✓	✓										✓
National Research Council	<i>Water Reuse: Potential for Expanding the Nation's Water Supply Through Reuse of Municipal Wastewater</i>	2012	✓	✓	✓	✓	✓	✓	✓	✓	✓	✓	✓	✓	✓	✓	
WaterReuse Research Foundation and National Water Research Institute	<i>Examining the Criteria for Direct Potable Reuse</i>	2013		✓												✓	✓

Author/Sponsoring Organization	Title	Year	U.S. Overview	Chemicals	Pathogens	Risk Assessment	Regulatory Summary	Treatment	Source Control	Buffers	Monitoring	Operations	Cost	Epidemiology	Public	Research	Case Studies
WaterReuse Research Foundation Project 11-02 and Bureau of Reclamation 11-02-2	<i>Potable Reuse: State of the Science Report and Equivalency Criteria for Treatment Trains</i>	2013		✓	✓		✓	✓		✓	✓					✓	✓
Australian Academy of Technological Sciences and Engineering	<i>Drinking Water through Recycling: The Benefits and Costs of Supplying Direct to the Distribution System</i>	2013	✓	✓	✓		✓	✓		✓			✓		✓		✓
WaterReuse Research Foundation	<i>Fit for Purpose Water: The Cost of Overtreating Reclaimed Water</i>	2014											✓		✓		
WaterReuse Research Foundation	<i>The Opportunities and Economics of Direct Potable Reuse</i>	2014	✓		✓					✓			✓				✓
General Electric Power and Water	<i>Addressing Water Scarcity Through Recycling and Reuse: A Menu for Policymakers</i>	2015	✓				✓									✓	✓
Texas Water Development Board and Alan Plummer Associates	<i>Texas Water Development Board Direct Potable Reuse Resource Document</i>	2015		✓	✓	✓	✓	✓	✓		✓	✓	✓		✓	✓	

Author/Sponsoring Organization	Title	Year	U.S. Overview	Chemicals	Pathogens	Risk Assessment	Regulatory Summary	Treatment	Source Control	Buffers	Monitoring	Operations	Cost	Epidemiology	Public	Research	Case Studies
American Water Works Association (AWWA), NWRI (National Water Research Institute), WEF (Water Environment Federation), and WaterReuse	<i>Framework for Direct Potable Reuse</i>	2015				✓	✓	✓	✓	✓	✓	✓	✓	✓	✓	✓	
Water Environment Federation	<i>Water Reuse Roadmap Primer</i>	2016	✓	✓	✓	✓	✓	✓	✓	✓					✓	✓	✓
Water Research Foundation	<i>Assessment of Techniques to Evaluate and Demonstrate Safety of Water from Direct Potable Reuse Treatment Facilities</i>	2016		✓	✓		✓				✓			✓			
Water Environment & Reuse Foundation	<i>Final Report: Potable Reuse Research Compilation Synthesis of Findings</i>	2016	✓	✓	✓	✓	✓	✓	✓	✓	✓	✓	✓	✓	✓	✓	✓
World Health Organization	<i>Potable Reuse: Guidance for Producing Safe Drinking-Water</i>	2017	✓	✓	✓	✓	✓	✓	✓	✓	✓						✓
U.S. Environmental Protection Agency	<i>2017 Potable Reuse Compendium</i>	2017	✓	✓	✓	✓	✓	✓	✓	✓	✓	✓	✓	✓	✓	✓	✓

CHAPTER 2

Potable Reuse in the United States and Abroad

2.1 Potable Reuse in the United States

Potable reuse has long been considered in the United States. As early as 1962, indirect potable reuse (IPR) was used in Los Angeles County Sanitation District's Montebello Forebay project, followed in 1976 by Orange County California's Water Factory 21, and again in 1978 in Fairfax County by Virginia's Upper Occoquan Service Authority (EPA, 2012a). These pioneering IPR projects were the first in the United States to use highly treated reclaimed water for potable reuse (EPA, 2012a). As a result, in 1980, EPA sponsored a workshop on *Protocol Development: Criteria and Standards for Potable Reuse and Feasible Alternatives* (EPA, 1980b). In the document's Executive Summary, the chairman of the planning committee remarked that “[a] repeated thesis for the last 10 to 20 years has been that advanced wastewater treatment provides a water of such high quality that it should not be discharged but put to further use. This thesis when joined to increasing problems of water shortage, provides a realistic atmosphere for considering the reuse of wastewater. However, at this time, there is no way to determine the acceptability of renovated wastewater for potable purposes.” The committee, at the time, recognized the potential for potable water reuse; but, there were technical limitations and knowledge gaps which did not allow the group to fully understand the potential public health impacts of the practice.

2.1.1 Current State of Potable Reuse in the United States

Table 2-1 summarizes some of the most prominent United States potable reuse projects. To date, communities with severe drought conditions have implemented direct potable reuse (DPR), including Big Spring, Texas (2013) and Wichita Falls, Texas (2014) (EPA 2012a; Dahl, 2014). In these locations, DPR was either the most cost effective or the only feasible solution to water resource challenges (see **Appendix A** for case studies on Big Spring and Wichita Falls). **Table 2-1** also identifies the treatment technologies employed downstream of conventional wastewater treatment for each potable reuse facility. The table lists technologies used before the environmental discharge for IPR facilities and lists the entire treatment scheme for DPR facilities with no environmental discharge.

Today, the United States produces 32 billion gallons of municipal wastewater effluent per day of which 7 to 8 percent is reclaimed (EPA, 2012a). Currently, planned IPR and DPR account for a negligible fraction of the reused water volume (NRC, 2012a). However, potable reuse is a significant portion of the Nation's water supply when considering *de facto* reuse (where treated wastewater impacts drinking water sources) (NRC, 2012a). The map and table below show locations of example planned IPR and DPR projects around the United States (**Figure 2-1; Table 2-1**).

Table 2-1. Overview of selected planned IPR and DPR projects in the United States (not intended to be a complete survey)

Project Name	Location	Year of Installation	Status	Size (MGD)	Type of Reuse	Technologies
Montebello Forebay, County Sanitation Districts of Los Angeles County	USA - CA	1962	Operational	44	IPR: Groundwater recharge via soil-aquifer treatment	Media Filtration → CI
Water Factory 21, Orange County	USA - CA	1976	Built in 1976 but superseded by Orange County GWRS in 2004	15	IPR: Groundwater recharge via seawater barrier	LC → Air Stripping → RO → UV/AOP → CI
Upper Occoquan Service Authority, Fairfax (UOSA)	USA - VA	1978	Operational	54	IPR: Surface water augmentation	LC → Media Filtration → GAC → IX → CI
Denver Potable Reuse Demonstration	USA - CO	1980-1993	Studied (\$30 million project)	1	DPR demonstration plant (not used for drinking water supply)	LC → Recarbonation → Filtration → UV → GAC → RO → O ₃ → CI
Huecco Bolson Recharge Project, El Paso Water Utilities	USA - TX	1985	Operational	10	IPR: Groundwater recharge via direct injection	LC → Media Filtration → O ₃ → GAC → O ₃ → CI
Clayton County	USA - GA	1985	Operational	18	IPR: Surface water augmentation	CI → UV
West Basin Water Recycling Plant	USA - CA	1995-2014	Operational	17.5	IPR: Groundwater recharge via direct injection	O ₃ → MF → RO → UV/AOP
Gwinnett County	USA - GA	1999	Operational	60	IPR: Surface water augmentation	UF → O ₃ → GAC
Scottsdale Water Campus	USA - AZ	1999-2014	Operational	20	IPR: Groundwater recharge via direct injection	Media Filtration → MF → RO → UV

Project Name	Location	Year of Installation	Status	Size (MGD)	Type of Reuse	Technologies
Dominguez Gap Barrier, Terminal Island, City of Los Angeles	USA - CA	2002-2014	Operational	6	IPR: Groundwater recharge via direct injection	Media Filtration → MF → RO
Alamitos Barrier, Water Replenishment District of So. CA, Long Beach	USA - CA	2005	Operational	8	IPR: Groundwater recharge via direct injection	Media Filtration → MF → RO → UV/AOP
Chino Basin Groundwater Recharge Project, Inland Empire Utility Agency	USA - CA	2007	Operational	18	IPR: Groundwater recharge via soil-aquifer treatment	Media Filtration → CI
Orange County Groundwater Replenishment System (GWRS)	USA - CA	2008-2014	Operational	100	IPR: Groundwater recharge via direct injection and spreading basins	UF → RO → UV/AOP
Arapahoe County/Cottonwood	USA - CO	2009	Operational	9	IPR: Groundwater recharge via riverbank filtration	Media Filtration → RO → UV/AOP → CI
Prairie Waters Project, Aurora	USA - CO	2010	Operational	50	IPR: Groundwater recharge via riverbank filtration	Riverbank Filtration → ASR → Softening → UV/AOP → BAC → GAC → CI
San Diego Advanced Water Purification Demonstration Project	USA - CA	2012	Operational	1	Demonstration only (not used for IPR or DPR)	O3 → BAC → MF → RO → UV/AOP
Big Spring – Colorado River Municipal Water District (CRMWD)	USA - TX	2013	Operational	1.8	DPR: Blending then conventional water treatment	MF → RO → UV/AOP → Conventional Treatment

Project Name	Location	Year of Installation	Status	Size (MGD)	Type of Reuse	Technologies
City of Clearwater and the Southwest Florida Water Management District	USA – FL	2013 – 2014 (study only)	Studied for 1 year (pilot test)	3 (studied)	IPR: Groundwater recharge via direct injection	UF → RO → UV/AOP
Wichita Falls – IPR and River Road WWTP and Cypress WTP DPR projects	USA - TX	2014	Decommissioned	7	Temporary DPR: Blending prior to conventional treatment (long term IPR will be implemented by 2018)	MF → RO → UV → Storage → Conventional Treatment
Cambria Emergency Water Supply	USA – CA	2014	Operational	0.65	IPR: Groundwater recharge via direct injection	UF → RO → UV/AOP
Village of Cloudcroft	USA - NM	2016	Built but delayed	0.026	DPR: Blending prior to treatment	MBR → RO → UV/AOP → Storage → UF → UV → GAC → CI
Hampton Road Sanitation District SWIFT project	USA - VA	Under study	Under study	120	IPR: Groundwater recharge via direct injection	Not determined
Franklin	USA - TN	Future	Not yet built	8	IPR: Surface water augmentation	Not determined
San Diego-Advanced Water Purification Facility	USA – CA	Under study	Under study	18	IPR: Surface water augmentation	Media Filtration MF → RO → UV/AOP
El Paso – Advanced Water Purification Facility	USA – TX	Future	Under going regulatory approval	10	DPR: Straight to distribution system	MF → RO → UV/AOP → GAC → CI

Abbreviations used for technologies:

ADF – Average Daily Flow; AOP – Advanced Oxidation Processes; ASR – Aquifer Storage and Recovery; BAC – Biological Activated Carbon; CI - Chlorination; DAF – Dissolved Air Flotation; GAC- Granular Activated Carbon; IX –

Ion Exchange; LC – Lime Clarification; MBR – Membrane Bioreactor; MF - Microfiltration; O3 – Ozone Disinfection; PAC – Powdered Activated Carbon; RO – Reverse Osmosis; UF - Ultrafiltration; UV – Ultraviolet Radiation

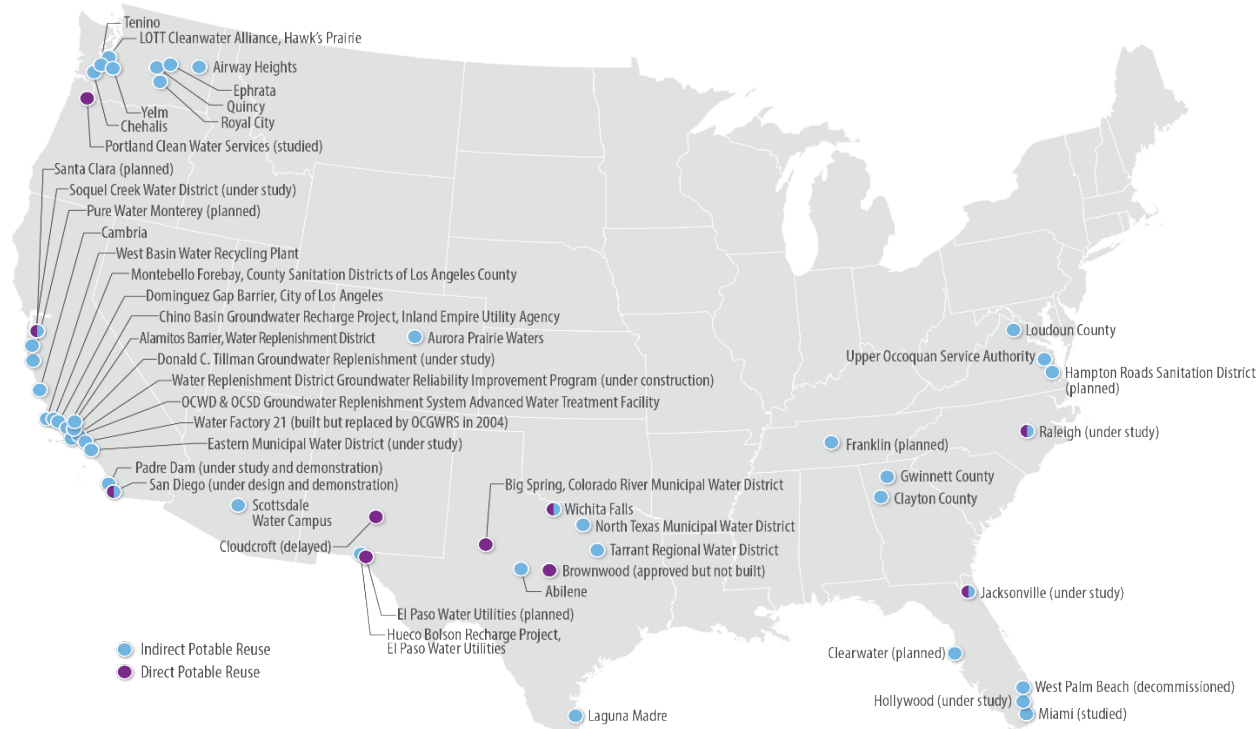

Figure 2-1. Planned and constructed IPR and DPR projects in the United States as of 2017

2.1.2 Water Supply Enhancement

While DPR is considered a relatively new concept, the 2012 *Guidelines* state, “[DPR] should be evaluated in water management planning, particularly for alternative solutions to meet urban water supply requirements that are energy intensive and ecologically unfavorable.” In regions that face imminent water supply shortages due to population pressures or changes in historical precipitation patterns, the only options to expand water supplies may include water importation, saltwater desalination, and water reuse (Snyder, 2014). Especially in inland locations, water reuse may be the only viable option (Snyder, 2014).

Examples include Big Spring, Texas (1.8 million gallons per day (MGD)) and Wichita Falls, Texas (5 MGD), which temporarily implemented DPR in response to extreme drought (Nix, 2014; see **Appendix A**). Wichita Falls designed a temporary DPR scheme that successfully implemented DPR for an 11-month period; a permanent IPR installation will supersede the now decommissioned DPR scheme (see **Appendix A**). Brownwood, Texas is also evaluating and pursuing DPR because of severe drought (Miller, 2015). Cloudcroft, New Mexico recently permitted a DPR project in response to limited water sources for the seasonal tourist population, but it is not in operation (see **Appendix A**).

It is important to note that U.S. communities with adequate annual rainfall are also evaluating potable reuse as a potential component of future water resource portfolios. For example, the City of Franklin, Tennessee is considering planned IPR to expand its ability to provide reasonably priced, high-quality drinking water to customers while also addressing discharge permitting (“City of Franklin”). In Raleigh, North Carolina (“City of Raleigh”) and Gwinnett County, Georgia (see **Appendix A**), local utilities are studying direct potable reuse.

2.1.3 *De facto* Reuse in the United States

Upstream or upgradient wastewater discharges contribute to many of our Nation's water supplies. Typically, facilities using these as drinking water sources do not characterize their process as potable reuse; but it is instructive to consider this practice as *de facto* reuse, whether intentional or not.

There is a general public perception that rivers and lakes help attenuate wastewater-derived contaminants before use as a downstream drinking water source. Generally, the factors that determine the concentration of wastewater-based contaminants in source water include the type and performance of the wastewater treatment plant (WWTP), dilution, residence time in the surface water, and water body characteristics (including depth, temperature, turbulence, water quality, and sunlight exposure) (NRC, 2012a).

Large cities that draw their drinking water from rivers with numerous upstream wastewater discharges (for example, Atlanta, Philadelphia, Houston, Nashville, Cincinnati, New Orleans, and Washington D.C.) utilize *de facto* reuse (Bell et al., 2016a). For instance, in Houston, an average of 50 percent of the water entering the water treatment plant (WTP) drawing from Lake Livingston is made up of wastewater effluent from the Dallas/Fort Worth area upstream (NRC, 2012a). While the drinking water treatment technologies used in these *de facto* reuse locations yields potable water that meets current drinking water regulations, many wastewater impacted source waters in *de facto* potable reuse locations receive less monitoring and treatment prior to entering the potable water supply than planned potable reuse projects (NRC, 2012a).

Recent studies contribute to understanding the extent of *de facto* reuse nationwide. Using a mass balance approach, the National Research Council (NRC) used EPA WWTP discharge data to estimate that of the 32 billion gallons per day (BGD) of U.S. municipal wastewater effluent, approximately 12 BGD discharge into an ocean or estuary, and 20 BGD discharge into surface water sources (NRC, 2012a). These discharges to surface water sources, which represent 63 percent of all municipal effluent generated daily in the United States, re-enter the hydrologic cycle and may become part of downstream drinking water sources, sources for irrigation, power generation, and ecological flows.

2.2 Potable Reuse Worldwide

There are a number of facilities worldwide that are currently operating successful potable reuse processes. Several of these facilities are identified in **Figure 2-2** and **Table 2-2**.

The most notable project employing DPR is the Goreangab Water Reclamation Plant in Windhoek, Namibia (EPA, 2012a). Windhoek was the first city to implement long-term potable reuse without the use of an environmental buffer. Windhoek's experimental DPR project began in 1969 and was expanded in 2002 to 5.5 MGD (EPA, 2012a). It can supply about 50 percent of the city's potable water demand (NRC, 2012a).

In Beaufort West, South Africa, a severe drought in 2010 resulted in the need for trucks to deliver water to more than 8,000 homes (Khan, 2013). The Beaufort West Water Reclamation Plant was commissioned in 2011 to provide up to 0.6 MGD (2.1 ML/d) (Khan, 2013).

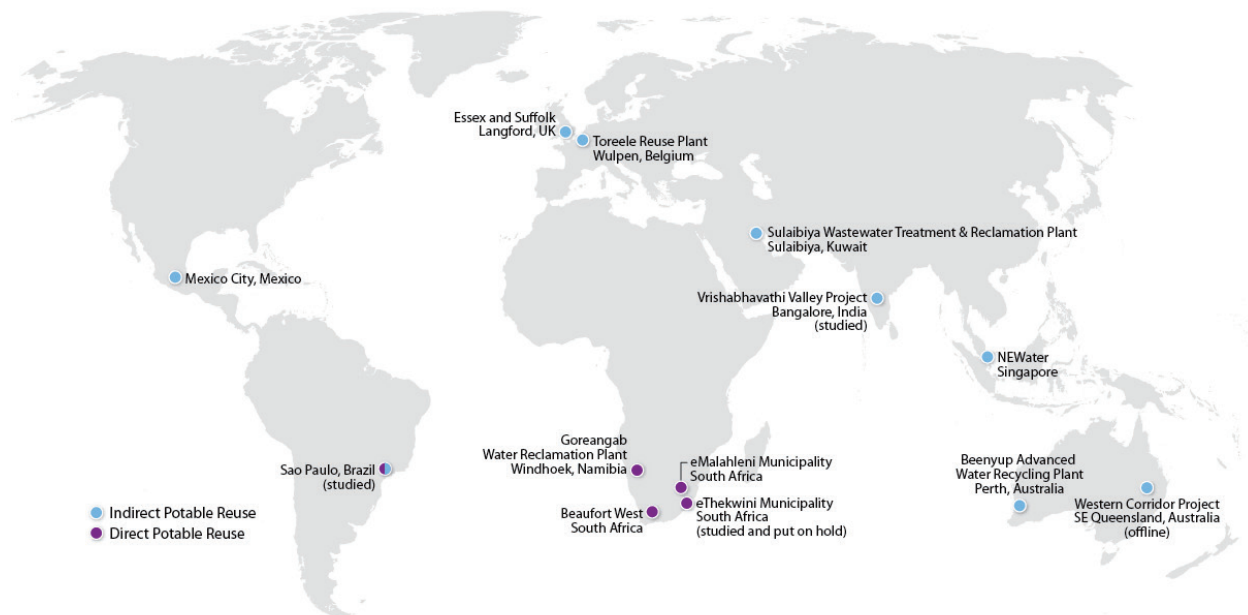

Figure 2-2. Overview of selected planned and constructed IPR and DPR projects worldwide (not intended to be a complete survey)

The eThekweni Municipality in South Africa, which includes Durban and surrounding towns, is rapidly approaching a water shortage (Khan, 2013). The Municipality formally began exploring water resource alternatives in 2008, including dams, desalination, rainwater harvesting, and potable water reuse. Proposals for a DPR process were put on hold in 2012 following negative media reports, with seawater desalination being pursued as a key alternative (Khan, 2013).

A study by the Australian Academy of Technological Sciences and Engineering (ATSE) (Khan, 2013) published findings on the science, technology, and engineering associated with DPR, indicating that with the rapid advancements in recent decades,

“DPR is growing internationally and will be an expanding part of global drinking water supply in the decades ahead. DPR is technically feasible and can safely supply drinking water directly into the water distribution system, but advanced water treatment plants are complex and need to be designed correctly and operated effectively with appropriate oversight. Current Australian regulatory arrangements can already accommodate soundly designed and operated DPR systems.”

“High levels of expertise and workforce training within the Australian water industry are critical. These must be supported by mechanisms to ensure provider compliance with requirements to use appropriately skilled operators and managers in their water treatment facilities. This will be no less important for any future DPR implementation and to maintain high levels of safety with current drinking water supply systems.”

Singapore’s NEWater plants are some of the best known IPR systems in the world (WHO, 2017; EPA, 2012a). Potable reuse can satisfy up to 40 percent of Singapore’s water demand, and it has helped the city-state pursue water sustainability (WHO, 2017; EPA, 2012a). The potable water produced is consistently noted for achieving drinking water standards, including EPA drinking water standards and World Health Organization guidelines (WHO, 2017; EPA, 2012a).

In Brazil, the worst drought in 80 years spurred the government to take action prior to the recent Olympics (Steadman, 2015). While Sao Paulo has reduced consumption by 20-25 percent, the city's two rivers remain heavily polluted (Steadman, 2015). A Brazilian state company requested Suez Environment propose solutions to this challenge, and Suez returned four possible solutions with the first being IPR (Steadman, 2015). The city has a significant amount of municipal wastewater that is not currently reused; when considering the available treatment technologies, it would be possible to reuse this source by returning highly treated water into one of the large reservoirs (Steadman, 2015). The City of Campinas is already testing IPR, potentially indicating acceptance of this practice (Steadman, 2015).

Table 2-2. Overview of selected planned IPR and DPR projects outside of the United States (not intended to be a complete survey)

Project Name	Location	Year of Installation	Status	Size (MGD)	Type of Reuse	Technologies
Vrishabhavathi Valley project, Bangalore	India	N/A	Studied	53	IPR: Surface water recharge	UF → GAC → Cl
Goreangab Water Reclamation Plant, Windhoek	Namibia	1969; expanded in 2002	Operational	5.5	DPR: Blending prior to treatment	PAC → O3 → Clarification → DAF → Sand Filtration → O3/AOP → BAC/GAC → UF → Cl
Toreele Reuse Plant, Wulpen	Belgium	2002	Operational	1.8	IPR: Groundwater recharge via infiltration ponds	UF → RO → UV
NEWater, Bedok	Singapore	2003	Operational	23	IPR: Surface water augmentation	UF → RO → UV
NEWater, Kranji	Singapore	2003	Operational	15	IPR: Surface water augmentation	UF → RO → UV
Essex and Suffolk, Langford	United Kingdom	2003	Operational	8	IPR: Surface water augmentation	Biological Filtration → UV disinfection
Western Corridor Project, Southeast Queensland (Bundamba, Luggage Point, Gibson Island)	Australia	2008	Intermittent Operation for NPR only	61	Designed for IPR: Surface water augmentation into drinking water reservoir (never used for IPR due to changes in local conditions)	UF → RO → UV/AOP
George	South Africa	2009	Intermittent Operation when necessary	2.6	IPR: Surface water augmentation	Drum Screen → UF → Cl

Project Name	Location	Year of Installation	Status	Size (MGD)	Type of Reuse	Technologies
NEWater, Changi	Singapore	2010; expanded in 2017	Operational	122	IPR: Surface water augmentation	UF → RO → UV
Beaufort West	South Africa	2011	Built	0.26	DPR: Blending with pretreated conventional sources	Sand Filtration → UF → RO → UV/AOP → Cl
Beenyup Groundwater Replenishment Reuse Trial, Perth, Australia	Australia	2011	Decommissioned	1.3	IPR: Groundwater recharge via direct injection	UF → RO → UV
Beenyup Advanced Water Recycling Plant, Perth, Australia	Australia	2016; expansion ongoing	Operational	10	IPR: Groundwater recharge via direct injection	UF → RO → UV
Mexico City	Mexico	Ongoing	Ongoing – untreated wastewater used for agricultural irrigation and incidental groundwater replenishment	570	IPR: Groundwater infiltration	None

Abbreviations used for technologies:

ADF – Average Daily Flow; AOP – Advanced Oxidation Processes; ASR – Aquifer Storage and Recovery; BAC – Biological Activated Carbon; Cl - Chlorination; DAF – Dissolved Air Flotation; GAC- Granular Activated Carbon; IX – Ion Exchange; LC – Lime Clarification; MBR – Membrane Bioreactor; MF - Microfiltration; O3 – Ozone Disinfection; PAC – Powdered Activated Carbon; RO – Reverse Osmosis; UF - Ultrafiltration; UV – Ultraviolet Radiation

CHAPTER 3

Safe Drinking Water Act and Clean Water Act: Opportunities for Water Reuse

Currently, there are no federal regulations specifically governing potable water reuse in the United States. There are state regulations, policies, and state and federal guidance addressing certain aspects of the process, including specific requirements for wastewater treatment and drinking water treatment. Additionally, several states have supported currently operational potable reuse projects. While there are no federal regulations directly addressing potable water reuse, it is a permissible approach to produce drinking water, provided all generally applicable Safe Drinking Water Act (SDWA), Clean Water Act (CWA), and state requirements are met.

3.1 Existing Regulatory Opportunities for Potable Reuse

The SDWA and the CWA provide the core statutory requirements relevant to potable water reuse. While the SDWA and the CWA are the federal laws that identify water quality criteria and standards (either in guidance or regulation), regulations specific to water reuse exist only at the state level.

As of the summer of 2017, no state had developed comprehensive, final regulations for direct potable reuse (DPR); but, North Carolina approved legislation in 2014 allowing limited DPR use with engineered storage buffering and blending with other sources (see **Table 3-2**). In 2016, the California State Water Resource Control Board concluded that it is feasible to develop uniform water quality criteria for DPR, a first step in consideration of state regulation development (CSWRCB, 2016). Some states are developing regulatory approaches for planning, permitting, and implementing risk management strategies to support potable reuse projects; these actions are in response to water supply challenges, population shifts and growth, and increasing interest in providing more resilient water supplies.

Historical Perspective

The concept of reclaiming water for potable use is not new. In a 1972 memo titled *EPA Policy Statement on Water Reuse*, EPA found that “the direct introduction of chemicals from a waste-stream and their build-up through potable system-waste system recycling can present increased long- term chronic hazards, presently undefined.” The memo concluded that: “We do not have the knowledge to support the direct interconnection of wastewater reclamation plants into municipal water supplies at this time,” and “an accelerated research and demonstration program is vitally needed to: Develop basic information and remedial measures with respect to viruses, bacteria, chemical build-ups, toxicological aspects and other health problems. Develop criteria and standards to assure health protection in connection with reuse.” (EPA, 1972).

However, as early as 1980, EPA noted “that advanced wastewater treatment provides a water of such high quality that it should not be discharged but put to further use” (EPA, 1980b). In 1982, the National Research Council (NRC) addressed water quality criteria for reuse in the report *Quality Criteria for Water Reuse*. Although the report did not endorse potable reuse, it provided some guidance on the topic. (NRC, 1982).

In 1998, the NRC published *Issues in Potable Reuse: The Viability of Augmenting Drinking Water Supplies with Reclaimed Water* that reflected significant changes from the 1982 report, including technological advances and emerging public health concerns. Additionally, the report analyzed several U.S. indirect

potable reuse (IPR) projects and concluded that reclaimed water might safely supplement raw water supplies, subject to further treatment. (NRC, 1998).

In 2012, the NRC published *Water Reuse: Potential for Expanding the Nation's Water Supply through Reuse of Municipal Wastewater*. The report concluded that the use of reclaimed water to augment potable water supplies has significant potential to contribute to the Nation's future needs. It also concluded that potable water reuse projects only account for a relatively small fraction of the total volume of water currently being reused when considering *de facto* or unplanned water reuse (NRC, 2012a). The committee commented on the potential utility of reused water (NRC, 2012b):

"... with recent advances in technology and design, treating municipal wastewater and reusing it for drinking water, irrigation, industry, and other applications could significantly increase the nation's total available water resources, particularly in coastal areas facing water shortages. Moreover, new analyses suggest that the possible health risks of exposure to chemical contaminants and disease-causing microbes from wastewater reuse do not exceed, and in some cases, may be significantly lower than, the risks of existing water supplies."

EPA, in partnership with Camp Dresser & McKee (now CDM Smith), published informational guidelines for water reuse in 1980 and updated them in 1992, 2004, and 2012 (EPA, 1980a; EPA, 1992; EPA, 2004; EPA, 2012a). The documents were intended to serve as authoritative references on water reuse practices. Among other things, the most recent guidelines (2012) include a discussion of water reuse in the United States and in other countries (developed in partnership with the U.S. Agency for International Development), advances in reuse-relevant wastewater treatment technologies, factors that would allow expansion of safe and sustainable water reuse, and presents case studies. The 2012 water reuse guidelines can be found at: <https://nepis.epa.gov/Adobe/PDF/P100FS7K.pdf>.

3.1.1 Clean Water Act (CWA)

The foundation of wastewater treatment requirements in the United States is the 1948 Federal Water Pollution Control Act. During the 1972 amendments, the law became known as the "Clean Water Act." Since then, the law has been reauthorized three times (1977, 1981, and 1987). The CWA authorizes water quality standards for surface waters and regulates pollutant discharge into U.S. waters with technology-based and water-quality based permit limits (EPA, 2017j). The subsections below describe specific aspects of the CWA that may apply to potable reuse.

3.1.1.1 Ambient Water Quality Criteria (AWQC)

To protect a given use of a water body, including those that serve as designated drinking water supplies, section 304(a)(1) of the CWA requires EPA to develop science-based water quality criteria. These criteria, based on pollutant concentrations and environmental or human health effects data, are developed for the protection of both aquatic life and human health. The criteria developed under section 304(a)(1) serve as recommendations to states and authorized tribes creating water quality standards, specifically water quality criteria, under section 303(c). 40 CFR 131.11(b) presents the options for states and/or authorized tribes establishing numerical water quality criteria (EPA, 2000a):

- Adopt EPA's 304(a) recommendations.
- Adopt 304(a) criteria but modify them based on site-specific characteristics.
- Develop their own scientifically-based criteria.

Currently, EPA has 122 recommended water quality criteria for the protection of human health and 60 recommended water quality criteria for the protection of aquatic life (EPA, 2017p). EPA also has recommended recreational water quality criteria for enterococci and *E. coli* (EPA, 2012c). These water quality criteria protect human health and the environment for primary contact recreational and drinking water supply uses.

Microbial (Pathogen) Criteria

Microbial criteria can protect the public from exposure to harmful levels of pathogens during primary contact recreational activities such as swimming.

As discussed in the 2012 Recreational Water Quality Criteria (RWQC), EPA currently recommends the culture-enumerated fecal indicator bacteria, *E. coli*, and enterococci to characterize the level of fecal contamination present in environmental waters (EPA, 2012c). However, there is a growing body of scientific evidence demonstrating that these culture-based bacterial indicators may not be good predictors of the presence of pathogenic enteric viruses and protozoa (EPA 2015a).

As of 2017, EPA is considering the use of male-specific (F-specific) and somatic coliphages as possible viral indicators of fecal contamination in ambient water. Coliphages are a type of virus that infects *E. coli*. EPA published a literature review titled *Review of Coliphages as Possible Indicators of Fecal Contamination for Ambient Water Quality* in 2015. The review summarizes the scientific literature on coliphage properties and evaluates its suitability as an indicator of fecal contamination in ambient water (EPA, 2015a). Additionally, EPA has published two standardized enumeration methods for male-specific and somatic coliphages (EPA, 2015a). The development of a coliphage criterion for ambient water could ensure that wastewater treatment plants are effectively reducing viruses in discharges. A coliphage criterion could also identify viral source water quality and its suitability for potable reuse waters.

Because of concerns about future increases in microbial contamination and potential new threats, EPA is considering future strategies that integrates the goals of both the CWA and the SDWA. In general, the new strategy objectives are to address important contamination sources, anticipate emerging problems, and efficiently use the CWA and the SDWA programmatic and research activities to protect public health. To help support this new approach, EPA has completed several risk assessment documents. First, EPA issued *Microbial Risk Assessment (MRA) Tools, Methods, and Approaches for Water Media*, which can assist risk assessors and scientists in developing rigorous and scientifically defensible risk assessments for waterborne pathogens (EPA, 2014a). The document describes a human health risk assessment framework for microbial hazards in water media (e.g., pathogens in treated drinking water, source water for drinking water, recreational waters, shellfish waters, and biosolids) that is compatible with other existing risk assessment frameworks for human health and chemical hazards. Secondly, EPA researchers and partners published two quantitative microbial risk assessments (QMRA) specifically addressing DPR (Soller et al. 2017; Soller et al., 2018). Together, these publications provide a risk methodology useful for regulators considering potable reuse projects as they consider how to best protect public health. Finally, EPA is working to finalize technical support material documents for QMRA, which will serve as a tool for states to use when developing CWA water quality standards based on local conditions and non-human sources of fecal contamination (EPA, 2014b).

Chemical Criteria

Human health ambient water quality criteria are numeric values that limit chemical concentrations in the Nation's surface waters to achieve designated uses and protect human health (EPA, 2015b). EPA develops these criteria by assessing the pollutant's effect on human health and the environment; States and tribes may use these criteria to establish water quality standards (CWA section 304(a)(1); EPA, 2015b). These

standards ultimately provide a basis for National Pollutant Discharge Elimination System (NPDES) permit limits in designated waters. A human health criterion provides guidance on the pollutant concentration in water that is not expected to pose a significant risk to human health (EPA, 2015b).

In 2015, EPA issued updated *National Recommended Human Health Water Quality Criteria* for 94 chemical pollutants to incorporate new information on exposure (body weight, drinking water, and fish consumption rates), bioaccumulation factors, health toxicity values for carcinogenic and non-carcinogenic compounds, and relative source contributions (EPA, 2015b).

3.1.1.2 NPDES Program

To help attain ambient water quality criteria, the CWA provides for EPA pollution control and permitting programs to limit the discharge of harmful pollutants into navigable waters (EPA, 2017j). With respect to protecting uses of the Nation's waters including drinking water sources, the National Pollutant Discharge Elimination System (NPDES) is a permit program under section 402 of the CWA that regulates point source discharges. Point sources include industrial, municipal, or other facilities that discharge effluent (wastewater) or stormwater into receiving surface waters (CWA sections 402 and 502(14)). Publicly owned treatment works (POTWs) are a subset of dischargers that discharge treated municipal and industrial wastewater and are required to have NPDES permits; however, dischargers connected to municipal sewer systems (i.e., indirect dischargers) do not need a NPDES permit (section 402; EPA, 2017q). The National Pretreatment Program controls industrial and commercial indirect dischargers (see 40 CFR 403.1). Most NPDES permits are issued by authorized states, however, EPA remains the permitting authority in Massachusetts, New Hampshire, New Mexico, Idaho, and for federal Indian lands and most U.S. territories (EPA, 2017a). There are two types of permits under the NPDES program: individual permits and general permits. Individual permits are issued for specific facilities whereas general permits cover discharges from multiple facilities that are similar in nature (EPA, 2013a).

NPDES permit limits are established using two basic approaches for protecting and restoring the Nation's waters. One is a technology-based approach, whereby the permitting authority bases permit conditions on either secondary treatment standards for POTWs, national effluent limitations guidelines for certain categories of non-POTWs, or case-by-case on the permit writer's best professional judgment (see CWA section 301(b) and 40 CFR 125.3). The other approach establishes water quality-based permit limits designed to ensure attainment of the water quality standards applicable to a particular water body. Where the permitting authority determines that technology-based effluent limits would not ensure attainment of the water quality standards, a more stringent water quality-based effluent limitation would be included in the permit (EPA, 2013a).

If the permitting authority determines that a discharge has a "reasonable potential" to cause or contribute to an excursion above an applicable water quality standard, the permitting authority must develop a limit that derives from and ensures compliance with the applicable standard (40 CFR 122.44(d)). Where a water body is already meeting its water quality standards, then those standards are used in calculating the water quality-based effluent limit for the NPDES permit, and the permitting authority may consider dilution of the effluent and receiving water in calculating the limit if state water quality standards allow (40 CFR 122.44(d)). Because effluent limits derive from and ensure compliance with all applicable water quality criteria (e.g., aquatic life protection criteria, human health criteria, wildlife criteria) there are instances in which the discharge limits for a given contaminant at a municipal wastewater treatment plant (WWTP) may be more stringent than drinking water maximum contaminant levels (MCLs) derived under the SDWA. These differences are seen, in part, because the risk-based approach for establishing the ambient water quality criteria for protection of aquatic life and wildlife differ from the risk management approach for establishing MCLs.

If a water body is not meeting its water quality standards and has a total maximum daily load (TMDL), then the permitting authority must develop water quality-based limits that are consistent with that TMDL (EPA,2017i).

3.1.1.3 Impaired Waters and Total Maximum Daily Loads (TMDLs)

Under section 303(d) of the CWA, jurisdictions (states, territories and authorized tribes) must evaluate and develop a list of "water quality-limited segments," i.e., waters that do not meet or are not expected to meet applicable water quality standards after application of technology-based effluent requirements. Jurisdictions must develop TMDLs for the specific pollutant(s) and water body combinations on the 303(d) list. The TMDL identifies the maximum amount of a pollutant that a water body can receive and still meet water quality standards and allocates the pollutant loadings among wasteload allocations for point sources and load allocations (LA) for nonpoint sources and natural background with a margin of safety.

3.1.1.4 National Pretreatment Program

EPA promulgates pretreatment standards under section 307 of the CWA. These standards apply to all non-domestic dischargers that discharge wastewater to POTWs. Some pretreatment standards are promulgated directly into the General Pretreatment Regulations for Existing and New Sources of Pollution ("Pretreatment Regulations") (40 CFR 403), and these are referred to as the General and Specific Prohibitions. EPA also identifies best available technology that is economically achievable for industry categories and promulgates national pretreatment standards for indirect dischargers at the same time it promulgates effluent limitations guidelines for direct dischargers under sections 301(b) and 304(b) of the CWA. Such pretreatment regulations are known as categorical pretreatment standards. Categorical pretreatment standards are designed to prevent the discharges of pollutants that pass through, interfere with, or are otherwise incompatible with the operation of POTWs on a nationwide basis (see 40 CFR 403.2 and 403.6).

The National Pretreatment Program requires, in specific circumstances, that POTWs develop local pretreatment programs to implement national pretreatment standards (see 40 CFR 403.5). A POTW's NPDES permit lists enforceable requirements for the development and implementation of its pretreatment program (see 40 CFR 403.8). Among other things, a POTW must evaluate its facility's capabilities in order to prevent pass through or interference with its operations. Based on this evaluation, the POTW adopts local limits to address specific needs and concerns of the POTW treatment plant, its sludge (and sludge management practices), and its receiving waters (including reuse concerns). POTWs must also have the legal authority to control industrial users' contributions through a permit, order, or similar means, which may include either general or individual control mechanisms. These control mechanisms impose monitoring and reporting requirements to assess the industrial users' compliance with the more stringent of all three types of pretreatment standards.

3.1.2 Safe Drinking Water Act (SDWA)

The SDWA, originally passed by Congress in 1974 to protect the Nation's public drinking water supply, is the law that provides EPA the authority to regulate public water systems. A public water system is "a system for the provision to the public of water for human consumption through pipes or other constructed conveyances, if such system has at least fifteen service connections or regularly serves at least twenty-five individuals" (42 U.S.C. 300f(4)(A)). A drinking water treatment plant in a potable reuse system would be considered a public water supply system. An advanced wastewater treatment facility (AWTF) would also be considered a public water supply system in DPR scenarios where treated water enters a distribution system directly after treatment from that AWTF. The law, amended in 1986 and 1996, requires actions to protect drinking water and its sources—including rivers, lakes, reservoirs, springs, and groundwater wells.

The SDWA does not regulate private wells or systems that serve fewer than 15 service connections or fewer than 25 individuals for at least 60 days a year (EPA, 2017b). It authorizes and requires EPA to set national health-based standards for drinking water to protect against naturally-occurring and anthropogenic contaminants found in drinking water and drinking water sources; this includes contaminants from wastewater discharges (EPA, 2017b). EPA, states, and utilities work together to meet these standards. Any water reuse application should not compromise the ability of the affected public water system to comply with the requirements of the SDWA. It should also be recognized that, depending upon how the water reuse application is designed or operated, there may be opportunities to facilitate compliance with the SDWA or improve finished water quality (e.g., by application of advanced treatment processes).

While the CWA addresses protection of surface drinking water sources, there are still potential source water threats to safe drinking water, such as improperly disposed of household and industrial chemicals, runoff of nutrients from non-point sources, and pesticides. Improperly treated or disinfected drinking water, or drinking water that travels through an improperly maintained or operated distribution system may also pose a health risk. Regulations developed under the SDWA require that systems take appropriate measures to address these risks.

Originally, the SDWA focused primarily on treatment as the means of providing safe drinking water at the tap. The 1996 amendments greatly enhanced the existing law by adding new requirements: consumer confidence reports, a cost-benefit analysis for every new standard, an assessment of threats that may warrant source water protection, operator training, significant infrastructure funding for water system improvements, and strengthened controls over microbial contaminants and disinfection by-products (EPA, 2015c). This approach strives to ensure the quality of drinking water by protecting it from source to tap.

The SDWA requires EPA to set enforceable drinking water standards; EPA typically approves states and authorized tribes for implementation and enforcement responsibilities (SDWA section 1413). EPA retains oversight authority over tribal, state, local, and water providers' drinking water programs. The SDWA defines primary and secondary drinking water standards, and also includes special provisions for programs that protect both finished water and drinking water sources.

3.1.2.1 National Primary Drinking Water Regulations and Maximum Contaminant Levels

National Primary Drinking Water Regulations (NPDWRs) are drinking water standards developed under the authority of the SDWA that apply to U.S. public water systems and undergo review every six years (EPA, 2017b). In general, to set a NPDWR, EPA identifies contaminants for potential regulation (EPA, 2017c). If EPA decides to regulate a contaminant, EPA determines a maximum contaminant level goal (MCLG) for the contaminant. The MCLG is the level of a contaminant in drinking water below which there is no known or expected health risks (EPA, 2017c). EPA then specifies an enforceable MCL, which is the maximum permissible level of a contaminant in drinking water delivered to any public water system user (EPA 2017c). MCLs are standards set as close to the MCLGs as feasible after considering best available treatment technologies, detection methods, and cost. The SDWA defines feasible as the level that may be achieved with the use of the best available technology, treatment technique(s), and other available means (EPA, 2015c). Once the technical feasibility is determined, the MCL is established to account for economic factors and projected health benefits. If it is not economically or technically feasible to set an MCL, or when there is no reliable or economically feasible method to detect or measure contaminants in the water, EPA sets a treatment technique (TT) that specifies the level of treatment that a system must apply to remove or minimize that specific contaminant (EPA 2017c).

NPDWRs are legally enforceable standards to protect public health. As opposed to NPDWRs, Secondary Drinking Water Regulations are guidelines that regulate contaminants based on aesthetic or cosmetic effects; these contaminants do not threaten public health and therefore are not legally enforceable (EPA, 2017k).

EPA has set MCLs for contaminants from six categories: microorganisms, disinfectants, disinfection by-products, inorganic chemicals, organic chemicals, and radionuclides (EPA, 2017n). Also, treatment technique requirements exist for three of these categories: disinfection by-products, pathogens, and lead and copper. EPA has also set Maximum Residual Disinfectant Levels (MRDLs) for disinfectants (40 CFR 141.2).

3.1.2.2 Unregulated Contaminants

Unregulated Contaminant Monitoring Rule

The 1996 SDWA amendments required EPA to establish criteria for an unregulated contaminant monitoring program and publish a list of contaminants to monitor every five years (EPA, 2017b; EPA 2017o). EPA uses the Unregulated Contaminant Monitoring Rule (UCMR) to collect data on contaminants of potential health concern that are suspected to be present in drinking water but do not have health-based standards under the SDWA (EPA, 2017o).

EPA develops the UCMR list of contaminants largely based on the Contaminant Candidate List (CCL). The 1996 SDWA Amendments describe the process (EPA, 2017o):

- Monitoring of up to 30 contaminants every five years.
- Monitoring by a representative sample of public water systems serving less than or equal to 10,000 people and all systems serving more than 10,000 people.
- Storing analytical results in a National Contaminant Occurrence Database to support contaminant occurrence analysis and support regulatory determinations.

Contaminant Candidate List (CCL) and Regulatory Determinations

EPA relies on a science-driven CCL process to identify candidates for possible new drinking water regulations. The CCL is a list of contaminants that are currently not subject to any proposed or promulgated national primary drinking water regulations, but are known or anticipated to occur in public water systems and may occur at levels of potential public health concern (EPA, 2017d). Contaminants listed on the CCL may require future regulation under the SDWA. The Agency considers health effects and drinking water occurrence information when placing contaminants on the list and places contaminants on the list that present the greatest potential public health concern (EPA, 2017d). The CCL is used to prioritize agency research needs and serves as the primary tool for identifying contaminants to be monitored under EPA's UCMR program (EPA, 2017c).

EPA published the most recent CCL (CCL 4) on the November 17, 2016 (EPA, 2016c). The CCL 4 includes 97 chemicals or chemical groups and 12 microbial contaminants. The list includes, among others, chemicals used in commerce, pesticides, biological toxins, disinfection by-products, pharmaceuticals, and waterborne pathogens. The list is available at <https://www.epa.gov/ccl>.

EPA later determines whether or not to regulate at least five contaminants from the CCL in a separate process called Regulatory Determinations. Section 1412(b)(1)(A) of the 1996 SDWA lists three criteria for making a positive regulatory determination for a CCL contaminant:

1. The contaminant may have an adverse health effect.
2. The contaminant occurs, or is likely to occur, at a level and frequency of public health concern.
3. A national regulation provides a meaningful opportunity for health risk reduction.

A Regulatory Determination is a formal decision on whether (or not) EPA should initiate a rulemaking process to develop a regulation for a specific contaminant or group of contaminants (EPA, 2017c). EPA completed its most recent Regulatory Determination on January 4, 2016. For more information, see <https://www.epa.gov/ccl/basic-information-ccl-and-regulatory-determination>.

Health Advisories

The SDWA authorizes EPA to produce health advisories (HAs) for unregulated contaminants which provide information on drinking water contaminants that may cause adverse human health effects (EPA, 2017i). HAs are non-regulatory, non-enforceable, and a way for the Agency to provide technical advice to states, public health officials, public water systems, and other stakeholders. These documents typically contain the following information for the contaminant:

- Physical and chemical properties.
- Occurrence and environmental fate.
- Pharmacokinetics.
- Health effects.
- Analytical methodologies.
- Treatment technologies associated with drinking water contamination.

Additionally, HAs may identify drinking water concentrations of the contaminant at which adverse health effects are not anticipated to occur over a given exposure period (EPA, 2012b). Historically, HAs have been derived for three reasons: 1.) in response to emergency spills or contamination incidents, 2.) to provide technical assistance to state and local officials for unregulated contaminants that may have locally or regionally elevated concentrations, and 3.) in response to a public or stakeholder request for an HA.

3.1.2.3 Surface Water Treatment Rules

The most recent Surface Water Treatment Rules (SWTRs) were developed with the Stage 1 and Stage 2 Disinfectants and Disinfection Byproducts Rules (DBPRs). These rules are known as the Microbial/Disinfection Byproduct (M-DBP) cluster and are intended to reduce microbial contaminants in the water while minimizing the risks posed by disinfectants and disinfection by-products (DBPs).

Microbes such as *Giardia* and *Cryptosporidium*, viruses such as hepatitis A virus, and *Legionella* cause waterborne diseases and exist in fluctuating concentrations in surface waters (EPA, 2017e). The SWTRs require filtration and/or disinfection of surface water sources to remove and inactivate harmful microbes. The SWTRs apply to all public water systems utilizing surface water or groundwater that is under the direct influence of surface water (GWUDI).

In 1990, EPA's Science Advisory Board, established by Congress as an independent panel of experts, cited drinking water contamination as one of the most important public health risks (EPA, 2001a). They indicated that disease-causing microbial contaminants (e.g., bacteria, protozoa, and viruses) pose the greatest remaining health risk challenge for drinking water suppliers. The 1989 SWTR set MCLGs for *Legionella*, *Giardia lamblia*, and viruses at zero because any exposure to these contaminants presents some level of

health concern (EPA, 1989a). The 1989 SWTR required all systems using surface water or GWUDI (also known as Subpart H systems), to achieve at least 99.9 percent (3-log) and 99.99 percent (4-log) removal and/or inactivation of *Giardia* and viruses, respectively. Under the SWTR, systems are assumed to meet these treatment technique requirements if they meet design and operating conditions, turbidity performance criteria, and CT values (defined as the product of disinfectant residual concentration and the contact time that the residual is present in the water). Further, systems must maintain a detectable disinfectant residual throughout the distribution system. The 1989 SWTR does not specifically address *Cryptosporidium*, a protozoan organism responsible for an outbreak in Milwaukee, WI in 1993. To reduce the public health risk associated with *Cryptosporidium* in finished water, the Interim Enhanced Surface Water Treatment Rule (IESWTR) lowered the turbidity standard at Subpart H systems that serve 10,000 or more people to improve filtration performance (EPA, 1998a). The IESWTR also requires states to conduct sanitary surveys for all surface water and GWUDI community systems every three years and for noncommunity systems every five years.

The Long Term 1 Enhanced Surface Water Treatment Rule (LT1ESWTR) extends this requirement to systems serving fewer than 10,000 persons (EPA, 2002b). The Long Term 2 Enhanced Surface Water Treatment Rule (LT2ESWTR) requires additional treatment for *Cryptosporidium* at those surface water or GWUDI systems considered to have high levels of *Cryptosporidium* in source waters based on monitoring results (EPA, 2006b). Those systems must provide for additional reduction of *Cryptosporidium* in their source waters based on placement in one of three *Cryptosporidium* concentration bins, with one additional bin requiring no extra treatment. Total removal requirements range from 2-log reduction of *Cryptosporidium* for sources classified for no additional treatment in Bin 1 (< 0.075 oocysts/L) to 5.5-log for sources classified as Bin 4 (>3.0 oocysts/L).

Finally, the Filter Backwash Recycling Rule is intended to reduce pathogen concentrations in finished water by properly managing WTP backwash water and waste streams (EPA, 2001d).

3.1.2.4 Stage 1 and Stage 2 Disinfectants and Disinfection Byproducts Rules (DBPR)

Disinfectants used in water treatment can react with natural organic and inorganic materials in the water and form potentially harmful by-products. DBPs have been associated with adverse health effects, including cancer and developmental and reproductive effects (EPA, 2001a). The Stage 1 DBPR sets maximum residual disinfectant level goals (MRDLGs) and MRDLs for chlorine, chloramine, and chlorine dioxide (EPA, 1998b; EPA, 2001a). It also sets MCLGs for specific trihalomethanes (THMs) and haloacetic acids, bromate, and chlorate; and MCLs for the sum concentration of four THMs (total trihalomethanes, or TTHM), five haloacetic acids (HAA5), bromate, and chlorite. Whereas the Stage 1 Rule bases MCL compliance on a system-wide average (running annual average) for TTHM and HAA5, the Stage 2 DBPR requires MCL compliance at each monitoring location (location running annual average) (EPA, 2006a).

The bromate MCL only pertains to systems using ozone and is based on a running annual average of monitoring results at the entrance to the distribution system. The chlorite MCL only pertains to systems using chlorine dioxide based on monitoring at the entrance to and within the distribution system. Since short term exposure to chlorite may impose health risks, daily monitoring for chlorite is required at the entrance to the distribution system. If any sample exceeds the MCL value, three additional samples must be taken in the distribution on the following day; if the average of these sample measurements exceeds the MCL, the system is in violation. The Stage 1 DBPR also sets a treatment technique for total organic carbon (TOC) removal to reduce unregulated DBPs in surface water and GWUDI systems that use conventional treatment.

3.1.2.5 Ground Water Rule (GWR)

In 2006, EPA published the Ground Water Rule (GWR) to facilitate enhanced protection against microbial pathogens from fecal contamination in drinking water systems supplied by groundwater sources (EPA, 2006c; EPA, 2017f). The GWR requires sanitary surveys to identify significant deficiencies in water systems and requires mitigation of these deficiencies. The GWR is a risk-based rule requiring triggered source water monitoring for fecal contamination indicators if a system observes a positive total coliform sample in the distribution system (**Section 3.1.2.6**). It also provides states with the option to require assessment source water monitoring to target systems that may have higher fecal contamination risks. Also, if the system is found vulnerable to fecal contamination, then the system must remediate such contamination (e.g. treatment to achieve at least 4-log or 99.99 percent inactivation or removal of viruses) (EPA, 2017f).

3.1.2.6 Revised Total Coliform Rule (RTCR)

The presence of pathogens in finished drinking water has the potential to result in a public health impact, including waterborne disease outbreaks. In addition to the aforementioned SWTRs and GWR, EPA also enacted the Total Coliform Rule (TCR) in 1989 and revised this rule in 2013 (Revised Total Coliform Rule, RTCR) to address these concerns (EPA, 1989b; EPA, 2013b). The RTCR includes an MCLG of zero for *E. coli* because some *E. coli* organisms are pathogenic, and ingestion of a single pathogen has the potential to cause disease. The goal of the RTCR is to reduce potential public health threats associated with microbial contamination. Under the RTCR, each public water system must monitor for total coliforms at a rate proportional to the number of people served (EPA, 2017g). Public water systems are also required to test for *E. coli* if they detected total coliforms. If specified coliform occurrence frequency levels are exceeded, it will trigger an investigation and possible corrective action. If the system has not done the investigation or has not corrected the problem, or if it has the specified levels of *E. coli* total coliform occurrence (an MCL violation), then it must notify the public (EPA, 2017g).

3.1.2.7 Lead and Copper Rule

EPA's NPDWRs regulate lead and copper in drinking water at 40 CFR part 141, Subpart I. The Lead and Copper Rule includes requirements for corrosion control treatment, source water treatment, lead service line replacement, and public education (EPA, 2007; EPA, 2017h). These requirements are triggered, in some cases, by lead and copper action levels measured in samples collected at consumers' taps. The action level for lead is exceeded if the concentration of lead in more than 10 percent of tap samples collected during any monitoring period is greater than 15 ppb (EPA, 2017h). The action level for copper is exceeded if the concentration of copper in more than 10 percent of tap samples is greater than 1.3 ppm (EPA, 2017h). The most common source of lead and copper in drinking water is leaching of these metals from the drinking water distribution system after the treated water has left the drinking water treatment plant. The corrosivity of the treated water and the presence of lead or copper in distribution systems or premise plumbing both play an important role in determining the levels of lead and copper that will be present in drinking water. It is important to note that purified water from DPR systems can be highly aggressive to plumbing materials, and proper corrosion control may be critical for maintaining the safety of these systems.

3.1.2.8 Source Water Assessments

Protecting water at the source is the first step in the multiple-barrier approach that also includes treatment for removal of contaminants, monitoring to ensure that health-based standards are met, adequate infrastructure maintenance, and actions to improve consumer awareness and participation. Source water is untreated (raw) water from streams, rivers, lakes, or underground aquifers that is used to provide public drinking water (EPA, 2017r). Some level of water treatment (e.g., filtration, disinfection, corrosion control) is usually necessary before it is delivered to the customer. Protecting source water from contamination can

reduce the cost of treatment and the risks to public health (EPA, 2017r). Source water protection is one of the critical intersections between the CWA and the SDWA, where both Acts serve to protect valuable drinking water sources.

The 1996 SDWA amendments, section 1453, required all states to receive EPA approval for a source water assessment program and to execute assessments for all public water system supplies within three years (SDWA section 300j-13). The program does not specifically dictate nor require implementation of source water protection measures; but, the assessments help identify potential public health threats to address through either source water protection or additional treatment. This provision of the SDWA provides an additional check for the protection of drinking water supplies; i.e. waters that are designated as drinking water supplies are also protected under the CWA by application of ambient water quality criteria. The ambient surface water quality criteria under the CWA and source water protection programs under the SDWA are central to an effective programmatic approach to protecting human health during the implementation of potable reuse through surface water augmentation.

3.1.2.9 Underground Injection Control Program

The Underground Injection Control (UIC) program under the SDWA is an important part of existing IPR programs that use injection to implement artificial aquifer recharge (AR) to enhance natural groundwater supplies (EPA, 2016a). Recharge can occur using man-made conveyances such as infiltration basins or injection wells. Similar to AR, aquifer storage and recovery (ASR) is a type of AR practiced to both augment groundwater resources and recover the water for future uses (EPA, 2016a). The type of water injected in recharge projects can include treated drinking water, surface water, stormwater, and reclaimed water. Chapter 2 of the 2012 *Guidelines* provides an extensive discussion of groundwater recharge.

The SDWA authorizes EPA to develop minimum federal regulations for state and tribal UIC programs to protect underground sources of drinking water (USDW) and prohibits any injection which endangers a USDW (SDWA section 300h). USDWs are defined as an aquifer, or a part of an aquifer, that is currently used as a drinking water source or may be used as a drinking water source in the future with these specific characteristics (40 CFR 144.3):

- Supplies any public water system, or contains a sufficient quantity of groundwater to supply a public water system, and currently supplies drinking water for human consumption, or contains fewer than 10,000 mg/l total dissolved solids (TDS).
- Is not an exempted aquifer.

The UIC program is overseen by either a state or tribal agency or one of EPA's regional offices, and these agencies are responsible for regulating the construction, operation, permitting, and closure of injection wells that place fluids underground for storage or disposal (EPA, 2017s).

All injections require authorization under either general rules or specific permits. Injection well owners and operators may not site, construct, operate, maintain, convert, plug, abandon, or conduct any other injection activity that endangers USDWs (EPA, 2016b). The UIC requirements have two purposes (EPA, 2016b):

- Ensure that injected fluids stay within the well and the intended injection zone.
- Mandate that fluids that are directly or indirectly injected into a USDW do not cause a public water system to violate drinking water standards or adversely affect public health.

EPA regulations group injection wells into six “classes” (EPA, 2016b). Classes I - IV and VI include wells with similar functions, construction, and operating features (EPA, 2016b). This creates consistent technical

requirements for each well class. Class V wells do not meet the description of any other well class and include storm water drainage wells, septic system leach fields, and agricultural drainage wells (EPA, 2016b). Class V wells do not necessarily have similar functions, construction, or operating features (EPA, 2016b). Aquifer recharge wells and aquifer storage and recovery wells are regulated as Class V injection wells and, as such, well owners and operators must submit basic inventory information to the EPA region or state with primary enforcement authority (primacy) (EPA, 2016a).

Additional recharge well regulations vary between primacy states. As of 2007, nine states require that water used for ASR injection be potable or treated to national or state drinking water standards or state groundwater standards (EPA, 2016a). Potable water is defined differently in each state but generally refers to high-quality water that poses no immediate or long-term health risk when consumed. Some primacy states allow ASR to use additional types of water, including treated effluent, untreated surface and groundwater, reclaimed water subject to state recycled water criteria, or “any” injectate (EPA, 2016a). State-specific regulations do not supersede the prohibition of movement of fluid into a USDW. EPA regulations provide that “[n]o owner or operator shall construct, operate, maintain, convert, plug, abandon, or conduct any other injection activity in a manner that allows the movement of fluid containing any contaminant into USDW, if the presence of that contaminant may cause a violation of any primary drinking water regulation under 40 CFR part 142 or may otherwise adversely affect the health of persons” (40 CFR 144.12). These regulations do not specifically stipulate treatment requirements (e.g. filtration, disinfection) for the injected water, but such treatment may be necessary to protect against the adverse health effects referenced in the regulation.

3.1.3 Regulatory Considerations for Planned Potable Reuse

While there are some stakeholders who look to EPA to establish additional regulations for potable water reuse, the CWA and the SDWA already allow for planned potable reuse implementation. Utilities and states must meet all applicable SDWA and CWA provisions, at a minimum, including the SWTRs, when implementing planned potable reuse projects. Potable reuse systems should provide water quality treatment at a level sufficient to ensure public health protection. Examples of approaches designed to protect public health include California’s indirect potable reuse regulatory approach (see **Chapters 3** and **5**) and EPA’s approach in the LT2ESWTR, which requires PWSs with more challenging source waters to determine additional treatment requirements (EPA, 2006b). In order to ensure adequate public health protection, potable reuse systems should provide water quality treatment equivalent to or better than that afforded by first treating the water to meet limits otherwise required by an NPDES permit (i.e., secondary treatment at a minimum), followed by treatment to meet all applicable SDWA requirements. Some states, as previously described in the 2012 *Guidelines*, have already established rules, regulations, or guidance for IPR project implementation.

The WaterReuse Association and National Water Research Institute (NWRI), in cooperation with the American Water Works Association and Water Environment Federation, supported an Independent Advisory Panel (IAP) to identify issues to address when developing DPR guidelines that could ultimately support state rules or regulations. The result of that IAP effort was published as the *Framework for Direct Potable Reuse* (NWRI, 2015). This document offers one approach on DPR and may help decision-makers understand DPR’s role in a community’s water portfolio. Additionally, EPA development of planned potable reuse support documents would allow the EPA, states, and stakeholders to work in partnership to achieve greater progress towards developing locally sustainable water supplies for drought-stricken communities. Anchoring a potable reuse framework within the existing risk-based human health regulatory structure could promote higher levels of treatment at municipal WWTPs and clarify treatment and monitoring needs for potable reuse projects (Soller et al., 2017; Soller et al. 2018).

3.2 Local Regulatory Approaches

The 2012 *Guidelines* provided guidance regarding IPR, but only defined the concept of DPR. As of 2012, only eight states had some IPR guidance, and no states had DPR regulations. As of 2017, multiple states have addressed potable reuse in their regulations, and some states are developing or evaluating DPR regulations or guidelines (**Table 3-1**). For example, in August 2014, the state of North Carolina passed legislation allowing the use of Type 2 Reclaimed Water as a drinking water supply under certain conditions (see N.C. Gen. Stat. § 143-355.5). The following two tables highlight regulatory approaches taken in different states related to potable reuse.

Table 3-1. Number of U.S. states or territories addressing potable water reuse as of 2017 (Updated from EPA, 2012a)

Category of Reuse	Description	Number of States with Policies to Address Potable Reuse in 2012	Number of States with Policies to Address Potable Reuse in 2017
IPR	Augmentation of a drinking water source (surface or groundwater) with reclaimed water followed by an environmental buffer that precedes normal drinking water treatment.	8 (Arizona, California, Florida, Hawaii, Massachusetts, Pennsylvania, Virginia, Washington)	14 (Arizona, California, Florida, Hawaii, Idaho, Massachusetts, Nevada, North Carolina, Oklahoma, Oregon, Pennsylvania, Texas, Virginia, Washington)
DPR	The introduction of reclaimed water (with or without retention in an engineered storage buffer) into a drinking water treatment plant. This includes the treatment of reclaimed water at an Advanced Wastewater Treatment Facility for direct distribution.	0	3 (California, North Carolina, Texas)

Table 3-2. Select U.S. states addressing potable reuse as of 2017

States	Types of Potable Reuse Addressed	Treatment Requirements	Highlights
California ¹	Groundwater Replenishment Using Recycled Water via Surface Spreading and Subsurface Applications (Direct Injection)	Full-Advanced Treatment for Direct Injection Filtration + Disinfection for Surface Spreading	<ul style="list-style-type: none"> ▪ 12-log virus removal (1-log virus credit given per month of subsurface retention time) ▪ 10-log <i>Cryptosporidium</i> and <i>Giardia</i> removal ▪ 3 or more separate treatment barriers ▪ Each treatment process is granted between 0.5-log and 6-log removal credit ▪ Minimum allowable underground response time is 2 months ▪ Drinking water MCLs ▪ Action levels for lead and copper ▪ Less than or equal to 10 mg/L total nitrogen (applies to recycled water effluent or blended water concentration)

States	Types of Potable Reuse Addressed	Treatment Requirements	Highlights
			<ul style="list-style-type: none"> ▪ TOC ≤ 0.5 mg/L divided by the fraction of recycled water contribution ▪ < 10 ng/L NDMA ▪ Wastewater management agency must have industrial pretreatment and pollutant source control program
<p>Florida²</p>	<p>Groundwater Recharge to a Potable Aquifer via Injection</p>	<ul style="list-style-type: none"> ▪ Secondary ▪ Filtration ▪ Disinfection ▪ Multiple barriers for control of pathogens and organics ▪ Pilot testing required 	<p>Injection to groundwater with TDS < 3,000 mg/L:</p> <ul style="list-style-type: none"> ▪ Primary and secondary drinking water standards ▪ TSS < 5 mg/L ▪ TOC < 3 mg/L ▪ No detectable total coliforms/100 mL ▪ TOX < 0.2 mg/L ▪ Total N < 10 mg/L ▪ CBOD₅ < 20 mg/L
		<ul style="list-style-type: none"> ▪ Secondary ▪ Filtration ▪ Disinfection 	<p>Injection to groundwater with TDS between 3,000 -10,000 mg/L:</p> <ul style="list-style-type: none"> ▪ Primary and secondary drinking water standards ▪ TSS < 5 mg/L ▪ No detectable total coliforms/100 mL ▪ Total N < 10 mg/L ▪ CBOD₅ < 20 mg/L
	<p>Surface Water Augmentation</p>	<ul style="list-style-type: none"> ▪ Secondary ▪ Filtration ▪ Disinfection ▪ Multiple barriers for control of pathogens and organics ▪ Pilot testing required 	<p>Planned use of reclaimed water to augment surface water resources which are used or will be used for public water supplies</p> <ul style="list-style-type: none"> ▪ Primary and secondary drinking water standards ▪ TSS < 5 mg/L ▪ TOC < 3 mg/L ▪ No detectable total coliforms/100 mL ▪ TOX < 0.2 mg/L ▪ Total N < 10 mg/L ▪ CBOD₅ < 20 mg/L
<p>North Carolina³</p>	<p>IPR and DPR</p>	<p>Type 2 reclaimed water facilities:</p> <ul style="list-style-type: none"> ▪ Dual disinfection systems containing UV disinfection and chlorination or equivalent that 	<p>In 2014, Senate Bill 163 was signed into law (N.C. Gen. Stat. § 143-355.5), allowing for local water supply systems to combine reclaimed water with other raw water sources before treatment if all of the following conditions are satisfied:</p> <ul style="list-style-type: none"> ▪ Reclaimed water use is not required for compliance with flow limitations

States	Types of Potable Reuse Addressed	Treatment Requirements	Highlights
		<p>can meet pathogen reduction requirements</p>	<ul style="list-style-type: none"> ▪ Reclaimed water and source water are combined in an impoundment, sized for > 5 days' storage ▪ Impoundment design should ensure mixing ▪ Reclaimed water treated to highest standard (Type 2) ▪ Average daily flow of reclaimed water into impoundment is ≤ 20% ▪ Conservation measures are implemented and maximized ▪ Unbilled leakage is maintained below 15% ▪ Reuse Master Plan ▪ Public Participation <p>Type 2 Reclaimed Water Effluent Standards</p> <ul style="list-style-type: none"> ▪ <i>E.coli</i> ≥ log 6 reduction; ≤ 3/100 ml (monthly geometric mean) ▪ Coliphage ≥ log 5 reduction; ≤ 5/100 ml (monthly geometric mean) ▪ <i>Clostridium perfringens</i> ≥ log 4 reduction; ≤ 5/100 ml (monthly geometric mean) ▪ BOD₅ ≤ 5 mg/L (monthly avg) ▪ TSS ≤ 5 mg/L (monthly avg) ▪ NH₃ ≤ 1 mg/L (monthly avg) ▪ NTU ≤ 5
Oklahoma⁴	<p>Category 1A – DPR</p> <hr/> <p>Category 1B – IPR (Surface Water)</p> <hr/> <p>Category 1C- IPR (Groundwater)</p>	N/A	In development stages
Virginia⁵	IPR	<ul style="list-style-type: none"> ▪ Multiple barrier approach ▪ Secondary ▪ Filtration ▪ Disinfection 	<p>Projects proposed after 1/29/14 require multiple requirements (the most stringent standard applies if there is more than one pollutant standard):</p> <ul style="list-style-type: none"> ▪ Level 1 standards <ul style="list-style-type: none"> ○ BOD₅ ≤ 10 mg/L (monthly avg) ○ CBOD₅ ≤ 8 mg/L (monthly avg) ○ NTU ≤ 2 ○ Fecal coliform ≤ 14 colonies/100 mL (monthly geometric mean) ○ <i>E. coli</i> ≤ 11 colonies/100 mL (monthly geometric mean)

States	Types of Potable Reuse Addressed	Treatment Requirements	Highlights
			<ul style="list-style-type: none"> ○ Enterococci ≤ 11 colonies/100 mL (monthly geometric mean) ○ pH 6-9 ○ Total residual chlorine < 1 mg/L⁴ ▪ Specific standards based on factors considered by the State Water Control Board ▪ Other standards (i.e. – TMDLs)
Nevada ⁶	Reuse Category A+: IPR via spreading basins or direct injection		<ul style="list-style-type: none"> ▪ State adopted NPDWRs ▪ State adopted secondary MCLs ▪ Enteric virus = 12-log reduction ▪ Giardia = 10-log reduction ▪ Cryptosporidium = 10-log reduction
Texas ⁸	IPR and DPR	<ul style="list-style-type: none"> • Case-by-case 	<ul style="list-style-type: none"> ▪ Determined on a case-by-case basis for IPR and DPR ▪ In DPR, assigned log removal credits do not include the WWTP, rather they start at the WWTP effluent
Washington ⁷	Class A reclaimed water (surface water augmentation, indirect and direct groundwater recharge, aquifer recovery)	<ul style="list-style-type: none"> ▪ Oxidation ▪ Coagulation ▪ Filtration ▪ Disinfection 	<p>Performance Standards:</p> <ul style="list-style-type: none"> ▪ Disinfection requires 4-log virus removal or inactivation ▪ BOD₅ ≤ 30 mg/L (monthly avg) ▪ CBOD₅ ≤ 25 mg/L (monthly avg) ▪ TSS ≤ 30 mg/L (monthly avg) ▪ NTU ≤ 2 (coagulation and filtration) or ≤ 0.2 (membrane filtration) (monthly avg) ▪ Total Coliform ≤ 2.2 MPN/100 mL (7 day median) ▪ Total N ≤ 10 mg/L (monthly average) pH = 6-9 or 6.5-8.5 (groundwater recharge) <p>Additional requirements are based on use</p>
	Class A+ reclaimed water (DPR)	<ul style="list-style-type: none"> ▪ Same as Class A ▪ Additional requirements determined on case-by-case basis 	<ul style="list-style-type: none"> ▪ Specific performance standards must be health based and require state department of health approval
	Class B reclaimed water (surface water augmentation, indirect groundwater recharge)	<ul style="list-style-type: none"> ▪ Oxidation ▪ Disinfection 	<p>Performance Standards:</p> <ul style="list-style-type: none"> ▪ BOD₅ ≤ 30 mg/L (monthly avg) ▪ CBOD₅ ≤ 25 mg/L (monthly avg) ▪ TSS ≤ 30 mg/L (monthly avg) ▪ Total Coliform ≤ 23 MPN/100 mL (7 day median)

States	Types of Potable Reuse Addressed	Treatment Requirements	Highlights
			<ul style="list-style-type: none"> pH = 6-9 or 6.5-8.5 (groundwater recharge) <p>Additional requirements are based on use</p>

¹ See Cal. Code Reg. tit. 22 § 60320.100-60320.230;

http://www.waterboards.ca.gov/drinking_water/certlic/drinkingwater/Lawbook.shtml

² See Fla. Admin. Code 62-610; <http://www.dep.state.fl.us/legal/Rules/wastewater/62-610.pdf>

³ See N.C. Gen. Stat. § 143-355.5; 15A N.C. Admin. Code 02U;

http://www.ncleg.net/EnactedLegislation/Statutes/PDF/ByArticle/Chapter_143/Article_38.pdf;

<http://reports.oah.state.nc.us/ncac/title%2015a%20-%20environmental%20quality/chapter%2002%20-%20environmental%20management/subchapter%20u/subchapter%20u%20rules.pdf>

⁴ See Okla. Admin. Code § 252:656-27 (ODEQ, 2014);

<http://www.deq.state.ok.us/wqdnew/wqmac/Proposed2014/RegulatoryPathForwardforIndirectandDirectPotableReuseofReclaimedWaterNov2014.pdf>; <http://www.deq.state.ok.us/rules/656.pdf>

⁵ See 9 Va. Admin. Code §§ 25-740-70, 25-740-90;

<https://law.lis.virginia.gov/admincode/title9/agency25/chapter740/section70/>;

<https://law.lis.virginia.gov/admincode/title9/agency25/chapter740/section90/>

⁶ See Nev. Admin. Code § 445A (revised Dec. 21, 2016); <https://www.leg.state.nv.us/Register/2016Register/R101-16A.pdf>

⁷ See RCW 90.46; Reclaimed Water (proposed rule Aug. 23, 2017) (to be codified at Wash. Admin. Code § 173-219);

<http://apps.leg.wa.gov/RCW/default.aspx?cite=90.46>; <https://ecology.wa.gov/DOE/files/2e/2e59fa6e-b5ab-4612-ba13-a56b23ba7b40.pdf>

⁸ See TWDB, 2015 and 2017

CHAPTER 4

Constituents in Potable Reuse Water Sources

Potable reuse implicates both the Clean Water Act (CWA) and Safe Drinking Water Act (SDWA). Wastewater effluent must meet, if not exceed the CWA requirements, including National Pollutant Discharge Elimination Systems (NPDES) requirements. Subsequently, reused water must meet drinking water treatment requirements under the SDWA, including the National Primary Drinking Water Regulations (NPDWRs). See **Chapter 3** for a more in-depth discussion of the CWA and the SDWA. This chapter carefully considers the constituents that may be relevant when considering the use of reclaimed water in community drinking water supplies.

4.1 Constituents in Potable Reuse Water Sources

Potential chemicals and pathogenic microorganisms in water sources need to be carefully studied and evaluated when considering potable reuse as these can impact human health. This section explores the constituents of concern in potable reuse water sources (e.g., source water, wastewater, stormwater, greywater).

4.1.1 Pathogenic Microorganisms in Potable Reuse Water Sources

Microorganisms are abundant in nature and most are not pathogenic to humans. Microorganisms are present in high concentrations in wastewater in the form of bacteria, viruses, protozoa, and helminths. The pathogenic microorganisms are those that cause negative human health effects, such as gastrointestinal illness. The source of primary pathogens in domestic wastewater is primarily feces, and infection typically occurs through the “fecal-oral” route. Pathogens that are able to survive outside of the host are primarily transmitted via ingestion or consumption of contaminated water or food, or by inhalation of aerosolized water containing suspended opportunistic pathogens. Pathogen survival in water, including wastewater, can depend on a variety of factors, such as: the distance of travel, rate of transport, temperature, exposure to sunlight, water chemistry, and predation by other organisms. In potable reuse scenarios, most pathogen exposures pose an acute risk since disease generally presents on the order of hours to days following exposure. There are some pathogens that pose chronic risks. **Table 4-1** presents the infectious dose levels of various types of pathogens.

Table 4-1. Median infectious dose of waterborne pathogens (Feachem et al., 1983; Messner et al., 2014, 2016; Teunis et al., 2008)

Pathogenic Organism	Examples	Median Infectious Dose (ID50) Category
Bacteria	<i>Campylobacter</i> <i>Shigella</i> <i>Salmonella</i>	~10 ⁶
Viruses	Hepatitis A Rotaviruses Adenoviruses Noroviruses	<10 ²

Pathogenic Organism	Examples	Median Infectious Dose (ID50) Category
Protozoa	<i>Giardia</i> <i>Cryptosporidium</i>	<10 ²

Three recent publications compiled peer-reviewed pathogen density and pathogen log removal data in raw wastewater (Soller et al., 2017; Eftim et al., 2017; Soller et al., 2018). See **Table 4-3** for a summary of pathogen concentrations in raw wastewater.

4.1.2 Chemical Constituents in Potable Reuse Water Sources

Chemicals present in wastewater may be from atmospheric contact, geology, natural products, pesticides, runoff, or discharges from industrial facilities, amongst other sources (EPA, 2012a). The chemical makeup of municipal wastewater can vary depending on the activities taking place at the wastewater source. In domestic wastewater, pharmaceutically active substances enter the wastewater stream through human excretion and improper disposal of medications via toilet flushing. Additionally, pesticides and other agricultural chemicals have the potential to enter wastewater through stormwater runoff (which may also include oil, gasoline, road salts). **Table 4-2** summarizes categories of chemicals potentially present in wastewater and gives examples of specific chemicals of interest.

Table 4-2. Chemical substances potentially present in wastewaters (not intended to be a complete list)

Origin	Categories of Sources of Chemical Substance	Examples of Specific Chemical Substances
Industrial	Pesticides, preservatives, flame retardants, perfluorochemicals, nanoparticles	Plasticizers, heat stabilizers, biocides, epoxy resins, bleaching chemicals, solvents, dyes, polymers, hydrocarbons, phthalates, atrazine, DEET
Domestic	Personal care products, surfactants	Laundry detergent, ammonia, bleach, antifreeze, lotions, perfume
Human-based	Steroidal hormones, pharmaceutical residues	Oestradiol, oestrone, testosterone, trimethoprim, caffeine, ibuprofen, gemfibrozil, sulfamethoxazole, carbamazepine
Formed during WW treatment	Disinfection by-products	THMs, HAAs, NDMA, NDEA, aldehydes, bromate, chlorate

Types of chemicals include inorganic chemicals such as metals, salts, and nutrients, as well as organic chemicals such as naturally-occurring humic substances, fecal matter, kitchen wastes, liquid detergents, oils, etc. There are also extremely low concentrations of individual inorganic and organic water constituents known as “trace chemical constituents,” “trace organic chemicals” (TrOCs), or “contaminants of emerging concern” (CECs). CECs may be from pharmaceuticals, non-prescription drugs, personal care products, household chemicals, food additives, flame retardants, plasticizers, or biocides (EPA, 2012a). Reported concentrations of trace constituents in untreated domestic wastewater range from several ng/L to several hundred µg/L (Asano et al., 2007). Some of the specific chemicals that may be found in potable reuse water sources are discussed further below.

4.1.3 Inorganic Chemicals in Potable Reuse Water Sources

Dissolved inorganic constituents present in potable reuse water sources are a combined result of elevated levels of minerals in existing drinking water sources, the introduction of minerals from domestic water uses (such as salt-based water softeners), impacts of commercial and industrial discharges, and chemicals used during water treatment such as sodium hypochlorite and some coagulants (Asano et al., 2007). Typically, the concentration of dissolved inorganics in wastewater ranges between 200 to 400 mg/L higher than the associated potable water supply (Khan, 2013).

4.1.4 Organic Chemicals in Potable Reuse Water Sources

Dissolved organic constituents primarily include natural organic matter, soluble microbial products, fecal matter, kitchen wastes, liquid detergents, oils, grease, consumer products, and low concentrations of an extensive range of organic chemicals from industrial and domestic sources. Examples include pharmaceuticals and personal care products (PPCPs), pesticides, preservatives, surfactants, flame retardants, disinfection by-products (DBPs), and chemicals released by humans such as dietary compounds and steroidal hormones (Khan, 2013).

Trace organic chemicals (sometimes given the acronym TrOC to avoid confusion with Total Organic Carbon (TOC)), are generally present at or below $\mu\text{g/L}$ concentrations (NRC, 2012a), whereas dissolved organic carbon (DOC) or TOC is typically on the order of mg/L.

4.1.5 Trace Chemical Constituents in Potable Reuse Water Sources

Trace chemical constituents may include pharmaceuticals, non-prescription drugs, personal care products, household chemicals, food additives, flame retardants, plasticizers, biocides, as well as degradation and disinfection by-products deriving from these original parent compounds (EPA, 2012a). Trace chemical constituents can include both inorganic and organic chemicals and are sometimes described by their associated human health effects, such as endocrine disrupting compounds (EDCs) or pharmaceutically active compounds (PhACs).

Pharmaceuticals were detected in U.S. surface waters starting in the 1970s (Hignite and Azarnoff, 1977; Garrison et al., 1976). In the 1990s, steroid hormones in wastewater were linked to ecological impacts in impacted surface waters (Daughton and Ternes, 1999; Snyder et al., 2001; Desbrow et al., 1998). There are now well over 1000 research articles documenting the presence of trace chemical constituents, such as per- and polyfluoroalkyl substances (PFAS), in aquatic ecosystems impacted by human populations worldwide (e.g. Wells et al., 2008; 2009; 2010; da Silva et al., 2012; 2013; King et al., 2016; Glassmeyer et al., 2017; Furlong et al., 2017; Kostich et al., 2017).

4.2 Constituents after Wastewater Treatment

Wastewater treatment does not address all potable reuse constituents of concern. This section highlights some of the microbial and chemical constituents that remain after wastewater treatment and prior to drinking water treatment. These remaining constituents may inform drinking water treatment techniques necessary to produce safe drinking water, as well as design considerations when constructing wastewater treatment plants.

4.2.1 Microbials after Wastewater Treatment

Wastewater effluent may contain microorganisms including bacteria, viruses, protozoa, and helminths. Significant concentrations of bacteria can remain during sedimentation, secondary clarification, or

coagulation and flocculation; bacteria are inactivated or destroyed in drinking water applications using ultraviolet radiation (UV) disinfection or various oxidative processes (e.g., chlorination, ozonation, or chlorine dioxide) (EPA, 2012a). Enteric viruses are harder to remove than bacteria via coagulation, sedimentation, or filtration processes due to their small size and are more resistant than bacteria to disinfectants, especially chlorine (EPA, 2012a; EPA, 2015a). Viruses can be found in secondary effluent in the range of 10 - 10^5 plaque forming units per 100ml (Rose et al., 2004; EPA, 2015a). Protozoa also tend to be highly resistant to environmental stresses such as heat, freezing, and sunlight; additionally, protozoa and helminths tend to be resistant to chemical disinfectants such as chlorination (EPA, 2012a).

4.2.2 Chemical Constituents after Wastewater Treatment

Most municipal wastewater treatment plant effluents contain metals, salts, oxyhalides, nutrients, and other inorganic particles. Oxyhalides (including bromate, chlorite, and chlorate) can form during some wastewater treatment disinfection processes, particularly those using chlorine or ozone (NRC, 2012a). Therefore, treatment facility design and operation should consider minimizing oxyhalide formation even though the NPDES program rarely regulates these parameters. The main forms of nitrogen in wastewater treatment plant effluent are ammonia, nitrate, nitrite, and organic nitrogen (NRC, 2012a).

Conventional wastewater treatment processes do not remove many PPCPs due to hydrophilic tendencies at the typical operational pH values (pH 7-8). Some researchers have demonstrated ecological impacts on local aquatic organisms from trace chemical constituents present in wastewater treatment plant (WWTP) outfalls, whereas laboratory studies have found that much higher concentrations are necessary to result in acute impacts. The ecological impacts due to chronic exposure to trace chemical constituents and mixtures of these compounds are still unknown. This is due to the difficulty in designing studies that control for the complex set of variables occurring in human impacted aquatic ecosystems. A 2005 study on PhACs showed that acidic drugs, beta-blockers, and antibiotics remained in conventional WWTPs' effluent at concentrations between 10 and 10,000 ng/L (Sedlak et al., 2005). The study found that reverse osmosis (RO), granular activated carbon, and soil aquifer treatment (SAT) were effective removal mechanisms for many PhACs, but low concentrations of some compounds remained even after advanced treatment (Sedlak et al., 2005). In a 2014 EPA study, Kostich et al. measured concentrations of 56 active pharmaceutical ingredients (APIs) in effluent samples from 50 large U.S. WWTPs and found concentrations similar to the Sedlak study. Researchers further concluded that the risks of human exposure to individual PhACs and mixtures are generally very low (Kostich et al., 2014).

4.3 Constituents During Water Treatment

By utilizing multiple unit processes in combination with one another, direct potable reuse (DPR) treatment trains ideally should target the reduction of pathogens to achieve *de minimis* risk, while providing an additional measure of redundancy.

EPA researchers and partners' recent publication *Direct Potable Reuse Microbial Risk Assessment Methodology: Sensitivity Analysis and Application to State Log Credit Allocations* summarizes indicative ranges of key pathogens in raw wastewater (influent) and microbial log reductions reported in the relevant literature for various treatment technologies, replicated here in **Table 4-3** (Soller et al, 2018). Generally, treatment process steps receive log reduction credits during the permitting stage of a potable reuse project, but this varies from state to state. Log reduction credits are often determined based on the ability to monitor the reduction through microbial surrogates, such as *E. coli* or coliphage. Log reduction credits are a function of the detection limit of the analytical technique and the concentration present or injected in the feed water to the unit process. The log removal and/or inactivation rates through secondary wastewater treatment remain an area of ongoing research.

Table 4-3. Pathogen Densities in Raw Wastewater and Log10 Reductions Across Unit Treatment Processes (adapted from Soller et al., 2018)

	Adenovirus		Campylobacter		Cryptosporidium		Giardia		Norovirus		Salmonella	
	Min	Max	Min	Max	Min	Max	Min	Max	Min	Max	Min	Max
Raw Wastewater ¹	1.75	3.84	2.95	4.60	-0.52	4.38	0.51	4.95	0.02	9.17	0.48	7.38
CSWT ²	0.9	3.2	0.6	2	0.7	1.5	0.5	3.3	0.8	3.7	1.3	1.7
Ozonation	4		4		1		3		5.4		4	
BAF	0	0.6	0.5	2	0	0.85	0	3.88	0	1	0.5	2
MF	2.4	4.9	3	9	4	7	4	7	1.5	3.3	3	9
RO	2.7	6.5	4		2.7	6.5	2.7	6.5	2.7	6.5	4	
UF	4.9		5.6	9	4.4	6	4.7	7.4	4.5		5.6	9
UV Dose												
800_mJ/cm ²	6		6		6		6		6		6	
12 mJ/cm ²	0	0.5	4		2	3.5	2	3.5	0.5	1.5	4	
CDWT	1.5	2	3	4	1.4	3.9	0.3	4	1.5	2	2	3
Cl ₂	4	5	4		0		0	0.5	1.1	3.9	4	

¹ log10 units; Adenovirus IU/L, Campylobacter MPN/L, Cryptosporidium oocysts/L, Giardia cysts/L, Norovirus copies/L, Salmonella PFU/L

² CSWT= conventional secondary wastewater treatment; BAF = biologically active filtration; MF = microfiltration; RO = reverse osmosis; UF = ultrafiltration; UV = ultraviolet radiation; CDWT = conventional drinking water treatment

The probabilistic Quantitative Microbial Risk Assessment (QMRA) on DPR treatment train combinations for recycled water documents the reduction of reference pathogens (norovirus, adenovirus, *Cryptosporidium spp.*, *Giardia lamblia*, *Campylobacter jejuni*, and *Salmonella enterica*) across each unit process considered (Soller et al. 2017; Soller et al. 2018). The California State Water Resource Control Board also recommended using a QMRA approach for the development of uniform DPR water recycling criteria (California SWRCB, 2016). The Water Environment & Reuse Foundation's (WE&RF's) *Establishing Additional Log Reduction Credits for Wastewater Treatment Plants* (WE&RF, est. 2017) will examine biological treatment processes for protozoa, bacteria, and viruses, and will further document pathogen removal rates to assign log removal credits to various wastewater treatment steps. The Water Research Foundation (WRF) report [Assessment of Techniques to Evaluate and Demonstrate Safety of Water from Direct Potable Reuse Treatment Facilities](#) (Rock et al., 2016) provides information on methods to detect microbial indicators and pathogens.

4.4 Constituents After Drinking Water Treatment

Water treatment plants may produce constituents through the disinfection process. If ammonia levels are high in the source water and the system uses chloramination, there may be an increased chance for nitrification to occur in the distribution system, as well as elevated levels of nitrate and nitrite within the distribution system (EPA, 2002a). Since monitoring for drinking water standards occurs at the distribution system's point of entry, nitrate and nitrite could occur above the drinking water standard in the distribution system if appropriate treatment measures to prevent nitrification are not taken.

When using chlorine for disinfection, organic compounds can contribute to the formation of regulated disinfectant by-products (DBPs) such as trihalomethanes (THMs) and haloacetic acids (HAAs). Chloramination can result in the formation of N-nitrosodimethylamine (NDMA). Ozone treatment and advanced oxidation processes can also result in the formation of regulated and unregulated DBPs (Khan, 2013). Disinfection by ultraviolet light (UV), on the other hand, does not result in significant formation of halogenated DBPs. Typically, high UV doses (800 mJ/cm²) are applied with advanced oxidation processes to destroy DBPs like NDMA (Gerrity et al., 2015b) and for effective pathogen inactivation.

Additionally, drinking water treatment processes may not capture some trace chemical constituents. Numerous U.S. sites have detected trace chemical constituents in drinking water supplies and finished drinking water at very low concentrations (generally on the order of ng/L with rare exceptions in µg/L (i.e. lithium)) (Benotti et al., 2009; Furlong et al., 2017). Advances in monitoring technologies have enabled the quantification of chemicals in water at parts per trillion (ppt) (10⁻¹²) and even parts per quadrillion (10⁻¹⁵) concentrations (EPA, 2012a). The effects of long-term exposure to chemical combinations and their degradation products at extremely low concentrations is unknown and an area of potential public concern (WHO, 2012). Based on available information, there is no indication that using highly-treated reclaimed water for potable purposes poses a greater health risk than using existing water supplies (NRC, 2012a). Indeed, potable reuse treatment facilities have consistently produced water with lower concentrations of trace chemicals than most of the Nation's tap water (Snyder, 2014).

CHAPTER 5

Risk Analysis

Although it is not feasible to completely eliminate risks from conventional treatment or those associated with reuse, in both cases, it is possible to produce high-quality water that, from a scientific standpoint, does not present a significant risk. One approach to addressing the risks associated with reclaimed water includes providing treatment to remove a specified minimum concentration of chemicals or pathogens. Rigorous methods such as advanced oxidation and reverse osmosis (RO) have frequently been employed to meet these treatment objectives; additionally, multiple treatment modalities may be incorporated to provide redundancy in treatment trains.

Individual unit processes in a potable reuse treatment train operate within limitations dictated by source water quality, removal capacities, maintenance requirements, and failure modes. These limitations as a whole define the overall capacity of a treatment train to produce water quality that is protective of human health. Understanding health hazards associated with chemicals and pathogens in source water allows the design of treatment trains with sufficient capacity, reliability, and redundancy.

Advanced treatment may be required to reach protective levels for key water quality parameters. Some constituents may be difficult to assess directly, and in some cases, detection methods could be insufficient to detect levels of viruses and protozoa that could potentially cause disease. In other cases, some chemicals' toxicological information may be insufficient to define required detection limits and/or to evaluate concentrations in terms of health risk.

Additional information is needed to identify those parameters, chemical and pathogenic, that place restrictions on drinking water treatment plant design (e.g. impose a need for advanced oxidation and/or RO). Risk analysis, which is the nexus of risk assessment and risk management, can inform questions related to these parameters and other constituents of concern in drinking water. A state or drinking water utility may want to consider whether to analyze case-specific risks to ensure their systems using indirect or direct potable water reuse adequately protect consumers and meet all SDWA and relevant state requirements.

5.1 Risk Assessment

Risk assessment is a formal process for developing qualitative and quantitative information on possible adverse health effects associated with chemical and pathogen exposure. It involves estimating the nature and potential for adverse health effects in humans potentially exposed to chemicals or pathogenic organisms in contaminated environmental media. Risk assessments that yield meaningful water quality criteria and drive the design of system reliability, system redundancy (multiple barriers), and effective treatment monitoring can be useful for ensuring public health protection.

For direct potable reuse (DPR), the key information supplied to risk managers from risk assessments includes evaluation of hazards represented by chemicals and pathogens in drinking water, identification of uncertainties in estimates of health risk, recognition of gaps in knowledge that may affect confidence in the risk assessment process, and, often, consideration of concentrations that are protective of public health. This section discusses some of the tools that can characterize constituents of concern or indicators used for potable reuse, including standard chemical risk assessment procedures, quantitative microbial risk assessment, and comparisons with water quality in indirect potable reuse (IPR) situations.

5.1.1 Quantitative Risk Assessment

In both conventional drinking water treatment systems and in IPR and DPR processes, there are chemicals and pathogens present in source water that are not fully understood and do not have an available maximum contaminant level (MCL) or other criteria to inform health impacts and treatment requirements. Using available toxicological or pathological data, along with extrapolation and uncertainty factors, is one approach to developing chemical and pathogenic health-based criteria. Quantitative estimates of health risks are the basis for developing water quality standards such as MCLs. These estimates require toxicity or infectivity criteria that reflect the quantitative relationship between exposure and adverse health effects.

Chemicals

Quantifying risks from chemical exposure has a long history in the United States. EPA developed guidance for estimating health risks that follows a four-step process: hazard identification, dose-response assessment, exposure assessment, and risk characterization (see EPA, 2016d for more information on this process). EPA's guidance, or a close adaptation of it, is used by other federal agencies and most state regulatory bodies.

When toxicity criteria are available, cancer risks are estimated in consideration of the potential exposure and the potential cancer potency of the compound. This calculation generates an estimate of the potential cancer risks associated with chronic chemical exposure. Risks of 1 in 1 million to 1 in 10,000 (1×10^{-6} to 1×10^{-4}) have frequently been used as a target risk for setting Agency standards.

Non-carcinogen hazards are estimated by comparing the potential exposure to the estimated safe dose level (typically referred to as a reference dose, RfD) to determine the potential for adverse health effects to occur. This comparison of potential chemical exposure and the RfD produces a ratio termed a hazard quotient (HQ). Values above one suggest that health impacts could occur. The higher the HQ, the greater the concern for such impacts; but, a HQ is not an estimate of the odds of these impacts occurring.

Pathogens

Health risks related to pathogen exposure can be quantified using a process analogous to that used for chemicals, known as quantitative microbial risk assessment (QMRA), as defined in **Chapter 3**. A key issue for determining pathogen health risks is understanding the pathogen doses needed to cause an infection or illness. Dose-response relationships are established for some pathogen exposures and potential occurrences of disease that are relevant to drinking water (Soller et al. 2018). Using QMRA, the potential health impacts from pathogens (e.g., *Cryptosporidium* oocysts) in potable supplies can be estimated quantitatively, which can provide useful information on recommended log removal goals for a potable reuse treatment train.

As discussed in Soller et al. (2018), "IPR projects in California apply the "12/10/10 Rule", meaning viruses should be reduced by 12-logs through treatment, and *Cryptosporidium* and *Giardia* by 10-logs each (CDPH, 2014; NWRI, 2013). These log-reduction values are intended to achieve a 1 infection per 10,000 people per year benchmark and were initially derived from the maximum reported densities of culturable enteric viruses, *Giardia lamblia*, and *Cryptosporidium* spp. found in raw sewage (Macler and Regli, 1993; Metcalf and Eddy, 2003; Sinclair et al., 2015; EPA, 1998b). California is now considering the same microbial log-reductions for DPR projects (Olivieri et al., 2016), which are also intended to achieve a risk benchmark of 1 infection per 10,000 people per year (NWRI, 2013; 2015; TWDB, 2014)."

However, QMRAs coupling updated pathogen density estimates (Eftim et al., 2017) with more recently published dose-response relationships (Messner et al., 2014; Messner and Berger, 2016; Van Abel et al.,

2017; Teunis et al. 2016) suggest higher log-removal values may be necessary to consistently achieve the 1 infection per 10,000 people per year benchmark. For example, Soller et al. (2017; 2018) highlight that cumulative annual risks are driven by the highest daily pathogen raw wastewater values; this is especially true for Norovirus and *Cryptosporidium spp.* Soller et al. (2018) found that enteric viruses should be reduced by 14-logs, and *Cryptosporidium spp.* and *Giardia* by 11-logs to consistently meet the benchmark of 1 infection per 10,000 people per year in 95% of the simulations. On the other hand, the World Health Organization (WHO) (2017) used a Disability Adjusted Life Year risk assessment approach and found that enteric viruses should be removed by 9.5-logs, enteric bacteria by 8.5-logs, and enteric protozoa by 8.5-logs.

Dose-response relationships for other pathogens, such as *Legionella*, are more complex. This bacterium can grow readily within home plumbing devices, such as hot water heaters, and within commercial air conditioning units, hot tubs, and decorative fountains, making it more difficult to quantify in water systems. Exposure occurs most commonly through inhalation rather than ingestion, further complicating dose-response relationships. Exposure and associated pathogen risk are important issues; but, monitoring disease-causing agents and disease incidence is quite difficult. This difficulty is due to a number of factors: die-off and replication of organisms in finished and wastewater effluent/receiving water, inability to distinguish viable and non-viable agents (for some methods), differences in human sensitivity, large numbers of serotypes and strains with differing infectivity, sensitivity of sampling methods, and the difficulty in tracking disease incidence within communities. Also, many pathogens are detected using culture methods that may not yield results until long after the exposure has occurred.

In some cases, the use of well-studied indicator organisms might help circumvent some of these complications. As an example, *Clostridium spp.* might be used to estimate the survival of protozoan pathogens *Cryptosporidium* and *Giardia*. Spores of these bacteria are relatively resistant to treatment; their survival during drinking water treatment may be similar to *Cryptosporidium* oocysts and *Giardia* cysts survival. Thus, the more easily monitored bacterium might be a surrogate for survival of the two protozoa. Typically, titers of protozoan oocysts and cysts are too low to be directly monitored to indicate treatment effectiveness. Rather, EPA relies on the measurement of engineering process control parameters such as turbidity and CT values to inform treatment effectiveness.

5.1.2 Alternative Risk Assessment Methods

Alternative risk assessment methods are available that take a broader approach to evaluating risks than the previously described quantitative assessments. These methods, both qualitative and quantitative, are described below and may be particularly useful for potable reuse evaluation.

5.1.2.1 Relative Risk Assessment

One qualitative means of addressing the risks posed by chemicals and pathogens in wastewater effluent is to compare water quality across a range of planned IPR, *de facto* reuse, and DPR cases. Where drinking water complies with drinking water standards, based on studies or long-term observation, recycled water of similar or better quality can adequately protect human health. Under this approach, a similar water quality could indicate the safety of the recycled water supply rather than defining specific limits for additional water quality parameters (NRC 2012a).

For example, the Texas Water Development Board (TWDB) recently produced a resource document that contains a quantitative relative risk assessment (QRRRA) comparing two raw surface water sources and two wastewater treatment effluents after disinfection and filtering (TWDB, 2015). From a health risk standpoint, as defined by the QRRRA, water quality from the two raw sources did not differ substantially from the wastewater effluents' water quality. That is, differences noted in various water quality parameters did not

translate into substantive differences in possible health impacts. The Texas Water Development Board (TWDB) QRRRA does not emphasize a comparison of IPR to DPR or a comparison of *de facto* reuse to DPR. However, the study approach does make some appropriate comparisons for a limited number of cases of raw water and treated effluent.

5.1.2.2 Probabilistic Risk Assessment

A more rigorous quantitative approach to risk assessment recognizes that, in some cases, health risks are best understood using probabilistic (stochastic) risk assessment. Probabilistic methods use distributions instead of point estimates to define inputs to MCLs, treatment technique requirements, or equivalent criteria, and produce a range of target concentrations or titers that could be health protective.

Probabilistic risk assessments use the same methods described previously to arrive at a range of risk estimates. This range will provide a more complete assessment of possible health impacts. For instance, deterministic risk assessments typically provide a conservative estimate of exposure levels and associated potential health impacts. A probabilistic analysis may show that such risks are atypical and may allow flexibility in the design of treatment methods based on the site-specific characterization of DPR designated wastewater effluent.

In addition, a probabilistic model can help set reasonable bounds for exposure and target pathogen densities in drinking water. This approach can further differentiate input parameters to risk calculations that are most critical for defining health risk. This information is important for designing treatment methods that specifically address key factors in reducing exposure and risk to consumers.

Finally, probabilistic risk assessment can be coupled with similar treatment train assessments to provide an overall assessment of water quality in finished water. As mentioned in **Chapters 3 and 4**, a study conducted a QMRA to evaluate microbial risks associated with DPR treatment trains, expanding on a previously published statistical approach suggested by Haas and Trussell (1998) and demonstrated by Olivieri et al. (1999) (Soller et al., 2017). This approach was the first quantitative evaluation of the microbial risks associated with various multi-barrier DPR treatment strategies. More recent sophisticated approaches are discussed in *Evaluation of microbiological risks associated with direct potable reuse* (Soller et al., 2017) and *Direct potable reuse microbial risk assessment methodology: sensitivity analysis and application to State log credit allocations* (Soller et al. 2018).

5.1.2.3 Other Methods

Computational toxicology attempts to use the totality of in vitro and in vivo data available in the toxicological literature to predict some of the characteristics of chemicals that are not well-studied or even new chemicals as a first step in safety evaluation. This field is still developing and has not yet been used to address potential concerns associated with water reuse. The field is likely to become increasingly important to all areas of toxicology in the coming years and may represent a viable means to develop toxicity criteria for unregulated chemicals.

5.2 Risk Management

Risk analysis uses the information from the risk assessment, along with policy and legal requirements, to inform decision-making; if risk reduction measures are needed, then any necessary control options are selected and monitored for the protection of public health (Asano et al., 2007). This latter process is the risk management component of the analysis.

Risk assessment can provide information on health risks associated with reuse into the process of effective treatment design. This information includes target chemical or pathogen concentrations/titers that can protect human health and uncertainties in these targets that require consideration in decisions on how to manage health risks. Risk management is the process of deciding how best to address potential health risks. It requires consideration of legal, economic, and behavioral factors, as well as the ecological and human health and welfare effects of each decision/management alternative. Management may consider regulatory and non-regulatory responses to protect public health. An example of a risk management action includes determining appropriate discharge levels for a river that feeds into a drinking water supply. Thus, the difference between risk assessment and risk management is that risk management is the action taken based on consideration of the risk assessment; *EPA Risk Characterization Handbook* (EPA, 2000b) describes the factors considered:

1. Scientific factors provide the basis for the risk assessment, including information drawn from toxicology, chemistry, epidemiology, ecology, and statistics. Factors of age, sex, race, etc. fall into this category.
2. Economic factors inform the manager on the cost of risks and the benefits of reducing them, the costs of risk mitigation or remediation options, and the distributional effects.
3. Laws and legal decisions are factors that define the basis for the Agency's risk assessments, management decisions, and, in some instances, the schedule, level or methods for risk reduction.
4. Social factors, such as income level, ethnic background, community values, land use, zoning, availability of health care, lifestyle, prevalence of underlying health conditions, and psychological condition, may affect exposure to and/or susceptibility of individuals or groups to a particular stressor, leading to greater health risk.
5. Technological factors include the feasibility, impacts, and range of risk management options.
6. Political factors are based on the interactions among branches of the Federal government, with other Federal, state, and local government entities, and even with foreign governments; these may range from practices defined by Agency policy and political administrations through inquiries from members of Congress, special interest groups, or concerned citizens.
7. Public values reflect the broad attitudes of society about environmental risks and risk management.

5.2.1 Risk Reduction Concepts and Management

In addition to water quality criteria that are anchored in human health risk assessment, there is ongoing work to address operational risks while providing treatment to achieve reuse water quality that is protective of the consumer. A WasteReuse Research Foundation (WRRF) study titled *Risk Reduction for Direct Potable Reuse* reviewed the development of an operational risk assessment framework for practical public health protection that employed a cost-effective approach specifically relating to DPR (WRRF, 2014a). This operational risk framework applies for both individual unit processes and from an overall system standpoint through four steps; **Figure 5-1** illustrates these steps (WRRF, 2014a). The four risk reduction concepts central to ensuring safety in potable reuse schemes include multiple barriers, system reliability, system redundancy, and process coupling.

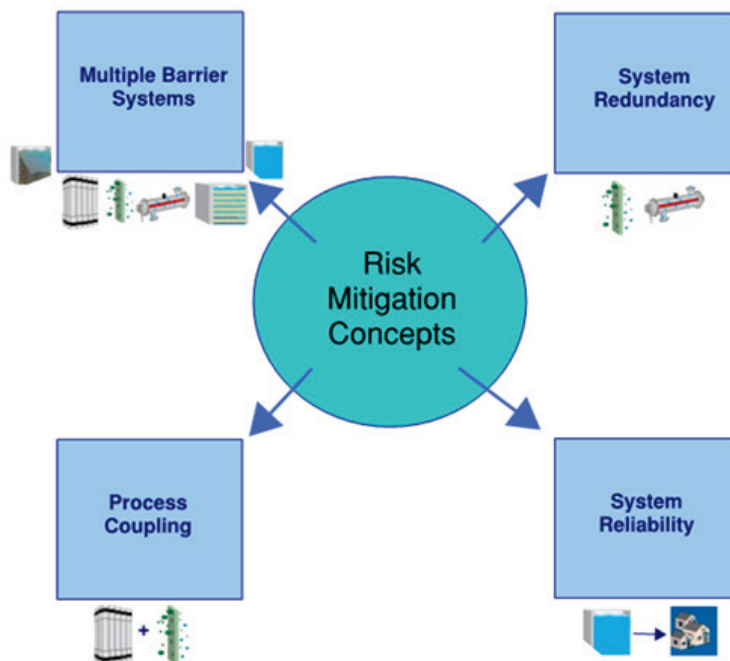

Figure 5-1. Risk mitigation concepts in potable reuse schemes (adapted from WRRF, 2014a)

5.2.1.1 Multiple Barrier Systems

Multiple barrier systems are a component of potable reuse schemes because they provide several individual processes capable of stopping the flow of pathogenic organisms and chemical substances into treated effluent water. In a multiple barrier scenario, no single treatment step is responsible for meeting target effluent requirements; instead, each step is partially or completely redundant of another (WRRF, 2014a). Design plans incorporate multiple barriers into the treatment scheme: monitoring at multiple and various points of the treatment process, real-time or near real-time monitoring, operator certification, training, a combination of treatment steps, and wastewater effluent control programs that strive to limit the amount of toxic substances entering the waste stream prior to wastewater treatment. The purpose of multiple barriers is to decrease the probability of process failure by adding units of reliability and redundancy to the treatment scheme; this ensures that if one step of the process fails, another treatment unit will reliably provide public health protection (Khan, 2013). Regulatory agencies employ an approach called log removal value (LRV) or log removal credit (LRC) to verify the functionality of multiple barriers for pathogen control. Regulatory agencies grant LRVs based on pathogen removal and/or inactivation knowledge of the individual unit treatment process (Khan, 2013). The LRVs required to achieve effluent targets, as set by regulation or permitting mechanism, are calculated and compared to actual treatment results for validation (Khan, 2013). The California Division of Drinking Water (DDW), for example, controls pathogens and forces multi-barrier design in groundwater replenishment reuse systems by requiring that the recycled municipal wastewater achieves at least 12-log enteric virus reduction, 10-log *Cryptosporidium* oocyst reduction, and 10-log *Giardia* cyst reduction (see Cal. Code Reg. tit. 22 § 60320.108, 60320.208). California DDW requires at least three individual treatment processes in the treatment works, and each step is credited with a maximum of 6-log reduction (see Cal. Code Reg. tit. 22 § 60320.108, 60320.208). The purpose of the maximum log removal and/or inactivation credit value is to ensure that reuse projects are designing systems that achieve *de minimis* risk levels utilizing the multiple barrier approach.

5.2.1.2 System and Process Reliability

Some of the earliest guidance on process reliability was published by EPA in 1974 in *Design Criteria for Mechanical, Electric, and Fluid System and Component Reliability* (EPA, 1974). The document was meant to supplement the *Federal Guidelines for Design, Operation, and Maintenance of Wastewater Treatment Facilities* by establishing minimum practices of reliability for mechanical, electric, and fluid systems and components. At the time of publication, there was a great deal of federal funding available for new construction and wastewater treatment plant (WWTP) upgrades, and the design criteria under this guidance document was often a requirement for obtaining federal financial assistance, including grants (EPA, 1974).

EPA's document defined reliability:

“A measurement of the ability of a component or system to perform its designated function without failure.”

This definition has been readily used by many other technical documents. It is also important to note that the reliability concept applies not only to the system, but also individual system components. The wastewater system includes the main wastewater treatment as well as the solids handling system and other auxiliary systems. A component is a single piece of equipment that performs a specific function; in this context, a component could be an entire process or may be a single piece of equipment, e.g., a pump.

Extending this concept of reliability to potable reuse treatment trains will likely have a positive effect on public perception, because consumers must trust that the system's performance protects public health (Asano et al., 2007). Utilizing extensive monitoring techniques within the potable reuse scheme is one way to demonstrate that the process is performing reliably. The evaluation of reliability in a system is done through risk assessment. There are several factors that may impact the reliability of a system including wastewater quality and its fluctuations, variation of both biological and advanced treatment processes, the level of automation and type of equipment, the effectiveness of employed monitoring techniques, and the accessibility of back-up materials such as equipment replacements and connections to power supplies (Asano et al., 2007). Additionally, operator reliability includes the level of awareness, skills, and knowledge of the system to ensure a high degree of safety in the potable reuse scheme (Khan, 2013).

As an example from another industry, aviation and space flight is a high-risk industry and, as such, places a large emphasis on the “fail-safe design” principle. Fail-safe design means that if a failure or combination of failures were to occur, the result would not be catastrophic (WRRF, 2014a). The aviation industry uses a concept called “hours-to-failure” to classify the integrity of a certain structural element by estimating the time of use in hours before a deficiency occurs that results in decreased strength (WRRF, 2014a). This concept could be applied to DPR, such as in the integrity testing of an RO system. Given that systems inevitably have failures within their lifetime, there are fail-safe design principles that apply following a system failure. These include approaches such as Hazard Analysis and Critical Control Points (HACCP), which gives an assessment of points within the system where impactful failures could occur (WRRF, 2014a). The International Space Station (ISS) water recycling system (WRS) serves as an example of a fail-safe design within the space flight industry (EPA, 2012a). The WRS has treated urine and humidity condensate to potable water quality for astronauts to consume since 2008 (EPA, 2012a). Given that the WRS is the sole source of water in outer space, the design must exemplify robustness, require minimal maintenance, and guarantee high-quality effluent. The WRS system incorporates methods that operate relatively independent of one another, meaning one component of the treatment process could malfunction without being detrimental to the end-product. This dynamic is known as being “loosely coupled” (WRRF, 2014a). Although it is inappropriate to apply the specific ISS WRS system to DPR, the fundamental goal remains the same;

systems providing potable water to the public should be designed to be fail-safe, meaning they produce water that is safe for public consumption and meets target effluent requirements.

5.2.1.3 System Redundancy

Redundancy is one method of ensuring system reliability. Redundancy in its simplistic form refers to the use of “backup” treatment methods should a given treatment method malfunction or underperform (WRRF, 2014a). Redundancy in potable reuse schemes is crucial because water is continuously distributed. Continuous operation and source water production requires a mechanism to produce high-quality water, even in the event of mechanical or structural failures, servicing of equipment, or a power failure (Asano et al., 2007).

This concept of system redundancy is not new to the water and wastewater treatment industry. While there are not federally mandated system redundancy requirements, state and/or local permitting agencies have the authority to implement rules, regulations, or guidelines with respect to facility design. And, in fact, most states do have some form of system redundancy guidance that is evaluated during plans review for facility permitting. The status of U.S. states with respect to redundancy guidance, as of 2003, is provided in **Figure 5-2**; a Water Environment Research Foundation study gathered this information to document efficient redundancy design practices so that WWTPs could optimize treatment for efficiency.

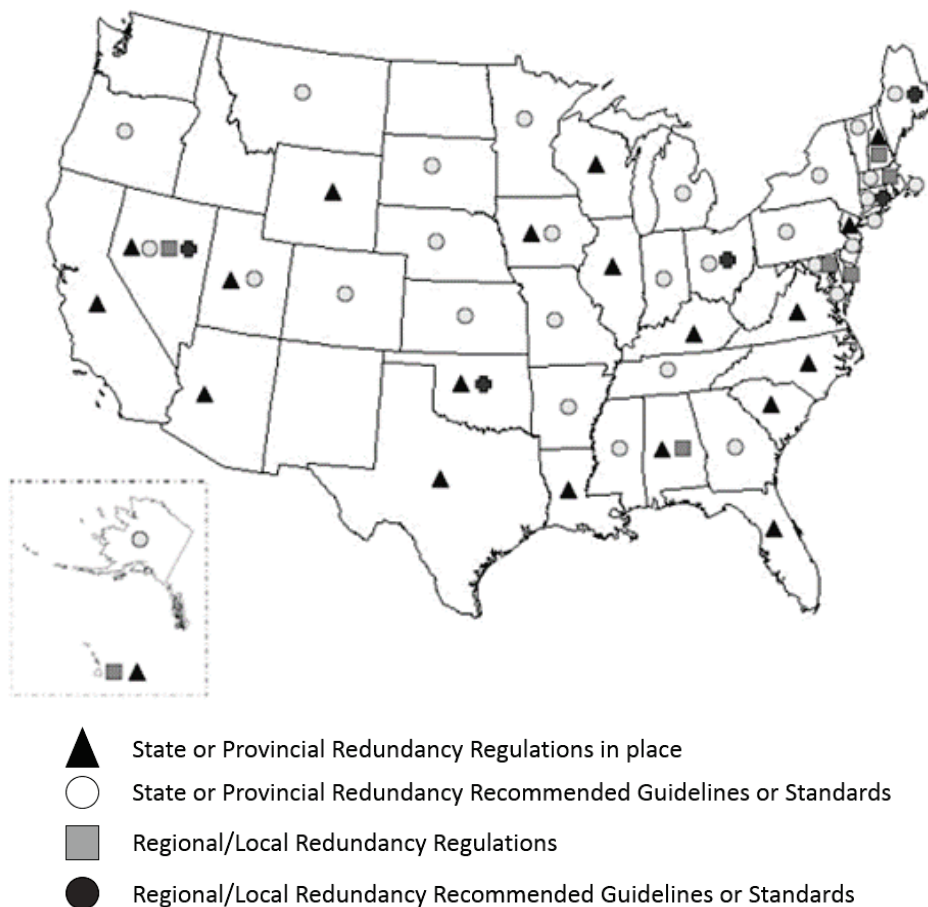

Figure 5-2. States with redundancy regulations or requirements (WERF, 2003)

5.2.1.4 Process Coupling

Process coupling is important to potable reuse schemes because it characterizes the dependency of one unit process on an upstream process (WRRF, 2014a). Process coupling ranges from loose to tight, where tightly coupled systems tend to operate highly dependent on another process. There are some negative effects found within tightly coupled systems: difficulty of intervention to mitigate local process failures, explicit design regarding buffers and equipment replacements, and very specific procedures to achieve effluent targets – where a deviation from the ideal procedure could result in global system failure (WRRF, 2014a). Potable reuse and most engineered systems favor loosely coupled systems.

5.2.2 Risk Analysis Framework

The risk analysis framework utilizes the concepts discussed above to generate methods for identifying, characterizing, and mitigating human health risks associated with potable reuse. This approach already accounts for the fact that in many scenarios, treated wastewater effluent is returned to the environment and is regulated under the Clean Water Act (CWA), which uses a risk-based approach to establish discharge standards. Further, EPA already establishes standards for drinking water that are anchored in human health risk assessment. Utilizing a similar risk approach is appropriate when evaluating the potential health risks associated with drinking water supplies originating from wastewater or wastewater effluent.

In addition to extending the approaches used by Soller et al. (2017; 2018), TWDB (2015), or WHO (2017) to more DPR projects, it is also important to consider opportunities for DPR approaches to improve the quality of the source water for drinking water supplies. By applying more consistent controls on the quality of wastewater effluent used in DPR, these systems have the potential to improve the overall safety of drinking water provided to the public.

Efforts are being expended to modify and refine risk frameworks for evaluating health impacts of potable reuse. Additional work in this area is expected in the near future from the EPA, the Water Environment Federation (WEF) and the Water Environment and Reuse Foundation (WE&RF), all of which are interested in examining the relative health risks associated with different source waters, including systems using planned IPR, *de facto* reuse, and DPR. Risk analysis in the evaluation of water reuse is evolving rapidly and is likely to undergo further modification and refinement in the next several years.

5.3 Summary

Risk analysis for potable reuse schemes consists of an initial assessment of health hazards associated with the source water, followed by a risk management phase where treatment is designed to protect consumers from both acute and chronic illnesses.

A comprehensive risk management framework for DPR still awaits definition and development. Since potable reuse, including limited DPR, is already occurring and will increasingly be an important potential solution for community water resource needs, effective risk management strategies will continue to be critical as potable reuse projects advance.

CHAPTER 6

Treatment Technologies for Potable Reuse

6.1 Overview: Five Overall Treatment Objectives for Potable Reuse

The purpose of this chapter is to provide an overview of individual unit processes used in advanced wastewater treatment facilities (AWTFs) for potable water treatment. An AWTF employs advanced wastewater treatment (extending beyond secondary treatment) for direct and indirect potable reuse applications. Individual unit processes are assembled in a range of combinations to achieve water quality appropriate for potable reuse, as described in **Chapter 7** of this document. It is important to note that potable reuse facilities rely on upstream controls including rigorous source control programs (**Chapter 8**) and effective treatment of raw wastewater at a wastewater treatment plant (WWTP). After treatment in an AWTF, the water may be sent to an environmental or engineered buffer (**Chapter 9**), or to a drinking water treatment plant (WTP). Depending on the type of environmental buffer employed, the water may or may not undergo additional treatment after extraction.

There are five main objectives for AWTFs: removing suspended solids, reducing dissolved chemicals, disinfection, water stabilization, and producing water with satisfactory aesthetics (**Table 6-1**) (Khan, 2013).

Table 6-1. Overall treatment objectives and corresponding unit processes

Overall Treatment Objectives	Processes to Accomplish Treatment Objectives
Removal of Suspended Solids	<ul style="list-style-type: none"> • Coagulation • Flocculation • Sedimentation • Media filtration • Microfiltration (MF) • Ultrafiltration (UF)
Reducing the Concentration of Dissolved Chemicals	<ul style="list-style-type: none"> • Reverse osmosis (RO) • Electrodialysis (ED) • Electrodialysis reversal (EDR) • Nanofiltration (NF) • Granular activated carbon (GAC) • Ion exchange • Biologically Active Filtration (BAF)
Disinfection and Removal of Trace Organic Compounds	<ul style="list-style-type: none"> • Ultraviolet disinfection (UV) • Chlorine/chloramines • Peracetic acid (PAA) • Pasteurization • Ozone • Chlorine dioxide; • Advanced oxidation processes (UV/H₂O₂, O₃/H₂O₂, UV/Cl₂) (AOP)
Stabilization	<ul style="list-style-type: none"> • Sodium hydroxide • Lime stabilization • Calcium chloride • Blending

Overall Treatment Objectives	Processes to Accomplish Treatment Objectives
Aesthetics (taste, odor, and color control) *	<ul style="list-style-type: none"> O3/Biologically Activated Carbon (BAC) MF/RO

* Taste and odor control and color removal does not necessarily require separate treatment processes in advanced wastewater treatment schemes. For example: O3/GAC or BAC and MF, RO typically address these issues.

6.2 Removal of Suspended Solids

AWTFs are responsible for further purifying treated effluent from conventional wastewater treatment. The conventional wastewater treatment process does not remove all suspended solids (Asano et al., 2007; Khan, 2013). Suspended solids, such as bacteria, viruses, and protozoan cysts and oocysts, can be a threat to human health if present in treated effluent (Khan, 2013). Additionally, the presence of particulates can negatively impact the performance of downstream treatment processes such as reverse osmosis (RO) and disinfection. Filtration capabilities with media filters are a function of the operating conditions, design conditions, and source water quality, and may demonstrate large variations in treatment effectiveness from changes in flow rate, feed water quality, or chemical dosing. In contrast, filtration capabilities with membranes are primarily a function of the membrane's pore size. Commercially available microfiltration (MF) and ultrafiltration (UF) membranes consistently remove large pathogens such as protozoan cysts; smaller pathogens such as viruses and bacteria require either smaller pore sizes (such as in nanofiltration (NF) or RO membranes) or adsorption to larger particles which may subsequently be removed (EPA, 2012a). **Sections 6.2 - 6.4** describe treatment processes that provide the removal of particulates, including pathogens, and include media filtration, MF, and UF. The distinguishing characteristic of these different types of filtration is the size of particles that each technology can remove, as shown in **Figure 6-1**.

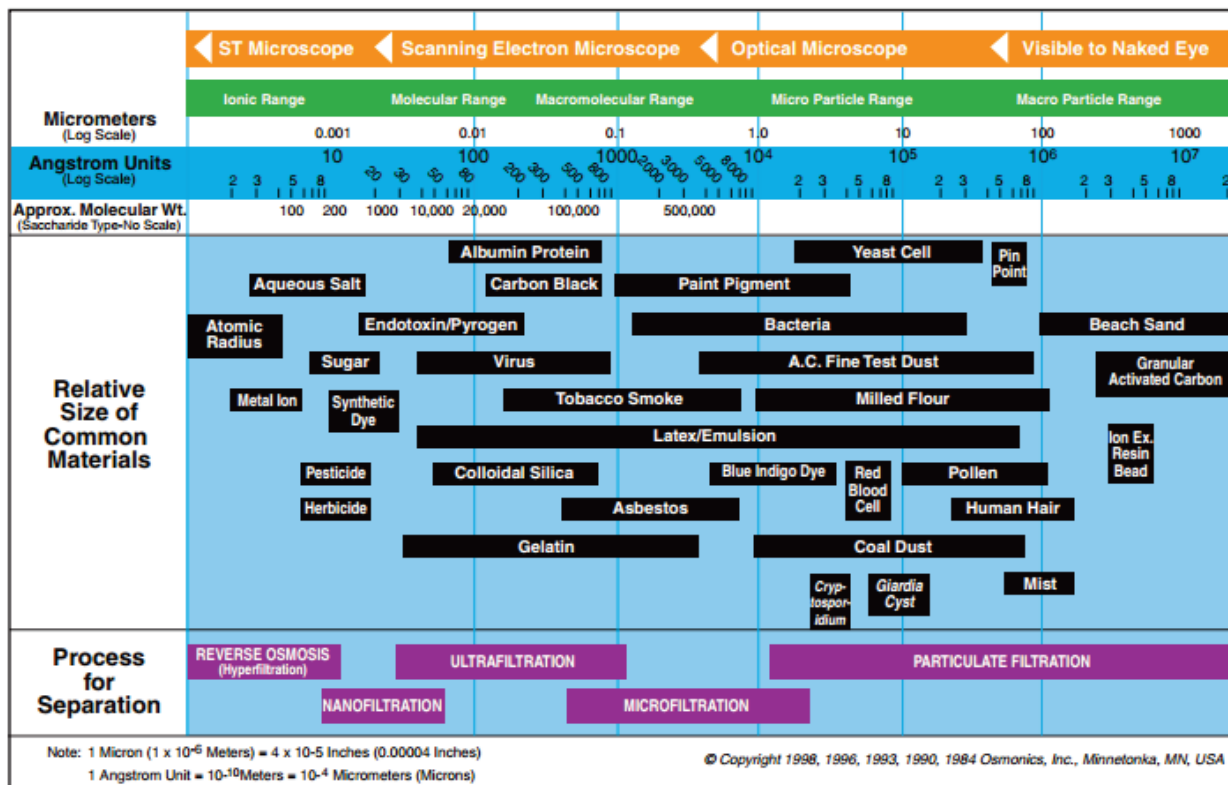

Figure 6-1. Size ranges for various filtration processes (source: GE Osmonics, 2000)

6.2.1 Media Filtration

Sand and media filtration are examples of particle filtration through porous beds of granular media by gravity or pressure differentials (EPA, 2012a; Khan, 2013). Particle removal in potable reuse treatment trains serves dual purposes. First, the removal of solids removes microbial agents including pathogens and those associated with particulates, colloids, or organics. Secondly, removal of particles improves the effluent quality for disinfection and other subsequent treatment processes. Lower concentrations of organics and other particulates can reduce the demand for chemical oxidants in disinfection; additionally, lower turbidities can improve UV disinfection by increasing the UV transmittance and allowing pathogen removal that otherwise may be shielded from UV light. There are two general mechanisms for particle removal through media filtration: physical adsorption and size exclusion. Physical adsorption occurs when smaller particles and pathogens adsorb to the surface of larger particles (filter media) and are subsequently removed. Size exclusion occurs when suspended solids are larger than the open spaces in the filter media and are physically excluded at the media surface (EPA, 2012a; Khan, 2013). Depth filtration is effective through physical adsorption processes and most commonly utilizes several feet of packed sand, anthracite, garnet, or other non-compressible media as the filter media (EPA, 2012a). The effective media size for non-compressible media filters ranges from 0.4 and 2.0 mm in average diameter (EPA, 2012a). Depth filters can contain one or more filter media types at specified depths. Some examples of media filters are slow sand filters, monomedia rapid sand filters, and multi-media filters containing anthracite, sand, and/or gravel (AWWA, 2011a). Depth filtration can also utilize compressible synthetic media (EPA, 2012a). Media filtration generally relies on coagulation, flocculation, and settling to increase contaminant particle size and improve filterability. For this reason, removal effectiveness is highly dependent on operating conditions and the feed water quality. Rapid changes in flow or feed water quality can result in high levels of particulate breakthrough in a media filter due to temporary non-optimal coagulant doses.

6.2.2 Microfiltration and Ultrafiltration

Microporous membrane filtration, such as MF and UF, began being used for large scale municipal water treatment in the early 1990s (Yoo et al., 1995) and was adapted for use in wastewater treatment later that decade (Cote et al., 2012). In potable reuse applications, membrane filtration processes can be used as pretreatment to RO to mitigate fouling or clogging of the RO membrane (Wetterau et al., 2013).

A membrane is a thin porous polymer film or a ceramic structure separating two phases that act as a selective barrier to the transport of matter (EPA, 2012a). Polymeric membrane filters are commonly made from one of three materials:

- Polypropylene.
- Polyvinylidene fluoride.
- Polysulfone and polyethersulfone.

Each material has different advantages and challenges, but all polymeric membranes run at least some risk of membrane breakage, which compromises the effectiveness of the membrane. Ceramic membranes offer an alternative without the risk of breakage, but they have not seen widespread use. Additionally, costs are considerably higher than polymeric membranes, and they may not have an established direct integrity testing method to receive pathogen credit.

Membrane filters function primarily by size exclusion, achieving near complete removal of all contaminants greater than the nominal pore size. As such, membrane filters typically achieve little-to-no removal of dissolved solids and other contaminants smaller than the nominal pore size. Unlike with media filters,

operating conditions, such as flow rate, feed water quality, or filtration run length impact the removal effectiveness of a membrane filter. While membrane filters can remove dissolved organic material when used in conjunction with coagulation or powdered activated carbon (PAC) (AWWA Subcommittee, 2008), most membrane filtration plants (particularly those in the United States) utilize filtration without coagulant or PAC, allowing dissolved organic constituents to pass through unchanged. “MF membranes have a nominal pore size between 0.1 μm and 0.2 μm ,” allowing them to achieve near complete removal of all suspended solids, protozoa, and bacteria, with limited removal of viruses (CORPUD, 2014). “UF membranes have a nominal pore size between 0.01 μm and 0.08 μm ,” achieving significantly higher removal of viruses, although not all viruses (CORPUD, 2014). Neither type of membrane achieves significant removal of dissolved organic matter, nor any measurable impact on total dissolved solids (TDS) (AWWA, 2005).

“For both UF and MF systems, membrane geometry typically [consists] of hollow fiber membranes, where several hollow fibers are wrapped in a tubular formation, with filtration occurring through the walls of the fibers” (CORPUD, 2014). MF and UF systems most commonly use an outside-in operation, where the influent water goes from outside the membrane, through the membrane, into the small hollow fibers, and finally moves to downstream processes (CORPUD, 2014). “The suspended solids and pathogens remain on the outside of the membrane where they are then backwashed to waste” (CORPUD, 2014). “There are a few inside-out membrane filtration systems,” “including the world’s largest membrane-based reuse facility in Kuwait” (CORPUD, 2014). MF and UF membranes for municipal use are most commonly configured as hollow fibers that are packaged into modules containing 4,000 to 20,000 individual membrane fibers, and range from 0.5 to 2 meters in length and 0.5 to 2 mm in diameter (Khan, 2013). The substances that do not pass through the filters are periodically backwashed from the membrane modules and transported to waste, or returned upstream to the wastewater treatment plant.

Both MF and UF systems contain a backwash system and a chemical clean-in-place (CIP) system, with chemical cleanings needed periodically (roughly once per month) to improve plant efficiency and reverse membrane fouling (CORPUD, 2014). “The CIP systems typically clean the membranes about once a month if the influent water is relatively clean[; but,] some reuse facilities utilize chemical cleanings on a more frequent basis” (CORPUD, 2014). Water quality impacts CIP periods: it occurs more frequently in “waters with high organic content, high microbial presence, or high coagulant doses, and less frequently in higher quality source waters, such as wastewaters [that use] full nitrification” (CORPUD, 2014). For example, the Orange County Groundwater Recharge System in California has a “typical cleaning interval of 14-21 days when treating secondary effluent with only partial nitrification” (**Figure 6-2** and **Figure 6-3** show the submerged MF and RO membranes at OCGWR, respectively) (CORPUD, 2014; see **Appendix A**). Generally, CIP systems “apply a combination of acid and sodium hypochlorite to the membranes, coupled with an air scour as necessary, and proprietary detergents [on occasion]” (CORPUD, 2014). Some manufacturers use sodium hydroxide as a CIP chemical (CORPUD, 2014).



Figure 6-2. Submerged MF membranes at OCGWR



Figure 6-3. RO system at OCGWR

Pretreatment for membrane filtration is used primarily to prevent fouling and membrane damage, rather than to enhance the filtration process. Automatic strainers, with slot or screen sizes between 100 and 500 microns, are used to remove large particulates that could damage polymeric membranes or plug up the filter modules. In wastewater, it is also common to maintain a continuous chlorine or chloramine concentration in the feed water to prevent biofouling; but, this is not essential if a sufficiently low membrane flux (or filtration rate) is maintained and the membranes are chemically cleaned and backwashed on a frequent basis. Membrane filters can treat either settled secondary effluent in a tertiary application or mixed liquor in a membrane bioreactor.

Membrane filtration requires a driving force for water to pass through. There are two general configurations for membranes: submerged and pressurized (CORPUD, 2014). Membranes in submerged systems are “suspended in a basin, and the feed water is at atmospheric pressure;” a pump adds vacuum pressure on the membrane’s filtrate side (CORPUD, 2014). “Pressurized systems typically use pumps to apply a trans-membrane pressure to the feed, [and] the filtrate is at roughly atmospheric pressure” (CORPUD, 2014). The pressure difference generated across the membranes in submerged and pressurized configurations drives the filtration process and suspended solid and pathogen removal (CORPUD, 2014). Historically, submerged systems were more common for large facilities (>10 million gallons per day (MGD)), while pressurized systems were more common with smaller facilities. This has changed in recent years, and both types of systems can be seen in various sized plants.

6.3 Reducing the Concentration of Dissolved Chemicals

Chapter 4 describes trace chemical constituents potentially present in raw wastewater. Unit processes that achieve degradation and/or removal of dissolved chemicals include RO, electrodialysis (ED), electrodialysis reversal (EDR), NF, granular activated carbon (GAC), ion exchange, and biologically active filtration (BAF). These treatment technologies are described below.

6.3.1 Reverse Osmosis

RO is a physical separation process in which feed water is forced through a semi-permeable membrane using a pressure gradient to separate permeate from a concentrated reject (concentrate). In RO, the feed

water must be pressurized to exceed the osmotic pressure difference between the feed and permeate, while providing additional driving pressure to overcome hydraulic losses of water passing through the membrane material. RO is used extensively for the desalination of seawater and brackish groundwater; potable reuse can also take advantage of RO because of its ability to effectively remove pathogens, dissolved chemical substances, total organic carbon (TOC), trace organic compounds, and TDS (Wetterau et al., 2011). The RO membranes most commonly used in drinking water treatment today are composed of a thin film composite, which includes a thicker support structure and a thin membrane skin. Two flat sheet membranes are glued together at their edges, with the membrane skins facing out and a permeate spacer mesh between the membrane sheets, creating a membrane envelope. Multiple envelopes are then rolled into a spiral wound configuration, with feed spacer meshes separating each envelope, creating an individual membrane module or element. Multiple elements (typically six to eight) are placed in series within a longer pressure vessel and multiple vessels are then banked in parallel and in series to create a treatment skid (AWWA, 2007).

There are five components to an RO system:

1. A high-pressure pump, which is used to increase the pressure in the feed water to overcome osmotic force and pass permeate through the RO membranes.
2. Multiple membrane modules (typically six to eight), which are installed in series within cylindrical pressure vessels. Sets of pressure vessels are often also placed in series to create multiple stages of treatment, with the concentrate from the first stage treated by the second, increasing the amount of product water that can be recovered by the system.
3. Membrane modules, which are generally purchased in a spiral wound configuration containing multiple membrane envelopes, utilizes a feed/concentrate channel on the outside of the envelope and a permeate channel on the inside. Water passing through the semi-permeable membrane to the inside of the envelope becomes the treated permeate and is collected in a central permeate tube.
4. Permeate piping, which collects treated water from the permeate tubes inside the membrane modules and conveys the permeate from the RO system.
5. Concentrate piping, which conveys the concentrated waste stream (i.e., reject flow) to final disposal.

Sufficient pretreatment is essential for reliable operation of RO membranes; organic colloids, biological growth, and inorganic scale can all impede the production of water and cause elevated feed pressures, increased cleaning frequency, and higher operating costs. Pretreatment depends on the feed water characteristics, and designing an RO system requires a thorough chemical analysis. MF or UF traditionally serves as a pretreatment process for the RO in wastewater applications to mitigate potential fouling that results in higher operating costs, more frequent chemical cleaning, and more rapid RO membrane replacement. When fouling does occur, it decreases the membrane system efficiency, requiring more energy to treat the water. Membranes are periodically chemically cleaned to remove foulants. Foulants can cause permanent damage that requires membrane replacement. Common types of membrane fouling improve with pretreatment:

- Scaling – Scaling over the membrane can be a problem if there is high calcium, magnesium, or other sparingly soluble salts in the wastewater, or if there are high recovery rates.
- Colloidal fouling – Elevated organic material, silica, and clarifier treatment chemicals (iron or aluminum salts) can cause colloidal fouling of the membranes.

- Biological fouling – Active microorganisms often can attach to the membranes and cause biofilm; the biofilm can then block the membrane surface.

A chloramine residual is typically added to the feed water to prevent biofouling or biological growth on the membranes (both MF and RO). A free chlorine residual is not recommended in full advanced treatment (**Chapter 7**) because of the potential to damage downstream RO membranes.

One disadvantage of RO treatment is that it creates a highly concentrated reject water stream. For reuse facilities, it is important that RO waste streams are not returned to the same wastewater treatment plant supplying the flow unless the RO plant represents a very small portion of the overall plant flow (<10 percent of the total plant flow). This will avoid concentrating salts and other contaminants within a closed loop between the two plants. The most common methods for disposal of wastewater RO concentrate are ocean discharges combined with existing wastewater outfalls, sewer disposal with flows directed to a downstream wastewater treatment facility, surface water discharge and deep well injection. Because the reject stream is highly concentrated (TDS from 3,000 to 20,000 mg/L), permitting a direct discharge of RO concentrate to surface water may be difficult, unless high salinity surface waters are present. Alternate methods of concentrate disposal, not previously mentioned, include use of evaporation ponds, mechanical evaporation, brine crystallizers, and various emerging technologies such as forward osmosis and membrane distillation.

Additionally, the RO permeate requires subsequent stabilization due to the near complete removal of hardness and low alkalinity. Calcium and alkalinity are reintroduced to the RO permeate to stabilize the water, as discussed in **Section 6.6**.

6.3.2 Nanofiltration (NF)

NF membranes are commonly made of the same or similar materials and through the same processes as RO membranes (AWWA, 2007). NF membranes are typically configured in the same pressure vessels as RO and require the same pretreatment steps, making the two hard to differentiate in some instances (CDM Smith, 2014). In contrast to RO membranes, NF membranes allow the passage of more monovalent ions, while rejecting highly charged inorganic ions and larger molecular weight organic constituents (CORPUD, 2014). NF typically requires a lower feed pressure than RO and therefore can be lower in cost; however, NF can still provide an effluent water quality comparable to RO when TDS reduction is not required. Early studies looking at NF wastewater treatment found that many NF membranes fouled more quickly than the RO membranes most commonly used in potable reuse, resulting in operating pressures that were not any lower than RO (Bellona et al., 2008).

NF has two important disadvantages compared to RO. The first disadvantage is that NF membranes provide less TDS removal than RO membranes (CORPUD, 2014). The second disadvantage is that NF membranes have poor nitrate rejection (Amouha et al., 2011), which can be a crucial consideration for potable reuse schemes that treat wastewater with potentially high nitrate levels (Bellona et al., 2008). When considering NF for potable reuse treatment trains, an effective nitrogen removal process such as ion exchange or sidestream RO may need to ensure adequate removal (CORPUD, 2014).

6.3.3 Electrodialysis/Electrodialysis Reversal (ED/EDR)

ED utilizes ion selective membranes in an electrically driven process to transport mineral salts and other constituents from one solution to another, forming a concentrate and a dilute solution (Asano et al., 2007). An ED system includes both cation and anion membranes stacked in an alternate pattern between spacers with a positive electrode (anode) on one end and a negative electrode (cathode) at the other end (Asano et al., 2007). A direct current is applied, creating an electrical current potentially responsible for moving the

ions through the membranes. Ions of opposite charge from the membrane are rejected and exit the system in the form of a concentrate (Asano et al., 2007).

EDR was introduced in the early 1970's (Asano et al., 2007). EDR is identical to ED, but it employs periodic reversal of the direct current polarity as a self-cleaning mechanism (Asano et al., 2007). EDR operates most ideally using water with a TDS concentration of 1,000 to 5,000 mg/L, but it can treat water with concentrations reaching 10,000 to 12,000 mg/L.

Unlike RO and NF membranes, ED and EDR do not result in a reduction of suspended solids, pathogens, or non-charged contaminants of emerging concern (CECs), but they are capable of reducing TDS through the removal of charged ions. EDR is also effective for bromide removal, which can reduce bromate formation. With respect to potable reuse, ED and EDR would only apply in situations where other unit processes capable of removing total suspended solids (TSS), pathogens, and CECs are included in the treatment train.

6.3.4 Ion Exchange

Ion exchange incorporates a solid phase ion exchange material that is used to replace an ion in the aqueous phase for an ion in the solid phase. The most common cation application of ion exchange processes is in water softening methods, where the hardness of the water is lessened by removing magnesium and calcium ions from the water and replacing them with sodium ions from a solid phase exchange material such as polymeric resin, kaolinite, or montmorillonite. Cationic resins replace cations, whereas anionic resins replace anions. Essentially, the exchange materials have fixed charge functional groups attached to the material itself. Oppositely charged ions, known as counter ions, uphold the electroneutrality of the exchange material and the aqueous solution, allowing removal of select ions from the water via replacement. Ion exchange can remove a variety of constituents such as boron, barium, radium, arsenic, perchlorate, chromate, Na^+ , Cl^- , SO_4^{2-} , NH_4^+ , and NO_3^- (Asano et al., 2007). Ion exchange is not currently used in any potable reuse applications but could provide benefit as a polishing step for nitrate removal.

6.3.5 Activated Carbon

Activated carbon works by adsorption, which is the process by which molecules are concentrated on a solid surface. The structure of the activated carbon results in a very large effective surface area for compound adsorption. Activated carbon can have a surface area of greater than $1000\text{m}^2/\text{g}$ (Wan Nik et al., 2006). Activated carbon's characteristics and performance are influenced by the substance it is made from, which can include various materials like coal, coconut shells, or wood (NRC, 1980)

There are two primary forms of activated carbon used in water treatment processes: GAC and PAC. GAC includes "irregularly shaped particles [with] sizes ranging from 0.2 to 5 mm" (Wan Nik et al., 2006); it is often used as filtration bed media. PAC is a "pulverized [material] with a size predominantly less than 0.18mm" (Wan Nik et al., 2006).

Activated carbon can adsorb contaminants, such as organic chemicals. Activated carbon is particularly well-suited for removal of larger molecular weight and hydrophobic organic compounds, while smaller-chain hydrophilic aliphatic hydrocarbons are not as well-removed. PAC is sometimes utilized in the activated sludge process to increase solids contact, and GAC is commonly used as the media component in pressure and gravity filters (NRC, 2012a).

6.3.6 Biologically Active Filtration (BAF)

BAF is an operational practice of managing, maintaining, and promoting biological activity within a filter to enhance treatment for organic and inorganic constituents. A biofilter can be any filter that allows a biologically active layer to establish and colonize the filter media surface. Examples include slow sand filtration, rapid rate filtration with or without preoxidation, GAC filtration with or without preoxidation, riverbank filtration, aquifer filtration, and anoxic biological treatment (Evans et al., 2010). Typically, indigenous microbial organisms populate the biofilter, and contaminants are biodegraded through direct substrate utilization or cometabolism. Biofilters can remove turbidity, natural organic matter (NOM), disinfection by-product precursors, taste and odor compounds, iron, manganese, ammonia, algal toxins, and trace chemical constituents including pharmaceuticals and personal care products (Evans et al., 2013; Bouwer and Crowe, 1988; Hoeger et al., 2004; Evans et al., 2010; Hozalski and Bouwer, 2001; Wunder et al., 2008).

Water quality and operational parameters such as pH, temperature, and hydraulic loading rates can impact treatment performance (Evans et al., 2013). Biofiltration does not remove TDS. Potable reuse treatment trains that utilize biofiltration and require TDS management may couple other processes such as EDR or RO in a split stream treatment scenario to achieve site-specific TDS targets. **Chapter 7** further discusses biofiltration.

6.4 Disinfection and Removal of Trace Organic Compounds

Disinfection is used as an additional barrier after removing suspended solids and reducing dissolved chemical concentrations. **Chapter 4** describes pathogens potentially present in raw wastewater. With respect to drinking water from surface water systems and groundwater systems under the direct influence of surface water (GWUDI), disinfection treatment requirements are driven by source water quality, as indicated in the Surface Water Treatment Rules; the 2006 Ground Water Rule regulates contaminated groundwater. **Chapter 3** provides further elaboration on these rules.

While the primary purpose of disinfection is to inactivate pathogenic microorganisms, some disinfection processes can also degrade chemical contaminants through oxidation (CDM Smith, 2014). The disinfection technologies used throughout a potable reuse treatment train are designed to meet recreational water quality criteria and extend into oxidation and advanced oxidation to address trace organic contaminants. Disinfection technologies that might apply in a potable reuse scenario include UV, chlorination, peracetic acid disinfection, pasteurization, chlorine dioxide, ozone, and advanced oxidation processes (AOPs).

6.4.1 UV

UV light is considered a biophysical disinfection method primarily because of its ability to prevent microorganisms from replicating; this is because light is absorbed by nucleic acids and results in dimerization (Khan, 2013). At high UV doses, UV photons are capable of breaking chemical bonds that have lower energy than the photons themselves (CDM Smith, 2014).

There are three types of UV lamps currently used in water treatment at WWTPs, AWTFs, and WTPs. These include low-pressure low output, low-pressure high output (LPHO), and medium pressure (MP). The most common lamp type used in water treatment applications is the LPHO lamp with a monochromatic output at a wavelength of 254 nanometers. While LP lamps are also commonly employed due to their low energy consumption in comparison to MP lamps, LPHO systems are usually employed in low dose applications, such as permitted wastewater discharges to surface waters. MP UV lamps are used at facilities with limited

space because they are more energy intensive, and the high output allows for the use of fewer lamps; but, these lamps have a lower germicidal efficiency.

The water quality parameters of concern for UV disinfection systems are UV transmittance (UVT), which is related to TSS and particle size. Utilizing filtration methods prior to disinfection can enhance UV disinfection performance. UV intensity, a measure of the incident UV light, is directly related to the UVT; the higher the UVT, the higher the intensity (actual UV intensity is also affected by the extent of sleeve fouling, power input, and the age of the lamps). The UV dose is the UV intensity multiplied by the exposure time. Shielding of target organisms can occur when high TSS or turbidity are present in water. In some cases, higher doses of UV light can help overcome this shielding, but it may not be possible to provide adequate disinfection in some secondary effluents (CDM Smith, 2014). In direct potable reuse (DPR) treatment trains in particular, employing high UV doses (~800 mJ/cm²) are critical for both pathogen removal (Soller et al. 2017; Soller et al. 2018) and carcinogenic by-products, such as N-nitrosodimethylamine (NDMA) (Gerrity et al., 2015b)

6.4.2 Chlorine/Chloramines

Chlorine disinfection is the most widely used form of disinfection in water and wastewater treatment in the United States. Chlorine may be applied as chlorine gas, liquid sodium hypochlorite, or as solid calcium hypochlorite. On a pound for pound basis, chlorine gas is much less expensive than other chlorination methods, but it poses significant safety challenges regarding storage and handling (CORPUD, 2014). As such, many U.S. utilities converted to alternative technologies to eliminate its use.

Raw wastewater contains nitrogen in the form of ammonia; plants that provide only secondary treatment cannot convert or remove ammonia. When ammonia remains in the secondary effluent and chlorine (in any form) is added to the water, the chlorine reacts to form chloramines. Although dependent on the chlorine to nitrogen ratio and operating parameters such as pH, temperature, and contact time, the dominant forms of chloramines are monochloramine and dichloramine, and the less common form is trichloramine. These types of chloramines also serve as disinfectants; but, they are significantly less effective at inactivating pathogens, especially for viruses, and react slower when compared to free chlorine (White, 1986; EPA, 1989a). Because chloramines are a less powerful disinfectant than free chlorine, they tend not to oxidize trace chemical constituents; therefore, chloramination reduces the likelihood of some disinfection by-products, such as trihalomethanes, haloacetic acids, and chlorate (EPA, 1999b). However, chloramines can increase the formation of nitrosamines, such as NDMA (Wetterau et al., 2011).

The two types of residual chlorine, free and combined, are distinguished by the disinfection method utilized and the breakpoint chlorination curve (Szerwinski et al., 2012). When breakpoint chlorination is used (along with a free chlorine reagent during analysis), the measured chlorine residual is known as the free chlorine residual as shown in **Figure 6-4**.

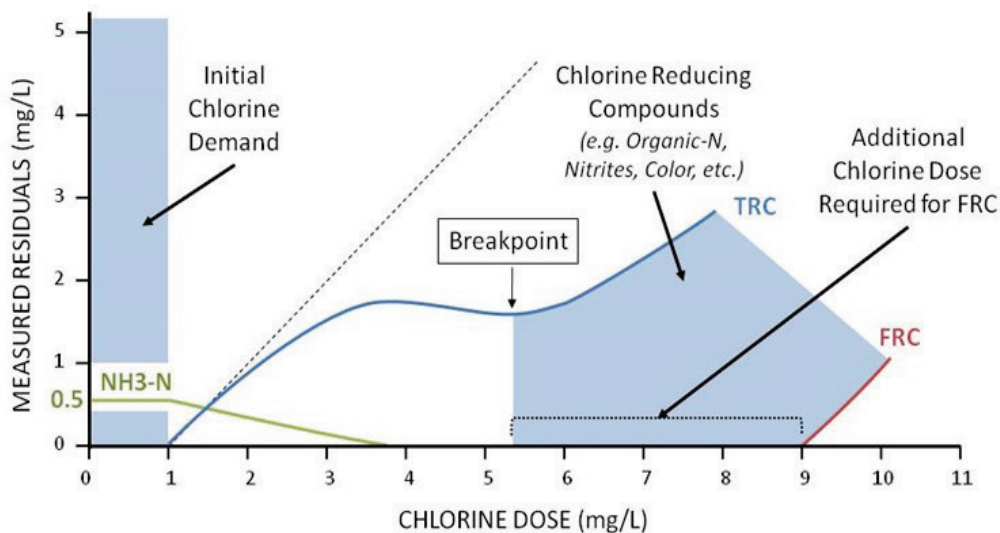

Figure 6-4. Typical breakpoint chlorination curve

When chloramines are the sole disinfectant, the measured chlorine residual is combined chlorine (dependent upon the reagent used during analysis). The breakpoint chlorination curve determines the amount of chlorine needed to oxidize organic and inorganic material and leave a free chlorine residual to achieve pathogen reduction (Asano et al., 2007). Many U.S. drinking water systems utilize combined chlorine in the distribution system to overcome issues associated with regulated disinfection by-product (DBP) formation, such as THMs and HAAs.

6.4.3 Peracetic Acid (PAA)

PAA can be used as a wastewater disinfectant, although it is a relatively new method in the United States. There are only a few WWTPs currently using PAA, but it has a long history of use in the food, beverage, medical, and pharmaceutical industries (CORPUD, 2014). PAA is delivered as an equilibrium mixture of acetic acid, hydrogen peroxide, PAA, and water. The PAA component of the solution has the chemical formula $\text{CH}_3\text{CO}_3\text{H}$. PAA performance as a disinfectant is dependent upon water quality and operating conditions. At pH values below seven, PAA's disinfection efficacy increases (CORPUD, 2014). Disinfection with PAA requires very low doses and short contact times to inactivate bacteria (Kitis, 2003). Additionally, because of PAA's widespread use in the medical and agricultural industries, there is a significant body of information that suggests that PAA is effective against viruses and protozoa. Further, when paired with UV processes for wastewater disinfection, the efficacy increases substantially (Asano et al., 2007). Additionally, PAA does not form known harmful disinfection by-products.

6.4.4 Pasteurization

Recently, pasteurization gained attention in the wastewater disinfection field. In sewage sludge processing, pasteurization produces Class A Biosolids (EPA, 2012a). The efficacy of pasteurization depends on operating conditions such as temperature and exposure time, characteristics of the organisms of interest, and characteristics of the medium (EPA, 2012a). Pasteurization processes could save operational costs compared to other disinfection methods, such as UV, because waste heat can preheat undisinfecting water. While the process received California Title 22 approval for reclaimed water disinfection, only one pasteurization unit appears to be in operation to date at a small municipal facility in Graton, California (CSWRCB, 2014). This facility is utilizing the process to provide reclaimed water for non-potable use.

6.4.5 Chlorine Dioxide

Chlorine dioxide has a high oxidation potential and therefore excellent germicidal power. While chlorine dioxide is commonly used in drinking water treatment, there are no U.S. publicly owned treatment works utilizing this technique for wastewater disinfection or reuse. It is both an effective bactericide and virucide and achieves more effective inactivation of viruses than chlorine itself. Chlorine dioxide is inherently unstable and readily decomposes and is typically generated onsite. The required dose for meeting disinfection objectives varies based on the pH and the microorganisms in the water. It is thought to be similarly effective as combined chlorine at inactivating bacteria, and similarly effective as free chlorine at inactivating viruses (Asano et al., 2007). Chlorine dioxide was included as a toolbox option for *Cryptosporidium* inactivation in the Long Term 2 Enhanced Surface Water Treatment Rule (LT2ESWTR) and dose tables for receiving inactivation credit were provided (EPA, 2006b). But, a major drawback to chlorine dioxide is that it can form toxic disinfection by-products such as chlorate and chlorite (NRC, 2012a). The control methods (other than process control management of dose/residual application) to mitigate these DBPs can be costly, including the addition of ferrous iron, sulfite, or using granular activated carbon to absorb the ions (Asano et al., 2007).

6.4.6 Ozone

Ozone (O_3) is a disinfection technology commonly used in drinking water treatment. Ozone is a powerful oxidant, capable of breaking down organic compounds including taste and odor compounds and trace chemical constituents. The concept of using ozone for wastewater and reclaimed water treatment gained increasing interest in recent years; a handful of plants have adopted the technology (Gerrity et al., 2015a; EPA, 2012a) because of its ability to provide disinfection and oxidation of organic carbon, including CECs.

Ozone is produced when oxygen separates into atomic oxygen; the result is an unstable gas (O_3). It is likely that free radicals form when ozone is decomposed. HO_2 and $HO\cdot$ are responsible for a significant portion of the oxidation in the disinfection process, making ozone an AOP (Asano et al., 2007). Ozone is a potent chemical disinfectant with an oxidant electrode potential (redox potential) of 2.08 V at 25 degrees Celsius and is very effective at pathogen inactivation - stronger than both chlorine (0.8 to 1.5 V) and monochloramine (0.7 to 0.8 V) at 25 degrees Celsius (James et al., 2004). Because ozone is an unstable gas that decomposes to elemental oxygen very rapidly after generation, it requires on-site generation. In general, an ozone disinfection system typically includes the following major components:

- Oxygen supply system (typically liquid oxygen is supplied to tanks onsite, but it can also be generated onsite at large capacity facilities).
- Ozone generators and the associated power supply units (PSUs).
- Ozone contactors and associated ozone gas transfer systems.
- Ozone contactor off-gas handling and residual ozone gas destruction systems and ozone gas monitoring and control systems.

Recent ozone technology improvements have made the process more energy efficient. Some of these improvements include oxygen production for feed gas, improvements in generator technologies, and injection technologies that allow higher mass transfer efficiencies. Additionally, improvements in dielectric technology, materials of construction, power supply components, control methods, and ozone generation production control logic resulted in reduced energy requirements and many economic benefits.

Ozone is a mature disinfection technology that merits serious consideration as a cost-effective treatment option for potable reuse treatment trains, particularly in light of the recent advances in ozone generation and application technologies. It is increasingly evaluated for its applicability to reuse, primarily because it is

the only mature disinfection alternative capable of treating complex, non-degradable trace organic compounds (e.g., pharmaceutical and personal care products and endocrine disrupting compounds (EDCs)) at typical disinfection doses (CORPUD, 2014).

Ozone can replace MF, UF, or RO processes and supplement biofiltration within potable treatment trains to remove trace chemical constituents; additionally, it can be a pretreatment process for MF to increase MF performance (CORPUD, 2014). However, when polymeric filters are utilized, the ozone residual must be dissipated before filtration to protect against the oxidation of the membrane material. Ozone can also be used as a disinfectant either in place of UV-AOP or in conjunction with UV to produce an AOP.

6.4.7 Advanced Oxidation Processes (AOPs)

AOPs can destroy trace chemical constituents. AOPs produce the hydroxyl radical (HO•), which is a very powerful oxidant (Asano et al., 2007). The breakdown products at different doses and water qualities are largely unknown, although organic compounds can be oxidized to CO₂ at extreme doses. Because of their unique ability to destroy and not just remove these compounds, AOP is often a final component of treatment trains in potable reuse applications (Asano et al., 2007). While AOP is part of the full advanced treatment train (described further in **Chapter 7**), it may not be necessary when additional treatment will be applied at a downstream public water system. AOP prior to discharge to a surface water storage reservoir is generally unnecessary. However, AOP may be quite useful at WTPs that have taste and odor issues, and also as a treatment tool to address contaminants that may pass through the previous treatment processes.

6.4.7.1 UV/Hydrogen Peroxide

The combination of UV light and hydrogen peroxide (H₂O₂) results in two simultaneous mechanisms responsible for the degradation of trace chemical constituents (CORPUD, 2014). The first mechanism is UV photolysis (discussed in **Section 6.4.1**), and the second mechanism is the generation of hydroxyl radicals through the UV light and hydrogen peroxide reaction (CORPUD, 2014). In some instances, low concentrations of very small compounds including trace chemical constituents may remain in permeate from upstream RO processes; UV/hydrogen peroxide is effective at oxidizing these constituents (CORPUD, 2014). It has been applied successfully in the development of potable reuse projects such as the Orange County GWRS (California), West Basin Advanced Water Treatment Plant (AWTP) (California), Vander Lans AWTP (California), Big Spring (Texas), and Cloudcroft (New Mexico) (CORPUD, 2014).

6.4.7.2 Ozone/Hydrogen Peroxide

Ozone/hydrogen peroxide AOP is an alternative process to UV/hydrogen peroxide and used for taste and odor control in drinking water. The combination of ozone/hydrogen peroxide results in lower power costs than UV/hydrogen peroxide (CORPUD, 2014). Ozone/hydrogen peroxide also results in higher removal efficiencies for some select trace chemical constituents (CORPUD, 2014). However, the process achieves lower removal rates of NDMA and other light sensitive species when compared with UV-based AOPs (CORPUD, 2014). In situations where the reclaimed water has sufficiently low nitrosamine concentrations, or where the UVT is a limiting factor, ozone/hydrogen peroxide may be a viable process alternative (Gerrity et al., 2013a).

6.4.7.3 UV/Chlorine

UV/Chlorine, like UV/hydrogen peroxide, utilizes photolysis and the formation of hydroxyl radicals to degrade small, trace chemical constituents in reclaimed water (CORPUD, 2014). The UV/chlorine process requires a free chlorine residual and is very sensitive to pH; but, it can be more efficient than UV/hydrogen peroxide when chlorine demand is low, and the pH is less than 6 to 6.5 (Wetterau et al., 2015b). For this

reason, UV/chlorine offers advantages for AOP in RO permeate but may offer fewer advantages in non-RO based reuse facilities that have higher pHs. UV/chlorine offers three primary advantages for direct potable reuse, independent of any operational or capital cost savings. First, chlorine is a far superior disinfectant to hydrogen peroxide, providing disinfection redundancy not present in the UV/hydrogen peroxide process. Secondly, use of UV/chlorine avoids the need for peroxide quenching prior to the drinking water treatment plant, or prior to introducing the purified water into a drinking water system. Finally, UV/chlorine offers a low cost means of integrity monitoring through the measurement of free chlorine residual. As of 2015, UV/chlorine was not used at any indirect potable reuse (IPR) or direct potable reuse (DPR) facilities; but, it has been full-scale tested in California at the Vander Lans AWTP and the Cambria Emergency Water Supply, and it is planned for the Terminal Island AWTP plant expansion (Wetterau et al., 2015a). The drawback to UV/chlorine AOP is that little research exists on the disinfection by-products that may form during this treatment process.

6.5 Aesthetics

Public perception will play a substantial role in the future acceptance of DPR schemes. The end result of the scheme is the final purified water (or drinking water) that the general public ultimately consumes. It is important to emphasize the aesthetic properties of the final purified water with respect to taste, odor, and color. Independent of the consistent safety of a purified product, the water will be judged based on how it tastes, looks, and smells. Water which stains sinks or discolors glasses is viewed negatively, regardless of how well the treatment processes remove regulated and unregulated contaminants. In potable reuse applications, the goal is to produce an effluent free from any objectionable taste, odor, or color, while meeting or exceeding the aesthetic quality of any existing local drinking water supplies. **Table 6-2** lists some potential aesthetic compounds from wastewater.

Table 6-2. Aesthetic compounds potentially present in untreated municipal wastewaters

Contaminant	Noticeable Effects above the Secondary MCL
Aluminum	Colored water
Chloride	Salty taste
Color	Visible tint
Copper	Metallic taste; blue-green staining
Corrosivity	Metallic taste; corroded pipes/ fixtures staining
Fluoride	Tooth discoloration
Foaming agents	Frothy, cloudy; bitter taste; oily, fishy, or perfume-like odor
Iron	Rusty color; sediment; metallic taste; reddish or orange staining
Manganese	Black to brown color; black staining; bitter metallic taste
Odor	"Rotten-egg," musty or chemical smell; quantified by TON
pH	Low pH: bitter metallic taste; corrosion high pH: slippery feel; soda taste; deposits
Silver	Skin discoloration; graying of the white part of the eye
Sulfate	Salty taste

Contaminant	Noticeable Effects above the Secondary MCL
TDS	Hardness; deposits; colored water; staining; salty taste
Zinc	Metallic taste

6.5.1 Taste and Odor Control

Taste and odor issues in water can arise from a variety of different sources. For example, surface waters may have significant algal blooms or groundwater may contain dissolved minerals such as iron and manganese. Disinfection by-products formed during treatment can cause taste and odor problems in water. Salinity can also cause taste issues (EPA, 2012a). Inaccurate chlorine dosing can result in product water that tastes or smells like bleach. Industrial discharges such as phenols cause a distinct “medicinal” taste. Demineralized effluent from RO or NF can have a taste often described as “metallic” if it is not sufficiently stabilized through hardness addition (Khan, 2013).

Two well-known compounds that negatively affect the taste and odor of water are *Geosmin* and *2-methylisoborneol* (MIB). These compounds are naturally occurring in lakes and reservoirs and cause an earthy, musty smell and taste in the water. The taste and odor concerns associated with these compounds are not related to any negative health effects, but they can cause public discontent (NRC, 2012a).

Processes that incorporate powerful oxidants are typically good strategies for controlling taste and odor (i.e. ozone, chlorine dioxide, AOP), but strong oxidants run the risk of harmful by-product formation. Activated carbon (PAC, GAC) is another method that can effectively reverse poor aesthetics. The combined process of ozone and biologically activated carbon (BAC) effectively controls taste, odor, and color (CORPUD, 2014). UV/chlorine is also an effective means of taste and odor control as demonstrated by Watts et al. (2012).

6.5.2 Color

When there is a hue in wastewater, it may be due to dissolved organic material or inorganic constituents such as metals. Even waters without visible color can cause staining of sinks and plumbing fixtures over time. Ozone is effective at lessening organic related hues in water, but ozone can oxidize manganese to permanganate, causing a purple color in water. Dissolved organic carbon (DOC), iron, and manganese concentrations can be used as indicator parameters to trace whether a wastewater has lost its “color” identity (Trussell et al., 2013). Although color is not an enforceable primary drinking water regulation, EPA’s Safe Drinking Water Act secondary standard is 15 color units (EPA, 2017k).

6.6 Stabilization

In instances where RO or NF processes treat reclaimed water, it is typically necessary to stabilize the water by remineralization techniques (Chalmers et al., 2010). RO and NF remove minerals, such as calcium and magnesium, and produce a permeate water with pH often below 6. The resulting product water is extremely corrosive and can cause severe corrosion in metal piping or concrete tanks. Advanced treated water is stabilized through some combination of decarbonation, or addition of lime, caustic soda, and/or calcium chloride. The stabilization generally targets a Langelier Saturation Index (LSI) near or above zero through the addition of hardness and alkalinity (AWWA, 2007). Other stabilization indices, such as the Ryznar Stability Index, can be used in addition to the LSI to determine stabilized water. The following paragraphs provide basic information on processes commonly used for product water stabilization in RO and NF facilities. For additional information, AWWA has published a *Manual of Practice: Internal Corrosion Control in Water Distribution Systems* (AWWA, 2011b).

6.6.1 Decarbonation

Often after RO treatment, packed tower aerators are used to remove carbon dioxide and increase the pH of the permeate without the addition of chemicals, or in addition to other chemical usage. Decarbonation can be a low cost means of increasing the pH when sufficient carbonate alkalinity is present. However, removal of carbon dioxide does not impact the total alkalinity of the water and, in some cases, can increase the amount of chemicals required to reach a stabilized LSI value. Decarbonation can provide advantages if other dissolved gases or volatile chemicals, such as trihalomethanes, hydrogen sulfide, methane, or radon, are present in the water.

6.6.2 Sodium Hydroxide

Sodium hydroxide, or caustic soda, is the most common chemical used for pH adjustment after RO. The addition of sodium hydroxide will increase the total alkalinity and pH of the water, increasing the LSI and producing a more stable product water. Because RO permeate is generally low in hardness as well as alkalinity, sodium hydroxide alone is rarely sufficient for producing a stable product water.

6.6.3 Lime Stabilization

Calcium oxide, or lime, can be used for product water stabilization, adding alkalinity, hardness, and pH to the water with a single chemical (Khan, 2013). Lime can be purchased as either quicklime (CaO), which requires the use of a slaker, or hydrated lime (Ca(OH)_2), which can be added directly (Khan, 2013). Lime is often challenging to work with; this is due to clumping in the dry feed equipment, dust accumulation, and turbidity carryover in the water. While lime is often the lowest cost means of stabilizing RO product water, many utilities choose to avoid it due to its operational challenges.

6.6.4 Calcium Chloride

Calcium chloride can add hardness to water, but it does not impact the pH or alkalinity. For this reason, calcium chloride needs to be used in conjunction with another chemical, such as sodium hydroxide. Calcium chloride can be purchased in liquid form, and it does not cause turbidity when added to water. While it is costlier than lime, some utilities have chosen to use calcium chloride and caustic soda for stabilization to avoid the operational challenges associated with lime.

6.6.5 Blending

Blending with fresh surface waters is an additional way to stabilize water following RO or NF treatment. Mixing the treated water with water of appropriate quality can restore hardness and alkalinity levels. Blending is a cost-effective restabilization method when sufficient blend water is readily available; the Wichita Falls emergency DPR system took this approach (see case study in **Appendix A**).

In DPR schemes, blending could occur at different steps throughout the treatment process; it could occur before entry into an engineered storage buffer, after storage in the buffer, or before introduction into the potable water system (WRRF, 2011a). Blending advanced treated wastewater with conventional source water prior to consumption may or may not occur within a given DPR scheme; this depends on site-specific constraints (Khan, 2013). For example, some DPR systems may not need to target TDS for removal if they anticipate high ratios of blending with low TDS source water. Additionally, blending with conventional source water may mean that remineralization of the DPR water is not required (Khan, 2013). Different blending configurations can occur within a DPR system. Blending of reclaimed water with alternative water supplies could occur prior to advanced wastewater treatment or drinking water treatment (Khan, 2013). Researchers are investigating the potential to blend purified water with conventionally treated water or even direct distribution. A Water Research Foundation study titled *Blending Requirements for Water from Direct*

Potable Reuse Treatment Facilities will evaluate the possible blending scenarios and associated impacts (WRF, est. 2018).

6.7 Summary Table of Treatment Technologies

Table 6-3 summarizes the effectiveness of the treatment technologies discussed in this chapter with respect to achieving three of the five treatment objectives.

Table 6-3. Treatment technologies and associated treatment capabilities (adapted from CORPUD, 2014)

Overall Treatment Objective	Unit Processes	TOC	TSS	TDS	Trace Chemical Constituents	Pathogens ⁵
Removal of Suspended Solids	Media Filtration, Microfiltration and ultrafiltration	R (Minimal)	R	-	-	R ⁶
Reducing the Concentration of Dissolved Chemicals	NF/RO	R ³	R	R	R ¹	R
	ED/EDR	-	-	R	-	-
	PAC	R	-	-	R	-
	GAC	R ³	R	-	R ³	R (Minimal)
	Ion exchange	-	-	R	R	-
	Biofiltration	R, D ^{3,4}	R	-	D ⁴	R
	Ozone	-	-	-	D ²	D
Disinfection and Removal of Trace Organic Compounds	UV	-	-	-	D ²	D
	Free Chlorine	-	-	-	D ²	D
	Chloramines ⁷	-	-	-	-	D ²
	PAA ⁸	-	-	-	D ²	D
	Pasteurization ⁸	-	-	-	D	D
	Ozone	-	-	-	D ²	D
	Chlorine dioxide	-	-	-	D ²	D
	Advanced oxidation processes (UV/H ₂ O ₂ , O ₃ /H ₂ O ₂ , UV/Cl ₂)	-	-	-	D ²	D

Key:

Pink = no impact, orange = partial impact; green = significant impact

R = constituents that are physically removed; D = constituents that are degraded or destroyed

Notes:

¹ Some chemical constituents may have RO removal efficiencies less than 90%, such as NDMA, 1,4-dioxane, and flame retardants. Additionally, RO likely has greater removal efficiency than NF.

² Removal depends on contaminant dose and contact time.

³ TOC removal is 40-60% and 98% for GAC/BAC and RO/NF, respectively.

⁴ BAC is effective at removing trace chemical constituents, but, BAC will result in higher TOC levels than RO.

⁵ Actual removal efficiencies vary by unit process depending on the specific constituent or group of constituents of concern. The doses and contact times used in some processes, such as oxidation, define the extent of removal of

pathogens. In any case, potable reuse applications should always employ multiple barriers to ensure redundancy and resiliency.

⁶ MF and UF membranes can remove bacteria and protozoa. MF is not considered an effective barrier against viruses, while UF can remove viruses to a certain extent.

⁷ Extended chloramine contact times are required for virus inactivation, but, no *Giardia* or *Cryptosporidium* inactivation should be anticipated with chloramine disinfection.

⁸ Currently used only in wastewater treatment.

6.8 Residuals Management

As in conventional WTPs and WWTPs, the residuals generated from potable reuse treatment trains must be managed. This can include treatment, reuse, and/or disposal. The residuals produced from an AWTF can include screenings, backwash solids and liquid streams, and RO concentrate (NWRI, 2015). Solids from backwashing and screening are commonly macerated and returned to the WWTP, where they are mixed with other process solids, removed/disposed, and/or incinerated. Reject streams and backwash water (other than RO concentrate) are often returned to the WWTP or AWTF inlet for retreatment (NWRI, 2015).

In AWTFs utilizing RO, RO concentrate management is a major consideration. In coastal regions, the concentrate is sometimes sent to ocean outfalls (NWRI, 2015). Where ocean outfalls are not practical, or are not permitted by state or local ordinance, concentrate may be treated using various brine concentration and crystallization methods or other salt recovery techniques. This results in a residual that must be disposed of as a solid waste or sold if the quality of the final product is sufficient for the market. Alternatively, if it is feasible, concentrate disposal may be accomplished more cost-effectively through deep-well injection, surface water discharge, land application, or discharge to the wastewater collection system (for small flows). The *Framework for Direct Potable Reuse* describes some of the common RO concentrate management approaches, regulatory considerations, and costs (NWRI, 2015). Refer to **Chapter 11** for a discussion of the costs of residuals management.

CHAPTER 7

Alternative Treatment Trains for Potable Reuse

7.1 Overview

Chapter 6 covered individual unit treatment processes. This chapter will cover the integration of these unit processes into a number of different treatment trains. A treatment train is a series of unit processes that treat water to the desired effluent quality (NWRI, 2015). Advanced wastewater treatment for potable reuse involves a strict source control program of raw wastewater treatment at a wastewater treatment plant (WWTP) and additional treatment at an advanced wastewater treatment facility (AWTF). Subsequently, the advanced treated wastewater may go to an environmental buffer, an engineered buffer, or a drinking water treatment plant. While some researchers are evaluating the feasibility of introducing AWTF water directly into the potable water distribution system, this scenario is not currently practiced in the United States.

Treatment trains for water reuse are assembled to address site-specific requirements and developed based on influent water quality characteristics and applicable federal, state, and local regulatory requirements. Other factors such as energy requirements, operation and maintenance (O&M) requirements, capital and O&M costs, staffing considerations, and affinity with existing operations also determine the optimal treatment train (Asano et al., 2007). There are numerous possible combinations of unit processes for specific reuse applications. In potable reuse applications, the treatment train needs to encompass redundancy and reliability against waterborne pathogens and chemical contaminants to protect public health. It also should allow enough time to address any loss in integrity of any components of the treatment train.

There are two ways to achieve redundancy within the treatment train. First, system designs can build in redundancy by providing additional capacity within each unit process (e.g., N+1). Second, the system design can utilize multiple treatment barriers capable of collectively removing a wide range of constituents with varying physiochemical properties, including inorganic contaminants, organic contaminants, viral, bacterial, and protozoan pathogens. As described in the 2012 *Guidelines for Water Reuse* it may not always be necessary to provide such high levels of redundancy given the effectiveness and reliability of available technologies (EPA, 2012a). There is the potential to “over-design” AWTFs using large margins of safety to account for uncertainty in target treatment objectives for unregulated chemical compounds (Gerrity et al., 2013a; NRC, 2012a).

Figure 7-1 illustrates different potable reuse treatment trains. The key distinguishing difference between indirect potable reuse (IPR) and direct potable reuse (DPR) is the lack of an environmental buffer in DPR.

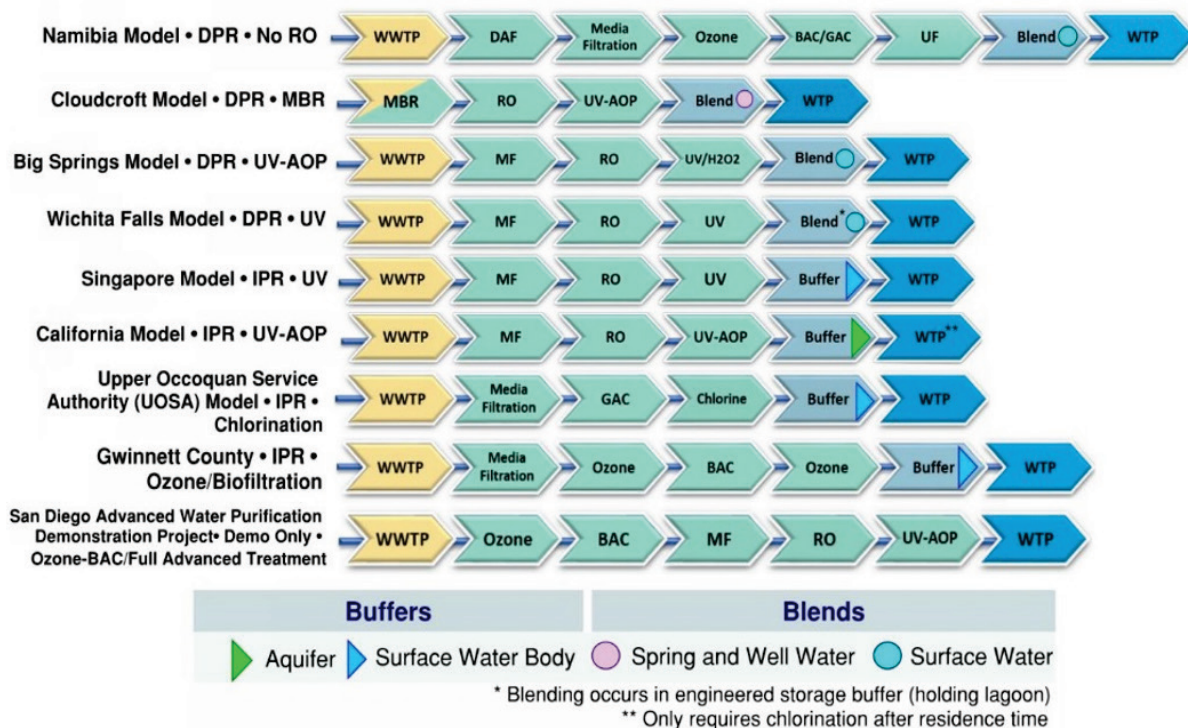

Figure 7-1. Overview of potable reuse treatment trains in existence as of 2015 (not intended to be a complete survey)

7.1.1 Multiple Barrier Approach

In 1982, a document titled *A Guide for the Planning, Design, and Implementation of a Water Reclamation Scheme* highlighted critical aspects of potable reuse learned from a DPR plant in Namibia (PGJ Meiring & Partners, 1982). The document emphasized that incorporation of multiple barriers in potable reuse treatment trains is crucial to ensuring public health protection. The concept of multiple barriers refers to a series of unit processes operating, with some level of redundancy, to prevent harmful microbes and chemical constituents from passing into the treated water system (Khan, 2013). Potable reuse requirements in the United States developed to date mandate use of multiple barrier approaches, including the California Division of Drinking Water (DDW) *Groundwater Replenishment with Recycled Water* regulations (see **Chapter 3** for regulations). More recently, the Texas Commission on Environmental Quality approved individual projects using treated effluent from the wastewater treatment facilities to supplement water treatment plant (WTP) supplies (see **Appendix A**). In both cases, treatment scenarios were modeled after the Singapore and California facilities using rigorous process controls and monitoring requirements and resulted in designs protective of human health.

7.1.2 Source Control

Source control programs are a fundamental element of the multi-barrier approach to ensure the protection of public health. Source control programs for wastewater are implemented to reduce the discharge of contaminants not specifically treated at WWTPs. The constituents originate from industrial, commercial, health-related, and residential sources (Alan Plummer Associates, 2010). For a discussion of source control, refer to **Chapter 8**.

7.1.3 Optimizing Upstream Wastewater Treatment

Wastewater treatment is a critical step in producing water that is suitable for an AWTF (NWRI, 2015). Optimizing upstream wastewater treatment can ensure that high quality, reliable, and consistent effluent goes to the AWTF. This is an important first step in AWTF design and can help ensure cost-effective and functional treatment. For an overview of wastewater treatment and a brief description of components that should be optimized before investing in an AWTF, see Chapter 6 of the *Framework for Direct Potable Reuse* (NWRI, 2015).

It is important to note that in the United States, all wastewater must undergo secondary treatment (unless there is some extenuating circumstance). Some AWTFs utilize secondary effluent as source water for potable reuse applications, but further treatment may be desirable to improve the feed water quality prior to entering advanced treatment.

Optimization of wastewater treatment processes can enhance treatment performance to meet these objectives. Operational parameters of activated sludge, such as solids retention time (SRT) and oxygen conditions, are important in addressing constituents of emerging concern. For example, Gerrity et al. (2013b) and Zeng et al. (2013) demonstrated enhanced removal of compounds susceptible to biodegradation and/or sorption, such as antibiotics and analgesics, when the SRT was optimized for control of nitrogen in a conventional full-scale activated sludge WWTP. However, some pollutants do not exhibit susceptibility to biodegradation or sorption. Similarly, Miller et al. (2013) found that operational conditions are likely the greatest influence on antibiotic resistant genes (ARGs). Thus, optimizing wastewater treatment can dramatically improve the water quality received by the AWTF.

7.2 Types of AWT Unit Processes Used in Potable Reuse Treatment Trains

In general, there are two categories of treatment train options considered for AWTF use in a DPR scenario; one based on reverse osmosis (RO), and a second based on ozone-biological active filtration (BAF). There are many other combinations potentially acceptable for planned IPR or *de facto* reuse. This section describes the major treatment combinations considered for both IPR and DPR applications, including the more common treatment combinations for different treatment objectives.

7.2.1 WWTP to Surface Water Discharge

In the most common potable reuse and *de facto* reuse applications, wastewater is treated to secondary standards, as outlined in the Clean Water Act (CWA); the criteria include using full biological treatment to produce treated effluent with < 30 mg/L of biochemical oxygen demand (BOD) and < 30 mg/L of total suspended solids (TSS). Often, the conventional WWTP's secondary process is modified by changing the SRT, adding chemicals to facilitate settling, or by carefully selecting the microorganism populations to accomplish nitrification, denitrification, and phosphorus removal (Gerrity et al., 2013a). In many scenarios, treated wastewater effluent receives additional treatment when it is discharged into a surface water body that serves as the drinking water source; treatment may include biological nutrient removal and other tertiary treatment processes. Tertiary treatment could consist of membrane or media filtration and disinfection through chlorine, chloramines, ultraviolet light (UV), or ozone (Gerrity et al., 2013a). Following surface water discharge, the water in these reuse schemes receives further treatment at a drinking water treatment plant. The treated wastewater augments the available water resources (NRC, 2012a).

7.2.2 WWTP to Soil Aquifer Treatment (SAT)

California is well-known for employing conventional WWTP processes before groundwater recharge into drinking water basins (Gerrity et al., 2013a). SAT can be initiated through surface spreading operations or

direct injection. In surface spreading applications, SAT has been shown to be effective for the attenuation of pathogens, bulk organic matter, and trace organic compounds over time and is described in **Chapter 9** (Gerrity et al., 2013a). The California DDW grants log removal credits (LRCs) for viruses, *Giardia*, and *Cryptosporidium* when employing surface spreading (CDPH, 2014). The underground residence time of the water determines the LRCs. *Giardia* and *Cryptosporidium* receive full removal credit when the source is disinfected filtered effluent, and surface spreading occurs for a minimum 6-month aquifer travel time (CDPH, 2014). Virus removal, in contrast, receives 1-log credit per month for in-basin travel time, up to 6 months (Gerrity et al., 2013; CDPH, 2014). Projects using direct injection receive no credit for SAT impact on *Giardia* or *Cryptosporidium* but receive a 1-log per month virus credit, up to 6-log (CDPH, 2014). LRCs require a minimum 2-month ground travel time regardless of the level of pathogen reduction achieved by upstream processes (CDPH, 2014). As of 2015, only one facility, the Cambria Emergency Water Supply, received approval for the minimum 2-month travel time.

The 2012 *Guidelines* suggested approaches for groundwater recharge of potable aquifers via surface spreading, injection, and augmentation of surface water supplies (EPA, 2012a). A summary of these approaches is in **Table 7-1**. Aquifer storage and recovery (ASR) is a term for the widely used technical method for storage of reclaimed water and excess water in a groundwater formation for later withdrawal and beneficial use. For a technical report on principles involved in ASR, as well as tools and methods for ASR system planning, assessment, design, and evaluation, refer to EPA's *Decision Support System for Aquifer Storage and Recovery (ASR) Planning, Design and Evaluation— Principles and Technical Basis* (EPA, 2017m).

Table 7-1. IPR application approaches (adapted from EPA, 2012a)

Type of IPR	Treatment Steps	Water Quality Parameters
Groundwater Recharge via Spreading into Potable Aquifers	<ul style="list-style-type: none"> ▪ Secondary¹ ▪ Filtration² ▪ Disinfection³ ▪ SAT 	<ul style="list-style-type: none"> ▪ No detectable total coliform /100 mL ▪ 1mg/L Cl₂ residual (Min) ▪ pH = 6.5-8.5 ▪ ≤ 2 NTU ▪ ≤ 2 mg/L TOC of wastewater origin ▪ Meets drinking water standards by time of exit from the vadose zone
Groundwater Recharge by Injection into Potable Aquifers	<ul style="list-style-type: none"> ▪ Secondary¹ ▪ Filtration² ▪ Disinfection³ ▪ Advanced Wastewater Treatment⁴ 	<ul style="list-style-type: none"> ▪ No detectable total coliform /100 mL ▪ 1mg/L Cl₂ residual (Min) ▪ pH = 6.5-8.5 ▪ ≤ 2 NTU ▪ ≤ 2 mg/L TOC of wastewater origin ▪ Meets drinking water standards
Augmentation of Surface Water Supply Reservoirs	<ul style="list-style-type: none"> ▪ Secondary¹ ▪ Filtration² ▪ Disinfection³ ▪ Advanced Wastewater Treatment⁴ 	<ul style="list-style-type: none"> ▪ No detectable total coliform /100 mL ▪ 1mg/L Cl₂ residual (Min) ▪ pH = 6.5-8.5 ▪ ≤ 2 NTU ▪ ≤ 2 mg/L TOC of wastewater origin ▪ Meets drinking water standards

(1) Refers to treatment processes such as conventional activated sludge, trickling filters, rotating biological contactors, and may include stabilization pond systems. BOD and TSS should be < 30 mg/L.

(2) Filtration through soils, filter media such as sand or anthracite, or membrane filtration.

(3) Disinfection can be achieved through chemical, physical, or biological processes so long as pathogen inactivation is accomplished (e.g. through chlorine, ozone, UV, membrane processes).

(4) Examples of advanced wastewater treatment processes include chemical clarification, carbon adsorption, RO, membrane filtration, advanced oxidation, air stripping, ultrafiltration (UF), ion exchange.

7.2.3 Full Advanced Treatment and Related Models

Full advanced treatment, or the “California model,” does not rely on SAT to remove trace chemical constituents, meet water quality limits, or achieve additional *Giardia* or *Cryptosporidium* removal credits. Lower levels of treatment are approved and used in California with surface spreading. Also, the California regulations allow for alternative treatment schemes for direct injection on a case-by-case basis. (CDM Smith, 2014). Because most of the existing facilities discharge into protected groundwater aquifers not under the direct influence of surface water, additional treatment after extraction is generally limited to chlorination for secondary disinfection.

RO is at the heart of the full advanced treatment process and is typically preceded by microfiltration (MF) or UF. RO pretreatment can be operationally challenging; suspended particulates can plug feed channels in the membrane modules or damage the membrane surfaces. See **Section 6.3.1** for a discussion on RO pretreatment and other operational considerations. In water reuse applications, the typical recovery rate of an RO system ranges from 85 to 93 percent, with higher recoveries often driven by limitations in disposal alternatives (Chalmers et al., 2013). RO is capable of reaching TDS reductions to below 50 mg/L, total organic carbon (TOC) reductions to less than 0.1 mg/L, and more than 99 percent removal of pathogens and most trace chemical constituents. Some low molecular weight and volatile compounds are less readily removed, with nitrosamine and trihalomethane removal ranging from 40 to 90 percent (CDM Smith, 2014). A WaterReuse Research Foundation (WRRF) study entitled *Guidelines for Engineered Storage Systems* proposes the LRC granted to RO systems in DPR schemes should be 1.5 for viruses, *Cryptosporidium*, and *Giardia* (WE&RF, 2016c). Studies have demonstrated that removals up to 6-log can be achieved (EPHC, 2008). Credits granted at existing facilities have ranged from 0-log to 3-log (Wetterau et al., 2015b), depending on the selected method of integrity monitoring and the regulatory agency responsible. For example, the Cambria Emergency Water Supply Project in California used only conductivity to continuously monitor RO performance and did not receive any pathogen credits. However, the Orange County Groundwater Replenishment System (GWRS) received 2-log credits using online TOC monitoring as a surrogate, and the Beenyup Water Recycling Plant in Perth, Australia received 3-log credits using periodic grab samples of sulfate as a pathogen surrogate.

The cost of implementing the full advanced treatment process is fairly well-understood because of its widespread application in California. The American Water Works Association (AWWA) is currently developing M62 Manual of Practice on membrane based reuse, which will include cost curves for IPR facilities; however, this information has not yet been publicly released. In general, treatment costs will depend on numerous factors, including the specific site and application, the cost of source water, treatment technologies used, plant facilities constructed, power, labor, and chemical costs, annual water production, and many other factors. Recognizing these factors, it is possible to gain an understanding of the costs of implementing a full advanced treatment system. **Chapter 11** contains additional information on costs of full advanced treatment systems. Interestingly, economies of scale for RO-based processes with increasing plant size are not significant. Further, if costs for a zero-discharge concentrate disposal system are considered, there are significant additional capital and O&M costs that nearly equal the cost of treatment to produce AWT water.

7.2.3.1 Plants/Projects Using Full Advanced Treatment or Related Models

Currently, five full-scale facilities in California, one in Big Spring, Texas, and three in Queensland, Australia use California's full advanced treatment model. Four plants in Singapore, one in Perth, Australia, and one in Wichita Falls, Texas use a modified version of the California model known as the "Singapore model" (Bell et al., 2016b). Singapore's model uses MF, RO, and UV; but, UV only serves to reduce viruses, without advanced oxidation, while RO is relied on to address trace chemical constituents (Bell et al., 2016b).

7.2.3.2 Water Quality

Full advanced treatment achieves a high-quality effluent using redundant barriers for pathogens and chemical contaminants. TDS levels less than 50 mg/L are typically achieved, with TOC less than 0.5 mg/L. **Table 7-2** compares the water quality credits associated with each unit process in the California model and the Singapore model adapted at Beenyup AWTF in Western Australia. Variations in the credits granted between California and Western Australia relate primarily to differences in integrity monitoring approaches used at the facilities and accepted by state regulators. In contrast, differences in total treatment requirements relate more to the risk mitigation approaches discussed in **Chapter 5**. It should be noted that pathogen reduction requirements in Western Australia must be achieved prior to injection in the groundwater, while the California regulations allow credit for soil aquifer treatment after spreading or injection. Table 7.4a of the *Framework for Direct Potable Reuse* provides additional information on pathogen LRCs and the associated performance monitoring method for each treatment step in a full advanced treatment train (NWRI, 2015).

Table 7-2. Comparison of pathogen and contaminant reduction in California and Western Australia IPR approaches

Requirement	California	Western Australia
MF/UF	0 to 1-log virus 4-log <i>Giardia</i> 4-log <i>Cryptosporidium</i> Turbidity < 0.2 NTU	3-log virus 3-log <i>Cryptosporidium</i> 3-log <i>Campylobacter</i> Turbidity < 0.2 NTU
RO	1 to 2-log virus 1 to 2-log <i>Giardia</i> 1 to 2-log <i>Cryptosporidium</i> TOC < 0.25 mg/L	3-log virus 3-log <i>Cryptosporidium</i> 3-log <i>Campylobacter</i>
UV	6-log virus 6-log <i>Giardia</i> 6-log <i>Cryptosporidium</i>	4-log virus 4-log <i>Cryptosporidium</i> 4-log <i>Campylobacter</i>
AOP	0.5-log 1,4-dioxane	Not required
Total Pathogen Requirement	12-log virus 10-log <i>Giardia</i> 10-log <i>Cryptosporidium</i>	9.5-log virus 8-log <i>Cryptosporidium</i> 8.1-log <i>Campylobacter</i>

7.2.3.1 Costs

Many have accepted full advanced treatment and modified forms as the standard for potable reuse treatment trains (WRRF, 2013a) as this process provides consistent, exceptional quality product water that exceeds the quality of most conventional drinking water supplies. However, this approach can lead to very high capital and operating costs. Also, facilities located more than a few miles from an ocean may find brine disposal alternatives costly and challenging to permit. Inland RO facilities without an option for deep injection wells or surface water disposal face exacerbated challenges for brine disposal; brine disposal can at least double the capital and operating costs of an RO facility where there is no ocean for reasonably economical disposal (Poulson, 2010; Bond & Veerapaneni, 2007). Comparative costs are summarized in **Chapter 11**.

7.2.4 Ozone-BAF or the Alternative Treatment Train

Some utilities are evaluating alternative treatment trains capable of producing a similar quality product water as full advanced treatment trains (Bell et al., 2016b). Ozone-BAF is one such alternative, providing a potential substitute for RO, addressing trace chemical constituents without producing a brine stream (Bell et al., 2016b).

7.2.4.1 Process Description

Ozone-BAF is a simple process leveraging a combination of chemical and biological oxidation processes, both mature treatment technologies currently widely used in drinking water treatment. The ozone-BAF process generally consists of an ozone pretreatment step followed by biological filtration in a media filter (**Figure 7-2**). Ozone is a strong oxidant, and when used in conjunction with BAF, it can remove iron and manganese, BOD or chemical oxygen demand (COD) (including trace chemical constituents), taste and odor compounds, color, and disinfection by-product precursors (Bell et al., 2016b; Bouwer and Crowe, 1988; Evans et al., 2010; Evans et al., 2013; Hozalski and Bouwer, 2001; Wunder and Hozalski, 2012). During ozonation, high molecular weight organic compounds are broken down into smaller chain compounds that are more readily biodegradable by the BAF, regardless of the composition of the filter media.

For ozone-BAF, ozonated water is sent to a biologically “active” granular media filter. Biofiltration is a treatment technique where the biomass on a granular media filter removes organic carbon that was made more biodegradable through pre-ozonation. Most granular media filters are capable of supporting microbial growth, assuming that the filtered water does not have a disinfectant residual. As a result, the biological activity can improve treatment performance beyond particle removal; water quality is improved with respect to a wide range of dissolved organic contaminants, including pesticides, endocrine disrupting chemicals (EDCs), and pharmaceuticals, although the degree to which biological activity contributes to treatment performance varies (Bonne et al., 2002; Wunder et al., 2008; Van der Aa et al., 2003). If the biofilter is not a carbon bed, a granular activated carbon (GAC) bed may follow it for further sorptive removal.

When compared with sand or anthracite media, GAC has adsorptive properties and can accumulate greater microbial biomass (or biofilm) due to its porosity and high surface area. Biomass is critical in biodegrading contaminants and supplementing GAC filtration and adsorption. GAC can extend the lifetime—the time between media replacements—because biogrowth is the main removal mechanism, not adsorption. For example, the original GAC was installed in 2006 at the F. Wayne Hill Water Resources Center, a AWT plant that provides water for IPR through surface water augmentation, and was still in use as of 2016.

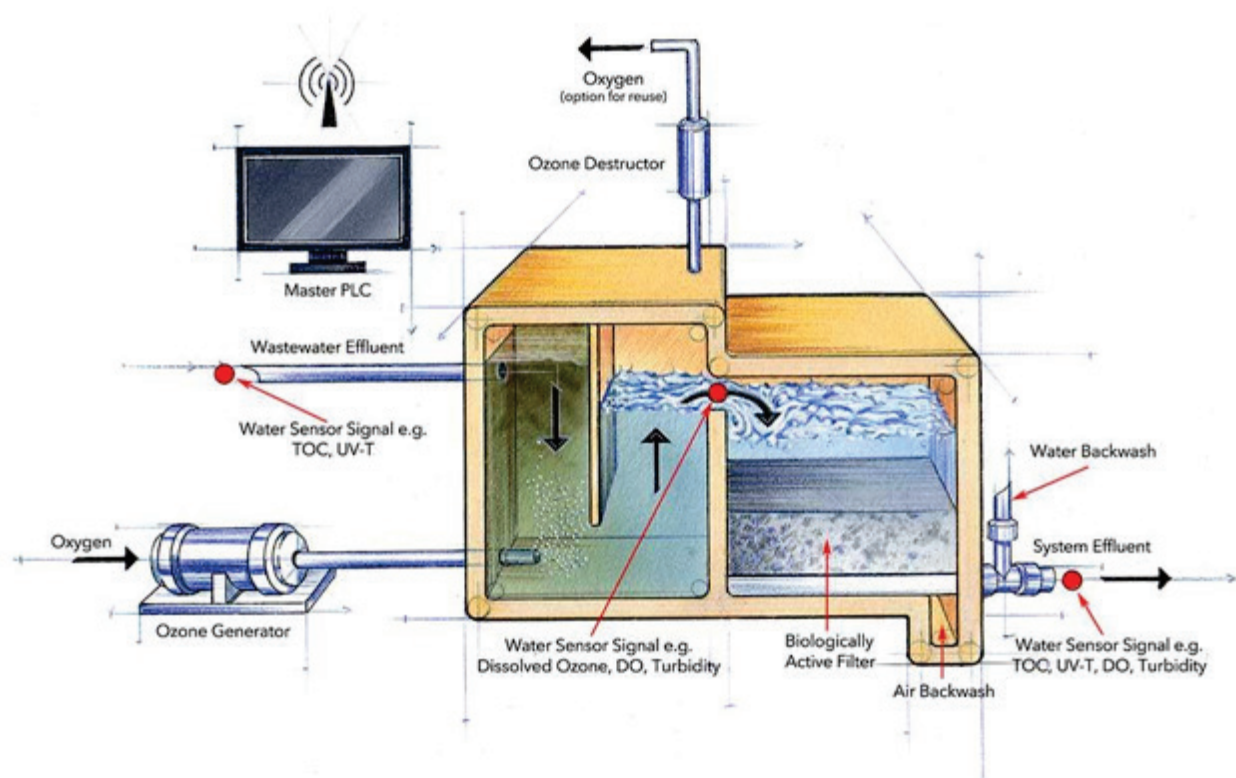

Figure 7-2. Oxelia oxidation-enhanced biologically active filtration system (courtesy of Xylem Inc.)

Depending on contact time requirements to remove target contaminants, a biofilter can be a rapid-rate filter, a mono-media deep-bed contactor, or a GAC filter cap on top of a sand or anthracite filter bed. As with conventional rapid-rate filters, upstream coagulants and oxidants improve contaminant removal. GAC's adsorptive properties aid in producing the desired filtered water quality; GAC must be regenerated periodically, particularly where adsorption may play a more dominant treatment role than the biological mechanism of contaminant removal. Biofiltration leverages low energy biological treatment processes to produce higher quality reclaimed water; this can make biofiltration an important component of a multi-barrier treatment process and it may replace higher energy processes, such as RO, in certain applications. With ozone present onsite, ozone-BAF could utilize ozone as a post-filtration disinfection process, similar to the F. Wayne Hill Water Resources Center in Gwinnett County, Georgia (**Appendix A**). See **Section 6.4.6** for more information on ozone as a treatment technology.

7.2.4.2 Plants using Ozone-BAF

Drinking water treatment facilities have used ozone-BAF successfully for decades. A significant number of drinking water utilities utilize BAFs to remove organic carbon, often to meet TOC removal requirements of the Stage 1 D/DPR Rule. Wastewater treatment has demonstrated ozone-BAF's effectiveness at a few notable water reclamation facilities. The longest running DPR operation, the Goreangab plant in Windhoek, Namibia, utilizes the ozone-BAF treatment train, demonstrating that the process can operate successfully (process details in **Figure 7-1**) (CORPUD, 2014). A recent Water Research Foundation project included a survey of multiple water utilities that utilize BAF (Evans et al., 2013). **Table 7-3** highlights potable reuse facilities utilizing the ozone-BAF treatment train.

The city of San Diego piloted a new DPR treatment train that incorporated ozone-BAF upstream of the full advanced treatment train (**Figure 7-1**) (Pecson et al., 2017). The pilot system was monitored with multiple online sensors to verify performance. This study found the pilot system “demonstrated reliable pathogen control that met or exceeded the risk goals used by the U.S., [World Health Organization], Australia, and other countries” (Pecson et al., 2017).

Table 7-3. Reclamation facilities using the ozone-BAF process

Project	Location	Year Installed (Upgraded)	Treatment Process	Treatment Application	Scale
F. Wayne Hill Water Reclamation Center (FHWRC)	Gwinnett County, Georgia	2003 (2006)	Secondary effluent → Chemical clarification → Granular media filtration → Pre-ozonation → GAC Filtration → Post-ozonation or Secondary effluent → MF → Pre-ozonation → BAC Filtration → Post-ozonation	IPR	48 MGD
Goreangab Reclamation Plant	Windhoek, Namibia	2002	PAC → Pre-ozonation → Coagulation /Flocculation → DAF → Rapid Sand Filtration → Ozonation → BAC Filtration → GAC Filtration → UF → Chlorination/Stabilization	DPR	5.5 MGD
Fred Hervey Water Reclamation Plant (FHWRP)	El Paso, Texas	1995 (2008)	High pH Lime addition → Two-stage recarbonation → Sand Filtration → Pre-ozonation/Disinfection → GAC Filtration	DPR and IPR	10 MGD
Reno-Stead Water Reclamation Facility (RSWRF)	Reno, Nevada	2010	Phase 1: UF → Ozone/Hydrogen peroxide → BAC filtration Phase 2: Sand filtration → Ozone/Hydrogen peroxide → BAC Filtration	Reclaimed water pilot	10.6 GPM (Pilot)

7.2.4.3 Water Quality

Table 7.4b of the *Framework for Direct Potable Reuse* proposes pathogen LRCs and the associated performance monitoring method for each treatment step in an ozone-BAF treatment train (NWRI, 2015). Considering that ozone-BAF leverages a biofilm established on filter media, there is concern over the potential to generate pathogenic bacteria from microbial biomass sloughing. However, research shows that the potential is low and post-disinfection processes can sufficiently mitigate any potential microbial breakthrough (LeChevallier et al., 1998; Evans et al., 2010; Burr et al., 2000).

One noteworthy difference between the ozone-BAF process and RO processes is that the full advanced treatment train can reduce TOC to below 0.5 mg/L. In practice, when ozone-BAF is used in lieu of RO this generally results in < 95 percent TOC reduction. Ozone-BAF is typically paired with other treatment trains that can increase overall organic carbon removal, but the low TOC levels achieved with RO are difficult to match with any other treatment scheme. However, the nature of the TOC remaining after an ozone-BAF

process, such as an increase of assimilable organic carbon, may differ in composition from that remaining after an RO-based process, and therefore acceptable TOC concentrations may be site-specific.

Ozone-BAF requires careful operator attention to maintain optimized ozone dosing, proper filter loading, and sufficient backwashing. A poorly operated facility could see wide variations in product water quality; this is a significant difference from the full advanced treatment process, where product water quality remains relatively consistent and independent of operating conditions or operator attention.

Ozone-BAF does not remove TDS, therefore it will be limited to applications where the water's salt concentrations are not a concern. However, ozone-BAF can be coupled with sidestream TDS removal in certain cases to achieve local TDS requirements. In the California *Groundwater Replenishment Using Recycled Water* regulations, ozone-BAF is an alternative process that requires approval on a case-by-case basis, if accepted. Ozone-BAF is allowed in California for surface spreading operations, but full advanced treatment is currently the only treatment train specifically approved for direct injection of reclaimed water into groundwater (CDPH, 2014).

7.2.4.4 Costs

Because a range of treatment configurations and operational strategies perform biological filtration, estimating capital and operating costs of ozone-BAF is more challenging than for full advanced treatment. These variations result in a range of options for filter construction and the operational strategies for running a BAF filter.

CHAPTER 8

Source Control

8.1 Introduction

Source control programs are a fundamental element of the multiple barrier approach utilized in potable reuse to protect public health. Wastewater source control programs are implemented to reduce chemical and contaminant discharges that are difficult to remove, not specifically treated for at wastewater treatment plants (WWTPs), or could impact the ability to meet discharge requirements. Source control programs for potable reuse must appropriately address industrial and commercial discharges to protect the treatment processes, public health, and downstream infrastructure and the environment. **Figure 8-1** illustrates the interaction of these goals for direct potable reuse (DPR) (FCM and NRC, 2003). These three goals are central to the operation of a successful wastewater source control program; but, not all entities currently exploring potable reuse have existing or approved pretreatment or source control programs.

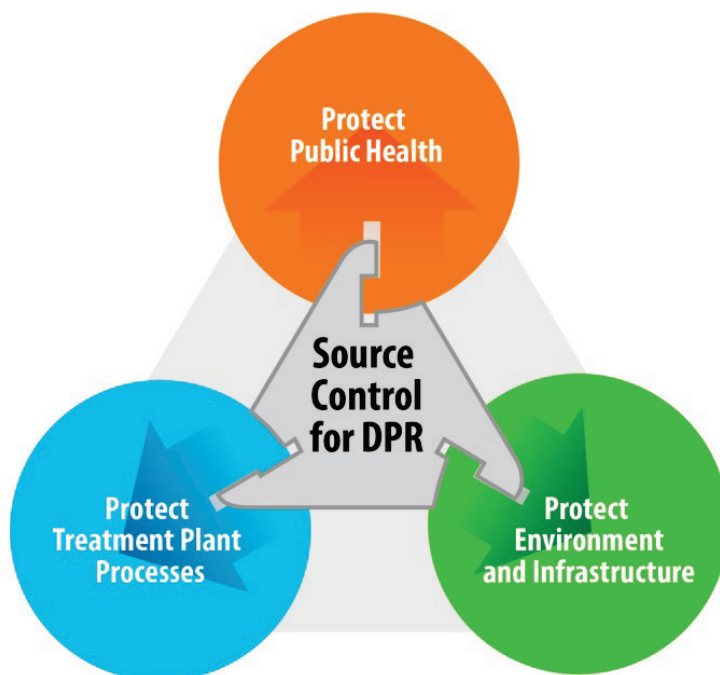

Figure 8-1. Fundamental goals of a DPR source control program

8.2 Elements for Potable Reuse – Source Control Program

An important question to consider for a potable reuse project is whether existing source control measures, designed solely for wastewater agencies discharging to ambient waters, are appropriately designed for facilities with a direct or indirect connection to a public drinking water system. Potable reuse source control programs are essential components of the multiple barrier approach implemented to ensure consumer safety and acceptability of potable reuse water. Therefore, there is likely a need for enhanced source control programs for potable reuse, and potentially a need for enhanced source control programs when DPR is employed (CUWA et al., 2010). Potable reuse source control programs may not remove all unwanted publicly owned treatment work (POTW) pollutants. Therefore, programs should reduce problematic and

measurable constituents, identify contributing sources, and determine where contributing sources are within the management agency’s control. **Figure 8-2** presents the overall structure of a potential potable reuse source control program. **Table 8-1** gives further details regarding the specific content of program elements.



Figure 8-2. Critical components of a source control program for potable reuse

Table 8-1. Specific content of potable reuse source control program elements (Adapted from FCM and NRC, 2003)

Source Control Program Element	Specific Content
Evaluation of Wastewater Sewer Service Area	<ul style="list-style-type: none"> ▪ Identify potential ‘pass-through’ and ‘interference’ constituents specific to the sewer service area in order to evaluate local limits for necessary constituents ▪ Prioritization of constituents ▪ Assessment of technical limits for regulated constituents and contaminants of emerging concern
Discharge Characteristics Assessment	<ul style="list-style-type: none"> ▪ Database of chemicals stored or discharged by industrial users ▪ Hauled waste inventory
Educational Awareness and Public Outreach Program	<ul style="list-style-type: none"> ▪ Quantity control ▪ Quality control ▪ Information on proper disposal methods ▪ Incentives program ▪ Pollution prevention program/service-area wide stewardship programs
Sewer-Use By-Laws and Best Management Practices	<ul style="list-style-type: none"> ▪ Prohibited Wastes ▪ Restricted Wastes ▪ Discharge permits ▪ Best Management Practices

Source Control Program Element	Specific Content
Enforcement and Response	<ul style="list-style-type: none"> ▪ Routine monitoring program ▪ Response plan for pollutant concerns ▪ Flow trace of pollutants to industrial user source using geometric network ▪ Enforcement response plan for non-compliance

8.2.1 California's IPR Source Control Program Requirements

The California *Groundwater Replenishment Using Recycled Water* regulations require a source control program for recycled municipal wastewater (see CDPH, 2014). The source control program includes multiple requirements: a fate assessment of specific wastewater and recycled municipal wastewater chemicals and contaminants; specific chemical and contaminant source identification and monitoring; an industrial, commercial, and residential outreach program; and an inventory of specific chemicals and contaminants (CDPH, 2014).

8.2.2 DPR Source Control Program Elements

Typically, an effective DPR source control program includes six principle elements: “(1) regulatory authority; (2) monitoring and assessment of commercial and industrial dischargers to the wastewater collection system within the service area; (3) investigation of chemical and other constituent sources; (4) maintenance of the current inventory of chemical constituents; (5) preparation of a public outreach and participation program; and (6) preparation of a response plan for water quality deviations.” (NWRI, 2015)

8.3 National Pretreatment Program

The National Pretreatment Program controls and regulates commercial and industrial wastewater discharges to POTWs (EPA, 2011). This program was not designed to address potable reuse systems. A more rigorous source control program, in conjunction with the National Pretreatment Program, is an important consideration in potable reuse planning to eliminate or control discharges that might impact the reliable treatment of water used for potable reuse.

The following POTWs must develop pretreatment programs: 1.) POTWs receiving pollutants from industrial users that may pass through or interfere with operations or are otherwise subject to pretreatment standards; and 2.) POTWs with a design capacity greater than 5 million gallons per day (MGD) (40 CFR 403.8). WWTPs with a capacity less than 5 MGD may be required to develop a pretreatment program (40 CFR 403.8).

Industrial discharges can potentially interfere with POTWs by upsetting treatment processes and/or sludge and biosolids operations. In addition to interferences, industrial pollutants discharged into the collection system and POTW may pass through all treatment processes and ultimately be discharged to surface water, sludges, or air emissions. POTWs are not designed to provide significant removal of some toxic chemical pollutants (EPA, 2011); pollutants passing through POTWs can result in aquatic life or human health impacts, including contamination of sludges initially intended for beneficial reuse.

Local municipalities and agencies also require additional source control regulations that protect the POTW or local environment. An approved pretreatment program frequently incorporates limits identified by local authorities (40 CFR 403.5(c)). For example, the City of Los Angeles has local limits on the amount of

industrial pollutants discharged into the sewer, which includes arsenic, metals, and other materials that could degrade the effluent (SDLAC, 2017).

National Pollutant Discharge Elimination System (NPDES) regulations (40 CFR 122.44(i)) require that POTWs periodically measure influent, effluent, and biosolids for pollutants of concern. Chemicals such as polychlorinated biphenyls (PCBs), pesticides, and phenolic compounds are often locally regulated from industrial discharges; these types of chemicals may impact the performance of some advanced removal technologies (e.g. foulant) as well as public acceptance of a potable reuse water program.

Nitrogen and TDS have potential negative impacts on a membrane treatment program if not controlled by a potable source control program. Higher TDS increases the pressure required for reverse osmosis (RO) treatment, impacting electric power usage and cleaning cycle frequency. Nitrogen compounds can impact reservoir discharge limits; higher nitrogen could also contribute to algal blooms or taste and odor issues in IPR situations (NRC, 2012a).

Orange County's GWRS includes local limits for potable reuse source control. Certain discharges may not enter the GWRS through the Orange County Sanitation District's wastewater collection system; this includes discharges from the Stringfellow Superfund site. Discharges from the Stringfellow Superfund site are non-reclaimable flow that cannot be recycled. Because of the public concern associated with Superfund site discharges in the IPR project, the wastewater agency made revisions to their collection and wastewater treatment systems to ensure the GWRS would not receive this water.

8.4 Pollution Prevention

Pollution Prevention (P2), a national objective enacted with the Pollution Prevention Act of 1990, and source control can complement one another. P2 objectives are built into EPA regulatory guidelines (EPA, 2011) and in some state and local agency guidelines. The main objectives of P2 Programs are to prevent pollution from occurring at the source, encourage the use of non-toxic or less toxic substances, and actively conserve natural resources (EPA, 2011). The P2 Program encourages the quantification of POTW influent pollutants to identify the source(s) of a pollutant or pollutant concentration and to determine pollutant loading.

8.5 POTW Chemical Impacts on Reuse Facilities

Chemicals and materials used at a POTW may also impact the suitability of influent water for a potable reuse facility. POTWs can reduce costs and simplify or improve wastewater treatment and reuse performance by avoiding cross-contamination from difficult-to-treat chemical compounds. Segregating processes at the wastewater plant can minimize the impact of these materials by either bypassing the reuse plant connection, allowing for pretreatment of that key contaminant, or switching to another chemical.

For example, Mannich polymer is a chemical often used at POTWs to aid settling in the sludge dewatering process. When the dewatering side streams are discharged back into the POTW, trace amounts of this compound can enter the downstream potable reuse facility in the influent water. Mannich polymer is known to increase N-nitrosodimethylamine (NDMA) formation and is a possible foulant to the RO membranes. If possible, even trace amounts should be eliminated from the influent stream.

NDMA forms in water treatment plants (WTPs) when chloramines react with dimethylamine (DMA), a constituent of the Mannich polymer (Huitrich et al., 2006). Huitrich et al. (2006) evaluated two alternatives for minimizing NDMA formation during chloramination: breakpoint chlorination while using Mannich polymer and chloramination while using emulsion polymers without DMA. Laboratory and full-scale tests were performed "to evaluate disinfection efficacy and formation of NDMA and trihalomethanes (TTHM) with these

alternatives” (Huitrich et al., 2006). The emulsion polymer alternative produced much lower NDMA levels than the Mannich polymer scenario, but it was less effective as a settling mechanism (Huitrich et al., 2006).

CHAPTER 9

Environmental and Engineered Buffers

9.1 Environmental Buffers

An environmental buffer refers to an aquifer, wetland, or other body of water such as a river, stream, lake, or reservoir, that serves as an intermediate discharge and holding point within a potable reuse scheme. The environmental buffer receives treated water from an advanced wastewater treatment facility (AWTF). Dilution, blending, and some contaminant removal through filtration (aquifers), photolysis (surface waters), or biological degradation can occur before indirect potable reuse (IPR) withdrawal (**Figure 9-1**) (WE&RF, 2016c). Environmental buffers tend to dissociate the origin of the water (wastewater discharge) from the end-point (drinking water); environmental buffers also create a window of time in which the water enters into a natural environment (Khan, 2013). Although environmental buffers can improve water quality, they are not a universally required component in potable reuse projects, and they do not conform to controlled performance standards (Khan, 2013). In fact, some environmental buffers may degrade the quality of purified water; including risks of surface water contamination.

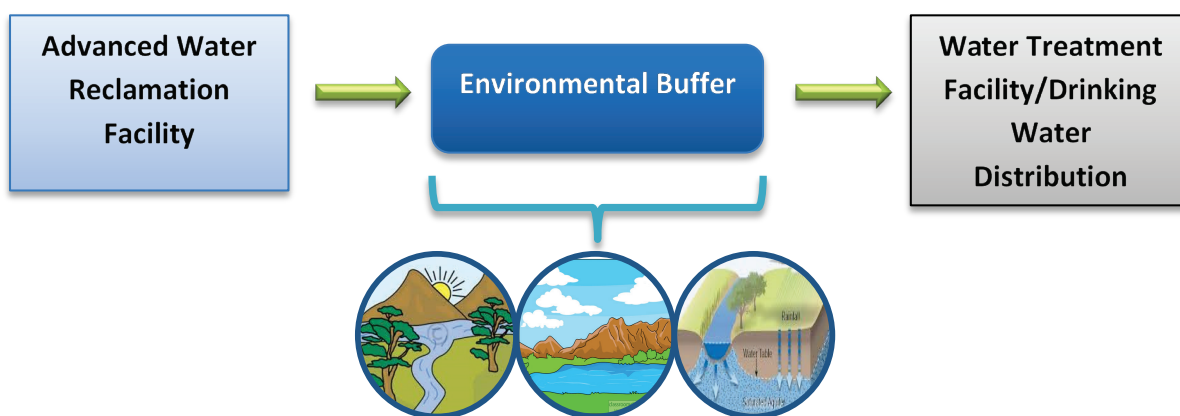

Figure 9-1. Environmental buffers in potable reuse treatment schemes

An environmental buffer's importance to public health largely depends on the influent water quality and the buffer's specific characteristics. For example, reclaimed water that undergoes advanced treatment upstream of the environmental buffer may have less stringent dilution and residence time requirements than reclaimed water that only undergoes filtration and disinfection (WE&RF, 2016c). Two types of environmental buffers, aquifers and surface storage, are discussed herein.

9.1.1 Aquifer Recharge

Aquifers can serve as subsurface environmental buffers. In this approach, treated effluent is either diverted to surface spreading basins whereby infiltration occurs, or used in more modern approaches such as rapid infiltration basins, vadose zone injection wells, infiltration trenches, or riverbank filtration to reach the water table. Reclaimed water percolates through sediment until it reaches the aquifer and blends with groundwater; it remains underground for a predetermined residence time before being extracted as a drinking water source. The process of enhancing natural groundwater supplies using engineered conveyances to route water to an aquifer is known as managed aquifer recharge (MAR), and in a number

of cases in near coastal areas, MAR has also helped to reduce saltwater intrusion. Purified water sent to a spreading basin undergoes a natural water treatment process known as soil aquifer treatment (SAT). As opposed to full advanced treatment (discussed in **Chapter 7**), SAT does not result in the generation of a brine requiring disposal and provides additional pathogen removal, therefore making it a popular option for inland geographies. Lab analysis of soil columns can assess the removal of pathogens, such as *Cryptosporidium*, through SAT. Field studies using actual *Cryptosporidium* are relatively rare due to low oocyst concentrations, even in raw surface waters. Field studies typically utilize surrogates, such as bacterial spores or microspheres, to assess log removal of pathogens through SAT (WRRF, 2015a). SAT, given a suitable aquifer, is considered the most economical potable reuse alternative. The WaterReuse Research Foundation (WRRF) completed a study, titled *Enhancing the Soil Aquifer Treatment Process for Potable Reuse*, that investigated two alternative treatment trains for potable reuse using SAT, one involving chlorine disinfection and the other involving ozone disinfection. Findings from this study indicated that SAT is an effective and natural treatment option (WRRF, 2015a). The level of treatment achieved through aquifer recharge depends on the quality of the feed water. There is the possibility of water quality degradation; blending high quality feed water with groundwater that was exposed to municipal, agricultural, industrial, and natural contaminants can result in added treatment requirements when the water is extracted (WE&RF, 2016c). Aquifer storage and recovery (ASR) is a specific type of MAR practiced to augment groundwater resources and recover the water in the future for various uses (EPA, 2012a). In the United States, ASR is used frequently as a method of improving water availability during droughts, and offsetting water shortages; ASR projects that utilize underground injection require an underground injection control (UIC) permit (EPA, 2017m). Most of the current U.S. ASR practices are utilized in non-potable water and wastewater reuse applications intended for irrigation, industrial, and urban landscape end uses; however, ASR for IPR has recently increased in popularity (EPA, 2017m). As mentioned in **Chapter 7**, for a technical report on principles involved in ASR, as well as tools and methods for ASR system planning, assessment, design and evaluation, refer to EPA's *Decision Support System for Aquifer Storage and Recovery (ASR) Planning, Design and Evaluation— Principles and Technical Basis* (EPA, 2017m).

9.1.2 Surface Water Storage

Surface water storage occurs when reclaimed effluent is discharged into a lake, reservoir, or river. In this instance, the receiving surface water blends with reclaimed water before being extracted and sent to the water treatment plant (WTP). Surface water storage provides a mitigation response time in the event of process failure, and can provide a level of treatment; however, the effectiveness of treatment depends on the water quality of the reclaimed effluent, and the water quality and environmental conditions of the surface water (WE&RF, 2016c). Surface water storage can be a limiting factor in IPR operation implementation, because a viable location for the surface water storage may not exist in all situations (Khan, 2013).

Interestingly, even if the surface water storage exists, there can be utilization challenges. As mentioned above, contamination risks can be challenging with surface water. Also, storage and withdrawal contracts can be contentious for surface water sources, as illustrated in the Gwinnett County case study (**Appendix A**).

9.1.3 Wetlands

There are numerous examples of using wetlands as “environmental buffers.” Many of these facilities, such as in Clayton County, Georgia, discharge treated effluent into a constructed treatment wetland system to recharge the water supply (CCWA, 2017). Constructed wetlands rely on aquatic ecosystem components to filter and biologically treat the water that flows through them; these components include soils, plants, and bacteria. Constructed wetlands can serve as a treatment process for potable reuse applications; but, storing

treated water in a natural wetland could contribute additional total organic carbon (TOC) to the treated water and make WTP treatment significantly more challenging.

9.1.4 Fate and Transport of Pathogens in Subsurface Environmental Buffers

As discussed in **Chapter 4**, wastewater pathogens may pose acute or sometimes chronic risks to public health. Environmental buffers can remove pathogens by sieving, sorption, predation, and subsequent die-off in soil and subsurface media. Pathogen removal is most efficient in granular (sand) media subsurface environments as opposed to non-porous media dominated environments, such as bedrock (e.g. basalt). Site-specific conditions, including soil saturation and aquifer flow type (porous or non-porous media), media composition, groundwater pH, and microorganism type and strain all interact to affect the removal capacity and die-off rate in soils and aquifers.

Pathogen concerns resulted in the implementation of residence and travel time requirements for environmental buffers in systems with potential hydraulic connectivity to drinking water supplies or in IPR schemes. Travel times are average values, and some groundwater takes a faster path and arrives sooner than the average. Porous media aquifers have the most accurately calculated travel times. In non-porous media aquifers, travel times are best determined using site-specific field tracer tests. For IPR systems in California, travel time requirements range from 2 to 12 months, depending on the percentage of reclaimed water in the planned IPR system. In 2009, Massachusetts adopted a six-month travel time requirement for environmental buffers in IPR systems. Although New York does not have water reuse guidelines, the State Sanitary Code (November 2011) requires that all new and existing effluent discharges to groundwater systems have a 60-day travel time or more from the point of discharge to the point of intake (NYCRR Title 10, 2011).

9.1.5 Fate and Transport of Trace Chemical Constituents in Environmental Buffers

As presented in **Chapter 4**, wastewater from properly well-operated publicly owned treatment works (POTWs) contains a wide variety of chemicals including trace chemical constituents that are generally present at nanogram per liter concentrations (ng/L) or less. Trace chemical constituents can include pharmaceutically active compounds and personal care and consumer product additives; they are the subject of numerous wastewater treatment and environmental removal studies (Wells et al., 2008, 2009, 2010; Bell, et al., 2011, 2012, 2013; Keen et al., 2014).

A combination of mechanisms can remove trace chemical constituents during subsurface transport, including sorption and biodegradation. Bulk organic matter components such as natural organic matter (NOM) and soluble microbial products (SMPs) are “reduced during subsurface transport as high-molecular-weight compounds are hydrolyzed into lower-molecular-weight compounds and the lower molecular weight compounds serve as a substrate for microorganisms” (NRC, 2008). Synthetic organic compounds with “concentrations too low to directly support microbial growth may be co-metabolized, as NOM and SMPs serve as the primary substrate for growth” (NRC, 2008). During subsurface transport, the transformation of organic compounds falls into two categories of either relatively fast, short-term transformations, or slow, long-term transformations (NRC, 2008). Easily biodegradable carbon transforms within a timescale of days and when transport paths are sufficiently long; providing longer retention times in the subsurface allows organic compounds to transform. The variability of influent trace chemical concentrations to subsurface environments could be temporally or seasonally dependent (Hinkle et al., 2005). Biodegradation rates increase with warmer temperatures.

Easily biodegradable trace chemical constituents, such as caffeine and 17 β -estradiol, tend to degrade on a timescale of days, while more refractory compounds, such as N-nitrosodimethylamine (NDMA) and sulfamethoxazole, tend to degrade over a timescale of weeks to months (Dickenson et al., 2008). Persistent compounds, such as carbamazepine and primidone, can persist for months or years in the subsurface (Clara et al., 2004; Heberer, 2002). The transformation of organic trace chemical constituents can depend on the presence of biodegradable dissolved organic carbon because the concentrations of constituents of concern are very low and may not support growth (Rausch-Williams et al., 2010; Nalinakumari et al., 2010).

The various removal mechanisms of trace chemical constituents in subsurface environments are discussed below. It is important to emphasize that site-specific conditions govern removal rates.

9.1.5.1 Biodegradation

Aerobic microbial reactions that occur underground preferentially use oxygen as the terminal electron acceptor due to energy requirements. Higher levels of oxygen result in microbial community growth that can attenuate chemical contaminants. Anaerobic biodegradation can also occur; however, aerobic conditions can enhance trace chemical constituent removal (Conn et al., 2010; Swartz et al., 2006; Carrara et al., 2008; Schaider et al., 2013; Teerlink et al., 2012; Heufelder, 2012).

9.1.5.2 Sorption and Ion Exchange

Sorption is another key mechanism governing the subsurface attenuation of trace chemical constituents. Factors affecting sorption include the hydrophobicity of the trace chemical, the organic matter present in the soil, the acid dissociation constant (pKa), and the soil pH (Schaider et al., 2013). If a chemical has a net negative charge in the soil, it is more likely to remain in solution because certain soil constituents (e.g. clay particles) also have a net negative charge (Schaider et al., 2013). Refer to the WateReuse Research Foundation (WRRF) project *Enhancing the Soil Aquifer Treatment Process for Potable Reuse* for further information on laboratory soil column studies assessing the key mechanisms governing subsurface attenuation of trace chemical constituents and pathogens (WRRF, 2015a).

Ion exchange is the soil's capacity to hold exchangeable ions at a given pH value. The acid dissociation constant and soil pH determine the ionization state of a given chemical, which affects sorption due to ion exchange.

9.2 Engineered Storage

Engineered storage is an additional approach in direct potable reuse (DPR) systems designed to provide capacity to manage fluctuations in water supply, water quality, and demand. An engineered storage reuse scenario is classified as DPR because there is no discharge to a natural water body. The number of facilities utilizing engineered storage in lieu of environmental buffers remains extremely limited to date. Engineered storage provides the appropriate residence time to allow adequate monitoring of the reclaimed effluent before discharging to the WTP or drinking water distribution system (**Figure 9-2**) (WRRF, 2011a).

Characteristics of an environmental storage buffer (ESB) may include the following: full control over the ESB environment, exclusion of contaminants from the surrounding environment, flow diversion and/or equalization, designed monitoring and sampling equipment, and optimized hydraulics (Khan, 2013). ESB construction can be costly and may not provide the same natural treatment associated with environmental buffers. There are multiple examples of ESB structures (stand-alone or integrated within the distribution system): large subsurface pipelines, constructed aquifers, enclosed subsurface storage reservoirs, lined and covered surface storage reservoirs, and above ground tanks (WRRF, 2011a). In all cases, ESB design depends on site-specific constraints and safety requirements (WRRF, 2011a). ESBs require proper sizing

and water quality parameter monitoring. To provide further treatment, an ESB can use chlorination or ozonation so long as residual monitoring occurs (WE&RF, 2016c). In instances where the DPR treatment train has relatively short failure response times (FRTs), disinfectant dosing may determine the ESB's size and design. This concept is described further in **Section 9.4**.



Figure 9-2. Engineered storage buffers in potable reuse treatment schemes

9.3 Response Time in Buffers

Response time is the time required to evaluate monitoring results and respond to a treatment failure before affecting the downstream water quality. There is an associated response time for each unit process and its applicable monitoring procedure (WE&RF, 2016c). Response time is one of the most significant factors in DPR system design, because a loss of response retention time may occur in the absence of an environmental or engineered buffer (WE&RF, 2016c). ESB functions incorporate response time. Additionally, DPR treatment systems require advanced monitoring techniques. Rapid, online, and real-time monitoring could serve as tools to protect public health; these tools enable the system operator to observe off-specification water and mitigate accordingly (Khan, 2013).

The Water Environment & Reuse Foundation's (WE&RF's) *Guidelines for Engineered Storage for Direct Potable Reuse* studied the FRTs for common unit processes and found that advanced monitoring techniques may drastically reduce the FRT. For example, standard monitoring approaches (direct integrity testing) for microfiltration membranes result in a FRT of 24+ hours; conversely, advanced monitoring techniques such as bioscans and particle counting can reduce the FRT for bacteria to minutes and protozoa to hours (WE&RF, 2016c). The log removal credit process can account for both sensitivity of monitoring techniques (actual reduction confirmed through monitoring) and the known process efficiency (actual proven reduction per unit process) (WE&RF, 2016c). For example, the FRT for reverse osmosis (RO) systems in DPR treatment trains is on the order of minutes using standard or advanced monitoring technologies. However, standard monitoring tests would result in a log removal credit of less than 2-log, whereas advanced monitoring tests could increase the log removal credit to between 4 and 6-log (WE&RF, 2016c).

9.4 Replacing the Value of the Environmental Buffer

Much of the literature regarding potable reuse and environmental buffers focuses on the buffer's role when it receives filtered and disinfected waters (WRRF, 2014e). The literature does not expand on the impact of an environmental buffer on high quality water, such as full advanced treatment and/or RO permeate (WRRF, 2014e). *Risk Reduction for Direct Potable Reuse* concludes that a process that can remove an additional 60% of trace chemical constituents and achieve a 5-log reduction of both viruses and protozoa is required to replace the environmental buffer's treatment value (WRRF, 2014a). While an additional level of treatment can offset the treatment effectiveness of an environmental buffer, it does not address the loss in response time from a process upset. A higher level of automation and monitoring or an engineered storage buffer can offset the loss in response time. Real time or near real time monitoring can potentially serve as a critical strategy in replacing the value of the environmental buffer.

CHAPTER 10

Training, Operating, and Monitoring

Operator training and certification is critical for the protection of public health and the maintenance of safe, optimal, and reliable operations of wastewater and water treatment plants and distribution facilities. EPA's role in operator certification is primarily related to providing tools, training, and guidance that is implemented by authorized states. There are no specific operator certification requirements outlined in the Clean Water Act (CWA); but, many state agencies have operator training and certification requirements for publicly owned treatment works (POTWs). The Safe Drinking Water Act (SDWA) contains requirements for drinking water plant training and operator certification; this chapter outlines some of the relevant requirements for potable reuse implementation. The chapter also covers key operations issues, such as hazard analysis and the establishment and monitoring of critical control points, start-up and commissioning, operation and maintenance (O&M), optimization of plant operations, and other monitoring considerations. This chapter does not specifically outline operator training requirements for advanced wastewater treatment facility (AWTF) operations in a potable reuse scenario. Instead, this chapter outlines the existing operator training and certification framework that exists within the CWA and the SDWA, and how these existing concepts may apply to AWTFs.

10.1 Operator Training and Licensure

The requirements for water treatment plant (WTP) operators could serve as an excellent guideline for the requirements for AWTF operators because the processes are similar. The staff that operates AWTFs for potable reuse should have extensive knowledge and skills regarding the design, management, and treatment processes used in the potable reuse system. Accredited training and certification programs will likely be a mandatory aspect of indirect potable reuse (IPR) and direct potable reuse (DPR) schemes. Thus, it is useful to examine the drinking water operator certification requirements in the context of potable reuse.

The 1996 SDWA amendments directed EPA on multiple operator-related issues:

- Initiate a partnership with states, water systems, and the public to develop information on recommended operator certification requirements.
- Issue guidelines for minimum operator certification and recertification standards in community water systems (CWSs) and nontransient, noncommunity public water systems (NTNCWSs).
- Reimburse, through grants to the states, training and certification costs for operators of CWS and NTNCWS systems serving 3,300 persons or fewer.

Subsequently, two EPA convened workgroups addressed issues related to operator certification and formulated specific program guidelines. EPA published the workgroups' nine baseline standards in *Final Guidelines for the Certification and Recertification of Operators of Community and Nontransient Noncommunity Public Water Systems* (1999a):

1. Authorization.
2. Classification of Systems, Facilities, and Operators.
3. Operator Qualifications.
4. Enforcement.
5. Certification Renewal.

6. Resources Needed to Implement the Program.
7. Recertification.
8. Stakeholder Involvement.
9. Program Review.

Licensed wastewater operators operate AWTFs. Currently, AWTF operators do not require a separate category of licensure or training. But, the AWTF processes require a different operator focus than wastewater treatment facilities. Additionally, most of these AWTFs are used in IPR applications, meaning licensed drinking water operators are responsible for the final treatment and distribution of the water downstream of the environmental buffer. Similarly, the two DPR facilities operated in Texas (Big Spring and Wichita Falls) include downstream drinking water plants operated by licensed drinking water operators. Many states have separate certification programs for water and wastewater operators, creating complications for the type of certification needed for the operation of a potable reuse facility.

As potable reuse plants become more common and the transition point between advanced wastewater purification and drinking water processes becomes less defined, requirements for operator training will need to evolve. Operator training must ensure that proper safeguards and procedures are maintained for monitoring and controlling water with potentially unique public health risks. Several organizations and state regulatory agencies are evaluating or developing operator training and licensure for AWTF facilities or for unit processes pertinent to AWTF. The Southeast Desalination Association, which provides operator training in the southeastern United States, developed membrane operator certification courses for reverse osmosis and nanofiltration plants, as well as a general certification course on membrane systems. These curricula were adapted by the South-Central Membrane Association (SCMA) and the Southwest Membrane Operator Association (SWMOA), providing training and certification for operators throughout the southern and western regions of the United States. In addition, SCMA developed a certification course focused on low pressure membranes (microfiltration and ultrafiltration), while SWMOA is developing certification training for operators of membrane bioreactors. California is currently evaluating whether to require a new type of operator certification for the operation of AWTFs used in potable reuse schemes. The California-Nevada American Waterworks Association is developing an operator certification program for water reuse facilities. The Wichita Falls case study in **Appendix A** describes how the city developed additional operator requirements when its DPR facility came online. A Water Environment and Reuse Foundation (WE&RF) study titled *Development of Operation and Maintenance Plan and Training and Certification Framework for DPR Systems* developed a framework for uniform training and certification requirements in DPR schemes (WE&RF, 2016a). It may not be essential to establish a uniform nationwide certification program for all AWTFs; but, it is clear that some portion of the treatment process will include drinking water treatment certification. Furthermore, developing training material and certification criteria can aid operators in understanding the critical nature of treatment barriers and the uniqueness of potable reuse treatment technologies.

10.2 Hazard Analysis and Critical Control Points (HACCP)

The Hazard Analysis and Critical Control Points (HACCP) approach is one proposed method for informing AWTF operations under the CWA and the SDWA. This approach was developed to prevent gastrointestinal illness in astronauts in the 1960's. It was subsequently adapted in the food industry to ensure food safety (FDA, 2017). HACCP can apply to potable reuse systems the same way it applies in other industries, such as aviation. But, it is important to note that HACCP is not a full risk assessment framework, but just one piece of a complete risk mitigation framework.

HACCP includes five pre-steps and seven steps. The five HACCP pre-steps include the following:

1. Assemble the HACCP team.
2. Describe the product.
3. Identify intended use.
4. Construct a flow diagram.
5. On-site confirmation of flow diagram.

There are seven steps in HACCP (FDA, 2017):

1. Hazard Identification - Characterize the wastewater, recognize constituents that may pose adverse health effects if not treated properly, assess the necessary (or mandated) log-removal values and allocate them amongst individual treatment processes.
2. Critical control point identification and design - Identify critical control points within each unit process and within the process as a whole.
3. Critical limits set - Identify a mechanism for measuring performance utilizing easily measurable parameters such as indicators and surrogates.
4. Monitoring system design and installation - Determine the components of the monitoring system that will be used to measure performance at the critical control points identified in step two.
5. Corrective actions planned and practiced - Establish an operational plan for mitigating local failures (i.e. performance criteria not met) and a plan for system failures.
6. Verification validation - Ensure quality assurance and quality control by outlining a framework for third-party verification and process validation.
7. Documentation - Document and develop recordkeeping systems.

HACCP is a widely-used approach for identifying hazards in order to control, minimize, and lessen the impact of system failures, and many variations of it have developed over the years (WRRF, 2014c). A 2014 WaterReuse Research Foundation (WRRF) study titled *Utilization of HACCP Approach for Evaluating Integrity of Treatment Barriers for Reuse* proposes a HACCP outline for potable water reuse treatment. The National Research Council's 2012 document titled *Water Reuse: Potential for Expanding the Nation's Water Supply Through Reuse of Municipal Wastewater* also outlines a potable reuse approach for HACCP (NRC, 2012a). The WE&RF (2016b) study *Critical Control Point Assessment to Quantify Robustness and Reliability of Multiple Treatment Barriers of a DPR Scheme* will conduct a hazard assessment for key unit operations and determine the critical control points of DPR schemes. Additionally, the World Health Organization (WHO) published a framework for a water safety plan that closely follows the HACCP concepts (WHO, 2009).

10.3 Start-up, Commissioning, and Initial Operation

During AWTF start-up, each component of the treatment train is tested separately, in combination with other key components, and finally as a complete treatment train. Each component's mechanical performance and produced water quality are verified. During the facility's initial months of operation, operations staff remain in close communication with equipment manufacturers and other third-party professionals to modify on-site conditions and ensure performance targets are met. In states where the project needs permit approval before operating, such as California, regulators review start-up data and visit the facility during commissioning. The facility should have a written standard operating procedure (SOP) review and SOP operator training.

10.4 Ongoing Operation and Maintenance

Primacy states must have “a systematic program for conducting sanitary surveys of public water systems in the State, with priority given to sanitary surveys of public water systems not in compliance with State primary drinking water regulations” (40 CFR 142.10(b)(2)). In the Interim Enhanced Surface Water Treatment Rule (IESWTR) (EPA, 1998a), a sanitary survey is defined as:

“an onsite review of the water source (identifying sources of contamination using results of source water assessments where available), facilities, equipment, operation, maintenance and monitoring compliance of a public water system to evaluate the adequacy of the system, its sources and operations and the distribution of safe drinking water.”

Conducting sanitary surveys on a routine basis is an important element in preventing contamination of drinking water supplies. Sanitary surveys provide an opportunity for the primacy agency to visit the water system and educate the operator about proper monitoring and sampling procedures and to provide technical assistance. Sanitary surveys are a proactive public health measure and an important component of the SDWA public water system supervision program (EPA, 2017t). The IESWTR requires that a sanitary survey addresses eight elements: source; treatment; distribution system; finished water storage; pumps, pump facilities, and controls; monitoring and reporting and data verification; system management and operation; and operator compliance with state requirements. IESWTR describes the timing for sanitary surveys (EPA, 1998a):

“The State must complete sanitary surveys for all surface water systems and [ground water under the direct influence of surface water] no less frequently than every three years for community systems and no less frequently than every five years for non-community systems. . . . The rule also provides that for community systems determined by the State to have outstanding performance based on prior sanitary surveys, successive sanitary surveys may be conducted no less frequently than every five years. In its primacy application, the State must include: 1) how it will decide whether a system has outstanding performance and is thus eligible for sanitary surveys at a reduced frequency, and 2) how it will decide whether a deficiency identified during a survey is significant.”

While the references herein specifically address surface water sources, there are also requirements for groundwater sources. The Ground Water Rule (GWR) requires states to conduct sanitary surveys for all groundwater sources to identify significant deficiencies, including deficiencies that could make a system susceptible to microbial contamination. Following the initial sanitary survey, states must conduct surveys every 3 years for community water systems (CWSs) (with allowance up to every 5 years depending upon the system’s performance and state’s evaluation) and every 5 years for non-community water systems (NCWSs) (EPA, 2006c).

AWTFs should have a regularly updated “living” operations plan that clearly identifies the roles and responsibilities of each staff. The plan should describe communication and decision-making procedures, provide a basic overview of the facility and the treatment unit processes, acceptable operating ranges for key processes, and contingency plans for process deviations or failures. For an example of an operations plan manual from the Orange County Water District in California, refer to National Water Research Institute (NWRI) section 11.6.2 (NWRI, 2015).

AWTFs need a facility maintenance strategy that includes an asset management program with software to track maintenance; this is a key component of avoiding equipment failure and protecting of public health. The facility needs a robust maintenance team to ensure proper operation of all conveyance, treatment, and

monitoring equipment. Periodic evaluation of facility operations could help provide a greater level of public acceptance for potable reuse.

10.5 Optimization and Improvement

Many AWTFS continually evaluate new technologies through an active program to identify and test new chemicals, processes, equipment, or tools to improve performance. AWTFS should carefully consider the protection of public health when changing operational practices.

Maintaining public health protection at water supply systems has become more challenging in recent years due to the resistance of some pathogens to chlorination and an increase in the immuno-compromised population (e.g., people with HIV, organ transplant patients). Also, as evidenced by documented pathogen occurrence, compliance with the 1989 Surface Water Treatment Rule (SWTR) and Total Coliform Rule (TCR) did not always assure public protection from waterborne disease. Based on this awareness, EPA developed new regulations to enhance control of microbial pathogen contamination in drinking water, while concurrently addressing other concerns such as disinfection by-products (DBPs). This interrelated regulation approach is moving the water supply industry toward meeting increasingly more complex water treatment requirements.

In 1988, the Composite Correction Program (CCP) was developed and demonstrated as a method of optimizing surface water treatment plant performance for protection from microbial contamination. This approach is based on the effective use of available water treatment process barriers against particle passage to the finished water. The program uses specific performance goals to define optimum performance for key treatment process barriers such as sedimentation, filtration, and disinfection. The CCP consists of two components - a Comprehensive Performance Evaluation (CPE) and Comprehensive Technical Assistance (CTA). A CPE is a thorough review and analysis of a plant's performance-based capabilities and associated administrative, operation, and maintenance practices. It identifies factors that may be adversely impacting a plant's ability to achieve permit compliance without major capital improvements. CTA is the performance improvement phase that is implemented if the CPE results indicate improved performance potential. During the CTA phase, identified plant-specific factors are systematically addressed and eliminated (40 CFR 142.16(g)(1)).

A similar approach, in complement with existing CCPs and CPEs for wastewater treatment plants (WWTPs), could apply to AWTFS that produce source water for drinking water treatment plants to provide optimized treatment processes and proactively identify and resolve maintenance issues.

10.6 Process Control and Monitoring

The transformation of municipal wastewater to a high-quality drinking water supply involves rigorous process control and monitoring protocols to ensure continuous public health protection. The purpose of monitoring is to assess process performance and trigger alarms if there is a change in normal operating conditions from a pathogen or chemical constituent outlook. Online real time and offline monitoring of potable reclaimed water is essential to protecting public health. Monitoring is already required for both wastewater treatment plants (WWTPs) and WTPs under the CWA and the SDWA, respectively.

Though existing advanced treatment processes are fully capable of producing a comparable, if not superior, water quality when compared to existing drinking water supplies, the response time for failure mitigation is inevitably shorter in DPR schemes. Therefore, accurate and robust monitoring and process control technologies are fundamental priorities during project development. While process control and monitoring are identified as key elements in advancing potable reuse, and many ongoing or planned research projects

aim to advance monitoring methods for DPR, it is not likely that new monitoring tools or programs will substantially change the current paradigm of treatment methods, or sizing and management of environmental and engineered storage buffers. Instead, it will likely be the meaningful use of the extensive body of data that is already collected through existing monitoring programs that could impact the implementation of DPR. Analysis of a facility's operating data could, for example, be facilitated through use of artificial neural networks and other predictive analytics. These kinds of tools have proven useful in predicting trends in financial and economic market sectors for nearly a decade. With the increasing availability of computing power, predictive analytics could be applied to DPR to provide integrated process evaluation, control, and proactive identification of preventive actions to demonstrate that the facility and processes are meeting the treatment objectives on a continuous basis.

The Water Research Foundation (WRF) report *Assessment of Techniques to Evaluate and Demonstrate the Safety of Water from Direct Potable Reuse Facilities: Literature Review* (Rock et al., 2016) characterizes available monitoring tools and strategies for meeting DPR treatment objectives. The WRF report provides practical information to utilities and municipalities interested in implementing DPR programs (Rock et al., 2016).

10.7 Selecting Monitoring Locations

Each treatment process must demonstrate its functioning as expected by careful selection of monitoring tools and locations. For potable reuse monitoring to be reasonably practical and operable, monitoring must focus on managing the risks to public health. **Section 10.2** describes the application of the HACCP methodology to water reuse. This methodology requires critical control points (CCPs) for both pathogen and chemical control.

10.7.1 Distinguishing Critical Control Points (CCPs) from Critical Operating Points (COPs)

CCPs are locations where essential unit processes occur, and powerful monitoring techniques can evaluate process performance to protect public health. Selecting a focused, concise list of CCPs that represent key risks to health, rather than adding every possible monitoring parameter for every piece of the process, allows the CCP methodology to succeed. Pathogen and chemical constituents require CCPs. An example of a CCP might be a reverse osmosis (RO) system, where the RO represents a CCP for both microorganism and chemical removal. In this case, the CCP can monitor for electrical conductivity: if the conductivity rises above a critical limit, a Supervisory Control and Data Acquisition (SCADA) system would sound an alarm and operators could take corrective action.

Additional monitoring requirements, called critical operating points (COPs), may be important to ensure successful facility operation. For example, antiscalant dosing and pH correction are important parameters for RO scaling management, but are not directly related to public health protection; therefore, these parameters serve as COPs rather than CCPs. Failure to manage RO scaling may result in loss of production, increased operating costs, and increased maintenance.

Operators must manage both CCPs and COPs. Differentiating between the two can clarify reporting, maintain appropriate regulator focus, and clearly demonstrate that public health is paramount.

For more examples of CCP and COP applications and step-by-step instructions on how to use the CCP framework for a potable reuse system, refer to the WE&RF (2016b) study *Critical Control Point Assessment to Quantify Robustness and Reliability of Multiple Treatment Barriers of a DPR Scheme*.

10.8 Phases of Monitoring: Validation and Compliance

Assessment of unit processes occurs in two phases: the piloting or commissioning phase (validation monitoring) and the full-scale operation phase (compliance/operational and verification monitoring).

10.8.1 Validation Monitoring

The objective of validation monitoring during commissioning is to ensure the treatment process is functioning as expected. Water quality is monitored for each treatment process and the final product water. Validation monitoring can last from 30 days to up to 6 months. The data collected during this period serves as a baseline of system performance for future comparison.

10.8.2 Compliance Monitoring

Long-term monitoring demonstrates the continuous production of high-quality water. Periodic grab sampling complements online continuous monitoring of certain parameters. For parameters that cannot be measured cheaply or quickly, infrequent periodic samples (such as quarterly or annually) can further verify process performance and build confidence in the treatment system.

In states that set log removal requirements for microbial or chemical indicators, unit process performance is monitored during operation to verify achievement of target log removals. In some cases, spiking studies (such as with viruses) demonstrated higher log removals through a given unit process than online monitoring demonstrated. For example, some spiking studies have shown 6-log removal of viruses through RO. However, RO performance is typically verified using online electrical conductivity or online total organic carbon (TOC) meters, which only can detect 1 to 2-log range. Therefore, the RO system can only receive 1 to 2-log removal credits if ongoing monitoring includes these instruments. Alternatively, surrogates such as sulfate, phosphate, and proprietary dyes can provide a range of 3 to 5-log. As a result, the selection of monitoring tools has important design implications and should be a significant design component. Monitoring tools with greater detection ranges allow for higher credits for the unit processes they monitor.

For a summary of pathogen log reduction credits achieved by full advanced treatment and biofiltration-based treatment and the performance monitoring methods used to verify those log removal values, refer to Tables 7.4a and 7.4b in the *Framework for Direct Potable Reuse* (NWRI, 2015). The credited log removals for each unit process may change as monitoring tools improve.

10.9 Calibration

All monitoring tools require regular calibration per manufacturer guidance. Also, periodic grab samples measured with bench-top methods occur regularly (often weekly); bench-top methods verify data generated by continuous online tools. These calibration procedures are similar or identical to those used in conventional drinking water plants. But, potable reuse facilities may rely on critical control instruments generally not considered critical at a conventional plant (such TOC or free ammonia analyzers).

10.10 Reporting

Although local authorities specify reporting requirements, it must involve annual reports at a minimum. Annual report preparation is an opportunity to critically evaluate facility operations for meeting the stated water quality objectives. For an example of the components of an annual report from the Orange County Water District in California, refer to NWRI section 11.6.3 (2015).

10.11 Indicators and Surrogates

Chapter 4 discussed potential chemical and microbial constituents present in wastewater. Indicator compounds, surrogate parameters, and/or conservative tracers are commonly used to predict concentrations or removal of pathogenic microorganisms and hazardous chemical contaminants. Accurate characterization of water quality involves the meticulous selection of a suite of indicators and surrogate parameters appropriately aligned with target contaminants. Indicators and surrogates help determine the efficacy of individual removal mechanisms and treatment barriers where it is impractical to measure actual target contaminants (Khan, 2013; EPA, 2012a; WHO, 2001). The overall objective of such monitoring is to inform whether potable reuse water can demonstrate log removal or *de minimis* risk situations. Monitoring less costly indicators, rather than pathogens or hazardous chemical contaminants, allows for more testing and potentially provides for a more reliable assessment of process variability. Ideally, the selected suite of indicators represents many physiochemical properties and behaviors, and provides information regarding the removal of other compounds with similar properties. The ultimate goal is to develop a potable reuse monitoring framework that provides assurance that potentially harmful chemical and microbial constituents are removed during treatment.

Table 10-1 and **Table 10-2** summarize important monitoring terms that can help remove the ambiguity in using the general terms indicators and surrogates.

Table 10-1. Microbial monitoring terms (adapted from WHO, 2001; WRF, 2008; NRC, 2012a; EPA, 2012a)

Term	Comment
Fecal contamination indicator	Historically, total coliforms, fecal coliforms, <i>Escherichia coli</i> , fecal streptococci, and enterococci are used as indicators of possible sewage contamination, because they are commonly found in human and animal feces. Although they are generally not harmful themselves, they indicate the possible presence of a fecal contamination event. There is no direct correlation between any fecal contamination indicator and enteric pathogens – the indicators only imply that pathogens may be present since fecal matter may be present.
Microbial treatment process performance indicator	A valid performance indicator has the same relative rate of removal or destruction as a specific target pathogen for a specific treatment process. For example, monitoring total heterotrophic bacteria or total coliforms can give an idea of the effectiveness of chlorine disinfection for many bacterial pathogens, but does not give meaningful predictions of the effectiveness against viral or protozoan pathogens. Similarly, coliphage is used to predict viral degradation in treatment processes.
Microbial treatment process performance monitoring tool	Similar to performance indicators, a valid performance surrogate has the same relative rate of removal or destruction as a specific target pathogen or group of pathogens for a specific treatment process. For example, measuring electrical conductivity across an RO membrane demonstrates membrane integrity, and indirectly implies whether pathogens are removed upstream of the membrane (all pathogens are orders of magnitude larger than the salt ions detected in conductivity measurements).

Table 10-2. Chemical monitoring terms (adapted from WRF, 2008; NRC, 2012a)

Term	Comment
Chemical treatment process performance indicator	Indicators can be selected for specific treatment processes or a complete treatment train. Examples of chemicals that represent broader classes of compounds based on physicochemical properties, such as functional groups. These indicators demonstrate the effectiveness of advanced oxidation performance.

Term	Comment
Chemical treatment process performance surrogate	As for indicators, surrogates can be selected for specific treatment processes or a complete treatment train. TOC is a surrogate for organic matter and often is monitored for overall treatment performance as well as the proper functioning of specific treatment steps. California requires purified water have a TOC less than 0.5 mg/L prior to groundwater recharge, whereas Florida requires less than 3 mg/L. EPA 2012 Guidelines suggest less than 2 mg/L.

10.11.1 Microbial Treatment Process Performance Indicators

Monitoring pathogen densities at low enough concentration levels in finished water to indicate log removal, inactivation, or *de minimis* risk is not feasible due to cost, time, and enumeration method constraints. Therefore, the use of indicator organisms or treatment process control parameters are required to determine microbiological treatment performance of potable treatment trains.

10.11.1.1 Protozoa

The most recognized treatment process performance criteria for protozoan removal/inactivation includes 1) defined design and operating conditions and turbidity criteria for different filtration processes and 2) the use of CT (residual concentration x contact time) values for inactivation. These criteria form the basis for demonstrating protozoan removal/inactivation efficiencies under EPA's treatment technique requirements (EPA, 1998b). Alternatively, Clostridia, such as *Clostridium perfringens* and *Clostridium sporogenes*, can act as treatment process performance indicators for protozoa such as *Giardia lamblia* and *Cryptosporidium parvum*; but, this approach may not be as easy to monitor (Khan, 2013).

The North Carolina regulations for Type 2 reclaimed water, which is the most restrictive water quality category regulated for state water reuse, recently added *C. perfringens*. Type 2 reclaimed water can directly supplement a drinking water source, provided the blended water is impounded for 5 days and the reclaimed water does not exceed 20 percent of the average flow into the impoundment. The rules for Type 2 reclaimed water specify effluent microbial concentrations and treatment performance requirements for *E. coli*, coliphage, and *C. perfringens*. To date, North Carolina is the only state that uses *C. perfringens* as an indicator in its water reuse regulations. Europe has used *C. perfringens* as a fecal contamination indicator (not process performance indicator) since the 1960s (NRC, 2004). Some states, such as California, require monitoring of *Giardia* and *Cryptosporidium* spp., which can take up to 24 hours to cultivate and are costlier than indicator compounds, as mentioned previously (EPA, 2012a).

10.11.1.2 Bacteria

The most commonly tested fecal bacterial indicators are total coliforms, fecal coliforms, *Escherichia coli*, and enterococci.

Total coliforms are a group of bacteria that are widespread in nature. All members of the total coliform group can occur in human feces, but some can occur in animal manure, soil, submerged wood, and in other places outside the human body. In drinking water, total coliforms inform the adequacy of water treatment for bacteria and the integrity of the distribution system, because their presence indicates contamination of a water supply by an outside source (see discussion of the Total Coliform Rule in **Chapter 3**).

Fecal coliforms, a subset of total coliform bacteria, are more fecal-specific in origin. *E. coli* is a species of fecal coliform bacteria that is specific to fecal material from humans and other warm-blooded animals. The Revised Total Coliform Rule added *E. coli* to drinking water regulations (fully implemented April 1, 2016).

Enterococci are distinguished by their ability to survive in salt water; this characteristic more closely mimics many pathogens compared to other bacterial indicators. Enterococci are typically more human-specific than the larger fecal streptococcus group. EPA does not currently have drinking water recommendations for enterococci.

Potable reuse schemes use microbial indicators because they are non-seasonal, more abundant, and therefore more sensitive, affordable, and faster to enumerate than directly monitoring pathogens of concern (e.g. noroviruses and rotaviruses) (Khan, 2013). However, they are also relatively limited in their ability to predict the presence of pathogens (as fecal contamination indicators) or removal of pathogens (as microbial treatment process performance indicators) (EPA, 2012a; Khan, 2013).

10.11.1.3 Viruses

Enteric viruses may exist in water that is free of bacterial indicators because bacteria are less resistant than most viruses to environmental factors and water and wastewater treatment processes (EPA, 2015a). This shortcoming of bacteria as a treatment performance indicator also pertains to protozoa; this is why EPA prescribes treatment technique requirements for viral and protozoan pathogens rather than relying on coliform occurrence in distribution systems. The same is true for ambient surface waters. While existing 2012 recreational water quality criteria are based on enterococci and *E. coli*, published research indicates that coliphages may be equally good indicators of fecal contamination as *E. coli* and enterococci, and better indicators of pathogenic virus removal in treated wastewater than bacteria (EPA, 2015a). As mentioned in **Chapter 3**, EPA is currently developing a coliphage-based recreational water quality criterion. EPA published two standardized enumeration culture-based methods published (Method 1601 and 1602) for both male-specific and somatic coliphages (EPA 2001b,c). EPA is also currently evaluating an ultrafiltration method (dead-end hollow tube fiber) for concentrating viruses in multiple liters of water, with enumeration by EPA Method 1602.

California recycled water regulations utilize lab strain coliphages (MS2) as treatment performance indicators, whereas North Carolina reclaimed water regulations utilize indigenous coliphages at the end of the pipe to verify removal of infectious viruses (regulations can be found in **Chapter 3**).

Some pathogenic viruses can be detected using cell culture methods. Cell culture methods are not, however, available for all pathogens, and some cell culture assays require several weeks. Where cell culture based methods are not available, researchers rely primarily on molecular methods; but, these methods cannot distinguish between viable and non-viable particles. See *Assessment of Techniques to Evaluate and Demonstrate the Safety of Water from Direct Potable Reuse Facilities* (Rock et al., 2016) for a discussion on cell culture methods.

10.11.2 Microbial Treatment Process Performance Surrogates

There are several examples of microbial treatment process performance surrogates for various membrane-based treatment systems. For example, measuring electrical conductivity or TDS across an RO membrane demonstrates membrane integrity. It also indirectly implies whether pathogen removal occurs upstream of the membrane since all pathogens are orders of magnitude larger than the salt ions detected in conductivity measurements. Fluorescent dyes and microspheres may detect RO membrane imperfections that would impact virus removal with up to 4-log sensitivity (Khan, 2013). The presence of dyes or microspheres in the permeate stream would indicate membrane damage or overall system compromise (such as faulty interconnectors or o-rings). Similarly, there is a range of treatment process performance surrogates used for monitoring disinfection processes. In chlorine disinfection systems, monitoring free chlorine residual determines if CT treatment objectives are met. Alternatively, application of the CT concept also applies to systems using chloramines, ozone, or chlorine dioxide. For UV disinfection systems, UV dose is measured

rather than CT to inform log inactivation for viruses or protozoa. Often, all of these process monitoring parameters are tied to process control. For example, often when total residual chlorine or UV intensities are low, the chemical or UV dose can be increased.

10.11.3 Chemical Treatment Process Performance Indicators

Multiple chemical indicators should be selected to represent a wide-range of physiochemical properties, such as molecular size, pH adjusted octanol-water partition coefficients (D_{ow}), acidity constants, volatility, dipole moment, etc. Physiochemical properties govern the attenuation of contaminants during treatment, therefore selecting multiple chemical indicators with a variety of physiochemical properties will inform the removal performance of unknown or emerging contaminants and target contaminants with similar properties (Khan, 2013; Bellona et al., 2004). In concept, monitoring indicators that are consistently measurable in secondary treated wastewater and possess a broad range of physicochemical properties can provide some level of assurance that chemical constituents, including unknown compounds and degradation products, are removed (Dickenson et al., 2011). Detection of indicator compounds above some threshold could indicate performance deficiencies (Kahn, 2013). There is currently no consensus in the scientific research community regarding what thresholds are appropriate. In potable reuse projects, current practice is to remove indicator compounds to current detection levels; however, current detection limits may come into debate as methodological improvements continue to lower detection levels. See 2016 WRF report *Assessment of Techniques to Evaluate and Demonstrate the Safety of Water from Direct Potable Reuse Facilities* for a discussion on indicators applied to potable reuse (Rock et al., 2016).

10.11.4 Chemical Treatment Process Performance Monitoring Surrogates

Since chemical indicator measurements generally involve sophisticated analytical equipment and require days to weeks for analytical results, monitoring chemical surrogates can provide a way to assure that treatment barriers are performing as expected with near instantaneous results. There are various chemical surrogates, such as conductivity, turbidity, biochemical oxygen demand (BOD), UVA, TOC, total nitrogen, nitrate, and fluorescence excitation/emission matrix spectroscopy; see the 2016 WRF report *Assessment of Techniques to Evaluate and Demonstrate the Safety of Water from Direct Potable Reuse Facilities* for a discussion on these surrogates (Rock et al., 2016).

A WaterReuse Foundation (WRF) study, entitled *Development of indicators and surrogates for chemical contaminant removal during wastewater treatment and reclamation* (WRF, 2008), investigated surrogate parameters and indicator compounds for wastewater-derived chemical contaminants in IPR systems. The project goals were to analyze the performance of analytical methods used to measure indicator concentrations and to assess the capability of the selected surrogates and indicators to accurately predict the occurrence of target contaminants. The study included an inter-laboratory comparison that revealed significant variations in recovery and relative standard deviations of indicator concentrations between experienced analytical laboratories. This indicated the high degree of uncertainty in concentrations reported at the low ppt-level. Researchers binned indicator compounds into categories indicating whether they were well-removed by specific unit processes and suggested monitoring approaches for start-up and full-scale operation of various types of treatment. The study demonstrated that surrogates do not usually correlate strongly with the actual removal of trace chemical constituents at the ng/L level. However, changes in surrogate parameters can demonstrate the beginnings of performance deficiencies and can monitor a specific unit operation or an entire treatment train's performance. By combining the monitoring of surrogate measures with targeted indicator chemicals, the surrogates can be calibrated to indicate when treatment processes are not performing as designed (Snyder, 2014).

The monitoring requirements outlined in the California Groundwater Replenishment with Recycled Water regulations serve as an example of surrogate parameters and a suite of chemical indicators used in conjunction to assess the performance of unit operations. The California Department of Public Health (CDPH) specifies that one of two approaches involving chemical indicators must be used to ensure the proper functionality of advanced oxidation processes through pilot testing. The first option requires an occurrence study involving the identification of nine indicators present in the source water. It also requires the identification of appropriate dosing conditions to achieve 0.5-log removal of indicators in Groups A-G and 0.3-log removal of indicators in Groups H-I (**Table 10-3**). In addition, at least one surrogate parameter or operating parameter must be used to continuously monitor for the removal of at least five of the nine chemical indicators (WRRF, 2013a; CDPH, 2014). Pilot testing, including challenge or spiking tests, must confirm the results. (See **Chapter 3** for additional information on California requirements.)

Table 10-3. Potential indicator compounds with differing physiochemical properties to demonstrate

Group Title	Functional Group	Potential Indicators ¹
A	Hydroxy Aromatic	Acetaminophen, Benzyl salicylate, Bisphenol A, Estrone, Hexyl salicylate, Nonylphenol, Triclosan, Clorifibric Acid
B	Amino-Acylamino Aromatic	Sulfamethoxazole, Atorvastatin, Triclocarban
C	Nonaromatics with Carbon Double Bonds	Acetyl cedrene, Carbamazepine, Codeine, Methyl ionine, Simvastatin hydroxyl, Terpeneol
D	Deprotonated Amine	Atenolol, Caffeine, Diclofenac, Erythromycin-H ₂ O, Fluoxetine, Metoprolol, Nicotine, Trimethoprim
E	Alkoxy Polyaromatic	Naproxen, Propranolol
F	Alkoxy Aromatic	Gemfibrozil, Hydrocodone
G	Alkyl Aromatic	Benzophenone, Benzyl acetate, Bucinal, DEET, Dilantin, Ibuprofen, Primidone, Tonalide
H	Saturated Aliphatic	Iopromide, Isobornyl Acetate, Meprobamate, Methyl Dihydrojasmonate
I	Nitro Aromatic	Musk Ketone, Musk Xylene

¹ Not intended to be an exhaustive list.

In addition to online or rapid off-line surrogate testing, the use of rapid bioassays can provide information about water quality that aggregates impacts from all chemicals or nanomaterials present. This includes degradation products and new chemicals under development. Recent advances in genomics, proteomics, metabolomics, and computer modeling have proliferated the ability to examine cellular responses to water quality using a range of bioassays (Snyder, 2014). These approaches help capture potential effects due to the presence of chemical mixtures. Whole effluent toxicity testing is an example of a bioassay that is routinely used to monitor the water quality of treated wastewater prior to discharge into surface waters. Challenges persist in extrapolating observed cellular responses to adverse human health effects and in developing high-throughput broad bioassays (Tice et al., 2013; Snyder, 2014). Bioassays can be paired with mass spectroscopy; a sample that produces bioactivity (observed through inexpensive bioassays) can

be used to screen samples for targeted analysis using more expensive high-resolution mass spectrometry *ex post facto* to identify chemicals.

CHAPTER 11

Cost of Potable Reuse

11.1 Introduction

Much of the discussion on potable reuse implementation deals with public perception issues, regulatory concerns, and safety considerations, all of which have significant impacts on the cost of implementing potable reuse. These concerns have driven existing potable reuse projects to utilize advanced treatment technologies with extensive monitoring approaches and consistent, near complete removal of potentially harmful contaminants.

The costs of these advanced wastewater treatment facilities (AWTFs), which include microfiltration (MF), reverse osmosis (RO), and ultraviolet light (UV or UV-advanced oxidation), provide a baseline for understanding costs for the majority of recent, U.S. potable reuse projects. Less costly alternatives may be available for future projects, particularly for inland locations where total dissolved solid (TDS) concentrations in treated wastewater effluent do not require salt removal. Understanding how alternative treatment train options impact costs will provide a basis for evaluating potable reuse against other water supply alternatives within a community's water supply portfolio.

11.2 Cost Estimates

Cost often drives the selection of treatment alternatives; but, it is important to consider other technical criteria for a long-term project that includes substantial operating and maintenance costs. Most engineering feasibility studies include the development of lifecycle costs; this allows for comparison between alternative systems when evaluating multiple configurations that could meet the same treatment objectives.

In addition, the same treatment system may vary in cost based on project delivery and equipment procurement methods. Decisions about these methods are multifaceted and are both site- and owner-specific. Lifecycle costs should include capital equipment costs, construction, replacements part costs (based on warranty period), chemical and labor costs, power costs, and several other ancillary factors. Final decision-making about the best treatment system for a specific application may include non-cost factors. These non-cost factors may include environmental and recreational impacts, avoided costs of water supply, local economic impacts, and water quality reliability (Tricas and Liner, 2017).

A recent WaterReuse Research Foundation (WRRF) study provided an overview of alternative treatment trains for reuse, the costs, and a triple bottom line (TBL) (financial, environmental, and social elements) evaluation of the treatment train alternatives. Additionally, WRRF provided a comparison of the costs of direct potable reuse (DPR) and indirect potable reuse (IPR) to seawater desalination, brackish groundwater desalination (inland), imported water, non-potable reuse, and water use efficiency, conservation, and restrictions based on California cost estimates (WRRF, 2014b). Since costs vary significantly with time, future cost considerations should reflect published cost indices and anticipation of future cost escalation.

11.2.1 Capital Costs

Total capital costs should include any structural, civil, electrical, instrumentation and controls, and other support systems necessary for project implementation. The cost of treatment equipment for any potable reuse project is often only a fraction of the total construction cost, but required to make accurate estimates

of both construction and lifecycle costs; additionally, treatment equipment costs contain an understanding of the equipment suppliers' scope of supply.

While the database of operational DPR facilities is limited (AWWA, 2016), there are a large number of operational indirect potable reuse (IPR) projects using similar or identical treatment processes (Chalmers et al., 2010). The construction costs for reuse facilities varied, depending on the location, capacity, and ancillary facilities included; the facilities averaged approximately \$6.75/1,000-gal capacity (February 2015 dollars), with a limited economy of scale between projects ranging in size from 1.8 million gallons per day (MGD) (Big Spring, Texas: \$7.0/1,000 gal) to 70 MGD (Orange County, California: \$6.5/1,000 gal) (Chalmers et al., 2010; Bailey, 2013; Sloan, 2013; Chalmers et al., 2013; WRRF, 2014c)

The costs above do not include engineering, permitting, or other project development costs, which can be approximately 25 percent of the total project costs. Further, these costs do not include off-site costs for transmission of product water or supply of feed water; these costs will vary depending on the project. The largest components of capital costs are the microfiltration and RO equipment, which each account for approximately 25 percent of the overall construction costs once installed. Low costs are the result of the unique locations of existing facilities, either near the ocean or near an inland location where brine disposal will not have a significant environmental impact.

11.2.2 Operations and Maintenance Costs (O&M Costs)

Operations and maintenance costs (O&M costs) for membrane based potable reuse facilities generally range from \$1.8 to \$2.0 per thousand gallons or \$0.48 to \$0.53 dollars per cubic meter (Bailey, 2013; Patel, 2010; Won et al., 2010; Chalmers et al., 2013). Some O&M costs will vary depending on the actual production of the plant, while other O&M costs will be fixed. Variable O&M costs include costs for chemicals, power, UV lamp replacement, cartridge filter replacement, concentrate disposal, and other miscellaneous costs. Fixed O&M costs include labor, membrane replacement, and equipment repair and replacement, which are generally independent of the variations in daily production. Most operational U.S. IPR facilities currently operate at or near their rated capacities, limiting the variation in O&M costs (Won et al., 2010; Chalmers et al., 2013).

Figure 11-1 includes a breakdown of typical O&M costs of a potable reuse facility using a membrane-based treatment train. These costs are based on a hypothetical 10 MGD facility but derive from actual operating costs of existing, online facilities. The actual breakdown of various O&M costs will vary from plant-to-plant and treatment train, but the largest cost components will generally be power and labor.

For potable reuse facilities, the RO feed pumps typically account for roughly half of the overall power use, with membrane filter pumps and UV systems each accounting for 5 to 10 percent of the total power. Higher salinity water will require more power to treat with RO, while water with high fouling potential (such as a non-nitrified source water) will result in higher power costs for all of the membrane processes.

Finished water pumping may be a substantial cost, but it depends on the pumping distance and elevation that the water must be pumped to; the costs presented in **Figure 11-1** do not include finished water pumping. Similarly, brine disposal costs can be a substantial component of the operating costs for many inland facilities. However, disposal costs are typically only minor O&M cost components for IPR. Treatment requirements post-AWTF may impact the overall cost of producing final product water. For example, AWTF water requires subsequent treatment to satisfy the surface water treatment rules (SWTRs) if it discharges into a surface water body or engineered storage buffer or goes directly to the water treatment plant (WTP). AWTF water may only require chlorination if it is for aquifer recharge and the withdrawn water is considered groundwater.

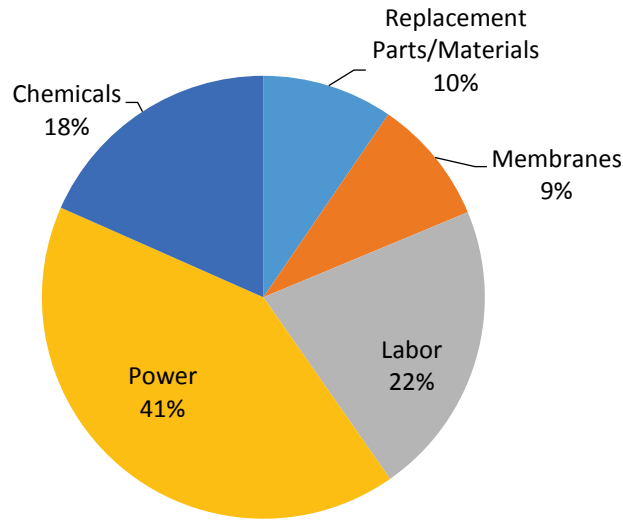

Figure 11-1. Typical O&M cost breakdown of a potable reuse facility using a membrane-based treatment train

11.2.3 Cost of Alternative Treatment Trains

There are methods for assessing alternative treatment processes that would support the implementation of more cost-effective treatment trains, particularly where TDS removal does not require RO. Ozone-biologically active filtration (ozone-BAF) is garnering interest as one of the alternative treatment trains for DPR applications, as described in **Chapter 7**. From an O&M cost perspective, the O&M costs for an ozone-BAF system include labor, power, chemicals (including liquid oxygen), laboratory and monitoring costs, equipment maintenance and repair, residuals management, and other minor costs. RO-based plants have significantly higher O&M costs, primarily due to significantly higher power requirements than the ozone-BAF treatment train. RO-based treatment trains employ mechanically intensive processes, which result in 2.5 times as much electricity as the ozone-BAF plants (average of 3867 kWh/MG [1.0 kWh/m³] for RO-based treatment compared to approximately 1400 kWh/MG [0.37 kWh/m³] for ozone-BAF treatment) (WRRF, 2014d). In contrast, the San Diego Pure Water Facility treatment train used ozone-BAF as pretreatment and full advanced treatment, resulting in a projected power usage of more than 11,000 kWh/MG (3.0 kWh/m³) (MWH et al., 2016). These higher costs are partially due to conservative assumptions used in facility planning, but also demonstrate the potential for increased facility costs when adding additional treatment steps beyond full advanced treatment.

11.2.4 Cost of Water

The nominal cost of water is calculated by dividing the sum of the annualized capital cost and annual O&M costs by the volume of water produced during the year; the result is usually expressed as dollars per unit volume, for example, in dollars per thousand gallons (\$/kgal), dollars per cubic meter (\$/m³), or dollars per acre-foot (\$/AF). The calculations included herein assume a 5 percent interest rate with capital costs annualized over 20 years. Typical treated water costs for a 10 MGD indirect potable reuse facility would range from \$2.8 to \$4.1 per thousand gallons. A white paper from the WateReuse Research Foundation (WRRF, 2014b) lists a larger range of \$2.5 to \$6.1 per thousand gallons (\$820 to \$2,000 per acre-foot or \$0.7 to \$1.6 per m³) that includes estimates of significant brine disposal costs and conveyance costs for pipeline construction in the high-end estimates.

The level of treatment provided in potable water reuse projects may vary throughout the country, depending on the source water quality, the level of treatment required, and the type of potable reuse practiced. Thus, selecting the appropriate treatment technology for potable reuse (including both IPR and DPR) can be a complex decision. Governmental organizations, non-governmental organizations, and advocacy groups can influence the selection of more expensive treatment. This is partially because the full financial, environmental, and social elements of the TBL may not be considered (WRRF, 2014d). WRRF funded a study to develop and apply a TBL framework to guide the water reuse selection process to provide information to utilities about the real cost of treatment. *Fit for Purpose Water: The Cost of Overtreating Reclaimed Water* evaluated and documented two IPR via surface water augmentation reuse scenarios. The treatment trains considered for planned IPR were the full advanced treatment train and an ozone-BAF process, as shown in **Figure 11-2** and **Figure 11-3**; these scenarios were evaluated for flows of 5, 20, and 70 MGD.

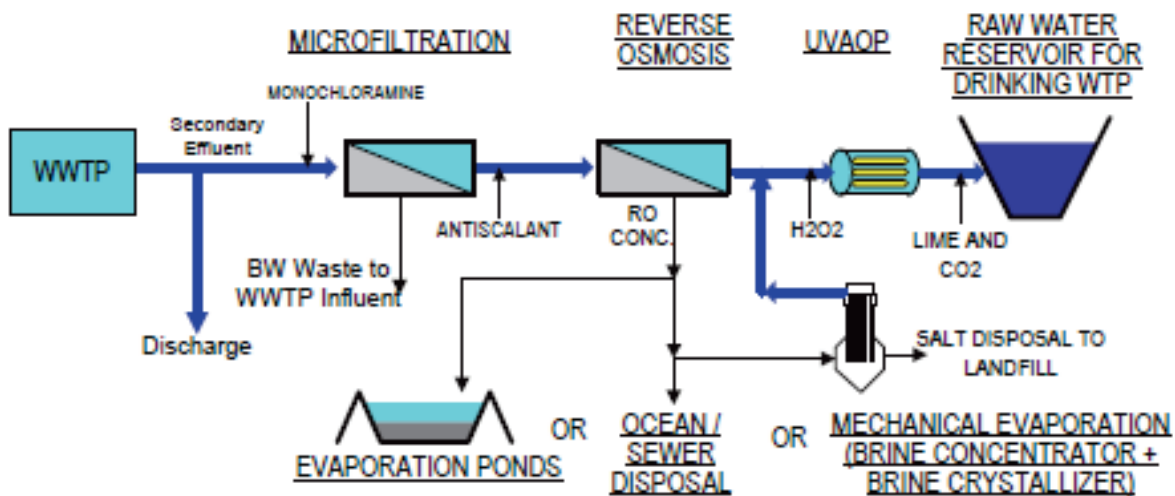

Figure 11-2. Full advanced treatment train

© Copyright 2014 WaterReuse Research Foundation (project 10-01), used with permission

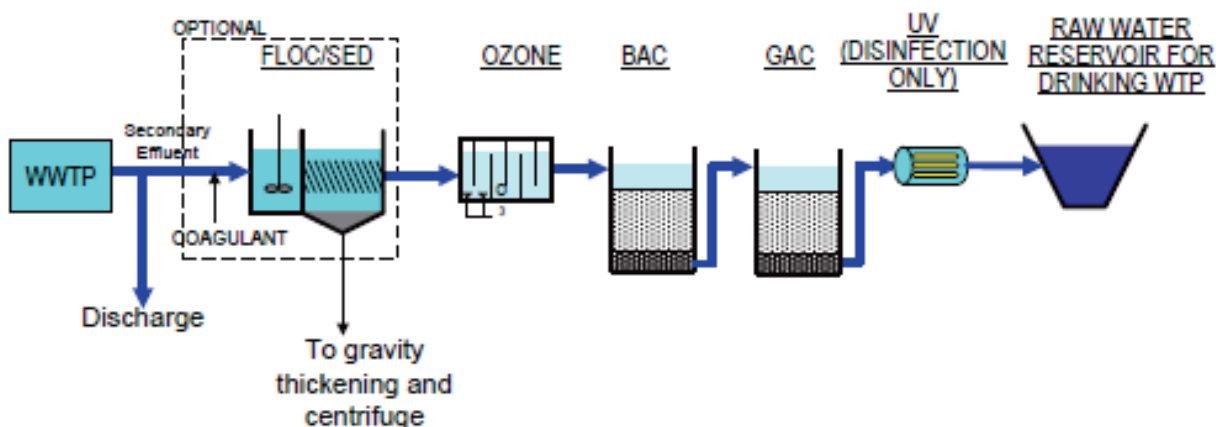

Figure 11-3. Ozone-BAF treatment train

© Copyright 2014 WaterReuse Research Foundation (project 10-01), used with permission

The study demonstrated several important points (WRRF, 2014d):

- Non-membrane based treatment trains have the lowest TBL costs for all flows analyzed; capital, O&M, and total TBL costs were lowest for the ozone-BAF alternative.
- There is an economy of scale for non-membrane based treatment at higher flows (> 20 MGD); for example, at 20 MGD, the full advanced treatment alternative was 32% more than the ozone-BAF train and at 70 MGD, full advanced treatment was 54% higher than ozone-BAF.
- Management of RO concentrate is a limiting factor for locations where sewer or ocean outfall options for brine disposal were not possible; concentrate handling and disposal significantly impacted the cost of the full advanced treatment alternative and approximately doubles the cost of providing treated water.

Table 11-1 provides a summary of the costs developed in this report for a 20 MGD scenario.

Table 11-1. Cost of alternative treatment trains for a 20 MGD facility (adapted from WRRF, 2014d)

Process		Ozone-BAF	Full advanced treatment with RO Concentrate Disposal		
			Ocean Outfall	Mechanical Evaporation	Evaporation Ponds
Cost/Impact					
Capital Cost (millions)		\$91	\$120	\$172	\$303
Annual O&M Cost (millions)		\$4.2	\$5.9	\$10.9	\$6.3
Annual Environmental Costs (millions)		\$0.4	\$1.6	\$6.3	\$2.2
Total TBL NPV (millions)		\$173	\$267	\$533	\$512
Cost of Water (including environmental costs)	\$/AF	\$386	\$596	\$1,190	\$1,143
	\$/1000 gal	\$1.18	\$1.83	\$3.65	\$3.51
	\$/m ³	\$0.31	\$0.48	\$0.96	\$0.93
Power Consumption (MWh/year)		4,400	16,000	65,400	22,000
Chemical Consumption (dry tons/year)		1,770	1,860	3,020	1,860
Air Emissions (tons/year)	CO ₂	2,900	13,400	44,200	17,200
	Other	11	30	150	49

While others have presented similar cost data ranges (NWRI, 2015), extrapolating the cost data presented here to a specific current or future project requires caution, because these costs derive from a limited number of operational facilities. Furthermore, these costs are presented to give the reader an approximate idea of costs for two generic treatment options. Detailed estimates of costs for any potable reuse facility should be part of a potential feasibility analysis. However, it is quite clear from the cost information presented here that a non-membrane based treatment process is the most cost-effective solution for providing AWT water. Typically, IPR does not use salt removal processes, but certain conditions require its use; these conditions include coastal and desert areas where water supplies are already high in TDS. In these cases, RO treatment may be necessary for reducing TDS; but, utilities should consider this process carefully before implementation because of the high costs. Alternatives should be considered, such as partial RO treatment and blending with other lower TDS sources (WRRF, 2014d).

RO brine management costs may limit the cost effectiveness of DPR employing RO as compared to other options for providing potable reuse source water. As previously discussed, costs associated with RO

concentrate management are site-specific and vary depending on the characteristics and volume of the concentrate.

Table 11-2. Costs of RO concentrate management options for potable reuse treatment (from Table 10.3 in NWRI, 2015)¹

Disposal option	Cost Range ²		Typical Cost ²	
	\$/AF	\$/10 ³ gal	\$/AF	\$/10 ³ gal
Deep well injection	50-80	0.15-0.25	70	0.21
Evaporation ponds	140-175	0.43-0.54	155	0.48
Land application, spray	135-160	0.41-0.49	115	0.35
Brine line to ocean	110-150	0.35-0.38	115	0.35
Zero liquid discharge	700-850	2.15-2.61	775	2.38

Notes: Adapted in part from WRRF, 2014b.

¹The reported costs are based on an Engineering News Record Construction Cost Index of 9900. Value of index in 1913=100.

²Based on a concentrate flow of 2 Mgal/d. $\$/10^3 \text{ gal} \times 325.892 = \$/A$.

CHAPTER 12

Epidemiological and Related Studies

Epidemiological studies can be used to study the occurrence and etiology of adverse health outcomes including potential adverse health impacts originating from reclaimed water. Currently few epidemiological studies evaluate the possibility of adverse health impacts from drinking reclaimed water, and these studies are limited and represent an area where additional data is needed.

For water reuse, identifying the cause of public health issues that coincide with conditions at a treatment plant or in finished water could assist in determining the source of potential infections. For example, if a certain strain of adenovirus is the cause of a gastroenteritis outbreak and the same strain is also detected in treated water, the case for cause and effect is stronger. If no such relationship is observed, then the source of infection is potentially a causative agent other than virus strain detected in the potable water.

12.1 Epidemiology of Water Reuse

A discussion of epidemiological studies on reclaimed water can be found in Appendix A of Water Research Foundation's *Assessment of Techniques to Evaluate and Demonstrate the Safety of Water from Direct Potable Reuse Treatment Facilities* (Rock et al., 2016) shown below in **Table 12-1**.

Table 12-1. Epidemiological and related studies on health effects pertaining to reclaimed water consumption (Rock et al., 2016. Reproduced with permission. © Water Research Foundation)

Study	Brief Project Description	Epidemiological Study Description	Reporting Period	Primary Conclusion	Reference
IPR Montebello Forebay Project – LA County, CA, Study No.1 (The Health Effects Study)	Recycled water, in addition to imported river water and stormwater, has been used for recharge of the groundwater since 1962. From 1962 to 1977, recycled water used for recharge was treated to secondary effluent disinfection standards.	Evaluated mortality, morbidity, cancer incidence, and birth outcomes using census tracts for two recycled water areas (high and low concentration) and two control areas. A telephone interview study was conducted interviewing adult females living in areas where recycled water was consumed, as well as interviews of adult females who were part of a control group. Interviews included questions on abortions, adverse reproductive outcomes, and general well-being.	1962-1980	Study results did not support the hypothesis of a causal relationship between potable reuse and cancer, diseases, or mortality. No dose-response relationship between reclaimed water and disease could be deduced	Frerichs 1983

Study	Brief Project Description	Epidemiological Study Description	Reporting Period	Primary Conclusion	Reference
IPR Montebello Forebay Project – LA County, CA, Study No.2 (The Rand Study)		Examined mortality, morbidity, infectious diseases such as <i>Giardia</i> , Hepatitis A, <i>Salmonella</i> , and <i>Shigella</i> , and cancer incidence using census tracts for two recycled water areas (high and low concentration) and two control areas.	1987-1991	Study results did not determine a causal relationship between potable reuse and cancer, diseases, or mortality.	Sloss et al. 1996
IPR Montebello Forebay Project – LA County, CA, Study No.3 (The Second Rand Study)		Examined adverse birth outcomes such as prenatal development and infant mortality (low birth weight, birth defects, nervous system defects, etc.)	1982-1993	Study found that rates of adverse births were equivalent between the reclaimed water users and a control group.	Sloss et al. 1999
Health status of residents of an urban dual reticulation system – Sydney, Australia	Households in dual reticulation developments receive water from the Rouse Hill Recycled Water Scheme in Sydney, Australia for non-potable purposes, such as filling swimming pools. Residents in neighboring suburbs receive conventionally treated potable water.	Primary-care consultation rates were examined for both communities. Five conditions were tested including: Gastroenteritis, respiratory complaints, dermal complaints, urinary tract infections and musculoskeletal complaints.	2005-2006	No increased rates of health issues as a result of reclaimed water exposure. There was little variation in consultation rates was noted between residents of using reclaimed and conventional water supply alternatives.	Sinclair et al. 2010
DPR Goreangab Plant-Windhoek, Namibia	First direct potable reuse project in the world. Treatment at the time of the study included sand filtration and granular activated carbon. Water was then distributed in the drinking water pipeline network.	Analyzed > 15,000 cases of diarrheal disease in surrounding area. Residents receiving conventional water were compared to those receiving recycled water.	1976-1983	Found that diarrheal disease in Caucasians drinking reclaimed water was marginally lower than Caucasians drinking conventional water supply. Incidence rates greatly	Isaacson and Sayed, 1988; Odendaal, 1991

Study	Brief Project Description	Epidemiological Study Description	Reporting Period	Primary Conclusion	Reference
				increased in blacks and colors, all of whom received the conventional water supply.	
Total Resource Recovery Project, City of San Diego	San Diego investigated a proposed surface water augmentation scheme utilizing advanced treatment and discharge into the Miramar Reservoir (source of drinking water supply at the time).	Telephone interviews were conducted on 1,100 women regarding adverse birth outcomes, infectious diseases, and mortality. Additionally, four bioassays were used to evaluate genetic toxicity and carcinogenic effects between the Miramar Reservoir (reclaimed water) and the city's raw water supply.	1988-1990	Study concluded, based on short-term bioassay results, that reclaimed water did not display more genotoxic or mutagenic tendencies than the raw water supply.	Cooper et al. 1992 and 1997; NRC 1998
The Chanute Kansas Emergency Direct Potable Reuse Project	Chanute, Kansas experienced a drought between 1956 and 1957 requiring the implementation of an indirect reuse scheme involving a dam on the Neosho River below the WWTP. The dam was subsequently washed out when the area experienced heavy precipitation. Before the dam was implemented, a portion of intake to the drinking water plant was municipal wastewater.	An epidemiology study was completed investigating the instances of stomach and intestinal illness during the period in which the Neosho River was dammed.	150 days during 1956-1957	The study concluded that fewer instances of stomach and intestinal illness were reported when recycled water was being consumed vs. instances reported during the following winter when the conventional water supply was being utilized.	Metzler et al. 1958
Denver Potable Water Reuse	Denver implemented a demonstration	A bio-analytical epidemiological study was completed	1990-1994	No treatment related effects were	Lauer et al. 1994 and

Study	Brief Project Description	Epidemiological Study Description	Reporting Period	Primary Conclusion	Reference
Demonstration Project	potable reuse project in order to evaluate the viability of potable reuse.	investigating the relative health impacts of highly treated reclaimed water derived from secondary wastewater compared to Denver's drinking water supply. Chronic toxicity and oncogenicity in rats and mice was measured using <i>in vivo</i> methods for 150 to 500 organic residue concentrates.		observed during this study	1996; NRC 1998
Tampa Water Resource Recovery Project	This planned but not implemented potable reuse project involved augmentation of the Hillsborough River raw water supply using advanced treated effluent from a granular activated carbon and ozone disinfection treatment train.	The epidemiology study evaluated approximately 1,000 x organic concentrates used in Ames Salmonella, micronucleus, and sister chromatid exchange experiments in three dose levels. In vivo testing comprised mouse skin initiation, strain A mouse lung adenoma, 90-day subchronic assay on mice and rats. A reproductive study on mice was also completed.	1987-1992	There was no mutagenic activity detected in any of the samples. All tests completed showed negative results, excluding some fetal toxicity exhibited in rats, but not mice, for the AWT sample.	CH2M Hill 1993, Pereira et al. No Date; NRC 1998
Toxicological Relevance of EDCs and Pharmaceuticals in Drinking Water – Water Research Foundation Project 3085	Water samples were studied from 20 drinking water facilities, four wastewater plants (raw and reuse water), and food products. 62 target compounds (EDCs and pharmaceuticals) were investigated.	In vitro cellular bioassay (E-screen) was used with a method reporting limit of 0.16 nanograms per liter (ng/L), expressed as estradiol equivalents (EEq).	2007	Of 62 compounds studied, only three were consistently detected in drinking waters of the US (Atrazine, meprobamate, phenytoin). Only 11 compounds were found in greater than 20% of drinking waters. Out of food products, raw wastewater,	Snyder et al. 2008

Study	Brief Project Description	Epidemiological Study Description	Reporting Period	Primary Conclusion	Reference
				recycled water, and finished drinking water, finished drinking water had the lowest levels of estrogenicity.	
Potomac Estuary Experimental Wastewater Treatment Plant	Potomac Estuary Experimental Water Treatment Plant (EEWTP) receives a 50-50 blended mix of estuary water and nitrified secondary effluent from the Blue Plains Wastewater Treatment Plant which treats wastewater from Washington D.C. EEWTP provides treatment in the form of aeration, coagulation, flocculation, sedimentation, predisinfection, filtration, carbon adsorption, and postdisinfection.	This bioanalytical study included short-term in vitro tests on both EEWTPs influent and effluent, as well as effluent from three drinking water treatment plants in the vicinity. Tests completed included the Ames Salmonella/ microsome test and a mammalian cell transformation test.	1980-1982	Toxicological parameters investigated showed that EEWTP effluent was comparable to product water from the local drinking water treatment plants.	Montgomery, 1983; NRC 1998
Singapore NEWater Potable Reuse	The majority of Singapore's NEWater is currently used for industrial and commercial use, however some is blended with raw water in reservoirs, which is then treated using MF/RO/UV and distributed as drinking water.	Study included a 12-month period of testing on Japanese Medaka fish (<i>Oryzias latipes</i>) comparing advanced treated effluent (NEWater) and untreated	2001-2003	This study was completed twice due to poor experimental design; however, both rounds found no indication of estrogenic or carcinogenic effects in advanced treated effluent.	Khan and Roser, 2007
Santa Ana River Water Quality Monitoring Study	This study included a <i>de facto</i> indirect potable	This bioanalytical study included three rounds of testing on	2004-2005	The three rounds of testing did not yield statistically	Woodside, 2004

Study	Brief Project Description	Epidemiological Study Description	Reporting Period	Primary Conclusion	Reference
	reuse scheme originating from an Orange County Water District (OCWD) diversion directing Santa Ana River water to the Orange County groundwater basin for recharge. The majority of flow for recharge is tertiary-treated product water.	Japanese Medaka fish comparing shallow groundwater adjacent to the Santa Ana River and control water. The study analyzed fish for tissue pathology, vitellogenin induction, reproduction, limited tissue pathology, and gross morphology.		significant differences between fish & the shallow groundwater adjacent to the river and fish & the control water.	
Soil Aquifer Treatment (SAT) Investigation	Water from multiple wastewater treatment plants, product water from soil-aquifer treatment, and stormwater were assessed to evaluate estrogenic activity using in vitro bioassay methods.	<i>In vitro</i> methods used included: - Estrogen binding assay - Glucocorticoid receptor competitive binding assay - Yeast-based reporter gene assay - MCF-7 cell proliferation assay - <i>in vivo</i> fish vitellogenin synthesis assay - Enzyme-linked immunosorbent assays (ELISAs) - GC/MS		WWTPs with the longest retention times generally had the lowest detected levels of estrogenicity. Estrogenicity was effectively removed during SAT.	Fox, Houston et al. 2006

12.2 Future Research

Epidemiological information can inform health risks potentially associated with potable reuse. The existing epidemiological literature on potable water reuse is one potential source of information to support the assessment of health risks. Additional information and data from risk assessments (see **Chapter 5**) and monitoring are needed to characterize possible adverse health outcomes.

While there are numerous limitations to conducting and interpreting available epidemiological data, several approaches could make better use of future epidemiological opportunities:

- Selecting large test and control populations.
- Identifying, where possible, target endpoints that have low incidence and/or variability in control populations.

- Using control and test populations that are as similar as possible controlling for confounders as appropriate.
- Incorporating measures of exposure as part of study designs.

As drought conditions persist in certain U.S. regions, there is a growing interest in potable reuse, along with a need for more information about the potential impact of the practices. Waterborne disease outbreaks occasionally occur in conventional water supplies; but, this reporting relies on passive surveillance (e.g., self-reporting by states to the Centers for Disease Control), which is relatively insensitive and often inadequate for detecting less than population-level effects. Subtle and background effects, as well as chronic or sub-chronic effects (e.g., reproduction and developmental effects), are more difficult to attribute to a water supply. This is an important area for additional research in the United States going forward.

Water Environment and Reuse Foundation released a white paper titled *Feasibility of Establishing a Framework for Public Health Monitoring*, which was last updated in 2017. The white paper discusses a potential framework approach to evaluate DPR using public health surveillance (WE&RF, 2017a).

Additionally, in lieu of epidemiology studies, many scientists are using microbial risk assessment approaches to understand health risks associated with a given potable reuse treatment scheme (Amoueyan et al. 2017; Chaundry et al., 2017; Lim et al., 2017; Pecson et al., 2017; Soller et al., 2017; Soller et al., 2018). Quantitative microbial risk assessment (QMRA) approaches, specifically those using probabilistic models and inputs, can provide more nuanced information about how consistently public health benchmarks are achieved, as compared to the traditional log credit allocations and epidemiology studies.

CHAPTER 13

Public Acceptance

The topic of direct potable water reuse can be viewed as a controversial, yet beneficial, strategy for reducing demand on stressed freshwater supplies. Americans tend to be less aware of where their water comes from than citizens in some countries. In 2012, GE Power and Water conducted an online survey with 1,000 respondents each from the United States, China, and Singapore; 31 percent of Americans did not know where their water came from, compared to 10 percent in China and Singapore (GE, 2012).

Public outreach can allow the public to access accurate and sufficient information for effective participation in managing human health and environmental risks. As in all water supply projects, public acceptance is a crucial step in the planning of potable reuse schemes. An uninformed public may become a major obstacle to direct potable reuse (DPR), regardless of its technical feasibility or safety.

There are many ways to enhance public involvement. One way to begin is with the identification of key stakeholders that the project will impact; a two-way communication effort between stakeholders and project leaders should occur early in the planning process to facilitate education, input, and trust between entities. Water management issues often require public involvement because water management decision-making directly impacts the community (EPA, 2012a) as they are usually the prime consumers. Provided below is a discussion of public acceptance regarding water reuse in the United States, as well as an evaluation of public relations principals and behaviors that have historically lent themselves to beneficial public acceptance results.

13.1 Current State of Public Acceptance

13.1.1 Public Awareness and Opinion

The previously mentioned GE survey showed a high level of support among Americans for water reuse and a willingness to pay a bit more to ensure future clean water. The study found that the vast majority of American respondents (80 percent) strongly support non-potable reuse, and just over half (51 percent) agree that recycled water is drinkable; but, only 30 percent of those surveyed favor drinking it (GE, 2012).

In Australia, when asked why DPR might be less attractive or more difficult to implement than indirect potable reuse (IPR), respondents indicated that public acceptance was a main obstacle and mentioned specific barriers (Khan, 2013):

- DPR lacks “community acceptance and/or wider public acceptance.”
- The “yuck factor.”
- Lack of “public confidence in the safety of advanced treatment technologies” and the abilities of the operators.
- “Non-equal distribution of recycled water.”

13.1.2 Shifting Opinions with Public Outreach and Changing Conditions

Water scarcity is one issue that is forcing parts of the United States to visit, or revisit, water reuse from both a technological and public opinion standpoint, potentially including the use of advanced treated recycled water to augment drinking water supplies.

The types of steps and tools effective at building trust and ultimately shifting public opinion are briefly listed in **Section 13.2** and summarized in the *Framework for Direct Potable Reuse* Chapter 12 (NWRRI, 2015). Multiple communities invested in these types of tools:

- Santa Clara Valley Water District (California) holds public tours of the Silicon Valley Advanced Water Purification Center and has other forms of outreach, including a website.
- Pure Water San Diego (California) ran a demonstration project with public tours and hosts a website.
- Orange County Groundwater Replenishment System (California) offers public tours and a website.
- Los Angeles Groundwater Replenishment Project (California).
- Wichita Falls DPR Project (Texas) – see **Appendix A**.

13.2 Important Factors in Stakeholder Engagement for Potable Reuse

Research shows that it is important to start outreach efforts early, set goals, engage the media, use consistent terminology, avoid the use of jargon, and confront misinformation as soon as it is encountered (WRRF, 2015b; AWWA/WEF, 2008).

Involving stakeholders from the beginning can be critical for effective policy decisions. There are trust-building strategies for water utilities tackling potable reuse public engagement processes (AWWA/WEF, 2008):

- Gaining the support of stakeholders in the project, including customers, the public overall, and policy makers, through persistent communication.
- Highlighting the overall water supply concerns and emphasizing the importance of water reliability.
- Creating confidence in the quality of the reclaimed water.
- Confronting conflict head-on.

There are a series of core steps and behaviors that, when used together, have proven to be successful in engaging the public on water reuse and potable reuse projects:

- **Situational Analysis: Assess the community (i.e. identify the “public”) and the utility itself. Define the problem the community needs to solve.**

The “general public” is hard to define, as people belong to many geographic, socio-economic, gender, age groups, political affiliations, social orientations, and recreation interests. When identifying the “public,” it is important to be overarching and diverse, including representatives from different ethnic, demographic, geographic, cultural, professional, and political backgrounds. Outreach to organized groups is just as essential as outreach to individuals. Outreach must clearly articulate the problem that the community faces (or, phrased in a positive spin, the opportunity for community improvement) to foster understanding and support.

- **Determine the desired/required level of public involvement and identify potential stakeholders.**

There needs to be a complete list of stakeholders before a project plan is in place to establish early adopters that other stakeholders can turn to for questions or concerns.

- **Develop and follow a broad and tactical communication plan (EPA, 2012a).**

There is no “one-size-fits-all” model for public involvement plans because the most effective approach will be the result of specific context and project analysis. Consider consistent and clear messaging, avoid technical jargon, take note that vocabulary words and structure count, and emphasize “purity” of reuse water. In public acceptance endeavors, it is important to ensure that the water industry itself is communicating consistent, effective, and well-received vocabulary words and water reuse messages to the general public.

- **Gauge the community and utility perspectives; evaluate trusted information sources and potential participation pathways.**

Trusted information sources vary significantly amongst communities and states. It is a good idea to perform a public opinion survey in each community considering a water reuse project.

- **Meet and discuss with community officials and leaders early in the planning process, and regularly throughout the project lifetime.**

Addressing community viewpoints and concerns can increase support for a given project, both from an opinion and monetary aspect. Policy makers can correctly answer stakeholder’s questions if they are well-informed about the project.

- **Request the participation of outside experts as spokespeople or evaluators, but voice that the utility should be the primary source of credible information.**

An advisory group with representatives from multiple community perspectives can be helpful, and the group should be aware of their expected contribution and role within the project’s decision-making process.

- **Explore the media, social media, and informational channels.**

The power of the media in today’s society can both help and hinder the implementation of potable reuse projects. Therefore, project leaders trying to promote acceptance should engage with the media to facilitate accurate and science-based DPR fact reporting. Strong opponents of DPR, as well as the media, tend to use attention-gaining phrases that magnify public fear, such as “toilet-to-tap,” perpetuating the idea that consumers are drinking wastewater rather than treated reclaimed water. However, the media can widely and effectively distribute fact-based information once they receive the correct information. For example, in 2011, USA Today ran a story regarding the DPR operation in Big Spring, Texas, and in 2012, the New York Times featured a front-page story titled “As ‘Yuck Factor’ Subsides, Treated Wastewater Flows from Taps.”

Social media enables a direct form of contact with stakeholder groups that can be very effective and beneficial. However, committing to the use of social media through the project lifetime requires dedication, time, and resources. Failing to maintain a social media presence could be detrimental to the project.

- **Involve employees and ensure they are knowledgeable on the most up-to-date information.**

Employees working for the utility or organization leading the project effort often receive questions or concerns relating to project material or ideas. If employees are well-versed on the subject matter, they will be able to convey a flow of factual information to the public.

- **Create a dialogue with the wider community of stakeholders, listen to opposition, and be timely with responses.**

DPR projects typically have opposition due to fears of public health impacts, especially on children. Involving opponents of the project in initial public involvement groups can ease concerns

from the rest of the opposing public and can bring up issues early in the process that may be overlooked otherwise (EPA, 2012a).

The WateReuse Research Foundation (WRRF) (now the Water Environment and Reuse Foundation (WE&RF)) has published communication frameworks that may facilitate state and local outreach. For further information about one possible communication framework, please see *Model Public Communication Plans for Increasing Awareness and Fostering Acceptance of Direct Potable Reuse*. This document includes examples for suggestions of how to phrase messages to induce a positive connotation with potable reuse water, among other things (WRRF, 2015b).

CHAPTER 14

Research

14.1 Current Highlighted Research

The field of potable reuse has advanced significantly over the past several years, with several foundations, researchers, and utilities contributing to groundbreaking research. In 2011, *Direct Potable Reuse: A Path Forward* laid out numerous relevant research needs and existing knowledge gaps (WRRF, 2011a). The following year, *Water Reuse: Potential for Expanding the Nation's Water Supply Through Reuse of Municipal Wastewater* identified direct potable reuse (DPR) research topics (NRC, 2012a). Several entities have committed to and launched significant research programs dedicated to potable reuse since 2012, as described below.

14.1.1 EPA

EPA has several ongoing projects related to potable reuse. First, EPA is researching municipal wastewater treatment plant (WWTP) performance in removing pathogens, microbial indicators, and trace chemical constituents. This research aims to characterize the removal of these constituents upstream of an advanced wastewater treatment facility (AWTF) for potable reuse.

Secondly, EPA is evaluating recreational water quality criteria (RWQC) for coliphage – a viral indicator. As part of this effort EPA has published a literature review (EPA, 2015a); held the 2016 Coliphage Experts Workshop; and published a peer-reviewed Proceedings of the Coliphage Expert Workshop (EPA, 2017v). EPA is currently working on the derivation of the coliphage-based RWQC, which involves a risk assessment approach. Coliphage-based RWQC can help improve ambient source water quality for drinking waters. Additionally, coliphage monitoring may also be used for characterizing source water for AWTFs for potable reuse. For example, North Carolina reuse legislation has proposed coliphage be assessed in reclaimed waters (see **Chapter 3** for relevant North Carolina law).

Additionally, EPA researchers and partners systematically collected and published data on viruses in raw wastewater and conducted quantitative microbial risk assessment (QMRA) using distributions of viruses and other reference pathogens found in raw wastewater to assess risk differences associated with various DPR treatment trains (Eftim et al., 2017; Soller et al., 2017; Soller et al., 2018). QMRA methodology is adaptable to other DPR treatment trains and can incorporate additional data as it becomes available. Soller et al. (2018) included a sensitivity analysis of the aforementioned QMRA work using updated dose-response models (Messner et al., 2014; Messner and Berger, 2016; Teunis et al., 2008; Soller et al., 2017) and evaluated the QMRA methodology against the log-credit approach currently applied in several states.

Collectively, this work will be useful to multiple groups: federal and state regulators considering DPR for drinking water, state and local decision-makers considering whether to permit a particular DPR project, and design engineers considering which unit treatment processes to employ for particular projects.

14.1.2 Water Environment & Reuse Foundation (WE&RF)

In 2016, the Water Environment Research Foundation (WERF) merged with the WaterReuse Foundation (WRRF) and became the WE&RF.

The California DPR Initiative began in June 2012 through WE&RF (then WRRF) and WaterReuse California to address the feasibility of developing criteria for DPR (per CA Senate Bill 918). The December 2012 DPR

Research Needs meeting forged the framework of WRRF's DPR research agenda. From 2012-2016, WRRF allocated \$6 million to fund over 30 DPR research projects. When combined with funding from partners, this DPR research portfolio addressing DPR's regulatory, utility, and community barriers is \$24 million.

In total, there are 34 WE&RF supported DPR projects completed or underway (**Table 14-1**). The research listed in **Table 14-1** aims to facilitate the implementation of DPR in a safe, economical, and socially acceptable manner (**Figure 14-1**). The research under this initiative is summarized in a single document *Potable Reuse Research Compilation: Synthesis of Findings* (WE&RF, 2016b). Dozens of technical expert authors synthesized the 34 DPR projects into 9 chapters by topic: Source Control, Evaluation of Potential Direct Potable Reuse Treatment Trains, Pathogens (Surrogates and Credits), Pathogens (Rapid Continuous Monitoring), Risks and Removal of Constituents of Emerging Concern, Critical Control Points, Operation and Maintenance and Operator Training and Certification, Failure and Resiliency, and Demonstration of Reliable, Redundant Treatment Performance.

WE&RF is continuing research to advance potable reuse. They are leveraging a \$4.5M grant from the state of California to address research needs and gaps across the country (WE&RF, 2017b).

14.1.3 Water Research Foundation (WRF)

In addition to WE&RF research, **Table 14-1** also summarizes the WRF's published and ongoing potable reuse research projects. Notably, along with other partners including the National Research Council (NRC), WRF supported two seminal studies – the *Augmenting Potable Water Supplies with Reclaimed Water* project which resulted in *Issues in Potable Reuse: The Viability of Augmenting Drinking Water Supplies With Reclaimed Water* (NRC, 1998), and the *Assessment of Water Reuse as an Approach for Meeting Future Water Supply Needs* project that resulted in *Water Reuse: Potential for Expanding the Nation's Water Supply Through Reuse of Municipal Wastewater* (NRC, 2012a). Currently, WRF research includes DPR as part of a comprehensive (One Water) approach to water supply planning. In 2014, WRF launched a research program titled "Integrated Water Management: Planning for Future Water Supplies" with the aim of developing data, tools, and knowledge to support integrated, resilient, and reliable water supply diversification by 2019. In addition, WRF supported a significant research portfolio specifically dedicated to biofiltration, a technology showing promise for DPR applications (**Table 14-2**).

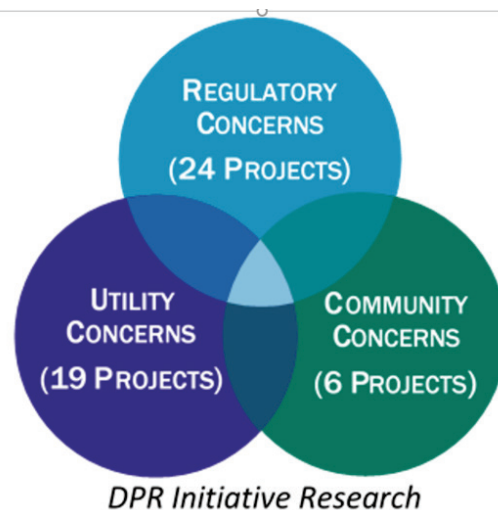

Figure 14-1. Barriers to potable reuse research (WRRF figure used with permission)

Together, these research efforts hold promise for continuing to advance the use of DPR and indirect potable reuse (IPR) projects for providing a safe and reliable source of drinking water for communities across the United States.

Table 14-1. DPR and related research projects

Project Title	Project Number(s)	Organization(s)	Publication Date	Research Focus		
				Regulatory Concerns	Utility Concerns	Community Concerns
Augmenting Potable Water Supplies with Reclaimed Water	WRF 371	WRF, NRC	1998	X	X	
Issues with Potable Reuse: The Viability of Augmenting Drinking Water Supplies with Reclaimed Water	-	AWWA	1998	X	X	
Soil Treatability Pilot Studies to Design and Model Soil Aquifer Treatment Systems	WRF 901	WRF	1998		X	
Protocol for Designing and Conducting UV Disinfection Studies	WRF 2674	WRF, NWRI	2001	X	X	
Water Reuse: Understanding Public Perception and Participation	00-PUM-1	WERF	2003			X
Water Quality Requirements for Reclaimed Water	WRF 2697	WRF, AECOM	2004	X	X	X
Framework for Developing Water Reuse Criteria with Reference to Drinking Water Supplies	WRF 2968	WRF, WRRF, UKWIR	2005	X		
Organic Nitrogen in Drinking Water and Reclaimed Wastewater	WRF 2900	WRF	2006		X	

Project Title	Project Number(s)	Organization(s)	Publication Date	Research Focus		
				Regulatory Concerns	Utility Concerns	Community Concerns
Understanding Public Concerns and Developing Tools to Assist Local Officials in Planning Successful Potable Reuse Projects	WRF 2919	WRF, WRRF	2006			X
Removal of EDCs and Pharmaceuticals in Drinking and Reuse Treatment Processes	WRF 2758	WRF	2007		X	
Comparing Nanofiltration and Reverse Osmosis for Treating Recycled Water	WRF 3012	WRF	2008		X	
Fate of Pharmaceuticals and Personal Care Products through Wastewater Treatment Processes	03-CTS-22-UR	WERF	2008		X	
Microbial Risk Assessment Interface Tool and User Documentation Guide	04-HHE-3	WERF	2008	X	X	
Using Reclaimed Water to Augment Potable Water Resources	-	WERF	2008	X		
Contributions of Household Chemicals to Sewage and their Relevance to Municipal Wastewater Systems and the Environment	03-CTS-21-UR	WERF	2009		X	

Project Title	Project Number(s)	Organization(s)	Publication Date	Research Focus		
				Regulatory Concerns	Utility Concerns	Community Concerns
Development of Indicators and Surrogates for Chemical Contaminant Removal during Wastewater Treatment and Reclamation	04-HHE-1CO	WERF	2009	X	X	
Minimizing Water Treatment Residual Discharges to Surface Water	WRF 4086	WRF	2010		X	
Optimizing Filtration and Disinfection Systems with a Risk-Based Approach	04-HHE-5	WERF	2010		X	
Regulatory Aspects of Direct Potable Reuse in California	-	NWRI	2010	X		
Direct Potable Reuse: A Path Forward	-	WRRF	2011	X	X	
Enhanced Reverse Osmosis Systems: Immediate Treatment to Improve Recovery	WRF 4061	WRF	2011		X	
Assessment of Water Reuse as an Approach for Meeting Future Water Supply Needs	WRF 4276	WRF, NRC, and other organizations	2012	X	X	
Challenge Projects on Low Energy Treatment Schemes for Water Reuse: Phase 1	WERF5T10a	WERF	2012		X	
Demonstrating Advanced Oxidation with Biodegradation for Removal of Carbamazepine	INFR3SG09	WERF	2012		X	

Project Title	Project Number(s)	Organization(s)	Publication Date	Research Focus		
				Regulatory Concerns	Utility Concerns	Community Concerns
Demonstration of Membrane Zero Liquid Discharge for Drinking Water System: Literature Review	06-CTS-1CO	WERF	2012		X	
Direct Potable Reuse: Benefits for Public Water Supplies, Agriculture, the Environment, and Energy Conservation	-	NWRI	2012	X	X	
The Effect of Prior Knowledge of 'Unplanned' Potable Reuse on Acceptance of 'Planned' Potable Reuse	WRRF-09-01	WRRF	2012			X
Research Strategy for Water Reuse Workshop	WRF 3145	WRF	2012		X	
Treatment Processes for Removal of Emerging Contaminants	INFR6SG09	WERF	2012		X	
Challenge Projects on Low Energy Treatment Schemes for Water Reuse: Phase 1	ENER2C12b	WERF	2013		X	
Challenge Projects on Low Energy Treatment Schemes for Water Reuse: Phase 1	ENER2C12c	WERF	2013		X	
Challenge Projects on Low Energy Treatment Schemes for Water Reuse: Phase 1	ENER2C12d	WERF	2013		X	
Evaluation of Risk Reduction Principles for Direct Potable Reuse	WRRF-11-10	WRRF	2013	X	X	

Project Title	Project Number(s)	Organization(s)	Publication Date	Research Focus		
				Regulatory Concerns	Utility Concerns	Community Concerns
Pilot Testing of Membrane Zero Liquid Discharge for Drinking Water Systems	ENER2C12a	WERF	2013		X	
Demonstrating the Benefits of Engineered Direct versus Unintended Indirect Potable Reuse Systems	WRRF-11-05	WRRF	2014	X	X	
Desalination Concentrate Management Policy Analysis for the Arid West	WERF5T10	WERF	2014	X	X	
Economics of DPR	WRRF-14-08	WRRF	2014	X	X	
Protocol for Evaluating Chemical Pretreatment for High Pressure Membranes	WRF 4249	WRF	2014		X	
Colorado Direct Potable Reuse White Paper – An Overview	WERF5C11	WERF	2015	X	X	
Considering the Implementation of Direct Potable Reuse in Colorado	WERF5T10b	WERF	2015	X	X	
Developing Direct Potable Reuse Guidelines	WRA-14-01	WRA	2015	X	X	
Institutional Issues for One Water Management	WRF 4487	WRF	2015	X	X	
Integrated Water Management: Planning for Future Water Supplies	WRF 4550	WRF	2015		X	

Project Title	Project Number(s)	Organization(s)	Publication Date	Research Focus		
				Regulatory Concerns	Utility Concerns	Community Concerns
Model Public Communication Plans for Increasing Awareness and Fostering Acceptance of Direct Potable Reuse	WRRF-13-02, WRF 4540	WRRF, WRF	2015			X
Advanced Oxidation of Pharmaceuticals and Personal Care Products: Preparing for Indirect and Direct Water Reuse	WRF 4213	WRF	2016		X	
Colorado Direct Potable Reuse Study	-	WaterReuse Colorado, Colorado Water Conservation Board (CWCB) Water Supply Reserve Account Grant Program	2016	X	X	
Creating a Roadmap for Bioassay Implementation in Reuse Waters: A cross disciplinary workshop	WE&RF-15-02	WE&RF	2016	X	X	
Critical Control Point Assessment to Quantify Robustness and Reliability of Multiple Treatment Barriers of DPR Scheme	WE&RF-13-03, WRF 4541	WE&RF, WRF	2016	X	X	

Project Title	Project Number(s)	Organization(s)	Publication Date	Research Focus		
				Regulatory Concerns	Utility Concerns	Community Concerns
Development of Operation and Maintenance Plan and Training and Certification Framework for Direct Potable Reuse (DPR) Systems	WE&RF-13-13	WE&RF	2016	X	X	
Direct Potable Reuse (DPR): Comparing relative human health risk of indirect potable reuse (IPR) and DPR	-	WEF, WE&RF, and CDM Smith	2016	X	X	X
DPR Research Compilation: Synthesis of Findings from DPR Initiative Projects	WE&RF-15-01	WE&RF	2016	X	X	X
Enhanced Pathogen and Pollutant Monitoring of the Colorado River Municipal Water District Raw Water Production Facility at Big Spring Texas	WE&RF-14-10	WE&RF	2016		X	
Ensuring stable microbial water quality in Direct Potable Reuse distribution systems (workshop)	WE&RF-14-18	WE&RF	2016	X	X	
Equivalency of Advanced Treatment Trains for Potable Reuse (3 publications)	WRRF-11-02	WRRF	2016	X	X	
Evaluation of Source Water Control Options and the Impact of Selected Strategies on DPR	WE&RF-13-12	WE&RF	2016	X	X	

Project Title	Project Number(s)	Organization(s)	Publication Date	Research Focus		
				Regulatory Concerns	Utility Concerns	Community Concerns
Guidelines for Engineered Storage for Direct Potable Reuse	WE&RF-12-06	WE&RF	2016	X	X	
Monitoring for Reliability and Process Control of Potable Reuse Applications	WE&RF-11-01	WE&RF	2016	X	X	
Methods for Integrity Testing of NF and RO Membranes	WE&RF-12-07	WE&RF	2016	X	X	
Using Greywater and Stormwater to Enhance Local Water Supplies: An Assessment of Risks, Costs, and Benefits	WRF 4521	WRF	2016	X	X	
Soil Aquifer Treatment Characterization with Soil Columns for Groundwater Recharge in the San Fernando Valley	WRF 4600	WRF	2017	X	X	
Blending Requirements for Water from Direct Potable Reuse Treatment Facilities	WE&RF-13-15, WRF 4536	WRF, WE&RF	2017 (anticipated)	X	X	
Demonstrating Redundancy and Monitoring to Achieve Reliable Potable Reuse	WE&RF-14-12	WE&RF	2017 (anticipated)	X	X	X
Develop Methodology of Comprehensive (fiscal/triple bottom line) Analysis of Alternative Water Supply Projects Compared to DPR	WE&RF-14-03	WE&RF	2017 (anticipated)		X	

Project Title	Project Number(s)	Organization(s)	Publication Date	Research Focus		
				Regulatory Concerns	Utility Concerns	Community Concerns
Enhanced Removal of Nutrients from Urban Runoff with Novel Unit-Process Capture, Treatment, and Recharge Systems	WRF 4567	WRF	2017 (anticipated)		X	
Establishing Additional Log Reduction Credits for WWTPs	WE&RF-14-02	WE&RF	2017 (anticipated)	X	X	
Anticipating Trade-offs of Using Alternative Water Supplies	WRF 4715	WRF	2018 (anticipated)		X	X
Assessment of Techniques to Evaluate and Demonstrate the Safety of Water from DPR Treatment Facilities	WE&RF-13-14, WRF 4508	WRF, WE&RF	2018 (anticipated)	X	X	
Blending Requirements for Water from DPR Treatment Facilities	WRF 4536	WRF	2018 (anticipated)		X	
Conventional Drinking Water Treatment of Alternative Water Sources: Source Water Requirements	WRF 4665	WRF	2018 (anticipated)		X	
Framework for Evaluating Alternative Water Supplies	WRF 4615	WRF	2018 (anticipated)		X	
Integrating Land Use and Water Resources: Planning to Support Water Supply Diversification	WRF 4263	WRF	2018 (anticipated)		X	

Project Title	Project Number(s)	Organization(s)	Publication Date	Research Focus		
				Regulatory Concerns	Utility Concerns	Community Concerns
Building-Scale Treatment for Direct Potable Water Reuse & Intelligent Control for Real Time Performance Monitoring	WRF 4691	WRF	2019 (anticipated)		X	
Challenges and Practical Approaches to Water Reuse Pricing	WRF 4662	WRF	2019 (anticipated)		X	
Kinetics Modeling and Experimental Investigation of Chloramine Photolysis in Ultraviolet-driven Advanced Water Treatment	WRF 4699	WRF	2019 (anticipated)		X	
Application of bioanalytical tools to assess biological responses associated with water at DPR facilities	WE&RF-14-15	WE&RF	TBD	X	X	
Building-Scale Treatment for Direct Potable Water Reuse & Intelligent Control for Real Time Performance Monitoring	WRRF-16-02	WE&RF, WRF	TBD	X	X	
Characterization and Treatability of TOC from DPR Processes Compared to Surface Water Supplies	WE&RF-15-04	WE&RF	TBD	X	X	

Project Title	Project Number(s)	Organization(s)	Publication Date	Research Focus		
				Regulatory Concerns	Utility Concerns	Community Concerns
Demonstration of High Quality Drinking Water Production Using Multi-Stage Ozone-Biological Filtration (BAF): A Comparison of DPR with Existing IPR Practice	WE&RF-15-11	WE&RF, Gwinnett County	TBD	X	X	
Developing Curriculum and Content for DPR Operator Training	WE&RF-15-05	WE&RF	TBD	X	X	
Evaluating Post Treatment Challenges for Potable Reuse Applications	WRRF-16-01	WE&RF	TBD		X	
Fate of sulfonamide antibiotics through biological treatment in WRRFs designed to maximize reuse applications	WRRF-16-04	WE&RF	TBD		X	
Framework for Public Health Monitoring: White paper	WE&RF-14-14	WE&RF	TBD	X	X	
From Sewershed to Tap: Resiliency of Treatment Processes for DPR	WE&RF-14-13	WE&RF	TBD	X	X	
Molecular Methods for Measuring Pathogen Viability/Infectivity	WE&RF-15-07	WE&RF	TBD	X	X	
NDMA Precursor Control Strategies for DPR	WE&RF-15-13	WE&RF, Los Angeles Sanitation	TBD		X	

Project Title	Project Number(s)	Organization(s)	Publication Date	Research Focus		
				Regulatory Concerns	Utility Concerns	Community Concerns
Operational, Monitoring, and Response Data from Unit Processes in Full-Scale Water Treatment, IPR, and DPR	WE&RF-14-16	WE&RF	TBD	X	X	
Optimization of ozone-BAC treatment processes for potable reuse applications	WE&RF-15-10	WE&RF, American Water	TBD	X	X	
Predicting RO removal of toxicologically relevant unique organics	WE&RF-14-19	WE&RF	TBD	X	X	
White Paper on the Application of Molecular Methods for Pathogens for Potable Reuse	WE&RF-14-17	WE&RF	TBD	X	X	
Advanced Oxidation of Pharmaceuticals and Personal Care Products: Preparing for Indirect and Direct Water Reuse	-	AWWA	-	X	X	

Table 14-2. WRF biofiltration related research projects (WRF, 2017)

Project Title	Project Number	Publication Date
Microbial Activity on Filter-Adsorbers	WRF 408	1992
Biologically Enhanced Slow Sand Filtration for Removal of Natural Organic Matter	WRF 409	1993
Ozone and Biological Treatment for DBP Control and Biological Stability	WRF 504	1994
Drinking Water Denitrification with Entrapped Microbial Technology	WRF 513	1994
Advances in Taste and Odor Treatment and Control	WRF 629	1995
Removal of Natural Organic Matter in Biofilters	WRF 631	1995

Project Title	Project Number	Publication Date
Design of Biological Processes for Organics Control	WRF 712	1998
Microbial Impact of Biological Filtration	WRF 917	1998
Advanced Oxidation and Biodegradation Processes for the Destruction of TOC and DBP Precursors	WRF 289	1999
Colonization of Biologically Active Filter Media with Pathogens	WRF 263	2000
Optimizing Filtration in Biological Filters	WRF 252	2001
Removal of Bromate and Perchlorate in Conventional Ozone/GAC Systems	WRF 2535	2001
Evaluation of Riverbank Filtration as a Drinking Water Treatment Process	WRF 2622	2001
Innovative Biological Pretreatments for Membrane Filtration	WRF 2570	2003
Application of Bioreactor Systems to Low-Concentration Perchlorate- Contaminated Water	WRF 2577	2004
Cometabolism of Trihalomethanes in Nitrifying Biofilters	WRF 2824	2005
Ozone-Enhanced Biofiltration for Geosmin and MIB Removal	WRF 2775	2005
Subsurface Treatment for Arsenic Removal--Phase I	WRF 3082	2006/2009
Hexavalent Chromium Removal Using Anion Exchange and Reduction with Coagulation and Filtration	WRF 3167	2007
State of Knowledge of Endocrine Disruptors and Pharmaceuticals in Drinking Water	WRF 3033	2008
Biological and Ion Exchange Nitrate Removal Evaluation	WRF 4131	2010
Biological Drinking Water Treatment Perceptions and Actual Experiences in North America	WRF 4129	2010
Biological Nitrate Removal Pretreatment for a Drinking Water Application	WRF 4202	2010
Cost-Effective Regulatory Compliance with GAC Biofilters	WRF 4155	2010
Removal and Fate of EDCs and PPCPs in Bank Filtration Systems	WRF 3136	2010
Treating Algal Toxins Using Oxidation, Adsorption, and Membrane Technologies	WRF 2839	2010
Engineered Biofiltration for Enhanced Hydraulic and Water Treatment Performance	WRF 4215	2011
Fate and Impact of Antibiotics in Slow- Rate Biofiltration Processes	WRF 4135	2012
Occurrence, Impacts, and Removal of Manganese in Biofiltration Processes	WRF 4021	2012

Project Title	Project Number	Publication Date
A Monitoring and Control Toolbox for Biological Filtration	WRF 4231	2013
Minimizing Waste Backwash Water from a Biological Denitrification Treatment System	WRF 4470	2014
Nitrate and Arsenic Removal from Drinking Water with a Fixed-Bed Bioreactor	WRF 4293	2014
Optimizing Engineered Biofiltration	WRF 4346	2014
An Operational Definition of Biostability for Drinking Water	WRF 4312	2015
Control of Pharmaceuticals, Endocrine Disruptors, and Related Compounds in Water	WRF 4162	2015
Development of a Biofiltration Knowledge Base	WRF 4459	2015
Pretreatment of Low Alkalinity Organic- Laden Surface Water Prior to a Coagulation-Ultrafiltration Membrane Process	WRF 4477	2015
Biological Oxidation Filtration for the Removal of Ammonia from Groundwater	WRF 4574	2016
Chemically Enhanced Biological Filtration to Enhance Water Quality and Minimize Costs	WRF 4429	2016
Full-Scale Demonstration of Engineered Biofiltration and Development of a Biofiltration Performance-Tracking Tool	WRF 4525	2016
Optimizing Filter Conditions for Improved Manganese Control During Conversion to Biofiltration	WRF 4448	2016
Pilot Testing Nitrate Treatment Processes with Minimal Brine Waste	WRF 4578	2016
Converting Conventional Filters to Biofilters	WRF 4496	2017 (anticipated)
Impact of Filtration Media Type/Age on Nitrosamines Precursors	WRF 4532	2017 (anticipated)
Impact of Wildfires on Source Water Quality and Implications for Water Treatment and Finished Water Quality	WRF 4525	2017 (anticipated)
Major Sources of Nitrosamine Precursors in Raw Waters	WRF 4591	2017 (anticipated)
Optimizing Biofiltration for Various Source Water Quality	WRF 4555	2017 (anticipated)
Simultaneous Removal of Multiple Chemical Contaminants Using Biofiltration	WRF 4559	2017 (anticipated)
Unintended Consequences of Implementing Nitrosamine Control Strategies	WRF 4491	2017 (anticipated)
Practical Monitoring Tools for the Biological Processes in Biofiltration	WRF 4620	2018 (anticipated)

CHAPTER 15

References

- "Facts on Integrated Water Plan and Harpeth River." *City of Franklin, TN* (City of Franklin). Accessed on September 13, 2017 from <<http://www.franklin-gov.com/government/water-management-department/integrated-water-resources-planning/facts-on-integrated-water-plan-and-harpeth-river>>.
- "Reuse Water System." *City of Raleigh*. Accessed on September 13, 2017 from <<https://www.raleighnc.gov/home/content/PubUtilAdmin/Articles/ReuseWaterSystem.html>>.
- "Water Reuse." *Clayton County Water Authority*. (CCWA). Accessed on September 6, 2017 from <http://www.ccwa.us/water-use>.
- Alan Plummer Associates, Inc. 2010. *Final Report: State of Technology of Water Reuse*. Prepared for the Texas Water Development Board, Austin, TX.
- Amoueyan, E., Ahmad, S., Eisenberg, J.N.S., Pecson, B. and Gerrity, D. (2017) "Quantifying pathogen risks associated with potable reuse: A risk assessment case study for Cryptosporidium." *Water Research*, 119, 252-266.
- Amouha, M.A., G.R.N. Bihendi, B. Hooshiyari. 2011. *Nanofiltration Efficiency in Nitrate Removal from Groundwater: A Semi-Industrial Case Study*. 2nd International Conference on Environmental Engineering and Applications.
- Asano, T., F.L. Burton, H.L. Leverenz, R. Tsuchihashi, G. Tchobanoglous. 2007. *Water Reuse: Issues, Technologies, and Applications*. McGraw-Hill, New York.
- American Water Works Association (AWWA). 2005. *Manual of Water Supply Practices M53: Microfiltration and Ultrafiltration Membranes for Drinking Water*. 1st ed. American Water Works Association. Denver, CO.
- American Water Works Association (AWWA). 2007. *Manual of Water Supply Practices M46: Reverse Osmosis and Nanofiltration*. 2nd ed. American Water Works Association. Denver, CO.
- American Water Works Association (AWWA) and Water Environment Federation (WEF). 2008. *Using reclaimed water to augment potable water resources*, 2nd Ed., Alexandria, VA.
- American Water Works Association (AWWA). 2011a. *Manual of Water Supply Practices M37: Operational Control of Coagulation and Filtration Processes*. 3rd ed. American Water Works Association. Denver, CO.
- American Water Works Association (AWWA). 2011b. *Manual of Water Supply Practices M58: Internal Corrosion Control in Water Distribution Systems*. 1st ed. American Water Works Association. Denver, CO.
- American Water Works Association (AWWA). 2016. *Potable Reuse 101: An innovative and sustainable water supply solution*. Accessed on September 28, 2017 from <https://www.awwa.org/Portals/0/files/resources/water%20knowledge/rc%20reuse/Potable%20Reuse%20101.pdf>.
- AWWA Subcommittee on Periodical Publications of the Membrane Process Committee (AWWA Subcommittee). 2008. *Microfiltration and ultrafiltration membranes for drinking water*. Journal – American Water Works Association. 100(12): 84-97. Accessed on September 28, 2017 from <https://www.awwa.org/publications/journal-awwa/abstract/articleid/16032.aspx>
- Bailey, R. 2013. *The City of San Diego Report to the City Council, March 11, 2013. Report No. 13-27*.
- Bell, K.Y., M.J.M. Wells, K.A. Traexler, M.L. Pellegrin, A. Morse, J. Bandy. 2011. "Emerging Pollutants." *Water Environment Research*, 83(10): 1906–1984.
- Bell, K.Y., J. Bandy, S. Beck, O. Keen, N. Kolankowsky, A.M. Parker, K. Linden. 2012. "Emerging Pollutants – Part II: Treatment." *Water Environment Research*, 84(10): 1909-1940.
- Bell, K.Y., J. Bandy, B.J. Finnegan, O. Keen, M.S. Mauter, A.M. Parker, L.A. Sima, H.A. Stretz. 2013. "Emerging Pollutants – Part II: Treatment." *Water Environment Research*, 85(10): 2022-2071.
- Bell, K.Y., R. Bastian, J.A. Gelmini. 2016a. Conjunctive Use of Water Reuse in Drought. In S. Eslamian & F. Eslamian (eds.) *Handbook of Drought and Water Scarcity: Environmental Impacts and Analysis of Drought and Water Scarcity*. Boca Raton, FL: Taylor & Francis Group.

- Bell, K.Y., A. Antolovich, D. Funk, J. Hooper, J. Minton, L. Schimmoller. 2016b. *Ozone-biologically active filtration – an alternative treatment for potable reuse*. World Water. Spring 2016: 27-30. Accessed on September 28, 2017 from http://www.mwhglobal.com/wp-content/uploads/2016/03/WWRDSpring2016_OzoneBiologicallyActiveFiltration.pdf.
- Bellona, C., J.E. Drewes, P. Xu, and G. Amy. 2004. "Factors affecting the rejection of organic solutes during NF/RO treatment – a literature review." *Water Research*, 38(12): 2795-2809.
- Bellona, C., J.E. Drewes, G. Oelker, J. Luna, G. Filteau, G. Amy. 2008. "Comparing nanofiltration and reverse osmosis for drinking water augmentation." *Journal of the American Water Works Association*, 100(9):102-116.
- Benotti, M. J., R.A. Trenholm, B.J. Vanderford, J.C. Holady, B.D. Stanford, S.A. Snyder. 2009. "Pharmaceuticals and Endocrine Disrupting Compounds in U.S. Drinking Water." *Environmental Science & Technology* 43(3): 597-603.
- Bluefield Research. 2015. *U.S. Municipal Wastewater & Reuse: Market Trends, Opportunities, and Forecasts, 2015 – 2025*. Advanced Water Treatment & Desalination Insight Service, Analyst Presentations, Insight Reports, Knowledge Center. US & Canada Insight Service.
- Bond, R., S. Veerapaneni. 2007. *Zero Liquid Discharge for Inland Desalination*. AWWA Research Foundation (AwwaRF) State of California Energy Commission, City of Phoenix Water Services Department. Phoenix, AZ.
- Bonne, P. A. C., J.A.M.H Hofman, J. P. van der Hoek. 2002. "Long-term Capacity of Biological Activated Carbon Filtration for Organics Removal." *Water Science and Technology: Water Supply*, 2(1):139-146.
- Bouwer, E. J., P. B. Crowe. 1988. "Biological Processes in Drinking Water Treatment." *Journal of the American Water Works Association*, 80(9): 82-93.
- Burr, M., A. K. Camper, R. DeLeon, P. Hacker. 2000. *Colonization of Biologically Active Filter Media with Pathogens*. AwwaRF and AWWA. Denver, CO.
- California Department of Public Health (CDPH). 2014. Retrieved September 28, 2017 from http://www.waterboards.ca.gov/drinking_water/certlic/drinkingwater/documents/lawbook/RWregulations_20140618.pdf.
- California State Water Resources Control Board (CSWRCB). 2014. *Alternative Treatment Technology Report for Recycled Water*. Accessed on September 28, 2017 from https://www.waterboards.ca.gov/drinking_water/certlic/drinkingwater/documents/dwdocuments/Alternative%20Treatment%20Technology%20Report%20for%20RW%2009_2014.pdf
- California State Water Resource Control Board (CSWRCB). 2016. *Investigation on the Feasibility of Developing Uniform Water Recycling Criteria for Direct Potable Reuse*. Accessed on September 28, 2017 from https://www.waterboards.ca.gov/drinking_water/certlic/drinkingwater/documents/rw_dpr_criteria/final_report.pdf.
- California Urban Water Agencies (CUWA), National Water Research Institute (NWRI), WaterReuse California. 2010. *Direct Potable Reuse Workshop: Workshop Report*. Accessed on September 28, 2017 from <http://www.nwri-usa.org/pdfs/DirectPotableWorkshopSummaryFINAL091010.pdf>.
- Carrara, C., C.J. Ptacek, W.D. Robertso, D.W. Blowes, M.C. Moncur, E. Sverko, S. Backus. 2008. "Fate of Pharmaceutical and Trace Organic Compounds in Three Septic System Plumes, Ontario, Canada." *Environmental Science & Technology*, 42(8):2805-2811.
- CDM Smith. 2014. *Technical Memorandum 2 Disinfection Alternatives Evaluation: Basis of Design Development Alternatives Screening and Life Cycle Cost / Non-Economic Factor Evaluation*. Western Lake Superior Sanitary District.
- CH2M Hill. 1993. *Tampa Water Resource Recovery Pilot Project Microbiological Evaluation*. Tampa Water Resource Recovery Project Pilot Studies. Final Report to the City of Tampa. Tampa, Florida.
- Chalmers, R.B., G. Wetterau, D. Brown. 2010. *RO System Design in Advanced Wastewater Treatment Facilities*. WEF Membrane Technology Conference.
- Chalmers, R.B., G. Wetterau, E. You, K. Alexander. 2013. *Increasing the Overall Recovery Rate at the Leo J. Vander Lans Water Treatment Facility to Greater than 92%*. AMTA/AWWA Membrane Technology Conference.
- Chaudhry, R.M., Hamilton, K.A., Haas, C.N. and Nelson, K.L. 2017. "Drivers of Microbial Risk for Direct Potable Reuse and de Facto Reuse Treatment Schemes: The Impacts of Source Water Quality and Blending." *Int J Environ Res Public Health*, 14(6).
- City of Raleigh Public Utilities Department (CORPUD) 2014. *Neuse River Water Quality Sampling Final Report*. Prepared by CDM Smith. Accessed on September 28, 2017 from

<https://www.raleighnc.gov/content/PubUtilAdmin/Documents/EPASurveyDocuments/EPASurveyNeuseRiverWQReportFinal.pdf>.

- Clara, M., B. Strenn, N. Kreuzinger. 2004. "Carbamezapine as a Possible Anthropogenic Marker in the Aquatic Environment: Investigations on the Behavior of Carbamezapine in Wastewater Treatment and During Groundwater Recharge." *Water Research*, 38(4): 947-954.
- Cooper, R.C., Danielson, R. E., Pettegrew, L. A., Fairchild, W. A., Sanchez, L. A. 1992. San Diego Aqua II Pilot Plant Reliability Study, Western Consortium for Public Health.
- Cooper, R.C., A.W. Olivieri, D.M. Eisenberg, J.A. Soller, L.A. Pettegrew, and R.E. Danielson. 1997. *The City of San Diego Total Resource Recovery Project Aqua III San Pasqual Health Effects Study, Final Summary Report*. Prepared by the Western Consortium for Public Health.
- Colorado Water Conservation Board (CWCB). 2015. Colorado's Water Plan.
- Conn, K. E., K.S. Lowe, J.E. Drewes, C. Hoppe-Jones, M.B. Tucholke. 2010. "Occurrence of Pharmaceuticals and Consumer Product Chemicals in Raw Wastewater and Septic Tank Effluent from Single-Family Homes." *Environmental Engineering Science*, 27(4):347-356.
- Cote, P., Z. Alam, J. Penny. 2012. "Hollow fiber membrane life in membrane bioreactors (MBR)." *Desalination*, 288: 145-151.
- Dahl, R. 2014. "Advanced Thinking: Potable Reuse Strategies Gain Traction." *Environmental Health Perspectives*, 22(12): A332-A333. Published online Dec. 1, 2014. doi: [10.1289/ehp.122-A332](https://doi.org/10.1289/ehp.122-A332)
- da Silva, A. K., M.J.M. Wells, A. N. Morse, M.L. Pellegrin, S.M. Miller, J. Peccia, L.C. Sima. 2012. "Emerging Pollutants – Part I: Occurrence, Fate, and Transport." *Water Environment Research*, 84(10): 1878-1908.
- da Silva, A. K., J. Amador, C. Cherchi, S.M. Miller, A.N Morse, M.-L. Pellegrin, and M.J.M Wells. 2013. "Emerging Pollutants – Part I: Occurrence, Fate, and Transport." *Water Environment Research*, 85(10): 1978-2021.
- Daughton, C.G., T.A. Ternes. 1999. "Pharmaceuticals and Personal Care Products in the Environment: Agents of Subtle Change?" *Environmental Health Perspectives*, 107(6): 907-938.
- Desbrow, C., E.J. Routledge, G.C. Brighty, J.P. Sumpter, M. Waldock. 1998. "Identification of Estrogenic Chemicals in STW Effluent. 1. Chemical Fractionation and in Vitro Biological Screening." *Environmental Science & Technology*, 32(11):1549-1558.
- Dickenson, E., J. E. Drewes, S. Snyder, and D. Sedlak. 2008. *Applying Surrogates to Determine the Efficacy of Groundwater Recharge Systems for the Removal of Wastewater Organic Contaminants*. World Environment and Water Resource Congress.
- Dickenson, E.R.V., S.A. Snyder, D.L. Sedlak, J.E. Drewes. 2011. "Indicator Compounds for Assessment of Wastewater Effluent Contributions to Flow and Water Quality." *Water Research*, 45(3):1199-1122.
- Eftim, S., T. Hong, J. Soller, A. Boehm, I. Warren, A. Ichida, S. Nappier. 2017. "Occurrence of norovirus in raw sewage - A systematic literature review and meta-analysis" *Water Research*, (111):366-374.
- El Paso Water. *Advanced Purified Water Treatment*. Accessed on October 6, 2017 from http://www.epwu.org/water/purified_water.html
- Environment Protection and Heritage Council (EPHC), the National Health and Medical Research Council (NHMRC), and the Natural Resource Management Ministerial Council (NRMMC). 2008. *Australian Guidelines for Water Recycling (AGWR): Augmentation of Drinking Water Supplies*. Environment Protection and Heritage Council. Canberra, Australia
- Evans, P. J., E. M. Opitz, P. A. Daniel, C. R. Schulz. 2010. *Biological Drinking Water Treatment Perceptions and Actual Experiences in North America*. Water Research Foundation and Department of Defense.
- Evans, P. J., J. L. Smith, M. LeChevallier, O. D. Schneider, L. A. Weinrich, P. K. Jjemba. 2013. *A Monitoring and Control Toolbox for Biological Filtration*. Water Research Foundation. Denver, CO.
- Feachem, R. G., D. G. Bradley, H. Garelick, D. D. Mara. 1983. *Sanitation and Disease: Health aspects of excreta and wastewater management. World Bank Studies in Water Supply and Sanitation 3*. John Wiley & Sons. Chichester, U.K.
- Federation of Canadian Municipalities (FCM) and National Research Council (NRC). 2003. *Wastewater Source Control: A Best Practice by the National Guide to Sustainable Municipal Infrastructure*. Issue No. 1.

- Fox, P., S. Houston, P. Westerhoff, M. Nellor, W. Yanko, R. Baird, M. Rincon, J. Gully, S. Carr, R. Arnold, K. Lansey, D. Quanrud, W. Ela, G. Amy, M. Reinhard, J.E. Drewes. 2006. *Advances in soil aquifer treatment for sustainable water reuse*. AWWA Research Foundation and American Water Works Association. Denver, CO.
- Frerichs, R. R., E.M. Sloss, E.F. Maes. 1983. *Water Reuse – Its Epidemiological Impact Part III, Los Angeles County, 1979-80*. Regents of the University of California, CA.
- Furlong, E.T., A.L. Batt, S.T. Glassmeyer, M.C. Noriega, D.W. Kolpin, H. Mash, K.M. Schenck. 2017. "Nationwide reconnaissance of contaminants of emerging concern in source and treated drinking waters of the United States: Pharmaceuticals." *Science of the Total Environment*, 579: 1629-1642.
- Garrison, A.W., J.D. Pope, F.R. Allen. 1976. *GC/MS Analysis of Organic Compounds in Domestic Wastewaters*. Chem. Congr. North Am. Cont., Ann Arbor Science.
- GE Osmonics. 2000. *The Filtration Spectrum*. Minnetonka, MN.
- GE Power and Water (GE). 2012. *GE Water Reuse Survey: Executive Summary of U.S. Findings*. Accessed on September 28, 2017 from [https://desalinationbiz.s3.amazonaws.com/documents/GE Water Reuse Survey Executive Summary US Findings .pdf](https://desalinationbiz.s3.amazonaws.com/documents/GE_Water_Reuse_Survey_Executive_Summary_US_Findings.pdf).
- General Electric Power and Water. 2015. *Addressing Water Scarcity Through Recycling and Reuse: A Menu for Policymakers*.
- Gerrity, D., B. Pecson, R.S. Trussell, R.R. Trussell. 2013a. "Potable reuse treatment trains throughout the world." *Journal of Water Supply: Research and Technology*, 62(6): 321-338.
- Gerrity, D., J.C. Holady, D.B. Mawhinney, O. Quinones, R.A. Trenholm, S.A. Snyder. 2013b. "The effects of solids retention time in full-scale activated sludge basins on trace organic contaminant concentrations." *Water Environment Research*, 85(8), 715–724.
- Gerrity, D., E. Owens-Bennett, T. Venezia, B.D. Stanford, M.H. Plumlee, J. Debroux, R.S. Trussell. 2015a. "Applicability of Ozone and Biological Activated Carbon for Potable Reuse." *Ozone: Science and Engineering*, 36(2):123-137.
- Gerrity, D., Pisarenko, A.N., Marti, E., Trenholm, R.A., Gerringer, F., Reungoat, J., Dickenson, E., 2015b. Nitrosamines in pilot-scale and full-scale wastewater treatment plants with ozonation. *Water Res.* 72: 251-261.
- Glassmeyer, S.T., E.T. Furlong, D.W. Kolpin, A.L. Batt, R. Benson, . . . V.S. Wilson. 2017. "Nationwide reconnaissance of contaminants of emerging concern in source and treated drinking waters of the United States." *Science of the Total Environment*, 581-582:909-922.
- Haas, C.N., R.R. Trussell. 1998. "Frameworks for assessing reliability of multiple, independent barriers in potable water reuse." *Water Science & Technology*, 38(6):1-8.
- Heberer, T. 2002. "Occurrence, Fate, and Removal of Pharmaceutical Residues in the Aquatic Environment: A Review of Recent Research Data". *Toxicology Letters*, 131(1-2): 5-17.
- Heufelder, G. 2012. *White Paper: Contaminants of Emerging Concern from Onsite Septic Systems*. Barnstable County Department of Health and Environment. Barnstable, MA.
- Hignite, C., D.L. Azarnoff, 1977. "Drugs and Drug Metabolites as Environmental Contaminants: Chlorophenoxyisobutyrate and Salicylic Acid in Sewage Water Effluent." *Life Sciences*, 20(2):337-341.
- Hinkle, S.R., R.J. Weick, J.M. Johnson, J.D. Cahill, S.G. Smith, B.J. Rich. 2005. *Organic wastewater compounds, pharmaceuticals, and coliphage in ground water receiving discharge from onsite wastewater treatment systems near La Pine, Oregon—Occurrence and implications for transport: U.S. Geological Survey Scientific Investigations Report 2005-5055*.
- Hoeger, S., G. Shaw, B. C. Hitzfeld, D. R. Dietrich. 2004. "Occurrence and Elimination of Cyanobacterial Toxins in Two Australian Drinking Water Treatment Plants." *Toxicon*, 43(6): 639-649.
- Hozalski, R. M., E. J. Bouwer. 2001. "Non-Steady State Simulation of BOM Removal in Drinking Water Biofilters: Model Development." *Water Research*, 35(1): 198-210.
- Huitric, S.J., J. Kuo, M. Creel, C. Tang, D. Snyder, R. Horvath, J. Stahl. 2006. *Reclaimed Water Disinfection Alternatives to Avoid NDMA And THM Formation*. Sanitation Districts of Los Angeles County, Water Environment Federation.

- Isaacson, M., A.R. Sayed. 1988. "Health aspects of the use of recycled water in Windhoek, SWA/Namibia, 1974-1983." *South African Journal of Medicine*, 70: 596-599.
- James, C., R. Copeland, D. Lytle. 2004. *Relationships between oxidation-reduction potential, oxidant, and pH in drinking water*. AWWA Water Quality Technology Conference. Accessed on September 28, 2017 from https://cfpub.epa.gov/si/si_public_record_report.cfm?dirEntryId=125092
- Keen, O., K. Bell, C. Cherchi, B. Finnegan, M. Mauter, A. Parker, J. Rosenblum, H. Stretz. 2014. "Emerging Pollutants – Part II: Treatment." *Water Environment Research*, 86(10): 2036-2096.
- Khan, S, and D. Roser. 2007. *Risk assessment and health effects studies of indirect potable reuse schemes: final report*. University of New South Wales, Centre for Water and Waste Technology.
- Khan, S. 2013. *Drinking Water Through Recycling: The Benefits and Costs of Supplying Direct to the Distribution System*. Report of the Australian Academy of Technological Sciences and Engineering, funded by the Australian Water Recycling Centre of Excellence through the Commonwealth Government's Water for the Future initiative. Accessed on September 28, 2017 from <https://www.atse.org.au/Documents/Publications/Reports/Water/drinking-water-through-recycling-full-report.pdf>.
- King, D.N., M.J. Donohue, S.J. Vesper, E.N. Villegas, M.W. Water, . . . S. Pfaller. 2016. "Microbial pathogens in source and treated waters from drinking water treatment plants in the United States and implications for human health." *Science of the Total Environment*, 562:987-995.
- Kitis, M. 2003. "Disinfection of wastewater with peracetic acid: A review." *Environmental International*. 30: 47-55. Accessed on September 28, 2017 from [https://doi.org/10.1016/S0160-4120\(03\)00147-8](https://doi.org/10.1016/S0160-4120(03)00147-8).
- Kostich, M. S., A.L. Batt, J.M. Lazorchak. 2014. "Concentrations of prioritized pharmaceuticals in effluents from 50 large wastewater treatment plants in the US and implications for risk estimation." *Environmental Pollution*, 184: 354-359.
- Kostich, M.S., R.W. Flick, A.L. Batt, H.E. Mash, J.S. Boone, . . . S.T. Glassmeyer. 2017. "Aquatic concentrations of chemical analytes compared to ecotoxicity estimates." *Science of the Total Environment*, 579:1649-1657.
- Lauer, W.C., L.W. Condie, G.W. Wolfe, E.T. Czeh, J.M. Burns. 1994. "Denver Potable Water Reuse Demonstration Project: Comprehensive Chronic Rat Study." *Food and Chemical Toxicology*, 32(11): 1021-1030.
- Lauer, W. C., and S. E. Rogers. 1996. *The demonstration of direct potable water reuse: Denver's pioneer project*. Proceedings of the AWWA/WEF 1996 Water Reuse Conference.
- LeChevallier, M. W., C. D. Norton, A. Camper, P. Morin, B. Ellis, W. Jones, A. Rompre, M. Prevost, J. Coallier, P. Servais, D. Holt, A. Delanoue, J. Colbourne. 1998. *Microbial Impact of Biological Filtration*. AwwaRF. Denver, CO.
- Lim, K.-Y., Wu, Y. and Jiang, S.C. 2017. "Assessment of Cryptosporidium and norovirus risk associated with de facto wastewater reuse in Trinity River, Texas." *Microbial Risk Analysis*, 5(Supplement C), 15-24.
- Macler, B.A., S. Regli. 1993. "Use of microbial risk assessment in setting United-States drinking-water standards." *International Journal of Food Microbiology*, 18:245-256
- Messner, M.J., P. Berger, S.P. Nappier. 2014. "Fractional Poisson--a simple dose-response model for human norovirus." *Risk Analysis*, 34(10):1820-1829.
- Messner, M.J., P. Berger. 2016. "Cryptosporidium Infection Risk: Results of New Dose-Response Modeling." *Risk Analysis*, 36(10):1969-1982.
- Metcalf and Eddy, Inc. 2003. *Wastewater Engineering, Treatment and Reuse* (fourth ed.), McGraw Hill, Boston, MA, USA.
- Metzler, D., R.L. Culp, H.A. Stoltenberg, R.L. Woodward, G. Walton, S.L. Chang, N.A. Clarke, C.M. Palmer, F.M. Middleton, C.H. Connell. 1958. "Emergency Use of Reclaimed Water for Potable Supply at Chanute, Kansas." *AWWA Journal*, 50(8):1021-1060.
- Miller, J. H., J.T. Novak, W.R. Knocke, K. Young, Y. Hong, P.J. Vikesland, M.S. Hull, A. Pruden. 2013. "Effect of Silver Nanoparticles and Antibiotics on Antibiotic Resistance Genes in Anaerobic Digestion." *Water Environment Research*, 85(5): 411-421.
- Miller, G. W. 2015. "Direct Potable Reuse: Its Time Has Come." *Journal of the American Water Works Association*, 107(5): 14-20.
- Montgomery, J. 1983. *Operation, Maintenance and Performance Evaluation of the Potomac Estuary Experimental Water Treatment Plant*. U.S. Army Corps of Engineers Baltimore District.

- MWH Americas, Inc., Brown and Caldwell, Trussell Technologies, Inc. 2016. *DRAFT Task 3: North City Pure Water Facility (MR) (NC03B) 30% Engineering Design Report*. Prepared for City of San Diego Public Utilities Department. San Diego, CA.
- Nalinakumari, B., W. Cha, P. Fox. 2010. "Effects of Primary Substrate Concentration On N-nitrosodimethylamine (NDMA) During Simulated Aquifer Recharge." *ASCE Journal of Environmental Engineering*, 136(4):373-380.
- National Research Council (NRC). 1980. *An Evaluation of Activated Carbon for Drinking Water Treatment in Drinking Water and Health: Volume 2*. National Academies Press: Washington D.C. Accessed on September 28, 2017 from <https://www.ncbi.nlm.nih.gov/books/NBK234593/>.
- National Research Council (NRC). 1982. *Quality Criteria for Water Reuse*. The National Academies Press: Washington, D.C.
- National Research Council (NRC). 1998. *Issues in Potable Reuse: The Viability of Augmenting Drinking Water Supplies with Reclaimed Water*. Committee to Evaluate the Viability of Augmenting Potable Water Supplies with Reclaimed Water. Washington, D.C: National Academy Press.
- National Research Council (NRC). 2004. *Indicators for Waterborne Pathogens*. Washington, DC: The National Academies Press. Accessed on September 28, 2017 from http://www.nap.edu/openbook.php?record_id=11010&page=R1.
- National Research Council (NRC). 2008. *Prospects for Managed Underground Storage of Recoverable Water*. The National Academies Press: Washington, D.C.
- National Research Council (NRC). 2012a. *Water Reuse: Potential for Expanding the Nation's Water Supply Through Reuse of Municipal Wastewater*. The National Academies Press: Washington, D.C.
- National Research Council (NRC). 2012b. *Reuse of Municipal Wastewater Has Significant Potential to Augment Future U.S. Drinking Water Supplies*. Accessed on September 28, 2017 from <http://www8.nationalacademies.org/onpinews/newsitem.aspx?RecordID=13303>.
- National Water Research Institute (NWRI) and WateReuse Research Foundation (WRRF). 2013. *Examining the Criteria for Direct Potable Reuse*. WRRF 11-02. NWRI 2013-01.
- National Water Research Institute (NWRI). 2015. *Framework for Direct Potable Reuse*. Sponsored by the American Water Works Association (AWWA), Water Environment Foundation (WEF), and WateReuse Research Foundation. WRRF. Alexandria, VA.
- Nix, Daniel. 2014. *City of Wichita Falls Water Conservation and Emergency Direct Potable Reuse*. City of Wichita Falls, Texas.
- N.Y. Comp. Codes R. & Regs. (NYCRR) tit. 10, § 225. 2011. Title 10 Department of Health. 2011. 10 CRR-NY
- Odendaal, P.E. 1991. "Recent Advances in Water Reuse Research in South Africa." *Water Science & Technology*. 23(10-12): 2061-2071.
- Oklahoma Department on Environmental Quality (ODEQ). 2014. *Regulatory Path Forward for Direct and Indirect Potable Reuse*. ODEQ Water Quality Standards and Technical Subcommittees. Accessed on September 28, 2017 from <http://www.deq.state.ok.us/wqdnew/wqmac/Proposed2014/RegulatoryPathForwardforIndirectandDirectPotableReuseofReclaimedWaterNov2014.pdf>.
- Olivieri, A.W., D. Eisenberg, J. Soller, P. Gagliardo. 1999. "Estimation of pathogen removal in an advanced water treatment facility using Monte Carlo simulation." *Water Science & Technology*, 40(4-5): 223-233.
- Olivieri, A.W., J. Crook, M.A. Anderson, R.J. Bull, J.E. Drewes, C. Haas, et al. 2016. *Expert panel final report: evaluation of the feasibility of developing uniform water recycling criteria for direct potable reuse*. Submitted August 2016 by the National Water Research Institute for the State Water Resources Control Board. Sacramento, CA.
- Patel, M. 2010. *RO CIP and energy optimization for the GWRS project*. WEF Membrane Applications Conference 2010.
- Pecson, B.M., S.C. Triolo, S. Olivieri, E.C. Chen, A.N. Pisarenko, C.C. Yang, A. Olivieri, C.N. Haas, R.S. Trussell, R.R. Trussell. 2017. "Reliability of pathogen control in direct potable reuse: Performance evaluation and QMRA of a full-scale 1 MGD advanced treatment train." *Water Research*. 122: 258-268.
- Pereira, M.A. et al. Toxicology Studies of the Tampa Water Resources Project. Medical College of Ohio, Toledo (undated).

- PGJ Meiring & Partners. 1982. *A guide for the planning, design and implementation of a water reclamation scheme*. Water Research Commission. Pretoria, Australia.
- Poulson, T.K. 2010. *Central Arizona Salinity Study: Strategic Alternatives for Brine Management in the Valley of the Sun*. Concentrate Management Sub-Committee. Phoenix, Arizona.
- Rausch-Williams, T., C. Hoppe-Jones, J.E. Drewes. 2010. "The role of organic matter in the removal of emerging trace organic chemicals during managed aquifer recharge." *Water Research*, 44(2): 449-460.
- Rock, C. M., S. Snyder, J. Amador, J. Hooper, J. Vandegrift, J. Osgood, A. da Silva, and K. Bell. 2016. *Assessment of Techniques to Evaluate and Demonstrate the Safety of Water from Direct Potable Reuse Treatment Facilities: Literature Review*. Project #4508. Denver, Colo.: Water Research Foundation (WRF).
- Rose, J.B., Farrah, S.R., Harwood, V.J., Levine, A.D., Lukaskik, J., Menendez, P., Scott, T.M. 2004. *Reduction of pathogens, indicator bacteria, and alternative indicators by wastewater treatment and reclamation processes*. Water Environmental Research Foundation (WERF), Final Report No. 00-PUM-2T.
- Sanitation Districts of Los Angeles County (SDLAC). 2017. *Discharge Limits*. Accessed on September 28, 2017 from http://www.lacsd.org/wastewater/industrial_waste/iwppolicies/discharge_limits.asp.
- Schaider, L., K. Rodgers, R. Rudel. 2013. *Contaminants of emerging concern and septic systems: a synthesis of scientific literature and application to groundwater quality on Cape Cod*. Silent Spring Institute, Newton, MA.
- Sedlak, D., K. Pinkston, C. Huang. 2005. *Occurrence Survey of Pharmaceutically Active Compounds*. AWWA Research Foundation and WaterReuse Foundation. Project #2617. Denver, CO.
- Sinclair, M., J. O'Toole, K. Gibney, K. Leder. 2015. "Evolution of regulatory targets for drinking water quality." *Journal of Water Health*, 13:413-426
- Sloan, D. 2013. *Direct Raw Water Blending in Big Spring*. WaterReuse Association Direct Potable Reuse Conference 2013.
- Sloss, E.M., S.A. Geschwind, D.F. McCaffrey, B.R. Ritz. 1996. *Groundwater Recharge with Reclaimed Water: An Epidemiological Assessment in Los Angeles County 1987-1991*. Santa Monica, CA: RAND Corporation.
- Sloss, E.M., D F. McCaffrey, R. D. Fricker, S. A. Geschwind and B. R. Ritz. 1999. *Groundwater Recharge with Reclaimed Water: Birth Outcomes in Los Angeles County, 1982-1993*. Santa Monica, CA: RAND Corporation.
- Snyder, S.A., D.L. Villeneuve; E.M. Snyder, J.P. Giesy. 2001. "Identification and Quantification of Estrogen Receptor Agonists in Wastewater Effluents." *Environmental Science & Technology*, 35(18):3620-3625.
- Snyder, S.A., R.A. Trenholm, E.M. Snyder, G.M. Bruce, R.C. Pleus, J.D.C. Hemming. 2008. *Toxicological Relevance of EDCs and Pharmaceuticals in Drinking Water*. Project #3085. Denver, Colo.: Water Research Foundation (WRF).
- Snyder, S.A. 2014. "Emerging chemical contaminants: Looking for greater Harmony." *Journal of the American Water Works Association*, 106(8):38-52.
- Soller, J., S. Eftim, I. Warren, S. Nappier. 2017. "Evaluation of microbiological risks associated with direct potable reuse." *Microbial Risk Analysis*, (2017):3-14.
- Soller J., S. E. Eftim, S. P. Nappier. 2018. "Direct Potable Reuse Microbial Risk Assessment Methodology: Sensitivity Analysis and Application to State Log Credit Allocations." *Water Research*, 128:286-292. Available at doi: 10.1016/j.watres.2017.10.034.
- Steadman, L. 2015. "Brazil: Avoiding Future Water Woes. Water and WasteWater International." Volume 30, Issue 3. Accessed on September 28, 2017 from <http://www.waterworld.com/articles/wwi/print/volume-30/issue-3/regional-spotlight-latin-america/brazil-avoiding-future-water-woes.html>.
- Swartz C.H., S. Reddy, M.J., Benotti, H.F. Yin, L.B. Barber, B.J. Brownawell. et al. 2006. "Steroid estrogens, nonylphenol ethoxylate metabolites, and other wastewater contaminants in groundwater affected by a residential septic system on Cape Cod, MA." *Environmental Science & Technology*, 40(16):4894-4902.
- Szerwinski, A., K. Bell, K. Bordewick. 2012. *Chloramination in a partially nitrified effluent: Process control solutions and case study*. WEF Technical Exhibition Conference, Los Angeles, CA.
- Teerlink, J., V. Martinez-Hernandez, C.E. Higgins, J.E. Drewes. 2012. "Removal of trace organic chemicals in onsite wastewater soil treatment units: A laboratory experiment." *Water Research*, 46(16): 5174-5184.
- Teunis, P.F., C.L. Moe, P. Liu, S.E. Miller, L. Lindesmith, R.S. Baric, J. Le Pendu, R.L. Calderon. 2008. "Norwalk virus: How infectious is it?" *Journal of Medical Virology*, 80(8):1468-1476.

- Teunis, P., J. Schijven, S. Rutjes. 2016. "A generalized dose-response relationship for adenovirus infection and illness by exposure pathway." *Epidemiology and Infection*, 144(16): 3461-3473.
- Texas Water Development Board (TWDB). 2014. *Direct Potable Reuse Resource Document*. Texas Water Development Board. Austin, Texas.
- Texas Water Development Board (TWDB). 2015. *Final Report: Direct Potable Reuse Resource Document*. Texas Water Development Board and Alan Plummer Associates. Austin, Texas.
- Texas Water Development Board (TWDB). 2016. *Direct Potable Reuse Monitoring: Testing Water Quality in a Municipal Wastewater Effluent Treated to Drinking Water Standards – Volume 1 of 2*. Texas Water Development Board and WE&RF. Austin, TX.
- Tice, R.R., C.P. Austin, R.J. Kavlock, J.R. Bucher. 2013. "Improving the Human Hazard Characterization of Chemicals: A Tox21 Update." *Environmental Health Perspectives*, 121(7):756.
- Tricas M, B. Liner. 2017. "A framework for improving economic analysis of water reuse opportunities." *International Journal of Environmental Policy and Decision Making*, 2(3):207-20.
- Trussell, R.; A. Salveson, S. Snyder, S. Trussell, D. Gerrity, B. Pecson. 2013. *Potable Reuse: State of the Science Report and Equivalency Criteria for Treatment Trains*. WaterReuse Research Foundation Project 11-02 and Bureau of Reclamation. Alexandria, VA.
- U.S. Environmental Protection Agency (EPA). 1972. *EPA Policy Statement on Water Reuse, and Water Reuse Background Statement*. Washington D.C. Publication Number 832R72102. Accessed on September 28, 2017 from <http://nepis.epa.gov/Exe/ZyPURL.cgi?Dockey=9100EYVM.txt>
- U.S. Environmental Protection Agency (EPA). 1974. *Design criteria for mechanical electric and fluid system and component reliability*. Office of Water Program Operators. Federal Water Quality Administration. EPA-430-99-74-001.
- U.S. Environmental Protection Agency (EPA). 1980a. *Guidelines for Water Reuse*. EPA/600/8-80-036.
- U.S. Environmental Protection Agency (EPA). 1980b. *Protocol Development: Criteria and Standards for Potable Reuse and Feasible Alternatives*. EPA 570/9-82-005. Washington, D.C.
- U.S. Environmental Protection Agency (EPA). 1989a. National Primary Drinking Water Regulations; Filtration, Disinfection; Turbidity, *Giardia lamblia*, Viruses, Legionella, and Heterotrophic Bacteria; Final Rule. Part III. 54 FR 27486. June 29, 1989.
- U.S. Environmental Protection Agency (EPA). 1989b. Drinking Water; National Primary Drinking Water Regulations: Total Coliforms (Including Fecal Coliforms and *E. coli*); Final Rule. 54 FR 27544. June 29, 1989.
- U.S. Environmental Protection Agency (EPA). 1992. *Guidelines for Water Reuse*. EPA/625/R-92/004.
- U.S. Environmental Protection Agency (EPA). 1998a. National Primary Drinking Water Regulations: Interim Enhanced Surface Water Treatment; Final Rule. 63 FR 69478. December 16, 1998).
- U.S. Environmental Protection Agency (EPA). 1998b. National Primary Drinking Water Regulations; Disinfectants and Disinfection Byproducts; Final Rule. [63 FR 69390](#). December 16, 1998.
- U.S. Environmental Protection Agency (EPA). 1999a. *Final Guidelines for the Certification and Recertification of Operators of Community and Nontransient Noncommunity Public Water Systems*. 64 FR 5916. February 5, 1999.
- U.S. Environmental Protection Agency (EPA). 1999b. *Alternative Disinfectants and Oxidants Guidance Manual*. EPA 815-R-99-014. Washington, D.C.
- U.S. Environmental Protection Agency (EPA). 2000a. *The Methodology for Deriving Ambient Water Quality Criteria for the Protection of Human Health*. EPA-822-B-00-004. Washington, D.C. Accessed on September 28, 2017 from <https://nepis.epa.gov/Exe/ZyPDF.cgi/20003D2R.PDF?Dockey=20003D2R.PDF>. >.
- U.S. Environmental Protection Agency (EPA). 2000b. *Risk Characterization*. EPA-100-B-00-002. Risk Characterization Implementation Core Team, EPA Science Policy Council. Washington, D.C.
- U.S. Environmental Protection Agency (EPA). 2001a. *Stage 1 Disinfectants and Disinfection Byproduct Rule: What Does it Mean to You?*. EPA 816-R-00-014. Accessed on September 28, 2017 from <https://nepis.epa.gov/Exe/ZyPDF.cgi?Dockey=200025FL.txt>.
- U.S. Environmental Protection Agency (EPA). 2001b. *Method 1602: Male-specific (F+) and Somatic Coliphage in Water by Single Agar Layer (SAL) Procedure*. EPA 821-R-01-029. Office of Water, Engineering and Analysis Division, Washington, DC.

- U.S. Environmental Protection Agency (EPA). 2001c. *Method 1601: Detection of Male-specific (F+) and Somatic Coliphage in Water by Two-Step Enrichment Procedure*. EPA 821-R-01-030. Office of Water, Engineering and Analysis Division, Washington, DC.
- U.S. Environmental Protection Agency (EPA). 2001d. National Primary Drinking Water Regulations: Filter Backwash Recycling Rule. [66 FR 31086](#). June 8, 2001.
- U.S. Environmental Protection Agency (EPA). 2002a. *Nitrification*. Office of Water, Office of Ground Water and Drinking Water. Accessed on September 28, 2017 from https://www.epa.gov/sites/production/files/2015-09/documents/nitrification_1.pdf.
- U.S. Environmental Protection Agency (EPA). 2002b. National Primary Drinking Water Regulations: Long Term 1 Enhanced Surface Water Treatment Rule. Final Rule. [67 FR 1812](#). January 14, 2002.
- U.S. Environmental Protection Agency (EPA). 2004. *Guidelines for Water Reuse*. EPA 625/R-04/108. Washington, D.C.
- U.S. Environmental Protection Agency (EPA). 2006a. National Primary Drinking Water Regulations: Stage 2 Disinfectants and Disinfection Byproducts Rule; Final Rule. [71 FR 388](#). January 4, 2006.
- U.S. Environmental Protection Agency (EPA). 2006b. National Primary Drinking Water Regulations: Long Term 2 Enhanced Surface Water Treatment Rule; Final Rule. [71 FR 654](#). January 5, 2006.
- U.S. Environmental Protection Agency (EPA). 2006c. *National Primary Drinking Water Regulation: Ground Water Rule; Final Rule*. 71 FR 65573. November 8, 2006.
- U.S. Environmental Protection Agency (EPA). 2007. National Primary Drinking Water Regulations for Lead and Copper: Short-Term Regulatory Revisions and Clarification, 72 FR 57782. October 10, 2007.
- U.S. Environmental Protection Agency (EPA). 2011. *Introduction to the National Pretreatment Program*. EPA-833-B-11-001. Office of Wastewater Management. Washington, D.C.
- U.S. Environmental Protection Agency (EPA). 2012a. *Guidelines for Water Reuse*. EPA/600/R-12/618. Washington D.C.
- U.S. Environmental Protection Agency (EPA). 2012b. *Drinking Water Standards and Health Advisories*. EPA 822-S-12-001. Office of Water. Washington, D.C. Accessed on September 28, 2017 from <https://nepis.epa.gov/Exe/ZyPDF.cgi/P100N01H.PDF?Dockey=P100N01H.PDF>.
- U.S. Environmental Protection Agency (EPA). 2012c. *Recreational Water Quality Criteria*. EPA 820-F-12-058. Washington, D.C.
- U.S. Environmental Protection Agency (EPA). 2013a. *Water Permitting 101*. Office of Wastewater Management. Accessed from <<https://www3.epa.gov/npdes/pubs/101page.pdf>>.
- U.S. Environmental Protection Agency (EPA). 2013b. National Primary Drinking Water Regulations: Revisions to the Total Coliform Rule, 78 FR 10269 (February 13, 2013).
- U.S. Environmental Protection Agency (EPA). 2014a. *Microbiological Risk Assessment (MRA) Tools, Methods, and Approaches for Water Media*, EPA-820-R-14-009. Office of Science and Technology, Office of Water. Washington, D.C.
- U.S. Environmental Protection Agency (EPA). 2014b. *Overview of Technical Support Materials: A Guide to the Site-Specific Alternative Recreational Criteria TSM Documents*. EPA-820-R-14-010. Office of Water, Office of Science and Technology. Washington, D.C.
- U.S. Environmental Protection Agency (EPA). 2015a. *Review of Coliphages as Possible Indicators of Fecal Contamination for Ambient Water Quality*. EPA-820-R-15-098. Office of Water, Office of Science and Technology, Health and Ecological Criteria Division. Washington, D.C.
- U.S. Environmental Protection Agency (EPA). 2015b. *Human Health Ambient Water Quality Criteria: 2015 Update*. Accessed on September 28, 2017 from <https://www.epa.gov/sites/production/files/2015-10/documents/human-health-2015-update-factsheet.pdf>.
- U.S. Environmental Protection Agency (EPA). 2015c. *Understanding the Safe Drinking Water Act*. Accessed on September 28, 2017 from <https://www.epa.gov/sites/production/files/2015-04/documents/epa816f04030.pdf>.
- U.S. Environmental Protection Agency (EPA). 2016a. *Aquifer Recharge and Aquifer Storage and Recovery*. Accessed on September 28, 2017 from <https://www.epa.gov/uic/aquifer-recharge-and-aquifer-storage-and-recovery>.

- U.S. Environmental Protection Agency (EPA). 2016b. *Underground Injection Control: General Information About Injection Wells*. Accessed on September 28, 2017 from <https://www.epa.gov/uic/general-information-about-injection-wells>.
- U.S. Environmental Protection Agency (EPA). 2016c. Drinking Water Contaminant Candidate List 4-Final, 81 FR 81099. November 17, 2016.
- U.S. Environmental Protection Agency (EPA). 2016d. *Human Health Risk Assessment*. Accessed on September 28, 2017 from <https://www.epa.gov/risk/human-health-risk-assessment>.
- U.S. Environmental Protection Agency (EPA). 2017a. *NPDES State Program Information*. Accessed on September 28, 2017 from <https://www.epa.gov/npdes/npdes-state-program-information>.
- U.S. Environmental Protection Agency (EPA). 2017b. *Background on Drinking Water Standards in the Safe Drinking Water Act (SDWA)*. Accessed on September 28, 2017 from <https://www.epa.gov/dwstandardsregulations/background-drinking-water-standards-safe-drinking-water-act-sdwa>.
- U.S. Environmental Protection Agency (EPA). 2017c. *How EPA Regulates Drinking Water Contaminants*. Accessed on September 28, 2017 from <https://www.epa.gov/dwregdev/how-epa-regulates-drinking-water-contaminants>.
- U.S. Environmental Protection Agency (EPA). 2017d. *Drinking Water Contaminant Candidate List (CCL) and Regulatory Determination*. Accessed on September 28, 2017 from <https://www.epa.gov/ccl>.
- U.S. Environmental Protection Agency (EPA). 2017e. *Drinking Water Requirements for States and Public Water Systems: Surface Water Treatment Rule*. Accessed on September 28, 2017 from <https://www.epa.gov/dwreginfo/surface-water-treatment-rules>.
- U.S. Environmental Protection Agency (EPA). 2017f. *Drinking Water Requirements for States and Public Water Systems: Groundwater Rule*. Accessed on September 28, 2017 from <https://www.epa.gov/dwreginfo/ground-water-rule>.
- U.S. Environmental Protection Agency (EPA). 2017g. *Revised Total Coliform Rule And Total Coliform Rule*. Accessed on September 28, 2017 from <https://www.epa.gov/dwreginfo/revised-total-coliform-rule-and-total-coliform-rule>.
- U.S. Environmental Protection Agency (EPA). 2017h. *Drinking Water Requirements for States and Public Water Systems: Lead and Copper Rule*. Accessed on September 28, 2017 from <https://www.epa.gov/dwreginfo/lead-and-copper-rule>.
- U.S. Environmental Protection Agency (EPA). 2017i. *The National Pollutant Discharge Elimination System: NPDES Permit Limits*. Accessed on September 28, 2017 from <https://www.epa.gov/npdes/npdes-permit-limits>.
- U.S. Environmental Protection Agency (EPA). 2017j. *Summary of the Clean Water Act*. Accessed on September 28, 2017 from <https://www.epa.gov/laws-regulations/summary-clean-water-act>.
- U.S. Environmental Protection Agency (EPA). 2017k. *Secondary Drinking Water Regulations: Guidance for Nuisance Chemicals*. Accessed on September 28, 2017 from <https://www.epa.gov/dwstandardsregulations/secondary-drinking-water-standards-guidance-nuisance-chemicals>.
- U.S. Environmental Protection Agency (EPA). 2017l. *Drinking Water Contaminant Human Health Effects Information*. Accessed on September 28, 2017 from <https://www.epa.gov/dwstandardsregulations/drinking-water-contaminant-human-health-effects-information>.
- U.S. Environmental Protection Agency (EPA). 2017m. *Decision Support System for Aquifer Storage and Recovery (ASR) Planning, Design and Evaluation— Principles and Technical Basis*. Accessed on September 28, 2017 from https://cfpub.epa.gov/si/si_public_record_report.cfm?dirEntryId=335408.
- U.S. Environmental Protection Agency (EPA). 2017n. *National Primary Drinking Water Regulations*. Accessed on September 28, 2017 from <https://www.epa.gov/ground-water-and-drinking-water/national-primary-drinking-water-regulations>.
- U.S. Environmental Protection Agency (EPA). 2017o. *Monitoring Unregulated Drinking Water Contaminants: Learn About the Unregulated Contaminant Monitoring Rule*. Accessed on September 28, 2017 from <https://www.epa.gov/dwucmr/learn-about-unregulated-contaminant-monitoring-rule>.
- U.S. Environmental Protection Agency (EPA). 2017p. *Water Quality Criteria*. Accessed on September 28, 2017 from <https://www.epa.gov/wqc>.
- U.S. Environmental Protection Agency (EPA). 2017q. *National Pollutant Discharge Elimination System (NPDES): NPDES Permit Basics*. Accessed on September 28, 2017 from <https://www.epa.gov/npdes/npdes-permit-basics>.

- U.S. Environmental Protection Agency (EPA). 2017r. *Source Water Protection Basics*. Accessed on September 28, 2017 from <https://www.epa.gov/sourcewaterprotection/source-water-protection-basics>.
- U.S. Environmental Protection Agency (EPA). 2017s. *Protecting Underground Sources of Drinking Water from Underground Injection (UIC)*. Accessed on September 28, 2017 from <https://www.epa.gov/uic>.
- U.S. Environmental Protection Agency (EPA). 2017t. *Sanitary Surveys*. Accessed on September 28, 2017 from <https://www.epa.gov/dwreginfo/sanitary-surveys>.
- U.S. Environmental Protection Agency (EPA). 2017u. *About WaterSense*. Accessed on November 2, 2017 from <https://www.epa.gov/watersense/about-watersense>.
- U.S. Environmental Protection Agency (EPA). 2017v. *2016 Experts Coliphage Workshop Proceedings*. EPA 822-R-17-003. Washington, D.C.
- U.S. Food and Drug Administration (FDA). 2017. *Hazard Analysis and Critical Control Points (HACCP)*. Accessed on September 28, 2017 from <https://www.fda.gov/food/guidanceregulation/haccp/>.
- Van der Aa, L. T. J., R.J. Kolpa, A. Magic-Knezev, L.C. Rietveld, J. C. van Dijk. 2003. *Biological Activated Carbon Filtration: Pilot Experiments in the Netherlands*. Water Technology Conference.
- Van Abel N., M.E. Schoen, J.C. Kissel, J.S. Meschke. 2017. "Comparison of Risk Predicted by Multiple Norovirus Dose-Response Models and Implications for Quantitative Microbial Risk Assessment." *Risk Analysis*, 37(2): 245-264.
- Wan Nik, W.B., M.M. Rahman, A.M. Yusof, F.N. Ani, C.M. Che Adnan. 2006. *Production of Activated Carbon from Palm Oil Shell Waste and Its Adsorption Characteristics*. Proceedings of the 1st International Conference on Natural Resources Engineering & Technology.
- Water Environment Research Foundation (WERF). 2003. *Efficient Redundancy Design Practices*. WERF Managing Utilities & Assets, 00-CTS-5. Alexandria, VA.
- Water Environment Federation (WEF). 2016. *Water Reuse Roadmap Primer*.
- Water Environment Federation (WEF) and the American Society of Mechanical Engineers (ASME). 2012. *Municipal Wastewater Reuse by Electric Utilities: Best Practices and Future Directions – Workshop Report*.
- Water Environment Federation (WEF) and American Water Works Association (AWWA). 2008. *Using Reclaimed Water to Augment Potable Resources*.
- Water Environment and Reuse Foundation (WE&RF). 2016a. *Development of Operation and Maintenance Plan and Training and Certification Framework for Direct Potable Reuse (DPR) Systems*. Reuse 13-13. Alexandria, VA.
- Water Environment and Reuse Foundation (WE&RF). 2016b. *Potable Reuse Research Compilation: Synthesis of Findings*. Reuse-15-01. Alexandria, VA.
- Water Environment and Reuse Foundation (WE&RF). 2016c. *Guidelines for Engineered Storage Systems*. Reuse 12-06. Alexandria, VA.
- Water Environment and Reuse Foundation (WE&RF). 2017a. *White Paper on the Feasibility of Establishing a Framework for Public Health Monitoring of Direct Potable Reuse*. Reuse-14-14. Alexandria, VA.
- Water Environment and Reuse Foundation (WE&RF). 2017b. *WE&RF to Receive a \$4.5 Million Grant from California State Water Board for Recycled Water Research*. Accessed on September 28, 2017 from http://www.werf.org/c/PressReleases/2017/WE_RF_to_Receive_4.5_Million_Grant_from_California_State_Water_Board_for_Recycled_Water_Research.aspx
- Water Environment and Reuse Foundation (WE&RF). Estimated release: 2017. *Establishing Additional Log Reduction Credit for Wastewater Treatment Plants*. WE&RF 14-02.
- Water Research Foundation (WRF). 2017. *Biological Treatment Research*. Water Research Foundation. Denver, CO.
- Water Research Foundation (WRF). Estimated release: 2018. *Blending Requirements for Water from Direct Potable Reuse Treatment Facilities*. WRF 4536.
- WaterReuse Association. 2004. *Innovative Applications in Water Reuse: Ten Case Studies*. Alexandria, VA.
- WaterReuse Foundation (WRF). 2008. *Development of indicators and surrogates for chemical contaminant removal during wastewater treatment and reclamation*. WRF 03-014. Water Environment Research Foundation (WERF), Bureau of Reclamation, California State Water Resources Control Board. Alexandria, VA.
- WaterReuse Foundation (WRF). 2011. *National Database of Water Reuse Facilities: Summary Report*. WRF-02-004. Alexandria, VA.

- WaterReuse Research Foundation (WRRF). 2011a. *Direct Potable Reuse – A Path Forward*. WRRF 11-00, Bureau of Reclamation, California State Water Resources Control Board. Alexandria, VA.
- WaterReuse Research Foundation (WRRF). 2013a. *Potable Reuse: State of the Science Report and Equivalency Criteria for Treatment Trains*. WRRF 11-02. WRRF and Bureau of Reclamation. Alexandria, VA.
- WaterReuse Research Foundation (WRRF). 2014a. *Risk Reduction for Direct Potable Reuse*. WRRF 11-10. Alexandria, VA.
- WaterReuse Research Foundation (WRRF). 2014b. *The Opportunity and Economics of Direct Potable Reuse*. WRRF 14-08. Alexandria, VA.
- WaterReuse Research Foundation (WRRF). 2014c. *Utilization of Hazard Analysis and Critical Control Points Approach for Evaluating Integrity of Treatment Barriers for Reuse*. WRRF 09-03. Alexandria, VA.
- WaterReuse Research Foundation (WRRF). 2014d. *Fit for Purpose Water: The Cost of Overtreating Reclaimed Water*. WRRF 10-01. WRRF and Bureau of Reclamation. Alexandria, VA.
- WaterReuse Research Foundation (WRRF). 2014e. *Demonstrating the Benefits of Engineered Direct Potable Reuse (DPR) versus De facto Reuse Systems*. WRRF 11-05. Alexandria, VA.
- WaterReuse Research Foundation (WRRF). 2015a. *Enhancing the Soil Aquifer Treatment Process for Potable Reuse*. WRRF 12-12. Alexandria, VA.
- WaterReuse Research Foundation (WRRF) and Metropolitan Water District of Southern California. 2015b. *Model Public Communication Plans for Increasing Awareness and Fostering Acceptance of Direct Potable Reuse*. WRRF 13-02. Alexandria, VA.
- Watts, M. J., R. Hofmann, E. Rosenfeldt. 2012. "Low-Pressure UV/Cl₂ for Advanced Oxidation of Taste and Odor." *Journal of the American Water Works Association*, 104(1): E58-E65.
- Wells, M. J. M., M.-L. Pellegrin, A. Morse, K.Y. Bell, L.J. Fono. 2008. "Emerging Pollutants." *Water Environment Research*, 80 (10): 2026–2057
- Wells, M. J. M., A. Morse, K.Y. Bell, M.-L. Pellegrin, L.J. Fono. 2009. "Emerging Pollutants." *Water Environment Research*, 81(10): 2211–2254.
- Wells, M. J. M., K.Y. Bell, K.A. Traexler, M.L. Pellegrin, A. Morse. 2010. "Emerging Pollutants." *Water Environment Research*, 82(10): 2095 – 2170.
- Wetterau, G., P. Liu, B. Chalmers, T. Richardson, H.B. VanMeter, H. B. 2011. "Optimizing RO design criteria for indirect potable reuse." *IDA Journal of Desalination and Water Reuse*, 3(4): 40-45.
- Wetterau, G., R. Chalmers, P. Liu, W. Pearce. 2013. "Advancing indirect potable reuse in California." *Water Practice & Technology*, 8(2): 275-285.
- Wetterau, G., P. Fu., C. Chang., B. Chalmers. 2015a. *Full-Scale Testing of Alternative UV Advanced Oxidation Processes for the Vander Lans Water Treatment Facility*. WaterReuse California Annual Conference.
- Wetterau, G., B. Chalmers, K. Bell. 2015b. *Comparing Recycled Water and Potable Water Treatment Requirements in California*. Presentation at International Desalination Association World Congress on Desalination and Water Reuse. REF: IDAWC15-Wetterau.
- White, G. C. 1986. *Handbook of chlorination*. Van Nostrand Reinhold Company.
- Won, W., T. Walker, M. Patel, E. Owens. 2010. "Comparing Membrane Operations at Three of the World's Largest Advanced Water Treatment Plants." *IDA Journal of Desalination and Water Reuse*, 2(3):10.
- Woodside, G., K. O'Connor-Patel. 2004. Final Report Santa Ana River Water Quality and Health Study. Orange County Water District.
- World Health Organization (WHO). 2001. *Water Quality: Guidelines, Standards, and Health*. Edited by Lorna Fewtrell and Jamie Bartram. IWA Publishing. London, UK.
- World Health Organization (WHO). 2009. *Water Safety Plan Manual: Step-by-step risk management for drinking-water suppliers*. World Health Organization. Geneva.
- World Health Organization (WHO). 2012. *Pharmaceuticals in Drinking-Water*. World Health Organization. Geneva.
- World Health Organization (WHO). 2017. *Potable Reuse: Guidance for Producing Safe Drinking-Water*. World Health Organization. Geneva.

Wunder, D. B., V. A. Horstman, R. M. Hozalski. 2008. *Antibiotics in Slow-Rate Biofiltration Processes: Biosorption Kinetics and Equilibrium*. In Proc. of the Thirty-Sixth Annual; AWWA Water Quality Technology Conference. Denver, CO.sses. Water Research Foundation, Denver, CO.

Wunder, D.B., R.M. Hozalski. 2012. *Fate and Impact of Antibiotics in Slow-rate Biofiltration Processes*. Water Research Foundation, Denver.

Yoo, R.S., D. Brown, R.J. Paradini, G.D. Bentson. 1995. "Microfiltration: A Case Study." *Journal of the American Water Works Association*, 87(3):38-49.

Zeng, Q., Y. Li, S. Yang. 2013. "Sludge Retention Time as a Suitable Operational Parameter to Remove Both Estrogen and Nutrients in an Anaerobic-Anoxic-Aerobic Activated Sludge System." *Environmental Engineering Science*, 30(4): 161–169.

Appendix A: Case Study Examples of IPR and DPR in the United States

- Appendix A-1** Los Alamitos Barrier Water Replenishment District of So. CA/Leo J. Vander Lans Advanced Water Treatment Facility – Indirect Potable Reuse
- Appendix A-2** Orange County Groundwater Replenishment System Advanced Water Treatment Facility
- Appendix A-3** Gwinnett F. Wayne Hill Water Resources Center, Chattahoochee River and Lake Lanier Discharge – Indirect Potable Reuse
- Appendix A-4** Village of Cloudcroft PRe Water Project – Direct Potable Reuse
- Appendix A-5** Colorado River Municipal Water District Raw Water Production Facility Big Spring Plant – Direct Potable Reuse
- Appendix A-6** Wichita Falls River Road WWTP and Cypress WTP Permanent IPR and Emergency DPR Project
- Appendix A-7** Potable Water Reuse in the Occoquan Watershed

A.1 Los Alamitos Barrier Water Replenishment District of So. CA/Leo J. Vander Lans Advanced Water Treatment Facility (LVLAWTF) – Indirect Potable Reuse

Paul Fu, Water Replenishment District of Southern California
 Greg Wetterau, CDM Smith

Project Facts

Location	California along the Los Angeles County and Orange County border
Size	3 million gallons per day (MGD) initial, expanded to 8 MGD
Year of Installation	2005 initial, expansion completed in 2014
Status	Operational
Cost	\$14 million initial, \$32 million expansion

Background

The Water Replenishment District of Southern California (WRD) is responsible for managing the Central and West Coast Groundwater Basins, which provide groundwater to 4 million residents in WRD’s service area. Prior to WRD’s formation in 1959, over-pumping resulted in water wells becoming dry and seawater intrusion contaminating coastal groundwater (WRD, 2013). One of WRD’s main objectives is to ensure water delivery to seawater intrusion barrier projects, such as the Alamitos Gap Barrier (AGB), to protect local aquifers from water quality degradation that would render the resource unusable for beneficial use (Figure A.1-1).



Figure A.1-1. Seawater barrier projects in California (Chang, 2013)

A schematic illustrating the use of well injection to prevent seawater intrusion can be seen in Figure A.1-2.

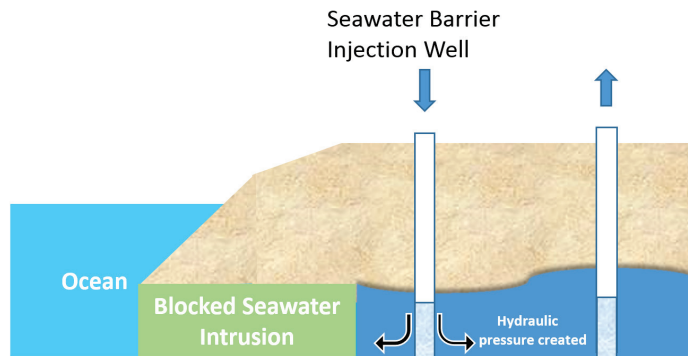

Figure A.1-2. Schematic of well injection to prevent seawater intrusion (adapted from Chang, 2013)

WRD has relied on imported water to replenish its groundwater sources. However, in 2005 WRD began sending recycled water from the Leo J. Vander Lans Advanced Water Treatment Facility (LVLAWTF) to the AGB for injection (**Figure A.1-3**). WRD's Water Independence Now program seeks to entirely eliminate WRD's dependence on imported water as a groundwater replenishment source and instead utilize alternative supplies such as stormwater and recycled water.



Figure A.1-3. Leo J. Vander Lans Advanced Water Treatment Facility (WRD, 2015)

The AGB currently has 43 injection wells stretching 2.2 miles and 220 associated observation wells. From 1966 through 2005, only municipal potable water was used for injection. The LVLAWTF was constructed in 2005 with a capacity of 3 MGD (EPA, 2012); the plant expansion completed in December 2014 increased capacity to 8 MGD (WRD, 2014). Tertiary treated recycled water from the Long Beach Water Reclamation Plant (LBWRP) serves as the influent water to LVLAWTF where microfiltration, reverse osmosis (RO) and ultraviolet disinfection with advanced oxidation process (MF/RO/UV-AOP) ensue before being sent to the AGB for injection (Chalmers, 2013).

With the expansion, LVLAWTF is capable of delivering 100 percent advanced treated recycled water to the AGB instead of blended municipally treated water and recycled water. The expansion will ultimately include influent water from the 37 MGD Los Coyotes Water Reclamation Plant, located 6 miles north of LVLAWTF.

Treatment Type and Process Flow Block Diagram

The plant expansion increases the overall plant recovery rate from 77 percent to 92 percent (WRD, 2014) - the highest recovery rate of any equivalent MF/RO/UV-AOP treatment train in the United States. This is a dramatic increase compared to typical recovery rates of approximately 80 percent (Chalmers, 2013). The

plant employs a treatment combination of MF, RO, and UV–AOP utilizing hydrogen peroxide (Figure A.1-4).

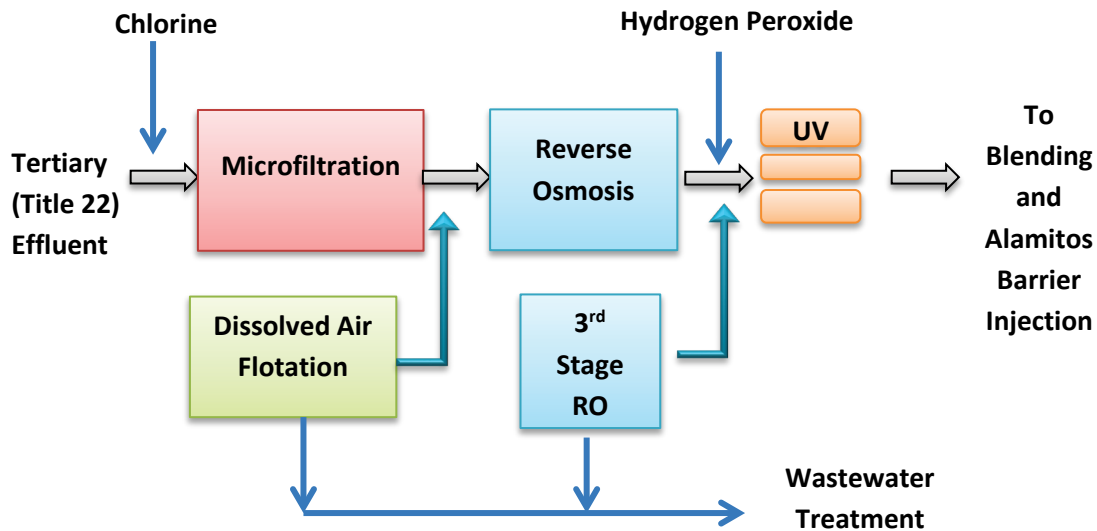

Figure A.1-4. LVLAWTF expansion treatment process (adapted from WRD, 2013)

Before the expansion, the reclaimed water was blended with 50 percent municipal water before being distributed to the AGB. The expansion includes an MF backwash treatment system which recovers 99 percent of the MF influent utilizing dissolved-air flotation (DAF) clarification technology (Figure A.1-5).

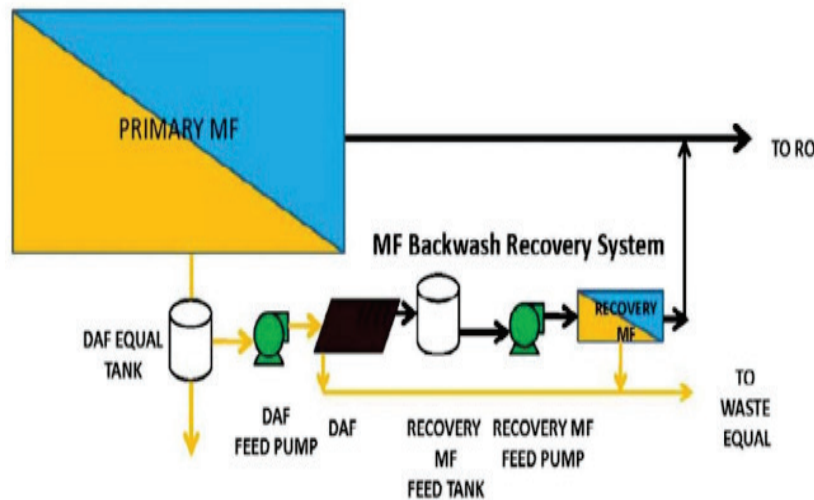

Figure A.1-5. MF and backwash recovery system at LVLAWTF (Chalmers, 2013)

DAF clarifiers achieve better than 2 nephelometric turbidity units (NTU) turbidity when operated with alum or ferric chloride as the coagulants. Due to stringent downstream requirements, a major design constraint of the plant expansion included limiting the amount of waste (i.e. RO brine) generated from treatment processes to 760,000 GPD, which is sent to a wastewater treatment plant downstream (Chalmers, 2013). By installing the MF backwash treatment system and an RO-recovery system, which increased RO recovery

to greater than 92 percent, the plant is able to successfully deliver discharges to the wastewater treatment plant under 760,000 GPD (**Table A.1-1**).

Table A.1-1. LVLAWTF plant processes (Chalmers, 2013)

Process	Recovery Rate
Microfiltration	98%
Reverse Osmosis	>92%
Overall Plant Recovery	92%

A third-stage RO system was added as part of the expansion for the purpose of treating RO concentrate from both two-stage upstream RO systems (Chalmers, 2013). The final steps include UV-AOP and stabilization of the product water with sodium hydroxide and calcium chloride to control the pH and re-mineralize the water before it is injected into the AGB. The total chlorine residual leaving the plant is approximately 3-4 mg/L (WRD, 2012).

Permitting and Monitoring

The LVLAWTF original permit has been revised under the Regional Water Quality Control Board, making LVLAWTF the first facility to receive approval under the finalized 2014 Groundwater Replenishment Reuse Regulations (**Table 3-2** in **Chapter 3**). On May 7, 2014, the County Sanitation Districts of Los Angeles County applied for a wastewater change petition in order to discharge an additional 5 MGD from the LBWRP to WRD. The recycled water is continually monitored and available for public view on a web database known as Geotracker, and also through an interactive well search website owned by WRD.

Influent N-nitrosodimethylamine (NDMA) concentrations to LVLAWTF average 420 parts per trillion (ppt). NDMA in water can originate from many potential sources including chlorine disinfection processes, ion exchange resins, water treatment polymers, circuit board manufacturing, leather tanning, pesticide manufacturing, cosmetic manufacturing, and rocket fuel (Trojan Technologies, 2010). The State Water Resource Control Board Division of Drinking Water (DDW) and EPA both recognize the danger of NDMA and have set notification levels at 10 ppt. NDMA passes through unit processes such as RO because of its small molecular weight and weak ionic charge (Trojan Technologies, 2010). Therefore, LVLAWTF utilizes low pressure and high output UV disinfection to destroy NDMA via photolysis to levels below 10 ppt (Trojan Technologies, 2010). Design criteria for the plant expansion included 2-log NDMA removal and 0.5-log 1,4-dioxane removal. 1,4-dioxane is an organic solvent used in many industrial and synthetic processes, present at the µg/L level in some wastewaters. It is likely to penetrate through RO membranes, and therefore was included as a log-removal requirement in the DDW Groundwater Replenishment Reuse Regulations. Influent levels of 1,4-dioxane have historically been low for LVLAWTF, so it was necessary to spike the compound into the RO permeate to test the removal efficiency of AOP (Wetterau et al., 2015).

References

Chalmers, B. 2013. "High-Water Mark: Indirect Potable Reuse with a 92 percent Recovery Rate." *Water Online*. 18-19.

Chang, C. 2013. "Moving Towards 100 percent Recycled Water at the Seawater Intrusion Barrier Wells, Central Basin and West Coast Basin." *WRD Technical Bulletin*, Volume 25. Accessed on September 28, 2017 from <http://www.wrd.org/sites/pr/files/TB25%20-%20Moving%20Towards%20100%25%20Recycled%20Water%20at%20the%20Seawater%20Intrusion%20Barrier%20Wells%20-%20WRD%20Service%20Area.pdf>

Trojan Technologies. 2010. 'Recycled Water Project, Water Replenishment District, Leo J. Vander Lans Water Treatment Facility'.

U.S. Environmental Protection Agency (EPA). 2012. Guidelines for Water Reuse, EPA/600/R-12/618. Washington D.C.

Water Replenishment District of Southern California (WRD). 2012. *Leo J. Vander Lans Water Treatment Facility Expansion* Presentation. WateReuse LA Chapter Meeting, February 14.

Water Replenishment District of Southern California (WRD). 2013. Retrieved from <http://www.wrd.org/>

Water Replenishment District of Southern California (WRD). 2014. *WRD Increases Production of Recycled Water to 8 Million Gallons Per Day*. Accessed on September 28, 2017 from <http://www.prnewswire.com/news-releases/wrd-increases-production-of-recycled-water-to-8-million-gallons-per-day-300012773.html>

Wetterau, G., Fu, P., Chang, C. and Chalmers, B. 2015. *Full-Scale Testing of Alternative UV Advanced Oxidation Processes for the Vander Lans Water Treatment Facility*. WateReuse California Annual Conference Proceedings.

A.2 Orange County Groundwater Replenishment System (GWRS) Advanced Water Treatment Facility

Mehul Patel, Orange County Water District
Greg Wetterau and Bruce Chalmers, CDM Smith

Project Facts

Location	Orange County, California
Size	70 MGD initial, expanded to 100 MGD
Year of Installation	2008 initial, expansion completed in 2015
Status	Operational
Cost	\$481 million initial, \$143 million expansion

Background

Water Factory 21 was established in Orange County, California in 1976 as the first project utilizing direct injection of recycled wastewater as a seawater intrusion barrier (EPA, 2012). The Orange County Water District (OCWD) obtains water from the Santa Ana River, the Colorado River, the State Water Project (Delta conveyance), local precipitation, and recycled water from the Orange County Sanitation District (OCSD) (Wehner, 2010). Starting in 2004 and completed in 2008, the OCWD upgraded their recharge system by superseding Water Factory 21 with the unveiling of a 70 MGD Groundwater Replenishment System (GWRS) – the world’s largest advanced water treatment system for potable reuse (**Figure A.2-1**).



Figure A.2-1. The world’s largest wastewater recycling system for indirect potable reuse (Photo Credit: Jim Kutzle, Orange County Water District, from GWRS, 2013)

During construction of the GWRS, the Interim Water Factory operated from 2004-2006 and produced 5 MGD of reclaimed water utilizing MF, RO, and UV-AOP with hydrogen peroxide (Wehner, 2010). This water was blended with 8 MGD imported water before being used for groundwater replenishment and seawater intrusion prevention. At the GWRS, influent water flows from the OCSD Plant 1 to the GWRS. After treatment, the GWRS pipelines initially distributed 35 MGD of purified reclaimed water from the OCWD’s facility located in Fountain Valley to groundwater recharge basins (Kraemer, Miller, and Miraloma) located

in Anaheim (**Figure A.2-2**). The purified water flows year-round through a 13-mile long pipeline before reaching and percolating through recharge basins that provide up to 75% of the drinking water supplied to the northern and central parts of the OCWD (OCWD, 2014). The other 35 MGD was pumped into the Talbert Gap seawater intrusion barrier injection wells. The plant completed an expansion to 100 MGD in 2015. The expansion included the addition of two 7.5 million gallon equalization tanks to help increase production due to limited availability of wastewater from OCSD Plant 1. The facility is planning a future expansion to 130 MGD and is evaluating alternatives for providing additional wastewater flows for both the current and expanded facility. At 70 MGD, the GWRS served approximately 600,000 people. With the completed expansion, the GWRS will produce enough water to sustain a population of 850,000 people (OCWD, 2014).



Figure A.2-2. Map of GWRS facilities, pipeline and recharge basins (Source: GWRS)

Treatment Type and Process Flow Block Diagram

The GWRS treatment process utilizes MF, RO, UV-AOP with hydrogen peroxide as part of the advanced purification process follow by decarbonation and lime addition (**Figure A.2-3**). The MF process has a 90% recovery rate at the GWRS; backwash from the process is sent to OCSD Plant 1 for treatment and returned to GWRS. Each MF cell experiences backwashing every 22 minutes to prevent high-pressure buildup (GWRS, 2013). Additionally, each microfiltration cell receives a full chemical cleaning every 21 days. The RO process has an 85% recovery rate and the resulting brine is distributed to the OCSD ocean outfall. MF and RO are followed by UV trains each consisting of six low pressure, high output UV reactors in series, each with 72 lamps. Following UV disinfection, the water is stabilized to pH levels between 8.5 and 9 by partial degasification and lime addition (GWRS, 2013).

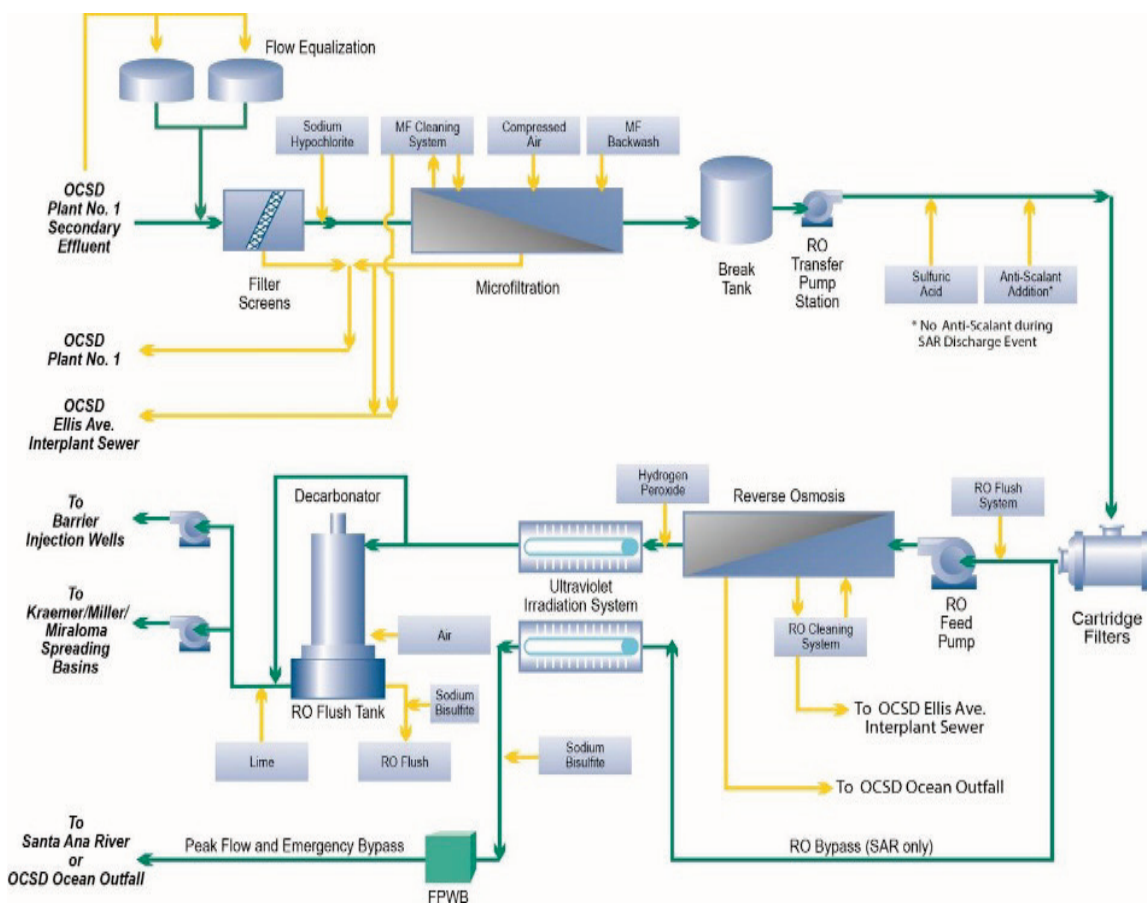

Figure A.2-3. Process Flow Diagram of Advanced Treatment at the GWRS (Source: GWRS, 2013)

The water quality of influent water to the GWRS and product water following the complete treatment process is summarized in Table A.2-1.

Table A.2-1. GWRS influent and effluent water quality

Water Quality Parameter	Influent Levels (mg/L)	Effluent Levels (mg/L)
TDS	1,000	<30
TOC	12-15	<0.30
Pharmaceuticals	-	Non-detect (<10 ng/L)

Permitting and Monitoring

Similar to the LVLAWTF/Alamitos Gap Barrier Injection project, the California Regional Water Quality Control Boards are responsible for regulatory oversight of potable reuse projects in Orange County, and to that extent, for all potable reuse projects in the State of California. The Regional Water Quality Boards issue permits for water recycling and the State Water Resource Control Board Division of Drinking Water (DDW) establishes the criteria used for water recycling. DDW (formerly the California Department of Public Health) recommendations were incorporated into the original reuse permit that was issued in 2004 after Water Factory 21 was out of commission and in the revised permit that was issued in 2015. The GWRS uses online sensors and supervisory control and data acquisition systems to monitor real-time performance of the treatment system. The RO process is monitored using measures of electrical conductivity (EC) and total organic carbon (TOC). Electrical conductivity is used to measure the concentration of total dissolved solids

whereas TOC is used to measure the level of organics in the product water, and therefore gauges removal levels. TOC also serves as a surrogate for pathogen reduction, allowing a 2-log pathogen credit to be granted across the RO system. The UV-AOP process is monitored using a UV transmittance online sensor and an additional sensor measuring UV power delivered.

Unique WWTP or WRF Permit Limits in the National Pollutant Discharge Elimination System (NPDES) Permit or Additional Permit

OCSD has a source control program that strives to limit pollution from drugs/medications or industrial chemicals, such as 1,4-dioxane, dumped into the source water. In addition to their source control program, the OCSD has implemented additional programs such as educational outreach programs, toxics inventory, and a pollutant ranking system in response to permit criteria set by DDW. The GWRS has received greater than 20 awards over the years, including the coveted 2014 Lee Kuan Yew Water Prize and the 2014 U.S. Water Prize (OCWD, 2014).

References

Groundwater Replenishment System Technical Brochure (GWRS). 2013. Fountain Valley, California.

Orange County Water District (OCWD). 2014. <http://www.ocwd.com>

U.S. Environmental Protection Agency (EPA). 2012. Guidelines for Water Reuse, EPA/600/R-12/618. Washington D.C.

Wehner, M. 2010. *Orange County's Groundwater Replenishment System – Potable Reuse for the Best Available Water*. PowerPoint Presentation. Tampa, Florida.

A.3 Gwinnett F. Wayne Hill Water Resources Center, Chattahoochee River and Lake Lanier Discharge - Indirect Potable Reuse

Denise Funk and Robert Harris, Gwinnett County
Darren Boykin, CDM Smith

Project Facts

Location	Gwinnett County, Georgia
Size	Phase I 20 MGD; Phase II 40 MGD; 60 MGD (total)
Year of Installation	Phase I opened in 2001; Phase II opened in 2006
Status	Operational
Cost	\$200 million initial plan construction, \$350 million plant expansion, \$72 million pipeline

Background

The F. Wayne Hill Water Resources Center (WRC), an advanced water reclamation facility, was initially constructed in 1999 on 700 acres of land located approximately 30 miles north of downtown Atlanta (**Figure A.3-1** and **Figure A.3-2**). The facility, which opened in 2001, currently receives influent wastewater (primarily residential) from numerous locations throughout Gwinnett County via six large force mains, three of which are used to divert flows from two other water reclamation facilities in the county. While the original Phase I 20 MGD WRC was in the midst of construction, population projections predicting rapid growth in Gwinnett County instigated the early design of a Phase II expansion to 60 MGD. Phase II design incorporated many technological improvements to the Phase I facility.

Initially, F. Wayne Hill WRC effluent was discharged to the Chattahoochee River through 20 miles of pipe from the plant. However, the facility was designed to discharge reclaimed water to Lake Lanier, a US Army Corps of Engineers (Corps) impoundment located on the Chattahoochee River. The \$72 million dollar, 9.5-mile pipeline extension to Lake Lanier started in 2008, and F. Wayne Hill WRC began discharging reclaimed water to Lake Lanier in 2010. Lake Lanier is the drinking water supply source for Gwinnett County and the Atlanta metropolitan region. Gwinnett County's Shoal Creek Filter Plant water intake is located less than one mile away from the F. Wayne Hill WRC discharge point within the lake.



Figure A.3-1. Aerial view of the F. Wayne Hill Water Resources Center

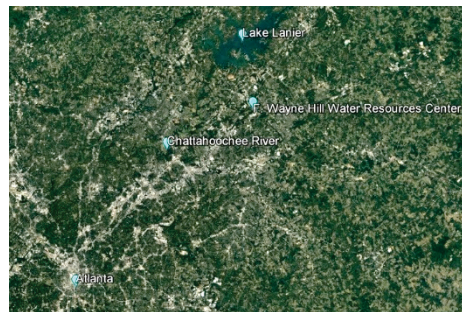

Figure A.3-2. Map of F. Wayne Hill Water Resources Center, Lake Lanier, Chattahoochee River, and Atlanta

Storage and Withdrawal Rights

In July 2, 1973, Gwinnett County entered into a “Contract between the United States of America and Gwinnett County, Georgia, for Withdrawal of Water from Lake Sidney Lanier,” administered by the Mobile District of the Corps and has since entered into several extensions and modifications to that agreement (collectively known as the “Contract”).

The Contract granted the county the right to withdraw raw water from Lake Lanier for municipal and industrial uses at a rate of 53 MGD. The Contract also permitted the county to construct and operate facilities to withdraw water and required the county to maintain certain records. The Contract originally provided that either party could terminate it upon providing three years advanced notice. Unless otherwise terminated, the Contract would continue for 30 years or until the Federal government completed its study of area water storage, discharge, and withdrawal needs. In June 1985, the Corps gave the county notice that the Contract would be terminated on July 1, 1989. In June 1989, the Contract was extended for six months. That historical contract is no longer in effect; but, the county has continued to withdraw and pay the Corps for water from Lake Lanier, which provides all of the county’s raw water. From 1990 to 2000, the county paid \$9.74 per million gallon (MG) for water withdrawn. In April 2000, the Corps increased this fee to \$18.80 per MG.

The use of storage in Lake Lanier for water supply has been under litigation since 1990. The multiple lawsuits in this litigation have been directed at the Corps. The litigation affects water supply for the entire region. Despite a favorable appeals ruling in July 2011, there is still uncertainty regarding the quantity of future supply that will be available. As of March 2012, the amount of Lake Lanier storage available for municipal and industrial use, and its corresponding yield, has not been determined. As a party to the litigation, Gwinnett County seeks to secure its water rights by obtaining storage contracts, as necessary, pursuant to past acts of Congress. Further Congressional action, which would remove any residual doubt regarding the use of Lake Lanier storage for water supply, is an alternative means of resolving the conflict.

The Corps has prepared an updated Water Control Manual for its dams in the Apalachicola-Chattahoochee-Flint (ACF) Basin. The outcome of the litigation will bear upon the Water Control Manual. While Gwinnett County will be engaged in this update through public participation channels, they plan to continue withdrawing water from Lake Lanier and to maximize return of highly treated flows from the F. Wayne Hill WRC.

Due to Gwinnett’s geographic location at the upper end of two water basins and the absence of any sizable or dependable groundwater aquifer source, Lake Lanier is currently the only viable source for Gwinnett County. However, the county will continue to explore additional water supply alternatives including the feasibility of including direct potable reuse (DPR) as a means of augmenting and diversifying its water rights and water supply portfolio for the long-range future.

Treatment Type and Process Flow Block Diagram

Gwinnett’s F. Wayne Hill WRC consists of primary and secondary biological treatment and two parallel trains of tertiary treatment to accomplish reliability utilizing the multi-barrier approach (**Figure A.3-3**). One of the two parallel trains includes chemical clarifiers and granular media filters, whereas the other consists of chemical clarifiers and ultrafiltration. Following the two treatment trains, water is blended prior to initial ozone disinfection, biologically active carbon filtration, and final ozone disinfection before being discharged via pipeline to Lake Lanier and the Chattahoochee River. The plant uses packed-tower wet scrubber technologies for odor control for its preliminary, primary and secondary treatment systems. The use of

ultrafiltration membranes for tertiary treatment makes the F. Wayne Hill WRC one of the world’s largest ultrafiltration plants.

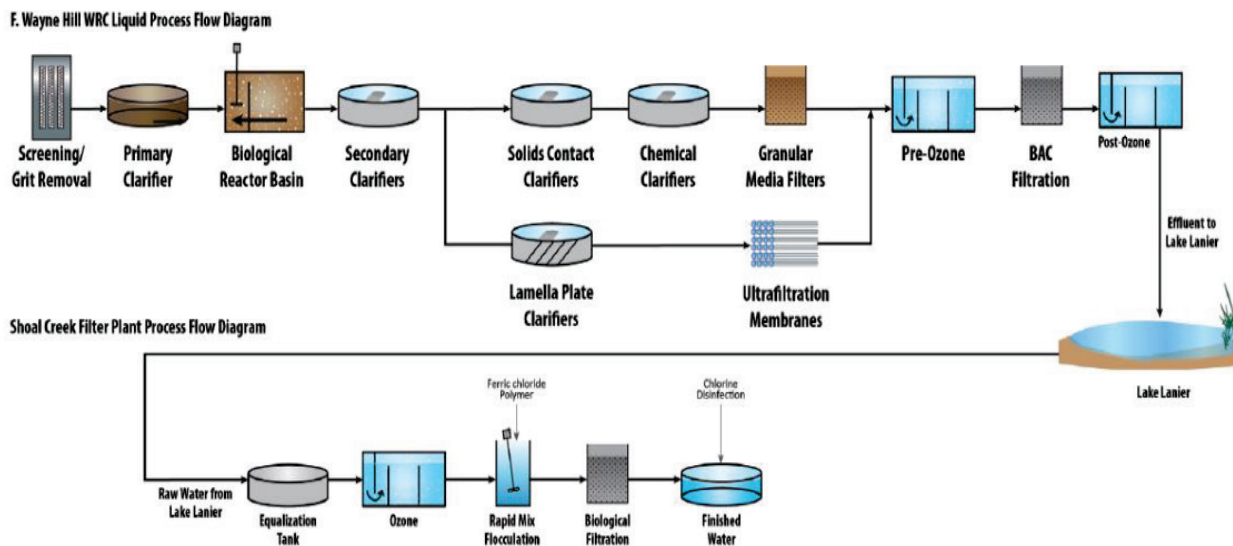

Figure A.3-3. Treatment process schematic of F. Wayne Hill Water Resources Center

Permitting and Monitoring

Lake Lanier and the F. Wayne Hill WRC are both monitored for conventional wastewater parameters such as ammonia, phosphorous, total suspended solids, pH, dissolved oxygen, chemical oxygen demand, and fecal coliforms. Total phosphorous influent concentrations average approximately 9 mg/L, and effluent standards are 0.08 mg/L. This criterion is low in comparison to other facilities; typical total phosphorus standards range between 0.13 – 0.5 mg/L. Lake Lanier is monitored in both upstream and downstream locations in proximity to the discharge outlet (Georgia EPD, 2014). The discharge from the reclamation facility is regulated under two NPDES permits; one permit for Lake Lanier, and one permit for F Wayne Hill WRC and Crooked Creek WRF combined discharge to the Chattahoochee River. Permit limits for Lake Lanier are outlined in **Table A.3-1**.

Table A.3-1. Water quality permit limits for FWH Discharge to Lake Lanier (Georgia EPD, 2014)

Water Quality Parameter	Permit Limit (monthly average)	2015 Annual Average Values	Units
Flow	40	33	MGD
Total Suspended Solids (TSS)	3	0.6	mg/L
Chemical Oxygen Demand (COD)	18	8	mg/L
Fecal Coliform	2	1	Count/100 mL
Turbidity	0.5	.12	NTU
Ammonia-Nitrogen	0.4	.07	mg/L
Total Phosphorous	0.08	.03	mg/L
Dissolved Oxygen (DO)	7.0 (minimum)	13.2	mg/L

References

Georgia Department of Natural Resources Environmental Protection Division (EPD). 2014. F. Wayne Hill Water Resources Center NPDES Permit No. GA0038130. Gwinnett County, Chattahoochee River Basin, GA.

A.4 Village of Cloudcroft PRe Water Project – Direct Potable Reuse

David Venable, Mayor, Village of Cloudcroft, NM
Eddie Livingston, P.E., Livingston Associates
Jillian Vandegrift, CDM Smith

Project Facts

Location	Cloudcroft, New Mexico
Size	0.1 MGD
Year of Installation	Anticipated in 2018
Status	Approved, 80 percent constructed, not online
Cost	\$3.5 million

Background

The Village of Cloudcroft, New Mexico resides at an elevation of 8,600 feet with a population of 750 people. As a mountain resort town, the population often increases during ski season weekends and holidays to approximately 2,000 people, resulting in an average water demand of 0.18 MGD and a peak water demand of up to 0.36 MGD. The town has historically relied on water from springs and wells, however drought conditions have resulted in low flows and have challenged water supply sources. In 2009, the local community approved the construction of an advanced water treatment facility with 0.1 MGD capacity to treat wastewater to drinking water standards.

When operational, the Cloudcroft direct potable reuse (DPR) project will be one of the first potable reuse project implemented in New Mexico. The project, termed “PRe Water,” is designed to double the water supply of this small community.

Conservation Efforts and Project Benefits

This project will help provide Cloudcroft with sufficient water for the next 40 years. For much of the time, the project will provide for all of the village’s water demands, including aquifer recharge, fighting forest fires, dust control, and construction. Additionally, the project will provide a clean and green energy efficient wastewater treatment plant (WWTP), reducing wastewater discharge and sludge handling loads to landfills. A photovoltaic (PV) electricity generating system will help to operate the water treatment facility; excess power not consumed by the facility will be resold to the Otero Electric Cooperative.

Regulatory Leadership

Because there are no potable reuse regulations in New Mexico, the New Mexico Environment Department (NMED) brought on the National Water Research Institute (NWRI) for regulatory assistance. NWRI assembled an Independent Advisory Panel (IAP) of local and national water quality and public health experts to review the Cloudcroft project and work with NMED regulators to develop potable water reuse regulatory guidance for Cloudcroft and future projects in New Mexico. The IAP concluded that, if properly monitored, operated, and maintained, the proposed DPR system in Cloudcroft is protective of public health

and should be permitted for operation. The detailed analysis of this project by the NWRI Expert Panel can be obtained from NWRI (NWRI, 2015).

DPR System

Wastewater from the local community will undergo multi-barrier treatment, blending with raw water, and additional water purification processes prior to being used for potable consumption and aquifer recharge. The project converts the existing trickling filter system at the WWTP (**Figure A.4-1**) to a membrane bioreactor (MBR) process (operational in 2017). Once the remaining construction is completed, the MBR permeate will be stored in an 80,000-gallon water storage tank at the WWTP site (**Figure A.4-2**), with a chloramine residual to minimize biofouling.



Figure A.4-1. Wastewater treatment plant

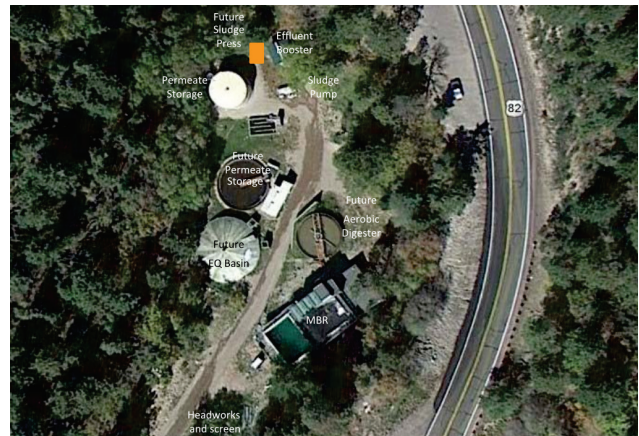

Figure A.4-2. WWTP site aerial view

Following storage, MBR permeate will be pumped a half-mile to another 80,000-gallon storage tank (**Figure A.4-2**), and will flow by gravity to the Water Purification Facility, five miles away. Using only the pressure resulting from gravity flow through the pipeline, the MBR permeate will pass through a RO system, followed by advanced oxidation using ultraviolet light (UV) and hydrogen peroxide, chlorination, and discharge into a 1 MG covered and lined reservoir (**Figure A.4-3**).



Figure A.4-3. PRe water pipeline from WWTP to water treatment facility (Courtesy of Eddie Livingston from Livingston Associates)

RO permeate will be blended with existing spring and groundwater at a blend ratio of approximately 50 percent. Up to 180,000 GPD (0.18 MGD) of the blended water will be treated utilizing ultrafiltration (UF),

UV disinfection, granular activated carbon (GAC), and final chlorine disinfection. After this treatment, the product water will be introduced into the village's water distribution system.

Concentrate resulting from the RO process, along with UF backwash water, will be stored in a 300,000-gallon open-top reservoir. This water will be put to beneficial uses such as gravel washing and dust control. There will also be the option to dispose of concentrate using deep-well injection, as illustrated in **Figure A.4-3**.

Purification Process Details

As previously stated, the Cloudcroft treatment train is a multiple barrier purification process: WWTP (MBR) → RO → UV/AOP with H₂O₂ → Chlorine disinfection → Storage and 50% Blending with spring water → UF → UV → GAC → Chlorine Disinfection → Distribution System (as shown in **Figure A.4-4**).

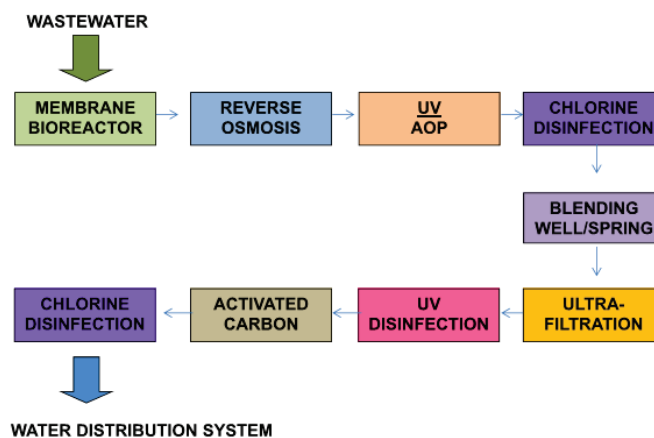

Figure A.4-4. Village of Cloudcroft PRe water treatment process flow schematic (Courtesy of Eddie Livingston from Livingston Associates)

The MBR has been designed for full nitrification-denitrification with a target five-day biochemical oxygen demand (BOD₅) of less than 5 mg/L and total nitrogen less than 1 mg/L. The gravity fed RO system will operate with a recovery between 75 and 80 percent and maximum feed pressure of 175 psi. The UV system utilizes a dose exceeding 500 mJ/cm² with a peroxide dose between 4 and 5 mg/L. Following UV, free chlorine contact will achieve additional disinfection.

Following blending, the UF system, which will be permitted as a drinking water system, will operate at a recovery of 90 to 95 percent and will include online integrity testing through pressure decay and turbidity. UV disinfection, following the UF, will achieve pathogen reduction with a target dose of 40 mJ/cm². The GAC will operate with an empty bed contact time of 10 minutes. A final free chlorine contact will achieve final disinfection.

DPR Microbial Log Removal Requirements

As designed, the series of multi-barrier treatment processes provides a robust barrier to pathogens and trace pollutants, based on criteria established by NMED and the IAP (Salveson, 2014; NWRI, 2015). **Table A.4-1** shows the pathogen log reduction values for the PRe Water project. The log reduction values achieved using these consecutive treatment processes exceed those as recommended by California for IPR and Texas for DPR (Salveson, 2014), although the methods used to calculate the credits differ from those used in the other states. One item worth noting is that the MBR used for pretreatment of the RO was

given considerably less *Cryptosporidium* and *Giardia* reduction credit than the UF and MF membranes used at advanced treatment facilities in California and Texas. This difference is attributed to the methods used for integrity monitoring in these systems rather than any inherent differences in the membranes. The UF membranes employed in the drinking water facilities at Cloudcroft received *Cryptosporidium* and *Giardia* credits similar to those in California and Texas.

Table A.4-1. Pathogen credits obtained from treatment process
(Source: Adapted from Salveson, 2014)

Treatment Process	Disinfection Credits		
	<i>Cryptosporidium</i>	<i>Giardia</i>	Enteric Viruses
Pathogen			
MBR	2	2	2
RO	1.5	1.5	1.5
UV	6	6	6
Free chlorine	0	1	4
UF	4	4	3
UV	4	4	0.5
GAC	0	0	0
Free chlorine	0	1	4
Total	17.5	19.5	21

References

Livingston, Eddie. 2015. Village of Cloudcroft PRe Water Project – Direct Potable Reuse.

NWRI. 2015. *Developing Proposed Direct Potable Reuse Operational Procedures and Guidelines for Cloudcroft, New Mexico*. NWRI IAP Report. September, 2015.

Salveson, Andrew. 2014. Visions in Potable Reuse: Research. *Research Solutions*. Spring 2014: 11-12.

A.5 Colorado River Municipal Water District Raw Water Production Facility Big Spring Plant - Direct Potable Reuse

John Grant, Colorado River Municipal Water District
Susan Crawford and Jillian Vandegrift, CDM Smith

Project Facts

Location	Big Spring, Texas
Size	1.8 MGD
Year of Installation	2013
Status	Operational
Cost	\$14 million

Background

This direct potable reuse (DPR) project is a Colorado River Municipal Water District (CRMWD) project providing water to the communities of Big Spring, Stanton, Midland, Odessa, and Snyder. The CRMWD's service area overlaps with the Chihuahuan desert to the west, thus water is always in short supply. In 2002, CRMWD began looking at ways to use sources of water that had not previously been considered for municipal water use. A reuse feasibility study was performed in 2005 that covered an analysis of municipal effluent quantity and quality, preliminary contact with regulators, costs, and a public outreach strategy, amongst other things (Sloan et al., 2010). Non-potable uses such as irrigation and industrial applications were considered, as well as indirect potable reuse (IPR); but, DPR was chosen partially due to poor expected performance from an environmental buffer located in the Permian Basin (Khan, 2013). Big Spring has very high levels of dissolved solids in their surface water, and dry air conditions cause high evaporation rates. For these reasons, IPR via discharge to surface water bodies proved infeasible and would likely result in a loss of product water (Sloan, 2013). Additionally, non-potable reuse tends to be seasonal and the opportunities for non-potable reuse in Big Spring were few and far between. Instead, CRMWD initiated a goal to "reclaim 100 percent of the water, 100 percent of the time" (Sloan et al. 2010). Pilot testing on the raw water production facility was completed in 2009 (Sloan et al., 2010). Refer to the previous Big Spring, TX case study in the 2012 *Guidelines* for further background and lessons learned (EPA, 2012).

In 2012, during a period of record drought throughout Texas, one of the reservoirs on the Colorado River, Lake Spence, which provides water to Big Spring, dropped to as low as 0.2 percent full (Sloan, 2013). Fortunately, in 2013 the 3.7 MGD Big Spring WWTP started to transfer 2.5 MGD of treated secondary effluent to a newly constructed raw water production facility (RWPF) that purifies the water to drinking water quality (**Figure A.5-1**).



Figure A.5-1. CRMWD raw water production facility (Source: TWDB, 2015)

Treatment Type and Process Flow Block Diagram

The conceptual treatment process for the Big Spring DPR scheme is illustrated in **Figure A.5-2**. Filtered secondary effluent from the Big Spring WWTP is transferred to a 1.8 MGD raw water production facility in which microfiltration (MF), RO, and UV-AOP using hydrogen peroxide treat the water to drinking water quality (**Figure A.5-3**). It should be noted that this simplified schematic does not show chemical feed facilities used at the existing water treatment plant, such as coagulant and disinfectant. The UV-oxidation treatment destroys low molecular weight compounds such as NDMA, which is a suspected carcinogenic compound (EPA, 2014). The UV-oxidation system achieves 1.2-log reduction of NDMA and 0.5-log reduction of 1,4-dioxane (Trojan UV, 2012). The CRMWD RWPF product water is then blended with CRMWDs raw water supply before being treated by the Big Spring, Stanton, Midland, Odessa, and at times Snyder conventional water treatment plants. The water treatment plants use rapid mix, flocculation, sedimentation, media filtration, and disinfection methods. Recycled water constitutes approximately 15-20 percent of the total blended water volume.

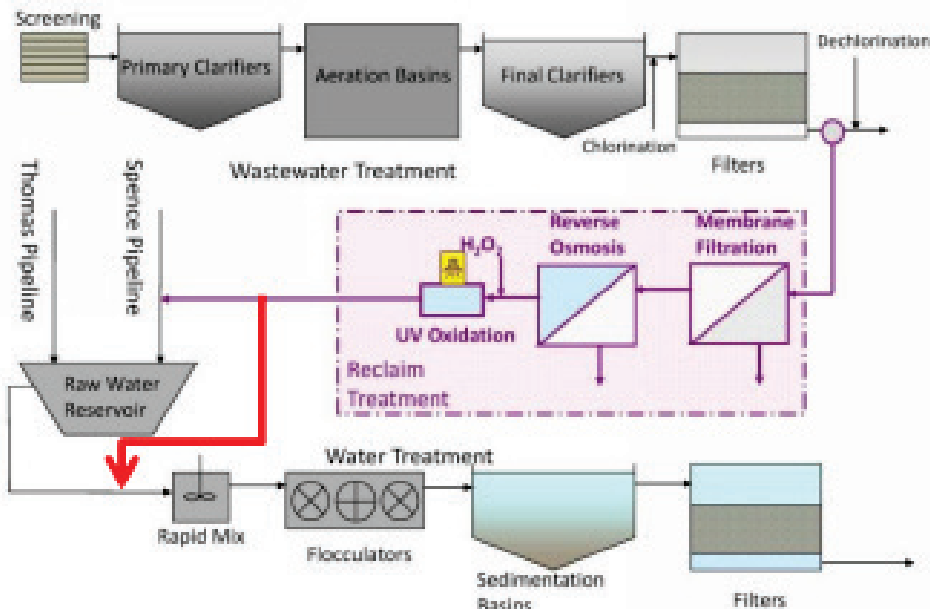

Figure A.5-2. Big Spring DPR conceptual schematic (Source: Sloan et al. 2010)

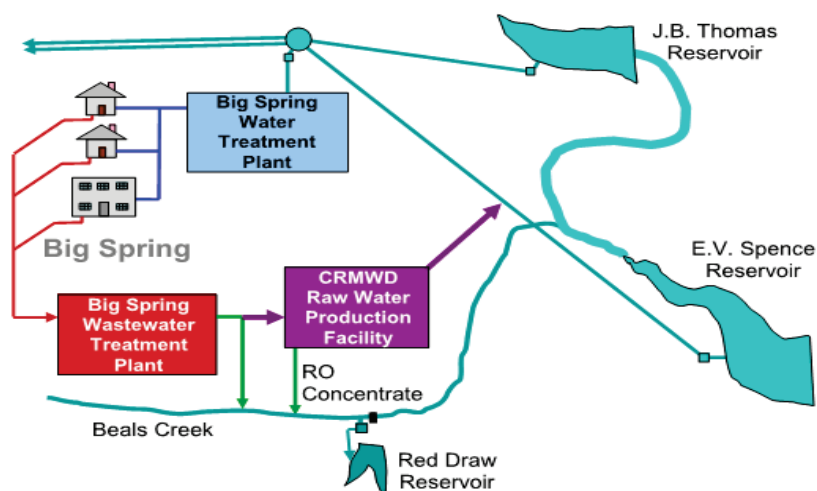

Figure A.5-3. Treatment flow diagram representing City of Big Spring WWTP, CRMWDs RWPF, and Individual Water Treatment Process for Individual Customers (Source: CRMWD)

Energy

In total, Big Spring water reclamation uses 5.34 kWh/1000 gallons for membrane treatment, UV oxidation, and source water and product water pumping collectively (Sloan, 2013). This is only slightly higher than the energy required to bring water to Big Spring from Lake Spence and to divert water from Beal's Creek so it does not enter the Colorado River, totaling approximately 5.04 kWh/1000 gallons. Comparing the two energy requirements illustrates an important concept; the energy avoided from raw water pumping to Big Spring is more or less equal to treating municipal wastewater effluent to drinking water quality (Sloan et al., 2010).

Disposal

Concentrate from the RO process is discharged to Beal's Creek under a permit obtained by CRMWD. Beal's Creek is a naturally brackish stream. CRMWD operates a brackish water system to divert low flow, high chloride water with an off-channel reservoir, where water is stored before being sold to oil companies or evaporated (Sloan et al. 2010). Membrane filtration backwashing waste is directed to the head of the WWTP, where it then flows through the treatment process instead of disposing of the waste elsewhere off-site (Sloan et al., 2010).

Permitting and Monitoring

As with other Texas potable reuse projects and in the absence of state enforced potable reuse guidelines, Texas Commission on Environmental Quality (TCEQ) reviewed the project proposal in accordance with its case-by-case exception approval process. The letter that grants the exception, which functions as a permit for the facility, includes requirements on treatment, design, operation, and monitoring. Subsequent to pilot testing, TCEQ set water quality requirements for the system which is permitted to produce raw water for municipal and industrial use. The original requirement for source water to the RWPF was to achieve turbidity levels less than 10 NTU and a 4-log reduction of virus through the RWPF. Furthermore, the

blending percentage, initially limited to 20 percent reclaimed water, was later amended to allow up to 50 percent reclaimed water.

The raw water production facility underwent an intensive period of testing in January 2013 in which regulated drinking water contaminants, secondary contaminants, unregulated radionuclides, and unregulated trace chemical constituents were monitored and documented. TCEQ required the following other regulatory actions before project implementation: concentrate discharge permit, reclaimed water use authorization (from TCEQ reuse group), industrial pretreatment permit (for membrane filtration backwash), a membrane pilot study, and a plan and specification review. One of the major stresses when planning potable reuse projects, beyond the public perception, has been operator certification and training. As mentioned in the Wichita Falls case study, TCEQ places significant emphasis on the ability of the plant operators to manage all processes and mitigate when necessary. One of the TCEQ requirements was that the facility must be under the supervision of a Class B licensed operator (Sloan, 2013).

Between November 2013 and May 2015, the RWPF underwent a detailed, independent operational and water quality evaluation conducted on behalf of the Texas Water Development Board, which concluded that "the RWPF produces water of very high quality [which is] more than sufficient to serve as a raw water source" (Steinle-Darling et al., 2016).

References

- Khan, S. 2013. *Drinking Water Through Recycling: The Benefits and Costs of Supplying Direct to the Distribution System*. Report of the Australian Academy of Technological Sciences and Engineering, funded by the Australian Water Recycling Centre of Excellence through the Commonwealth Government's Water for the Future initiative.
- Sloan, D.; Wingert, C.; Cadena, I. 2010. *Potable Reuse in the Permian Basin*. Accessed on September 28, 2017 from <https://www.freese.com/sites/default/files/Potable%20Reuse%20in%20the%20Permian%20Basin.pdf>.
- Sloan, D. 2013. *Direct Raw Water Blending in Big Spring*. 2013 Direct Potable Reuse Specialty Conference Presentation.
- Steinle-Darling, E., A. Salvesson, J. Sutherland, E. Dickenson, D. Hokanson, S. Trussell, and B. Stanford, 2016, *Direct Potable Reuse Monitoring, Final Report to the Texas Water Development Board* under contract no. 1348321632, co-funded by Water Environment and Reuse Foundation under Tailored Collaboration No. 14-10, December, 2016.
- Trojan UV Solutions. 2012. *UV Oxidation-Raw Water Production Facility (RWPF) Big Spring, Texas*. Accessed on September 28, 2017 from http://www.trojanuv.com/resources/trojanuv/casestudies/ECT/Direct_Potable_Reuse_Big_Spring_Texas_Case_Study.pdf.
- TWDB. *Water Reuse*. Retrieved January 2015 from <http://www.twdb.texas.gov/innovativewater/reuse/>.
- U.S. Environmental Protection Agency (EPA). 2012. Guidelines for Water Reuse, EPA/600/R-12/618. Washington D.C.
- U.S. Environmental Protection Agency (EPA). 2014. Technical Fact Sheet-N-Nitroso-dimethylamine (NDMA). Office of Solid Waste and Emergency Response. EPA 505-F-14-005.

A.6 Wichita Falls River Road WWTP and Cypress WTP Permanent IPR and Emergency DPR Project

Daniel Nix and Russell Schreiber, City of Wichita Falls

Project Facts

Location	Wichita Falls, Texas
Size	DPR: 5 MGD; IPR: 16 MGD
Year of Installation	DPR: 2014; IPR: potentially 2018
Status	DPR: Decommissioned; IPR: Planning stages
Cost	DPR: \$13 million; IPR: projected \$33.5 million

Background

Lake Arrowhead and Lake Kickapoo are the main surface water supplies for the City of Wichita Falls, Texas. During 2013, both lakes were less than 35 percent full (**Figure A.6-1**), sending Wichita Falls into extreme drought conditions with no readily available water supply solution (Khan, 2013).



Figure A.6-1. Lake Arrowhead levels in 2013 (Photo credit: Daniel Nix)

By May 2014, Wichita Falls declared a Stage 5 drought. Wichita Falls, however, proactively began investigating the possibility of implementing a DPR project following the drought of 1995-2000 during which they supplemented their drinking water supply with highly saline water from Lake Kemp and Lake Diversion (Dahl, 2014). By using microfiltration (MF) and RO, they were able to integrate the treated saline lake water with the existing potable water supply. Wichita Falls Public Works Department was confident they could do the same with municipal wastewater when faced with the most recent drought conditions. In 2012, recognizing the city would be out of water by 2014 without further action, Wichita Falls drafted a two-phase project plan involving both a permanent IPR scheme and an emergency temporary DPR scheme.

Conservation Efforts

By December 2014, staged water conservation efforts saved up to 6.1 billion gallons of water (about 1.5 years' supply). Stage 5 drought restrictions had lowered the average summer usage by 65 percent. Nonetheless, conservation alone was insufficient to sustain a reliable drinking water supply (Nix, 2014).

Emergency (short-term) DPR System

The DPR scheme was implemented because drought conditions led to severe and abrupt drinking water needs for the City of Wichita Falls, with lake levels well below the 40 percent considered to be an emergency. The emergency DPR project began operating online on July 9, 2014 after only 27 months of design, permitting, and construction. The city expected the temporary DPR system to remain in operation for 2-2.5 years, at which time the permanent IPR system would come online. Due to significant rainfall, the DPR project was decommissioned on July 21, 2015.

A unique context in Wichita Falls was that the city already had an MF/RO plant that treated the Lake Kemp water. This MF/RO system was scheduled to be taken offline because the salinity in Lake Kemp had increased dramatically (going from the normal 2500 ppm total dissolved solids (TDS) to 8000 ppm TDS). The Lake Kemp MF/RO system could not successfully treat this higher TDS water. Reusing the facility kept costs and time down because design and construction of a new membrane plant was not needed.

The DPR system transferred treated effluent from the River Road WWTP to the Cypress water treatment plant (WTP) through 13 miles of pipe that were laid in 3 months – all above ground. The pipeline was sized for the future permanent IPR system and will be reused. By laying the pipeline through the city's flood control channels, the city did not face any right of way issues.

At the Cypress WTP, the treated effluent was purified through MF and RO. A disinfection-dose UV system was added after six months of operation. The UV dose employed targeted pathogen inactivation, but was not designed to address unregulated constituents, such as n-nitrosodimethylamine (NDMA), or provide advanced oxidation. The advanced-treated water was then blended at a 1:1 ratio with raw, untreated Lake Arrowhead water and subsequently treated at a conventional WTP, followed by holding in an engineered storage buffer for 24 hours before being sent to the distribution system. The process created an additional 5 MGD (up to 50 percent of daily demand) of municipal drinking water. 2.5 MGD of brine from the MF and RO processes was discharged to the Big Wichita River under the discharge permit acquired for the Lake Kemp operation (**Figures A.6-2 A and B**) (Nix, 2014).



Figure A.6-2 A. RO permeate
(Photo credit: City of Wichita Falls)



Figure A.6-2 B. RO modules
(Photo credit: City of Wichita Falls)

Permanent (long-term) IPR system

The IPR project will use the existing 13-mile pipeline constructed for the DPR project to complete the 15-mile pipeline from River Road WWTP to Lake Arrowhead. Wichita Falls has received a new discharge permit from TCEQ for the permanent IPR installation. The IPR project will ultimately pipe up to 16 MGD of advanced treated (i.e., tertiary) effluent from River Road WWTP back to Lake Arrowhead, which will serve as an environmental buffer, before the water is treated at the city’s conventional WTPs and distributed to customers. River Road WWTP will be retrofitted with a new phosphorous reduction process, tertiary filtration processes, and a new pump station using loan money to fund the upgrades (Ingle, 2014).

Treatment Process

DPR

WWTP → Pipeline (including chloramine disinfectant down the pipeline) → WTP (MF → RO → UV) → Holding Lagoon (engineered storage buffer) → Blending 50-50 → Conventional WTP (chlorine dioxide pre-disinfection, chloramine primary disinfection, coagulation, lime, sedimentation, gravity media filtration, fluoridation, chloramine terminal disinfection) → Storage (engineered storage buffer) (Figure A.6-3)

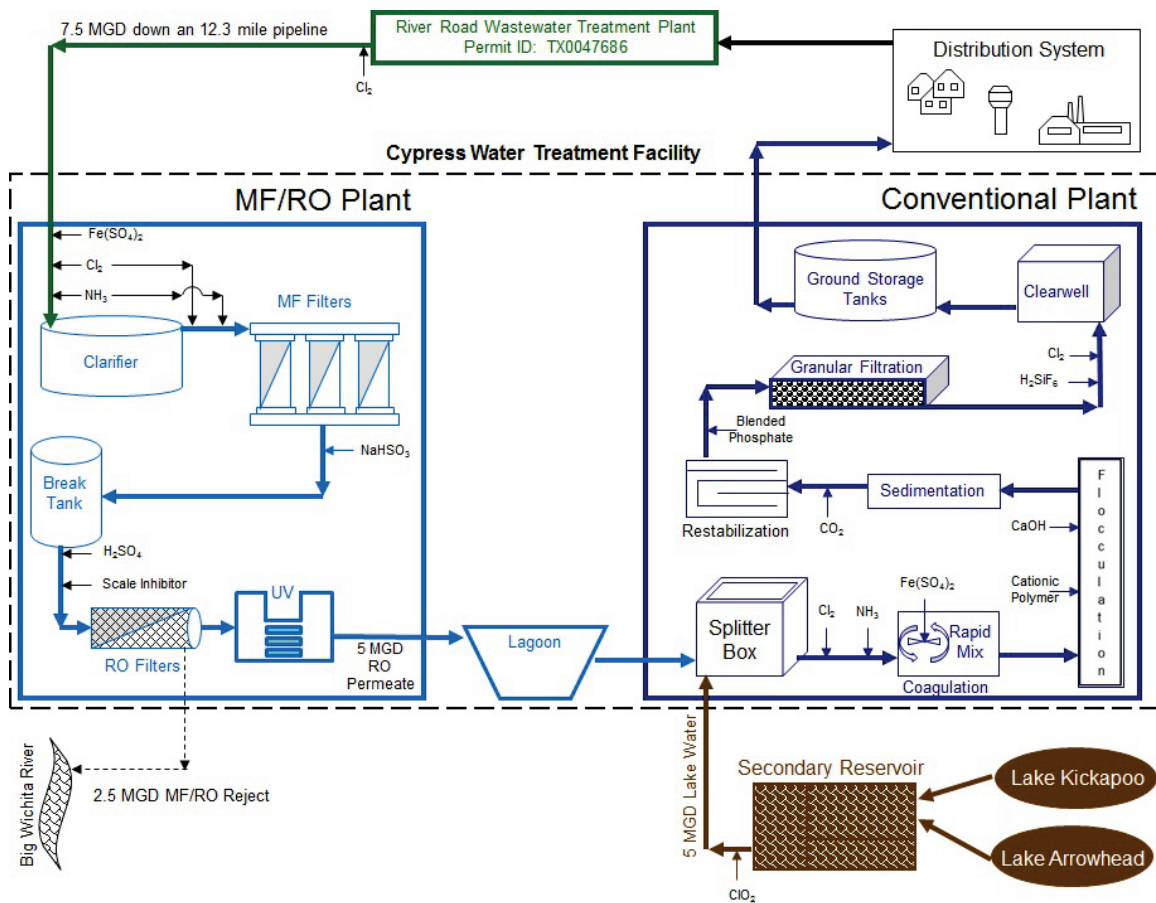

Figure A.6-3. Emergency DPR treatment process flow diagram (Source: Daniel Nix)

IPR

River Road WWTP (upgrades will include chemical phosphorus reduction with filters and new re-aeration) → Effluent Pump station and pipeline → Lake Arrowhead (environmental storage buffer) → Conventional WTP.

Collaboration between TCEQ and City

Although there are no IPR or DPR regulations currently implemented in Texas, TCEQ reviews submitted project proposals individually and grants approval and discharge permits on a case-by-case basis. TCEQ approved the Wichita Falls DPR scheme after reviewing the DPR project proposal and the proposed long-term IPR system solution. Since there are no regulatory guidelines for DPR in Texas, TCEQ and the City of Wichita Falls Public Works Department collaboratively discussed the necessary treatment requirements and effluent limitations.

DPR Permitting Process

The city worked with TCEQ for the first 9 months of 2013 to discuss how to operate the plant and received the approval to build the pipeline towards the end of 2013. Following the completion of the DPR system installation in December 2013, TCEQ worked with the city on carrying out an intense 45-day testing period, followed by 30 additional days of testing. During this full-scale verification testing, TCEQ staff spent time onsite understanding how the plant was operating and observing the lab operations. Based on the results from these full-scale verification test periods, TCEQ approved a permit on June 28, 2014 which allowed six months of operation. TCEQ has subsequently extended the permit based on excellent operation but required the addition of UV after the initial six months of operation.

DPR Microbial Log Removal Requirements

TCEQ used the Surface Water Treatment Rules (SWTRs) as the basis for assigning log removal requirements. However, to be more conservative than required by the SWTRs, rather than using a 24-sample average concentration as the basis for assigning log removal requirements, they took the maximum concentration ever observed, and applied this standard to viruses, *Giardia*, and *Cryptosporidium*, rather than only *Cryptosporidium* as required by the SWTRs.

The DPR process is required to achieve 9-log virus removal, 8-log *Giardia* removal, and 5.5-log *Cryptosporidium* removal as specified by TCEQ. Initially, TCEQ had required 8-log virus removal but increased it to 9-log because chloramines were pre-forming at the wastewater plant, and therefore TCEQ felt that there would not be as much free chlorine disinfection occurring. Likewise, TCEQ initially required a lower *Giardia* removal target (6-log) but increased it to 8-log removal required after continuous effluent monitoring indicated higher concentrations of *Giardia* could be present in the treated wastewater than the maximum concentration observed previously. These adjustments show the adaptability on the part of TCEQ to changing conditions and the open communication between the regulators and the city with the common goal of protecting public health.

Because no daily integrity test has been demonstrated to the satisfaction of the TCEQ to date for RO, it does not give microbial log removal credits for the DPR RO elements. As a result, other employed treatment methods must successfully achieve the log removal requirements.

IPR Permitting Process

TCEQ approved the permit for the IPR system in Fall 2014 which allowed the city to go forward with design. The system is funded with a \$33.5 million loan through the Texas Water Development Board and the Clean Water Act State Revolving Fund. The city is in the midst of a required archaeological investigation along the pipeline route and the design process and expects to have the permanent IPR system online and upgrades to the River Road WWTP complete by 2018.

DPR System Monitoring

The city worked with TCEQ in a collaborative process to decide upon 42 monitoring locations and requirements within the DPR system to ensure public health was protected and off-speculation drinking water was prohibited from entering the distribution system (**Figure A.6-4**). The range of chemical and microbial constituents required for monitoring of the temporary DPR scheme were similar to the current Safe Drinking Water Act (SDWA) requirements. Constituents in the SDWA were monitored in the wastewater effluent, RO permeate before blending, lake water, and at the end of the conventional WTP.

TCEQ required bi-weekly monitoring of *Cryptosporidium*, *Giardia*, and total culturable viruses using standard methods. A polymerase chain reaction (PCR) based method was also tried for *Cryptosporidium* and *Giardia* during verification testing but was removed from the monitoring requirements because PCR results were difficult to interpret. Other monitoring parameters included *E. coli* (daily); full metal scans; algal counts; inorganic, organic, radioactive, and secondary chemicals specified under Texas drinking water codes; and disinfection by-products. The city monitored unit processes to ensure that the required microbial log removals are being met. For example, every eight hours, log removal credits for each disinfection zone were calculated based on disinfectant concentration and contact time. The log removal values were entered into a table with values from other unit processes and an overall observed log removal was tabulated. The DPR process regularly provided a calculated 25-log removal for viruses and 16-log removal for *Giardia* (compared to the 9- and 7-log removal requirements, respectively).

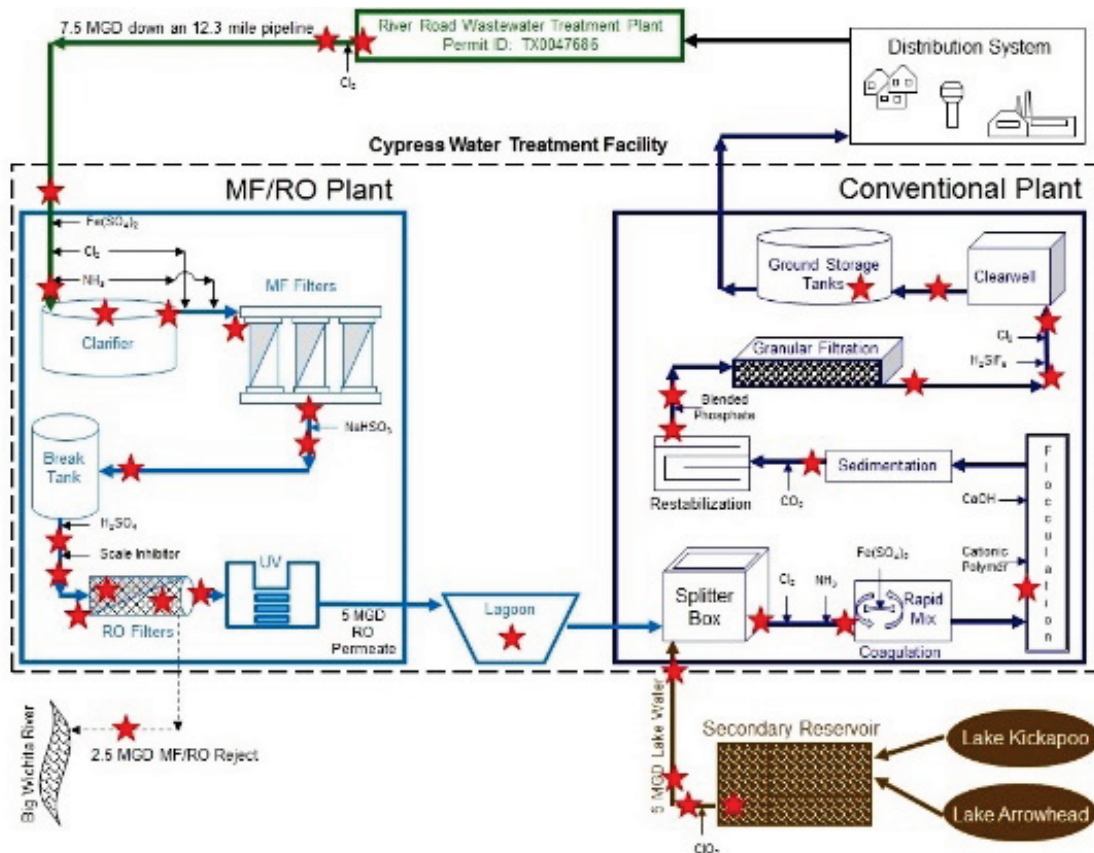

Figure A.6-4. Water quality monitoring locations in Emergency DPR Project (Source: Daniel Nix)

Operator Certification

The City of Wichita Falls has historically produced high-quality drinking water, and prides itself on its plant operator certification system. Wichita Falls plant operators must be certified by the State of Texas and continue training throughout their career lifetime. They can achieve certification levels A through D, A being the highest achievable level. Operators must be recertified every three years (City of Wichita Falls, 2014a). In total, the City of Wichita Falls has five class A operators, 19 class B operators, and 11 class C operators (City of Wichita Falls, 2014).

Because there are no specific regulations regarding operator certification for reuse, Wichita Falls implemented two additional requirements for its operators. First, water operators are required to tour the wastewater plant, so they would understand the wastewater treatment processes. Second, water operators are required to take basic wastewater, wastewater treatment, and waterborne pathogens classes. Likewise, wastewater operators are required to tour the water treatment plant and take basic water, surface water, and waterborne pathogens classes. There is currently an ongoing effort to determine and begin a certified DPR operator program in Texas.

Collaboration between the County Public Health Department and the City's Public Works Department

The city had an existing local water quality task force that was established in 1997 in response to the Milwaukee *Cryptosporidium* outbreak. The task force is made up of members of the City's Public Works Department and the City/County Public Health Department. The task force has met regularly and has established protocols for what action and communication is required in the case of unexpected process upsets or disease outbreaks observed in the population. TCEQ has attended one of the task force meetings to observe how information and data are exchanged. This relationship is unique and helps to guarantee public health safety.

Leadership

The Director of the City's Public Works Department and the Utilities Operations Manager were trailblazers with DPR. However, they also felt that the science was already proven and there was nothing innovative technically – all of the components had been previously studied for four decades or more. Wichita Falls simply did extensive research to assemble and digest published literature from the U.S., Australia, Europe, and Japan, and then put the pieces together.

Public Outreach

Public outreach techniques were used to educate doctors, professors of environmental science and chemistry, and the general public (Dahl, 2014). Ensuring the community was comfortable with the potable reuse concept immensely helped the project's evolution. The leadership of the Public Works Department feels that the DPR and IPR projects have been 100 percent transparent with the citizens and that they could not have succeeded without the support of the community.

Public Perception

City and state officials did not receive any complaint calls regarding taste during DPR operations. In fact, some residents felt the water tasted better since the DPR scheme was brought online.

The Public Works Department monitored bottled water sales at the three large Walmart retailers in town. Water bottle sales increased by about 9 percent after DPR was brought online, indicating that some residents may have switched from tap water to bottled water for drinking; but the majority of the population

did not begin buying bottled water. City residents have embraced their place in history as a leader in DPR (Figure A.6-5).



Figure A.6-5. T-shirts sold in Wichita Falls touting DPR (Photo credit: F5 Concepts, Inc.)

References

City of Wichita Falls. 2014. *Wichita Falls Direct Potable Reuse Project: Complete Detail*. Retrieved December 2014 from <http://www.wichitafallstx.gov/DocumentCenter/View/21987>.

Dahl, R. 2014. "Advanced Thinking: Potable Reuse Strategies Gain Traction." *Environmental Health Perspective*. 122(12): A332–A335. Published online Dec 1, 2014. doi: 10.1289/ehp.122-A332

Ingle, John. 2014. 'Water board approves Wichita Falls loan'. Wichita Falls Times Record News.

Khan, S. 2013. *Drinking Water Through Recycling: The Benefits and Costs of Supplying Direct to the Distribution System*, Report of the Australian Academy of Technological Sciences and Engineering, funded by the Australian Water Recycling Centre of Excellence through the Commonwealth Government's Water for the Future initiative.

Nix, D. 2014. *City of Wichita Falls Water Conservation and Emergency Direct Potable Reuse*. PowerPoint Presentation at North Central Texas American Water Works Association Meeting.

A.7 Potable Water Reuse in the Occoquan Watershed

Robert W. Angelotti, Upper Occoquan Service Authority
Thomas J. Grizzard, PhD, P.E., Virginia Tech

Project Facts

Location	Fairfax, Virginia
Size	54 MGD
Year of Installation	Initial (1978): 15 MGD; 1987: 27 MGD; 1993: 32 MGD; 2003: 54 MGD
Status	Operational
Cost	Replacement value of owned infrastructure exceeds \$0.5 billion

Background

The Occoquan Reservoir is a critical component of the water supply for approximately 1.8 million residents of Northern Virginia, a highly-urbanized region located west of Washington, D.C. **Figure A.7-1** shows an aerial photo of the Occoquan Reservoir above the dam in the vicinity of the raw potable water plant intakes. Reclaimed water from the reservoir represents a significant supplement to potable water supply yield and has been successfully augmenting the drinking water supply for nearly four decades.



**Figure A.7-1. Aerial view of the Occoquan Reservoir
(Photo Credit: Roger Snyder, Manassas, Virginia)**

Rapid transformation from a largely rural to a predominantly urban/suburban region began in the 1960s as a result of unprecedented growth from the westward expansion of the urban core of Washington, D.C. By the mid-1960s, this urbanization was adversely affecting water quality of the Occoquan Reservoir, resulting in an unplanned and unintended indirect potable reuse scenario, where 11 small wastewater treatment plants were discharging effluent upstream of the reservoir. Poorly treated wastewater with urban and agricultural runoff threatened the continued use of the Occoquan Reservoir for public water supply.

In 1971, the Virginia State Water Control Board (VDEQ) and the Virginia Department of Health (VDH) adopted a plan to protect the Occoquan Reservoir as a drinking water supply. The Occoquan Policy mandated a newly conceived framework for water reuse and set in motion the first planned and intentional

use of reclaimed water for supplementing a potable surface water supply in the United States (EPA, 2012).

The Occoquan Policy mandated the creation of a regional state authority, the Upper Occoquan Service Authority (UOSA), to provide collection and reclamation of wastewater, and the Occoquan Watershed Monitoring Program (OWMP) to continuously monitor the watershed and reservoir, provide independent water quality assessments, and provide advice on protective measures for the reservoir. By the 1970s, Fairfax Water was responsible for potable water production and distribution for much of Northern Virginia. The VDEQ and VDH were also highly involved in developing the ultimate solution.

While water quality improvement was the primary driver for implementing planned and intentional potable water reuse in the Occoquan system, supplementing the raw water supply was always an underlying objective. Although the mid-Atlantic region of the United States is not considered dry or arid, the population density results in stressed water supply and limited per capita water availability. This situation becomes more pronounced during periodic extended drought conditions.

Treatment Type and Process Flow Block Diagram

A diagram illustrating how the UOSA reclamation system interacts with the drinking water supply is provided in **Figure A.7-2**. The UOSA reclamation plant produces about 35 MGD (1535 L/s) of water on an annual average basis, and the plant has the capacity to reclaim as much as 54 MGD (2,365 L/s). A future plant flow of around 65 MGD is projected for the build out condition of the UOSA service area. Future reclaimed water production is anticipated to effectively double the safe yield of the Occoquan Reservoir. Although the majority of water produced supplements the drinking water supply, an additional 1 to 3 MGD (44 to 131 L/s) is delivered for non-potable uses on the UOSA campus.

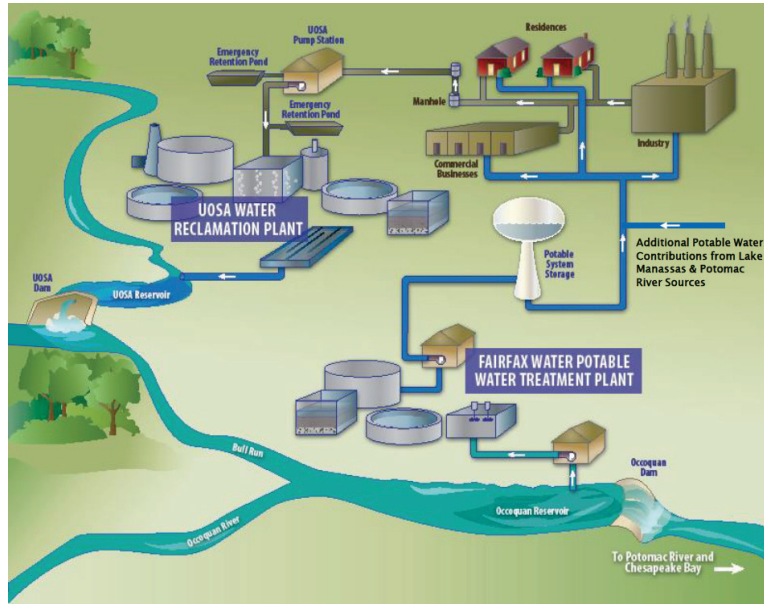

Figure A.7-2. The UOSA Reclamation Plant provides an important source of water for the service area (Schematic credit: CDM Smith for UOSA)

Water reclamation at UOSA employs a multi-barrier approach to treatment, includes large volumes of engineered storage, and incorporates a high-level of redundant and resilient features designed to deal with plant, local, or regional failures. The water reclamation process includes preliminary and primary treatment followed by complete mixed activated sludge with biological nitrogen removal. Advanced

ensure that sufficient monitoring and reclaimed potable water treatment has occurred and that water quality and plant performance continuously meets expectations.

Table A.7-1. Examples of UOSA's product water requirements (source: Occoquan Policy)

Water Quality Parameter	Product Water Requirement Concentration (Monthly Average)
COD (mg/L)	< 10
Total Suspended Solids (mg/L)	< 1
Nitrogen (TKN) (mg/L)	< 1
Phosphorous (mg/L)	< 0.1
Turbidity (NTU)	< 0.5
Total Coliforms (CFU/100 mL)	< 2

Water produced at the UOSA plant meets all federal primary and secondary drinking water standards with exceptions for nitrate and occasionally TDS. Seasonally, the nitrate drinking water standard is exceeded purposefully to accomplish specific reservoir water quality goals to retard the release of undesirable contaminants from the hypolimnion when the reservoir is thermally stratified. TDS above the secondary drinking water standard may occur during prolonged periods of dry weather. Historically, this has not been a significant issue because dilution occurs downstream after UOSA's product water is blended with the native reservoir source waters (which contains a much lower TDS concentration).

Unregulated Compounds and Voluntary Monitoring

The potable reuse scenario implemented within the Occoquan Watershed applies a multiple barrier approach to deal with trace organic compounds. The first barrier to such contaminants is a source control program that builds upon the framework offered by the Federal Pretreatment Program for publicly owned treatment works (POTWs). UOSA's source control program emphasizes the need to protect its product water for beneficial use as a supplement to the local potable water source. This important aspect is considered when issuing pretreatment permits to significant industrial users. There are a host of additional barriers that further ensure that the potable water is safe for end users. These are listed below.

1. Biological degradation and transformation - suspended growth activated sludge at long solids retention time with nitrification and denitrification followed by two stages of bio-filtration at the UOSA facility. Further biological treatment occurs through natural bio-decay in the environmental buffer and finally further degradation occurs in ozone enhanced bio-filtration at the potable water treatment plant.
2. Solids partitioning and absorption - onto biologically and chemically flocculated solids at the UOSA facility, in stream and reservoir portions of the environmental buffer and through the flocculation and settling stages of the potable water treatment plant.
3. Volatilization – via extended aeration at the UOSA facility and in the free-flowing stream portions of the environmental buffer.
4. Hydrolysis – occurs at high pH through the lime treatment portion of the UOSA facility.
5. Physical/chemical adsorption - onto granular activated carbon at both the UOSA and potable water treatment facilities.
6. Oxidation - by free chlorine at the UOSA and Fairfax Water facilities and again by ozone at the drinking water plant.

7. UV photolysis - in open storage tanks at the UOSA facility, in the reservoir and again at the drinking water plant.

A significant amount of voluntary monitoring is performed to confirm that the water produced is safe for use by the community. UOSA typically monitors for selected microbial pathogens and around 300 unregulated compounds in its finished product water at least annually. The watershed program monitors for trace organic compounds in the reservoir water column, sediments, and fish tissue at several reservoir monitoring stations on a biannual or quarterly basis. Raw source and finished drinking waters are analyzed quarterly for unregulated compounds and results are posted publicly on the internet. Bioassays are used to demonstrate that the product water yields no toxic, estrogenic, or other undesirable biological outcomes. Years of accumulated data support the conclusion that there is no significant increased risk to public health that results from supplementing the reservoir water supply with the reclaimed water product.

Management Practices and Institutional Considerations

Today, the concept of indirect potable reuse is well-communicated to regulators and public official stakeholders within the region. Interested parties within local municipalities are aware that a significant portion of the water supply is comprised of reclaimed water. Both Fairfax Water and UOSA are run by a board of directors. Board members are representatives for their community and make decisions in the best interest of the communities they serve. It is not uncommon for UOSA to collaborate closely with representatives of local governments about issues relating to water quality.

The community and the independent water quality monitoring entity, OWMP, both openly acknowledge that the reclaimed water produced by UOSA is the most reliable and highest quality water entering the Occoquan Reservoir. The OWMP has a technical advisory panel that is comprised of members from EPA, VDEQ, VDH, and an expert from an accredited and well-renowned academic institution within the state (Virginia Polytechnic Institute and State University, otherwise known as Virginia Tech). This provides even greater confidence and credence for potable reuse in the region.

Periodically, water related issues within the region result in the formation of technical advisory groups, citizen action committees, and task forces. These may be composed of agency stakeholders, city or county government officials, community representatives, water experts, and interested citizens. Examples of issues tackled by such groups include the following: land zoning around the reservoir to protect water quality, siting of a major semiconductor industry within the UOSA service area, and consumptive use of reclaimed water by a proposed power plant. These collaborative efforts with interested and affected parties are used to gather input before important decisions are made that might impact water quality or its availability to users.

Cultural and Social Considerations

When water reclamation was first proposed, a number of hearings were conducted to explain what was to be implemented and to provide the public a venue to express their views. UOSA has always engaged in an active program to provide tours to local students, from grade school through college, during which potable reuse is thoroughly explained. These tours have been conducted for nearly 40 years, providing public outreach to the local population on the importance of UOSA's mission. In addition, UOSA maintains a public website where its role in potable water reuse is clearly expressed. UOSA's success has not required dedicated public relations staff or a formal public outreach and communication program.

Successes and Lessons Learned

Perhaps the greatest key to success of this project is that it was implemented specifically to improve water quality problems in the existing surface water reservoir being used as the drinking water supply. The project was initiated by the Commonwealth of Virginia via state regulation (the Occoquan Policy) that was developed by the VDEQ and VDH. Early water quality problems in the Occoquan Reservoir were clearly articulated, and the best solution for the region was presented to stakeholders and interested citizens. Although water quality was the major driver, it was clearly recognized that treated wastewater flows returned to the reservoir would be a significant and valuable resource in the future.

This project is unique in that there is a separate watershed management program (OWMP), along with its associated water quality monitoring laboratory, that provides oversight, independent accountability and recommendations to the water reclamation agent (UOSA), the potable water treatment and distribution entity (Fairfax Water), and the state regulatory agencies. This was critical in establishing a credible voice of endorsement and recommendation for the plan. Collaboration among major institutional entities that work toward the common goal of protecting and improving reservoir water quality demonstrates leadership for water related issues to the community. Nearly 40 years of successful implementation has demonstrated confidence that the original plan is still working well today.

References

U.S. Environmental Protection Agency (EPA). 2012. Guidelines for Water Reuse, EPA/600/R-12/618. Washington D.C.