



# Regulatory Impact Analysis for the Proposed Standards of Performance for Greenhouse Gas Emissions for New Stationary Sources: Electric Utility Generating Units

Regulatory Impact Analysis for the Proposed Standards of Performance for Greenhouse Gas  
Emissions for New Stationary Sources: Electric Utility Generating Units

U.S. Environmental Protection Agency  
Office of Air Quality Planning and Standards  
Health and Environmental Impacts Division  
Research Triangle Park, NC

## **CONTACT INFORMATION**

This document has been prepared by staff from the Office of Air Quality Planning and Standards, U.S. Environmental Protection Agency. Questions related to this document should be addressed to Amanda Curry Brown, U.S. Environmental Protection Agency, Office of Air Quality Planning and Standards, C439-02, Research Triangle Park, North Carolina 27711 (email: CurryBrown.Amanda@epa.gov).

## **ACKNOWLEDGEMENTS**

In addition to EPA staff from the Office of Air Quality Planning and Standards, personnel from the U.S. EPA Office of Atmospheric Programs and Office of Policy contributed data and analysis to this document.

## ACRONYMS

AEO	Annual Energy Outlook
BACT	Best Available Control Technology
CAA	Clean Air Act
CCS	Carbon Capture and Sequestration or Carbon Capture and Storage
CH <sub>4</sub>	Methane
CO <sub>2</sub>	Carbon Dioxide
CSAPR	Cross State Air Pollution Rule
DOE	U.S. Department of Energy
EAB	Environmental Appeals Board
EGU	Electric Generating Unit
EGU GHG NSPS	Standards of Performance for Greenhouse Gas Emissions for New Stationary Sources for Electric Utility Generating Units
EIA	U.S. Energy Information Administration
EO	Executive Order
EOR	Enhanced Oil Recovery
EPA	U.S. Environmental Protection Agency
FERC	Federal Energy Regulatory Commission
GHG	Greenhouse Gas
HFC	Hydrofluorocarbons
HRSG	Heat Recovery Steam Generator
ICR	Information Collection Request
IGCC	Integrated Gasification Combined Cycle
IOU	Investor Owned Utility
IPCC	Intergovernmental Panel on Climate Change
IPM	Integrated Planning Model
kWh	Kilowatt-hour
MATS	Mercury and Air Toxics Standards
mmBtu	Million British Thermal Units
MW	Megawatt
MWh	Megawatt-hour
N <sub>2</sub> O	Nitrous Oxide
NEEDS	National Electric Energy Data System
NETL	National Energy Technology Laboratory
NGCC	Natural Gas Combined Cycle

NO <sub>x</sub>	Nitrogen Oxide
NRC	National Research Council
NSPS	New Source Performance Standard
NTTAA	National Technology Transfer and Advancement Act
O&M	Operations and Maintenance
OMB	Office of Management and Budget
PC	Pulverized Coal
PM <sub>2.5</sub>	Fine Particulate Matter
PRA	Paperwork Reduction Act
PSD	Prevention of Significant Deterioration
psi	Pounds per Square Inch
RFA	Regulatory Flexibility Act
RIA	Regulatory Impact Analysis
SBA	Small Business Administration
SBREFA	Small Business Regulatory Enforcement Fairness Act
SCC	Social Cost of Carbon
SF <sub>6</sub>	Sulfur Hexafluoride
SIP	State Implementation Plan
SO <sub>2</sub>	Sulfur Dioxide
SPC	Supercritical Pulverized Coal
Tcf	Trillion Cubic Feet
TSD	Technical Support Document
UMRA	Unfunded Mandates Reform Act
USGCRP	U.S. Global Change Research Program
VCS	Voluntary Consensus Standards

## TABLE OF CONTENTS

Executive Summary.....	ES-1
ES.1 Background and Context of Proposed Rule.....	ES-1
ES.2 Summary of Proposed Rule .....	ES-2
ES.3 Key Findings of Economic Analysis .....	ES-3
Chapter 1 Introduction and Background .....	1-1
1.1 Introduction .....	1-1
1.2 Background .....	1-1
1.3 Regulatory Analysis.....	1-1
1.4 Regulated Entities .....	1-3
1.5 Regulated Pollutant .....	1-3
1.6 Baseline and Years of Analysis .....	1-4
1.7 Organization of the Regulatory Impact Analysis .....	1-4
Chapter 2 Control Strategies.....	2-1
2.1 Synopsis.....	2-1
2.2 Definition of Affected Sources.....	2-1
2.3 Control Strategies .....	2-4
2.4 Analytical Baseline .....	2-4
2.5 Emission Reductions .....	2-4
Appendix 2A Potential Transitional Units.....	2A-1

Chapter 3	Defining the Climate Change Problem and Rationale for Rulemaking .....	3-1
3.1	Overview of Climate Change Impacts from GHG Emissions.....	3-1
3.2	References.....	3-10
Chapter 4	Electric Power Sector Profile.....	4-1
4.1	Introduction .....	4-1
4.2	Power Sector Overview.....	4-1
4.3	Deregulation and Restructuring .....	4-6
4.4	Emissions of Greenhouse Gases from Electric Utilities .....	4-7
4.5	Pollution Control Technologies.....	4-11
4.6	GHG Regulation in the Power Sector.....	4-16
4.7	Revenues, Expenses, and Prices .....	4-18
4.8	Electricity Demand and Demand Response.....	4-22
4.9	References .....	4-24
Chapter 5	Costs, Benefits, Economic, and Energy Impacts .....	5-1
5.1	Synopsis.....	5-1
5.2	Background .....	5-1
5.3	External Review of EPA Applications of IPM.....	5-6
5.4	IPM is a Detailed Bottom-Up Model.....	5-7
5.5	Base Case and Sensitivity Analysis of Future Generating Capacity .....	5-8
5.6	Analysis of Applicability of Proposed EGU GHG NSPS to Projected New Generating Capacity.....	5-14
5.7	Costs, Economic, and Energy Impacts of the Proposed Rule for New Electric Generating Units .....	5-19
5.8	Comparison of Emissions from Generation Technologies.....	5-19
5.9	Benefits of Reducing GHGs and Conventional Pollutants .....	5-21

5.10	Illustrative Analysis of the Social Costs of New Generating Sources.....	5-26
5.11	Macroeconomic and Employment Impacts.....	5-37
5.12	References.....	5-37
Chapter 6	Statutory and Executive Order Analyses.....	6-1
6.1	Synopsis.....	6-1
6.2	Executive Order 12866, Regulatory Planning and Review, and Executive Order 13563, Improving Regulation and Regulatory Review .....	6-1
6.3	Paperwork Reduction Act .....	6-2
6.4.	Regulatory Flexibility Act as Amended by the Small Business Regulatory Enforcement Fairness Act of 1996, 5 U.S.C. et seq.....	6-4
6.5	Unfunded Mandates Reform Act of 1995 .....	6-7
6.6	Executive Order 13132, Federalism.....	6-8
6.7	Executive Order 13175, Consultation and Coordination with Indian Tribal Governments .....	6-9
6.8	Executive Order 13045, Protection of Children from Environmental Health Risks and Safety Risks .....	6-10
6.9	Executive Order 13211, Actions Concerning Regulations That Significantly Affect Energy Supply, Distribution, or Use .....	6-10
6.10	National Technology Transfer and Advancement Act .....	6-11
6.11	Executive Order 12898: Federal Actions to Address Environmental Justice in Minority Populations and Low-Income Populations.....	6-11



## LIST OF TABLES

Table 4-1.	Existing Electricity Generating Capacity by Energy Source, 2009.....	4-2
Table 4-2.	Total U.S. Electric Power Industry Retail Sales in 2010 (Billion kWh).....	4-2
Table 4-3.	Electricity Net Generation in 2010 (Billion kWh).....	4-3
Table 4-4.	Coal Steam Electricity Generating Units, by Size, Age, Capacity, and Thermal Efficiency (Heat Rate).....	4-4
Table 4-5.	Domestic Emissions of Greenhouse Gases, by Economic Sector (million metric tons of CO <sub>2</sub> equivalent).....	4-8
Table 4-6.	Electricity Generation-Related Greenhouse Gas Emissions, 2009 (million metric tons of CO <sub>2</sub> equivalent).....	4-9
Table 4-7.	Fossil Fuel Emission Factors in EPA Modeling Applications .....	4-10
Table 4-8.	Existing Coal-Fired EGU Efficiency Improvements Reported for Actual Efficiency Improvement Projects .....	4-14
Table 4-9.	Revenue and Expense Statistics for Major U.S. Investor-Owned Electric Utilities for 2010 (\$millions).....	4-19
Table 4-10.	Projected Revenues by Service Category in 2015 for Public Power and Investor-Owned Utilities (billions).....	4-20
Table 5-1.	Total Generation Capacity in 2010 and Projected by 2020 (GW).....	5-10
Table 5-2.	2010 U.S. Electricity Net Generation and EPA Base Case Projections for 2020 (Billion kWh).....	5-10
Table 5-3.	Projected New Capacity in 2020.....	5-14
Table 5-4.	Estimated Levelized Cost of New Generation Resources from EIA, U.S. Average (2016).....	5-18
Table 5-5.	Illustrative Emissions Profiles, New Coal and Natural Gas-Fired Generating Units.....	5-21
Table 5-6.	Social Cost of CO <sub>2</sub> , 2015-2050 (in 2007 dollars) .....	5-24
Table 5-7.	Pollution Damages (\$/MWh) from Illustrative New Coal Unit <i>Relative to</i> New Natural Gas Combined Cycle Unit.....	5-30
Table 5-8.	Illustrative Costs and Benefits for two CCS Scenarios Compared to Conventional Coal Plant (per MWh 2007\$) .....	5-36
Table 6-1.	Potentially Regulated Categories and Entities.....	6-5

## LIST OF FIGURES

Figure 4-1.	Fossil Fuel-Fired Electricity Generating Facilities, by Size .....	4-5
Figure 4-2.	Status of State Electricity Industry Restructuring Activities .....	4-7
Figure 4-3.	Domestic Emissions of Greenhouse Gases, 2009 (million metric tons of CO <sub>2</sub> equivalent) .....	4-8
Figure 4-4.	GHG Emissions from the Power Sector Relative to Total Domestic GHG Emissions (2009) .....	4-10
Figure 4-5.	Post-Combustion CO <sub>2</sub> Capture for a Pulverized Coal Power Plant .....	4-12
Figure 4-6.	Pre-Combustion CO <sub>2</sub> Capture for an IGCC Power Plant .....	4-13
Figure 4-7.	National Average Retail Electricity Price (1960 – 2009) .....	4-20
Figure 4-8.	Average Retail Electricity Price by State (cents/kWh), 2009 .....	4-21
Figure 4-9.	Natural Gas Spot Price, Annual Average (Henry Hub) .....	4-22
Figure 4-10.	Electricity Growth Rate (3 Year Rolling Average) and Projections from the Annual Energy Outlook 2011 .....	4-23
Figure 5-1.	Historical U.S. Power Plant Capacity Additions, by Technology .....	5-4
Figure 5-2.	Projected Levels of Electricity Demand in 2020, EPA and EIA .....	5-12
Figure 5-3.	Projected Natural Gas Prices in 2020, EPA and EIA (Delivered, Power Sector). .....	5-13
Figure 5-4.	Illustrative Wholesale Levelized Cost of Electricity of Alternative New Generation Technologies, EPA .....	5-16

## EXECUTIVE SUMMARY

This Regulatory Impact Analysis (RIA) discusses potential benefits, costs, and economic impacts of the proposed Standards of Performance for Greenhouse Gas Emissions for New Stationary Sources for Electric Utility Generating Units (herein referred to as EGU GHG NSPS).

### ES.1 Background and Context of Proposed Rule

The proposed EGU GHG NSPS will limit greenhouse gas emissions (GHG) from new fossil fuel fired electric generating units (EGU) constructed in the United States in the future.<sup>1</sup> This rulemaking will apply to carbon dioxide (CO<sub>2</sub>) emissions from new electric generating sources that exceed 25 megawatts (MW) in capacity. The United States Environmental Protection Agency (EPA) is proposing requirements for these sources because CO<sub>2</sub> is a GHG and power plants are the country's largest stationary source emitters of GHGs. As stated in the EPA's Endangerment and Cause or Contribute Findings for Greenhouse Gases Under Section 202(a) of the Clean Air Act (74 FR 66,518; Dec. 15, 2009) and summarized in Chapter 3 of this RIA, the anthropogenic buildup of GHGs in the atmosphere is very likely the cause of most of the observed global warming over the last 50 years. This action is taken in response to a proposed settlement agreement entered into on December 23, 2010 to issue rules that will deal with GHGs from certain fossil fuel-fired EGUs.

The statutory authority for this action is the Clean Air Act (CAA) section 111(b), which covers the regulation of new, modified, and reconstructed sources. For the purposes of this rule, a new source is one that commences construction after the publication of the proposed rule, other than those sources EPA has classified as "transitional" sources described later in this RIA. A reconstructed source is generally defined as an existing source that conducts extensive replacement of components and is treated as a new source under CAA section 111. A modification is any physical change in, or change in the method of operation of, a source that increases the amount of any air pollutant emitted by the source or results in the emission of any air pollutant not previously emitted.

EPA is not proposing a standard of performance for a group of sources it is calling transitional sources as long as they commence construction<sup>2</sup> within 12 months from the date of

---

<sup>1</sup> For purposes of this rule, covered EGUs do not include simple cycle combustion turbines. In addition, units subject to emission requirements under the CAA solid waste combustion provisions (Section 129) would not be subject to requirements under this proposed rule.

<sup>2</sup> EPA's regulations define "commenced construction" as, in general, undertaking a continuous program of construction or entering into a binding contract to do so (40 CFR 51.165).

this proposal. Transitional sources are affected EGUs that have received approval for their complete Prevention of Significant Deterioration (PSD) preconstruction permits, but that have not “commenced construction” by the date of today’s proposed rulemaking. EPA is aware of approximately 15 transitional sources, six of which are expected to utilize carbon capture and sequestration (CCS) technology.

CAA section 111(d) covers regulation of existing stationary sources that are not regulated under other parts of the CAA (i.e., pollutants regulated under NAAQS requirements or NESHAP requirements) and to which a new source performance standard (NSPS) would apply if such existing source were a new source. This rulemaking affects CAA section 111(b) new sources of GHG emissions from fossil fuel-fired EGUs but does not address GHG emissions from existing sources. EPA is currently examining options for developing CO<sub>2</sub> emission guidelines that will be used by states to develop plans establishing standards of performance as required by CAA section 111(d). CAA Section 111 (b) requires that this standard be reviewed every eight years, thus this regulatory requirement will likely be reviewed and potentially revised after the 2020 timeframe. Therefore, this economic analysis focuses on benefits and costs of this proposal for the years through 2020.

This proposed rule is consistent with the President’s goal to ensure that “by 2035 we will generate 80 percent of our electricity from a diverse set of clean energy sources - including renewable energy sources like wind, solar, biomass and hydropower, nuclear power, efficient natural gas, and clean coal.”<sup>3</sup> Additionally, this rule demonstrates to other countries that the United States is taking action to limit GHGs from its largest emissions sources, in line with our international commitments. The impact of GHGs is global, and U.S. action to reduce GHG emissions complements ongoing programs and efforts in other countries.

## **ES.2 Summary of Proposed Rule**

This proposal requires that all new fossil-fuel fired units that exceed 25 MW in capacity be able to meet an emission rate standard of 1,000 pounds of CO<sub>2</sub> per megawatt hour (lbs CO<sub>2</sub>/MWh) calculated over a rolling 12-month period. It also proposes an alternative compliance option that would allow units to meet the 1,000 lbs CO<sub>2</sub>/MWh standard using a 30-year averaging period. These standards could be met either by natural gas combined cycle (NGCC) generation with no additional GHG control or coal-fired generation using CCS. The base case modeling EPA performed for this rule (as well as modeling that EPA has performed for

---

<sup>3</sup>“Blueprint for a Secure Energy Future.” March 30, 2011. Available online at:  
[http://www.whitehouse.gov/sites/default/files/blueprint\\_secure\\_energy\\_future.pdf](http://www.whitehouse.gov/sites/default/files/blueprint_secure_energy_future.pdf)

other recent air rules) project that, even in the absence of this action, new fossil-fuel fired capacity constructed through 2020 will most likely be natural gas combined cycle capacity. Alternatively, with available federal funding and appropriate market conditions, coal-fired capacity with CCS could also be built. Any projected combustion turbine capacity would not be affected by this rule. Analyses performed both by EPA and the U.S. Energy Information Administration (EIA)<sup>4</sup> project that generation technologies other than coal (including natural gas and renewable sources) are likely to be the technology of choice for new generating capacity due to current and projected economic market conditions. This means that technologies planned for new sources currently envisioned by owners and operators of EGUs will meet the regulatory requirements of this NSPS or are not covered by the NSPS.

### **ES.3 Key Findings of Economic Analysis**

As explained in detail in this document, energy market data and projections support the conclusion that, even in the absence of this rule, existing and anticipated economic conditions in the marketplace will lead electricity generators to choose technologies that meet the proposed standards. Therefore, based on the analysis presented in Chapter 5, EPA anticipates that the proposed EGU GHG NSPS will result in negligible CO<sub>2</sub> emission changes, energy impacts, quantified benefits, costs, and economic impacts by 2020. Accordingly, EPA also does not anticipate this rule will have any impacts on the price of electricity, employment or labor markets, or the US economy. Nonetheless, this rule may have several important beneficial effects described below.

This NSPS provides legal assurance that any new coal-fired plants must limit CO<sub>2</sub> emissions. Rather than relying solely on changeable energy market conditions to provide low emissions from new power plants in the future, this rule prevents the possible construction of uncontrolled, high-emitting new sources that might continue to emit at high levels for decades, contributing to accumulation of CO<sub>2</sub> in the atmosphere. In Chapter 5 of this RIA, we present a sensitivity analysis indicating that even in the unlikely event that market conditions change sufficiently to make the construction of new conventional coal-fired units economical from the perspective of private investors, the level of avoided negative health and environmental effects expected would imply net social benefits from this proposed rule.

The rule will reduce regulatory uncertainty by defining section 111(b) requirements for limiting GHG from new EGU sources. In addition, EPA intends this rule to send a clear signal about the future of CCS technology that, in conjunction with other policies such as Department

---

<sup>4</sup> Annual Energy Outlook (AEO) 2009- 2012.

of Energy (DOE) financial assistance, the agency estimates will support development and demonstration of CCS technology from coal-fired plants at commercial scale, if that financial assistance is made available and under the appropriate market conditions.<sup>5</sup> Carbon capture also has the potential to help to improve U.S. energy production through enhanced oil recovery, as highlighted by a series of regional assessments conducted for DOE.<sup>6</sup>

---

<sup>5</sup> A number of the sources that EPA has identified as transitional sources have received some form of DOE financial assistance to demonstrate CCS. Several additional projects have received funding but have not yet received air permits. Beyond these projects, prospects for additional federal funding are dependent on the overall budget process.

<sup>6</sup> U.S. Department of Energy. DOE web page, "Ten Basin-Oriented CO<sub>2</sub>-EOR Assessments Examine Strategies for Increasing Domestic Oil Production.," Available online at: [http://www.fossil.energy.gov/programs/oilgas/eor/Ten\\_Basin-Oriented\\_CO<sub>2</sub>-EOR\\_Assessments.html](http://www.fossil.energy.gov/programs/oilgas/eor/Ten_Basin-Oriented_CO2-EOR_Assessments.html).

## CHAPTER 1 INTRODUCTION AND BACKGROUND

### 1.1 Introduction

In this action, EPA seeks to address the climate and health effects of GHGs, specifically CO<sub>2</sub>, emitted from fossil fuel-fired electricity generating units. This document presents the expected economic impacts of the proposed EGU GHG NSPS rule through 2020. Based on the analysis presented in Chapter 5, expected and anticipated economic conditions will lead electricity generators to choose technologies that meet the standard. As a result, this proposed rule is expected to have no, or negligible, costs or monetized benefits associated with it. This chapter contains background information on the rule and an outline of the chapters of the report.

### 1.2 Background

Section 111 of the CAA requires performance standards for air pollutant emissions from categories of stationary sources that may reasonably contribute to endangerment of public health or welfare. In April 2007, the Supreme Court ruled that GHGs meet the definition of an “air pollutant” under the CAA. This ruling clarified that the authorities and requirements of the Act apply to GHGs. As a result, EPA must make decisions about whether to regulate GHGs under certain provisions of the Act, based on relevant statutory criteria. EPA issued a final determination that GHG emissions endanger public health and welfare in the Endangerment and Cause or Contribute Findings for Greenhouse Gases Under Section 202(a) of the Clean Air Act (74 FR 66,496; Dec. 15, 2009). Because fossil fuel-fired EGUs contribute significantly to domestic CO<sub>2</sub> emissions, EPA is proposing to regulate these emissions from EGU sources under section 111 of the CAA.

This action responds to a proposed settlement agreement EPA entered into in December 2010 to issue rules that will address greenhouse gas emissions from fossil fuel-fired power plants. Details of the settlement agreement can be found on the EPA website.<sup>1</sup> This action addresses standards for new sources but does not address existing sources at this time. Existing sources will be addressed in a separate action at a later date by the EPA.

### 1.3 Regulatory Analysis

In accordance with Executive Order 12866, Executive Order 13563, and EPA’s Guidelines for Preparing Economic Analyses, EPA prepared this RIA for this “significant regulatory action.”

---

<sup>1</sup> <http://www.epa.gov/airquality/ghgsettlement.html>

This proposal is not anticipated to have an annual effect on the economy of \$100 million or more or adversely affect in a material way the economy, a sector of the economy, productivity, competition, jobs, the environment, public health or safety, or State, local, or tribal governments or communities and is therefore not an “economically significant rule.” However, under EO 12866 (58 FR 51,735, October 4, 1993), this action is a “significant regulatory action” because it “raises novel legal or policy issues arising out of legal mandates.” As a matter of policy, however, EPA has attempted to provide a thorough analysis of the potential impacts of this rule, consistent with requirements of the Executive Orders, and will continue to analyze the potential impacts of this rule between the proposed and final rule.

This RIA addresses the potential costs and benefits of the new source guidelines that are the focus of the proposed action. The proposed rule regulates new sources. EPA does not anticipate that any costs or quantified benefits will result from those parts of the standards. For new sources, EPA (and other energy modeling groups such as EIA<sup>2</sup>) does not project that any new coal capacity without federally-supported CCS will be built in the analysis period. This is due in part to the low cost of base load NGCC capacity relative to coal capacity, relatively low growth in electricity demand, and use of energy efficiency and renewable energy resources. This conclusion holds under a range of sensitivity analyses as well as in EPA’s baseline scenario. Furthermore, absent this rule, any new NGCC that may be built is expected to have an annual emission rate in compliance with the standard. Because the proposal does not change these projections, it is expected to have no, or negligible, costs<sup>3</sup> or quantified benefits associated with it. Chapter 5 of this RIA also provides an illustrative analysis of the levelized cost of electricity and environmental damages associated with representative new conventional coal and natural gas combined cycle units, under a range of natural gas price assumptions. That analysis, along with information on historical<sup>4</sup> and projected<sup>5</sup> gas prices, indicates that this standard is highly likely to have no costs or benefits; that there is some small probability that the standard

---

<sup>2</sup> AEO 2009-2012.

<sup>3</sup> Because of existing and anticipated trends in the marketplace, EPA does not project that any generators expected to be built within the time frame of our analysis will have to install additional controls to meet the proposed standard. Additionally, because new generators would already be required to monitor and report their CO<sub>2</sub> emissions under the information collection requirements contained in the existing part 75 and 98 regulations (40 CFR part 75 and 40 CFR part 98), any additional monitoring or reporting costs from this proposal should be negligible. Costs are only incurred if there has been a violation and a source chooses to take advantage of the affirmative defense, in which the source can show that the violation was caused by a malfunction and the source took necessary actions to minimize emissions. See Chapter 6 for more details on monitoring and reporting costs.

<sup>4</sup> EIA. U.S. Natural Gas Prices. Available online at: [http://www.eia.gov/dnav/ng/ng\\_pri\\_sum\\_dcu\\_nus\\_a.htm](http://www.eia.gov/dnav/ng/ng_pri_sum_dcu_nus_a.htm).

<sup>5</sup> AEO 2009-2012.



produces net benefits; and that the probability that the standard results in net costs to society is exceedingly low.

#### **1.4 Regulated Entities**

This action will directly regulate CO<sub>2</sub> emissions from EGUs with capacity greater than 25 MW that commence construction after the issuance of this proposal.<sup>6</sup>

As described in the preamble, EPA does not have enough information on potential reconstructions in order to issue a standard at this time. As a result, in today's action, the EPA is not including a proposal for reconstructions. Instead, we solicit comment on how we should approach reconstructions and, depending on the information we receive, we may propose and finalize a standard for reconstructions at a later time. Additionally, EPA does not have information indicating that affected EGUs would undertake modifications, and is thus not proposing any standards for modifications. EPA is taking comment on this and in the future may choose to set a standard for modifications that is different than that for existing sources. Finally, EPA is not proposing a standard of performance for transitional sources as long as they commence construction within 12 months from the date of this proposal.

#### **1.5 Regulated Pollutant**

This rule proposes to limit CO<sub>2</sub> emissions from affected sources. EPA is proposing these requirements because CO<sub>2</sub> is a GHG and power plants are the country's largest stationary source emitters of GHGs. In 2009, EPA found that by causing or contributing to climate change, GHGs endanger both the public health and the public welfare of current and future generations.

EPA is aware that other GHGs such as nitrous oxide (N<sub>2</sub>O) (and to a lesser extent, methane (CH<sub>4</sub>)) may be emitted from fossil-fuel-fired EGUs, especially from coal-fired circulating fluidized bed combustors and from units with selective catalytic reduction and selective non-catalytic reduction systems installed for nitrogen oxide (NO<sub>x</sub>) control. EPA is not proposing separate N<sub>2</sub>O or CH<sub>4</sub> emission limits or an equivalent CO<sub>2</sub> emission limit because of a lack of available data for these affected sources. Additional information on the quantity and significance of emissions and on the availability of cost effective controls would be needed before proposing standards for these pollutants.

---

<sup>6</sup> For purposes of this rule, covered EGUs do not include simple cycle combustion turbines. In addition, units subject to emission requirements under CAA section 129 would not be subject to requirements under this proposed rule.

## **1.6 Baseline and Years of Analysis**

The rule on which this analysis is based proposes the requirement for new EGUs to achieve lower levels of GHG emissions. The baseline for this analysis, which uses the Integrated Planning Model (IPM), includes state rules that have been finalized and/or approved by a state's legislature or environmental agencies. Additional legally binding and enforceable commitments for GHG reductions considered in the baseline are discussed in Chapter 5 of this RIA.

All analysis is presented for compliance through the year 2020 and all estimates are presented in 2007\$. Because we expect similar economic conditions leading up to the year of analysis, we also would not anticipate costs or benefits in any year prior to 2020. Any estimates presented in this report represent annualized estimates of the benefits and costs of the proposed EGU GHG NSPS rather than the net present value of a stream of benefits and costs in these particular years of analysis.

## **1.7 Organization of the Regulatory Impact Analysis**

This report presents EPA's analysis of the potential benefits, costs, and other economic effects of the proposed EGU GHG NSPS to fulfill the requirements of a Regulatory Impact Analysis. This RIA includes the following chapters:

- Chapter 2, Control Strategies, defines the source categories affected by the proposal and describes the control strategies and regulatory alternatives for these source categories.
- Chapter 3, Defining the Climate Change Problem and Rationale for the Rulemaking, describes the effects of GHG emissions on climate and offers support for EPA undertaking this rulemaking.
- Chapter 4, Electric Power Sector Profile, describes the industry affected by the rule.
- Chapter 5, Costs, Benefits, Economic, and Energy Impacts describes impacts of the proposal.
- Chapter 6, Statutory and Executive Order Impact Analyses, describes the small business, unfunded mandates, paperwork reduction act, environmental justice, and other analyses conducted for the rule to meet statutory and Executive Order requirements.

## CHAPTER 2 CONTROL STRATEGIES

### 2.1 Synopsis

This section defines the source categories affected by the proposal, outlines regulatory actions included in the analytical baseline, and describes the control strategies and regulatory alternatives for new, modified, reconstructed, and transitional sources. Existing EGU GHG sources are not addressed in this action, but will be the subject of a subsequent action by the EPA.

### 2.2 Definition of Affected Sources

#### 2.2.1 *Electric Utility Generating Unit*

For the purposes of this rule, the EPA is proposing to define an EGU as any fossil fuel-fired combustion unit that has the potential to produce more than 25 MW electrical output and serves as a generator that produces electricity for sale, with the exception of simple cycle turbines. For this rule, the term EGU includes steam generating units (“boilers”), NGCC combustion turbines and their associated heat recovery steam generator (HRSG) and duct burners, and Integrated Gasification Combined Cycle (IGCC, “coal gasification”) units – including their combustion turbines and associated HRSGs. A unit that cogenerates steam and electricity or that cogenerates feedstocks (e.g., hydrogen or hydrocarbons from an IGCC) for chemical or fuel production and supplies more than one-third of its potential electric output capacity and more than 25 MW output to any utility power distribution system for sale is also considered to be an EGU for the purposes of this rule. This rule does not cover simple cycle turbines.

#### 2.2.2 *New Sources*

Sources affected by the new source provisions of the proposal are sources that are both considered “EGUs” and are considered “new” as defined by this rule. The general NSPS provisions (40 CFR Part 60) define a new source as one that begins construction (or reconstruction) after the date the provisions are proposed.

CAA section 111(a)(2) defines a “new source” as “any stationary source, the construction or modification of which is commenced after publication of regulations (or, if early, proposed regulations) prescribing a standard of performance under [CAA section 111] which will be applicable to such source.” In contrast, CAA section 111(a)(6) defines an “existing source” as “any stationary source other than a new source.” The definition of a “new source” applies for purposes of this rulemaking, except that special considerations come into play for

sources undertaking physical or operational changes (modified sources), transitional sources, and sources undertaking reconstruction.

### **2.2.3 Modified Sources**

The EPA does not have a sufficient base of information to develop a proposal for the relatively few affected sources that may take actions that would constitute “modifications,” as defined under the EPA’s NSPS regulations, and therefore be subject to requirements for new sources. A modification is any physical or operational change to a source that increases the amount of any air pollutant emitted by the source or results in the emission of any air pollutant not previously emitted. However, projects to install pollution controls required under other CAA provisions are specifically exempted from the definition of “modifications” under 40 CFR 60.14(e)(5), even if they emit CO<sub>2</sub> as a byproduct. The significant majority of projects that the EPA believes EGUs are most likely to undertake in the foreseeable future that could increase the maximum achievable hourly rate of CO<sub>2</sub> emissions would be pollution control projects that are exempt under this definition. More details on the approach for modified sources can be found in the preamble.

EPA is not proposing a standard of performance for modifications at this time. As a result, sources that undertake modifications will be treated as existing sources and thus not subject to the requirements proposed in this notice, although they would be subject to requirements that the EPA intends to propose separately for existing EGUs. The EPA is soliciting comment on the treatment of modified sources and, depending on the information received, may issue proposed standards of performance in the future.

### **2.2.4 Transitional Sources**

This proposed rule sets no standard for transitional sources, although these sources may be subject to an existing source standard in a subsequent rulemaking. In this proposal, EPA identifies transitional sources as those sources that have received permits to construct, but have not actually commenced construction. EPA believes that there are approximately 15 units that would be classified as transitional sources (see Appendix 2A for a list of potential transitional units). EPA is proposing that as long as these units commence construction within one year of the effective date of this proposal, these sources will be classified as transitional sources for the purposes of this rule and will not be subject to the NSPS.

Historically, obtaining a permit does not guarantee that a unit will be constructed. In the last 10 years, 85 coal plants have been permitted. Of those, 40 (or less than half) have

actually commenced construction. Thirty projects have been cancelled and approximately 15 sources (the transitional sources) have active permits. EPA notes that many variables in addition to permitting appear to contribute to the likelihood of project completion. Based on this history and current economic conditions in particular, not all units are likely to proceed.

EPA believes the transitional units that are most likely to commence construction are those that have received government incentives to install CCS. These units would be able to commence construction within the proposed rule time-frame.

### **2.2.5 Reconstructed Sources**

The EPA's CAA section 111 regulations provide that reconstructed sources are to be treated as new sources and, therefore, subject to new source standards of performance. The regulations define reconstructed sources, in general, as existing sources: (i) that replace components to such an extent that the capital costs of the new components exceed 50 percent of the capital costs of an entirely new facility and (ii) for which compliance with standards of performance for new sources is technologically and economically feasible (40 CFR 60.15).

Historically, very few power plants have undertaken reconstructions. We are not aware that any power plants are presently planning any project that could meet the requirements for a reconstruction. In light of this limited experience concerning reconstructions, the Agency lacks adequate information that is needed to propose a standard of performance for reconstructions. As a result, in today's action, the EPA is not including a proposal for reconstructions. Instead, we solicit comment on how we should approach reconstructions and, depending on the information we receive, we may propose and finalize a standard for reconstructions at a later time. EPA is soliciting comment on the type of source that will undertake reconstruction; the type of changes; the extent of emissions increases; and the type of control measures, including their cost and emissions reductions.

### **2.2.6 Existing Sources**

For the purposes of this rule an existing EGU is defined as any fossil fuel-fired combustion unit that has the potential to produce more than 25 MW output and serves a generator that produces electricity for sale and was in operation or commenced construction on or before publication of this proposed rule. Existing sources are not covered in this proposed action, but will be addressed in a subsequent rulemaking by the EPA.

### **2.3 Control Strategies**

This proposal requires that all new fossil-fuel fired units with greater than 25 MW capacity be able to meet an emission rate standard of 1,000 lb CO<sub>2</sub>/MWh calculated over a rolling 12-month period. It also proposes an alternative compliance option that would allow units to meet the 1,000 lb CO<sub>2</sub>/MWh standard using a 30-year averaging period. These standards could be met by NGCC generation with no additional GHG control or coal-fired generation using carbon capture and sequestration technology.

### **2.4 Analytical Baseline**

EPA used IPM v.4.10 to assess the baseline conditions described for the proposed new source performance standards. IPM is a dynamic linear programming model that can be used to examine the economic impacts of air pollution control policies for CO<sub>2</sub> and other air pollutants throughout the contiguous U.S. for the entire power system. The modeling conducted for this proposal is discussed more extensively in Chapter 5 of this RIA. Documentation for IPM can be found in the docket for this rulemaking or at <http://www.epa.gov/airmarkets/progsregs/epa-ipm/index.html>. For more information on the analytical baseline see Chapter 5 of this report.

### **2.5 Emission Reductions**

As will be discussed in more detail in Chapter 5 of this RIA, the EPA anticipates that the proposed EGU GHG NSPS will result in negligible changes in GHG emissions over the analysis period (through 2020). Even in the absence of this rule, the EPA expects that owners of new units will choose generation technologies that meet these standards due to expected economic conditions in the marketplace. Likewise, we anticipate that this rule will have negligible costs, quantified benefits, and impacts on the price of electricity, labor markets, or the economy.

**APPENDIX 2A**  
**POTENTIAL TRANSITIONAL UNITS**

Plant Name	Size	CO <sub>2</sub> Mitigation Plan	Location
Trailblazer	600 MW	CCS – EOR (supercritical PC)	TX
Taylorville	602 MW	CCS – EOR/Geologic (IGCC)	IL
Texas Clean Energy Project	400 MW	CCS – EOR (IGCC)	TX
Cash Creek Generation	761 MW	CCS - IGCC	KY
Power County Advanced Energy Center	520 MW	CCS – EOR (IGCC)	ID
Good Spring	270 MW	CCS – IGCC	PA
Limestone 3	750 MW	Agreement to capture or offset 50% of CO <sub>2</sub> (subcritical PC) – CCS ready	TX
Holcomb 2	895 MW	None (supercritical PC)	KS
White Stallion	1320 MW	None (subcritical CFB)	TX
James De Young	78 MW	None (subcritical CFB)	MI
Wolverine	600 MW	None (subcritical CFB) – CCS ready	MI
Coletto Creek	650 MW	None (supercritical PC) – CCS ready	TX
Washington County	850 MW	None (supercritical PC)	GA
Bonanza	110 MW	None (subcritical CFB, waste coal)	UT
Two Elk	250 MW	None (subcritical PC, waste coal) – CCS ready	WY

Note: This table does not reflect an official list of transitional sources, but instead reflects sources that could potentially be considered transitional under the proposed regulation.

PC = pulverized coal

CCS = carbon capture and storage

CFB = circulating fluidized bed

EOR = enhanced oil recovery

IGCC = integrated gasification combined cycle

## CHAPTER 3

### DEFINING THE CLIMATE CHANGE PROBLEM AND RATIONALE FOR RULEMAKING

#### 3.1 Overview of Climate Change Impacts from GHG Emissions

In 2009, the EPA Administrator found that elevated concentrations of greenhouse gases in the atmosphere may reasonably be anticipated both to endanger public health and to endanger public welfare. It is these adverse impacts that make it necessary for EPA to regulate greenhouse gases from EGU sources. This proposed rule is designed to minimize emissions of greenhouse gases, minimize the rate of increase of concentrations of these gases, and therefore reduce the risk of adverse effects. As the analysis presented in Chapter 5 shows, existing and anticipated economic conditions in the marketplace will lead electricity generators to choose technologies that meet the proposed standards. However, rather than relying solely on changeable energy market conditions to provide low emissions from new power plants in the future, though this rule, EPA ensures that new electricity generation will be clean generation.

This chapter summarizes the adverse effects on public health and public welfare detailed in the 2009 Endangerment Finding.<sup>1</sup> The major assessments by the U.S. Global Change Research Program (USGCRP), the Intergovernmental Panel on Climate Change (IPCC), and the National Research Council (NRC) served as the primary scientific basis for these effects.

##### 3.1.1 *Public Health*

Climate change threatens public health in a number of ways: direct temperature effects, air quality effects, the potential for changes in vector-borne diseases, and the potential for changes in the severity and frequency of extreme weather events. Additionally, susceptible populations may be particularly at risk. Each of these effects will be addressed in turn in this section, based on the 2009 Endangerment Finding.

Regarding direct temperature changes, it has already been estimated that unusually hot days and heat waves are becoming more frequent, and that unusually cold days are becoming less frequent. Heat is already the leading cause of weather-related deaths in the United States. In the future, severe heat waves are projected to intensify in magnitude and duration over the portions of the United States where these events already occur. Heat waves are associated with marked short-term increases in mortality. Hot temperatures have also been associated with

---

<sup>1</sup> Endangerment and Cause or Contribute Findings for Greenhouse Gases Under Section 202(a) of the Clean Air Act, 74 Fed. Reg. 66,496 (Dec. 15, 2009).



increased morbidity. The projected warming is therefore projected to increase heat related mortality and morbidity, especially among the elderly, young, and frail. The populations most sensitive to hot temperatures are older adults, the chronically sick, the very young, city-dwellers, those taking medications that disrupt thermoregulation, the mentally ill, those lacking access to air conditioning, those working or playing outdoors, and socially isolated persons. As warming increases over time, these adverse effects would be expected to increase as the serious heat events become more serious.

Increases in temperature are also expected to lead to some reduction in the risk of death related to extreme cold. It is not clear whether reduced mortality in the United States from cold would be greater or less than increased heat-related mortality in the United States due to climate change. However, there is a risk that projections of cold-related deaths, and the potential for decreasing their numbers due to warmer winters, can be overestimated unless they take into account the effects of season and influenza, which is not strongly associated with monthly winter temperature. In addition, the latest USGCRP report (2009) refers to a study (Medina-Ramon and Schwartz, 2007) that analyzed daily mortality and weather data in 50 U.S. cities from 1989 to 2000 and found that, on average, cold snaps in the United States increased death rates by 1.6 percent, while heat waves triggered a 5.7 percent increase in death rates. The study concludes that increases in heat-related mortality due to global warming in the United States are unlikely to be compensated for by decreases in cold-related mortality.

Regarding air quality effects, increases in regional ozone pollution relative to ozone levels without climate change are expected due to higher temperatures and weaker circulation in the United States relative to air quality levels without climate change. Climate change is expected to increase regional ozone pollution, with associated risks in respiratory illnesses and premature death. In addition to human health effects, tropospheric ozone has significant adverse effects on crop yields, pasture and forest growth, and species composition.

Modeling studies discussed in EPA's Interim Assessment (2009) show that simulated climate change causes increases in summertime ozone concentrations over substantial regions of the country, though this was not uniform, and some areas showed little change or decreases, though the decreases tend to be less pronounced than the increases. For those regions that showed climate-induced increases, the increase in maximum daily 8-hour average ozone concentration, a key metric for regulating U.S. air quality, was in the range of 2 to 8 ppb, averaged over the summer season. The increases were substantially greater than this during the peak pollution episodes that tend to occur over a number of days each summer. The overall effect of climate change was projected to increase ozone levels, compared to what would occur

without this climate change, over broad areas of the country, especially on the highest ozone days and in the largest metropolitan areas with the worst ozone problems. Ozone decreases are projected to be less pronounced, and generally to be limited to some regions of the country with smaller population.

In addition to impacts on heat-related mortality and air quality, there is also the potential for increased deaths, injuries, infectious diseases, and stress-related disorders and other adverse effects associated with social disruption and migration from more frequent extreme weather. Vulnerability to these disasters depends on the attributes of the people at risk and on broader social and environmental factors.

Increases in the frequency of heavy precipitation events are associated with increased risk of deaths and injuries as well as infectious, respiratory, and skin diseases. Floods are low-probability, high-impact events that can overwhelm physical infrastructure, human resilience, and social organization. Flood health impacts include deaths, injuries, infectious diseases, intoxications, and mental health problems.

Increases in tropical cyclone intensity are linked to increases in the risk of deaths, injuries, waterborne and food borne diseases, as well as post-traumatic stress disorders. Drowning by storm surge, heightened by rising sea levels and more intense storms (as projected by IPCC), is the major killer in coastal storms where there are large numbers of deaths. Flooding can cause health impacts including direct injuries as well as increased incidence of waterborne diseases.

According to the assessment literature, there will also likely be an increase in the spread of several food and water-borne pathogens among susceptible populations depending on the pathogens' survival, persistence, habitat range and transmission under changing climate and environmental conditions. Food borne diseases show some relationship with temperature, and the range of some zoonotic disease carriers such as the Lyme disease carrying tick may increase with temperature.

Climate change, including changes in carbon dioxide concentrations, could impact the production, distribution, dispersion, and allergenicity of aeroallergens and the growth and distribution of weeds, grasses, and trees that produce them. These changes in aeroallergens and subsequent human exposures could affect the prevalence and severity of allergy symptoms. However, the scientific literature does not provide definitive data or conclusions on how climate change might impact aeroallergens and subsequently the prevalence of allergenic

illnesses in the United States. It has generally been observed that the presence of elevated carbon dioxide concentrations and temperatures stimulate plants to increase photosynthesis, biomass, water use efficiency, and reproductive effort. The IPCC concluded that pollens are likely to increase with elevated temperature and carbon dioxide.

### **3.1.2 Public Welfare**

As with public health, there are multiple pathways in which the greenhouse gas air pollution and resultant climate change affect climate-sensitive sectors. These sectors include food production and agriculture; forestry; water resources; sea level rise and coastal areas; energy, infrastructure, and settlements; and ecosystems and wildlife. Impacts also arise from climate change occurring outside of the United States, such as national security concerns for the United States that may arise as a result of climate change impacts in other regions of the world. Each of these effects will be addressed in turn in this section, based on the 2009 Finding.

Regarding food production and agriculture, elevated carbon dioxide concentrations can have a stimulatory effect, as may modest temperature increases and a longer growing season that results. However, elevated carbon dioxide concentrations may also enhance pest and weed growth. In addition, higher temperature increases, changing precipitation patterns and variability, and any increases in ground-level ozone induced by higher temperatures, can work to counteract any direct stimulatory carbon dioxide effect, as well as lead to their own adverse impacts. A USGCRP report (2009) concluded that while for some crops such as grain and oilseed crops there may be a beneficial effect overall in the next couple decades, as temperature rises, these crops will increasingly begin to experience failure, especially if climate variability increases and precipitation lessens or becomes more variable. Changes in the intensity and frequency of extreme weather events such as droughts and heavy storms have the potential to have serious negative impact on U.S. food production and agriculture. Changing precipitation patterns, in addition to increasing temperatures and longer growing seasons, can change the demand for irrigation requirements, potentially increasing irrigation demand.

With respect to livestock, higher temperatures will very likely reduce livestock production during the summer season in some areas, but these losses will very likely be partially offset by warmer temperatures during the winter season. The impact on livestock productivity due to increased variability in weather patterns will likely be far greater than effects associated with the average change in climatic conditions.

For the forestry sector there are similar factors to consider. There is the potential for beneficial effects due to elevated concentrations of carbon dioxide, increased temperatures,

and nitrogen deposition, but there is also the potential for adverse effects from increasing temperatures, changing precipitation patterns, increased insects and disease, and the potential for more frequent and severe extreme weather events. According to the science assessment reports on which the Administrator relied for the 2009 Finding, climate change has very likely increased the size and number of wildfires, insect outbreaks, and tree mortality in the Interior West, the Southwest, and Alaska, and will continue to do so.

If existing trends in precipitation continue, it is expected that forest productivity will likely decrease in the Interior West, the Southwest, eastern portions of the Southeast, and Alaska, and that forest productivity will likely increase in the northeastern United States, the Lake States, and in western portions of the Southeast. An increase in drought events will very likely reduce forest productivity wherever such events occur.

The sensitivity of water resources to climate change is very important given the increasing demand for adequate water supplies and services for agricultural, municipal, and energy and industrial uses, and the current strains on this resource in many parts of the country. According to the assessment literature, climate change has already altered, and will likely continue to alter, the water cycle, affecting where, when, and how much water is available for all uses. With higher temperatures, the water-holding capacity of the atmosphere and evaporation into the atmosphere increase, and this favors increased climate variability, with more intense precipitation and more droughts.

Climate change is causing and will increasingly cause shrinking snowpack induced by increasing temperature. In the western United States, there is already well-documented evidence of shrinking snowpack due to warming. Earlier meltings, with increased runoff in the winter and early spring, increase flood concerns and also result in substantially decreased summer flows. This pattern of reduced snowpack and changes to the flow regime pose very serious risks to major population regions, such as California, that rely on snowmelt-dominated watersheds for their water supply. While increased precipitation is expected to increase water flow levels in some eastern areas, this may be tempered by increased variability in the precipitation and the accompanying increased risk of floods and other concerns such as water pollution.

Climate change will likely further constrain already over-allocated water resources in some regions of the United States, increasing competition among agricultural, municipal, industrial, and ecological uses. Although water management practices in the United States are generally advanced, particularly in the West, the reliance on past conditions as the basis for

current and future planning may no longer be appropriate, as climate change increasingly creates conditions well outside of historical observations. Increased incidence of extreme weather and floods may also overwhelm or damage water treatment and management systems, resulting in water quality impairments.

According to the assessment literature, sea level is rising along much of the U.S. coast and the rate of change will very likely increase in the future, exacerbating the impacts of progressive inundation, storm-surge flooding, and shoreline erosion. A large percentage of the U.S. population lives in these coastal areas. The most vulnerable areas are the Atlantic and Gulf Coasts, the Pacific Islands, and parts of Alaska. Cities such as New Orleans, Miami, and New York are particularly at risk, and could have difficulty coping with the sea level rise projected by the end of the century under a higher emissions scenario. Population growth and the rising value of infrastructure increases the vulnerability to climate variability and future climate change in coastal areas. Adverse impacts on islands present concerns for Hawaii and the U.S. territories. Reductions in Arctic sea ice increases extreme coastal erosion in Alaska, due to the increased exposure of the coastline to strong wave action. In the Great Lakes, where sea level rise is not a concern, both extremely high and low water levels resulting from changes to the hydrological cycle have been damaging and disruptive to shoreline communities.

Coastal wetland loss is being observed in the United States where these ecosystems are squeezed between natural and artificial landward boundaries and rising sea levels. Up to 21 percent of the remaining coastal wetlands in the U.S. mid-Atlantic region are potentially at risk of inundation between 2000 and 2100. Coastal habitats will likely be increasingly stressed by climate change impacts interacting with development and pollution.

Although increases in mean sea level over the 21st century and beyond will inundate unprotected, low-lying areas, the most devastating impacts are likely to be associated with storm surge. Superimposed on expected rates of sea level rise, projected storm intensity, wave height, and storm surge suggest more severe coastal flooding and erosion hazards. Higher sea level provides an elevated base for storm surges to build upon and diminishes the rate at which low-lying areas drain, thereby increasing the risk of flooding from rainstorms. In New York City and Long Island, flooding from a combination of sea level rise and storm surge could be several meters deep. Projections suggest that the return period of a 100-year flood event in this area might be reduced to 4–60 years by the 2080s. Additionally, some major urban centers in the United States, such as areas of New Orleans are situated in low-lying flood plains, presenting increased risk from storm surges.

With respect to infrastructure, climate change vulnerabilities of industry, settlement, and society are mainly related to changes in intensity and frequency of extreme weather events rather than to gradual climate change. Extreme weather events could threaten U.S. energy infrastructure (transmission and distribution), transportation infrastructure (roads, bridges, airports and seaports), water infrastructure, and other built aspects of human settlements. Moreover, soil subsidence caused by the melting of permafrost in the Arctic region is a risk to gas and oil pipelines, electrical transmission towers, roads, and water systems.

Within settlements experiencing climate change stressors, certain parts of the population may be especially vulnerable based on their circumstances. These include the poor, the elderly, the very young, those already in poor health, the disabled, those living alone, and/or indigenous populations dependent on one or a few resources. In Alaska, indigenous communities are likely to experience disruptive impacts, including shifts in the range or abundance of wild species crucial to their livelihoods and well-being.

Climate change is exerting major influences on natural environments and biodiversity, and these influences are generally expected to grow with increased warming. Observed changes in the life cycles of plants and animals include shifts in habitat ranges, timing of migration patterns, and changes in reproductive timing and behavior.

The underlying assessment literature finds with high confidence that substantial changes in the structure and functioning of terrestrial ecosystems are very likely to occur with a global warming greater than 2 to 3 °C above pre-industrial levels, with predominantly negative consequences for biodiversity and the provisioning of ecosystem goods and services. With global average temperature changes above 2 °C, many terrestrial, freshwater, and marine species (particularly endemic species) are at a far greater risk of extinction than in the geological past. Climate change and ocean acidification will likely impair a wide range of planktonic and other marine calcifiers such as corals. Even without ocean acidification effects, increases in sea surface temperature of about 1–3 °C are projected to result in more frequent coral bleaching events and widespread mortality. In the Arctic, wildlife faces great challenges from the effects of climatic warming, as projected reductions in sea ice will drastically shrink marine habitat for polar bears, ice-inhabiting seals, and other animals.

Some common forest types are projected to expand, others are projected to contract, and others, such as spruce-fir, are likely to disappear from the contiguous United States. Changes in plant species composition in response to climate change can increase ecosystem vulnerability to other disturbances, including wildfires and biological invasion. Disturbances

such as wildfires and insect outbreaks are increasing in the United States and are likely to intensify in a warmer future with warmer winters, drier soils and longer growing seasons. The areal extent of drought-limited ecosystems is projected to increase 11 percent per °C warming in the United States. In California, temperature increases greater than 2°C may lead to conversion of shrubland into desert and grassland ecosystems and evergreen conifer forests into mixed deciduous forests. Greater intensity of extreme events may alter disturbance regimes in coastal ecosystems leading to changes in diversity and ecosystem functioning. Species inhabiting salt marshes, mangroves, and coral reefs are likely to be particularly vulnerable to these effects.

According to the USGCRP report of June 2009 and other sources, climate change impacts in certain regions of the world may exacerbate problems that raise humanitarian, trade, and national security issues for the United States.<sup>2</sup> The IPCC identifies the most vulnerable world regions as the Arctic, because of the effects of high rates of projected warming on natural systems; Africa, especially the sub-Saharan region, because of current low adaptive capacity as well as climate change; small islands, due to high exposure of population and infrastructure to risk of sea-level rise and increased storm surge; and Asian mega-deltas due to large populations and high exposure to sea level rise, storm surge, and river flooding. Climate change has been described as a potential threat multiplier with regard to national security issues. While some of these international risks do not readily lend themselves to precise analyses or future projections, given the unavoidable global nature of the climate change problem it is appropriate and prudent to consider how impacts in other world regions may present risks to the U.S. population.

### **3.1.3 Recent Assessments**

Since the Endangerment Finding was released, more recent assessments have produced similar conclusions to those of the assessments upon which the Finding was based. In May 2010, the NRC published its comprehensive assessment, “Advancing the Science of Climate Change” (2010). It concluded that “climate change is occurring, is caused largely by human activities, and poses significant risks for — and in many cases is already affecting — a broad range of human and natural systems.” Furthermore, the NRC stated that this conclusion is based on findings that are “consistent with the conclusions of recent assessments by the U.S.

---

<sup>2</sup> “In an increasingly interdependent world, U.S. vulnerability to climate change is linked to the fates of other nations. For example, conflicts or mass migrations of people resulting from food scarcity and other resource limits, health impacts or environmental stresses in other parts of the world could threaten U.S. national security.” (Karl *et al.*, 2009).

Global Change Research Program, the Intergovernmental Panel on Climate Change's Fourth Assessment Report, and other assessments of the state of scientific knowledge on climate change." These are the same assessments that served as the primary scientific references underlying the Administrator's Endangerment Finding. Another NRC assessment, "Climate Stabilization Targets: Emissions, Concentrations, and Impacts over Decades to Millennia," was published in 2011. This report found that climate change due to carbon dioxide emissions will persist for many centuries. The report also estimate a number of specific climate change impacts, finding that every degree Celsius of warming could lead to increases in the heaviest 15 percent of daily rainfalls of 3 to 10 percent, decreases of 5 to 15 percent in yields for a number of crops (absent adaptation measures that do not presently exist), decreases of Arctic sea ice extent of 25 percent in September and 15 percent annually averaged, along with changes in precipitation and stream flow of 5 to 10 percent in many regions and river basins. The assessment also found that for an increase of 4 degrees C nearly all land areas would experience average summers warmer than all but 5 percent of summers in the 20<sup>th</sup> century, that for an increase of 1 to 2 degrees C the area burnt by wildfires in western North America will likely more than double, that coral bleaching and erosion will increase due both to warming and ocean acidification, and that sea level will rise 1.6 to 3.3 feet by 2100 in a 3 degree C scenario. The assessment notes that many important aspects of climate change are difficult to quantify but that the risk of adverse impacts is likely to increase with increasing temperature, and that the risk of surprises can be expected to increase with the duration and magnitude of warming.

In the 2010 report cited above, the NRC stated that some of the largest potential risks associated with future climate change may come not from relatively smooth changes that are reasonably well understood, but from extreme events, abrupt changes, and surprises that might occur when climate or environmental system thresholds are crossed. Examples cited as warranting more research include the release of large quantities of GHGs stored in permafrost (frozen soils) across the Arctic, rapid disintegration of the major ice sheets, irreversible drying and desertification in the subtropics, changes in ocean circulation, and the rapid release of destabilized methane hydrates in the oceans.

On ocean acidification, the same report noted the potential for broad, "catastrophic" impacts on marine ecosystems. Ocean acidity has increased 25 percent since pre-industrial times, and is projected to continue increasing. By the time atmospheric CO<sub>2</sub> content doubles over its preindustrial value, there would be virtually no place left in the ocean that can sustain



coral reef growth. Ocean acidification could have dramatic consequences for polar food webs including salmon, the report said.

Importantly, these recent NRC assessments represent another independent and critical inquiry of the state of climate change science, separate and apart from the previous IPCC, NRC, and USGCRP assessments.

### **3.2 References**

40 CFR Chapter I [EPA–HQ–OAR–2009–0171; FRL–9091–8] RIN 2060–ZA14, “Endangerment and Cause or Contribute Findings for Greenhouse Gases Under Section 202(a) of the Clean Air Act,” Federal Register / Vol. 74, No. 239 / Tuesday, December 15, 2009 / Rules and Regulations.

Karl, T., J. Melillo, and T. Peterson (Eds.) (2009). *Global Climate Change Impacts in the United States*. Cambridge University Press, Cambridge, United Kingdom.

Medina-Ramon, M. and J. Schwartz, 2007: Temperature, temperature extremes, and mortality: a study of acclimatization and effect modification in 50 U.S. cities. *Occupational and Environmental Medicine*, 64(12), 827-833.

National Research Council (2010). *Advancing the Science of Climate Change*. National Academy Press. Washington, DC.

National Research Council (2011). *Climate Stabilization Targets: Emissions, Concentrations, and Impacts over Decades to Millennia*. National Academy Press, Washington, DC.

U.S. Environmental Protection Agency (2009). *Assessment of the Impacts of Global Change on Regional U.S. Air Quality: A Synthesis of Climate Change Impacts on Ground-Level Ozone*. An Interim Report of the U.S. EPA Global Change Research Program. U.S. Environmental Protection Agency, Washington, DC, EPA/600/R–07/094.

U.S. Global Change Research Program (USGCRP). *Global Climate Change Impacts in the United States*. Thomas R. Karl, Jerry M. Melillo, and Thomas C. Peterson, (eds.). Cambridge University Press, 2009.

## **CHAPTER 4**

### **ELECTRIC POWER SECTOR PROFILE**

#### **4.1 Introduction**

This chapter discusses important aspects of the power sector that relate to the proposed EGU GHG NSPS, including the types of power-sector sources affected by the proposal, and provides background on the power sector and EGUs. In addition, this chapter provides some historical background on EPA regulation of, and future projections for, the power sector.

#### **4.2 Power Sector Overview**

The production and delivery of electricity to customers consists of three distinct segments: generation, transmission, and distribution.

##### **4.2.1 Generation**

Electricity generation is the first process in the delivery of electricity to consumers. Most of the existing capacity for generating electricity involves creating heat to rotate turbines which, in turn, create electricity. The power sector consists of over 17,000 generating units, comprising fossil-fuel-fired units, nuclear units, and hydroelectric and other renewable sources dispersed throughout the country (see Table 4-1).

These electric generating sources provide electricity for commercial, industrial, and residential uses, each of which consumes roughly a quarter to a third of the total electricity produced (see Table 4-2). Some of these uses are highly variable, such as heating and air conditioning in residential and commercial buildings, while others are relatively constant, such as industrial processes that operate 24 hours a day.

**Table 4-1. Existing Electricity Generating Capacity by Energy Source, 2009**

Energy Source	Number of Generators	Generator Nameplate Capacity (MW)	Generator Net Summer Capacity (MW)	Average Capacity Factor
Coal	1,436	338,723	314,294	63.8%
Petroleum	3,757	63,254	56,781	7.8%
Natural Gas	5,470	459,803	401,272	42.2%
Other Gases	98	2,218	1,932	10.1%
Nuclear	104	106,618	101,004	90.3%
Hydroelectric Conventional	4,005	77,910	78,518	39.8%
Wind	620	34,683	34,296	N/A
Solar Thermal and Photovoltaic	110	640	619	N/A
Wood and Wood Derived Fuels	353	7,829	6,939	N/A
Geothermal	222	3,421	2,382	N/A
Other Biomass	1,502	5,007	4,317	N/A
Pumped Storage	151	20,538	22,160	N/A
Other	48	1,042	888	N/A
<b>Total</b>	<b>17,876</b>	<b>1,121,686</b>	<b>1,025,400</b>	<b>44.9%</b>

Source: EIA 2009

Note: Average capacity factors not available for EIA's 2010 Electric Power Annual. Additionally, EIA does not calculate average capacity factors for all energy sources presented in the table. This table presents generation capacity. Actual net generation is presented in Table 4-3.

**Table 4-2. Total U.S. Electric Power Industry Retail Sales in 2010 (Billion kWh)**

	Sales/Direct Use (Billion kWh)	Share of Total End Use
<b>Retail Sales</b>	Residential	1,445 37.2%
	Commercial	1,330 34.2%
	Industrial	971 25.0%
	Transportation	8 0.2%
<b>Direct Use</b>	135	3.5%
<b>Total End Use</b>	<b>3,889</b>	<b>100%</b>

Source: EIA 2010a

In 2010, electric generating sources produced 4,125 billion kWh to meet electricity demand. Roughly 70 percent of this electricity was produced through the combustion of fossil fuels, primarily coal and natural gas, with coal accounting for the largest single share (see Table 4-3).

**Table 4-3. Electricity Net Generation in 2010 (Billion kWh)**

	<b>Net Generation (Billion kWh)</b>	<b>Fuel Source Share</b>
Coal	1,847	44.8%
Petroleum	37	0.90%
Natural Gas	988	23.9%
Other Gases	11	0.3%
Nuclear	807	19.6%
Hydroelectric	260	6.3%
Other	175	4.2%
<b>Total</b>	<b>4,125</b>	<b>100%</b>

Source: EIA 2010a

Note: Retail sales are not equal to net generation because net generation includes net exported electricity and loss of electricity that occurs through transmission and distribution.

Coal-fired generating units have historically supplied “base-load” electricity, the portion of electricity loads which are continually present, and typically operate throughout the day. Along with nuclear generation, these coal units meet the part of demand that is relatively constant. Although much of the coal fleet operates as base load, there can be notable differences across various facilities (see Table 4-4). For example, coal-fired units less than 100 MW in size compose 37 percent of the total number of coal-fired units, but only 6 percent of total coal-fired capacity. Gas-fired generation is better able to vary output and is the primary option used to meet the variable portion of the electricity load and typically supplies “peak” power, when there is increased demand for electricity (for example, when businesses operate throughout the day or when people return home from work and run appliances and heating/air-conditioning), versus late at night or very early in the morning, when demand for electricity is reduced.

The evolving economics of the power sector, in particular the increased natural gas supply and relatively low natural gas prices, have resulted in more gas being utilized as base load energy. Projections of new capacity and the impact of this rule on these new sources are discussed in more detail in Chapter 5 of this RIA.

**Table 4-4. Coal Steam Electricity Generating Units, by Size, Age, Capacity, and Thermal Efficiency (Heat Rate)**

Unit Size Grouping (MW)			No. Units	% of All Units	Avg. Age	Avg. Net Summer Capacity (MW)	Total Net Summer Capacity (MW)	% Total Capacity	Avg. Heat Rate (Btu/kWh)
0	to	25	193	15%	45	15	2,849	1%	11,154
>25	to	49	108	9%	42	38	4,081	1%	11,722
50	to	99	162	13%	47	75	12,132	4%	11,328
100	to	149	269	21%	49	141	38,051	12%	10,641
150	to	249	81	6%	43	224	18,184	6%	10,303
250	and up		453	36%	34	532	241,184	76%	10,193
<b>Totals</b>			<b>1,266</b>				<b>316,480</b>		

Source: National Electric Energy Data System (NEEDS) v.4.10

Note: The average heat rate reported is the mean of the heat rate of the units in each size category (as opposed to a generation-weighted or capacity-weighted average heat rate.) A lower heat rate indicates a higher level of fuel efficiency. Table is limited to coal-steam units online in 2010 or earlier, and excludes those units with planned retirements.

#### **4.2.2 Transmission**

Transmission is the term used to describe the movement of electricity over a network of high voltage lines, from electric generators to substations where power is stepped down for local distribution. In the US and Canada, there are three separate interconnected networks of high voltage transmission lines,<sup>1</sup> each operating at a common frequency. Within each of these transmission networks, there are multiple areas where the operation of power plants is monitored and controlled to ensure that electricity generation and load are kept in balance. In some areas, the operation of the transmission system is under the control of a single regional operator; in others, individual utilities coordinate the operations of their generation, transmission, and distribution systems to balance their common generation and load needs.

<sup>1</sup>These three network interconnections are the western US and Canada, corresponding approximately to the area west of the Rocky Mountains; eastern US and Canada, not including most of Texas; and a third network operating in most of Texas. These are commonly referred to as the Western Interconnect Region, Eastern Interconnect Region, and ERCOT, respectively.

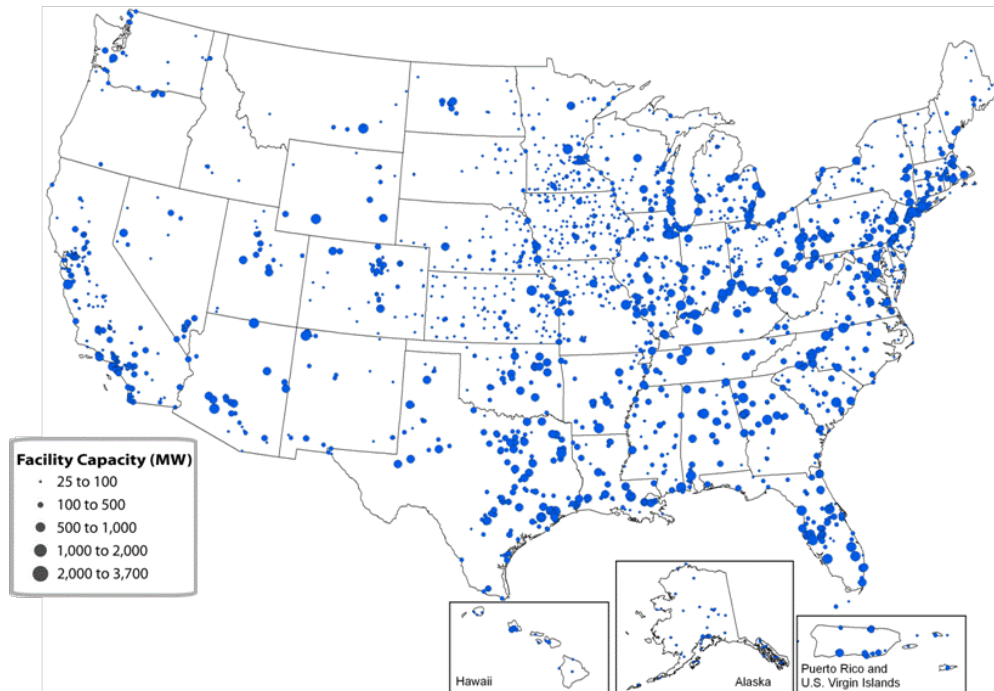

**Figure 4-1. Fossil Fuel-Fired Electricity Generating Facilities, by Size**

Source: National Electric Energy Data System (NEEDS) 4.10

Note: This map displays facilities in the NEEDS 4.10 IPM frame. NEEDS reflects available capacity on-line by the end of 2011. This includes planned new builds and planned retirements. In areas with a dense concentration of facilities, some facilities may be obscured.

### **4.2.3 Distribution**

Distribution of electricity involves networks of lower voltage lines and substations that take the higher voltage power from the transmission system and step it down to lower voltage levels to match the needs of customers. The transmission and distribution system is the classic example of a natural monopoly, in part because it is not practical to have more than one set of lines running from the electricity generating sources to substations or from substations to residences and business.

Transmission has generally been developed by the larger vertically integrated utilities that typically operate generation and distribution networks. Distribution is handled by a large number of utilities that often purchase and sell electricity, but do not generate it. Over the last couple of decades, several jurisdictions in the United States began restructuring the power industry to separate transmission and distribution from generation, ownership, and operation. As discussed below, electricity restructuring has focused primarily on efforts to reorganize the industry to encourage competition in the generation segment of the industry, including ensuring open access of generation to the transmission and distribution services needed to

deliver power to consumers. In many states, such efforts have also included separating generation assets from transmission and distribution assets to form distinct economic entities. Transmission and distribution remain price-regulated throughout the country based on the cost of service.

### **4.3 Deregulation and Restructuring**

The process of restructuring and deregulation of wholesale and retail electric markets has changed the structure of the electric power industry. In addition to reorganizing asset management between companies, restructuring sought a functional unbundling of the generation, transmission, distribution, and ancillary services the power sector has historically provided, with the aim of enhancing competition in the generation segment of the industry.

Beginning in the 1970s, government policy shifted against traditional regulatory approaches and in favor of deregulation for many important industries, including transportation (notably commercial airlines), communications, and energy, which were all thought to be natural monopolies (prior to 1970) that warranted governmental control of pricing. However, deregulation efforts in the power sector were most active during the 1990s. Some of the primary drivers for deregulation of electric power included the desire for more efficient investment choices, the economic incentive to provide least-cost electric rates through market competition, reduced costs of combustion turbine technology that opened the door for more companies to sell power with smaller investments, and complexity of monitoring utilities' cost of service and establishing cost-based rates for various customer classes.

The pace of restructuring in the electric power industry slowed significantly in response to market volatility in California and financial turmoil associated with bankruptcy filings of key energy companies. By the end of 2001, restructuring had either been delayed or suspended in eight states that previously enacted legislation or issued regulatory orders for its implementation (shown as "Suspended" in Figure 4-2 below). Another 18 other states that had seriously explored the possibility of deregulation in 2000 reported no legislative or regulatory activity in 2001 (EIA, 2003) ("Not Active" in Figure 4-2 below). Currently, there are 15 states where price deregulation of generation (restructuring) has occurred ("Active" in Figure 4-2 below). Power sector restructuring is more or less at a standstill; there have been no recent proposals to the Federal Energy Regulatory Commission (FERC) for actions aimed at wider restructuring, and no additional states have recently begun retail deregulation activity.

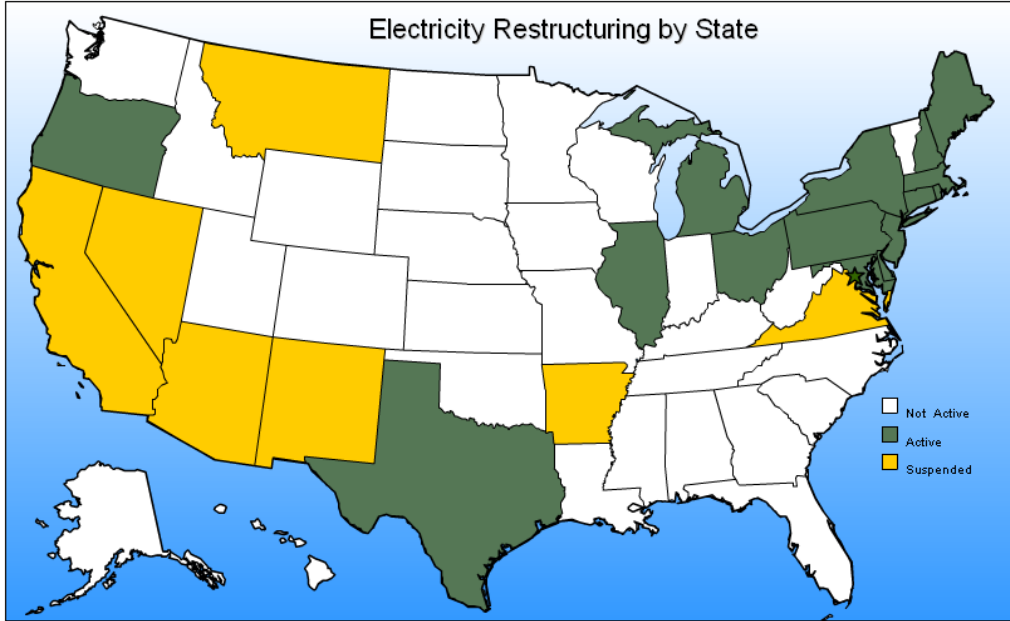

**Figure 4-2. Status of State Electricity Industry Restructuring Activities**

Source: EIA 2010b.

#### **4.4 Emissions of Greenhouse Gases from Electric Utilities**

The burning of fossil fuels, which generates about 70 percent of our electricity nationwide, results in emissions of greenhouse gases. The power sector is a major contributor of CO<sub>2</sub> in particular, but also contributes to emissions of sulfur hexafluoride (SF<sub>6</sub>), CH<sub>4</sub>, and N<sub>2</sub>O. In 2009, the power sector accounted for 33 percent of total nationwide greenhouse gas emissions, measured in CO<sub>2</sub> equivalent, a slight increase from its 30 percent share in 1990. Table 4-5 and Figure 4-3 show the contributions of the power sector relative to other major economic sectors. Table 4-6 and Figure 4-4 show the contributions of CO<sub>2</sub> and other GHGs from the power sector.



**Table 4-5. Domestic Emissions of Greenhouse Gases, by Economic Sector (million metric tons of CO<sub>2</sub> equivalent)**

Implied Sectors	1990	1995	2000	2005	2009
Electric Power Industry	1,869	1,995	2,338	2,445	2,193
Transportation	1,545	1,695	1,932	2,017	1,812
Industry	1,564	1,591	1,544	1,442	1,323
Agriculture	429	465	485	493	490
Commercial	396	397	381	387	410
Residential	345	367	386	371	360
U.S. Territories	34	41	46	58	46
Total Emissions	6,182	6,551	7,113	7,214	6,633

Source: EPA 2011

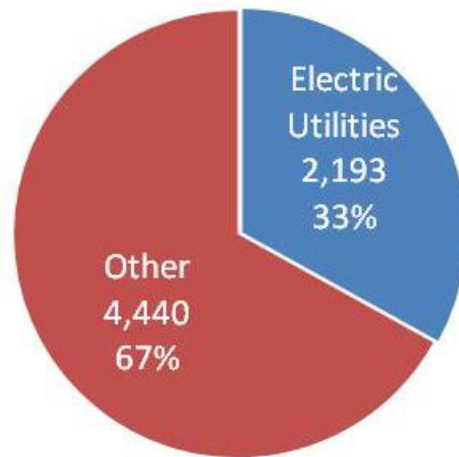

**Figure 4-3. Domestic Emissions of Greenhouse Gases, 2009 (million metric tons of CO<sub>2</sub> equivalent)**

Source: EPA 2011

**Table 4-6. Electricity Generation-Related Greenhouse Gas Emissions, 2009 (million metric tons of CO<sub>2</sub> equivalent)**

Source	Total Emissions
<b>CO<sub>2</sub></b>	<b>2,170.1</b>
CO <sub>2</sub> from Fossil Fuel Combustion	2,154.0
<i>Coal</i>	1,747.6
<i>Natural Gas</i>	373.1
<i>Petroleum</i>	32.9
<i>Geothermal</i>	0.4
Incineration of Waste	12.3
Limestone and Dolomite Use	3.8
<b>CH<sub>4</sub></b>	<b>0.7</b>
Stationary Combustion*	0.7
Incineration of Waste	+
<b>N<sub>2</sub>O</b>	<b>9.4</b>
Stationary Combustion*	9.0
Incineration of Waste	0.4
<b>SF<sub>6</sub>**</b>	<b>12.8</b>
Electrical Transmission and Distribution	12.8
<b>Total</b>	<b>2,193.0</b>

Source: EPA 2011

\* Includes only stationary combustion emissions related to the generation of electricity.

\*\* SF<sub>6</sub> is not covered by this rule, which specifically regulates GHG emissions from combustion.

+ Does not exceed 0.05 Tg CO<sub>2</sub> Eq. or 0.05 percent.

The amount of CO<sub>2</sub> emitted during the combustion of fossil fuels varies according to the carbon content and heating value of the fuel used (EIA, 2000) (see Table 4-7). Coal has higher carbon content than oil or natural gas and, thus, releases more CO<sub>2</sub> during combustion. Coal emits around 1.7 times as much carbon per unit of energy when burned as does natural gas and 1.25 times as much as oil (EPA 2011).

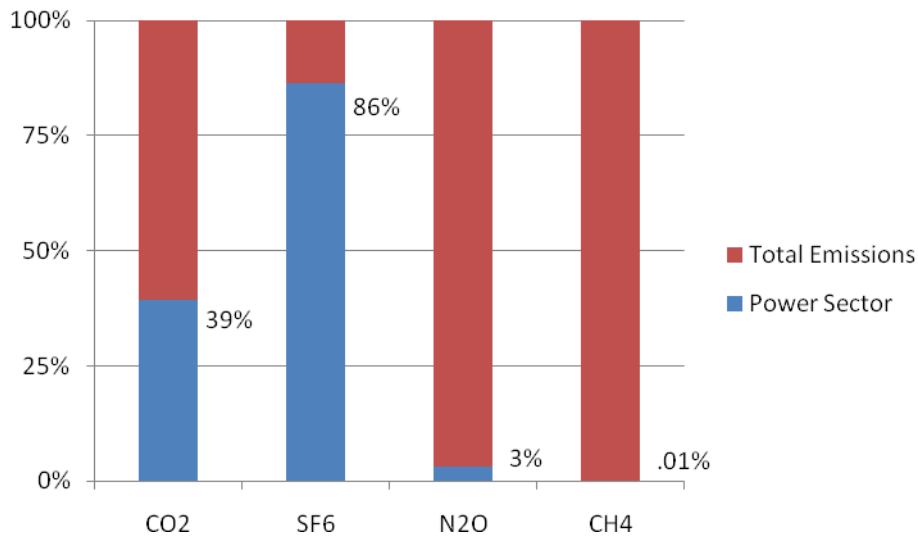

**Figure 4-4. GHG Emissions from the Power Sector Relative to Total Domestic GHG Emissions (2009)**

Source: EPA 2011

**Table 4-7. Fossil Fuel Emission Factors in EPA Modeling Applications**

Fuel Type	Carbon Dioxide (lbs/MMBtu)
Coal	
Bituminous	205.2 – 206.6
Subbituminous	212.7 – 213.1
Lignite	213.5 – 217.0
Natural Gas	117.1
Fuel Oil	
Distillate	161.4
Residual	161.4 – 173.9
Biomass*	195
Waste Fuels	
Waste Coal	205.7
Petroleum Coke	225.1
Fossil Waste	321.1
Non-Fossil Waste	0
Tires	189.5
Municipal Solid Waste	91.9

Source: Documentation for IPM Base Case v.4.10. See also Table 9.9 of IPM Documentation.

Note: CO<sub>2</sub> emissions presented here for biomass account for combustion only and do not reflect lifecycle emissions from initial photosynthesis (carbon sink) or harvesting activities and transportation (carbon source).

## **4.5 Pollution Control Technologies**

There are several methods to reduce CO<sub>2</sub> emissions from the power sector, including carbon capture and storage and improved fuel efficiency, which are discussed in more detail in the following sections. Additional methods for CO<sub>2</sub> reduction include switching to lower-emitting fuels, increased generation share from lower-emitting sources, decreased loss of power via transmission and distribution systems, and improved end-use efficiency lowering electricity demand for the same level of service provided. The first three strategies are within the sphere of a generator's decision-making, whereas the latter two strategies are only indirectly related to generators. The fourth strategy is an inherent property of the power system responding to the implicit value of emissions as grid operators make dispatch decisions to meet electricity demand at least cost (including the cost of harmful emissions). Increased construction of natural gas-fired EGU capacity will increase the number of lower-emitting sources from which grid operators may select to meet electricity demand.

### **4.5.1 Carbon Capture and Storage (CCS)**

Carbon capture technology has been successfully applied since 1930 on several smaller scale industrial facilities and is currently in the demonstration phase for power sector applications. There are currently larger-scale projects under construction or in the advanced planning stages. CCS can be achieved through either pre-combustion or post-combustion capture of CO<sub>2</sub> from a gas stream associated with the fuel combusted. For post-combustion capture, flue gas CO<sub>2</sub> stripping with a liquid absorbent which selectively reacts with the gaseous carbon dioxide to remove it from the combustion gas stream. The absorbent, upon saturation, transfers to a downstream operation which regenerates the absorbent by desorbing the CO<sub>2</sub> back to gaseous form. The absorbent recycles back into the process to repeat the capture cycle while the removed carbon dioxide is compressed, sent to storage and sequestered. This process is illustrated for a pulverized coal power plant in Figure 4-5.

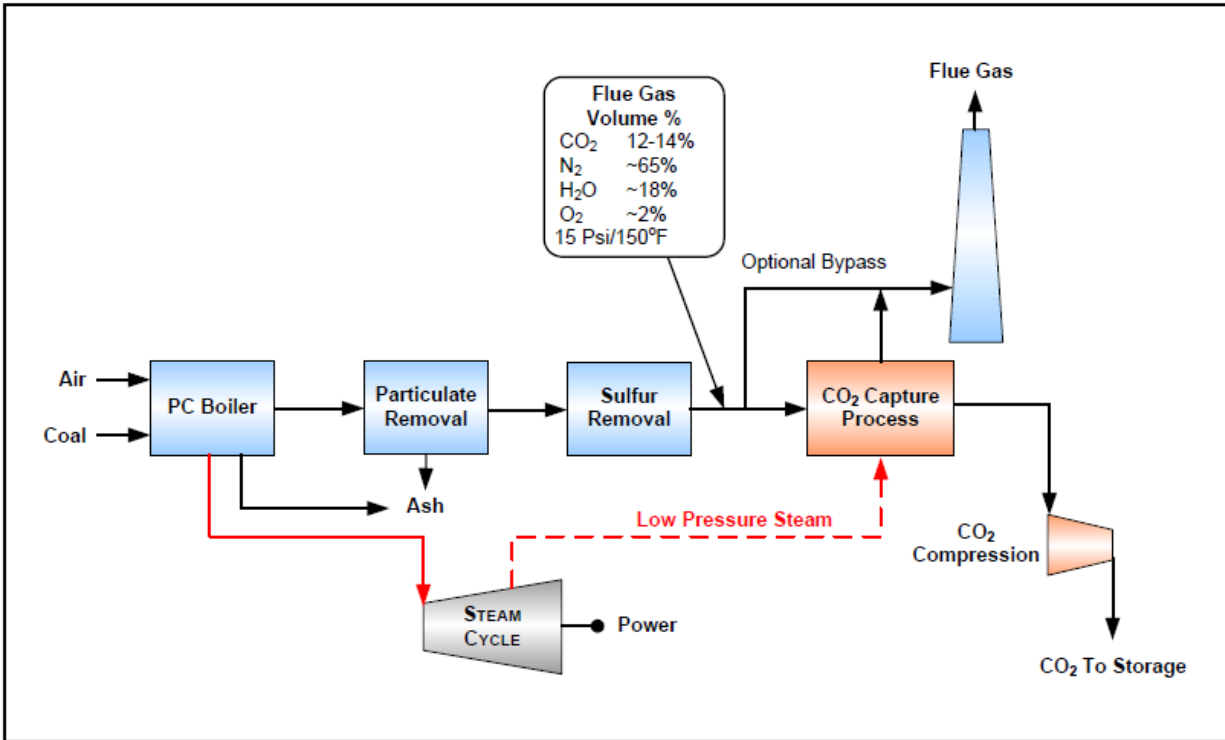

**Figure 4-5. Post-Combustion CO<sub>2</sub> Capture for a Pulverized Coal Power Plant**

Source: Interagency Task Force on Carbon Capture and Storage 2010

Pre-combustion capture is mainly applicable to IGCC facilities, where the fuel is converted into gaseous components (“syngas”) under heat and pressure and the carbon contained in the syngas is captured before combustion. These processes are energy intensive. For post-combustion, a station's net generating output will be notably lower due to the energy needs of the capture process. For pre-combustion technology, a significant amount of energy is needed to gasify the fuel(s). This process is illustrated in Figure 4-6. For more detail on the current state of CCS technology, see the “Report of the Interagency Task Force on Carbon Capture and Storage” (2010).

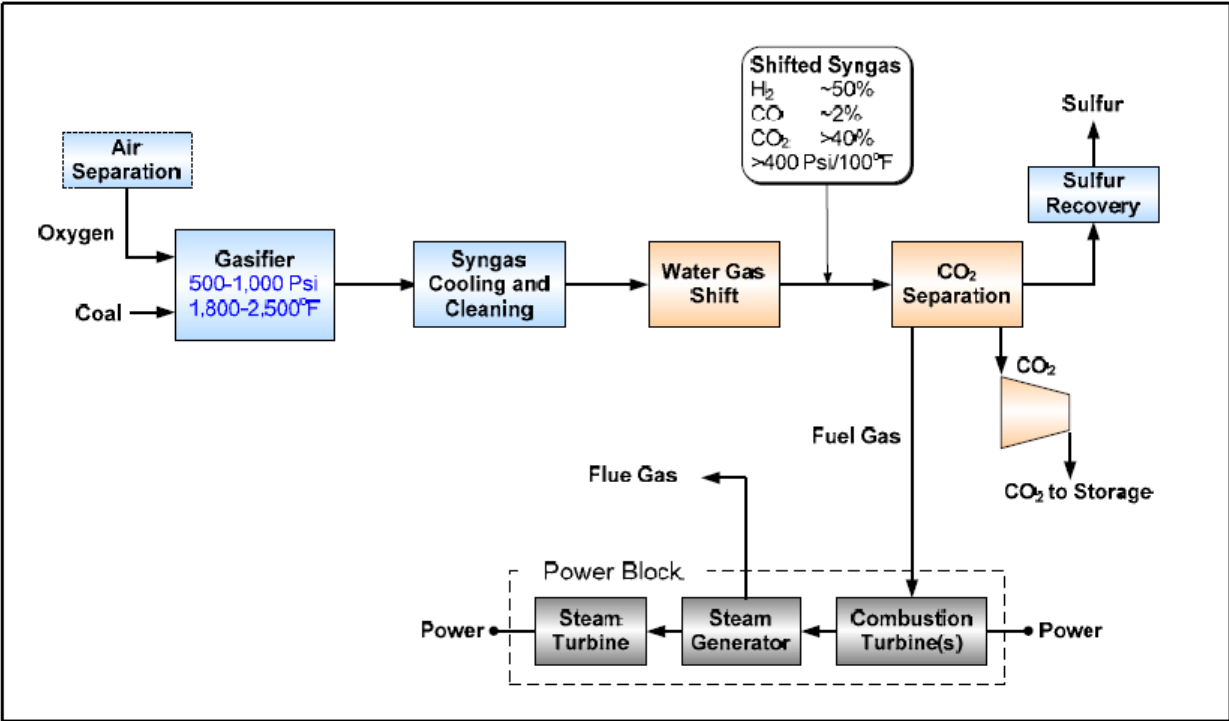

**Figure 4-6. Pre-Combustion CO<sub>2</sub> Capture for an IGCC Power Plant**

Source: Interagency Task Force on Carbon Capture and Storage 2010

**4.5.2 Thermal Efficiency Improvements**

As the thermal (i.e. fuel) efficiency of a coal-fired EGU is increased, less coal is burned per kilowatt-hour (kWh) generated, and there is a corresponding decrease in CO<sub>2</sub> and other emissions per unit of energy generated. Numerous alternatives are available for improving generating unit efficiency (Sargent & Lundy, 2009). Regular maintenance can achieve and sustain optimal operational conditions, such as minimizing leakage of heat, assuring all components are operating optimally, maintaining furnace operation near peak efficiency, ensuring furnace soot removal system are functioning properly, and repairing tube leaks. Efficiency gains can also be achieved through replacement of inefficient or obsolete equipment, which can reduce parasitic power loads.<sup>2</sup> There are many small actions that can be undertaken which, cumulatively, can result in notable efficiency improvements. Such improvements include optimizing air pre-heaters, installing heat recovery systems, reducing steam leaks, and refurbishing the steam turbine. In a 2010 white paper, EPA summarized the efficiency

<sup>2</sup> Reducing parasitic power loads increases the amount of generation for sale and therefore, where economical, plant managers have an incentive to avoid these losses. However, reducing these loads does not necessarily lower the gross CO<sub>2</sub> emission rate of a plant, and therefore the structure of the proposed rule may not significantly increase the incentive to reduce these losses.

improvement techniques identified by the National Energy Technology Laboratory (NETL) through a review of published articles and technical papers (EPA, 2010). The summary of these findings is shown in Table 4-8.

**Table 4-8. Existing Coal-Fired EGU Efficiency Improvements Reported for Actual Efficiency Improvement Projects**

Efficiency Improvement Technology	Description	Reported Efficiency Increase <sup>a</sup>
Combustion Control Optimization	Combustion controls adjust coal and air flow to optimize steam production for the steam turbine/generator set. The technologies include instruments that measure carbon levels in ash, coal flow rates, air flow rates, CO levels, oxygen levels, slag deposits, and burner metrics as well as advanced coal nozzles and plasma assisted coal combustion. Combustion control for a coal-fired EGU is complex and impacts a number of important operating parameters including combustion efficiency, steam temperature, furnace slagging and fouling, and NO <sub>x</sub> formation.	0.15 to 0.84%
Cooling System Heat Loss Recovery	Controls are applied to recover a portion of the heat loss from the warm cooling water exiting the steam condenser prior to its circulation through a cooling tower or discharge to a water body. The identified technologies include replacing the cooling tower fill (heat transfer surface) and tuning the cooling tower and condenser.	0.2 to 1%
Flue Gas Heat Recovery	Flue gas exit temperature from the air pre-heater can range from 250- 350°F depending on the acid dew point temperature of the flue gas, which is dependent on the concentration of vapor phase sulfuric acid and moisture. For power plants equipped with wet FGD systems, the flue gas is further cooled to approximately 125°F as it is sprayed with the FGD reagent slurry. However, it may be possible to recover some of this lost energy in the flue gas to preheat boiler feedwater via use of a condensing heat exchanger.	0.3 to 1.5%

(continued)

**Table 4-8. Existing Coal-Fired EGU Efficiency Improvements Reported for Actual Efficiency Improvement Projects (continued)**

Efficiency Improvement Technology	Description	Reported Efficiency Increase <sup>a</sup>
Low-rank Coal Drying	Subbituminous and lignite coals contain relatively large amounts of moisture (15 to 40%) compared to bituminous coal (less than 10%). A significant amount of the heat released during combustion of low-rank coals is used to evaporate this moisture, rather than generate steam for the turbine. As a result, boiler efficiency is typically lower for plants burning low-rank coal. The technologies include using waste heat from the flue gas and/or cooling water systems to dry low-rank coal prior to combustion.	0.1 to 1.7%
Soot Blower Optimization	Soot blowers intermittently inject high velocity jets of steam or air to clean coal ash deposits from boiler tube surfaces in order to maintain adequate heat transfer. Proper control of the timing and intensity of individual soot blowers is important to maintain steam temperature and boiler efficiency. The identified technologies include intelligent or neural-network soot blowing (i.e., soot blowing in response to real-time conditions in the boiler) and detonation soot blowing.	0.1 to 0.65%
Steam Turbine Design	Recoverable energy losses can result from the mechanical design or physical condition of the steam turbine. For example, steam turbine manufacturers have improved the design of turbine blades and steam seals which can increase both efficiency and output (i.e., steam turbine dense pack technology).	0.84 to 2.6%

Source: EPA 2010, NETL 2008

<sup>a</sup> Reported efficiency improvement metrics adjusted to common basis by conversion methodology assuming individual component efficiencies for a reference plant as follows: 87 percent boiler efficiency, 40 percent turbine efficiency, 98 percent generator efficiency, and 6 percent auxiliary load. Based on these assumptions, the reference power plant has an overall efficiency of 32 percent and a net heat rate of 10,600 Btu/kWh. As a result, if a particular efficiency improvement method was reported to achieve a 1 percentage point increase in boiler efficiency, it would be converted to a 0.37 percentage point increase in overall efficiency. Likewise, a reported 100 Btu/kWh decrease in net heat rate would be converted to a 0.30 percentage point increase in overall efficiency.

In addition to the techniques described above, new coal-fired EGU projects may use other methods to maximize thermal efficiency. Under constant energy input, a higher pressure and temperature for the water-steam cycle will increase the overall efficiency. Most existing boilers, however, are already operating at the maximum pressure and temperature that the boiler is designed to withstand. Most existing coal-fired EGUs have subcritical boilers that typically operate at a pressure of 2,400 pounds per square inch (psi) and temperatures between 1,000 to 1,050°F. “Supercritical” boilers are those that use steam pressures above 3200 psi and temperatures up to 1,100°F. Boilers that can operate above these conditions are considered



“ultra-supercritical.” Examples of ultra-supercritical coal-fired EGUs in Canada, Europe, and Japan are cited as representing the highest efficiency coal-fired EGUs in the world (EPA, 2010).

#### **4.5.3 Other Approaches to Reduce GHG Emissions**

While CCS and fuel efficiency improvements are more closely related to potential NSPS regulatory frameworks, they are not the only options available for EGUs to reduce emissions of CO<sub>2</sub>. As discussed previously, the amount of CO<sub>2</sub> emitted during the combustion of fossil fuels varies according to the carbon content and heating value of the fuel used (see Table 4-7). Switching from a higher-emitting to a lower-emitting fuel will reduce CO<sub>2</sub> emissions from an EGU, all other things equal. Similarly, increasing the share of generation from lower-emitting sources will also lead to a reduction in CO<sub>2</sub> emissions. As with increased generation efficiency, improvements to efficiency in transmission and electricity use will also result in reductions in CO<sub>2</sub> emissions. Note that these types of strategies would further reduce need for construction of new units.

#### **4.6 GHG Regulation in the Power Sector**

In April 2007, the Supreme Court concluded that GHGs met the CAA definition of an air pollutant, giving EPA the authority to regulate GHGs under the CAA based on the agency determination that GHG emissions from new motor vehicles cause or contribute to air pollution that may reasonably be anticipated to endanger public health or welfare. This decision to regulate GHG emissions for motor vehicles set the stage for the determination of whether other sources of GHG emissions, including stationary sources, would need to be regulated as well.

In response to the FY2008 Consolidated Appropriations Act (H.R. 2764; Public Law 110–161), EPA issued the Mandatory Reporting of Greenhouse Gases Rule (74 FR 5620) which required reporting GHG data and other relevant information from fossil fuel suppliers and industrial gas suppliers, direct greenhouse gas emitters, and manufacturers of heavy-duty and off-road vehicles and engines. The purpose of the rule was to collect accurate and timely GHG data to inform future policy decisions. As such, it did not require that sources control greenhouse gases, only that sources above certain threshold levels monitor and report emissions.

In August 2007, EPA issued a PSD permit to Deseret Power Electric Cooperative, authorizing it to construct a new waste-coal-fired EGU near its existing Bonanza Power Plant, in Bonanza, Utah. The permit did not include emissions control requirements for CO<sub>2</sub>. EPA acknowledged the Supreme Court decision, but found that decision alone did not require PSD

permits to include limits on CO<sub>2</sub> emissions. Sierra Club challenged the Deseret permit. In November 2008, the Environmental Appeals Board (EAB) remanded the permit to EPA to reconsider “whether or not to impose a CO<sub>2</sub> BACT limit in light of the ‘subject to regulation’ definition under the CAA.” The remand was based in part on EAB’s finding that there was not an established EPA interpretation of the regulatory phrase “subject to regulation.”

In December 2008, the Administrator issued a memo indicating that the PSD Permitting Program would apply to pollutants that are subject to either a provision in the CAA or a regulation adopted by EPA under the CAA that requires actual control of emissions of that pollutant. The memo further explained that pollutants for which EPA regulations only require monitoring or reporting, such as the provisions for CO<sub>2</sub> in the Acid Rain Program, are not subject to PSD permitting. Fifteen organizations petitioned EPA for reconsideration, prompting the agency to issue a revised finding in March 2009. After reviewing comments, EPA affirmed the position that PSD permitting is not triggered for a pollutant such as GHGs until a final nationwide rule requires actual control of emissions of the pollutant. For GHGs, this meant January 2011 when the first national rule limiting GHG emissions for cars and light trucks was scheduled to take effect. Therefore, a permit issued after January 2, 2011, it would have to address GHG emissions.

The Administrator signed two distinct findings in December 2009 regarding greenhouse gases under section 202(a) of the Clean Air Act. The endangerment finding indicated that current and projected concentrations of the six key well-mixed greenhouse gases —CO<sub>2</sub>, CH<sub>4</sub>, N<sub>2</sub>O, hydrofluorocarbons (HFCs), perfluorocarbons (PFCs), and SF<sub>6</sub> — in the atmosphere threaten the public health and welfare of current and future generations. These greenhouse gases have long lifetimes and, as a result, become homogeneously distributed through the lower level of the Earth’s atmosphere (IPCC, 2001). This differentiates them from other greenhouse gases that are not homogeneously distributed in the atmosphere. The cause and contribute finding indicated that the combined emissions of these well-mixed greenhouse gases from new motor vehicles and new motor vehicle engines contribute to the greenhouse gas pollution which threatens public health and welfare. Both findings were published in the Federal Register on December 15, 2009 (Docket ID EPA-HQ-OAR-2009-0171). These findings did not themselves impose any requirements on industry or other entities, but allowed EPA to regulate greenhouse gases under the Clean Air Act. This action was a prerequisite to implementing the EPA's proposed greenhouse gas emission standards for light-duty vehicles, which was finalized in January 2010. Once a pollutant is regulated under the Clean Air Act, it is subject to permitting requirements under the PSD and Title V programs.

In May 2010, EPA issued the final Tailoring Rule which set thresholds for GHG emissions that define when permits under the New Source Review PSD and Title V Operating Permit programs are required for new and existing industrial facilities. Facilities responsible for nearly 70 percent of the national GHG emissions from stationary sources, including EGUs, were subject to permitting requirements under the rule.

EPA entered into two proposed settlement agreements in December 2010 to issue rules that will address greenhouse gas emissions from fossil fuel-fired power plants and refineries. These two industrial sectors make up nearly 40 percent of the nation's greenhouse gas emissions. For natural gas, oil, and coal-fired EGUs this rule establishes NSPS for new and reconstructed sources, with the exception of combustion turbines. Existing source standards will be addressed in a later action. Details of the settlement agreements can be found on the EPA website.<sup>3</sup>

#### **4.7 Revenues, Expenses, and Prices**

Due to lower retail electricity sales, total utility operating revenues declined in 2009 to \$276 billion from a peak of almost \$300 billion in 2008. Despite revenues not returning to 2008 levels in 2010, operating expenses were appreciably lower and as a result, net income also rose in comparison to both 2008 and 2009 (see Table 4-9). Recent economic events have put downward pressure on electricity demand, thus dampening electricity prices and consumption (utility revenues), but have also reduced the price and cost of fossil fuels and other expenses. Electricity sales and revenues associated with the generation, transmission, and distribution of electricity are expected to rebound and increase modestly by 2015, when revenues are projected to be roughly \$360 billion (see Table 4-10).

Table 4-9 shows that investor-owned utilities (IOUs) earned income of about 11.5 percent compared to total revenues in 2009. Based on EIA's Annual Energy Outlook 2011, Table 4-10 shows that the power sector is projected to derive revenues of \$360 billion in 2015. Assuming the same income ratio from IOUs (with no income kept by public power), and using the same proportion of power sales from public power as observed in 2009, EPA projects that the power sector will expend over \$320 billion in 2015 to generate, transmit, and distribute electricity to end-use consumers.

Over the past 50 years, real retail electricity prices have ranged from around 7 cents per kWh in the early 1970s, to around 11 cents, reached in the early 1980s. Generally, retail

---

<sup>3</sup> <http://www.epa.gov/airquality/ghgsettlement.html>

electricity prices do not change rapidly and do not display the variability of other energy or commodity prices, although the frequency at which these prices change varies across different types of customers. Retail rate regulation has largely insulated consumers from the rising and falling wholesale electricity price signals whose variation in the marketplace on an hourly, daily, and seasonal basis is critical for driving lowest-cost matching of supply and demand. In fact, the real price of electricity today is lower than it was in the early 1960s and 1980s (see Figure 4-7).

**Table 4-9. Revenue and Expense Statistics for Major U.S. Investor-Owned Electric Utilities for 2010 (\$millions)**

	2008	2009	2010
<b>Utility Operating Revenues</b>	<b>298,962</b>	<b>276,124</b>	<b>284,373</b>
Electric Utility	266,124	249,303	260,113
Other Utility	32,838	26,822	24,260
<b>Utility Operating Expenses</b>	<b>267,263</b>	<b>244,243</b>	<b>250,122</b>
Electric Utility	236,572	219,544	226,845
Operation	175,887	154,925	159,585
Production	140,974	118,816	128,808
Cost of Fuel	47,337	40,242	44,115
Purchased Power	84,724	67,630	67,284
Other	8,937	10,970	13,013
Transmission	6,950	6,742	6,948
Distribution	3,997	3,947	4,007
Customer Accounts	5,286	5,203	5,091
Customer Service	3,567	3,857	4,741
Sales	225	178	185
Admin. and General	14,718	15,991	17,115
Maintenance	14,192	14,092	14,962
Depreciation	19,049	20,095	20,930
Taxes and Other	26,202	29,081	27,646
Other Utility	30,692	24,698	23,277
<b>Net Utility Operating Income</b>	<b>31,699</b>	<b>31,881</b>	<b>34,251</b>

Source: EIA 2010a

Note: This data does not include information for public utilities.

**Table 4-10. Projected Revenues by Service Category in 2015 for Public Power and Investor-Owned Utilities (billions)**

Generation	\$195
Transmission	36
Distribution	129
<b>Total</b>	<b>\$360</b>

Source: EIA 2011

Note: Data are derived by taking either total electricity use (for generation) or sales (transmission and distribution) and multiplying by forecasted prices by service category from Table 8 of EIA 2011 (Electricity Supply, Disposition, Prices, and Emissions).

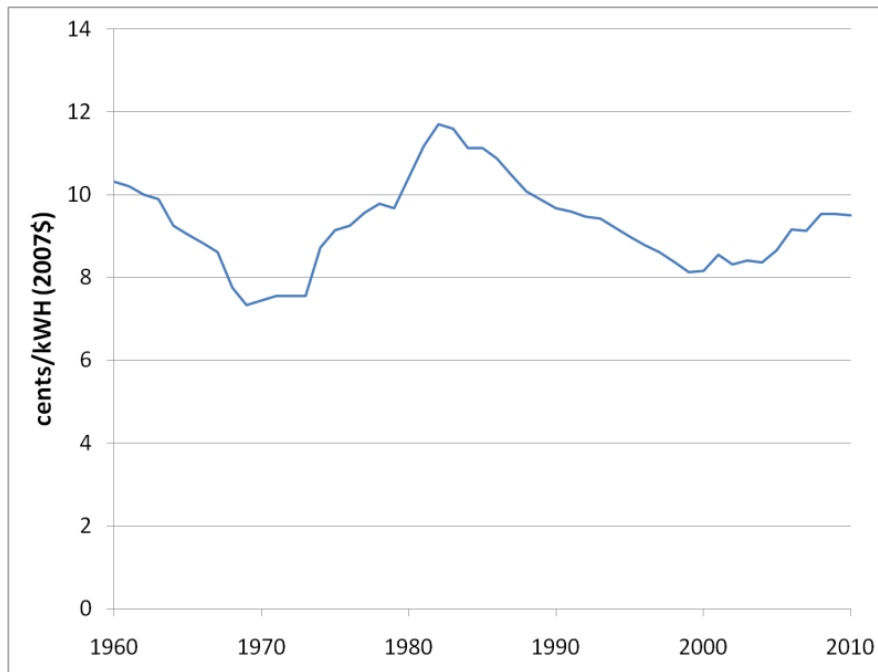

**Figure 4-7. National Average Retail Electricity Price (1960 – 2009)**

Source: EIA 2010a

On a state-by-state basis, retail electricity prices vary considerably. The Northeast and California have average retail prices that can be as much as double those of other states (see Figure 4-8).

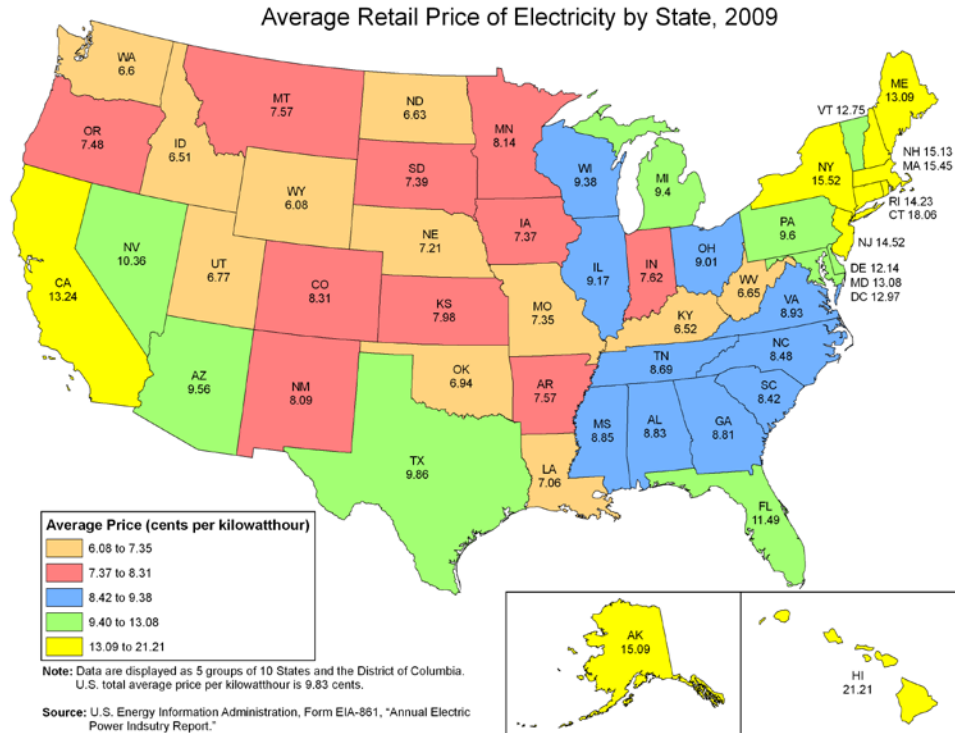

**Figure 4-8. Average Retail Electricity Price by State (cents/kWh), 2009**

Source: EIA 2009

#### 4.7.1 Natural Gas Market

The natural gas market in the United States has historically experienced significant price volatility from year to year, between seasons within a year, and can undergo major price swings during short-lived weather events (such as cold snaps leading to short-run spikes in heating demand). Over the last decade, gas prices (both Henry Hub prices and delivered prices to the power sector) have ranged from \$3 per mmBtu to as high as \$9 on an annual average basis (see Figure 4-9). During that time, the daily price of natural gas reached as high as \$15/mmBtu. Recent forecasts of natural gas have also experienced considerable revision as new sources of gas have been discovered and have come to market, although there continues to be some uncertainty surrounding the precise quantity of the resource base.

EIA projections of future natural gas prices assume trends that are consistent with historical and current market behavior, technological and demographic changes, and current laws and regulations.<sup>4</sup> Depending on actual conditions, there may be significant variation from the price projected in the reference case and the price observed. To address this uncertainty, EIA issues a range of alternative cases, including cases with higher and lower economic growth,

<sup>4</sup> AEO 2010c.

which address many of the uncertainties inherent in the long-term projections. EPA uses the reference case and a number of alternative cases in its analyses.

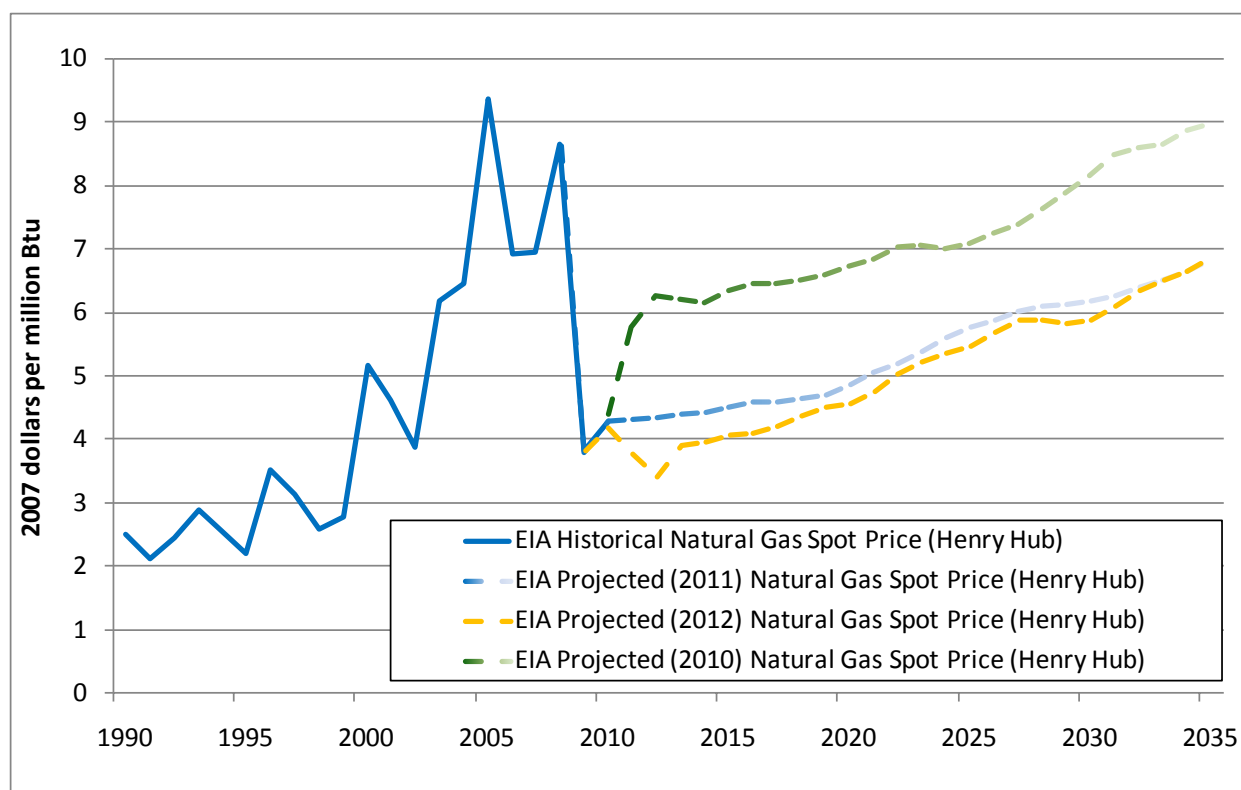

**Figure 4-9. Natural Gas Spot Price, Annual Average (Henry Hub)**

Source: EIA 2010d, EIA 2011, EIA 2012

#### 4.8 Electricity Demand and Demand Response

Electricity performs a vital and high-value function in the economy. Historically, growth in electricity consumption has been closely aligned with economic growth. Overall, the U.S. economy has become more efficient over time, producing more output (GDP) per unit of energy input, with per capita energy use fairly constant over the past 30 years (EIA, 2010e). The growth rate of electricity demanded has also been in overall decline for the past sixty years (see Figure 4-8), with several key drivers that are worth noting. First, there has been a significant structural shift in the U.S. economy towards less energy-intensive sectors, like services. Second, companies have strong financial incentives to reduce expenditures, including those for energy. Third, companies are responding to the marketplace and continually develop and bring to market new technologies that reduce energy consumption. Fourth, other policies, such as energy efficiency standards at the state and Federal level, have helped address certain market

failures. These broader changes have altered the outlook for future electricity growth (see Figure 4-10).

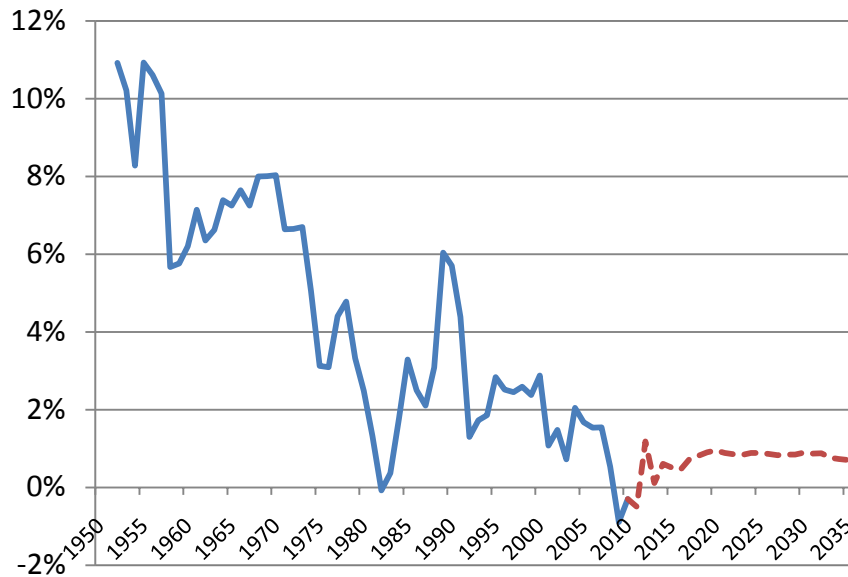

**Figure 4-10. Electricity Growth Rate (3 Year Rolling Average) and Projections from the Annual Energy Outlook 2011**

Source: EIA 2009, EIA 2011

Note: Electricity demand projections in the AEO 2012 early release are very similar to those in AEO 2011 and would not be expected to change this figure noticeably.

Energy efficiency initiatives have become more common, and investments in energy efficiency are projected to continue to increase for the next 5 to 10 years, driven in part by the growing number of states that have adopted energy efficiency resource standards.<sup>5</sup> These investments, and other energy efficiency policies at both the state and federal level, create incentives to reduce energy consumption and peak load. According to EIA, demand-side management provided actual peak load reductions of 31.7 GW in 2009. For context, the current coal fleet is roughly 320 GW of capacity.

Demand for electricity, especially in the short run, is not very sensitive to changes in prices and is considered relatively price inelastic, although some demand reduction does occur in response to price. With that in mind, EPA modeling does not typically incorporate a “demand response” in its electric generation modeling (Chapter 5) to the increases in electricity prices

<sup>5</sup> To the extent that EIA includes these measures in its baseline forecast from the Annual Energy Outlook, EPA has also incorporated them into the baseline for purposes of assessing the economic impacts of this proposed rule. See AEO 2011 and Chapter 7 of the IPM documentation for more detail.



typically projected for EPA rulemakings. Electricity demand is considered to be constant in EPA modeling applications and the reduction in production costs that would result from lower demand is not considered in the primary analytical scenario that is modeled. This leads to some overstatement in the private compliance costs that EPA estimates for rules where compliance costs are anticipated for a rulemaking. Note that this NSPS is not anticipated to create compliance costs for new EGU sources.

#### 4.9 References

Interagency Task Force on Carbon Capture and Storage. *Report of the Interagency Task Force on Carbon Capture and Storage*. August 2010. Available online at: <http://www.epa.gov/climatechange/downloads/CCS-Task-Force-Report-2010.pdf>.

Intergovernmental Panel on Climate Change. *Climate Change 2001: The Scientific Basis*. 2001. Available online at: [http://www.grida.no/publications/other/ipcc\\_tar/?src=/climate/ipcc\\_tar/wg1/218.htm](http://www.grida.no/publications/other/ipcc_tar/?src=/climate/ipcc_tar/wg1/218.htm).

National Energy Technology Laboratory (NETL). *Reducing CO<sub>2</sub> Emissions by Improving the Efficiency of Existing Coal-fired Power Plant Fleet*. July 2008. Available online at: <http://www.netl.doe.gov/energy-analyses/pubs/CFPP%20Efficiency-FINAL.pdf>.

Pacific Northwest National Laboratory (PNNL). *An Assessment of the Commercial Availability of Carbon Dioxide Capture and Storage Technologies as of June 2009*. June 2009. Available online at: [http://www.pnl.gov/science/pdf/PNNL-18520\\_Status\\_of\\_CCS\\_062009.pdf](http://www.pnl.gov/science/pdf/PNNL-18520_Status_of_CCS_062009.pdf).

Sargent & Lundy, LLC. *Coal-fired Power Plant Heat Rate Reductions*. January 2009. Available online at: <http://www.epa.gov/airmarkets/resource/docs/coal-fired.pdf>.

U.S. Energy Information Administration (U.S. EIA). *Carbon Dioxide Emissions from the Generation of Electric Power in the United States*. July 2000. Available online at: <ftp://ftp.eia.doe.gov/environment/co2emiss00.pdf>.

U.S. Energy Information Administration (U.S. EIA). *Electric Power Annual 2003*. 2003. Available online at: <http://www.eia.gov/electricity/annual/archive/03482003.pdf>.

U.S. Energy Information Administration (U.S. EIA). *Electric Power Annual 2009*. 2009. Available online at: <http://www.eia.gov/electricity/annual/archive/03482009.pdf>.

U.S. Energy Information Administration (U.S. EIA). *Electric Power Annual 2010*. 2010a. Available online at: <http://www.eia.gov/electricity/annual/>.

U.S. Energy Information Administration (U.S. EIA). "Status of Electricity Restructuring by State." 2010b. Available online at: [http://www.eia.gov/cneaf/electricity/page/restructuring/restructure\\_elect.html](http://www.eia.gov/cneaf/electricity/page/restructuring/restructure_elect.html).

- U.S. Energy Information Administration (U.S. EIA). *AEO 2010 Retrospective Review*. 2010c. Available online at: <http://www.eia.gov/forecasts/aeo/retrospective/>.
- U.S. Energy Information Administration (U.S. EIA). *Annual Energy Outlook 2010*. 2010d. Available online at: <http://www.eia.gov/oiaf/archive/aeo10/index.html>.
- U.S. Energy Information Administration (U.S. EIA). *Annual Energy Review 2010*. 2010e. Available online at: <http://www.eia.gov/totalenergy/data/annual/pdf/aer.pdf>.
- U.S. Energy Information Administration (U.S. EIA). *Annual Energy Outlook 2011*. 2011. Available online at: <http://www.eia.gov/forecasts/archive/aeo11/>.
- U.S. Energy Information Administration (U.S. EIA). *Annual Energy Outlook 2012 (Early Release)*. 2012. Available online at: <http://www.eia.gov/forecasts/aeo/>.
- U.S. Environmental Protection Agency (U.S. EPA). *Available and Emerging Technologies for Reducing Greenhouse Gas Emissions from Coal-Fired Electric Generating Units*. October 2010. Available online at: <http://www.epa.gov/nsr/ghgdocs/electricgeneration.pdf>.
- U.S. Environmental Protection Agency (U.S. EPA). *Inventory of U.S. Greenhouse Gas Emissions and Sinks: 1990–2009*. April 2011. Available online at: [http://epa.gov/climatechange/emissions/downloads11/US-GHG-Inventory-2011-Complete\\_Report.pdf](http://epa.gov/climatechange/emissions/downloads11/US-GHG-Inventory-2011-Complete_Report.pdf).

## CHAPTER 5

### COSTS, BENEFITS, ECONOMIC, AND ENERGY IMPACTS

#### 5.1 Synopsis

This chapter reports the compliance cost, economic, and energy impact analysis performed for the EGU GHG NSPS. EPA used IPM, developed by ICF Consulting, in this analysis. IPM is a dynamic linear programming model that can be used to examine air pollution control policies throughout the United States for the entire power system. EPA used the IPM model to forecast likely future electricity market conditions with and without the proposed rule.

Even in a baseline scenario without the proposed rule, the only capacity additions subject to this rule projected during the analysis period (through 2020<sup>1</sup>) are compliant with the requirements of this rule (e.g., combined cycle natural gas and small amounts of coal with CCS supported by DOE funding). This conclusion also holds for several sensitivity analyses EPA performed. As a result, under a wide range of future electricity market conditions, this proposed EGU GHG NSPS is not expected to change GHG emissions for newly constructed EGUs, and is anticipated to impose negligible costs, economic impacts, or energy impacts on the EGU sector or society. An additional illustrative analysis, presented at the end of this chapter, indicates that even in the unlikely event that electricity market conditions change enough to support additional new coal, the proposed EGU GHG NSPS would provide net benefits. This analysis concluded based on sensitivity analyses that the price of natural gas would have to increase to approximately \$10/mmBtu for coal boilers without CCS to become competitive with combined cycle natural gas units, which is projected to be very unlikely.<sup>2</sup>

#### 5.2 Background

Over the last decade, EPA has conducted extensive analyses of regulatory actions impacting the power sector. These efforts support the Agency's understanding of key policy variables and provide the framework for how the Agency estimates the costs and benefits associated with its actions. Current forecasts for the mix of new, and utilization of existing, generating capacity are a key input into informing the design of EPA's proposal. Given excess capacity within the existing fleet and relatively low forecasts of electricity demand growth, there is limited new capacity, of any type, expected to be constructed over the next decade. A small number of new coal-fired power plants have been built in recent years; however, EPA

---

<sup>1</sup> Note that while the analysis presented in this RIA is for the year 2020, IPM projections were also made for 2030 and are available in the docket.

<sup>2</sup> This chapter presents all costs in 2007\$.

does not forecast the construction of any new unplanned coal-fired additions over the time horizon of this analysis (through the year 2020). For more detailed discussion of this forecast, see section 5.5.

Under current and foreseeable future market conditions affecting new capacity additions, gas-fired generating technologies can produce electricity at a lower levelized cost than coal-fired generating technologies, and therefore utilities are expected to rely heavily on combustion turbines and combined cycle plants using natural gas when they do need to expand capacity during the time horizon considered for this analysis. Current and projected natural gas prices are considerably lower than the prices observed over the past decade, largely due to advances in hydraulic fracturing and horizontal drilling techniques that have opened up new shale gas resources and substantially increased the supply of economically recoverable natural gas. According to EIA,

Shale gas refers to natural gas that is trapped within shale formations. Shales are fine-grained sedimentary rocks that can be rich sources of petroleum and natural gas. Over the past decade, the combination of horizontal drilling and hydraulic fracturing has allowed access to large volumes of shale gas that were previously uneconomical to produce. The production of natural gas from shale formations has rejuvenated the natural gas industry in the United States.

The U.S. Energy Information Administration's Annual Energy Outlook 2012 (Early Release) estimates that the United States possessed 2,214 trillion cubic feet (Tcf) of technically recoverable natural gas resources as of January 1, 2010. Natural gas from proven and unproven shale resources accounts for 542 Tcf of this resource estimate. Many shale formations, especially the Marcellus, are so large that only small portions of the entire formations have been intensively production-tested. Consequently, the estimate of technically recoverable resources is highly uncertain, and is regularly updated as more information is gained through drilling and production. At the 2010 rate of U.S. consumption (about 24.1 Tcf per year), 2,214 Tcf of natural gas is enough to supply over 90 years of use. Although the estimate of the shale gas resource base is lower than in the prior edition of the Outlook, shale gas production estimates increased between the 2011 and 2012 Outlooks, driven by lower drilling costs and continued

drilling in shale plays with high concentrations of natural gas liquids and crude oil, which have a higher value in energy equivalent terms than dry natural gas.<sup>3</sup>

Based on these market conditions, and detailed analysis and modeling conducted by EPA, the levelized cost of generation from a new natural gas power plant is expected to be lower on average than the levelized cost of generation from a new coal-fired power plant.<sup>4,5</sup> This trend has already been observed recently, as natural gas-fired capacity has been the technology of choice for power generation over the last few years (see Figure 5-1).

---

<sup>3</sup> For more information, see: [http://www.eia.gov/forecasts/archive/aeo11/IF\\_all.cfm#prospectshale](http://www.eia.gov/forecasts/archive/aeo11/IF_all.cfm#prospectshale);  
[http://www.eia.gov/energy\\_in\\_brief/about\\_shale\\_gas.cfm](http://www.eia.gov/energy_in_brief/about_shale_gas.cfm)

<sup>4</sup> See Table 5-4, which reports the levelized cost of new generation in the Annual Energy Outlook (AEO) 2011.

<sup>5</sup> Note that EPA's analysis, which is consistent with this expectation, is based on sophisticated IPM modeling, and is not based on simplified LCOE assumptions.

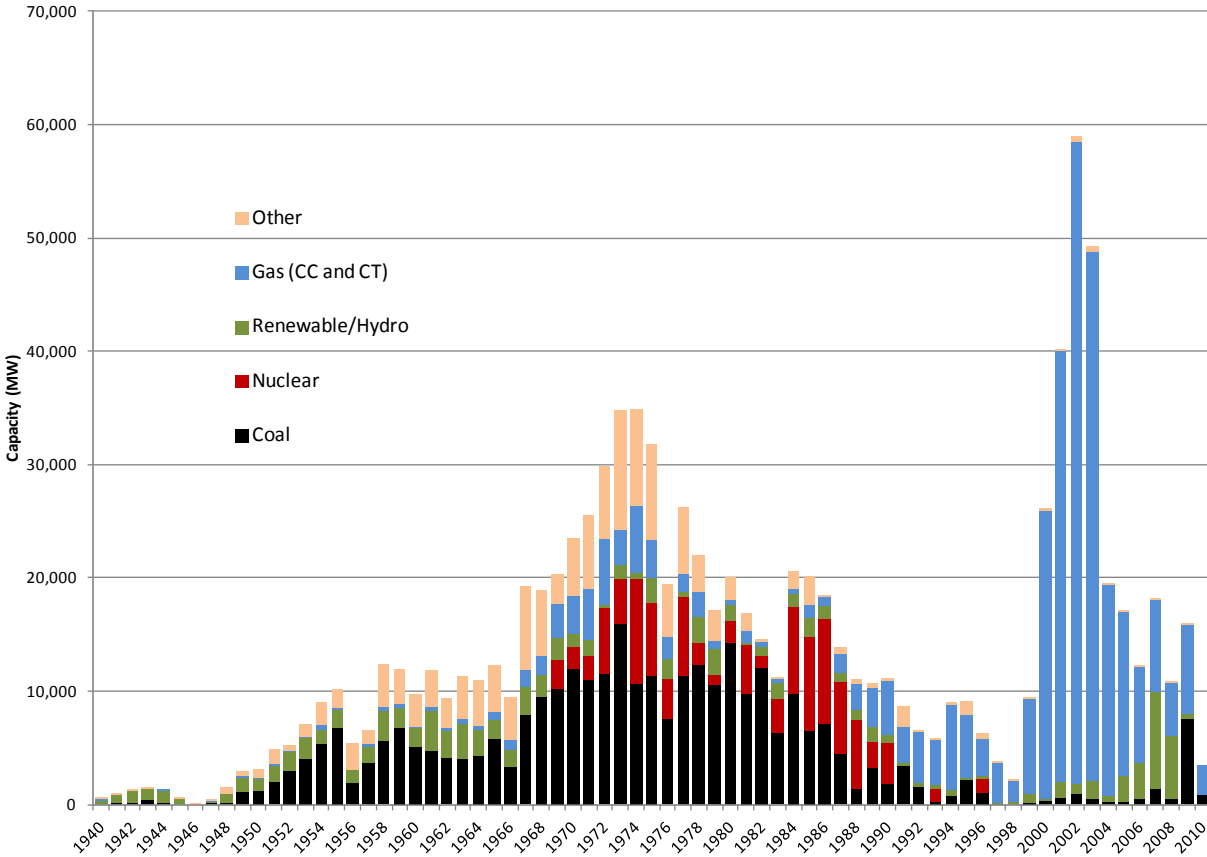

**Figure 5-1. Historical U.S. Power Plant Capacity Additions, by Technology**

Source: National Electric Energy Data System (NEEDS) v4.10\_PT0x

Note: Renewables include geothermal, biomass, solar, and wind energy technologies. A considerable amount of renewables were built in 2009 and 2010, and these are reflected in EPA modeling applications but not necessarily in NEEDS.

Numerous energy sector modeling efforts, including recent projections from EIA, have provided results that are consistent with these findings. The Annual Energy Outlook (AEO) for 2011 shows a modest amount of CCS-equipped new coal-fired power coming online past 2012 that would be in compliance with this proposal.<sup>6</sup> EIA includes some additional new coal with CCS in its baseline (2 GW), an assumption which EPA has adopted in IPM. The new CCS is in response to existing Federal incentives for the technology (the Emergency Economic Stabilization Act of 2008 and the American Reinvestment and Recovery Act of 2009). According to the AEO 2011, the majority of new generating capacity is forecast to be either natural gas-fired or renewable, with some lesser amounts of nuclear power. The AEO 2011 is based on

<sup>6</sup> AEO 2011 has a small amount of planned coal capacity that is under construction and expected to come online in the next year. This capacity represents certain units that likely fit the definition of transitional sources under this proposal. It also has 2 GW of unplanned coal capacity, which reflects new coal with CCS in response to Federal incentives.

existing policy and regulations, such as state Renewable Portfolio Standard programs and Federal tax credits for renewables.<sup>7</sup> Based on EIA analysis, DOE concluded, that “the low capital expense, technical maturity, and dispatchability of natural gas generation are likely to dominate investment decisions under current policies and projected prices.”<sup>8</sup> The economics favoring new NGCC additions instead of conventional coal are robust under a range of sensitivity cases examined in the AEO. Unplanned additions of coal by 2020 are also not forecast in sensitivity cases that separately examine higher economic growth, lower coal prices, lower capital costs for fossil capacity, no risk premium for greenhouse gas emissions liability from conventional coal, slower oil and gas technology deployment, lower shale gas recovery per play, and lower shale gas recovery per well. In addition, the EIA’s AEO 2012 Early Release (AEO 2012 ER) does not forecast new unplanned coal capacity without CCS through 2020. Furthermore, it projects an increase over AEO 2011 in the price of coal relative to natural gas, strengthening the conclusion that natural gas-fired generating technologies are likely to be the fossil fuel of choice during the analysis period. The AEO 2012 ER also has lower electricity demand projections than those used in IPM, reflecting an extended economic recovery and increasing energy efficiency in end-use appliances,<sup>9</sup> which would result in the need for less new capacity in general.

EPA uses IPM to support its understanding of the economic and emissions impacts of air regulations on the power sector. IPM forecasts show patterns of future power plant deployment that are similar to those presented in AEO 2011, and also forecasts no construction of new conventional coal-fired power plants under the base case.<sup>10</sup>

A number of major utilities have made public announcements consistent with these modeling results.<sup>11</sup>

IPM has been used for evaluating the economic and emission impacts of environmental policies for over two decades. The economic modeling presented in this chapter has been developed specifically for analysis of the power sector. Thus, the model has been designed to

---

<sup>7</sup> [http://www.eia.gov/forecasts/aeo/chapter\\_legs\\_regs.cfm](http://www.eia.gov/forecasts/aeo/chapter_legs_regs.cfm)

<sup>8</sup> Department of Energy (2011). *Report on the First Quadrennial Technology Review*. Available at [http://energy.gov/sites/prod/files/QTR\\_report.pdf](http://energy.gov/sites/prod/files/QTR_report.pdf).

<sup>9</sup> AEO 2012 Early Release Overview

<sup>10</sup> <http://www.epa.gov/airmarkets/progsregs/epa-ipm/BaseCasev410.html#documentation>

<sup>11</sup> For example: “We have no other coal-fueled generation planned at this time... When we do need new capacity, it is highly likely that we will look to natural gas plants instead of coal, especially if natural gas prices remain as low as projected.” AEP January 1, 2011, Washington Post; “If you actually look at the economics today, you would be burning gas, not coal,” Jack Fusco, Calpine, 12/1/2010, Marketplace; “Coal’s most ardent defenders are in no hurry to build new ones in this environment.” John Rowe, Exelon, 9/2011, EnergyBiz; “With low gas prices, gas-fired generation kind of snowplows everything else” Lew Hay, NextEra, 11/1/2010, Dow Jones.

reflect the industry as accurately as possible. EPA uses the best available information from utilities, industry experts, gas and coal market experts, financial institutions, and government statistics as the basis for the detailed power sector modeling in IPM. More detail on IPM can be found in the model documentation, which provides additional information on the assumptions discussed here as well as all other assumptions and inputs to the model.

### **5.3 External Review of EPA Applications of IPM**

EPA has used IPM extensively over the past two decades to analyze options for reducing power-sector emissions. The model has been used by the Agency to support regulatory initiatives as well as legislative proposals designed to address air emissions for the power sector. All of the IPM scenarios conducted for this rulemaking are available at EPA's website and in the public docket.<sup>12</sup>

The model undergoes periodic formal peer review, which includes separate expert panels for both the model itself and EPA's key modeling input assumptions. For example, over the past ten years several separate panels of independent experts have been convened to review IPM's coal supply and transportation assumptions, natural gas assumptions, and model formulation.

The rulemaking process also provides opportunity for expert review and comment by a variety of stakeholders, including owners and operators of the electricity sector that is represented by the model, public interest groups, and other developers of U.S. electricity sector models. The feedback that the Agency receives provides a highly detailed check for key input assumptions, model representation, and modeling results.

The Agency has used IPM in several recent regulatory contexts. The model has been used to support the Agency's analytics for the Clean Air Interstate Rule, CSAPR, MATS, and over a dozen legislative analytical efforts to forecast the costs, emission changes, and power sector impacts of various policies to reduce power sector emissions. As part of the rulemaking process, EPA is required to respond to every significant comment submitted.

The model has also been used by states (e.g., for Regional Greenhouse Gas Initiative, the Western Regional Air Partnership, Ozone Transport Assessment Group), other Federal and State agencies, environmental groups, and industry, all of whom subject the model to their own review procedures.

---

<sup>12</sup> <http://www.epa.gov/airmarkt/progsregs/epa-ipm/index.html>



More specifically, the model has received extensive review by energy and environmental modeling experts over the past two decades. States have used the model extensively to inform issues related to ozone in the northeastern portion of the U.S. This groundbreaking work set the stage for the NO<sub>x</sub> SIP call, which has helped reduce summer NO<sub>x</sub> emissions and the formation of ozone in densely populated areas in the northeast. In the late 1990's, the Science Advisory Board reviewed IPM as part of the CAA Amendments Section 812 prospective studies that are periodically conducted. The model has also undergone considerable interagency scrutiny as part of a series of legislative analyses over the past decade. These analyses explored a variety of approaches to controlling emissions from the power sector, and the results were presented to Congress in a comparative manner in order to evaluate the merits of policy proposals. The model was also used to support the Agency's power sector analyses of legislative climate proposals in 2005, continuing through 2010. In addition, Regional Planning Organizations throughout the U.S. have extensively examined IPM as a key element in the state implementation plan (SIP) process for the National Ambient Air Quality Standards. The Agency has also used the model in a number of comparative modeling exercises sponsored by Stanford University's Energy Modeling Forum over the past 15 years.

#### **5.4 IPM is a Detailed Bottom-Up Model**

EPA applies IPM to consider nationwide impacts of environmental policies, which can also be considered at a regional level of detail appropriate to the functional organization of the power section. Although the Agency typically focuses on broad system effects when assessing the economic impacts of a particular policy, EPA's application of IPM includes a detailed and sophisticated regional representation of key power sector variables. For example, the model includes 32 power regions with detailed representation of the inter-regional transmission system and reflects the regional aspects of natural gas and coal markets. When considering which new units are most cost effective to build and operate, the model considers the relative economics of various technologies based on their unique capital costs, operation and maintenance (O&M) costs, fuel costs and emission profiles. The capital costs for new units are regionalized through the application of regional adjustment factors that capture regional differences in labor, material, and construction costs. These regional cost differentiation factors are based on assumptions used in the EIA's AEO.

As part of the model's assessment of the relative economic value of building a new power plant, the model incorporates a detailed representation of the fossil-fuel supply system that supports fuel price projections, a key component of new power plant economics. The model includes an endogenous representation of the North American natural gas supply system

through a natural gas module that reflects a full supply/demand equilibrium of the North American gas market. This module consists of 114 supply, demand, and storage nodes and 14 liquefied natural gas regasification facility locations that are tied together by a series of linkages (i.e., pipelines) that represent the North American natural gas transmission and distribution network.

IPM also endogenously models the coal supply and demand system throughout the continental U.S., and reflects non-power sector demand and imports/exports. IPM reflects 84 coal supply curves, 12 coal sulfur grades, and the coal transport network, which consists of 1,230 linkages representing rail, barge, and truck and conveyer linkages. The coal supply curves in IPM, which are publicly available, were developed during a thorough bottom-up, mine-by-mine based approach that depict the coal choices and associated supply costs that power plants will face over the modeling time horizon. The IPM documentation outlines the methods and data used to quantify the economically recoverable coal reserves, characterize their cost, and build the 84 coal supply curves that are implemented in EPA modeling applications. The coal curves used by EPA were developed in consultation with Wood Mackenzie, one of the leading energy consulting firms and specialists in coal supply. These curves have been independently reviewed by industry experts and have been made available for public review on several occasions over the past two years during the rulemaking process for CSAPR and MATS.

## **5.5 Base Case and Sensitivity Analysis of Future Generating Capacity**

### **5.5.1 Base Case Analysis**

EPA began its analysis of the economic impacts of the proposed NSPS by conducting a base case analysis of future generating capacity. This base case incorporates the final MATS and the final Transport Rule (finalized as CSAPR).<sup>13</sup> In addition to MATS and CSAPR, the baseline takes into account emissions reductions associated with the implementation of all finalized federal rules, state rules and statutes, and other binding, enforceable commitments that are applicable to the power industry and which govern the installation and operation of pollution controls during the timeframe covered in the analysis. EPA's IPM modeling for this rule relies on EIA's *Annual Energy Outlook for 2010's* electric demand forecast for the US and employs a set of EPA assumptions regarding fuel supplies, the performance and cost of electric generation technologies, pollution controls, and numerous other parameters.

---

<sup>13</sup> <http://www.epa.gov/airquality/powerplanttoxics> and <http://www.epa.gov/airtransport>.

The IPM base case projection is based on an electricity demand growth assumption of 0.8 percent annually on average, similar to EIA's Annual Energy Outlook for 2010, and slightly higher than the 0.7 percent annual average growth in the AEO 2012 ER. Total electricity demand is projected to be 4,086 billion kWh by 2015. Table 5-2 shows current electricity generation alongside EPA's projection for 2020 using IPM. This new demand will be fulfilled by existing generating capacity that is currently not being fully utilized, and new renewable and gas-fired generating capacity (see Table 5-1). The change in coal represents only retirements of existing plants and no new unplanned coal builds. These projections are the result of least-cost dispatching using IPM, and reflect the most cost-effective dispatch and investment option, given a variety of variables and constraints. Although most new generating capacity will be renewable and natural gas-fired, U.S. electricity demand will continue to be met by a diverse mix of electricity generation sources (see Table 5-2). In addition, coal is projected to continue to provide the largest share of America's electricity.<sup>14</sup> By 2020, EPA forecasts roughly 27 GW of new renewable capacity, 2 GW of coal with CCS, and 10 GW of new natural gas-fired capacity. Although 2 GW of coal with CCS is included in the base case in response to incentives under existing law, overall coal capacity is forecast to decline in response to current economics, along with some retirements due to other air regulations (CSAPR and MATS).

---

<sup>14</sup> Coal-fired generation is projected to increase above 2009 actual levels. 2020 natural gas-fired generation is projected to be lower than 2010, due in large part to the smaller relative difference in delivered natural gas and coal prices in different areas of the country projected to occur in 2020 than occurred in 2010. While the projected narrowing of this gas price and coal price differential may increase dispatch (generation) from existing coal units, it is insufficient to shift the economic decision to favor new conventional coal-fired capacity, which requires consideration of capital costs in addition to generation costs. The same trend is seen in AEO 2011 projections.

**Table 5-1. Total Generation Capacity in 2010 and Projected by 2020 (GW)**

	<b>2010</b>	<b>2020</b>
Pulverized Coal	316	304
Natural Gas Combined Cycle	199	212
Combustion Turbine	135	143
Oil/Gas Steam	111	90
Non-Hydro Renewables	31	73
Hydro	99	99
Nuclear	102	106
Other	5	4
<b>Total</b>	<b>998</b>	<b>1,030</b>

Source: 2010 data from EPA's NEEDS v.4.10 PTR. 2020 projections from Integrated Planning Model run by EPA.

Notes: The sum of the table values in each column may not match the total figure due to rounding.

"Non-Hydro Renewables" include biomass, geothermal, solar, and wind electric generation capacity. The capacity of a generating unit that is co-firing gas in a coal boiler is split in this table between "pulverized coal" and "Oil/Gas Steam" proportionally by fuel use.

**Table 5-2. 2010 U.S. Electricity Net Generation and EPA Base Case Projections for 2020 (Billion kWh)**

	<b>Historical</b>	<b>Projected</b>
	<b>2010</b>	<b>2020</b>
Coal	1,828	1,976
Oil	35	0.126
Natural Gas	901	869
Nuclear	807	840
Hydroelectric	258	286
Non-hydro Renewables	139	289
Other	4	45
<b>Total</b>	<b>3,972</b>	<b>4,305</b>

Notes: The sum of the table values in each column may not match the total figure due to rounding.

Source: 2010 data from EIA Electric Power Annual 2010, Table 2.1; 2020 projection from IPM run by EPA, 2011.

### **5.5.2 Sensitivity Analyses**

Forecasts suggesting that new coal is unlikely to be built by 2020 have been shown to be robust under a range of alternative assumptions that influence the industry's decisions to build new power plants. For example, EIA typically supplements the AEO with a series of distinct scenarios that explore specific issues and examine a future state of the world that deviates from the core parameter estimates that underlie the AEO reference case. Even under

alternative scenarios where assumptions might improve the relative economic value of building new coal-fired power plants, the AEO 2011 does not project new coal capacity being built through 2025, beyond the coal capacity already planned outside of the modeling. Relevant scenarios include higher economic growth forecast, lower cost of coal supply, lower capital costs of fossil fuel-fired energy technologies, and less optimistic natural gas supply.<sup>15</sup> Although new coal capacity is built in some of these scenarios after 2025, CAA Section 111(b) requires that this standard be reviewed every eight years, thus this regulatory requirement will likely be reviewed and potentially revised after the 2020 timeframe, which serves as the primary focus of this analysis. In addition to studying the alternative scenarios analyzed by EIA, EPA also conducted three additional sensitivity analyses using IPM: a low shale gas recovery scenario, a high electricity demand scenario, and a combination of the two.<sup>16</sup> The lower shale recovery scenario assumed, that 50 percent less natural gas is recovered from each shale play relative to the base case (effectively lowering shale reserves by 50 percent, similar to the AEO 2011 low shale gas recovery scenario). The high electricity demand scenario assumed that electricity demand grows at an annual average rate of 1.1 percent, similar to EIA's high economic growth scenario for AEO 2010 (compared to about 0.8 percent in the EPA baseline, which is similar to the reference case in AEO 2010). Figure 5-2 and 5-3 illustrate electricity demand and natural gas price in these sensitivity analyses. Note that the EPA structured the sensitivity analyses such that natural gas prices and electricity demand growth are both considerably higher than the comparable AEO 2011 scenarios.<sup>17</sup>

---

<sup>15</sup> Conversely, modeling in support of the AEO 2011 show that new natural gas combined cycle capacity is expected to be higher in 2020 in the low fossil cost and high economic growth scenarios relative to the reference case.

<sup>16</sup> Although EPA and EIA do not typically combine scenarios (as EPA did with the natural gas and demand sensitivity in this analysis), this scenario was performed to demonstrate that even when considering the occurrence of two independent and highly unlikely assumptions that influence new power plant additions, new unplanned coal is not expected to be built through 2020.

<sup>17</sup> EPA's baseline electricity demand forecast used in IPM v4.10 is based on the demand forecast in AEO 2010. AEO 2010 electricity demand forecast for the year 2020 is roughly 2.5% higher than the 2020 forecast in AEO 2011. EPA's sensitivity with higher electricity demand growth (using the AEO 2010) uses an electricity demand for 2020 that is about 6% higher than the reference case AEO 2011 demand for 2020, and about 3% higher than the demand in the AEO 2011 high economic growth scenario. The EPA sensitivity with higher electric demand represents a very conservative view of electricity demand in 2020 (meaning that its electricity demand projection is considerably higher than the most recent reference case forecast, therefore representing a future in which new coal-fired capacity would be of correspondingly higher economic value to build relative to the reference case forecast conditions).

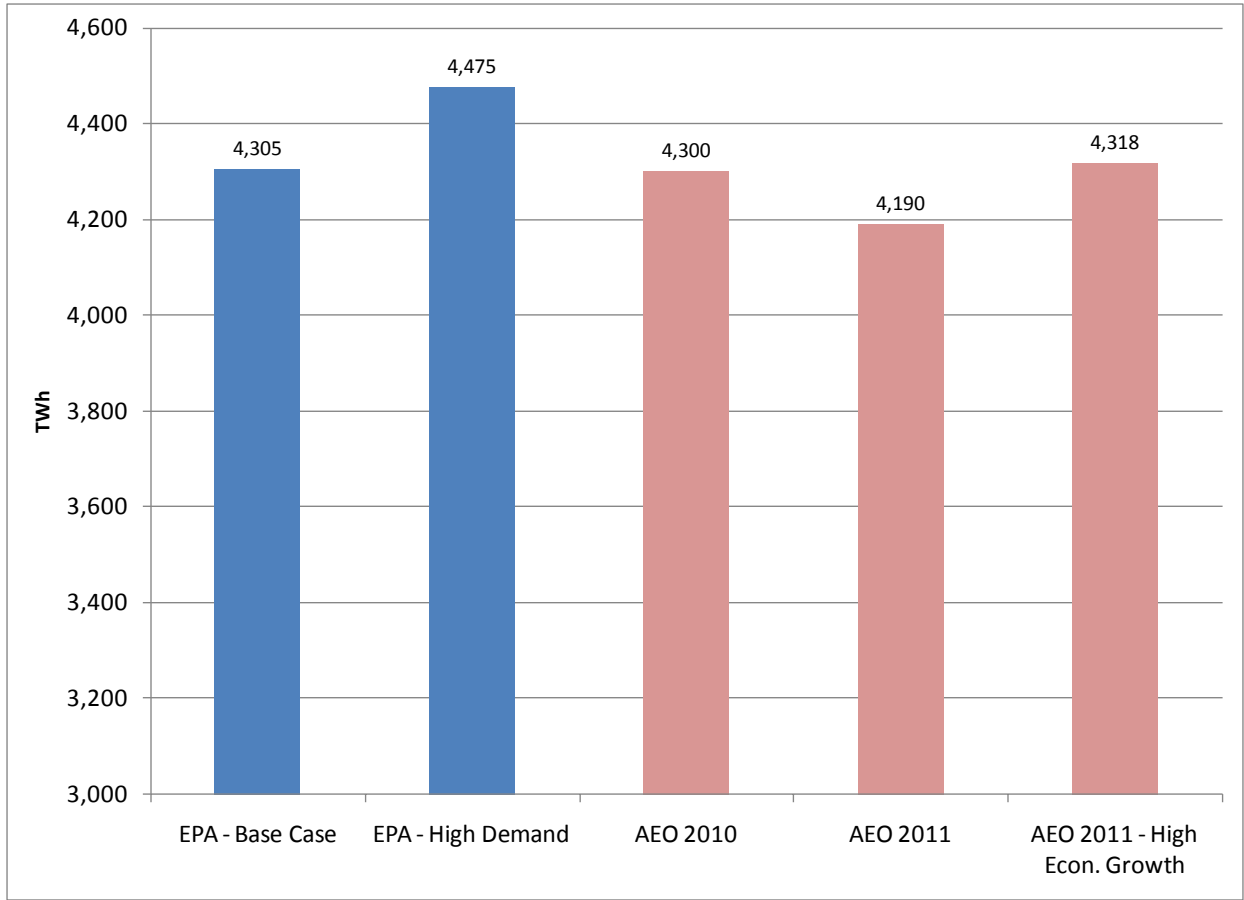

**Figure 5-2. Projected Levels of Electricity Demand in 2020, EPA and EIA**

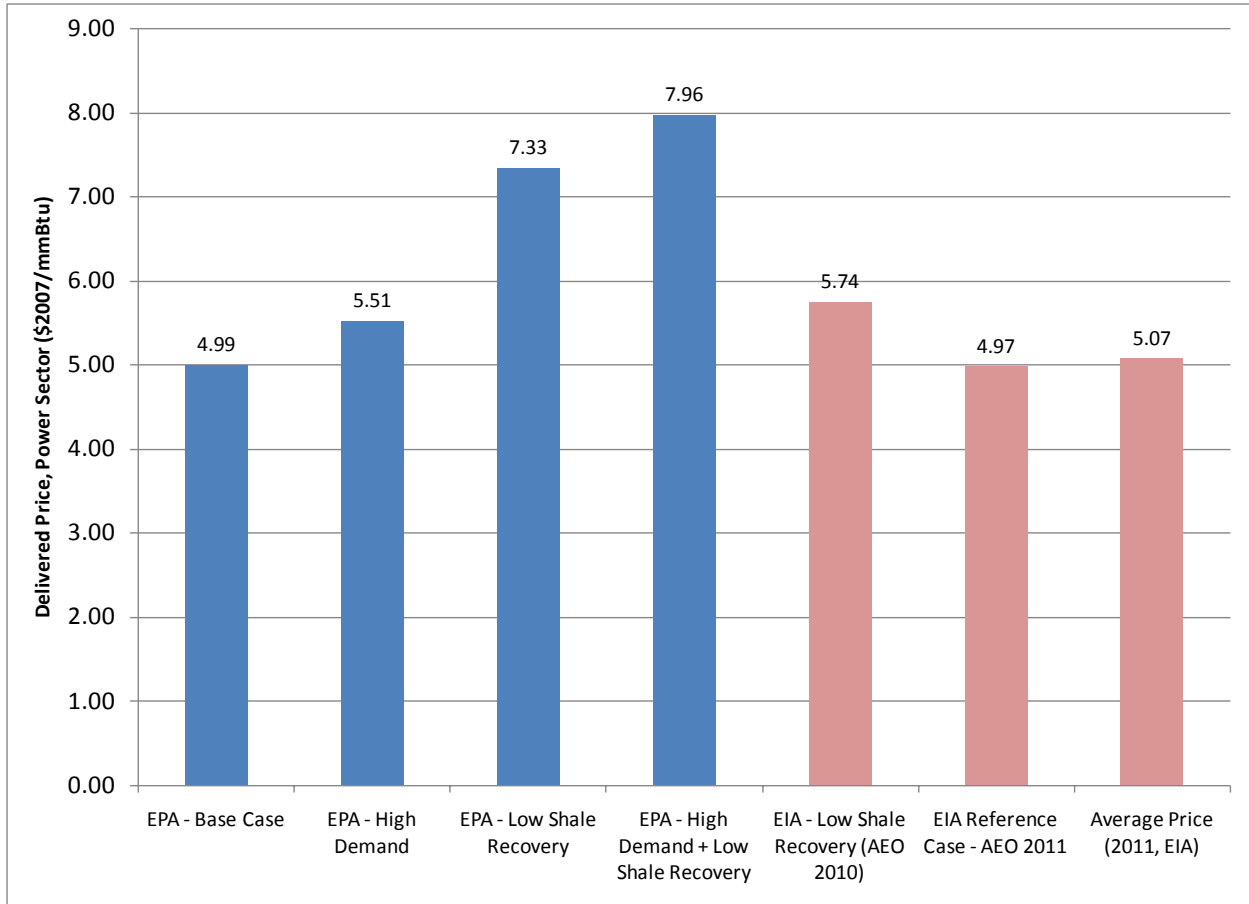

**Figure 5-3. Projected Natural Gas Prices in 2020, EPA and EIA (Delivered, Power Sector)**

None of these analyzed scenarios resulted in new conventional coal-fired capacity being built in 2020 (see Figure 5-4) beyond 2 GW of coal with CCS, which is built in response to the financial incentives for CCS included in the Emergency Economic Stabilization Act of 2008 and American Recovery and Reinvestment Act of 2009, which authorized and/or appropriated funding to DOE for CCS deployment.<sup>18</sup> In the short-term, most new capacity is projected as a mix of wind and natural gas in response to the competitive marketplace for fuels and other energy policies (such as tax credits and state renewable portfolio standards). These scenarios show similar results as EIA, and serve to further confirm the high likelihood that no new coal capacity is likely to be built by 2020 in baseline forecasts. See Table 5-3 for new capacity projections in 2020.

<sup>18</sup> A number of the sources that EPA has identified as transitional sources have received some form of DOE financial assistance to demonstrate CCS. Several additional projects have received funding but have not yet received air permits. Beyond these projects, prospects for additional federal funding are dependent on the overall budget process.

**Table 5-3. Projected New Capacity in 2020**

	<b>EPA-Base Case</b>	<b>EPA-High Demand</b>	<b>EPA-Low Shale Recovery</b>	<b>EPA-High Demand + Low Shale Recovery</b>
Coal +CCS	2.0	2.0	2.0	2.0
Natural Gas Combined Cycle	7.0	22.7	7.3	24.8
Combustion Turbine	3.0	3.2	2.4	2.4
Non-Hydro Renewables	26.9	27.6	27.3	31.5
<b>Total</b>	<b>38.9</b>	<b>55.5</b>	<b>39.0</b>	<b>60.7</b>

### **5.6 Analysis of Applicability of Proposed EGU GHG NSPS to Projected New Generating Capacity**

As the second step in the analysis, EPA analyzed the applicability of the NSPS to new generating capacity anticipated to be built through 2020, and whether the requirements would require the regulated community to take actions different from those projected in the base case.

The proposed EGU GHG NSPS discusses potential requirements for new units. Analysis performed by EPA, along with information from other sources, suggests that the standards as specified in this proposed rule are likely to result in negligible emission changes, other quantified benefits, energy impacts, costs, or economic impacts by 2020. This is because analyses performed both by EPA and EIA, as well as statements and actions of a number of major utilities, demonstrate that generation technologies other than coal (mostly natural gas and renewable sources) are likely to be the technologies of choice for new sources due to current and projected market conditions.<sup>19</sup>

#### **5.6.1 New Units**

This proposal requires that all new fossil-fuel fired units greater than 25 megawatt capacity be able to meet an emission rate standard of 1,000 lbs CO<sub>2</sub>/MWh on a gross basis. It also proposes an alternative compliance option that would allow new units to meet the 1,000 lbs CO<sub>2</sub>/MWh standard using a 30 year averaging period. These standards could be met either by natural gas combined cycle generation or coal-fired generation using CCS.

<sup>19</sup> EPA does not anticipate any oil or gas steam boilers to be constructed, either. Although these types of units would be subject to this rule, they have not been a technology of choice for the sector in recent years and are generally smaller (less than the 25 MW applicability threshold included as part of this rule). In addition, the operating economics also do not favor this technology, similar to the dynamic with conventional new coal-fired capacity.



Of the new generating capacity projected to be constructed by 2020, only the fossil-fueled boilers would be affected by the proposed EGU GHG NSPS. The NGCC units, which are the basis of the proposed standard, are projected to meet the proposed standard through their inherent design.<sup>20</sup> As discussed in section 5.5, no new conventional coal-fired boilers are projected to be built (excluding new coal built with CCS). This implies that the NSPS will require no changes in design or construction of new EGUs forecasted in the base case. Thus, under the baseline projections as well as the sensitivity analyses presented above, the proposed EGU GHG NSPS will not result in any reduction in emissions, or any costs.

Engineering cost analysis, even outside of a least-cost system dispatch modeling environment, reaches similar conclusions. A comparison of levelized wholesale electricity costs for differing generation technologies and natural gas prices are shown in Figure 5-4 and Table 5-4. It is important to note that both EIA and EPA include a capital charge rate adder (3 percent) for new conventional coal-fired generating capacity without CCS, which reflects the additional cost of raising capital that is currently reflected in the marketplace, related at least in part to uncertainty surrounding future greenhouse gas emission reduction requirements.<sup>21</sup> Note that this figure only shows the costs to the generator and does not reflect the additional social costs that are associated with damages from greenhouse gas emissions or conventional air pollutants. As the figure shows, with a delivered natural gas price of \$5 per million British Thermal Units (mmBtu) and a delivered coal price of \$2 per mmBtu, which reflect forecasted prices from IPM in 2020,<sup>22</sup> electricity generated by natural gas combined cycle units is less expensive on average than coal generation.

---

<sup>20</sup> Natural gas combustion turbines are not covered by this proposal.

<sup>21</sup> EIA includes "a 3-percentage-point increase is added to the cost of capital for investments in GHG-intensive technologies, such as coal-fired power plants without CCS and CTL plants." Source: EIA AEO 2009, Issues in Focus. *Reflecting Concerns Over Greenhouse Gas Emissions in AEO2009*, available at:

<http://www.eia.gov/forecasts/archive/aeo09/issues.html>

See also <http://www.epa.gov/airmarkets/progsregs/epa-ipm/index.html>

<sup>22</sup> EIA projects a U.S. average power sector delivered coal price of \$2.08/MMBtu in 2020 (\$2007). EPA and EIA both project delivered (power sector) natural gas price of roughly \$5/mmBtu in 2020.

(\$2007)

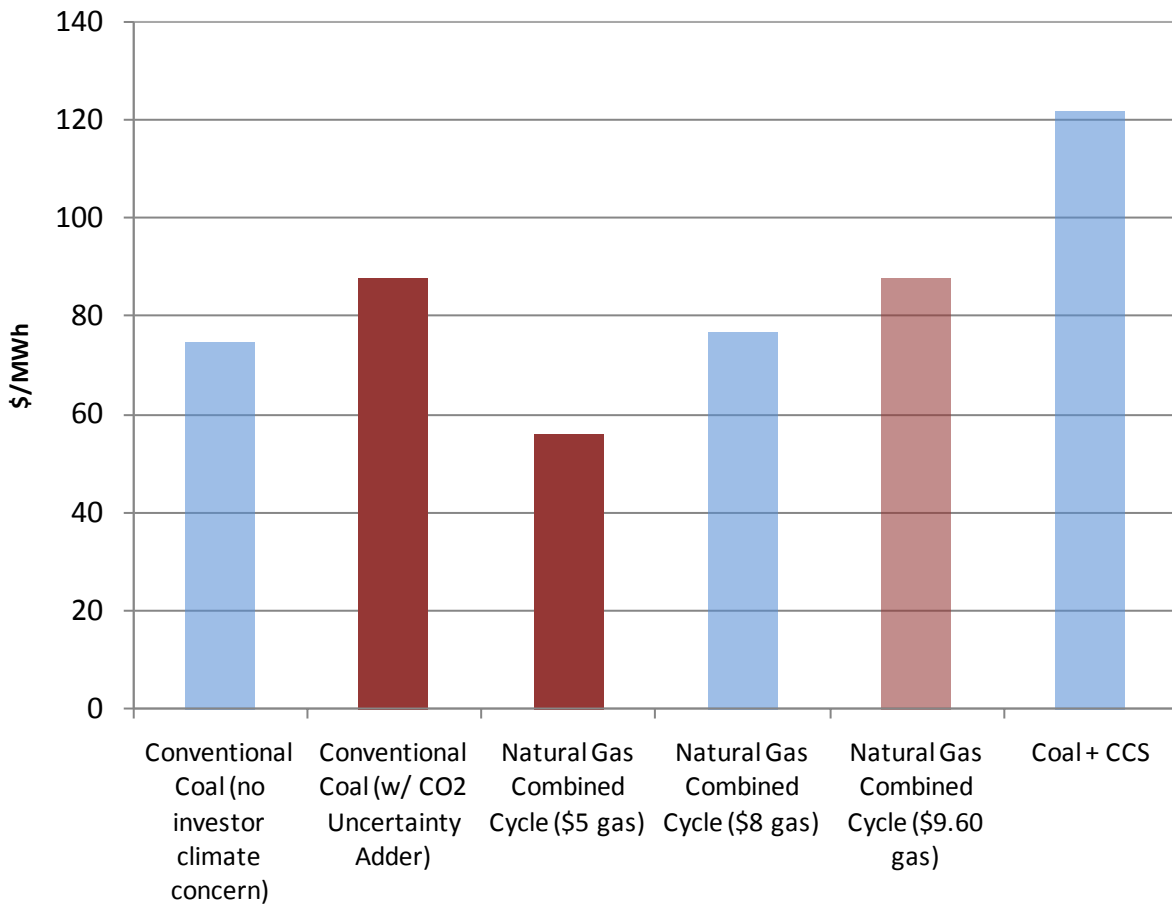

**Figure 5-4. Illustrative Wholesale Levelized Cost of Electricity of Alternative New Generation Technologies, EPA<sup>23</sup>**

Notes: Assumptions derived from EPA’s application of IPM. Technologies include Coal without CCS, Natural Gas Combined Cycle with natural gas costing \$5 per mmBtu, Natural Gas Combined Cycle with \$8 per mmBtu costs of natural gas, and Integrated Gasification Combined Cycle with CCS (with 90 percent capture). In this graph coal is a high sulfur bituminous at \$2 mmBtu. Conventional Coal is at a heat rate of 8,875 Btu/kWh net, capacity factor of 85 percent assumed across all technologies.

<sup>23</sup> Although EPA believes that this cost data is broadly representative of the economics between new coal and new natural gas facilities, this analysis assumes representative new units and does not reflect the full array of new generating sources that could potentially be built. To the extent that other types of new units that would be affected by this rule could be built, they could exhibit different costs than presented here. For example, smaller new conventional coal facilities which would be more expensive on a \$/kw basis and have a relatively higher LCOE, and some technologies could potentially have a lower LCOE if fuel could be obtained cheaply and capital costs remained similar, or lower than, an new base load convention coal plant (petroleum coke or waste coal). These differences do not fundamentally change the analysis presented in this chapter.

It is only when gas prices reach approximately \$9.60/mmBtu (in 2007 dollars), that new coal-fired generation without CCS becomes competitive, in terms of dollars per megawatt hour wholesale cost of electricity generation (none of the EPA or EIA sensitivities with alternate assumptions for natural gas approach this price level).

It is important to note that this analysis is based on assumptions regarding the average national cost of generation at new facilities. As reported by the EIA, there is expected to be significant spatial variation in the costs of new generation due to design differences, labor wage and productivity differences, location adjustments, among other potential differences.<sup>24</sup> EPA acknowledges that there is some uncertainty around these estimates, and is unable to provide estimates for all variants. However, the results are expected to hold for the majority of situations. The analysis also does not explicitly consider new units designed to combust waste coal or petroleum coke (pet coke), which may be affected by this rule, but also may exhibit different local economics.<sup>25</sup>

This rule also proposes an alternative compliance option that would allow new units to meet the 1,000 lbs CO<sub>2</sub>/MWh standard using a 30 year averaging period.<sup>26</sup> To the extent market participants have alternative views of both the cost and development of CCS, new conventional coal-fired capacity (or IGCC) could be built and operated for some time, with the intention to apply CCS with high removal efficiency at some later date, in order to achieve the required average rate over the 30 year period. Also the above analysis reflects national averages, and given their specific situation, a market participant could determine that the economics of building a coal-powered facility that immediately achieves a CO<sub>2</sub> capture and/or removal rate consistent with the emission standard are favorable.

---

<sup>24</sup> [http://www.eia.gov/oiaf/beck\\_plantcosts/pdf/updatedplantcosts.pdf](http://www.eia.gov/oiaf/beck_plantcosts/pdf/updatedplantcosts.pdf)

<sup>25</sup> This analysis also does not explicitly consider new units designed to combust waste coal or petroleum coke (pet coke), which may be affected by this rule, but can exhibit different economics. Most other energy models, including EIA's application of NEMS, do not consider these technologies for new electricity sources because they are marginal technologies that are rarely built, and highly dependent upon specific local factors that are difficult to model and highly speculative (like the ability to obtain a very inexpensive local supply of suitable fuel). The models do include these technologies as part of the existing universe of sources, however. For context, there are currently 59 units nationwide that are designed to combust either waste coal or petroleum coke, with a total capacity of roughly 5 GW (or 0.5% of the entire fleet). To the extent that these technologies would be built absent this rule due to unique local economics and fuel supply, there would be certain costs and benefits associated with this proposed rule, although they would be expected to be small because these sources are not often built. EPA is taking comment and solicits additional information on its consideration of these technologies in the analysis.

<sup>26</sup> IPM does not consider the impact of elevation on performance, and utilizes a uniform elevation performance-based assumption.

**Table 5-4. Estimated Levelized Cost of New Generation Resources from EIA, U.S. Average (2016)**

Plant Type	Capacity Factor (%)	Levelized Capital Cost	U.S. Average Levelized Costs (2009 \$/ MWh) for Plants Entering Service in 2016			Total System Levelized Cost
			Fixed O&M	Variable O&M (Including fuel)	Transmission Investment	
Conventional Coal	85	65.3	3.9	24.5	1.2	94.8
Advanced Coal	85	74.6	7.9	25.7	1.2	109.4
Advanced Coal with CCS	85	92.7	9.2	33.1	1.2	136.5
<b>Natural Gas-fired</b>						
Conventional Combined Cycle	87	17.5	1.9	45.6	1.2	66.1
Advanced Combined Cycle	87	17.9	1.9	42.1	1.2	63.1
Advanced CC with CCS	87	34.6	3.9	49.6	1.2	89.1
Conventional Comb. Turbine	30	45.8	3.7	71.5	3.5	124.5
Advanced Combustion Turbine	30	31.6	5.5	62.9	3.5	103.5
Advanced Nuclear	90	90.1	11.1	11.7	1.0	113.9
Wind	34	83.9	9.6	0	3.5	97.0
Wind - Offshore	34	209.3	28.1	0	5.9	243.2
Solar PV	25	194.6	12.1	0	4.0	210.7
Solar Thermal	18	259.4	46.6	0	5.8	311.8
Geothermal	92	79.3	11.9	9.5	1.0	101.7
Biomass	83	55.3	13.7	42.3	1.3	112.5
Hydro	52	74.5	3.8	6.3	1.9	86.4

Source: EIA, AEO 2011

Others have researched the cost and efficiency of varying levels of capture relative to building other energy technologies.<sup>27</sup> This ongoing research indicates that lower levels of carbon capture at new coal facilities could be cost competitive, and the costs of meeting the proposed emission rate immediately could be achievable. For example, The Clean Air Task Force has compiled data that indicates the levelized cost of electricity for a new supercritical pulverized coal unit with 50 percent CCS (or 1,080 lb/MWh CO<sub>2</sub>, which is just above the proposed standard) could be \$116/MWh compared to \$147/MWh for 90 percent removal. However, investment decisions will be made on a case by case basis dependent upon a number of factors, all of which are difficult to estimate in advance.

<sup>27</sup> Technical Options for Lowering Carbon Emissions from Power Plants. Clean Air Task Force (June, 2011). Available at: [http://www.coaltransition.org/filebin/pdf/Technical\\_Options\\_for\\_Lowering\\_Carbon\\_Emissions\\_from\\_Power.pdf](http://www.coaltransition.org/filebin/pdf/Technical_Options_for_Lowering_Carbon_Emissions_from_Power.pdf)

### **5.6.2 Reconstructed Units**

The EPA's CAA Section 111 regulations define reconstructed sources as, in general, existing sources (i) that replace components to such an extent that the capital costs of the new components exceed 50 percent of the capital costs of an entirely new facility, and (ii) for which compliance with standards of performance for new sources is technologically and economically feasible (40 CFR 60.15). The Agency is aware that, in theory, operators of existing power plants may choose to reconstruct them, but we are not aware of any announced plans to do so. This provision is rarely triggered. In light of this limited experience concerning reconstructions, the Agency lacks adequate information that is needed to propose a standard of performance for reconstructions. As a result, in today's action, the EPA is not including a proposal for reconstructions. Instead, we solicit comment on how we should approach reconstructions and, depending on the information we receive, we may propose and finalize a standard for reconstructions at a later time.

### **5.6.3 Modified and Transitional Units**

Modified and transitional units are described in the preamble and in Chapter 2 of this RIA. EPA does not anticipate any costs being associated with these units.

## **5.7 Costs, Economic, and Energy Impacts of the Proposed Rule for New Electric Generating Units**

Under a wide range of electricity market conditions – including EPA's baseline scenario as well as multiple sensitivity analyses – EPA projects that the industry will choose to construct new units that already meet these standards, regardless of this proposal. As a result, EPA anticipates that the proposed EGU GHG NSPS will result in negligible CO<sub>2</sub> emission changes, energy impacts, or costs for new units constructed by 2020. Likewise, the Agency does not anticipate any notable impacts on the price of electricity or energy supplies. Additionally, for the reasons described above, the proposed rule is not expected to raise any reliability concerns, since reserve margins will not be impacted and the rule does not impose any requirements on existing facilities.

## **5.8 Comparison of Emissions from Generation Technologies**

As discussed earlier in this chapter, natural gas combined cycle units are on average expected to be more economical to build and operate than new coal units. These natural gas units also have lower emission profiles for CO<sub>2</sub> and criteria air pollutants than new coal units. While the proposed EGU GHG NSPS is anticipated to have negligible costs or quantified benefits

under a range of likely market conditions, it is instructive to consider the differences in emissions of CO<sub>2</sub> and conventional air pollutants between the two types of units.

As Table 5-5 below shows, emissions from a typical new natural gas combined cycle facility are significantly lower than those from a traditional coal unit.<sup>28</sup> For example, a typical new supercritical pulverized coal facility that burns bituminous coal in compliance with new utility regulations (e.g., CSAPR and MATS) would have considerably greater CO<sub>2</sub>, sulfur dioxide (SO<sub>2</sub>), NO<sub>x</sub>, toxic metals, acid gases, and particulate emissions than a comparable natural gas combined cycle facility. A typical natural gas combined cycle unit emits two million metric tons less CO<sub>2</sub> per year than a typical new conventional coal unit, as well as 930 fewer short tons SO<sub>2</sub> and 1,200 fewer short tons of NO<sub>x</sub> each year. Importantly, these differences in emissions assume a new coal unit that complies with all applicable regulations, including MATS. Reductions in SO<sub>2</sub> emissions are a particularly significant driver for monetized health benefits, as SO<sub>2</sub> is a precursor to the formation of particulates in the atmosphere, and particulates are associated with premature death and other serious health effects. Further information on these pollutants' health effects is included in the next subsection.

---

<sup>28</sup> Estimated emissions of CO<sub>2</sub>, SO<sub>2</sub>, and NO<sub>x</sub> for the illustrative new coal and natural gas combined cycle units could vary depending on a variety of assumptions including heat rate, fuel type, and emission controls, to name a few.

**Table 5-5. Illustrative Emissions Profiles, New Coal and Natural Gas-Fired Generating Units<sup>29</sup>**

	Conventional Coal		Natural Gas CC		Coal with CCS	
	Emissions (tons/year)	Emission Rate (lbs/MWh net)	Emissions (tons/year)	Emission Rate (lbs/MWh net)	Emissions (tons/year)	Emission Rate (lbs/MWh net)
SO <sub>2</sub>	940	0.42	10	0.0041	50	0.022
NO <sub>x</sub>	1,400	0.62	200	0.09	1,100	0.47
CO <sub>2</sub>	3.6 million	1,800	1.7 million	820	0.4 million	200

Notes: SO<sub>2</sub> and NO<sub>x</sub> in short tons, CO<sub>2</sub> in metric tons. As discussed in Section 5.4, the illustrative units represent relative emissions for new well controlled 600 MW (net) baseload units running at 85 percent capacity factor (85% capacity factor reflects operation of new baseload units and does not necessarily reflect the historic capacity factors of existing units with specifications similar to these illustrative units). Assumed coal is high sulfur bituminous with scrubber and SCR, data are based on EPA assumptions used in IPM.

## 5.9 Benefits of Reducing GHGs and Conventional Pollutants

Because emissions of CO<sub>2</sub> and criteria air pollutants adversely affect human health and welfare, the differences in emissions presented above translate into differences in the external social costs associated with different generation technologies. Here we provide a general discussion about the differences in emissions of CO<sub>2</sub> and criteria air pollutants in the previous illustrative example.

### 5.9.1 Social Cost of Carbon

The social cost of carbon (SCC) is a metric to estimate the monetary value of benefits associated with marginal changes in CO<sub>2</sub> emissions, and may therefore be utilized to understand the value of the difference in CO<sub>2</sub> emissions between the two representative units discussed in Section 5.8. The SCC is an estimate of the monetized damages associated with an incremental increase in carbon emissions in a given year. It is intended to include (but is not limited to) changes in net agricultural productivity, human health, property damages from increased flood risk, and the value of ecosystem services due to climate change. Federal agencies typically use SCC estimates to assess the benefits of rulemakings that achieve marginal reductions in CO<sub>2</sub> emissions. These estimates were developed through an interagency process that included EPA and other executive branch entities, and concluded in February 2010. The

<sup>29</sup> The emissions presented here are estimated on an output basis to enable easier comparisons and to illustrate the potential impacts of moving from new coal to new natural gas. This analysis assumes representative new units and does not reflect the full array of new generating sources that could potentially be built (e.g., a small new conventional coal plant or a waste coal or petroleum coke facility). However, the emissions associated with other facilities that could be built, and which would be subject to this proposal, would not change noticeably (i.e., these new facilities would be subject to emissions standards for other pollutants and would emit similar levels of SO<sub>2</sub>, NO<sub>x</sub>, and CO<sub>2</sub>, on an output basis).

SCC Technical Support Document (SCC TSD) provides a complete discussion of the methods used to develop these SCC estimates.<sup>30</sup>

The interagency group selected four SCC values for use in regulatory analyses: \$7, \$26, \$42, and \$81 per metric ton of CO<sub>2</sub> emissions in 2020, in 2007 dollars.<sup>31,32</sup> The first three values are based on the average SCC from three integrated assessment models, at discount rates of 5, 3, and 2.5 percent, respectively. SCCs at several discount rates are included because the literature shows that the SCC is quite sensitive to assumptions about the discount rate, and because no consensus exists on the appropriate rate to use in an intergenerational context. The fourth value is the 95th percentile of the SCC from all three models at a 3 percent discount rate. It is included to represent higher-than-expected impacts from temperature change further out in the tails of the SCC distribution.

The SCC increases over time because future emissions are expected to produce larger incremental damages as physical and economic systems become more stressed in response to greater climatic change. Note that the interagency group estimated the growth rate of the SCC directly using the three integrated assessment models rather than assuming a constant annual growth rate. This helps to ensure that the estimates are internally consistent with other modeling assumptions. Table 5-6 presents the SCC estimates for the years 2015 to 2050. In order to calculate the dollar value for emission reductions, the SCC estimate for each emissions year would be applied to changes in CO<sub>2</sub> emissions for that year, and then discounted back to the analysis year using the same discount rate used to estimate the SCC.

When attempting to assess the incremental economic impacts of carbon dioxide emissions, the analyst faces a number of serious challenges. A recent report from the National Academies of Science (NRC 2009) points out that any assessment will suffer from uncertainty,

---

<sup>30</sup> Docket ID EPA-HQ-OAR-2009-0472-114577, *Technical Support Document: Social Cost of Carbon for Regulatory Impact Analysis Under Executive Order 12866*, Interagency Working Group on Social Cost of Carbon, with participation by Council of Economic Advisers, Council on Environmental Quality, Department of Agriculture, Department of Commerce, Department of Energy, Department of Transportation, Environmental Protection Agency, National Economic Council, Office of Energy and Climate Change, Office of Management and Budget, Office of Science and Technology Policy, and Department of Treasury (February 2010). Also available at <http://epa.gov/otag/climate/regulations.htm>

<sup>31</sup> Note that upstream emissions changes were not considered for this rule. There may be changes in greenhouse gas emissions (in particular, methane) due to changes in fossil fuel extraction and transport in response to this proposal, but those were not quantified.

<sup>32</sup> The interagency group concluded that a global measure of the benefits from reducing U.S. GHG emissions should be the standard practice when conducting regulatory impact analysis in support of federal rule makings. See Interagency Working Group on Social Cost of Carbon. 2010. *Technical Support Document: Social Cost of Carbon for Regulatory Impact Analysis Under Executive Order 12866*.



speculation, and lack of information about (1) future emissions of greenhouse gases, (2) the effects of past and future emissions on the climate system, (3) the impact of changes in climate on the physical and biological environment, and (4) the translation of these environmental impacts into economic damages.<sup>33</sup> As a result, any effort to quantify and monetize the harms associated with climate change will raise serious questions of science, economics, and ethics and should be viewed as provisional.

The interagency group noted a number of limitations to the SCC analysis, including the incomplete way in which the integrated assessment models capture catastrophic and non-catastrophic impacts, their incomplete treatment of adaptation and technological change, uncertainty in the extrapolation of damages to high temperatures, and assumptions regarding risk aversion. Current integrated assessment models do not assign value to all of the important physical, ecological, and economic impacts of climate change recognized in the climate change literature because of lack of precise information on the nature of damages and because the science incorporated into these models understandably lags behind the most recent research. The limited amount of research linking climate impacts to economic damages makes the interagency modeling exercise even more difficult. The interagency group hopes that over time researchers and modelers will work to fill these gaps and that the SCC estimates used for regulatory analysis by the Federal government will continue to evolve with improvements in modeling. It is important to emphasize that the interagency process is committed to updating these estimates as the science and economic understanding of climate change and its impacts on society improves over time. Specifically, they have set a preliminary goal of revisiting the SCC values within two years, or at such time as substantially updated models become available, and to continue to support research in this area. Additional details on these limitations are discussed in the SCC TSD.

---

<sup>33</sup> National Research Council (2009). *Hidden Costs of Energy: Unpriced Consequences of Energy Production and Use*. National Academies Press. See docket ID EPA-HQ-OAR-2009-0472-11486.

**Table 5-6. Social Cost of CO<sub>2</sub>, 2015-2050<sup>a</sup> (in 2007 dollars)**

Year	Discount Rate and Statistic			
	5% Average	3% Average	2.5% Average	3% 95 <sup>th</sup> percentile
2015	\$6	\$24	\$38	\$73
2020	\$7	\$26	\$42	\$81
2025	\$8	\$30	\$46	\$90
2030	\$10	\$33	\$50	\$100
2035	\$11	\$36	\$54	\$110
2040	\$13	\$39	\$58	\$119
2045	\$14	\$42	\$62	\$128
2050	\$16	\$45	\$65	\$136

<sup>a</sup> The SCC values vary depending on the year of CO<sub>2</sub> emissions and are defined in real terms.

### 5.9.2 Health Impacts of SO<sub>2</sub> and NO<sub>x</sub>

SO<sub>2</sub> is a precursor for fine particulate matter (PM<sub>2.5</sub>) formation. NO<sub>x</sub> is a precursor for PM<sub>2.5</sub> and ozone formation. As such, reductions of SO<sub>2</sub> and NO<sub>x</sub> would in turn lower overall ambient concentrations of these pollutants as well as PM<sub>2.5</sub> and ozone. Reducing exposure to PM<sub>2.5</sub> and ozone is associated with significant human health benefits, including avoided mortality and morbidity. Researchers have associated PM<sub>2.5</sub> and ozone exposure with adverse health effects in numerous toxicological, clinical, and epidemiological studies (U.S. EPA, 2009; U.S. EPA, 2006). Health effects associated with exposure to PM<sub>2.5</sub> include premature mortality for adults and infants, cardiovascular morbidity such as heart attacks and hospital admissions, and respiratory morbidity such as asthma attacks, bronchitis, hospital and emergency room visits, work loss days, restricted activity days, and respiratory symptoms. Health effects associated with exposure to ozone include premature mortality and respiratory morbidity such as asthma attacks, hospital and emergency room visits, and school loss days. For a full discussion of the human health benefits of reducing SO<sub>2</sub> and NO<sub>x</sub> emissions from power sector sources, including reducing methyl mercury, SO<sub>2</sub>, and NO<sub>2</sub> exposure, please refer to the RIA for CSAPR (U.S. EPA, 2011).

In addition to human health benefits, reducing SO<sub>2</sub> and NO<sub>x</sub> emissions would also result in human welfare improvements by improving ecosystem services—the benefits that the public obtains from ecosystems that directly or indirectly contribute to social welfare. SO<sub>2</sub> and NO<sub>x</sub> emissions can adversely impact vegetation, certain manmade materials, acidic deposition, nutrient enrichment, visibility, and climate (U.S. EPA, 2009; U.S. EPA, 2008). Reducing these harmful emissions improves human welfare. For more information about the welfare benefits

of SO<sub>2</sub> and NO<sub>x</sub> emission reductions from power sector sources, please refer to the Regulatory Impact Analysis for the CSAPR (U.S. EPA, 2011).

Because the health and welfare benefits of SO<sub>2</sub> and NO<sub>x</sub> emissions in terms of incidences of health effects avoided or monetized value of health or welfare improvements depend on power plant location, the potential benefits cannot be quantified precisely for the purposes of this illustrative example. However, reducing one thousand tons of annual SO<sub>2</sub> from U.S. EGUs in 2020 has been estimated<sup>34</sup> to yield between 3 and 9 incidences of premature mortality avoided annually and annual monetized PM<sub>2.5</sub>-related health benefits (including these incidences of premature mortality avoided) between \$30 million and \$75 million (2007\$) using a 3% discount rate or between \$28 million and \$67 million (2007\$) using a 7% discount rate (where the range is due to EPA's use of two alternative primary estimates of PM<sub>2.5</sub> mortality impacts, a lower primary estimate based on Pope et al. (2002) and a higher primary estimate based on Laden et al. (2006)). Additionally, reducing one thousand tons of annual NO<sub>x</sub> from U.S. EGUs in 2020 has been estimated<sup>35</sup> to yield up to 1 incidence of premature mortality avoided annually and annual monetized PM<sub>2.5</sub>-related health benefits (including these incidences of

---

<sup>34</sup> The SO<sub>2</sub> and NO<sub>x</sub> benefit per-ton (BPT) values presented here consist of only PM<sub>2.5</sub>-related health benefits from reductions in SO<sub>2</sub> and NO<sub>x</sub> (precursors to PM<sub>2.5</sub> formation). EPA relied on air quality modeling used to develop a previous rulemaking affecting power sector emissions of SO<sub>2</sub> and NO<sub>x</sub> to develop these BPT values (Air Quality Modeling Technical Support Document for the final Transport Rule; <http://epa.gov/airtransport/pdfs/AQModeling.pdf>). EPA utilized Transport Rule (Cross-State Air Pollution Rule) modeling rather than air quality modeling of EPA's Mercury and Air Toxics Standards (MATS) because EPA did not estimate NO<sub>x</sub> BPT values for MATS and because the utilized Transport Rule modeling reduced emissions of SO<sub>2</sub> and NO<sub>x</sub> independently, allowing for better estimation of PM<sub>2.5</sub>-related SO<sub>2</sub> and NO<sub>x</sub> BPT values. The air quality modeling utilized reflects emission reductions in the eastern U.S. In order to better understand the relative difference between BPT values for emission reductions in the east and west, see Table 5C-3 of the MATS Regulatory Impact Analysis (RIA) <[www.epa.gov/ttn/ecas/regdata/RIAs/matsriafinal.pdf](http://www.epa.gov/ttn/ecas/regdata/RIAs/matsriafinal.pdf)>. Using this existing air quality modeling, EPA used BenMAP ([www.epa.gov/air/benmap](http://www.epa.gov/air/benmap)) to estimate the benefits of air quality improvements using projected 2020 population, baseline incidence rates, and economic factors. These BPT values are methodologically consistent with those reported in Fann et al. (2009). As EPA models avoided premature deaths among populations exposed to levels of PM<sub>2.5</sub>, we have lower confidence in levels below the lowest measured level (LML) for each study. However, studies using data from more recent years, during which time PM<sub>2.5</sub> concentrations have fallen, continue to report strong associations with mortality. For more information refer to the MATS RIA. The average BPT values reflect a specific geographic distribution of SO<sub>2</sub> and NO<sub>x</sub> reductions resulting in a specific reduction in PM<sub>2.5</sub> exposure and may not fully reflect local or regional variability in population density, meteorology, exposure, baseline health incidence rates, or other factors that might lead to an over-estimate or under-estimate of the actual benefits associated with PM<sub>2.5</sub> precursors. These BPT values are purely illustrative as EPA does not assert a specific location for the illustrative coal and natural gas combined cycle units and is therefore unable to specifically determine the population that would be affected by their emissions. Therefore, the benefits for any specific unit can be very different than the estimates shown here. EPA notes that the BPT estimates do not reflect emission reductions after implementation of EPA's Mercury and Air Toxics Standards.

<sup>35</sup> Ibid.

premature mortality avoided) of between \$2.5 million and \$6.2 million (2007\$) using a 3% discount rate or between \$2.3 million and \$5.6 million (2007\$) using a 7% discount rate.

### **5.10 Illustrative Analysis of the Social Costs of New Generating Sources**

As the analysis in sections 5.5 and 5.6 demonstrated, under a wide range of likely electricity market conditions – including EPA’s baseline scenario as well as multiple sensitivity analyses – EPA projects that the industry will choose to construct new units that already meet these standards, regardless of this proposal.

In this section, we consider the unlikely scenario where future market conditions support the construction of new conventional (advanced, but without CCS) coal capacity during the analysis period in the absence of the rule. The analysis in this section indicates that in this scenario, the proposed EGU GHG NSPS is highly likely to provide net benefits to society as a whole.

The starting point for this analysis is the illustrative comparison (presented in Figure 5-4 above) of the relative private costs of constructing and operating a representative new conventional coal EGU and a representative NGCC unit.<sup>36</sup> This comparison shows that, at forecast relative fuel prices, there is a significant difference in the levelized cost of these two generating technologies. However, in the context of a social welfare analysis, the appropriate comparison between multiple options is on the basis of benefits and costs to society *as a whole*, and not solely the private cost to an investor.

From the perspective of society, the appropriate cost comparison for new generation capacity should account for the pollution damages associated with the competing generation technologies in addition to private generating costs. This section further explores how the potential social benefits and costs of this NSPS standard may change across a wide range of natural gas prices, a key factor in the potential cost of the policy. It begins by estimating illustrative environmental damages per MWh for coal relative to gas generation and then uses

---

<sup>36</sup> By fixing generation in this comparison, we are assuming that both technologies generate the same benefits in the form of electricity generating services. We assume in the discussion that the benefit of electricity production to consumers outweighs the private and social investment cost. However, at particularly high fuel prices this might not be the case. For a discussion of when comparing the levelized costs of different generating technologies provides informative results and when it does not see, for example, Joskow 2010 and 2011.

these estimates to conduct an illustrative sensitivity analysis for the potential social costs of the policy in this illustrative example.<sup>37</sup>

It should be emphasized that the analysis presented here is illustrative, although EPA believes that it leads to a robust conclusion. From an analytical perspective, the challenge is to estimate expected benefits and costs given uncertainty about future market conditions. An ideal benefit-cost analysis would first model projected generation capacity and capacity additions for every plausible set of market conditions (e.g., different combinations of natural gas and coal supplies and electricity demand). The effects of the proposed EGU GHG NSPS could then be estimated in each of those scenarios including the resulting estimated benefits and costs (which would depend on the amount of new generation capacity built, the technologies used, the location of new generating plants, and so on). The analysis would then estimate the conditional probability distribution of those outcomes (for example, the probability distribution of future natural gas prices or future electricity demand conditional on the current information on supply). Finally, the analysis would integrate the estimated benefits and costs over the conditional probability distribution of outcomes, to arrive at the expected net benefits of the rule.

The analysis just described is beyond the scope of the current RIA, and EPA believes that the sensitivity cases presented in section 5.6.1, combined with the illustrative analysis here, provide a robust picture of the likely costs and benefits of the standard. Nonetheless, EPA is inviting comment on whether a more detailed analysis would be practical, feasible, and an effective use of limited analytical resources, and if so, how it might be carried out and what information it would be expected to provide. If commenters believe that such an analysis would be practical and appropriate, EPA invites comment on what variables should be treated as uncertain (e.g., natural gas and coal prices, electricity demand) and on the specific conditional and potentially joint probability distributions that should be used for the future state of those variables.

In the spirit of the “ideal” analysis just described, in the remainder of this section EPA provides an illustrative analysis focusing on uncertainty in the price of natural gas, which is a key determinant of the economics of electricity generation and therefore the potential impacts of this proposed rule.

---

<sup>37</sup> From an economic perspective, the analysis in sections 5.5 and 5.6 considered the net benefits of the rule under expected market conditions, and found those to be zero (because the rule would not affect what new capacity is built under those market conditions). The analysis in this section, while still purely illustrative, is an initial step toward estimating the expected net benefits of the rule as a function of market conditions.

### 5.10.1 Illustrative Environmental Damages per MWh

As previously discussed in this chapter, the damages associated with emissions from new sources of electricity generation are greater for coal-fired units than for natural gas combined cycle units (even when accounting for compliance with EPA's recent Mercury and Air Toxics Standard). To gauge the general effect of accounting for both the private and external costs of electricity generation for new generation options we continue with the illustrative example from Section 5.8. The external costs are defined as the damages associated with pollution that are not accounted for in the private investor's decision making.<sup>38</sup>

To illustrate the external costs associated with new generation options we combine the illustrative emission profiles for the new units, as provided in Table 5-5, and the illustrative emissions and damage estimates discussed in the previous two sections.<sup>39</sup> Specifically, for each generating technology we multiply the CO<sub>2</sub> emissions by the estimates of the SCC and add that to the SO<sub>2</sub> emissions<sup>40</sup> multiplied by the PM<sub>2.5</sub>-related SO<sub>2</sub> benefit per-ton estimates,<sup>41</sup> subsequently dividing by MWh to estimate the external costs per unit of generation.

Table 5-7 reports the additional pollution damages from the illustrative new coal plant relative to the illustrative new natural gas plant given different mortality risk studies and assumptions about the discount rate. These pollution damages should be relatively invariant across natural gas prices and other economic factors. Depending on the discount rate and mortality risk study used, damages associated with generation from a representative new coal unit are \$11 to \$81 per MWh, while damages associated with the illustrative new natural gas combined cycle unit are \$3 to \$31 per MWh (2007\$).<sup>42</sup>

It is important to note that although the ranges appear to overlap, for any set of assumptions (i.e., any specific mortality risk study and choice of SCC value) estimate the

---

<sup>38</sup> See Baumol and Oates, 1988.

<sup>39</sup> Only the direct emissions of two pollutants (CO<sub>2</sub> and SO<sub>2</sub>) are considered in this illustrative exercise. Other pollutants and lifecycle emissions are not considered.

<sup>40</sup> See footnote 32 in section 5.8.

<sup>41</sup> See footnote 34 in section 5.9.2 for a description of the benefit-per-ton values. In this exercise they are interpreted as damage-per-ton values.

<sup>42</sup> Different discount rates are applied to SCC than to the other damage estimates because CO<sub>2</sub> emissions are long-lived and subsequent damages occur over many years. Moreover, several rates are applied to SCC because the literature shows that it is sensitive to assumptions about discount rate and because no consensus exists on the appropriate rate to use in an intergenerational context. The SCC interagency group centered its attention on the 3 percent discount rate but emphasized the importance of considering all four SCC estimates. See the "SCC TSD," Interagency Working Group on Social Cost of Carbon (IWGSC). 2010. Technical Support Document: Social Cost of Carbon for Regulatory Impact Analysis Under Executive Order 12866. Docket ID EPA-HQ-OAR-2009-0472-114577. <http://www.epa.gov/otag/climate/regulations/scc-tsd.pdf> for details.

pollution damages associated with new coal generation are significantly higher than those associated with new natural gas combined cycle generation in this illustrative, but representative example. For example, considering the SO<sub>2</sub> per ton damages based on Pope et al. 2002 using a 7% discount rate and the SCC estimate based on the 3% discount rate, new generation based on conventional coal in this example would result in an additional \$17 per MWh in pollution damages compared to a new NGCC plant. Alternately, damages that reflect the SO<sub>2</sub> per ton damage estimate based on Laden et al. 2006 using a 3% discount rate and the SCC estimate based on a 2.5% discount rate suggest an additional \$33 of pollution damages per MWh from a new conventional coal unit compared to a new NGCC plant.

As with the relative investment costs of a new coal unit and a new natural gas combined cycle system, the actual environmental damages associated with these two technologies depends on the location under consideration and the specific fuels that would be used. An ideal benefit-cost analysis would account for these local circumstances (and consider alternative sources of generation).<sup>43</sup> However, these factors will not change the qualitative conclusion. The damages associated with CO<sub>2</sub> emissions, which are the focus of this rule, do not depend on the location of generation. Furthermore, the damages associated with sulfur dioxide emissions from a new very well-controlled coal-fired unit firing low-sulfur coal would still be greater than the damages from a new natural gas combined cycle unit independent of the location.

---

<sup>43</sup> EPA does not assert a specific location for the illustrative coal and natural gas combined cycle units and is therefore unable to specifically determine the population that would be affected by their SO<sub>2</sub> emissions. Therefore, the benefits for any specific unit can be very different than the estimates shown here.

**Table 5-7. Pollution Damages (\$/MWh) from Illustrative New Coal Unit *Relative to New Natural Gas Combined Cycle Unit*<sup>44</sup>**

SCC Discount Rate	Damages from CO <sub>2</sub>
5%	\$3
3%	\$11
2.5%	\$18
3% (95 <sup>th</sup> percentile)	\$34

Mortality-Risk Study	Damages from SO <sub>2</sub> Only Discount Rate Applied to Health Co-Benefits	
	3% Discount Rate	7% Discount Rate
Pope (2002)	\$6	\$6
Laden (2006)	\$16	\$14

SCC Discount Rate	Combined Damages from CO <sub>2</sub> and SO <sub>2</sub> Discount Rate Applied to Health Co-Benefits	
	3% Discount Rate	7% Discount Rate
5%	\$9 - \$19	\$9 - \$17
3%	\$17 - \$27	\$17 - \$25
2.5%	\$24 - \$33	\$24 - \$32
3% (95 <sup>th</sup> percentile)	\$41 - \$50	\$40 - \$48

Notes: Values in first two tables may not sum due to rounding.

The range of costs within each SCC value and discount rate for SO<sub>2</sub> pollution damages pairing reflects the use of two core estimates of PM<sub>2.5</sub>-related premature mortality, Pope et al. (2002) representing the lower of our core estimates and Laden et al. (2006) represent the higher of our core estimates. Assumed coal is high sulfur bituminous with scrubber and SCR. The combinations of health studies and discount rates represent lower and higher valuations of impacts of SO<sub>2</sub> emissions in the Eastern U.S. EPA has evaluated the range of potential impacts per MWh by combining all SCC values with health damages values at the 3 percent and 7 percent discount rates. To be consistent with concepts of intergenerational discounting, values for health damages, which occur within a generation, would only be combined with SCC values using a lower discount rate, e.g. the 7 percent health damages estimates would be combined with 5 percent or lower SCC values, but the 3 percent health damages would not be combined with the 5 percent SCC value. While the 5 percent SCC and 3 percent health damages estimate falls within the range of values we analyze, this individual estimate should not be used independently in an analysis, as it represents a combination of discount rates that is unlikely to occur. Combining the 3 percent SCC values with the 3 percent health damage values assumes that there is no difference in discount rates between intragenerational and intergenerational impacts.

<sup>44</sup> The damages presented here are estimated on an output basis to enable easier comparisons and to illustrate the potential impacts of moving from new coal to new natural gas. This analysis assumes representative new units and does not reflect the full array of new generating sources that could potentially be built (e.g., a comparison of a small new conventional coal plant with a small natural gas plant, or a comparison of a waste coal or petroleum coke facility to a natural gas plant of a comparable size and capacity factor). However, the damages associated with other facilities that could be built, and which would be subject to this proposal, would not change noticeably (i.e., these new facilities would be subject to emissions standards for other pollutants and would emit similar levels of SO<sub>2</sub> and CO<sub>2</sub>, on an output basis) except for differences in local conditions, as discussed below.



The conclusion from this analysis is that there are significant environmental damages associated with electricity generation from a representative new conventional coal unit relative to a representative new natural gas combined cycle unit.<sup>45</sup> Other studies of the social costs of coal and natural gas fired generation provide similar findings (Muller et. al, 2011; NRC, 2009).<sup>46</sup> An important implication is that if market conditions changed sufficiently so that new coal units became marginally more profitable to operate, these new units are still likely to impose a net cost to society relative to a new natural gas plant. This idea is discussed in more detail in the next section.<sup>47</sup>

### ***5.10.2 Social Benefits and Costs across a Range of Gas Prices - Sensitivity Analysis***

We now discuss how a consideration of the environmental damages associated with new coal and natural gas EGUs informs the comparison of the two technologies from the standpoint of net benefits – building on the illustrative comparison of a representative new coal unit and a representative natural gas unit developed in Sections 5.8 and 5.9

At current natural gas prices relative to other fuels, the difference in the estimated levelized cost of electricity for a representative NGCC unit is roughly \$27 per MWh less than for a representative new conventional coal unit (see Figure 5-4). This is consistent with EPA’s projection, discussed at length above, that the proposed EGU GHG NSPS will not impose any social costs (or generate quantified net benefits) under current and likely future market conditions.

Because the impacts of this proposed rule depend on future natural gas prices, which are uncertain, EPA conducted an illustrative analysis of the impacts of the rule over a wide range of natural gas prices. This analysis considers two distinct thresholds in the price of natural

---

<sup>45</sup> As previously noted in this section and the previous sections on the costs and damages associated with these technologies, EPA does not assert a specific location for the illustrative coal and natural gas combined cycle units and is therefore unable to specifically determine the population that would be affected by their SO<sub>2</sub> emissions. Therefore, the benefits for any specific unit can be very different than the estimates shown here, though the proportion associated with CO<sub>2</sub>, which is a well dispersed global pollutant, will not be affected by location.

<sup>46</sup> Muller et al. 2011 conclude that, “coal-fired power plants have air pollution damages larger than their value added”, while the same is not true for natural gas plants (see Table 5). However, these comparisons are based on typical existing coal and natural gas units, including natural gas boilers, and are not sensitive to location. The NRC 2009 study shows that only the most polluting natural gas units may cause greater damages than even the least polluting existing coal plants (compare Tables 2-9 and 2-15). However, the NAS comparison does not compare new units located in the same place, and so some of the natural gas units with the greatest damages may be attributable to their location, and includes natural gas steam boilers, which have a higher emission rates per unit of generation than natural gas combined cycle units.

<sup>47</sup> The presence of net benefits for a given regulatory option is a necessary but not a sufficient condition for optimal regulatory design. It does however; signify that the regulatory option is welfare improving for society.

gas at present: one price at which the private cost of a representative new coal unit falls below that of a representative NGCC unit, but the generation cost advantage remains outweighed by the environmental damages from the perspective of society as a whole; and an even higher price at which the environmental damages no longer outweigh the private cost advantage. This analysis presents three relevant ranges within the conditional distribution of future natural gas prices that can be classified as a range of likely gas prices, unexpectedly high natural gas prices, and unprecedented natural gas prices. It is important to note that this illustrative analysis considers variation in the natural gas price holding all else constant; as discussed above, an ideal analysis would vary other conditions simultaneously.<sup>48</sup> In general, this analysis shows that the policy would likely have a net benefit even under scenarios with much higher gas prices. Under some conditions, higher natural gas prices result in a net cost, holding all other parameters constant and disregarding benefits that we are unable to monetize.<sup>49</sup> However, it is important to note that this analysis is limited in the types of social benefits and costs considered, given that it does address the life-cycle pollution associated with fossil fuels along with the limitations of current SCC estimates, as previously discussed.

**Likely Natural Gas Prices.** As described earlier in this chapter, the base case modeling that EPA performed for this rule (as well as base case modeling that EPA has performed for other recent air rules) indicates that new fossil fuel-fired generating capacity projected to be built through 2020 will be either natural gas-fired combined cycle generation or coal-fired generation with CCS (the latter is assumed to be built with support from federal grants). This conclusion also holds for the high-demand and low-shale-gas sensitivity analyses considered above. As shown earlier in the illustrative analysis, it is only when gas prices reach approximately \$9.60/mmBtu, that new conventional coal-fired generation becomes competitive with NGCC in terms of the levelized cost of electricity (in dollars per megawatt hour).

Projections of future market conditions suggest that it is likely that natural gas prices will remain below this level. As noted earlier in this chapter, EIA's projected natural gas price for 2020 in its reference scenario for AEO 2011 is \$5.30 (in 2007 dollars). Even EIA's most pessimistic gas sensitivity case ("low shale gas recovery per well") only projects an electricity sector gas price of \$7.01/mmBtu (in 2007 dollars) in 2020 (the "low shale gas recovery per play" scenario projects a price of \$6.13/mmBtu (in 2007 dollars) in 2020). In other words, even under

---

<sup>48</sup> For example, high economic growth would raise both natural gas and coal prices at the same time – extending the range of natural gas prices for which NGCC retained a cost advantage.

<sup>49</sup> In reality this is unlikely to be the case. For example, high economic growth would increase both natural gas and coal prices at the same time - making it harder to alter the underlying cost advantage of NGCC generation.

pessimistic natural gas sensitivity cases, NGCC is likely to remain the economic choice for generation over the next two decades even in the absence of this standard. In this scenario, it appears very likely that the costs – and benefits – of the proposed standard will be zero.

**Unexpectedly High Natural Gas Prices.** In this illustrative analysis, at natural gas prices above approximately \$9.60/mmBtu, the private levelized cost of electricity for a representative new conventional coal unit falls below that of a new NGCC unit. Therefore, above that price level some new conventional coal units might be constructed in the absence of the standard, provided there is sufficient demand and new coal without CCS is competitive with other generating technologies.<sup>50</sup> However, these coal units would also impose additional environmental and health damages in the form of global warming pollution and particulate matter (as a result of SO<sub>2</sub> and NO<sub>x</sub> emissions) – an element of social costs that are avoided by building an NGCC unit instead.

For a range of natural gas prices above \$9.60/mmBtu, the resulting external costs will outweigh the difference in the private costs in this illustrative example – indicating that the proposed standard would yield net benefits. For example, at gas prices of \$10/MMBtu, the illustrative conventional coal unit would generate power for \$3/MWh less than an NGCC unit,<sup>51</sup> but result in greater pollution damages of \$9 to \$50/MWh (see table 5-7).<sup>52</sup> Under the proposed standard, if in this example the NGCC unit were built instead, the resulting net social benefit would be \$6 to \$47/MWh.

For context, we note that these circumstances are far less likely than the zero cost scenario outlined above. To put this gas price point into historical context, \$9.60/MMBtu is higher than any average annual gas price (in 2007 dollars) observed over the last 10 years, and it has only been reached temporarily in 8 of the last 120 months.<sup>53,54</sup> Looking forward, the

---

<sup>50</sup> See section 5.4 for a discussion of how local conditions and other factors influencing the levelized cost comparison may influence the natural gas price where the levelized cost of the conventional coal unit and the NGCC unit are the same.

<sup>51</sup> Assuming an increase of \$6.80/MWh in the cost of gas generation for every \$1/MMBtu increase in natural gas prices.

<sup>52</sup> Again, assuming that coal prices do not increase along with natural gas prices as they historically have. See previous footnote.

<sup>53</sup> See: <http://www.eia.gov/dnav/ng/hist/n3045us3A.htm>. EIA reports average annual delivered natural gas prices to the electricity sector for the past 15 years (since 1996) and reports average monthly delivered natural gas prices to the electricity sector over the past 10 years (since 2001).

<sup>54</sup> It is important to note that relatively high gas prices in a single month or year will not drive the investment decision in the technology employed for new generating units. Instead that decision will be motivated by expectations of relative fuel prices over the lifetime of the unit. Therefore given the historical path of natural gas prices and the forecasts for the future, it is highly unlikely that expectations of sustained high natural gas prices, to the degree necessary to drive technology choices, will be realized.

continued development of unconventional natural gas resources in the U.S. suggests that gas prices would actually tend to be towards the lower end of the historical range. As discussed above, none of the EIA sensitivity cases (which represent future price trajectories for both gas and coal) show scenarios where non-compliant coal becomes more economic than NGCC before 2020.

**Unprecedented Natural Gas Prices.** At extremely high natural gas prices, the private generating costs of non-compliant coal would be sufficiently lower than the cost of new natural gas that the net social benefit of the standard could be negative (i.e., a net cost) under some assumptions for environmental damages. For example, at gas prices of \$15/MMBtu, the illustrative conventional coal unit would generate power for roughly \$37/MWh less than an NGCC unit but result in social costs of \$9 to \$50/MWh (see table 5-7). Under the proposed standard, if an NGCC unit were built instead, the resulting net social impact would range from a net cost of \$28 to a net benefit of \$13/MWh. The point at which this standard would result in net social costs depends heavily upon the value for damages from GHGs and SO<sub>2</sub>. For example, assuming an SCC using a 3% discount rate, along with a 7% discount rate for estimating benefits from reduced SO<sub>2</sub> and the mortality-risk estimate from Pope (2002), natural gas prices above \$12/mmBtu in this illustrative example would result in net social costs from the proposed standard. Alternatively, using an SCC value of 3% and using the mortality-risk estimate from Laden (2006) along with a 3% discount rate for PM benefits, the corresponding threshold for natural gas prices would be \$14/mmBtu. Natural gas prices above these levels would be unprecedented. Average annual natural gas prices delivered to the electricity sector have not exceeded \$9.47 /mmBtu (in 2007 dollars) over the last 15 years, and projected prices do not begin to approach this level in any of EIA's scenarios.<sup>55,56</sup> As a result, based on historical gas prices as well as projections, EPA believes that there is an extremely small probability that natural gas prices will reach (let alone remain at) levels at which this standard would generate net social costs.

We emphasize that differences in generating costs, plant design, local factors, and the relative differences between fuels costs can all have major impacts on the precise circumstances under which this standard would be projected to have no costs, net benefits or

---

<sup>55</sup> [http://www.eia.gov/dnav/ng/ng\\_pri\\_sum\\_dcu\\_nus\\_a.htm](http://www.eia.gov/dnav/ng/ng_pri_sum_dcu_nus_a.htm). EIA reports average annual delivered natural gas prices to the electricity sector for the past 15 years (since 1996) and reports average monthly delivered natural gas prices to the electricity sector over the past 10 years (since 2001).

<sup>56</sup> Note that while EIA forecasts natural gas prices to rise, it also forecasts coal price to rise as well. An ideal comparison of levelized costs in future time periods should account for the expected change in both natural gas and coal prices.

net costs. However, based on average annual gas prices over the last 15 years, we project that this standard is most likely to have negligible costs, and, if it does impose costs, it likely also produces positive, although modest, net benefits. There is an exceedingly low probability that it results in net costs.

### **5.10.3 Illustrative Costs and Benefits of CCS Compared with Conventional Coal**

The analysis above focuses on two well developed control technologies, conventional supercritical coal and natural gas combined cycle. Because these technologies are well developed, there is significantly more certainty about operating costs than for new, emerging technologies like coal with CCS. As a result, any analysis that examines the relative social costs of coal vs. coal with CCS is considerably more uncertain and should primarily be used as a guide to the key sensitivities in the relative social costs. EPA compared the costs and damages for a model pulverized coal (PC) EGU using supercritical steam conditions (like the one used in the comparisons above) to and IGCC plant with a CCS system (e.g. Selexol). See technical memo “Control Cost and Environmental Impacts of the Proposed GHG NSPS on new Coal-Fired Electric Utility Generating Units” for more details.

EPA analyzed the cost and emission impacts for two scenarios. In the first scenario, partial capture achieves the proposed emissions rate of 1,000 lb CO<sub>2</sub>/MWh gross output. This requires that approximately 39% of the CO<sub>2</sub> is captured and stored. EPA has not previously developed costs for such a unit, therefore, this analysis may not fully realize all of the cost savings possible from building a unit with significantly less than 90% capture (for instance, an IGCC could be built with a conventional gas turbine, rather than one designed for higher temperature characteristics of a higher hydrogen content fuel). A 90% capture system was also examined to analyze the cost of several proposed new coal-fired EGUs using CCS. In the near term, any new coal-fired EGU with CCS would most likely be located in areas amenable to using the captured CO<sub>2</sub> in enhanced oil recovery (EOR) operations. This is because EOR provides a revenue stream that is not available for other forms of geologic storage. For example, the Texas Clean Energy project<sup>57</sup> is planning to capture 90% of the CO<sub>2</sub> and sell it for enhanced oil recovery.

To evaluate the potential revenues from EOR we examined two options. We considered a case where CO<sub>2</sub> could be sold for \$45/ton based on recent DOE studies for the 90% capture case.<sup>58</sup> We also considered a lower revenue sensitivity where CO<sub>2</sub> could be sold for \$15/ton

---

<sup>57</sup> <http://www.texascleanenergyproject.com/>

<sup>58</sup> US DOE / NETL studies have assumed a delivered CO<sub>2</sub> price ranging from \$40 - \$45/tonne. “Improving Domestic Energy Security and Lowering CO<sub>2</sub> Emissions with “Next Generation” CO<sub>2</sub>-Enhanced Oil Recovery (CO<sub>2</sub>-EOR)”,

(equivalent to the cost assumed for the transport and storage of CO<sub>2</sub> in the analysis) for the partial capture case. Costs for the IGCC unit with 90% capture and the supercritical pulverized coal-fired (SPC) unit without CCS were derived from IPM version 4.10.<sup>59</sup> These cost estimates are generally consistent with the range of studies estimating the cost of CCS that are available, however there is uncertainty around any such projections of technology costs, particularly for early movers of this technology. Capital costs for the IGCC unit with 39% capture were assumed to be 90% of the capital costs for an IGCC unit with 90% CCS. EPA estimated the benefits associated with avoided CO<sub>2</sub> and SO<sub>2</sub> emissions in a similar fashion to the one described above. See technical memo “Control Cost and Environmental Impacts of the Proposed GHG NSPS on new Coal-Fired Electric Utility Generating Units” for more details.

**Table 5-8. Illustrative Costs and Benefits for two CCS Scenarios Compared to Conventional Coal Plant (per MWh 2007\$)**

	SPC to IGCC with 39% Capture	SPC to IGCC with 90% Capture
Additional Gross Annual Private Costs	\$17	\$34
Revenue from EOR	\$5 (@\$15/ton)	\$37(@\$45/ton)
Net Additional Annual Private Costs	\$12	(\$3)
Value of Monetized Benefits		
SCC 3% with Pope 7%	\$13	\$24
SCC 3% with Laden 3%	\$23	\$34
Net Monetized Benefits		
SCC 3% with Pope 7%	\$1	\$27
SCC 3% with Laden 3%	\$11	\$37

This analysis suggests that the relative social cost of CCS compared to conventional coal is sensitive to the achieved generating costs for CCS units, the revenue stream from EOR, and the monetary value of avoided climate and other air pollution damages. However, it also suggests that, at relatively low prices for EOR revenue (\$15/MWh), CCS generation can generate net social benefits compared to conventional coal generation. As before, it is important to note that these comparisons omit additional benefits that may be associated with the abatement of greenhouse gas emissions.

DOE/NETL-2011/1504 (June 2011); and “Storing CO<sub>2</sub> with Enhanced Oil Recovery, DOE/NETL-402/1312 (February 2008).

<sup>59</sup><http://www.epa.gov/airmarkets/progsregs/epa-ipm/BaseCasev410.html>

### 5.11 Macroeconomic and Employment Impacts

This proposed EGU GHG NSPS is not anticipated to change GHG emissions for newly constructed electric generating units, and is anticipated to impose negligible costs or quantified benefits. EPA typically presents the economic impacts to secondary markets (e.g., changes in industrial markets resulting from changes in electricity prices) and impacts to employment or labor markets associated with proposed rules based on the estimated compliance costs and other energy impacts, which serve as an input to such analyses. However, since the EPA does not forecast a change in behavior relative to the baseline in response to this proposed rule, there are no notable macroeconomic or employment impacts expected as a result of this proposed rule.

### 5.12 References

Baumol, W.J. and W. E. Oates, *The Theory of Environmental Policy*. 2nd Edition. Cambridge University Press: New York (1988).

Blyth, W. and Yang, M. and Bradley, R. *Climate policy uncertainty and investment risk*. 2007. OECD/IEA.

Dalia Patiño-Echeverri, Paul Fischbeck, and Elmar Kriegler. *Economic and Environmental Costs of Regulatory Uncertainty for Coal-Fired Power Plants*. *Environmental Science & Technology* 2009 43 (3), 578-584.

Hoffmann, Volker H. and Trautmann, Thomas and Hamprecht, Jens. *Regulatory Uncertainty: A Reason to Postpone Investments? Not Necessarily*. *Journal of Management Studies* 2009 46 (7), 1467-6486.

Joskow, P.L. 2010. *Comparing the Cost of Intermittent and Dispatchable Electricity Generating Technologies*. MIT Center for Energy and Environmental Policy Research Working Paper 10-013.

Laden, F., J. Schwartz, F.E. Speizer, and D.W. Dockery. 2006. *Reduction in Fine Particulate Air Pollution and Mortality*. *American Journal of Respiratory and Critical Care Medicine* 173:667-672.

Malik, N.S. 2010, November 1. *NextEra CEO sees clean energy standards replacing recent climate proposals* [Radio transcript]. Dow Jones News [Online]. Available: Dow Jones Interactive Directory: Publications Library.

Mufson, S. 2011, January 2. *Coal's burnout*. *The Washington Post*. Retrieved from <http://www.washingtonpost.com/newssearch>.

- Muller, N.Z., R. Mendelsohn, and W. Nordhaus. Environmental Accounting for Pollution in the United States Economy. *American Economic Review*. 101:1649-1675.
- Pope, C.A., III, R.T. Burnett, M.J. Thun, E.E. Calle, D. Krewski, K. Ito, and G.D. Thurston. 2002. Lung Cancer, Cardiopulmonary Mortality, and Long-term Exposure to Fine Particulate Air Pollution. *Journal of the American Medical Association* 287:1132-1141.
- Reinelt, Peter S.; Keith, David W. Carbon Capture Retrofits and the Cost of Regulatory Uncertainty. *Energy Journal*, 2007, Vol. 28 Issue 4, p101-127.
- Rosenberg, M. 2011, September/October. "The Reign of Cheap Gas." *EnergyBiz Magazine*. Retrieved from <http://www.energybiz.com/magazine/article/234577/reign-cheap-gas>.
- Teisberg, E.O. An Option Valuation Analysis of Investment Choices by a Regulated Firm. *Management Science*, 1994, 40 (4) 535-548.
- Tong, S. 2010, November 1. Placing Bets on Clean Energy. [Radio transcript]. American Public Media: *Marketplace* [Online]. Available: Marketplace Programs on Demand.
- National Research of Council (NRC). 2009. Hidden Costs of Energy: Unpriced Consequences of Energy Production and Use. National Academies Press: Washington, D.C.
- U.S. Environmental Protection Agency (U.S. EPA). 2009. Integrated Science Assessment for Particulate Matter (Final Report). EPA-600-R-08-139F. National Center for Environmental Assessment – RTP Division. December. Available on the Internet at <<http://cfpub.epa.gov/ncea/cfm/recorddisplay.cfm?deid=216546>>.
- U.S. Environmental Protection Agency (U.S. EPA). 2006. Air Quality Criteria for Ozone and Related Photochemical Oxidants (Final). EPA/600/R-05/004aF-cF. Washington, DC: U.S. EPA. February. Available on the Internet at <<http://cfpub.epa.gov/ncea/CFM/recorddisplay.cfm?deid=149923>>.
- U.S. Environmental Protection Agency (U.S. EPA). 2008. Integrated Science Assessment for Oxides of Nitrogen and Sulfur –Ecological Criteria National (Final Report). National Center for Environmental Assessment, Research Triangle Park, NC. EPA/600/R-08/139. December. Available on the Internet at <<http://cfpub.epa.gov/ncea/cfm/recorddisplay.cfm?deid=201485>>.
- U.S. Environmental Protection Agency (U.S. EPA). 2011. Regulatory Impact Analysis (RIA) for the final Transport Rule. Office of Air and Radiation, Washington, DC. June. Available on the Internet at <<http://www.epa.gov/airtransport/pdfs/FinalRIA.pdf>>. Fann, N., C.M. Fulcher, B.J. Hubbell. 2009. The influence of location, source, and emission type in estimates of the human health benefits of reducing a ton of air pollution. *Air Qual Atmos Health* 2:169–176.



## CHAPTER 6 STATUTORY AND EXECUTIVE ORDER ANALYSES

### 6.1 Synopsis

This chapter presents discussion and analyses relating to Executive Orders and statutory requirements relevant to the proposed EGU GHG NSPS.<sup>1</sup> We discuss analyses conducted to meet the requirements of Executive Orders 12866 and 13563, as well as, potential impacts to affected small entities required by the Regulatory Flexibility Act (RFA), as amended by the Small Business Regulatory Enforcement Fairness Act (SBREFA). We also discuss the requirements of the Unfunded Mandates Reform Act of 1995 (UMRA) and assess the impact of the proposed rule on state, local and tribal governments and the private sector, along with the analysis conducted to comply with the Paperwork Reduction Act (PRA). In addition, we address the requirements of Executive Order (EO) 13045: Protection of Children from Environmental Health and Safety Risks; EO 13132: Federalism; EO 13175: Consultation and Coordination with Indian Tribal Governments; EO 12898: Federal Actions to Address Environmental Justice in Minority Populations and Low-Income Populations; EO 13211: Actions that Significantly Affect Energy Supply, Distribution, or Use; and the National Technology Transfer and Advancement Act (NTTAA).

### 6.2 Executive Order 12866, Regulatory Planning and Review, and Executive Order 13563, Improving Regulation and Regulatory Review

Under EO 12866 (58 FR 51,735, October 4, 1993), this action is a “significant regulatory action” because it “raises novel legal or policy issues arising out of legal mandates.” Accordingly, EPA submitted this action to the Office of Management and Budget (OMB) for review under Executive Orders 12866 and 13563 (76 FR 3821, January 21, 2011) and any changes made in response to OMB recommendations have been documented in the docket for this action.

In addition, EPA prepared an analysis of the potential costs and benefits associated with this action. This analysis is contained in this RIA. Based on the analysis presented in Chapter 5, EPA believes this rule will have negligible compliance costs associated with it, over a range of likely sensitivity conditions, because even in the absence of the proposal, electric power companies will choose to build new EGUs that comply with the regulatory requirements of this proposal because of existing and expected market conditions. Because our modeling shows

---

<sup>1</sup> Electricity Generating Unit Greenhouse Gas New Source Performance Standard - The NSPS would be established under section 111(b) of the Clean Air Act (CAA).

that new fossil-fuel fired capacity constructed through 2020 will most likely be natural gas combined cycle capacity along with a small amount of coal with CCS supported by federal funding, the proposed standard of performance — which is based on the emission rate of a new NGCC unit — would not add costs. The EPA does not project any new coal-fired EGUs without CCS to be built.

### **6.3 Paperwork Reduction Act**

The information collection requirements have been submitted for approval to the Office of Management and Budget under the Paperwork Reduction Act, 44 U.S.C. 3501 et seq. The Information Collection Request (ICR) document prepared by the EPA has been assigned EPA ICR number 2465.01.

This proposed action would impose minimal new information collection burden on affected sources beyond what those sources would already be subject to under the authorities of CAA parts 75 and 98. OMB has previously approved the information collection requirements contained in the existing part 75 and 98 regulations (40 CFR part 75 and 40 CFR part 98) under the provisions of the PRA, 44 U.S.C. 3501 et seq. and has assigned OMB control numbers 2060-0626 and 2060-0629, respectively. Apart from certain reporting costs based on requirements in the NSPS General Provisions (40 CFR part 60, subpart A), which are mandatory for all owners/operators subject to CAA section 111 national emission standards, there are no new information collection costs, as the information required by this proposed rule is already collected and reported by other regulatory programs. The recordkeeping and reporting requirements are specifically authorized by CAA section 114 (42 U.S.C. 7414). All information submitted to the EPA pursuant to the recordkeeping and reporting requirements for which a claim of confidentiality is made is safeguarded according to Agency policies set forth in 40 CFR part 2, subpart B.

The EPA believes that electric power companies will choose to build new EGUs that comply with the regulatory requirements of this proposal because of existing and expected market conditions. The EPA does not project any new coal-fired EGUs without CCS that commence construction after this proposal to commence operation over the 3-year period covered by this ICR. We estimate that 17 new affected NGCC units would commence operation during that time period. As a result of this proposal, those units would be required to prepare a summary report, which includes reporting of excess emissions and downtime every 6 months.

When a malfunction occurs, sources must report them according to the applicable reporting requirements of 40 CFR part 60, subpart TTTT. An affirmative defense to civil

penalties for exceedances of emission limits that are caused by malfunctions is available to a source if it can demonstrate that certain criteria and requirements are satisfied. The criteria ensure that the affirmative defense is available only where the event that causes an exceedance of the emission limit meets the narrow definition of malfunction (sudden, infrequent, not reasonable preventable, and not caused by poor maintenance and or careless operation) and where the source took necessary actions to minimize emissions. In addition, the source must meet certain notification and reporting requirements. For example, the source must prepare a written root cause analysis and submit a written report to the Administrator documenting that it has met the conditions and requirements for assertion of the affirmative defense.

To provide the public with an estimate of the relative magnitude of the burden associated with an assertion of the affirmative defense position adopted by a source, the EPA has estimated what the notification, recordkeeping, and reporting requirements associated with the assertion of the affirmative defense might entail. The EPA's estimate for the required notification, reports, and records, including the root cause analysis, associated with a single incident totals approximately \$3,141, and is based on the time and effort required of a source to review relevant data, interview plant employees, and document the events surrounding a malfunction that has caused an exceedance of an emission limit. The estimate also includes time to produce and retain the record and reports for submission to the EPA. The EPA provides this illustrative estimate of this burden, because these costs are only incurred if there has been a violation, and a source chooses to take advantage of the affirmative defense.

The EPA provides this illustrative estimate of this burden because these costs are only incurred if there has been a violation and a source chooses to take advantage of the affirmative defense. Given the variety of circumstances under which malfunctions could occur, as well as differences among sources' operation and maintenance practices, we cannot reliably predict the severity and frequency of malfunction-related excess emissions events for a particular source. It is important to note that the EPA has no basis currently for estimating the number of malfunctions that would qualify for an affirmative defense. Current historical records would be an inappropriate basis, as source owners or operators previously operated their facilities in recognition that they were exempt from the requirement to comply with emissions standards during malfunctions. Of the number of excess emissions events reported by source operators, only a small number would be expected to result from a malfunction (based on the definition above), and only a subset of excess emissions caused by malfunctions would result in the source choosing to assert the affirmative defense. Thus, we believe the number of instances in

which source operators might be expected to avail themselves of the affirmative defense will be extremely small. In fact, we estimate that there will be no such occurrences for any new sources subject to 40 CFR part 60, subpart TTTT over the 3-year period covered by this ICR. We expect to gather information on such events in the future, and will revise this estimate as better information becomes available.

The annual information collection burden for this collection consists only of reporting burden as explained above. The reporting burden for this collection (averaged over the first 3 years after the effective date of the standards) is estimated to be \$15,570 and 396 labor hours. This estimate includes semi-annual summary reports which include reporting of excess emissions and downtime. All burden estimates are in 2010 dollars. Average burden hours per response are estimated to be 16.5 hours. The total number of respondents over the 3-year ICR period is estimated to be 36. Burden is defined at 5 CFR 1320.3(b).

An agency may not conduct or sponsor, and a person is not required to respond to, a collection of information unless it displays a currently valid OMB control number. The OMB control numbers for EPA's regulations in 40 CFR are listed in 40 CFR part 9.

To comment on the Agency's need for this information, the accuracy of the provided burden estimates, and any suggested methods for minimizing respondent burden the EPA has established a public docket for this proposed rule, which includes this ICR, under Docket ID number EPA-HQ-OAR-2011-0660. The final rule will respond to any OMB or public comments on the information collection requirements contained in this proposal.

#### **6.4. Regulatory Flexibility Act as Amended by the Small Business Regulatory Enforcement Fairness Act of 1996, 5 U.S.C. et seq.**

The RFA generally requires an agency to prepare a regulatory flexibility analysis of any rule subject to notice and comment rulemaking requirements under the Administrative Procedure Act or any other statute unless the agency certifies that the rule will not have a significant economic impact on a substantial number of small entities. Small entities include small businesses, small organizations, and small governmental jurisdictions.

For purposes of assessing the impacts of this rule on small entities, small entity is defined as:

(1) A small business that is defined by the Small Business Administration's regulations at 13 CFR 121.201 (for the electric power generation industry, the small business size standard is

an ultimate parent entity defined as having a total electric output of 4 million MWh or less in the previous fiscal year. The NAICS codes for the affected industry are in Table 6-1 below);

(2) A small governmental jurisdiction that is a government of a city, county, town, school district, or special district with a population of less than 50,000; and

(3) A small organization that is any not-for-profit enterprise which is independently owned and operated and is not dominant in its field.

**Table 6-1. Potentially Regulated Categories and Entities<sup>a</sup>**

Category	NAICS Code	Examples of Potentially Regulated Entities
Industry	221112	Fossil fuel electric power generating units.
Federal Government	221112 <sup>b</sup>	Fossil fuel electric power generating units owned by the federal government.
State/Local Government	221112 <sup>b</sup>	Fossil fuel electric power generating units owned by municipalities.
Tribal Government	921150	Fossil fuel electric power generating units in Indian Country.

<sup>a</sup> Include NAICS categories for source categories that own and operate electric power generating units (includes boilers and stationary combined cycle combustion turbines).

<sup>b</sup> Federal, state, or local government-owned and operated establishments are classified according to the activity in which they are engaged.

After considering the economic impacts of this proposed rule on small entities, the Administrator of EPA certifies that this action will not have a significant economic impact on a substantial number of small entities.

We do not include an analysis of the illustrative impacts on small entities that may result from implementation of this proposed rule by states because we anticipate negligible compliance costs over a range of likely sensitivities as a result of this proposal. Thus the cost-to-sales ratios for any affected small entity would be zero costs as compared to annual sales revenue for the entity. The EPA believes that electric power companies will choose to build new EGUs that comply with the regulatory requirements of this proposal because of existing and expected market conditions. (See the RIA for further discussion of sensitivities.) Because our modeling shows that new fossil-fuel fired capacity constructed through 2020 will most likely be natural gas combined cycle capacity along with a small amount of coal with CCS supported by federal funding, the proposed standard of performance — which is based on the emission rate of a new NGCC unit — would not add costs. The EPA does not project any new coal-fired

EGUs without CCS to be built. Accordingly, there are no anticipated economic impacts as a result of this proposal.

Nevertheless, the EPA is aware that there is substantial interest in this rule among small entities (municipal and rural electric cooperatives). In light of this interest, the EPA determined to seek early input from representatives of small entities while formulating the provisions of this proposed regulation. Such outreach is also consistent with the President's January 18, 2011 Memorandum on Regulatory Flexibility, Small Business, and Job Creation, which emphasizes the important role small businesses play in the American economy. This process has enabled the EPA to hear directly from these representatives, at a very preliminary stage, about how it should approach the complex question of how to apply Section 111 of the CAA to the regulation of GHGs from these source categories. The EPA's outreach regarded planned actions for new and existing sources, but only new sources would be affected by this proposed action.

The EPA conducted an initial outreach meeting with small entity representatives on April 6, 2011. The purpose of the meeting was to provide an overview of recent EPA proposals impacting the power sector. Specifically, overviews of the Cross-State Air Pollution Rule, the Mercury and Air Toxics Standards, and the Clean Water Act 316(b) Rule proposals were presented.

The EPA conducted outreach with representatives from 20 various small entities that potentially would be affected by this rule. The representatives included small entity municipalities, cooperatives, and private investors. The EPA distributed outreach materials to the small entity representatives; these materials included background, an overview of affected sources and GHG emissions from the power sector, an overview of CAA section 111, an assessment of CO<sub>2</sub> emissions control technologies, potential impacts on small entities, and a summary of the five listening sessions that EPA held in February and March 2011 with various stakeholder groups to get feedback from key stakeholders and the public before the agency initiated the rulemaking process for new greenhouse gas emissions standards.<sup>2</sup> EPA met with eight of the small entity representatives, as well as three participants from organizations representing power producers, on June 17, 2011, to discuss the outreach materials, potential requirements of the rule, and regulatory areas where the EPA has discretion and could potentially provide flexibility.

---

<sup>2</sup> <http://www.epa.gov/airquality/listen.html>

A second outreach meeting was conducted on July 13, 2011. We met with nine of the small entity representatives, as well as three participants from organizations representing power producers. During the second outreach meeting, various small entity representatives and participants from organizations representing power producers presented information regarding issues of concern with respect to development of standards for GHG emissions for both new and existing sources. Specifically, topics discussed included: boilers with limited opportunities for efficiency improvements due to NSR complications for conventional pollutants; variances per kilowatt-hour and in heat rates over monthly and annual operations; significance of plant age; legal issues; importance of future determination of carbon neutrality of biomass; and differences between municipal government electric utilities and other utilities.

Small entities expressed concern regarding units making modifications being regulated as new sources. As explained above, we are not proposing a standard of performance for modifications. As a result, sources that undertake modifications would be treated as existing sources and thus would not be subject to the requirements proposed in this notice. As also explained above, the EPA is not proposing standards of performance for existing proposed EGUs, which are referred to as transitional sources, that have acquired a complete preconstruction permit by the time of this proposal and that commence construction within 12 months of this proposal. As a result, any transitional sources owned by small entities would not be subject to the standards of performance proposed in today's rule.

We invite comments on all aspects of the proposal and its impacts, including potential adverse impacts, on small entities.

## **6.5 Unfunded Mandates Reform Act of 1995**

This proposed rule does not contain a Federal mandate that may result in expenditures of \$100 million or more for State, local, or tribal governments, in the aggregate, or the private sector in any one year. The EPA believes this proposed rule will have negligible compliance costs associated with it over a range of likely sensitivity conditions because electric power companies will choose to build new EGUs that comply with the regulatory requirements of this proposal because of existing and expected market conditions. (See the RIA for further discussion of sensitivities.) As previously explained, because our modeling shows that new fossil-fuel fired capacity constructed through 2020 will most likely be natural gas combined cycle capacity along with a small amount of coal with CCS supported by federal funding, the proposed standard of performance — which is based on the emission rate of a new NGCC unit — would not add costs. The EPA does not project any new coal-fired EGUs without CCS to be

built. Thus, this proposed rule is not subject to the requirements of sections 202 or 205 of UMRA. This proposed rule is also not subject to the requirements of section 203 of UMRA because it contains no regulatory requirements that might significantly or uniquely affect small governments.

In light of interest in this rule among governmental entities, the EPA initiated consultations with governmental entities. The EPA invited the following 10 national organizations representing state and local elected officials to a meeting held on April 12, 2011, in Washington DC: 1) National Governors Association; 2) National Conference of State Legislatures, 3) Council of State Governments, 4) National League of Cities, 5) U.S. Conference of Mayors, 6) National Association of Counties, 7) International City/County Management Association, 8) National Association of Towns and Townships, 9) County Executives of America, and 10) Environmental Council of States. These 10 organizations representing elected state and local officials have been identified by the EPA as the “Big 10” organizations appropriate to contact for purpose of consultation with elected officials. The purposes of the consultations were to provide general background on the proposal, answer questions, and solicit input from state/local governments. The EPA’s consultation regarded planned actions for new and existing sources, but only new sources would be affected by this proposed action.

During the meeting, officials asked clarifying questions regarding CAA section 111 requirements and efficiency improvements that would reduce CO<sub>2</sub> emissions. In addition, they expressed concern with regard to the potential burden associated with impacts on state and local entities that own/operate affected utility boilers, as well as on state and local entities with regard to implementing the rule. Subsequent to the April 12, 2011 meeting, the EPA received a letter from the National Conference of State Legislatures. In that letter, the National Conference of State Legislatures urged the EPA to ensure that the choice of regulatory options maximizes benefit and minimizes implementation and compliance costs on state and local governments; to pay particular attention to options that would provide states with as much flexibility as possible; and to take into consideration the constraints of the state legislative calendars and ensure that sufficient time is allowed for state actions necessary to come into compliance.

## **6.6 Executive Order 13132, Federalism**

This proposed action does not have federalism implications. It would not have substantial direct effects on the States, on the relationship between the national government and the States, or on the distribution of power and responsibilities among the various levels of



government, as specified in EO 13132. This proposed action would not impose substantial direct compliance costs on state or local governments nor would it preempt state law. Thus, Executive Order 13132 does not apply to this action. The EPA consulted with state and local officials in the process of developing the proposed rule to permit them to have meaningful and timely input into its development. The EPA's consultation regarded planned actions for new and existing sources, but only new sources would be affected by this proposed action. The EPA met with 10 national organizations representing state and local elected officials to provide general background on the proposal, answer questions, and solicit input from state/local governments. The UMRA discussion in this chapter includes a description of the consultation. In the spirit of EO 13132 and consistent with EPA policy to promote communications between the EPA and state and local governments, the EPA specifically solicits comment on this proposed action from state and local officials.

#### **6.7 Executive Order 13175, Consultation and Coordination with Indian Tribal Governments**

Subject to the EO 13175 (65 FR 67249, November 9, 2000) EPA may not issue a regulation that has tribal implications, that imposes substantial direct compliance costs, and that is not required by statute, unless the Federal government provides the funds necessary to pay the direct compliance costs incurred by tribal governments, or EPA consults with tribal officials early in the process of developing the proposed regulation and develops a tribal summary impact statement.

EPA has concluded that this proposed action would not have tribal implications. It would neither impose substantial direct compliance costs on tribal governments, nor preempt tribal law. This proposed rule would impose requirements on owners and operators of EGUs. The EPA is aware of three coal-fired EGUs located in Indian country but is not aware of any EGUs owned or operated by tribal entities. The EPA notes that this proposal does not affect existing sources such as the three coal-fired EGUs located in Indian country, but addresses CO<sub>2</sub> emissions for new EGU sources only.

Because the EPA is aware of tribal interest in this proposed rule, the EPA offered consultation with tribal officials early in the process of developing this proposed regulation to permit them to have meaningful and timely input into its development. The EPA's consultation regarded planned actions for new and existing sources, but only new sources would be affected by this proposed action.

Consultation letters were sent to 584 tribal leaders. The letters provided information regarding EPA's development of NSPS and emission guidelines for EGUs and offered consultation. A consultation/outreach meeting was held on May 23, 2011, with the Forest County Potawatomi Community, the Fond du Lac Band of Lake Superior Chippewa Reservation, and the Leech Lake Band of Ojibwe. Other tribes participated in the call for information gathering purposes. In this meeting, the EPA provided background information on the GHG emission standards to be developed and a summary of issues being explored by the Agency. Tribes suggested that the EPA consider expanding coverage of the GHG standards to include combustion turbines, lowering the 250 MMBtu per hour heat input threshold so as to capture more EGUs, and including credit for use of renewables. The tribes were also interested in the scope of the emissions averaging being considered by the Agency (e.g., over what time period, across what units) for a possible existing source standard. In addition, the EPA held a series of listening sessions on this proposed action. Tribes participated in a session on February 17, 2011 with the state agencies, as well as in a separate session with tribes on April 20, 2011.

The EPA will also hold additional meetings with tribal environmental staff to inform them of the content of this proposal as well as provide additional consultation with tribal elected officials where it is appropriate. We specifically solicit additional comment on this proposed rule from tribal officials.

#### **6.8 Executive Order 13045, Protection of Children from Environmental Health Risks and Safety Risks**

The EPA interprets EO 13045 (62 FR 19885, April 23, 1997) as applying to those regulatory actions that concern health or safety risks, such that the analysis required under section 5-501 of the Order has potential to influence the regulation. This proposed action is not subject to EO 13045 because it is based solely on technology performance. The proposal is not expected to produce changes in emissions of greenhouse gases or other pollutants but does encourage the current trend towards cleaner generation, helping to protect air quality and children's health. The Agency recognizes that children are among the groups most vulnerable to climate change impacts and the public is invited to submit comments or identify peer reviewed studies relevant to this proposal.

#### **6.9 Executive Order 13211, Actions Concerning Regulations That Significantly Affect Energy Supply, Distribution, or Use**

This proposed action is not a "significant energy action" as defined in Executive Order 13211 (66 FR 28355, May 22, 2001), because it is not likely to have a significant adverse effect on the supply, distribution, or use of energy. This proposed action is anticipated to have

negligible impacts on emissions, costs or energy supply decisions for the affected electric utility industry.

#### **6.10 National Technology Transfer and Advancement Act**

Section 12(d) of the NTTAA of 1995 (Public Law No. 104-113; 15 U.S.C. 272 note) directs the EPA to use Voluntary Consensus Standards (VCS) in their regulatory and procurement activities unless to do so would be inconsistent with applicable law or otherwise impractical. VCS are technical standards (e.g., materials specifications, test methods, sampling procedures, business practices) developed or adopted by one or more voluntary consensus bodies. The NTTAA directs the EPA to provide Congress, through annual reports to the OMB, with explanations when an agency does not use available and applicable VCS.

This proposed rulemaking involves technical standards. The EPA cites the following standards in this proposed rule: D5287-08 (Standard Practice for Automatic Sampling of Gaseous Fuels), D4057-06 (Standard Practice for Manual Sampling of Petroleum and Petroleum Products), and D4177-95(2010) (Standard Practice for Automatic Sampling of Petroleum and Petroleum Products). The EPA is proposing use of Appendices B, D, F, and G to 40 CFR part 75; these Appendices contain standards that have already been reviewed under the NTTAA.

The EPA welcomes comments on this aspect of the proposed rulemaking and, specifically, invites the public to identify potentially-applicable VCS and to explain why such standards should be used in this action.

#### **6.11 Executive Order 12898: Federal Actions to Address Environmental Justice in Minority Populations and Low-Income Populations**

Executive Order 12898 (59 FR 7629, February 16, 1994) establishes Federal executive policy on environmental justice. Its main provision directs Federal agencies, to the greatest extent practicable and permitted by law, to make environmental justice part of their mission by identifying and addressing, as appropriate, disproportionately high and adverse human health or environmental effects of their programs, policies, and activities on minority populations and low-income populations in the U.S. EPA has determined that this proposed rule would not result in disproportionately high and adverse human health or environmental effects on any minority, low-income, or indigenous populations.

---

United States  
Environmental Protection  
Agency

Office of Air Quality Planning and Standards  
Health and Environmental Impacts Division  
Research Triangle Park, NC

Publication No. EPA-452/R-12-001  
March 2012

---