



Work Breakdown Structure-Based Cost Model for Reverse Osmosis/Nanofiltration Drinking Water Treatment

Office of Water (4607M)
EPA ***_*_*****
March 2023

Table of Contents

1. Introduction.....	1
1.1 Background	1
1.2 Objectives.....	1
1.3 Organization of the Report.....	2
1.4 List of Abbreviations and Symbols in this Chapter	2
1.5 References	2
2. WBS Model Overview	3
2.1 Model Structure.....	3
2.2 The WBS Approach	8
2.3 Model Use	10
2.3.1 Input Sheet Structure and Use.....	10
2.3.2 Common Inputs.....	13
2.3.3 Input Sheet Examples	16
2.3.4 Output Sheet Structure and Use.....	18
2.3.5 Critical Design Assumptions Sheet Structure and Use.....	18
2.3.6 Index Sheet Structure and Use.....	21
2.4 General Cost Assumptions.....	22
2.4.1 Building Costs.....	24
2.4.2 Residuals Management Costs	24
2.4.3 Indirect Capital Costs.....	25
2.4.4 Add-on Costs	26
2.4.5 Annual O&M Costs	27
2.4.6 Total Annualized Cost	28
2.4.7 Updating and Adjusting Costs	28
2.5 List of Abbreviations and Symbols in this Chapter	29
2.6 References	29
3. Reverse Osmosis and Nanofiltration Model.....	31
3.1 Overview of the RO/NF Treatment Process	32
3.2 Input Sheet.....	36
3.3 Model Assumptions Sheets	49
3.4 Influent and Booster Pumping Sheet.....	52
3.5 Pre-treatment Sheet	52
3.6 Feed Water Sheet	53
3.7 Train Design Sheets	53
3.7.1 Overview.....	53
3.7.2 Train Design Sheet.....	54
3.7.3 Pressure Tuning Sheet.....	55
3.7.4 Calc System and Calc One Element Sheets.....	56
3.8 Membrane Capital Sheet	59
3.9 Cleaning Sheet.....	60
3.10 Pipes and Structure Sheet	61
3.11 Instrumentation and Control Sheet.....	62
3.12 Residuals Management Sheet.....	62
3.13 O&M and HVAC Sheets	63
3.14 Indirect Sheet.....	64

3.15	Output Sheet	64
3.16	Ancillary Model Components	65
3.17	List of Abbreviations and Symbols in this Chapter.....	65
3.18	References	66
Appendix A. Valves, Instrumentation and System Controls.....		68
Appendix B. Building Construction Costs.....		74
Appendix C. Residuals Management Costs.....		83
Appendix D. Indirect Capital Costs		92
Appendix E. General Assumptions for Operating and Maintenance Costs.....		115

1. Introduction

This report is one of a series of reports describing cost models for drinking water treatment technologies. Most of these technologies are used in drinking water systems to remove or destroy pollutants such as arsenic, radon, disinfection byproducts, sulfates, hardness and waterborne pathogens. In addition, several of these technologies can be used as add-on technologies to existing treatment systems. For example, some of the technologies can be installed to provide pre-oxidation to improve contaminant removal efficiency by subsequent treatment processes.

1.1 Background

The Safe Drinking Water Act Amendments of 1996, as well as a number of other statutes and executive orders, require that the U.S. Environmental Protection Agency (EPA or the Agency) estimate regulatory compliance cost as part of its rulemaking process. EPA developed the models described in this document to assist in fulfilling this requirement. In other words, the primary purpose of these models is to aid EPA in estimating national compliance costs. The models might be acceptable, however, for other uses (e.g., developing a preliminary site-specific estimate for a water system) if sufficient care is taken to account for site- or project-specific factors appropriate to the intended use.

The compliance cost models described in this document differ from the drinking water cost models previously used by the Agency in that the new models are based on a work breakdown structure (WBS) approach to developing cost estimates. In general, the WBS approach involves breaking a process down into discrete components for the purpose of estimating unit costs. EPA pursued this approach as part of an effort to address recommendations made by the Technology Design Panel, which convened in 1997 to review the Agency's methods for estimating drinking water compliance costs (U.S. EPA, 1997).¹

1.2 Objectives

In developing WBS-based models for estimating drinking water treatment system costs, EPA had the following objectives:

- Transparency of process design and cost
- Defensibility of design criteria and assumptions
- Ease of use and updating
- Modularity of components for use with centralized cost database.

The Agency determined that the best way to meet these goals was to develop spreadsheet-based engineering models drawing from a central database of component unit costs. Each engineering model contains the work breakdown for a particular treatment process and preprogrammed engineering criteria and equations that estimate equipment requirements for user-specified design requirements (e.g., system size and influent water quality). Each model also provides unit and total cost information by component (e.g., individual items of capital equipment) and totals the

¹ The panel consisted of nationally recognized drinking water experts from U.S. EPA, water treatment consulting companies, public and private water utilities, suppliers, equipment vendors and Federal and state regulators in addition to cost estimating professionals.

individual component costs to obtain a direct capital cost. Additionally, the models estimate add-on costs (permits, pilot study and land acquisition costs for each technology), indirect capital costs and annual operating and maintenance (O&M) costs, thereby producing a complete compliance cost estimate.

1.3 Organization of the Report

This report is organized as follows:

- Chapter 2 provides an overview of the general model components and the methods used in these components to estimate treatment system costs.
- Subsequent chapters describe the individual models, design criteria and assumptions for the selected treatment technologies.
- Appendices provide additional information on methods EPA used to estimate design requirements and costs for specific components, such as buildings, system controls, indirect capital costs and annual O&M costs.

1.4 List of Abbreviations and Symbols in this Chapter

EPA	U.S. Environmental Protection Agency
O&M	operating and maintenance
WBS	work breakdown structure

1.5 References

U.S. Environmental Protection Agency (U.S. EPA). 1997. *Discussion Summary: EPA Technology Design Workshop*. Washington, D.C.: U.S. EPA, Office of Groundwater and Drinking Water.

2. WBS Model Overview

This chapter includes the following sections:

- An overview of how the models are structured (Section 2.1)
- A description of how this structure was developed using the work breakdown structure (WBS) approach (Section 2.2)
- A brief users guide describing how to operate the models (Section 2.3), including documentation of general design assumptions
- Documentation of the general cost assumptions incorporated in all of the models (Section 2.4).

2.1 Model Structure

The WBS-based engineering models integrate the following structural features to generate treatment cost estimates:

- Treatment component selection, design and cost output based on a WBS approach
- Process design based on state-of-the-art techniques and generally recommended engineering practices (GREPs)
- A centralized reference database containing unit costs for components and reference tables for component sizing and chemical properties.

Exhibit 2-1 shows how these features are integrated in a series of spreadsheets that include an Excel workbook for each technology and a central cost and engineering reference database (the WBS cost database).² An input sheet allows the user to define treatment requirements such as system design and average flows, target contaminant and raw water quality. **Exhibit 2-2** provides an example of an input spreadsheet. The information provided via the input sheet interacts with three critical design assumption sheets (one each for process design, operating and maintenance [O&M] and indirect capital costs) to generate inputs to the engineering design sheets. Although the critical design assumption values are based on GREPs and can be used without modification, the user can also revise these values to reflect site-specific requirements. Each model also has a predetermined list of treatment equipment needs (e.g., tanks, vessels and instrumentation) identified using the WBS approach. The engineering design sheets calculate equipment quantity and size requirements based on the treatment needs and critical design assumptions. The technology chapters of this report describe technology-specific content and function of each sheet. General design and cost assumptions are described in Sections 2.3.5 and 2.4.

² EPA maintains the central WBS cost database in a separate Excel workbook. The WBS cost database itself is not provided along with the publicly released WBS models. Instead, for ease of review and to maintain vendor confidentiality, relevant cost and engineering data have been extracted from the database and included directly in the WBS model workbooks. Thus, users can review (and adjust, if needed) the information from the central cost database in the same manner as other WBS model inputs and assumptions.

Exhibit 2-1. Structure of the WBS Models

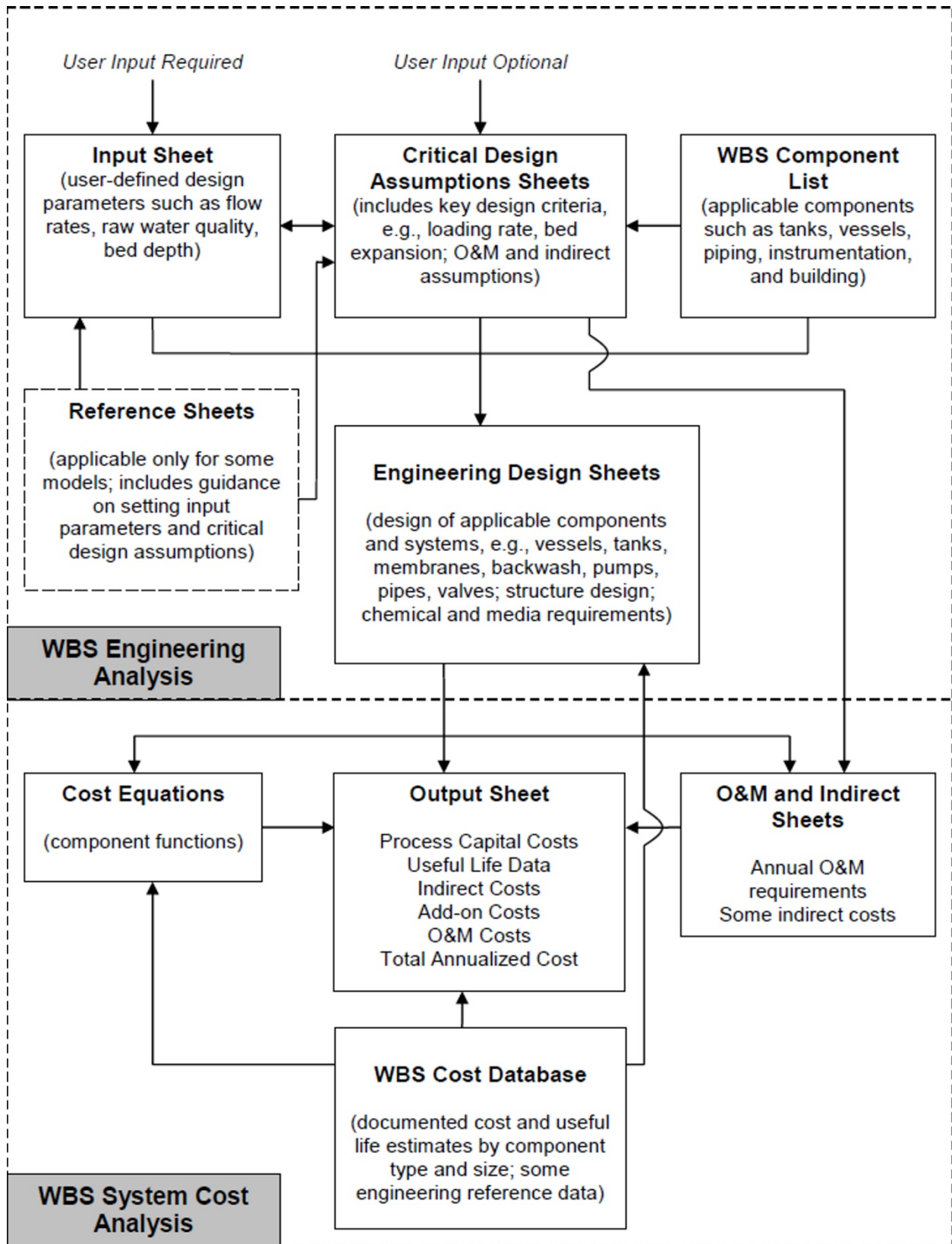

Exhibit 2-2. Sample of Input Spreadsheet

MULTI-STAGE BUBBLE AERATION SYSTEM DESIGN AND COST INPUT

STEP 1

Select Contaminant: For VOCs, default designs available up to 1 MGD only, because information on using MSBA for these contaminants in larger systems is limited

STEP 2:

Select one of the eight standard designs at right

OR

Select "CLEAR FOR MANUAL ENTRY"

0.030 mgd standard design	← Using this design
0.124 mgd standard design	
0.305 mgd standard design	
0.740 mgd standard design	
2.152 mgd standard design	
7.365 mgd standard design	
22.614 mgd standard design	
75.072 mgd standard design	
CLEAR FOR MANUAL ENTRY	

See model documentation for more information on standard designs

STEP 3:

Optional for standard designs
Enter or change values in the gold and blue cells below, under "Manual Inputs"

Input Complete -- Results Ready

STEP 4:

Results are ready (no need to click button)

Generate Results

[Results summary \(see OUTPUT sheet for details\)](#)
 Direct Capital Cost: \$107,797
 Total Capital Cost: \$156,997
 Annual O&M Cost: \$7,292
 Annualized Cost: \$23,629 (16.3 years at 7%)

MANUAL INPUTS

Cells in gold are required; cells in blue are optional

Design Flow	0.030	MGD	Select units
Average Flow	0.007	MGD	
For information:			
Treatment system design flow	0.030	MGD	
Bypass design flow	0.000	MGD	

Flow Input OK

Current bypass percentage is 0%. Go to Critical Design Assumptions to change this value.
[Adjust bypass percentage](#)

Optimize Number of Basins	Design Type	pre-engineered package	pick none
	Number of operating basins	Air to water ratio	1 unit
			40
	Maximum water depth		3 feet
	Number of stages		6
	Pilot rate constant		0.17 1/min
	Pilot air intensity		2.54 cfm/cubicft
For information:			
	Theoretical Percent Removal		90.07%
	Number of Basins (including redundancy)		1 units
	Basin Length (including quiescent chamber)		4 feet
	Basin Width		2.5 feet
	Basin Height (including freeboard)		5 feet
	Diffusers per stage		1 units
	Total diffusers		6 units

Basin Inputs OK

Vendor packages include aboveground stainless steel, plastic, or fiberglass basins and typically are used by small systems

Guidance: For VOCs, typical air to water ratios are between 10:1 and 300:1
 Guidance: VOCs require no more than 2 to 3 feet water depth, beyond this depth no significant gain is realized (Lowry peer review comments)
 Guidance: For VOCs, minimum of 6 stages, maximum of 12 stages, vendor uses 8 stages for most applications (Lowry peer review comments)

Estimate only, based on pilot rate constant and air intensity. To increase, increase air to water ratio and/or number of stages

[Adjust freeboard](#)
[Adjust basin length constraints](#)
[Adjust diffuser access space requirements](#)

Influent water concentration	5	ug/L
Percent removal		not required
VOC release at which air pollution control system is needed	1	lb/day
For information: Off-gas control system may not be required		
Off-gas pollution control technology	none	pick none
Heat recovery type		not required
Spent GAC regeneration		not required
GAC bed life		not required

Off-gas Inputs OK

Used only to determine whether air pollution control might be required; not part of system design
 Using theoretical removal from above
 CMRPP (2000) states this is the maximum emission level for all VOCs for California South Coast AQMD, but other districts may require different emissions standards based on location of the site and regional ambient air quality.

Number of booster pumps		pumps
For information: # of booster pumps	2	pumps
Number of blowers		blowers
For information: # of blowers (including redundant basins to be added)	2	blowers
Number of redundant basins to be added		units
For information: Redundant basins	0	units
Component level		pick or leave blank
System automation	fully automated	pick or leave blank
For information: Component level	low cost	
Automation	fully automated	

Optional Inputs OK

Enter 0 to exclude booster pumps (i.e., use existing pumps). Clear cell to accept model defaults (included for all sizes in this technology)

Designs should always include at least one blower. Leave blank to accept model default calculations.
[Adjust number of redundant blowers](#)

Leave blank to accept redundancy specified in critical design assumptions

Leave blank to use low cost components
 Leave blank to allow model to pick based on component level

Exhibit 2-3 shows an example of an output spreadsheet. The output sheet summarizes the results of the calculations performed by the engineering design sheets, listing size and quantity required for each item of equipment and the corresponding unit cost from the database. The output sheet multiplies unit cost by quantity to determine total component cost for each WBS component. The output sheet also lists the estimated useful life of every WBS component. The models use the component useful lives in estimating total annualized cost (see Section 2.4.6).

For many of the components, there are optional materials, all of which are illustrated on the output worksheet. For example, pressure vessels can be constructed with different types of body material (stainless steel or carbon steel) and different types of internal materials (stainless steel or plastic). Where there are optional materials, the output sheet selects from among these materials. The specific selections are determined by input values and documented in the “use?” column of the output worksheet. Direct capital cost is the sum of the selected component costs.

The output sheet also contains sections that calculate add-on costs, indirect capital costs, annual O&M costs and total annualized cost. Annual O&M costs are based on the annual requirements calculated on the O&M sheet. Indirect capital costs for certain items (standby power, geotechnical, site work and yard piping) are based on calculations performed by the indirect sheet. Other indirect capital costs and add-on costs are based on assumptions described in Sections 2.4.3 and 2.4.4. Section 2.4.6 describes the calculation of total annualized cost.

The output sheet obtains unit costs (both capital and O&M) either from the central WBS cost database or from estimated equipment cost curves. All of the treatment technology models use information from the WBS cost database, which consists of a series of lookup tables that contain costs by equipment or O&M element type and size. The database also provides useful life estimates and documents the source of information. The central WBS cost database also contains several tables that are used by the engineering design sheets of each model. For example, these tables include information used in selecting pipe diameters, footprint for pumps and chemical properties.

The WBS cost database itself is not provided along with the publicly released WBS models. Instead, for ease of review and to maintain vendor confidentiality, relevant cost and engineering data have been extracted from the database and included directly in the WBS model workbooks. Thus, users can review (and adjust, if needed) the information from the central cost database in the same manner as other WBS model inputs and assumptions.

Exhibit 2-3. Sample of Output Spreadsheet

OUTPUT SUMMARY

Parameter	Value	Units
Technology	MSBA	
Contaminant Type	TCE	
System Size Category	Small	
Design Flow	0.03 MGD (excludes bypass flow)	
Average Flow	0.007 MGD (excludes bypass flow)	
Number of Barin	1	unit
Number of Stages per Barin	3	stage
Barin Length	4	foot
Barin Width	2.5	foot
Barin Height	5	foot
Diffusers per Stage	1	unit
Total Diffusers	3	unit
Off-Gas Treatment	None	
Recycling Costs (in year 2012 dollars)		
Direct Capital Cost	\$ 107,797	Detail
Add-on Cost	\$ 1,038	Detail
Indirect Capital Cost	\$ 50,162	Detail
Total Capital Cost	\$ 158,997	Detail
Annual O&M Cost	\$ 7,292	Detail
Annualized Cost (16.9 years at 7%)	\$ 23,629	Detail
Per 1,000 gallons average flow	\$ 9.25	
Per household per year	\$ 958	

Direct Capital Cost Details (Items in italics, without a "Use?" column, represent alternate costs and are excluded from total)

WBS #	Item	Design Quantity	Design Size	Size used in estimate	Unit Cost	Total Cost	Useful Life	Use?
1. Aerating Basin								
1.1 Custom Designed								
<i>1.1.1 Concrete</i>		0	unit	N/A	N/A	--	N/A	
<i>1.1.2 Excavation</i>		-	cy	N/A	N/A	--	N/A	
<i>1.1.3 Backfill and Compaction</i>		-	cy	N/A	N/A	--	N/A	
<i>1.1.4 Steel Cover</i>		-	sf	N/A	N/A	--	N/A	
1.2 Pre-engineered Package								
<i>1.2.1 Stainless Steel</i>		1	unit	374 gal	\$ 23,455	\$ 23,455	20	0
1.2.1 Plastic		1	unit	374 gal	\$ 2,114	\$ 2,114	7	1
<i>1.2.1 Fiberglass</i>		1	unit	374 gal	\$ 23,258	\$ 23,258	16	0
1.3 Baffles								
1.3.1 Baffle		8	unit	12.5 rft/baffle	\$ 123	\$ 982	7	1
1.4 Aerators								
1.4.1 Diffusers		8	unit	14 cfm	\$ 49	\$ 395	10	1
2. Pumps and Blowers								
2.1 Blower Pump		2	unit	13 gpm	\$ 4,516	\$ 9,032	17	1
ADDITIONAL WBS COMPONENTS NOT SHOWN								
<i>2.1.1 No. of pump</i>		N/A		N/A	N/A	--	N/A	
2.7 Concrete Pad		1	unit	2 cy	\$ 657	\$ 1,314	37	1

Total of direct line items above:

Direct cost category	Total	Guidance
Process carts	\$ 101,538	Exclude alternate cart line items in italics, without a "Use?" column. Include installation, transportation, and O&P
Building carts	\$ 6,259	See indirect assumptions sheet to exclude building
Total direct capital cost	\$107,797	Total of process and building carts

Add-on Cost Details (See indirect assumptions sheet to exclude individual add-on items)

Add-on Line Item	Total	Guidance
Permit	\$ 111	
Pilot Study	\$ -	No pilot study required for this technology
Land Cost	\$ 926	For 0.04 acre
Total add-on costs	\$1,038	Total of permit, piloting, and land

Indirect Capital Cost Details (See indirect assumptions sheet to exclude individual indirect items)

Indirect Line Item	Total	Percent	Guidance
Mobilization and Demobilization	\$ -	0%	Excluded for pre-engineered package
Architectural Fees for Treatment Building	\$ -	9%	Excluded by default for small systems
Installation, Transportation, and O&P	\$ -	0%	
Site Work	\$ 1,423		Calculated based on system requirements.
Yard Piping	\$ 1,107		Calculated based on system requirements.
Geotechnical	\$ -		Calculated based on system requirements.
Standby Power	\$ -		Calculated based on system requirements. Excluded by default for small systems.
Electrical (including wiring)	\$ 10,154	10%	Percentage is applied only to process cart. Building direct carts include electrical components.
Instrumentation and Control	\$ -	0%	
Contingency	\$ -	0%	Included for high cart systems only.
Process Engineering	\$ 21,559	20%	
Miscellaneous Allowance	\$ 10,780	10%	
Legal, Fiscal, and Administrative	\$ 2,156	2%	
Sales Tax	\$ -	0%	
Financing during Construction	\$ -	0%	
Construction Management and GC Overhead	\$ 2,383		Included bond and insurance only for pre-engineered package
Total indirect capital cost	\$50,162		Total of indirect line items

TOTAL CAPITAL COST DETAILS

Assumption	Value	Guidance
City Index	1.0	User adjustable. Can be used to adjust estimated carts to be more reflective of specific geographical location
Capital Cost Category		
Total Direct Capital Cost (from above)	\$ 107,797	
Total Add-on Cost (from above)	\$ 1,038	
Total Indirect Cost (from above)	\$ 50,162	
Grand total capital cost (comparing city to)	\$ 158,997	

Annual Operating and Maintenance Cost Details (Items in italics, without a "Use?" column, represent alternate costs and are excluded from total)

Item	Quantity	Unit Cost	Total Cost (\$/yr)	Use?	Guidance
Labor					
Manager	14 hrs/yr	\$ 40.12 /hr	\$ 566	1	
Administrative	14 hrs/yr	\$ 27.63 /hr	\$ 381	1	
Operator	141 hrs/yr	\$ 28.30 /hr	\$ 3,994	1	Includes labor for regular operation, maintenance, etc.
Materials					
Materials for blower	calculated as percentage of capital		\$ 566	1	

2.2 The WBS Approach

These models represent improvements over past cost estimating methods by increasing comprehensiveness, flexibility and transparency. By adopting a WBS-based approach to identify the components that should be included in a cost analysis, the models produce a more comprehensive assessment of the capital requirements for a treatment system. The models are flexible in that users can change certain design parameters; warning messages indicate when user inputs violate GREPs or logical functions. The transparent structure of each model allows users to see how costs are built up from component unit costs to total treatment costs, which enables users to identify cost drivers and determine whether the input assumptions generate a cost-effective treatment design. Users also can perform sensitivity analyses showing how changes in water quality parameters, chemical feed doses and equipment configuration affect cost.

Unlike prior EPA models, which used a variety of cost build-up methods, the WBS-based engineering models have been developed using a consistent framework. **Exhibit 2-4** shows this framework. For each technology, the result is an engineering spreadsheet model that combines user-identified inputs with pre-programmed engineering criteria and equations to generate appropriate treatment design and equipment requirements. The models also result in a system-level cost estimate for regulatory cost analysis.

Exhibit 2-4. Framework for Developing the WBS-Based Models

Step	Process
Step 1	Identify the treatment requirements based on the contaminant requiring removal, the flow for which treatment is required, the influent water quality and treated water quality requirement, and then select a treatment technology or combination of technologies capable of meeting the requirements.
Step 2	Develop the general design assumptions that apply to all the technologies (e.g., chemical storage capacity).
Step 3	Develop site- and technology-specific design assumptions that might affect treatment performance and, thereby, design requirements (e.g., assumptions related to influent water constituents such as alkalinity or water quality parameters such as pH).
Step 4	Construct a typical process flow diagram or P&ID showing the main unit processes for the technology and identify equipment requirements.
Step 5	Calculate the equipment requirements, including dimensions and quantities, for the core elements of each unit process. At each component (or group) level, identify choices of material (e.g., stainless steel or PVC pipe material).
Step 6	Link the treatment equipment requirements to a database that contains unit costs by equipment type, size and material. Multiplying the unit costs by the dimension and quantity requirements developed in Step 5 provides the component-level design costs.
Step 7	Tally the costs of the selected components to determine direct capital cost.
Step 8	Develop and add indirect and add-on costs to determine total system capital cost.
Step 9	Develop operation and maintenance cost estimates.

The WBS approach provides EPA with a consistent method for identifying components to include in a cost estimate. For each technology, the WBS approach develops a process and instrumentation diagram (P&ID) or a typical schematic layout showing the main unit processes needed to achieve the contaminant removal goals.

Exhibit 2-5 provides examples of several classes of components that can be included in a P&ID. The models often include further breakdown for alternative materials of construction for each component, because costs can differ substantially across materials. For example, most pipes can

be constructed of stainless steel, steel, polyvinyl chloride (PVC) or chlorinated PVC. Stainless steel piping can cost twice as much as PVC.

Exhibit 2-5. Component Classes Included in the WBS Inventory

Component Classes	Example Components
Vessels	Pressure vessels
Tanks/basins	Storage Backwash Mixing Contact Flocculation Sedimentation Filtration
Pipes	Process Backwash Chemical Inlet/outlet Bypass
Valves (see Appendix A for further details)	Check (one-way) Motor- or air-operated Manual
Pumps	Booster Backwash High-pressure (for membrane systems) Chemical metering
Mixers	Rapid Flocculation Inline static
Instrumentation (see Appendix A for further details)	Pressure gauge Level switch/alarm Chlorine residual analyzer Flow meter pH meter Air monitor/alarm High/low pressure alarm Gas flow meters—rotameters Scales
System controls (see Appendix A for further details)	Programmable logic control units Operator interface equipment Controls software
Chemicals	Acids Bases Coagulants and coagulant aids Antiscalants Corrosion control Oxidants and disinfectants
Treatment media	Activated alumina Activated carbon Membranes Sand Resins

Component Classes	Example Components
Building (see Appendix B for further details)	Structure Heating and air conditioning systems Concrete pad
Indirect Capital Components (see Appendix D for further details)	Geotechnical investigations Standby power generators

The level of component detail (and by implication, design detail) in **Exhibit 2-5** indicates that the WBS-based approach is more sophisticated, and potentially more time consuming, than the factored or parametric cost estimating methods used in earlier efforts. Nevertheless, the Technology Design Panel considered it the right approach to developing unit costs for policy analysis. Furthermore, EPA believes that developing unit cost models that are more comprehensive, flexible and transparent will facilitate the policy analysis process by addressing a frequent topic of dispute over regulatory cost estimates. Finally, the WBS-based models are driven by technical scope and selection of suitable equipment and material to achieve a defined treatment objective. This approach is superior to cost estimating methods that are not defined by a desired treatment level or that cannot be changed easily to reflect raw water quality.

2.3 Model Use

This section provides basic guidance on operating the WBS technology models. As discussed above, each model is an Excel workbook comprising a series of spreadsheets. In general, users need only be concerned with the input sheet and output sheet, although advanced users might also wish to examine the critical design assumptions spreadsheets.

2.3.1 Input Sheet Structure and Use

The input sheet in each of the technology models is similar to that pictured in **Exhibit 2-2**. A step-by-step input process allows the user to quickly generate costs for standard designs built into the model, modify those designs or construct an alternative design.

Overview of the Input Process

Many models require basic information from the user before choosing an appropriate standard design. For example, contaminant selection is the first choice that must be made in several of the models. Such choices are made using a drop-down list at the top of the input sheet.

After making any basic, top-level choices, the user can click on one of the eight standard design buttons. Each button corresponds to a system size category in the flow characterization paradigm described below in **Exhibit 2-6**. The model will populate all inputs with values

JLTI-STAGE BUBBLE AERATION SYSTEM DESIGN AND COST INPUT

STEP 1
Select Contaminant

Radon

STEP 2:
Select one of the eight standard designs at right OR select "CLEAR FOR MANUAL ENTRY"

0.030 MGD (21 gpm)
0.124 MGD (86 gpm)
0.305 MGD (212 gpm)
0.740 MGD (514 gpm)
2.152 MGD (1,494 gpm)
7.365 MGD (5,115 gpm)
22.614 MGD (15,704 gpm)
75.072 MGD (52,133 gpm)
CLEAR FOR MANUAL ENTRY

STEP 3:
(Optional for standard designs)
Enter or change values in the gold and blue cells below

Input Complete -

appropriate for the selected design, then compute all costs. The direct capital cost, total capital cost and annual O&M cost are displayed on the input sheet; details are available on the output sheet (see Section 2.3.4). More information on the standard designs is provided below.

Exhibit 2-6. Standard Flow Rate Categories Used in WBS Standard Designs

Size Category	Population Served	Design Flow (MGD)	Average Flow (MGD)
1	25 to 100	0.030	0.007
2	101 to 500	0.124	0.035
3	501 to 1,000	0.305	0.094
4	1,001 to 3,300	0.740	0.251
5	3,301 to 10,000	2.152	0.819
6	10,001 to 50,000	7.365	3.200
7	50,001 to 100,000	22.614	11.087
8	Greater than 100,000	75.072	37.536

The standard designs, with their corresponding buttons, are primarily for EPA’s use in estimating costs for a median sized system in each size category, although some users may find them useful as a starting point (see the examples in Section 2.3.3). The user can modify the standard designs after clicking one of the buttons by entering values in the gold and blue input cells, under the “Manual Inputs” heading on the input sheet. Alternately, many users will want to click the button marked “CLEAR FOR MANUAL ENTRY” and enter all of the input values by hand. In any case, the manual inputs section contains several types of cells:

- Required user inputs, highlighted in gold
- Optional user inputs, highlighted in blue
- Greyed-out inputs, which are not required for a given design
- Information and guidance, with text in green.

Some inputs, such as system flows, must contain a numeric value. Others have a drop-down arrow that appears when the cursor is positioned in the input cell. These cells must contain one of the drop-down values. Required inputs must be populated; optional inputs can be left blank to accept model defaults or changed by the user to examine the effect of different assumptions. The Autosize button, described below, is available in some models to facilitate design.

The input sheet in each model verifies user inputs against certain design constraints that reflect GREPs. If user inputs result in designs that violate these constraints, a warning message appears on the input sheet, explaining which input value needs to be corrected. In addition, the message “Input Incomplete—Check for Error Messages Below” appears at the top of the input sheet.

Once all inputs are complete and the model has verified that they meet design constraints, the message at the top of the input sheet changes to “Input Complete—Press ‘Generate Results’.” The user must click the “Generate Results” button to tell the model to generate costs. Once the user has clicked

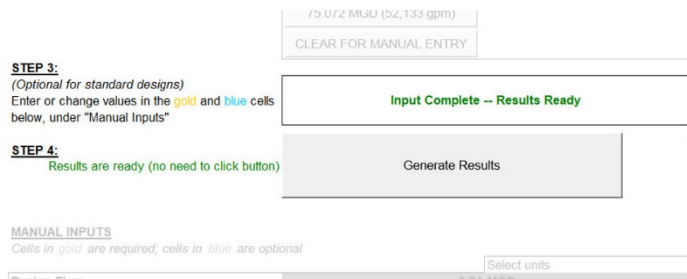

the button, the message at the top of the model changes to “Input Complete—Results Ready,” and total costs are displayed on the input sheet. The output sheet provides more details for the total costs.

Standard Designs

The input sheet in each of the technology models contains up to eight buttons, which correspond to the eight standard flow sizes in the flow characterization paradigm for public water systems (see **Exhibit 2-6**). These buttons populate all of the input fields with appropriate values for the selected design flow. The values in each standard design meet all relevant design constraints. Each model includes a separate sheet, entitled “standard inputs,” that documents the specific input values included in each standard design.

Advanced users can adjust the standard designs by changing the values on the standard input sheet. For example, a user could change all the standard designs to use high cost components, rather than the default of low cost components (see Section 2.3.2 under “Component Level”), by changing values in the appropriate column on the standard input sheet. The standard input sheet highlights values that have been changed by the user and includes a button (“Reset to Defaults”) that resets the standard designs back to their original settings. Users that make significant adjustments to the standard designs should take care to verify that their new designs still meet design constraints by checking for warning messages on the input sheet after each new design is run.

JLTI-STAGE BUBBLE AERATION SYSTEM DESIGN AND COST INPUT

STEP 1
Select Contaminant: Radon

STEP 2:
Select one of the eight standard designs at right OR select "CLEAR FOR MANUAL ENTRY"

0.030 MGD (21 gpm)
0.124 MGD (86 gpm)
0.305 MGD (212 gpm)
0.740 MGD (514 gpm)
2.152 MGD (1,494 gpm)
7.365 MGD (5,115 gpm)
22.614 MGD (15,704 gpm)
75.072 MGD (52,133 gpm)
CLEAR FOR MANUAL ENTRY

STEP 3:
(Optional for standard designs)
Enter or change values in the gold and blue cells below.

Input Complete

The Autosize Routine

The models also can be used to estimate costs for systems with design flows other than the eight standard sizes. To aid in developing designs for other flows, some models include a button labeled “Autosize.” This button activates a computer-aided design routine that attempts to find a design meeting all

relevant design constraints for a given design and average flow. For example, the user could change design flow to 3 million gallons per day (MGD) and average flow to 1 MGD, then click the autosize button. This would populate some input fields with values that are both appropriate for a 3 MGD system and that meet all design constraints. More information on the autosize routines, including details on which inputs are and are not populated, is available in the technology-specific chapters of this document.

Pressure Vessels
The next four inputs may be entered manually, or calculated with Au

Auto Size Pressure Vessels	Bed depth
	Vessel geometry
	Length (straight)
	Diameter

For information:
Number of treatment trains

In the rare case that the autosize routine cannot find a design meeting all constraints, it will display a pop-up warning message. This does not mean that it is impossible to design a system for the selected size. The user might still be able to develop a design by manually adjusting the input values, paying careful attention to the warning messages on the input sheet. It might be necessary to relax some of the design constraints by adjusting values on the critical design assumptions sheet.

Manual Input and “Generate Results”

All of the models allow the user to enter input values by typing them directly into the appropriate fields on the input sheet. Users can develop complete designs from scratch, populating all the input fields manually. Users also can adjust designs generated by the standard design or autosize buttons, by adjusting one or more input fields manually after clicking one of these buttons. In either case, after completing the manual changes, users should do two things:

- Verify that no warning messages appear to ensure that the design meets all relevant constraints
- Click the button labeled “Generate Results.”

The second step is necessary to tell the models that the design process is complete and to select the appropriate items of equipment for inclusion in total costs on the output sheet. This step is particularly important if the system automation or component level inputs are adjusted manually, because these

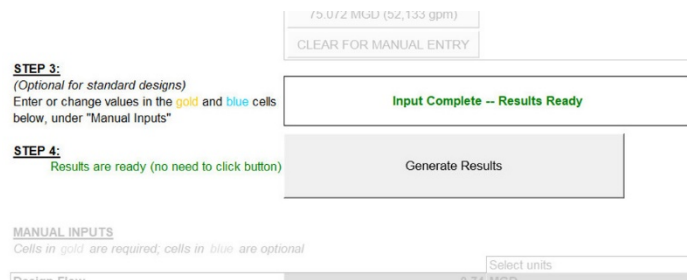

inputs have a significant impact on the selection of equipment. To ensure correct calculation of costs, however, users should click the “Generate Results” button after completing manual changes to *any* of the inputs. It is not necessary to click this button when the input sheet message reads “Input Complete—Results Ready.” This message will appear, for example, when the standard designs or autosize routine are used without subsequent manual changes to input values. The standard design buttons and the autosize button automatically incorporate the “Generate Results” step, telling the models to select the appropriate items of equipment.

2.3.2 Common Inputs

The user inputs in each model are largely technology-specific and are described in detail in the technology chapters of this document. There are certain inputs, however, that are common to all of the technology models. These common inputs are described below.

Design and Average Flow

MANUAL INPUTS

Cells in gold are required; cells in blue are optional

	Select units
Design Flow	0.74 MGD
Average Flow	0.251 MGD
System size inputs OK	

Each model needs the design and average flow to determine the size and number of treatment components needed. Design flow is the peak instantaneous flow of product water from a treatment system, while average flow is the annual average flow, taking into account daily and seasonal variations in demand.

Design flow can be entered in MGD or in gallons per minute (gpm). In either case, the design flow is meant to represent a maximum instantaneous flow. Average flow can be entered in MGD, in gpm or as a percentage of design flow.

The standard design functions included in each model (see above) can populate design and average flow with values based on the flow characterization paradigm for public water systems. The flow paradigm includes eight model size categories, as shown in **Exhibit 2-6**. These size categories represent populations ranging from 25 persons to greater than 100,000 persons. Based on the values in **Exhibit 2-6**, the ratio of average flow to design flow ranges from 25 percent for very small systems to 50 percent for large systems.

Component Level

Component level		pick or leave blank
System automation	low cost	pick or leave blank
Include buildings?	mid cost	pick or leave blank
Include HVAC?	high cost	pick or leave blank
Include land?		<- pick or leave blank

Each model includes an optional input that determines whether the cost estimate generated is a low, medium or high cost estimate. This input, labeled “component level” or “cost level,” drives the selection of materials for items of equipment that can be constructed of different materials. For example, a low cost system might include fiberglass pressure vessels and PVC piping. A high cost system might include stainless steel pressure vessels and stainless steel piping. The component level input also drives other model assumptions that can affect the total cost of the system, including assumptions about system automation (see “System Automation” below), building quality and heating and cooling (see Appendix B).³ If the component level input is left blank, the models will generate a low cost estimate. The user can change this input to select a medium or high cost estimate.

³ In some cases (e.g., the membrane models, which are under development), this input also determines the source water quality that the model treats. In these models the input is called the “cost level.”

System Automation

Component level		<-- pick or leave blank
System automation		<-- pick or leave blank
Include buildings?	manual	pick or leave blank
Include HVAC?	semi-automated	pick or leave blank
Include land?	fully automated	pick or leave blank
For information: Component level		low cost

As described in Appendix A, control of drinking water treatment systems can be manual, automated or semi-automated. The method of control can have a significant impact on both capital and O&M costs. Each model includes an optional input that allows the user to select from among the three control options. If the system automation input is left blank, the control option selected is determined by the system size and the component level input selected (see above), using the logic shown in **Exhibit 2-7**. The user can change the system control input to force the design of a system with manual, automated or semi-automated control.

Exhibit 2-7. Default Assumptions for System Control

Component Cost Level Selected	System Size (Design Flow) Less than 1 MGD	System Size (Design Flow) 1 MGD or greater
Low	Manual	Manual
Medium	Manual*	Automated
High	Automated	Automated

* Automated for some models.

Include Buildings?

Component level		<-- pick or leave blank
System automation		<-- pick or leave blank
Include buildings?		<-- pick or leave blank
Include HVAC?		<-- pick or leave blank
Include land?		<-- pick or leave blank
For information: Component level		
Automation	yes	
	no	

Optional inputs OK

By default, the WBS models include the capital cost of buildings to house the treatment system, as discussed in Section 2.4.1 and Appendix B. Each model includes an optional input that allows the user to exclude the capital cost of buildings. If the user excludes the capital cost of buildings, the model also excludes the O&M cost of building maintenance and lighting.

Include Heating, Ventilating and Air Conditioning (HVAC)?

By default, the WBS models choose whether to include the cost of heating and cooling systems depending on system size, building structure type and user input for component level, as discussed in Section 2.4.1 and Appendix B. Each model includes an optional input that allows the user to override the model’s default selection and choose to include or exclude the cost (both capital and O&M) of HVAC systems.

Include Land?

Regardless of whether a system needs to purchase additional land on which to build the new treatment train, there is an opportunity cost associated with using land for water treatment rather

than an alternative use. By default, the WBS models include an add-on cost for land, as discussed in Section 2.4.4. Each model includes an optional input that allows the user to exclude the add-on cost for land.

2.3.3 Input Sheet Examples

Several examples are presented here to clarify the use of the WBS model input sheet. The examples refer to particular technology models. Detailed information about the inputs for these models can be found in the appropriate technology-specific chapters.

Standard Design

The simplest way to generate a design is by use of the standard design buttons. Suppose that a user wishes to estimate costs for a system designed to treat trichloroethylene (TCE) using granular activated carbon (GAC), serving a population of approximately 8,000 people. The following are step-by-step instructions for using the adsorptive media model to generate such a cost estimate:

1. Open the Excel workbook named “WBS GAC.xlsm.”⁴ Depending on your settings and version of Excel, a message might appear regarding “active content” in the workbook. For the models to function properly, macros must be enabled. Take the appropriate steps to enable macros (for example, clicking “Options” and selecting “Enable this content,” depending on your version of Excel).
2. Navigate to the input sheet by clicking on the tab labeled “INPUT” at the bottom of the Excel window. (It is also possible to page through the sheets by pressing Ctrl-Page Up and Ctrl-Page Down.) Scroll to the top of the input sheet.
3. The GAC model requires that the user first choose the contaminant. Select “TCE” from the “Select Contaminant” dropdown list.
4. The GAC model also requires that the user choose between pressure and gravity designs (see the appropriate technology chapter for discussion of the difference between design types). Select “Pressure” from the “Select Design Type” dropdown list.
5. The user wishes to use a standard design appropriate for a population of 8,000 people. **Exhibit 2-6** indicates that size category 5, with a design flow of 2.152 MGD, is appropriate for such a system. Therefore, click on the design button labeled “2.152 MGD standard design.” After a few seconds, the model will display the message “Using this design” next to the design button and “Input Complete—Results Ready” underneath the buttons. It displays the direct capital cost, total capital cost and annual O&M cost on the input sheet.
6. If desired, scroll down on the input sheet to see what inputs are used for the standard design. For instance, the 2.152 MGD standard design for GAC treating TCE with a pressure design uses a design flow of 2.152 MGD and an average flow of 0.819 MGD. It

⁴ Note that your model file name might vary. It likely will include a date following the model title (e.g., “WBS GAC 042514.xlsm” for April 25, 2014).

assumes a carbon life of 66,600 bed volumes and a total theoretical empty bed contact time (EBCT) of 7.5 minutes.

Modified Standard Design

Suppose that the user wishes to design a GAC system treating TCE for a population of 1,000, using source water that entails a different carbon life and EBCT than that assumed in the standard designs (e.g., because the source water contains a higher initial concentration of TCE). The user determines that the source water characteristics entail a carbon life of 40,000 bed volumes and an EBCT of 10 minutes. The following are step-by-step instructions for using the GAC model to generate such a cost estimate:

1. Open the Excel workbook named “WBS GAC.xlsm”⁵ and take the appropriate steps to enable macros (see Step 1 described in the “Standard Design” section above). Navigate to the input sheet, scroll to the top of that sheet and select “TCE” and “Pressure” from the appropriate dropdowns (see Steps 2, 3 and 4 described in the “Standard Design” section above).
2. The user wishes to design a system for a population of 1,000 people. **Exhibit 2-6** indicates that size category 3, with design flow 0.305 MGD, is appropriate for this population, so start by clicking the “0.305 MGD standard design” button.
3. The user wishes to design a system with a carbon life of 40,000 bed volumes. Scrolling down the input sheet, note that the standard design uses an input carbon life of 66,600 bed volumes. Type the number 40,000 in the gold input cell to change the carbon. Note that the green informational text below the input cell changes to show the number of months between regenerations. Note also that the message above the manual inputs changes to “Input Complete—Press ‘Generate Results’” to indicate that costs have not been updated for your new input.
4. The user wishes to design a system with an EBCT of 10 minutes. Scroll down to the cell labeled “Theoretical Empty Bed Contact Time” and enter the number 10.
5. Changing the EBCT will change the optimal vessel geometry. To quickly estimate costs for this new EBCT, click the “Autosize” button next to the inputs for vessel geometry. The input values will flicker briefly while the model tries several different values and then settles on a new value. Because the Autosize button was clicked, it is not necessary to click the “Generate Results” button; the message above the manual inputs reads “Input Complete—Results Ready,” and the total costs are displayed on the input sheet.

Suppose that the user also wishes to estimate a high-end cost for this system. In this case, take the following additional steps:

⁵ Again, your model file name might vary. It likely will include a date following the model title (e.g., “WBS GAC 042514.xlsm” for April 25, 2014).

6. Scroll down and place the cursor in the input cell labeled “Component Level.” A dropdown arrow appears to the right of the cell. Click on the arrow and choose “high cost.”
7. Scroll back to the top of the sheet. Note that the sheet indicates that the user must click “Generate Results.” Click that button. The model displays costs for the high-end system. To see what components are included, switch to the Output sheet and examine the details.

2.3.4 Output Sheet Structure and Use

The output sheet in each of the technology models is similar to that pictured in **Exhibit 2-3**. In addition to the details described in Section 2.1, the output sheet includes several important totals:

- Process cost, which is the sum of the installed capital cost of all equipment required for the treatment process
- Building cost, which is the sum of the installed capital cost of all buildings and the concrete pad
- Direct capital cost, which is the sum of the process and building costs
- Total capital cost, which is the total of the direct capital cost, the indirect capital costs and add-on costs (see Sections 2.4.3 and 2.4.4)
- Annual O&M cost (see Section 2.4.5)
- Total annualized cost (see Section 2.4.6).

The capital equipment section of the output sheet includes a column labeled “Use?” This column tells the model which line items to include in the direct capital cost. Specifically, items with a value of 1 in the “Use?” column are included in the total; items with a value of 0 or a blank are not included in the total. Advanced users can manually adjust this column to include or exclude certain items of equipment. For example, a user could examine process costs without booster pumps by changing the “Use?” value to 0 for those pumps. The “Generate Results” button, which is present on both the input and output sheets, will reset the “Use?” values back to pre-programmed default values, as driven by system size and input values.

The output sheet also includes a button labeled “Record Output in a New Workbook.” This button generates a complete copy of the output sheet that will not change. Using this button allows users to record the detailed design output for comparison purposes. For example, a user could record the output from the standard design for 0.03 MGD, then select the 0.124 MGD standard design and compare the output results for the two designs.

2.3.5 Critical Design Assumptions Sheet Structure and Use

Each of the technology models includes at least three critical design assumptions sheets:

- One for process and building design assumptions
- One for assumptions used in calculating annual O&M costs
- One for assumptions used in calculating certain indirect capital costs

Some models include additional critical design assumptions sheets (e.g., in the aeration models, for assumptions associated with off-gas treatment).

These sheets contain design constraints and structural and chemical engineering assumptions based on GREPs. Users can review these sheets for details on significant assumptions used in the models. Advanced users might want to modify certain assumptions, particularly if adapting a model for use with a source water quality different than assumed in the standard designs or to reflect site-specific conditions. Most of the assumptions include a comment column explaining the use of the assumption and/or providing guidance on appropriate values.

Most of the significant design assumptions are technology-specific and discussed in detail in the technology chapters of this report. However, there are certain assumptions that are common to many of the models. **Exhibit 2-8** summarizes the general design assumptions that are common across most of the models. As **Exhibit 2-8** indicates, these assumptions are based on a combination of sources, including standard design handbooks, engineering textbooks and comments of external reviewers. Note that some of the general design assumptions (and some technology-specific assumptions, as discussed in the relevant technology chapters) differ for small versus large systems. In general, these differences are because small systems can often be built as packaged, pre-engineered or skid-mounted systems. In most cases, the different design and cost assumptions for small systems are based on comparison of model outputs with as-built designs and costs for actual small treatment systems.

The user can change some of the assumptions shown in **Exhibit 2-8** by editing the critical design assumptions sheet; others can be edited in the data extracted from WBS cost database. The final column of **Exhibit 2-8** provides guidance on how to change each assumption. For example, the design of pumps for any treatment system is based on the peak flow requirements of the system, including a safety factor. As specified in **Exhibit 2-8**, the critical design assumptions sheet assumes a safety factor of 25 percent. A user could change this factor based on an actual pump performance curve.

Exhibit 2-8. General Design Assumptions Used in the WBS-based Models

Element	Assumption	Can be changed by:
Influent pumps	Include flooded suction	Replacing unit costs or cost coefficients extracted from the WBS cost database
All pumps	Design flow incorporates a safety factor of 25 percent	Editing the critical design assumptions sheet of each technology
Access space for pumps	Provide a minimum of 4 feet of service space around three sides of each unit, assuming the fourth side can share access space with relevant tanks or vessels	Editing the critical design assumptions sheet of each technology
Pipe size	Based on a maximum of 3 feet of head loss per 100 feet of pipe	Editing the engineering lookup table extracted from the WBS cost database
Process pipe size	Based on maximum flow to each unit (not total system flow)	Cannot be changed
Tank and pressure vessel capacity	Based on design capacity, freeboard and standard manufactured sizes	Cannot be changed
Pressure vessel diameter	Based on user input, within limits specified on a technology-specific basis	Changing user inputs (for diameter) and editing the critical design assumptions sheet of each technology (for constraints)
Storage tank diameter	Assumes a cylindrical design, with diameter equal to one half of the height	Cannot be changed

Element	Assumption	Can be changed by:
Access space for tanks and pressure vessels	Provide service space around each unit equal to its diameter (half its diameter for small systems), to a maximum of 6 feet	Editing the critical design assumptions sheet of each technology (only maximum can be changed)
Process vessels and basins, all pumps and chemical feed systems	Multiple units required to protect from single point failure	Editing the critical design assumptions or input sheet of each technology (depending on the specific item)
Chemical storage	Storage requirement based on 30-day delivery frequency	Editing the critical design assumptions sheet of each technology
Concrete pad under heavy equipment	1 foot thick for large systems, 6 inches thick for small systems	Editing the critical design assumptions sheet of each technology
Office space	100 square feet per employee for large systems (excluded for small systems)	Editing the critical design assumptions sheet of each technology

Sources: U.S. EPA (1997); AWWA (1990); AWWA/ASCE (1998); Viessman and Hammer (1993); GREPs; and information from manufacturers and technology experts who reviewed model critical design assumptions.

Cost Estimation Method

Equipment unit costs can be derived in one of two ways. The first (and recommended) method uses component-specific cost equations developed from unit costs collected from equipment vendors. The component cost equations are best-fit equations (developed using statistical regression analysis across the sizes available for each item) that estimate the unit cost of an item of equipment as a function of its size. Under the cost equation option, the models will generate unit costs for each item of equipment by applying the appropriate cost equation to the exact size determined by the design calculations.

The second method uses unit cost lookup tables extracted from the WBS cost database. These lookup tables are based on quotes from equipment manufacturers for discrete equipment sizes. To maintain vendor confidentiality, the tables do not identify the individual vendors associated with the quotes and the unit costs typically are averages across multiple vendors. Under the lookup table option, for each item of equipment, the models will search the appropriate lookup table to locate a unit cost that best meets the design requirements for the component. In general, this means that the models will select the discrete equipment size for each item of equipment that is equal to or greater than the size determined by design calculations.

Each model includes a critical design assumption, labeled “cost estimating method,” that determines the method used to derive equipment costs. By default, the assumption is set to 1, to use the component-specific cost equations. The user can set the assumption to a blank value to select the lookup table method. EPA believes the cost equations method is most appropriate for generating national cost estimates and for most user-specified designs. Using the equations, instead of the price quotes, allows the models to generate unit costs for equipment of the exact size determined by the design calculations. For example, a WBS model design might require a 250 gallon steel tank, but the available price quotes might be limited to 100 gallon, 500 gallon and various larger sizes. The cost equation for steel tanks will allow the WBS model to generate a unit cost for the intermediate sized 250 gallon tank. The lookup table method would use the cost for the 500 gallon tank. The models retain the lookup table method for users who wish to examine the specific cost data points on which the component-specific cost equations are based.

2.3.6 Index Sheet Structure and Use

Each technology model includes an index of all inputs and critical design assumptions, including hyperlinks to their locations. **Exhibit 2-9** shows an example of the index sheet. The sheet provides an alphabetized list of all inputs and assumptions. Due to the great number of inputs and assumptions in the WBS models, the Find feature in Excel can be useful in locating a specific input or assumption.

Next to the description of each input or assumption is a blue, underlined hyperlink. It shows the internal name of the input or assumption used in the engineering formulas throughout the WBS model. Clicking on the hyperlink takes the user to the cell where the assumption can be viewed or adjusted.

Exhibit 2-9. Sample of Index Spreadsheet

INDEX	
This page provides an index to all user-adjustable inputs and assumptions. Click on a variable name to go directly to the adjustable cells.	
User-adjustable Input or Assumption	Variable Name and Link
Access space per pump/blower for custom designed systems	space_pumps_cust
Access space per pump/blower for pre-engineered packages	space_pumps_pre
Additional blower head above water depth	add_blow_head
Additional building after...	add_2nd_building
Administrative LOE as a percent of average technical labor	Clerical_percent
Air conditioning EER	EER
Air to water ratio	air_water_ratio
Always include NEPA compliance costs?	include_NEPA
Annual cooling degree days	cool_DD
Annual heating degree days	heat_DD
Average Flow	average_flow_l
Basin excavation depth above which deeper boreholes are needed	deep_bore_need
Bedding depth below pipe	bedding_depth
Bedding depth surrounding the pipe	bedding_pct
Blower efficiency	blower_effcy
Blower safety factor	blower_safety_factor
Borehole depth (package systems)	bore_depth_p
Borehole depth for deep basins	bore_depth_max
Borehole depth for shallow basins	bore_depth_min
Borehole needed every x square feet	hole_per_sf
Boreholes per job	hole_per_job
Buffer space around other sides of buildings	non_fire_buffer
Builder's risk insurance percentage	br_ins_pct
Building height	Building_height
Coefficient of passive pressure	Coeff_Kp
Communications hardware	comm_hardware
Component level	component_level_l
Computer workstations per x operators	workstation_ratio
Concrete pad thickness	pad_thick
Concrete pad thickness for small systems	pad_thick_small
Concrete thickness	conc_thick
Contaminant-Specific Off-gas Assumptions	contaminant_lookup
Cooling table for buildings 500 square feet or greater	cooling_table
Cooling table for buildings less than 500 ft2	cooling_table_shed
Cooling ventilation/infiltration load	cool_vload
Cost for parts & maintenance for pumps and blowers	pump_maint_rate
Density of air	PA
Design Flow	design_flow_l
Design safety factor for standby power	std_safety_factor
Design Type	design_type_l
Diffuser access space	diffuser_access_space
Drive controllers per blower	S_blower
Drive controllers per booster pump	S_booster_pump
Drive controllers per catalytic oxidizer	S_CO
Drive controllers per thermal oxidizer	S_TO
Efficiency of pumps	pump_effcy
Electric resistance heating efficiency	resist_eff
Electrical percentage	elect_pct
Engineering percentage for large systems	eng_pct_large
Engineering percentage for medium systems	eng_pct_medium
Engineering percentage for small systems	eng_pct_small
Ethernet modules	plc_ethernet
Excess air required	CO_ex_air
Excess air required	TO_ex_air
External air piping	air_pipe_add
Financing percentage	finance_pct

2.4 General Cost Assumptions

An important feature of the WBS models is that they build up cost estimates from component-level data. Each model shows the user the cost build-up, which makes the cost estimates more transparent, giving the user an opportunity to evaluate the impact of design and unit cost assumptions on treatment costs. There are several types of costs that need to be aggregated into a total cost estimate: equipment costs, building cost, residuals discharge cost, indirect capital costs, add-on costs and annual O&M costs. The sections below describe how each type of cost enters the WBS models.

The build-up process for equipment costs is straightforward. The design sheets in the model generate the required dimensions and quantities for each item in the WBS list of equipment components and materials. Then, the model obtains unit costs to match the component size and material (e.g., a 10-inch diameter PVC pipe or a 4,000-gallon steel backwash tank). The model multiplies unit costs by the quantity estimate (e.g., 30 feet of pipe or 2 tanks) to obtain total component costs. Direct capital cost equals the sum of these costs across the selected components, including costs for treatment equipment and buildings.

The models enable equipment unit costs to be derived in one of two ways (using lookup tables or cost equations, as described in Section 2.3.5 under “Cost Estimation Method”). Regardless of the method used, the estimates are intended to provide enough information to establish a budgetary or preliminary cost estimate. Therefore, although the model results are point estimates shown to the nearest \$1, this precision is not meant to imply that the results are accurate to \$1. Instead, EPA’s goal is for the resulting costs to be within +30 percent to -15 percent of actual cost. To validate the engineering design methods used by the models and assess the accuracy of the resulting cost estimates with this goal, EPA has subjected the individual models to a process of external peer review by nationally recognized technology experts. The technology-specific chapters of this document include a discussion of peer reviewer opinions on the accuracy of each model’s results. Users are encouraged to review all documentation, modify inputs and assumptions as appropriate to their specific purpose, and form their own informed opinions about the accuracy and suitability of the results.

Consistent with providing a budgetary or preliminary cost estimate, WBS models contain several cost-related assumptions that allow the models to produce costs for some components without having detailed site-specific information (e.g., pipe fitting sizes). **Exhibit 2-10** summarizes these assumptions.

Exhibit 2-10. General Equipment Cost Assumptions

1. Costs are preliminary estimates based on major components as shown on piping and instrumentation diagrams or typical layout drawings. Costs include consideration of package plants where relevant (see model-specific chapters for more details).
2. All equipment costs include costs of transportation and installation.
3. All equipment costs are based on cost quotes from manufacturers or RSMeans database.
4. Long-term storage of chemicals (greater than 30 days) is not taken into account unless specifically mentioned.
5. Cost of waste disposal (residuals) is accounted for using the methods outlined in Section 2.4.2 and Appendix C.
6. Building layout is for the process itself, with room for operation, maintenance and replacing equipment, if needed.
7. Building costs are estimated using unit costs per square foot (see Section 2.4.1 and Appendix B for more details).
8. Costs for a reinforced-concrete pad floor to handle equipment loads are added to building costs. Costs associated with special unit or site-specific foundation requirements are not included and should be evaluated on a case-by-case basis.
9. To account for the cost of fittings, pipe lengths are determined by applying a multiplier to the overall system building layout length. The resulting lengths are considered conservative (i.e., erring on the high side), so that the resulting cost covers the installed cost of the pipe and fittings. The specific multipliers are as follows:
 - Combined influent and treated water pipe length is 2 times the length of the overall system building layout length.
 - Process pipe length is 2 times the length of the overall system building layout length.
 - Backwash pipe length is 2.5 times the overall system layout length.
 - Bypass pipe length is 2.5 times the overall system layout length.
 - Chemical pipe length is 1 times the overall system layout length.
 - Residuals pipe length is 1 times the overall system layout length.

2.4.1 Building Costs

The WBS model building costs use three sources: RSMeans *2020 Square Foot Costs* (RSMeans, 2020), Saylor *2020 Commercial Square Foot Building Costs* (Saylor, 2020) and the Craftsman 2020 National Building Cost Estimator software model (described in Craftsman, 2020).

Appendix B provides a detailed description of these sources and the approach to developing building costs.

In each WBS technology model, there are four possible design configurations for buildings: three construction design and quality categories (low, medium and high) and small, very low cost, prefabricated (“shed-type”). The WBS models select from among these configurations based on system size, structure size and user input for component level (see Section 2.3.2), as shown in Appendix B. Unit costs (in dollars per square foot) for each configuration vary by structure size. When appropriate, the WBS models add costs for building heating and cooling systems as line items separate from the base building costs. Whether the WBS models include these systems also depends on system size, structure type and user input for component level, as shown in Appendix B.

As discussed in Section 2.3.2, the input sheet of each model includes optional inputs that allow the user to choose whether or not to include the costs of buildings and HVAC systems.

2.4.2 Residuals Management Costs

Many of the treatment technologies covered by the WBS-based models generate liquid, semi-solid (sludge) and/or solid residuals. For these technologies, each model includes a sheet that

estimates the cost of various options for managing these residuals. The residuals management options available for a given technology vary depending on the types of residuals generated, their quantity, the frequency of generation (e.g., intermittent versus continuous) and their characteristics. Examples of residuals management options include (but are not limited to): direct discharge to surface water, discharge to a publicly owned treatment works, land disposal of solids and storage and/or treatment of sludge or liquid waste prior to disposal or discharge. The individual technology chapters of this document describe the specific residuals management options available for each technology. Appendix C provides detailed information about the data and assumptions used to estimate costs for the various residuals handling and disposal options.

2.4.3 Indirect Capital Costs

Indirect capital costs are costs that are not directly related to the treatment technology used or the amount or quality of the treated water produced, but are associated with the construction and installation of a treatment process and appurtenant water intake structures. Indirect costs can be considerable and must be added to cost estimates if they are not included as a line item component or a factor in the major (cost driver) elements of a technology. They include indirect material costs (such as yard piping and wiring), indirect labor costs (such as process engineering) and indirect burden expenses (such as administrative costs).

The WBS models compute the costs of site work, geotechnical investigation, yard piping and standby power based on the system requirements, as determined during the direct capital cost buildup. Other indirect costs are computed as a percentage of the installed process cost, building cost or direct capital cost estimate. The indirect assumptions sheet in each WBS model (see Section 2.3.5) contains guidance regarding a typical range of percentages for each item and indicates the base cost to which the percentage will be applied. The guidance also describes conditions that might require an assumption outside the range of typical values. Finally, guidance on the output sheet notes that items such as installation costs and contractor overhead and profits are already included in the direct capital cost estimate, but entries can be made to increase these cost items should circumstances merit higher costs. Any of these costs can also be excluded by modifying assumptions on the indirect assumptions sheet. Costs that are computed as a percentage can be excluded simply by setting the percentage to zero. Those that are computed based on system requirements can be included or excluded by setting the appropriate flag to one or zero on the indirect assumptions sheet.

The WBS models report the total capital cost directly below this section of the output sheet so the user can determine the impact of altering the indirect cost assumptions on total capital costs.

Appendix D provides descriptions of the default assumptions for the following indirect costs:

- Mobilization and demobilization
- Architectural fees for treatment building
- Equipment transportation, installation and contractor overhead and profit
- Construction management and general contractor overhead
- Process engineering
- Site work
- Yard piping

- Geotechnical
- Standby power
- Yard wiring
- Instrumentation and control
- Contingency
- Financing during construction
- Legal, fiscal and administrative
- Sales tax
- City index
- Miscellaneous allowance.

2.4.4 Add-on Costs

Add-on costs are costs that may be attributed to one or more aspects of the treatment technology. These add-on costs include permit costs (e.g., for construction and discharge permits), pilot and bench testing costs and land use costs. Users can include or exclude these costs by setting appropriate flags on the indirect assumptions sheet (see Section 2.3.5).

Permits

Systems installing new treatment technologies to comply with revised drinking water standards will often need to build a new structure to house the new treatment train and might need to build auxiliary structures to store chemicals (e.g., chlorine, which must be stored in a separate building). In all jurisdictions, such construction activities require a building permit and inspections to ensure that the structure meets local building codes. New treatment trains can also create a new waste stream or supplement an existing one. New waste streams such as new point source discharges to surface water generally require a state or federal permit; additions to existing flows often require revisions to existing permits. The WBS models include costs for the following permits:

- Building permits
- Permits under the National Pollutant Discharge Elimination System (when residuals discharge to surface water is present)
- Storm water permits (for systems requiring one acre of land or greater)
- Risk management plans (when certain chemicals are present in large quantities)
- Compliance with the National Environmental Protection Act (included by default only at the high cost component level – see Section 2.3.2).

Pilot Study

Site-specific pilot tests are often required by regulatory agencies to better define design conditions and to ensure that the proposed technology will protect public health. In addition, pilot tests and bench-scale tests can be run for non-regulatory reasons, e.g., to determine appropriate loading and chemical feed rates, waste handling requirements or other process parameters. Options for pre-design and pre-construction testing can include full- or small-scale pilot studies, bench tests and desktop feasibility studies. Costs for pilot testing vary accordingly.

Pilot studies range from inexpensive small-scale efforts to full-scale tests that might be warranted by site-specific conditions. Three variables affecting the costs of a pilot study are: technology requirements, testing protocols and state requirements. Some states determine test requirements on a case-by-case basis, particularly where drinking water standards or regulations such as noise, air emissions, plume abatement or surface water discharges (e.g., the National Pollutant Discharge Elimination System) are relatively stringent. The diversity of state requirements, along with the many options for pre-design testing, means that requirements for pilot- or bench-scale studies are difficult to define. Nevertheless, the WBS models include default pilot study costs based on vendor quotes and estimated analysis costs. The user can alter these costs by adjusting the cost data extracted from the central WBS cost database if site-specific conditions warrant.

Land Cost

Regardless of whether a system needs to purchase additional land on which to build the new treatment train, there is an opportunity cost associated with using land for water treatment rather than an alternative use. The WBS models capture this cost in a land cost estimate that is based on the calculated land requirement (in acres) and a unit cost per acre. As discussed in Section 2.3.2, the input sheet of each model includes an optional input that allows the user to choose whether or not to include the cost of land.

Each model estimates land required for the treatment system, plus a 40-foot buffer on one side for emergency vehicle access and 10 feet on the other three sides. The user can change the assumptions about buffer spacing using the critical design assumptions sheet for each technology.

The WBS models incorporate land costs based on unit land costs that vary by system size and land requirements that vary by technology and system size. Average land costs per acre are estimated as probability-weighted averages using data from the Safe Drinking Water Information System on system size and location, data for rural land costs for 50 states and data on urban land costs for approximately 125 cities and metropolitan areas.

2.4.5 Annual O&M Costs

The O&M costs in each WBS model include annual expenses for:

- Labor to operate and maintain the new treatment equipment and buildings
- Chemicals and other expendable items (e.g., replacement media) required by the treatment technology
- Materials needed to carry out maintenance on equipment and buildings
- Energy to operate all equipment and provide building heating, cooling, lighting and ventilation
- Residuals discharge fees.

The individual technology chapters of this document describe additional, technology-specific O&M costs.

O&M costs calculated in the models do not include annual costs for commercial liability insurance, inspection fees, domestic waste disposal, property insurance and other miscellaneous expenditures that are not directly related to the operation of the technology. These costs are highly site-specific. Users wishing to include them should add the appropriate site-specific estimates to the model results.

The WBS models calculate annual O&M costs based on the inputs provided by the user in the input and O&M assumptions sheet. These inputs include system size, raw and finished water quality parameters and other factors that affect operation requirements. Appendix E contains the design assumptions used to develop default costs for the O&M sheet.

2.4.6 Total Annualized Cost

The output sheet in each model includes an estimated useful life, in years, for each WBS component. The models take these component useful lives from the WBS cost database. The useful lives vary by component type (e.g., buildings generally last longer than mechanical equipment) and by material (e.g., steel tanks generally last longer than plastic tanks). The models use the component useful lives to calculate an average useful life for the entire system. The calculation uses a reciprocal weighted average approach, which is based on the relationship between a component's cost (C), its useful life (L) and its annual depreciation rate (A) under a straight-line depreciation method. The formula below shows the reciprocal weighted average calculation:

$$\text{Average Useful Life} = \frac{\sum_{n=1}^N C_n}{\sum_{n=1}^N A_n} = \frac{C}{A}$$

where:

C_n denotes the cost of component n, n=1 to N

C denotes total cost of all N components

A_n denotes the annual depreciation for component n, which equals C_n/L_n

A denotes total annual depreciation for the N components.

The models use this average useful life for the system, along with a discount rate, to annualize total capital cost, resulting in capital cost expressed in dollars per year. The models use a default discount rate of 7 percent, which users can adjust directly on the output sheet. The models add annual O&M cost to the annualized capital cost to arrive at a total annual cost in dollars per year.

2.4.7 Updating and Adjusting Costs

There are many factors that contribute to the variation in capital and O&M costs for the same treatment technology. One variable is location, which is captured by the city index indirect cost. Another is time—over time, the nominal price of materials, labor and land can change due to inflation. If relative prices do not change over time (i.e., if innovative materials or production technologies do not affect production cost relative to the price of other goods), then nominal component prices can be adjusted using standard cost indices. The WBS cost database incorporates the following indices to adjust prices to values in a common year:

- The Producer Price Index (PPI) consists of a family of indices that measure the average trends in prices received by producers for their output (BLS, 2010). Within the PPI is the family of commodity-based indices. The commodity classification structure of the PPI organizes products by similarity of end use or material composition. Fifteen major commodity groupings (at the two-digit level) make up the all-commodities index. Each major commodity grouping includes (in descending order of aggregation) subgroups (three-digit level), product classes (four-digit level), subproduct classes (six-digit level) and individual items (eight-digit level). The WBS cost database assigns components to the most closely related PPI commodity index. The selected price index for a component is generally the index with the smallest product space. For example, prices for stainless steel pressure vessels are escalated using a four-digit level index called BLS1072 Metal Tanks.
- Building and construction costs are escalated using either the Engineering News-Record Construction Cost Index or the Building Cost Index (ENR, 2020).
- Labor costs are escalated using the Employment Cost Index for “not seasonally adjusted, total compensation, private industry and public utilities” (BLS, 2000; SIC series: 252). The Bureau of Labor Statistics releases this index quarterly. The WBS cost database utilizes an annual average.
- The Consumer Price Index is used to adjust land costs and components that have not been assigned a specific PPI (BLS, 2007).

2.5 List of Abbreviations and Symbols in this Chapter

EBCT	empty bed contact time
EPA	U.S. Environmental Protection Agency
GAC	granular activated carbon
gpm	gallons per minute
GREPs	generally recommended engineering practices
HVAC	heating, ventilating and air conditioning
MGD	million gallons per day
O&M	operating and maintenance
P&ID	process and instrumentation diagram
PPI	Producer Price Index
TCE	trichloroethylene
WBS	work breakdown structure

2.6 References

American Water Works Association (AWWA). 1990. *Water Quality and Treatment: A Handbook of Community Water Supplies*. Fourth Edition. New York: McGraw Hill.

AWWA/American Society of Civil Engineers (ASCE). 1998. *Water Treatment Plant Design*. Third Edition. New York: McGraw-Hill.

Bureau of Labor Statistics (BLS). 2007. *BLS Handbook of Methods: The Consumer Price Index*. Updated June 2007. Retrieved from <http://www.bls.gov/opub/hom/pdf/homch17.pdf>

BLS. 2010. *BLS Handbook of Methods: The Producer Price Index*. Last updated 10 July. Retrieved from <http://www.bls.gov/opub/hom/pdf/homch14.pdf>

BLS. 2000. *Employment Cost Indices, 1976-1999*. September. Retrieved from <http://www.bls.gov/ncs/ect/sp/ecbl0014.pdf>

Craftsman Book Company. 2020. *2020 National Building Cost Manual*. 68th Edition.

Engineering News-Record (ENR). 2020. *Building and Construction Cost Indexes*. Retrieved from <http://enr.construction.com/economics/>

RSMeans. 2020. *2020 Square Foot Costs*. 68th Annual Edition. Rockland, Massachusetts: the Gordian Group.

Saylor Publications, Inc. 2020. *2020 Commercial Square Foot Building Manual*.

U.S. Environmental Protection Agency (U.S. EPA). 1997. *Discussion Summary: EPA Technology Design Workshop*. Washington, D.C.: U.S. EPA, Office of Groundwater and Drinking Water.

Viessman, W.J. and M.J. Hammer. 1993. *Water Supply and Pollution Control*. 5th Edition. Harper Collins College Publishers, New York, NY.

3. Reverse Osmosis and Nanofiltration Model

Reverse osmosis (RO) is a membrane filtration technology that, in municipal drinking water treatment, has traditionally been used for desalination of brackish waters and seawater. In RO, influent (“feed”) water is passed through a membrane that filters out (or rejects) the substances to be removed. Water passing through the membrane is split into two streams: the concentrate stream, which contains the substances that are rejected by the membrane, and the permeate (product) stream, which is the stream that passes through the membrane barrier (AWWA/ASCE, 2005). The process depends on applying high pressures across the membrane (in the range of roughly 100 to 1,000 pounds per square inch gauge) in order to overcome the osmotic pressure differential between the saline feed and product waters.

Nanofiltration (NF), sometimes called membrane softening, is a membrane filtration technology that operates similarly to RO. NF removes ions that contribute to water hardness and other contaminants of concern for drinking water treatment (AWWARF, 1995). The process uses pressures in the range of 75 to 150 pounds per square inch (psi).

RO and NF membranes can remove materials as small as 0.01 to 0.001 microns. RO membranes can remove inorganic ions and can effectively reduce total dissolved solids (TDS), nitrate, radionuclides, total organic carbon, some disinfection byproduct (DBP) precursors and synthetic organic chemicals. NF membranes efficiently remove divalent ions; they are less effective than RO membranes in the removal of monovalent ions. They may therefore be used to remove hardness. They are also used to remove color and odor compounds, synthetic organic chemicals and some DBP precursors.

Exhibit 3-1 presents various particle sizes and shows the process range for RO and NF in comparison to other membrane processes.

Exhibit 3-1. Particle Sizes and Membrane Process Ranges

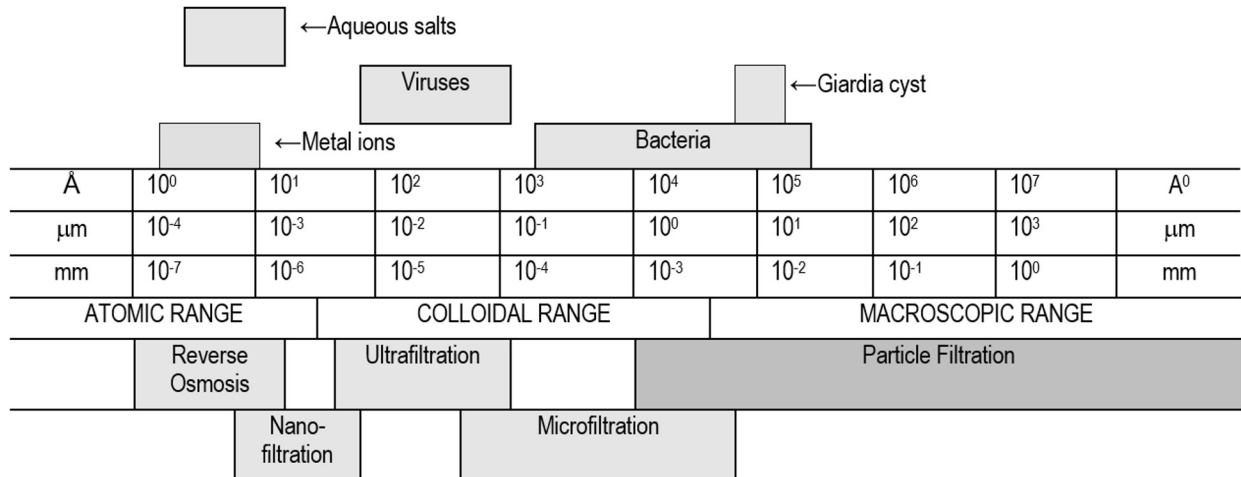

Sources: after Osmonics (1990) and Dow (2005)

Osmosis and reverse osmosis can take place when there is a concentrated solution on one side of a semi-permeable membrane and a dilute solution on the other side. In the absence of any externally applied pressure, water will flow through the membrane from the dilute side to the concentrated side; this is osmosis. If, however, enough pressure is applied to the side with the concentrated solution, the osmotic flow will stop; if more pressure is applied, the flow will reverse and water will flow from the concentrated side to the dilute side. This condition is reverse osmosis and the pressure that exactly balances the osmotic flow is called the osmotic pressure.

RO is advantageous because of its capability to remove a wide range of contaminants. Since RO permeate has a reduced chlorine demand, its finished water requires a low dose of disinfectant. RO is suitable for small systems with a high degree of seasonal fluctuation in water demand. There is no breakthrough period required for RO to work. NF and RO systems are automated processes that require little operator time.

One of the disadvantages of RO is its low water recovery when compared to other drinking water treatment technologies. The Small Business Advocacy Review Panel (1999) pointed out that a water rejection rate of 20 to 25 percent can present a problem where water is scarce, such as in the western states. Operating with a higher recovery, however, would increase equipment and energy costs for small water systems. In addition, RO generates a large volume of concentrate that may need to be treated before disposal. RO also has a higher energy demand than other water treatment technologies due to its operation under high pressure.

3.1 Overview of the RO/NF Treatment Process

The RO/NF treatment process includes the following components:

- Feed water pumping
- Pre-treatment systems, which may include cartridge filters, pH control and antiscalant addition, with secondary containment when chemical addition is included. (These systems provide minimal pre-treatment that is usually appropriate for groundwater. Surface water pre-treatment is considered in other work breakdown structure, or WBS, models, as described below.)
- The RO or NF membrane filtration process system
- Chemical cleaning systems with secondary containment for cleaning chemical storage
- Equipment for the discharge of water treatment residuals
- Associated piping, valves and instrumentation.

Several processes that can be used for pre- or post-treatment in an RO/NF plant include the following:

- When surface water is the source for an RO or NF membrane system, it is often necessary to use other pre-treatment processes such as lime softening, media filtration or low-pressure membrane filtration.

- RO permeate has low alkalinity and pH and is therefore quite corrosive. Since gases permeate freely through the membrane, it is typically high in dissolved carbon dioxide. Hydrogen sulfide in the feed water will also be present in the permeate. Therefore, post-treatment is necessary before the water can enter a distribution system. Typical post-treatment steps include alkalinity recovery by feeding sodium hydroxide or lime and, if needed, aeration for the removal of gases. Hydrogen sulfide may be removed by aeration or oxidation with chlorine; in either case, it is necessary to maintain a low pH in order to avoid the precipitation of elemental sulfur (AWWARF, 1996).

The WBS model for RO/NF does not include these types of pre- or post-treatment. To account for the cost of these additional treatment steps, the U.S. Environmental Protection Agency (EPA) has developed separate WBS models that generate costs for the pre- or post-treatment steps. In generating national costs, EPA would add costs from the separate treatment models to costs from the RO/NF model for scenarios that incorporate pre- or post-treatment.

Membranes can be made from organic and inorganic polymers and inorganic materials such as ceramics or glass. The membranes used for water treatment are generally non-cellulose thin-film composite (TFC) or amidic composite. Most drinking water systems use TFC membranes because they can obtain higher production rates and better salt rejection rates than cellulose membranes. Polyamidic and TFC membranes degrade in presence of chlorine and other oxidants. They are resistant to biological fouling and hydrolysis between pH of 4 and 11 (AWWA, 1999; AWWARF, 1996).

For municipal drinking water treatment, RO and NF membranes are typically used in a spiral-wound configuration. A spiral wound membrane consists of several membrane envelopes, layered with feed spacers and rolled together in a spiral around a central permeate collection tube. Each envelope consists of a flat membrane sheet folded in half over a porous membrane permeate carrier and glued on the remaining three sides to completely enclose the carrier. The envelopes are connected to a central permeate collection tube. After the envelopes and feed spacers are rolled around the tube, the assembly is enclosed in a shell to form a membrane element.

Multiple elements are placed within a pressure vessel. To achieve the target removal efficiency and water recovery, these pressure vessels often are arranged in sequential stages, typically up to three depending on the recovery to be achieved (AWWA/ASCE, 2005; Dow, 2005). When multiple stages are used, the number of pressure vessels decreases from stage to stage. Permeate or finished water is collected from each pressure vessel. The concentrate stream from the first membrane stage serves as the feed to the second and the concentrate stream from the second stage serves as the feed to the third. Consequently, each successive stage of the process increases the total system recovery (Jacangelo et al., 1998). The stages in combination make up an RO/NF treatment train. A treatment system may have multiple trains. **Exhibit 3-2** provides a schematic drawing for the filtration process within an RO/NF system; each rectangular box within a train represents a pressure vessel that contains multiple membrane elements.

Exhibit 3-2. Typical Schematic Layout for Reverse Osmosis/Nanofiltration

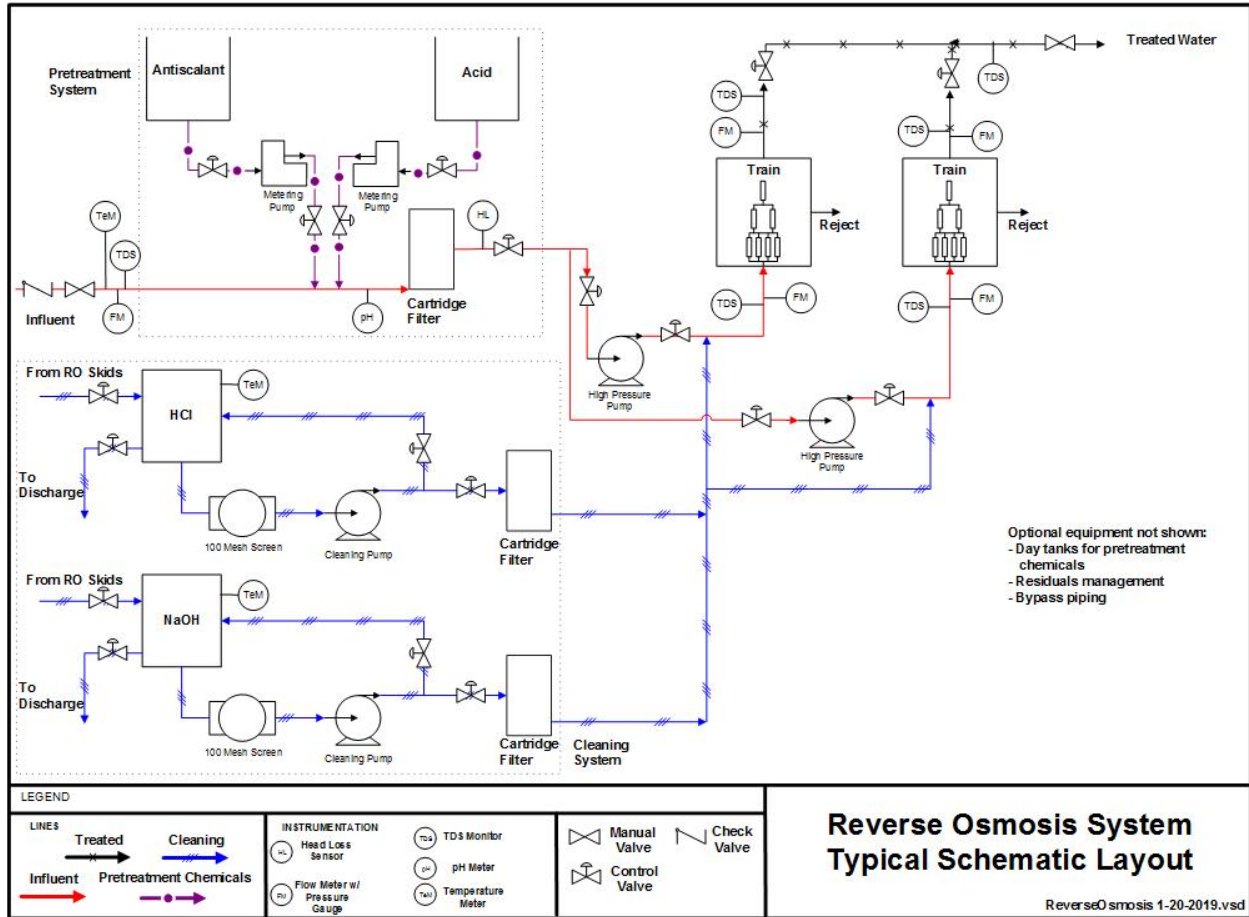

Membrane plant design generally requires a pilot study. One of the most important reasons for conducting a pilot study is to evaluate the influence of water quality on membrane fouling and to determine pre-treatment requirements. Calculations such as the silt density index (SDI), found in ASTM standard D3739-94, can provide insight into the fouling problems that are inherent in any membrane system. SDI measures the fouling potential of suspended solids. Manufacturers typically specify maximum SDIs of 3 to 5 for RO and NF elements. In addition, it is important to model and conduct pilot studies to assess the potential for fouling from substances such as calcium carbonate (CaCO_3), silica (SiO_2), calcium fluoride (CaF_2), barium sulfate (BaSO_4), calcium sulfate (CaSO_4), strontium sulfate (SrSO_4) and calcium phosphate. The scaling potential of other substances may be determined from a saturation calculation. The Langelier saturation index (LSI), described in ASTM standard D4189-94, characterizes the potential for CaCO_3 scaling. The LSI is used to indicate whether calcium carbonate will precipitate or dissolve in water, as well as the pH change required to re-dissolve the calcium carbonate.

Pre-treatment is necessary in a typical RO/NF system to minimize fouling and other damage to the membrane. The type of pre-treatment necessary depends on the influent water quality, post pre-treatment and recovery ratio and final water quality needed. The membrane material and configuration of the RO/NF module will also affect the pre-treatment required (AWWARF,

1996). Typically, pre-treatment includes pre-filtration to remove large particles and addition of acid and antiscalants to prevent scaling.

Periodic cleaning of the membrane system is necessary to recover productivity lost to fouling. This cleaning may include cycles of acid and caustic wash, depending on the nature of the fouling. Basic cleaning systems consist of chemical solution mixing tanks, screens and filters, recirculation pumps, tubing and provisions for draining (Dow, 2005).

Different RO and NF membranes allow for different flux rates of water and ions. The passage of water and ions may be modeled mathematically. There are many models of water and solute transport across a membrane surface. The calculations in the WBS model are based on the linear solution diffusion model (AWWARF, 1996).

Water flux, K_w , can be measured in gallons per square foot per day (gfd). It is characterized by the equation:

$$K_w = A(\Delta P - \Delta \pi)$$

where:

A	=	Water mass transfer coefficient or specific flux, gfd/psi
ΔP	=	Transmembrane pressure differential, psi
$\Delta \pi$	=	Transmembrane osmotic pressure differential, psi

The quantity $\Delta P - \Delta \pi$ is called the net driving pressure or NDP and is denoted P_{net} .

Rather than measuring the solute flux directly, membrane system designers typically focus on the salt passage, defined as:

$$salt\ passage = \frac{C_p}{C_m}$$

where:

C_p	=	Concentration on product side of membrane surface (permeate), mg/L
C_m	=	Concentration on feed side of membrane surface (concentrate), mg/L

Note that C_m is typically greater than the bulk concentration of solute on the feed side of the membrane. This effect, called concentration polarization, is discussed further below. Typically, each ion will have a different passage. The passage may be modeled for each ion in terms of another membrane parameter, B , and a factor, f_i , that is specific to the ion-membrane combination. Then:

$$\frac{C_p}{C_m} = \frac{B}{A \times P_{net} + B} \times f_i$$

where:

B	=	salt diffusion coefficient, defined for the membrane element, gfd
f_i	=	Ion passage factor, dimensionless; varies for each ion, i , in the solute

Typically, B is defined so that f_i is equal to one for a reference ion such as sodium or chloride.

A and B depend on the membrane material and may change with the conditions under which the membrane system is operated. They depend, in particular, on the water temperature, the pressure applied to the membrane and the osmotic pressure and TDS on the feed side of the membrane (Dow, 2005; Wolfe, 2004). As feed water flows through the membrane, ions are carried towards the membrane surface. The ions that are rejected will concentrate near the surface, increasing the feed concentration in a thin layer. This effect is known as concentration polarization. It is characterized by the parameter β , defined such that:

$$\beta = \frac{C_m}{C_f}$$

In this formula, C_m is the concentration at the membrane surface, as above, and C_f is the average concentration in the feed water. The concentration polarization typically ranges from 1.0 to 1.2. β increases with the recovery in the element and decreases with flow rate. According to Wolfe (2004), it can be approximated by:

$$\beta = \exp^{cY}$$

where:

- Y is the fractional recovery in the membrane element
- c is a coefficient that depends on the design of the element.

The recovery, Y , is equal to the fraction of feed water that passes through the membrane. The default membranes in the WBS model have maximum recoveries ranging from 15 to 27 percent. The recovery may be defined for a single membrane element or for the entire membrane system.

The pressure applied to the membrane determines the water flux; increasing the transmembrane pressure will increase the flux through the membrane. At the same time, as water passes through the membrane, the solute concentration on the feed or brine side of the membrane increases. The designer must maintain a brine concentration low enough to prevent scale formation and fouling of the membranes.

3.2 Input Sheet

The input sheet accepts user-defined design parameters that determine fundamental process requirements. The user can indicate system size and select basic equipment parameters such as operating pressure. Key design considerations that the user identifies on this sheet are described in greater detail below and include the following:

- Feed water
- Design and average flow (production flow, see Section 2.3 and below)
- Feed water temperature
- Include redundant train?
- Membrane element
- Number of operating RO trains (optional)

- Target recovery rate
- Design flux
- Pre-treatment options
- Cleaning interval (optional)
- Residuals management
- Component level (optional, see Section 2.3)
- System automation (optional, see Section 2.3 and below)
- Include buildings; heating, ventilating and air conditioning (HVAC) and land? (optional, see Section 2.3).

Exhibit 3-3 summarizes the units and constraints (i.e., Excel validation criteria) for each of these inputs, along with conditions under which the model generates warnings. The sections below describe each input in greater detail.

Exhibit 3-3. RO/NF Model Input Constraints and Warnings

Input	Units	Constraints	Warning Conditions
Select Feed Water	Pick list	Pick list	None
Design flow	MGD or gpm	Greater than 0	Blank
Average flow	MGD or gpm	Greater than 0	Blank, greater than design flow or less than 0.1 times design flow
Feed temperature	degrees centigrade	Greater than 0	Blank or greater than the maximum operating temperature specified for the type of element selected
Include redundant train?	Yes/No	Yes/No	None
Membrane element	Pick list	Pick list	Blank
Number of operating RO trains (optional)	dimensionless	Integer greater than 0	None
Target recovery rate	percent	Greater than 0 and less than 100%	Blank, outside constraints or cannot achieve target recovery in three stages
Design flux	gfd	Greater than 0	Blank or outside flux limits specified on the critical design assumptions sheet for the selected feed SDI
Acid for pretreatment	Pick list	Pick list	Blank
Treated feed pH (if acid pretreatment is included)	Standard units	Between 2 and 14	Blank, less than minimum for continuous operation or greater than original feed pH
Antiscalant	Pick list	Pick list	Blank
Cleaning interval (optional)	months	Greater than 0	Greater than maximum allowable interval specified on the critical design assumptions sheet
Discharge option for reject/cleaning solution	Pick list	Pick list	Blank
Flow equalization for reject/cleaning solution	Pick list	Pick list	Blank
Characteristics of spent membranes/solids for disposal	Pick list	Pick list	Blank
Component level (optional)	Pick list	Pick list	None
System automation (optional)	Pick list	Pick list	None
Include buildings?	Yes/No/Blank	Yes/No/Blank	None
Include HVAC?	Yes/No/Blank	Yes/No/Blank	None

Input	Units	Constraints	Warning Conditions
Include land?	Yes/No/Blank	Yes/No/Blank	None

gfd = gallons per square foot per day; gpm = gallons per minute; MGD = million gallons per day; SDI = silt density index

After the inputs are specified, the model will display a design for the RO system showing how many stages are required, the number of pressure vessels per stage and how many elements will be used in each pressure vessel. More information on the calculation is provided in Section 3.7.

To generate cost data, press the “Generate Results” button. The model will then determine the required feed pressure and any pressure adjustments necessary in the later stages of the train, a process that takes several seconds. During this time, the model will display messages that describe the status of the calculations and may briefly show error messages that describe problems with preliminary pressure estimates. These messages will disappear when the model finds a feed pressure (and possibly a set of pressure adjustments in later stages) that satisfy the target water production and recovery rate. In rare cases, the model may be unable to find an appropriate set of pressures; in these cases, it may be necessary to adjust the target recovery rate or design flux.

Note that the model’s designs are intended to generate cost estimates for policy analysis purposes. Thus, the model estimates general quantity requirements for membrane elements, pressure vessels, booster pumps or throttle valves and pump energy. The designs are not necessarily optimized for the treatment of a particular feed water.

If you press the “Generate Results” button, adjust the inputs and press “Generate Results” again, the model may display a dialog box saying that the main sizing inputs (design flow, temperature, feed water, membrane element, target recovery and design flux) are the same as for the previous run. In this case, it may be fastest to start from the pressures that the model computed for the previous set of inputs. Choose “yes” at the dialog box to use these pressures. Advanced users who change membrane element parameters or the critical design assumptions that govern the pressure tuning routine, may wish to choose “no” to start from scratch. In either case, the model should be able to compute a suitable set of pressures.

Once the model has completed its calculations, it will display information about the required pressures, the permeate water quality and the scaling potential of the membrane concentrate underneath the “Generate Results” button. If there is an error or other problem in the system design, the model will display a message on the input sheet describing the problem.

The buttons at the top of the input sheet provide standard designs at several different flows. To use the standard designs, first select a feed water and then press the button corresponding to the desired flow.

Feed Water

STEP 1

Select Feed Water

The WBS model for RO/NF includes a “drop-down” list box that allows the user to select from among several feed water options. This box is located at the top of the input sheet, above the standard design buttons. The user should verify that the selection shown in this box is correct before populating the other design input values. The user can change the feed water modeled by picking a different selection from the list. After doing so, the user should then repopulate the input sheet with values appropriate for the new feed water by clicking one of the standard design buttons or manually adjusting inputs and clicking the “Generate Results” button (see Section 2.3 for further discussion of each of these methods).

The feed water options set the default feed water quality, which is a primary input to the train design routine. **Exhibit 3-4** shows the feed water options. EPA developed these water analyses to establish typical low- and high-end costs for RO and NF water treatment, as well as typical mid-range costs. Costs for specific scenarios may require changes in the feed water characteristics, which require additional model inputs.⁶ In addition to the options shown in **Exhibit 3-4**, a few additional feed water designs are present for use in testing the model (e.g., 2,500 ppm NaCl).⁷

The feed water also determines which membrane element and pre-treatment are used in the standard designs (see Chapter 2 for more information on standard designs). The standard designs for high, mid and low quality feed use nanofiltration, low-pressure RO and brackish water RO elements, respectively. They also, by default, set the optional component level input to low, mid or high cost, respectively (see Section 2.3 for more information on the component level input). Each standard design includes chemical pre-treatment appropriate to prevent scaling given the design’s feed water and recovery goal. A user can always override the standard designs by entering different choices on the input sheet.

⁶ To use a different feed water, first enter it in the water specs sheet. An interactive form is available by using the “Add Water Analysis” button on that sheet. The form allows users to enter the concentration of each ion. It will issue a warning if the ionic charges do not balance. It is also possible to specify a feed water with a given concentration of MgSO₄ or NaCl. Each feed water must also be assigned a name, a pH, and an SDI. After the feed water is entered in the Water Specs sheet, its name will appear in the Feed Water dropdown on the input sheet. Choose its name from the dropdown. The model will then estimate costs for treatment of new feed water.

⁷ The model also includes a selection in the feed water list entitled “Reuse Train Post MF.” This option is meant to be used in conjunction with other WBS models as part of a forthcoming tool to estimate the costs of a complete series of treatment processes that might be used as part of an advanced water treatment train for potable reuse. Because this tool is currently under development, this document does not discuss the specific inputs associated with the reuse train feed water option.

Exhibit 3-4. Standard Feed Waters

Water name	High Quality GW	Mid Quality GW	Low Quality GW	High Quality SW	Mid Quality SW	Low Quality SW
Ca (ppm)	70	68	119	35	110	275
Mg (ppm)	18	50	100	5	40	25
Na (ppm)	47	300	1000	65	202	589
K (ppm)	3	0	20	1	7	3
Ba (ppm)	0.002	0.04	0.125	0.002	0.07	0.05
Sr (ppm)	1.1	0.3	10	1	1	1
HCO3 (ppm)	175	250	225	150	125	125
Cl (ppm)	40.5	60	1550	60	350	900
SO4 (ppm)	150	707	520	42	280	673
F (ppm)	0.1	1	2	0.1	0.3	0.3
SiO2 (ppm)	10	20	20	3	5	5
pH	7.3	7.6	8.0	7.5	7.9	8.2
SDI (15 min)	1.1	1.9	2.8	2.1	3.5	4.8
Approximate TDS (ppm)	510	1460	3570	290	1060	2530
Treatment goal	Organics removal, hardness reduction	TDS reduction	TDS reduction	Organics removal, hardness reduction	TDS reduction	TDS reduction

GW = groundwater; ppm = parts per million; SDI = silt density index; SW = surface water; TDS = total dissolved solids

Design and Average Flow (Production Flow)

	Select Units
Design Flow (including bypass)	0.74 MGD
Average Flow (including bypass)	0.251 MGD
Feed temperature	15 deg C

As discussed in Section 2.3, the model requires the design and average flows to determine the size and number of treatment components needed. In the RO/NF model, the input flows are the design and average production, or treated water, flows. Unlike many other technologies, the production flows in a membrane system will differ from the raw water, or influent, flows, because recovery rates (see below under “Target Recovery Rate”) are less than 100 percent. The WBS model takes into account recovery rates and sizes the equipment based on the raw water flow needed to meet the production flow.

If the user specifies a bypass percentage on the critical design assumptions sheet (see Section 3.3), the production flows equal the total of the bypass and permeate flow. In this case the model will compute the permeate flow required for the bypass percentage indicated by the user. Otherwise, the production flow is the permeate flow. After the model determines the design and average permeate flows, based on the specified production flows and any blending, it calculates the necessary influent flow to achieve the desired production flow. It sizes the pumps and pre-treatment components to handle the calculated influent flow.

Feed Temperature

Average Flow (including bypass)	0.251 MGD
Feed temperature	15 deg C
Include redundant train?	no

The temperature of the feed water has a significant effect on the membrane’s permeability to both solute and water (the water mass transfer coefficient A). The temperature also affects the

carbonate chemistry, osmotic pressure and viscosity. In general, a higher feed water temperature will result in a higher permeate water flow, at a given pressure, as well as a higher salt passage. The model will display a warning if the feed temperature is outside specifications for the selected membrane element.

Systems that use surface water will experience seasonal variations in water temperature. As stated above, the lower the temperature, the more pressure is required for a given amount of permeate flow. However, since water demand also varies seasonally, it may be possible for systems that use surface water to operate for fewer hours when water temperatures are low. Instead of modeling temperature and demand throughout the year, the model uses an input for design temperature (between 0 and 45°C) and computes pressure and energy requirements to produce the average flow at the design temperature year round.

Include Redundant Train?

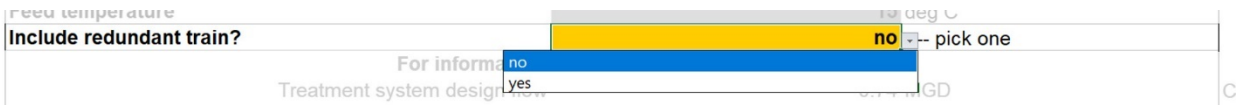

The input sheet offers the choice of whether or not to include redundant units in the system design. The purpose of redundancy is to allow a plant to maintain its design capacity while some membrane units are offline (e.g., for cleaning). Factors in determining whether to include redundant membrane elements are the ratio of design flow to average flow, treated water storage capacity, local regulatory requirements and other site-specific treatment goals or preferences. Smaller systems with production flow rates less than 1 million gallons per day (MGD) often do not include redundancy because their peak flow demands are much greater than their average flow demands, creating a large excess production capacity on average. The standard designs include redundancy for systems with design production flows greater than 1 MGD. The user can modify the exact level of redundancy (i.e., the ratio of operating membrane elements to redundant elements) on the critical design assumptions sheet.

Membrane Element

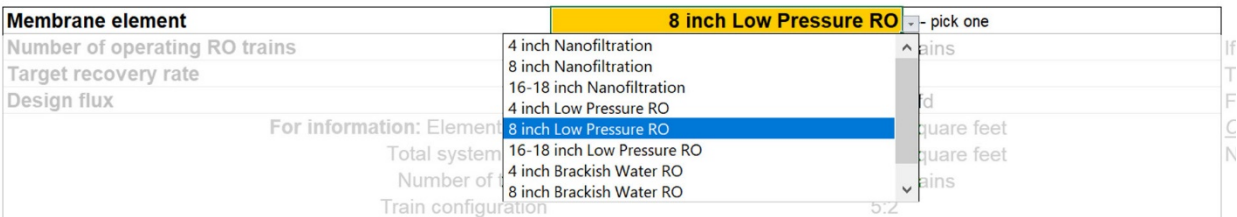

Membrane elements from different manufacturers, and different elements from the same manufacturer, may have widely varying water and ion permeabilities. The WBS model contains three basic types of membrane elements: low-pressure RO (with relatively higher water permeability), brackish water RO (with lower water and salt permeability) and nanofiltration elements. Each is available in three diameters: a 4-inch element (for use in very small systems), an 8-inch element and a 16- to 18-inch element (the membrane industry does not currently have a standard diameter larger than 8 inches, so a single large diameter [16 to 18 inches] is assumed in the modeling). The element parameters in the model do not represent specific manufacturers. Instead, they are chosen to represent mid-range values for *A* and *B*, based on the membrane

behavior modeled in design programs from different membrane element manufacturers. Numerous characteristics of each element are tabulated on the ancillary sheet labeled “Membrane Specs.” For each element, the following parameters are tabulated:

- Membrane type (RO or NF)
- Length and diameter of the element, in inches
- Membrane area, in square feet
- *A* value, in gfd/psi
- Coefficients used to correct *A* for applied pressure, temperature and feed osmotic pressure
- *B* value, in gfd
- Coefficients used to correct *B* for temperature and feed TDS
- The geometric coefficient *c* used to compute the concentration polarization
- Coefficients used to compute the pressure drop as water flows through the membrane element
- Maximum operating specifications, including the maximum feed pressure and flow, maximum recovery in one element, minimum concentrate flow, maximum feed SDI, minimum operating pH, maximum operating temperature and maximum pressure drop permitted in a single element and a complete pressure vessel.

Section 3.7 details the use of these parameters.

The membrane element is selected using the drop-down box on the input sheet. When a user chooses an element, the model displays its area. If the SDI of the feed water is too high for this element, the model will display a warning. In this case, the user may choose another element or create a customized feed water on the water specs sheet with an SDI level that reflects the expected SDI level with pre-treatment of the feed water. The user may then use select the new water as described above in the section “Feed Water.”

Number of Operating RO Trains (Optional)

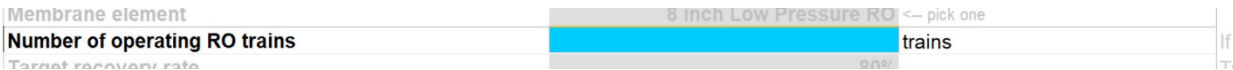

By default, the model calculates the number of operating trains, before redundancy, based on a maximum permeate flow per train that varies based on the membrane element specified, with a minimum of two trains. The input sheet, however, includes an optional input that allows the user to override the default calculation and directly specify the number of RO trains, before redundancy, to be included in the design. The model standard designs leave this optional input blank to accept the model default calculations.

Target Recovery Rate



As discussed above, the RO/NF process produces a permeate flow (water with most dissolved solids removed) and a concentrate flow (residual water rejected by the membrane). The recovery is the percentage of the influent flow rate that is recovered as permeate rate. Increasing the recovery will increase the concentration of dissolved solids in the membrane reject water and will thus increase the required feed pressure and the potential for membrane scaling. Thus, the achievable recovery depends on the quality of the source water as well as the pre-treatment of the water (ASCE/AWWA, 1998), and systems with high levels of TDS in their feed water will typically operate at lower recoveries than systems with lower levels.

For a given membrane and feed water, a higher recovery will require the use of more elements in series. To account for the non-linearities associated with the vessels in series, the actual recovery performance compared to the manufacturer’s specifications is accounted for by an efficiency variable “Average recovery per element, as fraction of spec” that is specified as a percentage on the Critical Design Assumptions sheet. The model accomplishes this by increasing the number of elements per pressure vessel and/or by increasing the number of stages in the system.

For NF membrane elements, the target recovery will typically be between 80 and 90 percent. For RO elements, the target recovery will typically be between 50 and 85 percent. The model displays guidance with those bounds. However, systems with small production flows may need very few elements in total to achieve their production and flux goals. Since these systems have few elements in total, they cannot put many elements in series, and they may therefore be more limited in the recovery they can achieve. The most economical choice for those systems may be to run at a low recovery.

The model standard designs use target recovery rates between 75 and 85 percent when the design flow is greater than 0.5 MGD. For design flows less than 0.5 mgd, the designs use recovery rates that optimize the model’s projected costs. Recoveries at these small flows, therefore, vary between 65 and 80 percent. In general, standard designs for lower cost levels use higher recovery rates.

Design Flux



The flux of the system is the rate of permeate water per unit of membrane area. In the model, it is measured in gfd. While each stage of a membrane system will have a different flux, the average flux over all elements is a fundamental design parameter. In general, the higher the quality of the feed water, the higher the flux that may be achieved. Operating with excessively high flux, however, leads to fouling of the membrane elements. Depending on the nature of the fouling, it can be reversed by cleaning or can require replacement of the elements.

For some high-quality groundwaters, systems can operate successfully with fluxes as high as 18 to 20 gfd. Surface waters require lower fluxes, typically between 12 and 17 gfd, depending on the SDI of the source water. Pre-treatment with microfiltration or ultrafiltration membranes will

usually permit the use of a higher flux. The WBS model uses the SDI as a proxy for the feed water quality. It will issue a warning if the flux is outside a prescribed range, based on the SDI and whether the water is a surface or groundwater. The model's flux ranges are based on typical recommendations from membrane element manufacturers. **Exhibit 3-5** lists these ranges.

Exhibit 3-5. Flux Ranges

Feed Water Type	Feed Water SDI	Flux Range
Either	<1 ^a	21-25
Groundwater	1-3	16-20
Groundwater	3-5	12-16
Surface Water	1-3	13-17
Surface Water	3-5	10-16

a. These very low SDI values are typically associated with second-pass treatment of RO permeate.

The standard designs in the model use fluxes of 16, 17 and 19 gfd, respectively, for the low, mid and high quality groundwaters and 12, 14 and 16 gfd, respectively, for the low, mid and high quality surface waters.

Pre-treatment Options

Acid for pretreatment	H2SO4	<-- pick one
Treated feed pH	6.90	S.U.
Antiscalant	Basic (carbonate)	<-- pick one
For information:		pH adjustment requires 27 mg/L H2SO4, at 78% strength.
Pretreatment inputs OK		

To reduce fouling of the membrane, some type of pre-treatment is usually required. The RO/NF model includes three pre-treatment steps, two of which are optional:

- 5-micron cartridge filtration, to remove larger particles that can clog the membrane elements
- Optional acid addition, to reduce the scaling potential of calcium carbonate
- Optional antiscalant addition, to reduce scaling potential of several substances.

Other possible pre-treatment steps, such as lime softening, media filtration and low-pressure membrane filtration, are covered by other WBS models and are not included in the RO/NF model, as discussed in Section 3.1.

Reducing the feed water's pH by adding acid will lower the concentration of carbonate ions and therefore will reduce the saturation of calcium carbonate. Acidifying the water will also convert some bicarbonate to carbonic acid, which passes through the membrane as carbon dioxide. Adding lime to the permeate will then convert the carbonic acid back to bicarbonate, allowing recovery of alkalinity in the finished water.

The model includes the option of adding hydrochloric acid or sulfuric acid; however, because hydrochloric acid is much more expensive than sulfuric, the standard designs that include acid pre-treatment always use sulfuric acid. If acid pre-treatment is specified, the model requires the target pH for the feed water. It then determines how much of the specified acid to add to the feed. The model will issue a warning if the feed pH is lower than the tolerance indicated for the

membrane element; however, elements can typically operate continuously with pH as low as 2 to 4, while a typical feed pH might be 5 to 6.5.

Antiscalants, also called scale inhibitors, will inhibit scaling when scaling salts are oversaturated in the membrane concentrate. If the system design routine determines that salts are oversaturated, the model will recommend the use of an antiscalant, unless the oversaturation is so great that antiscalant is likely to be ineffective. Many different antiscalants are available, and the choice of antiscalant depends on site-specific conditions. To capture some of this variation, the WBS model includes two options for antiscalants: a basic antiscalant, for use when only carbonate scaling is of concern, and a premium antiscalant, for use when silica, fluoride or sulfate scaling is of concern. The WBS model uses the following rules of thumb (Freeman and Randtke, 2006) to determine whether antiscalant will be effective:

- CaCO_3 , to an LSI of 2.3
- SiO_2 , to a concentration of 150 milligrams per liter (mg/L)
- CaF_2 , to 10,000 percent of saturation
- CaSO_4 , to 200 percent of saturation
- BaSO_4 , to 4,000 percent of saturation
- SrSO_4 , to 800 percent of saturation.

Users can adjust these parameters on the critical design assumptions sheet.

The input sheet contains a user input option that determines whether to use basic antiscalant, premium antiscalant or neither. The antiscalant dose can be specified on the critical design assumptions sheet.

A bicarbonate alkalinity of 1 to 3 milliequivalents per liter in the finished water is desirable for corrosion control (AWWA, 1999). The standard designs in the model therefore use sulfuric acid pre-treatment to ensure that at least 1.5 moles per liter of inorganic carbon is present in the RO permeate.

Antiscalant use in the standard designs is based on the model’s projections of concentrate saturation. The concentrate resulting from treatment of the low-cost waters is oversaturated in calcium carbonate (LSI>0), while the mid- and high-cost waters yield concentrate that is also oversaturated in other scaling salts. Therefore, for low and mid quality waters, the model’s standard designs use premium antiscalant. For high quality waters, the standard designs use basic antiscalant, except for the two smallest system sizes with high quality water, which use no antiscalant.

Cleaning Interval (Optional)

Cleaning interval		months
	For information:	Default cleaning interval is 15.6 months, based on feed SDI. Cleaning input OK

By default, the model estimates a cleaning interval from 3 to 18 months, based on the SDI of the feed water. However, cleaning requirements for RO/NF systems vary greatly based on site-

specific conditions. Users may therefore enter a cleaning interval on the input sheet, overriding the model’s estimate. For more information on the estimate, see Section 3.3.

Residuals Management

Discharge option for reject/cleaning solution	direct discharge / ocean outfall	<--pick one
Flow equalization for reject/cleaning solution	no flow equalization	<--pick one
Characteristics of spent membranes for disposal	non-hazardous	<--pick one
Residuals inputs OK		

The RO/NF process generates three residuals streams: the membrane concentrate, spent cleaning solution and spent membranes. Since the spent cleaning solution is generated infrequently and in small amounts, the model assumes that it will be diluted and discharged with membrane concentrate. The input sheet requires the user to choose from among several options for management of the resulting liquid residuals stream. **Exhibit 3-6** shows the available residuals management options for membrane concentrate (including diluted cleaning solution).

The management options shown in **Exhibit 3-6** include several alternatives for flow equalization. While membrane systems generate concentrate on a continuous basis, some systems may operate for partial days. Flow equalization might be appropriate, then, to prevent instantaneous flow from overwhelming the capacity of a publicly-owned treatment works (POTW).

The option in the RO/NF model for direct discharge assumes that RO and NF facilities located near a coastline are likely to use ocean outfalls to dispose of their concentrate. Therefore, when direct discharge is chosen, the model assumes 5,000 feet of piping is required to reach the discharge point, rather than the default value discussed in Appendix C.

Exhibit 3-6 also includes the option for an evaporation pond. Given the potentially large quantities of membrane concentrate, this management method might be appropriate when the residual is non-hazardous, particularly for facilities in dry climates. The required area for an evaporation pond depends on local climate. After selecting an evaporation pond, the user should carefully review the climatic parameters on the critical design assumptions sheet. For more information, see Appendix C. Furthermore, to ensure that heating, cooling and standby power costs are computed consistently, the user should review the climatic parameters in the operating and maintenance (O&M) and indirect assumptions sheets. Appendix E and Appendix D contain information on these parameters. The use of an evaporation pond results in the generation of a secondary residuals stream, in the form of evaporation pond solids.

Exhibit 3-6. Management Options for Membrane Concentrate

Options for Stage 1 of Residuals Management	Options for Stage 2 of Residuals Management
Holding tanks (for flow equalization)	Direct discharge to surface water or ocean outfall Discharge to POTW Deep well injection Concentrate recycling * Hazardous waste disposal
Holding basins (for flow equalization)	Direct discharge to surface water or ocean outfall Discharge to POTW Deep well injection Concentrate recycling * Hazardous waste disposal
Holding lagoons (for flow equalization)	Direct discharge to surface water or ocean outfall Discharge to POTW Deep well injection Concentrate recycling * Hazardous waste disposal
No flow equalization	Direct discharge to surface water or ocean outfall Discharge to POTW Deep well injection Evaporation pond**

* This option has been temporarily removed from the model. The train design sheet does not take concentrate recycling into account when it determines the feed pressure. See discussion below.

** Results in generation of secondary residuals (evaporation pond solids).

The model also includes the option of deep well injection of membrane concentrate. Larger RO plants, notably in Florida, have injected their membrane concentrate into porous rock formations below the lowest source of underground drinking water. The Class I injection wells used for concentrate disposal can reach depths of 1,000 to 8,000 feet, depending on local geology. They use several casings and layers of cement surrounding the central pipe through which concentrate is injected, called the injection tubing. The cost of an injection well includes substantial testing and surveying. A separate monitoring well is also required.

For deep well injection, the WBS model uses a linear approximation to a cost buildup developed for the Bureau of Reclamation (Mickley, 2006):

$$\text{Cost (2001\$)} = -288,000 + 145,900 * \text{Diameter (inches)} + 754 * \text{Depth (feet)}$$

The diameter in the approximation is the diameter of the central injection tubing. The cost buildup includes costs for drilling and reaming; logging, testing and survey; installed casing, grouting, injection tubing and packer; and a monitoring well. The approximation also includes an allowance for mobilization and demobilization, equal to 20 percent of the construction costs for the main well (not the monitoring well). It does not include the cost of pumping the concentrate into the well.

To use the Bureau of Reclamation costs, the WBS model assumes a well depth of 3,500 feet. The model will use multiple wells if the concentrate flow rate is greater than a maximum flow rate, assumed to be 10,000 gallons per minute (gpm). The model determines the diameter of the injection tubing by assuming a flow speed of 10 feet per second at the design flow of concentrate. The model includes the mobilization and demobilization cost of the Bureau of

Reclamation model in its indirect costs. However, for simplicity, the WBS model assumes that one-sixth of the total injection well cost is due to mobilization and demobilization. The model also includes pumps at the wellhead with 40 psi of head. When deep well injection is chosen, the model assumes 5,000 feet of piping is required to reach the injection point, rather than the default value discussed in Appendix C.

The model includes the option to recycle membrane concentrate to the head of the RO/NF process. Concentrate recycling is sometimes used in RO/NF systems to improve crossflow velocity and reduce the recovery required for the membrane system. It is important to note that the model's pressure calculations do not take concentrate recycling into account. To approximate the effects of concentrate recycling, it is possible for users to enter a custom feed water with the estimated characteristics of the combined feed and recycle streams and adjust the target recovery downwards. This option has been temporarily removed from the model while EPA reviews its implementation.

Finally, the model includes the option to dispose the membrane concentrate as liquid hazardous waste. Flow equalization is always required when hazardous waste disposal is selected, to store the membrane concentrate prior to disposal.

Management options available for spent membranes and evaporation pond solids (when generated) include the following:

1. Disposal as non-hazardous solid waste⁸
2. Disposal as hazardous waste
3. Disposal as radioactive waste
4. Disposal as radioactive and hazardous waste.

The solid residual management options do not include disposal in an on-site facility. This option would be economically viable only for facilities with an existing on-site landfill—a factor that is highly site-specific. For these facilities, the cost of this option would be less than that for off-site disposal, because it would involve much lower transportation costs. Therefore, the off-site disposal options included provide a conservative cost estimate for these facilities.

According to Burbano et al. (2006), the predominant method of concentrate disposal for RO/NF plants is direct discharge to an ocean or receiving stream; 59 percent of plants surveyed used direct discharge. Therefore, all of the standard designs in the model assume direct discharge of the membrane concentrate to an ocean or surface water.

⁸ Users can also select land application, instead of landfilling, for non-hazardous evaporation pond solids by changing an option on the critical design assumptions sheet. Appendix C discusses this option in more detail.

System Automation

Component level		<-- pick or leave blank
System automation		pick or leave blank
Include buildings?	manual	pick or leave blank
Include HVAC?	semi-automated	pick or leave blank
Include land?	fully automated	pick or leave blank
	For information: Component level	low cost

The input sheet includes an optional input for system automation. This input functions as discussed in Section 2.3, except as follows. Membrane systems are typically sold with automatic controls included, and the system automation input does not change the controls included in the membrane system itself. Instead, it controls the automation of the rest of the plant and the integration of the membrane system’s controls with the rest of the plant’s control system. If, for instance, the user selects manual controls, the model will include time required for an operator to operate pumps and valves for the pre-treatment and cleaning systems and manually record instrument readings. However, the model will also assume that automatic controls accompanying the membrane system actuate the valves found on the skids.

Since manual operation of a membrane facility is likely to be complex, the model assumes a fully automated system regardless of component level or system size. This approach differs from the default logic used in other WBS models and displayed in **Exhibit 2-7**. The model standard designs, therefore, always include the costs of fully automated system controls.

3.3 Model Assumptions Sheets

There are three sheets that contain assumptions needed to facilitate process design: the critical design assumptions sheet, the O&M assumptions sheet and the indirect assumptions sheet. These sheets contain a variety of structural and chemical engineering parameters used in the engineering design sheets.

There are more than 100 critical design assumptions in the model that cover process, O&M and indirect cost parameters. Key critical design assumptions include pre-treatment chemical dosages and characteristics, pre-treatment chemical storage, membrane fouling factor, interstage throttling and pressure boost, membrane life, cleaning frequency, cleaning chemical dosages, markup for rack assembly and bypass percentage. The following sections provide descriptions and default values for these assumptions. Any assumption value can be modified, as needed.

Pre-treatment Chemical Dosages and Characteristics

Antiscalant dosage depends on feed water quality and water chemical composition. The model computes an antiscalant dose in the feed water sufficient to provide 15 mg/L of antiscalant in the concentrate (Watson, 2002). This concentration is specified on the critical design assumptions sheet. To determine the antiscalant dose in the feed, the model multiplies the concentration by 1 minus the system’s recovery rate.

To calculate the quantity of chemicals consumed, the model also requires assumptions about the density of acid and antiscalant. The model assumes the use of commercially available 93 percent sulfuric acid or 28 percent hydrochloric acid, with densities of 14.19 pounds per gallon (lbs/gal) or 2.662 lbs/gal, respectively. It assumes the use of 50 percent sodium hydroxide, with a density

of 6.364 lbs/gal. The concentrations can be adjusted on the critical design assumptions sheet. Based on the concentrations, the model looks up the densities in the WBS cost database. The model assumes an antiscalant density of 10 lbs/gal.

Pre-treatment Chemical Storage

The quantity of pre-treatment chemicals stored on-site determines the size of pre-treatment chemical storage tanks and the initial quantity of pre-treatment chemicals purchased. According to U.S. EPA (2000), tanks are generally sized to hold approximately 30 days worth of chemicals, so the model uses this assumption to determine storage requirements.

Membrane Fouling Factor

The water permeability of a membrane element decreases as the membrane ages. The WBS model uses the permeability specified for new membrane elements, but includes a fouling factor to account for the decrease in permeability. For design purposes, the membrane's water permeability (its *A* value) is reduced according to this factor. The factor may be defined so that it is compounded each year, modeling decreases in permeability as the membrane element ages, or it may be defined so that it is applied only once during the design of a system. For simplicity, the fouling factor in the WBS model is applied only once.

By default, the fouling factor is 85 percent, indicating that the permeability will be reduced by 15 percent. Reducing this factor will allow for more fouling and will therefore increase the pressure required for a given flux and recovery.

Permeate Throttling and Interstage Boost

The train design sheet might determine that it is necessary to adjust the concentrate pressure between stages. There are two ways to adjust the pressure: by using booster pumps before later stages or by introducing a backpressure (throttle) on the permeate from earlier stages and correspondingly increasing the overall feed pressure. While booster pumps increase the system's footprint and capital cost, they are generally a more energy-efficient option than permeate throttling. Unless the throttle option is chosen on the Critical Design Assumptions sheet, the model assumes the use of booster pumps when pressure adjustment is necessary.

Membrane Life

The life of the membrane elements determines their replacement frequency, which the model uses to calculate operations and maintenance costs. According to the engineering experts who reviewed the critical design assumptions, most engineers use a 5 year life when preparing cost estimates, although actual life may be longer in practice. Consistent with this practice, the model assumes a 5 year life for RO and NF elements in most cases. However, the model assumes a 7 year life for high quality groundwater and a 3 year life for low quality surface water. Users can override these default values on the O&M assumptions sheet.

Cleaning Frequency and Capacity

Because membranes are subject to fouling, periodic cleaning of the membrane system is necessary. Indications that cleaning is necessary include: a pressure drop across the membrane, an increase in the feed pressure requirement or a significant decrease in the permeate flow. The

model incorporates a cleaning regime where acid wash is followed by a high-pH wash. Cleaning system design depends on several factors:

- Cleaning frequency (i.e., the number of months between cleanings)
- Cleaning cycle length (i.e., the number of days to complete the cleaning process).

In general, the cleaning frequency depends on the feed water quality and the system's flux rate. The WBS model permits the user to enter a cleaning interval directly in the input sheet, based on site-specific conditions. If no cleaning interval is specified there, the model uses the feed water's SDI as a proxy for the water quality and estimates a cleaning frequency with the following rule of thumb (Wolfe, 2004):

$$\text{Interval between cleanings (months)} = 12 - 4 * (\text{SDI} - 2)$$

When the feed water SDI is equal to 2, the model assumes 12 months between cleanings. When the SDI increases by one, the model reduces the cleaning interval by 4 months, to a minimum interval of 3 months. When the SDI decreases by one, the cleaning interval increases by 4 months, to a maximum interval of 18 months. The resulting cleaning frequencies agree with estimated cleaning intervals provided by membrane equipment manufacturers. The parameters for the cleaning interval estimate can be adjusted on the critical design assumptions sheet.

Cleaning Chemicals, Dosages and Equipment

Several different chemicals can be used in the cleaning process. Their dosages, along with cleaning frequency and membrane system volume, determine the quantity of chemicals consumed in the cleaning process. For the acid cleaning cycle, the model permits the use of citric acid, hydrochloric acid or a proprietary acidic cleaner indicated for sulfate and metal fouling. For the high-pH cycle the model permits the use of caustic soda alone or a high-pH detergent. The model assumes the use of proprietary acidic cleaner and a high-pH detergent (Dow, 2005).

The model assumes the use of separate equipment for the acid and caustic cycles of cleaning. If the user opts not to use an acid or caustic cleaning cycle, the model will adjust the amount of capital equipment in the cleaning system accordingly. For more information on cleaning equipment, see Section 3.9.

Markup for Assembly of Rack

The model estimates the cost for installation of the membrane system (assembly of the support) rack using a percentage, specified on the critical design assumptions sheet, times the capital cost of the membrane equipment, excluding elements and piping. The model assumes this installation markup is 100 percent.

Bypass Percentage

Because RO and NF can reduce TDS or hardness to very low levels, systems may choose to treat only a portion of their production flow when blending is allowed, using a smaller treatment system and blending treated water with raw water while still achieving treatment targets. The bypass percentage is that portion of production flow that goes untreated. If bypass is used, the model designs the treatment system to treat a flow equal to (100 minus bypass percentage) multiplied by design production flow and adds bypass piping and associated valves to the

components included on the output sheet. The RO/NF model also adds booster pumping for the bypass line when bypass is specified. The model assumes no bypass, but the user can incorporate bypass by entering a percentage of bypass flow on the critical design assumptions sheet.

3.4 Influent and Booster Pumping Sheet

The design of an influent pumping system is determined by the peak influent flow along with the specific pumping head and pressure required for RO/NF treatment. The influent and booster pumping sheet assumes as many influent pumps as required to handle the total feed flow into the RO/NF process trains, without going above a maximum flow per pump, specified on the critical design assumptions sheet. The pump number is determined by the number of pumps designed for meeting the average flow rate necessary to operate at the maximum flow rate. The model assumes no redundant pumps by default on the Critical Design Sheet. If a bypass percentage is specified on the critical design assumptions sheet, this sheet also performs the required calculations for the bypass pumps.

To determine the size of each pump, this sheet calculates the influent flow based on production flow and recovery rate as specified on the input sheet. The sheet then increases this flow by a safety factor specified on the critical design assumptions sheet and splits it among the operational pumps. Finally, it computes the horsepower needed for each pump.

The model determines the costs of the appropriate horizontal split-case pumps based on the required pressure and flow. It uses the horsepower to determine the pump footprint, by looking up the required areas for pumping and electrical equipment in the WBS cost database. If booster pumps are required, the model determines their size and energy requirements using the same method as for the influent pumps.

3.5 Pre-treatment Sheet

As discussed above, RO/NF systems require pre-treatment facilities. For groundwater treatment, pre-treatment typically includes filtration and chemical conditioning of the feed water. Surface water requires further pre-treatment, possibly including lime softening, media filtration, low-pressure membrane filtration or dissolved air flotation. As discussed above, these latter potential pre-treatment steps are not included in the WBS model for RO/NF.

Cartridge filtration protects the membranes by removing large particles. The cartridge filters are installed between the pretreatment system and the feed water pumps. For systems with production flows below 1 MGD, the model uses one cartridge filter. From 1 to 5 MGD, the model uses two cartridge filters. Above 5 MGD, the model will use one cartridge filter for every 5 MGD of design flow. In addition, the model includes one standby cartridge filter for systems with design flows up to 50 MGD or two standby filters for plants with design flows of 50 MGD and above. Users can adjust these assumptions on the critical design assumptions sheet. The unit capital costs for the cartridge filters are based on manufacturer's quotes and vary based on the flow per filter. Each filter can contain multiple cartridges.

Addition of acid and antiscalant also can be necessary in a pre-treatment system, and the model includes inputs to control whether these steps are included in the cost estimate. The pre-treatment sheet determines acid and antiscalant doses based on the objectives set in the input and critical

design assumptions sheets, as described above. Equipment required for the acid and antiscalant chemical systems includes the following:

- Tanks for acid storage
- Tanks for antiscalant storage
- Metering pumps for each chemical.

The model assumes separate day tanks, in addition to the primary bulk storage tanks, are required for each chemical if daily chemical usage at design production flow exceeds a number of gallons specified on the critical design assumptions sheet. To provide secondary containment for the pre-treatment chemical tanks, this sheet also includes calculations for concrete curbing around the storage area and chemical resistant coating for the curbing and the underlying concrete pad.

3.6 Feed Water Sheet

The feed water sheet determines the ion concentrations in the feed water, based on the analysis of the feed water selected by the user. Given the ion concentrations and pH listed for the selected feed water, the sheet computes the concentrations of carbonate ions and of carbon dioxide and makes sure the anions and cations in the water are balanced. The model then computes the LSI and the saturation percentages of SiO_2 , CaSO_4 and CaF_2 in the feed water, for display on the input sheet. The methods used to compute these quantities come from the Total Flux and Scaling Program (TFSP), developed by PerLorica, Inc. for EPA.

If the user specifies acid addition, the feed water sheet determines the concentrations of carbonate ions and carbon dioxide for the adjusted feed pH. It then determines the required addition of chloride or sulfate ions by requiring that the treated feed be charge-balanced and determines the required dose of hydrochloric or sulfuric acid in commercial concentration to achieve the target pH.

Finally, the sheet assembles a water analysis (viscosity and ionic concentrations) for the treated feed and determines scaling quantities, as above. The water analysis is passed to the train design sheet.

3.7 Train Design Sheets

3.7.1 Overview

The RO/NF model determines a train design based on the feed water, membrane element and flux and recovery targets set on the input sheet. It operates as follows:

Based on the flux and recovery targets, the model determines how many total membrane elements are needed and how they should be assembled into a train (that is, how many stages to use, how many elements to include in a pressure vessel and how many pressure vessels to use in each stage). These results determine most of the capital cost of the membrane system, except for possible costs associated with booster pumps or permeate throttle valves. These computations take place on the train design sheet, based on additional calculations that cover three additional sheets.

Based on the feed water analysis and membrane element parameters, the model determines what feed pressure is required to achieve the target recovery, thereby establishing pumping energy requirements. If necessary, the model will include booster pumps or permeate throttle valves in this step.

The model uses an iterative procedure to choose the feed pressure. Starting from a pressure guess, it determines whether the membrane system would operate within specs and computes the amount of permeate produced. It then modifies the pressure guess if it finds off-spec operation or if the resulting permeate production is too high or too low. The iteration continues until the model finds a feed pressure and interstage pressure adjustments that will yield the desired permeate flow.

These computations take place on the pressure tuning sheet. They are controlled by a Visual Basic macro, which runs automatically when the user presses the “Generate Results” button on the input sheet.

To perform each iteration on the pressure tuning sheet, the model does a detailed, element-by-element simulation of the membrane system. The simulation iteratively determines concentrate and permeate flows and ion passages, based on the selected membrane element parameters and feed water analysis. All calculations take place on the calc system sheet and calc one element sheets. The iteration is controlled by a set of Visual Basic macros, which are run automatically from the pressure tuning macro.

Thus, the train design process includes the four sheets labeled train design, pressure tuning, calc system and calc one element. The following subsections describe how each sheet operates.

3.7.2 Train Design Sheet

The train design sheet uses the required flux and recovery to assemble a train configuration (number of stages, number of elements per pressure vessel and the number of pressure vessels in each stage). It also makes a first guess for the required feed pressure, which is used as an input to the pressure tuning routine. The sheet uses a modified version of the design procedure outlined in the Dow Filmtec technical manual (Dow, 2005).

The sheet starts by determining how many elements to use in series across all stages of the system. It first computes the average recovery desired in each element, by taking 70 percent of the maximum recovery specified for the element. (Users can adjust the fraction of the maximum recovery on the critical design assumptions sheet.) The system recovery Y_s is equal to

$$Y_s = 1 - (1 - Y_{e,avg})^{N_e},$$

where $Y_{e,avg}$ is the average recovery per element, and N_e is the number of elements in series. Therefore,

$$N_e = \frac{\ln(1-Y_s)}{\ln(1-Y_e)}$$

If the number of elements in series is less than 7, the model uses a single stage with the required number of elements in each pressure vessel. If the number is greater than 7, it will use multiple

stages. It will use no fewer than 6 elements per vessel in this case and will choose the number of elements per vessel and number of stages to come as close as possible to the desired number of elements in series.

Users can adjust the minimum and maximum number of elements per vessel on the critical design assumptions sheet. In particular, users who want designs with no more than 6 elements per pressure vessel may change the assumption *el_per_vess_max_8* to 6. Elements with a diameter of 16 to 18 inches use different assumptions, with a minimum of 4 elements per vessel in multi-stage systems and a maximum of 5 elements per vessel.

The train design sheet then determines the ratio of pressure vessels in each stage. It attempts to design the system so that the recovery can be the same in each stage. It follows (Dow, 2005) that the ideal ratio of pressure vessels from one stage to the next is equal to

$$R = (1 - Y_s)^{-1/n},$$

where R is the staging ratio, and n is the number of stages.

Based on the target flux and the membrane area in each element, the sheet determines the total number of membrane elements and pressure vessels required. It arranges them in stages according to the staging ratio it computes. It estimates the flow through each stage by assuming a constant recovery in each element. Based on these flows, it uses membrane element specifications such as the maximum recovery per element, maximum pressure drops, maximum feed flow and minimum concentrate flow to constrain the number of vessels in each stage. (Note that the flows are computed in detail later in the train design sheet; the flow estimate is used only to adjust the train design.)

Finally, the sheet assembles a first guess for the feed pressure. It estimates the net driving pressure, based on the target flux and an estimated A -value for the membrane; the average osmotic pressure, based on the feed osmotic pressure, the target recovery and with an assumption of 100 percent salt rejection; and the pressure drop in the system, using the flow estimate described above. The feed pressure guess is the sum of these:

$$P_{guess} = P_{net,guess} + \pi_{guess} + \delta P_{guess}/2.$$

3.7.3 Pressure Tuning Sheet

The pressure tuning sheet, along with a set of Excel macros, refines the first pressure guess until it finds a feed pressure that will achieve the required flow of product water. It will adjust pressure in the later stages if necessary. It uses the following steps:

- Load the pressure guess from the previous iteration or from the train design sheet on the first iteration.
- Determine the flow and quality of the resulting permeate water or whether the pressure guess would result in off-spec operation of the membranes. This step takes place largely on the calc system and calc one element sheets.

- If the pressure guess results in off-spec operation, adjust the pressure to bring operation within spec. The correction is estimated on the calc one element sheet.
- If the pressure guess results in a flux imbalance between stages, adjust the pressures to rectify the imbalance. The model will adjust the pressures if the flux in any stage is more than 25 percent greater than the required average flux. For the first stage, the model will adjust the pressures if the flux is lower than the average flux for the entire system. For later stages, it will adjust pressures if the flux is more than 25 percent lower than the required average flux. Users can adjust these parameters on the critical design assumptions sheet.
- If the elements are operating within spec and the flux is sufficiently balanced, the model compares the resulting permeate flow with the required flow. It then adjusts the pressure proportionately to the required change in the flow.
- The sheet stops iterating when the permeate flow is within 0.5 percent or 500 gallons per day (gal/day) of the required permeate flow or after 20 iterations. Users can also adjust these parameters on the critical design assumptions sheet.

3.7.4 Calc System and Calc One Element Sheets

For each pressure guess, the model determines the resulting product water as follows:

- Load the inputs collected in the calc system sheet.
- Copy the element parameters into the calc one element sheet.
- Copy the initial feed water parameters into the calc one element sheet.
- At the beginning of a stage, copy the throttle and boost pressures into the calc one element sheet, as required.
- Simulate the performance of the first element. This calculation is described below.
- If the calculation of the element's performance results in an error, the calculation stops.
- Copy the results from the first element into the calc system sheet.
- Take the ion concentrations from the first element and copy them into the feed concentrations for the second element.
- Repeat the previous four steps for each element in the first stage, up to the number of elements per pressure vessel specified on the input sheet.
- Compute the recovery and other quantities for the entire first stage. These quantities are described below.
- The process repeats for the second and third stages, if the train design sheet determined that later stages are necessary.

Input Collection

At the top of the calc system sheet, the model displays the detailed parameters for the membrane element chosen on the input sheet. Beneath them are two inputs that control the iteration process for a membrane element. It should not be necessary to change these values.

Detailed Output

The system outputs are largely the same as those summarized on the input sheet. Other system outputs here include the concentrate flow, TDS and the concentration of each ion in the permeate water.

The outputs per stage include flows, recovery and permeate and concentrate TDS for each stage. In this section, the information on recovery applies only to the given stage. For instance, a system might have 48 percent recovery in the first stage and 35 percent recovery in the second stage, for a total recovery of 66 percent. Likewise, the information on TDS applies only to the given stage. For example, a system might have TDS of 19 in the product water from the first stage and 61 in the product water from the second stage, for a final TDS of 31.

The outputs per element consist of a detailed table of results for each element in the train, including flows, pressures and water analyses. More information on these results follows below.

Element Calculations

The detailed calculation of flow for each element takes place on the calc one element sheet. This sheet contains data for only one element at a time; the data is loaded by the train design macro, as described above. At the top of the sheet are the inputs, describing the selected membrane element, the water fed into the element and the feed flow and pressure. A user may, if he or she wishes, enter values into the bold gold cells by hand and then press the “Solve Element” button to see the computation of the recovery and salt passage for the element. Changing values on this sheet will not affect the cost estimate on the output sheet.

The element calculation computes the recovery and salt passage by determining the net driving pressure and the membrane's A (water permeability) and B (salt permeability) values. The net driving pressure depends on the osmotic pressure on the concentrate side of the membrane, as well as on the feed pressure drop. The pressure drop, in turn, depends on the average of the feed and concentrate flows. The A and B values also depend on the ions present in the feed and concentrate water. A guess for the net driving pressure and the A and B values allows the model to compute the water and salt passage for the membrane. The water and salt passage, in turn, allow the model to compute the flow and ion concentrations on the concentrate side of the membrane, which are used to recompute the net driving pressure and A and B values. The sheet aims to find self-consistent values of the net driving pressure and of A and B . It proceeds as follows:

- Convert the inputs into standard units and convert feed ion concentrations into milliequivalents per liter.
- Corrects A and B for the temperature of the feed water and for the feed pressure.
- Establish first guesses for A and B , based on the osmotic pressure and TDS of the feed water.
- Establish a first guess for the net driving pressure, based on the feed water and the salt passage as determined by A and B
- Compute permeate and concentrate flows.
- Compute the concentration polarization, based on recovery.
- Compute the passage of each ion into the permeate, making sure the ions are balanced.

- Based on the ions in the permeate, determine the ions in the concentrate.
- Compute the osmotic pressure difference between the permeate and concentrate.
- Compute the pressure drop in the vessel, based on the feed and concentrate flows and viscosities.
- Recompute the net driving pressure, based on the osmotic pressures and the pressure drop.
- Recompute A and B , based on the osmotic pressure and TDS in the brine, respectively.
- Compare net driving pressure, A and B to their values at the beginning of this iteration. If they all agree within the tolerance specified on the system calculation sheet (0.01 percent, by default), the computation is complete. If not, the new values are used to drive another iteration. The model will perform up to 100 iterations.

On each iteration, the model corrects A and B to account for the effect of applied pressure, feed osmotic pressure, feed salinity and temperature. The correction factors for A are as follows:

- Temperature correction factor,

$$\exp [K_{AT}(\frac{1}{T_{ref}} - \frac{1}{T})],$$

where k_{AT} and T_{ref} are specified for each membrane element. The model includes two values of k_{AT} for each element, one used when $T > T_{ref}$ and one used when $T < T_{ref}$. For some elements, these values are equal.

- Applied pressure correction factor,

$$1 - k_{AP}(P_{feed} - P_{throttle}),$$

where k_{AP} is specified for each membrane element.

- Osmotic pressure correction factor,

$$1 - k_{A\pi}\pi,$$

where $k_{A\pi}$ is specified for each membrane element, and π is the average osmotic pressure on the feed side of the membrane.

Each correction factor is computed and applied to A independently of the others.

The correction factors for B are as follows:

- Temperature correction factor,

$$\exp [K_{BT}(\frac{1}{T_{ref}} - \frac{1}{T})],$$

where k_{BT} and T_{ref} are specified for each membrane element. The model includes one temperature coefficient for B .

- Salinity correction factor,

$$1 + k_{BS}|TDS - TDS_{min B}|,$$

where TDS is the average TDS on the feed side of the membrane, and the vertical bars denote absolute value (so that the factor is always greater than or equal to 1).

The B value of a membrane tends to be large at very low TDS, decrease to some minimum value, and then increase again (Franks, 2005; Wolfe, 2006). For each element, the model includes the

minimum B value and the $TDS_{\min B}$ at which it occurs. It also includes two values of the slope k_{BS} , one for use when $TDS < TDS_{\min B}$ and one for use when $TDS > TDS_{\min B}$. Finally, the salinity correction factor will not increase above a maximum value, also tabulated for each element.

The correction factors are computed and applied to B independently of one another.

The model computes the pressure drop in each membrane element according to a power law with a correction for viscosity,

$$\delta P = k_p Q^\alpha (\mu / \mu_{ref})^{1/2},$$

where Q is the average of the feed flow into the element and the concentrate flow out of it, μ is the average viscosity of the feed water (computed from the temperature and TDS), and μ_{ref} is the viscosity for the element's reference temperature and TDS. The coefficient k_p , exponent α , and reference temperature and TDS are specified for each element.

After the train design macro runs, the model displays the computation for the last element in the last stage of the system on the calc one element sheet. To view the computation for a different element in the train, go to the train design sheet and select the cell containing the code for the selected element. The codes are located at the top of the element output table. For instance, the code for the fourth element in stage 1 is *el_1_4*. After selecting the code, press the button labeled "Load Element Data." The model will load the data for that element onto the element calculation sheet and then will redo the calculation for that element.

3.8 Membrane Capital Sheet

The membrane capital sheet uses the results of the train design (see Section 3.7) to determine how many membrane racks are required. The model assumes that each rack operates as a separate process train. Racks are built in various sizes to house multiple pairs of pressure vessels, and the size of a rack for a particular flow train will vary with flow rate, water quality, target recovery, membrane element size and even design feed water temperature. The number of racks affects cleaning requirements, the footprint required for membrane equipment, flow rates and pipe sizes to and from each rack and instrumentation requirements.

The model first adds redundant pressure vessels, if redundancy is specified on the input sheet. By default, it adds one redundant vessel for every ten operating vessels; users can adjust this redundancy frequency on the critical design assumptions sheet.

The critical design assumptions sheet specifies the maximum permeate flow rate per rack, based on the membrane element sizes (4-inch, 8-inch or 16-18-inch). The total number of racks is determined by dividing the design permeate flow rate by the maximum permeate flow rate per rack.

The cost of the RO/NF membrane system is determined for a package, including racks, pressure vessels, membrane elements, valves and piping on the racks and controls for the equipment on the rack. (Note that the membrane system component cost includes a concentrate control valve, which is displayed in **Exhibit 3-2** because of its importance in process control.) The cost is based on quotes from membrane system integrators and is parameterized in terms of the total

membrane area supported. The costs do not include pumps, instruments or ancillary equipment such as cleaning and pre-treatment equipment; costs for these items are included separately on the output sheet.

The capital cost of the initial set of membrane elements is included in the membrane system cost. However, the membrane capital sheet also determines a replacement cost for membrane elements. The replacement cost is based on a cost per unit area tabulated in the centralized cost database and the area for each element tabulated on the membrane specs sheet (see Section 3.16).

3.9 Cleaning Sheet

The membranes need to be cleaned when, for example, the pressure drop across the membrane increases, feed pressure requirements increase or product flow decreases beyond desirable points or fouling or scaling is evident. Chemical cleaning for RO/NF systems may consist of cycles of acid washing, caustic washing or washing with other chemicals; each cycle typically includes a soak, a period of high-flow pumping of cleaning solution through the element, a flush with permeate water and a period of filtering feed water to waste to ensure that the membranes are performing as desired (Dow, 2005). The WBS model assumes that cleaning consists of an acid cycle and a caustic cycle. The cleaning frequency is determined as described in Sections 3.2 and 3.3.

Exhibit 3-2, above, includes the layout of a typical chemical cleaning system for RO. The cleaning equipment includes the following for each chemical:

- Tanks
- Heaters
- Cleaning pumps
- 100-mesh security screens to protect the pumps
- Cartridge filters to protect the membrane elements
- Associated valves and controls.

Typically, one stage of a multi-stage membrane system is cleaned at a time. The model therefore assumes that the cleaning system is sized to wash all the first-stage pressure vessels on a single rack. It sizes the tanks to accommodate a volume of cleaning solution equal to the total volume of the vessels to be washed, plus an allowance of 5 percent for the volume of piping between the cleaning system and the membrane rack. Pumps, screens and filters are sized for the high-rate flow phase (specified on the critical design assumptions sheet); the flow is determined based on the membrane element diameter.

The model sizes immersion heaters to heat the cleaning solution to 95 degrees in five hours, starting at the feed water temperature. It uses the following rule of thumb (Cole-Parmer, 2006) to determine the required heater power:

$$Power = \frac{V \times \Delta T}{325 \times t}$$

where the tank volume V is in gallons, the temperature increase ΔT is in degrees Fahrenheit, and the heat-up time t is in hours.

Most facilities will include only one cleaning system, with some redundant equipment. Very large facilities may need to perform simultaneous cleanings, depending on the number of racks, the cleaning interval and the amount of time each rack is offline for cleaning. The model assumes that each rack will be offline for two days to be cleaned and includes an additional cleaning system if simultaneous cleanings are possible.

Finally, the model determines the cleaning chemical quantities (citric acid, hydrochloric acid, caustic soda or proprietary cleaners) used for each cleaning, how much of each chemical must be stored and the annual use of each cleaning chemical. If it is necessary to store more than a minimum number of gallons (specified on the critical design assumptions sheet) of a cleaning chemical, the model includes a storage tank in the cost buildup. To provide secondary containment for the cleaning chemical storage tanks, this sheet also includes calculations for concrete curbing around the storage area and chemical resistant coating for the curbing and the underlying concrete pad.

3.10 Pipes and Structure Sheet

The pipes and structure sheet performs calculations for the following pipes:

- Influent and treated water piping
- Feed piping
- Permeate piping
- Concentrate piping
- Cleaning system piping
- Bypass piping.

Calculations for the concentrate and residuals piping are covered on the residual management sheet.

The size (diameter) of pipes is determined using a pipe flow look-up table that is part of the WBS cost database. The pipe diameter selection method incorporates a reasonable head loss and flow velocity, as documented in **Exhibit 2-8**. These design assumptions may result in some oversizing of pipes, which means the costs for pipes may be conservative (i.e., err on the high side).

The flow used to determine influent and treated water pipe size is the design flow. The diameter of interconnecting feed piping uses the same pipe flow chart, after splitting the inflow by the number of skids; the diameter of permeate piping is determined by splitting the permeate flow by the number of skids. Cleaning system piping is sized for the high-rate flow phase of cleaning, using the same table. A similar approach is used in determining the size and capacity of bypass piping. Except for cleaning system piping, the length of these pipes is determined using the assumptions documented in **Exhibit 2-10**, which are designed to account for the cost of fittings. For cleaning system piping, the model uses a length equal to the overall system building layout length.

This sheet also calculates the housing area for RO/NF based on the footprint of the technology components footprint and the spacing criteria specified on the critical design assumption sheet. The space requirements for pumps, tanks, screens, filters and service space are based on manufacturer specification, “to scale” drawings and the experience of engineers. The amount of

additional concrete needed to support heavy equipment, such as pumps and vessels, is calculated using the footprint of the vessels and pumps.

Square footage assumptions specified on the critical design assumptions sheet determine how many buildings are required. For smaller space requirements, the model assumes a single building containing all process equipment. For medium requirements, the model assumes two buildings, one containing influent pumping and pre-treatment equipment and one containing membrane equipment, cleaning systems and residuals management equipment. For larger requirements, the model assumes three buildings, one containing influent pumping equipment, one containing pre-treatment equipment and one containing membrane equipment, cleaning systems and residuals management equipment. The number of buildings affects the total land required and energy costs for heating, ventilating and cooling.

3.11 Instrumentation and Control Sheet

Controls for the valves on the membrane skids are integrated into the membrane system component; unit costs in the WBS cost database include these controls. Therefore, the instrumentation and control sheet calculates the incremental requirements for valves, instrumentation (e.g., flow meters) and automated system controls that are external to the skids. These include instrumentation and controls associated with pumps, pre-treatment and cleaning and valves and controls associated with external piping. The number of valves and instruments is based on the number of process components (e.g., number of feed water pumps) and assumptions from the critical design assumptions sheet (e.g., number of valves per feed pump). The assumptions correspond to the general schematic layout for this technology shown in **Exhibit 3-2**. Sizing of valves corresponds to the size of the appropriate pipe determined on the pipes and structure sheet, except for the sizing of permeate throttle valves; these valves are sized according to the flow rate from one skid due to their stage. Appendix A describes the method used in the WBS models to estimate the number and type of system control components.

3.12 Residuals Management Sheet

The residuals management sheet estimates the volume and mass of residuals, their characteristics and the capital and O&M requirements for residuals management, based on the management options selected on the input sheet and the approach outlined in Appendix C. Depending on the management options chosen, specific items of capital equipment for residuals may include:

- Holding tanks, basins or lagoons
- Pumps
- Evaporation ponds (including excavation and lining)
- Deep injection wells (with costs determined as outlined in Section 3.2)
- Valves, piping and instrumentation.

Specific O&M requirements associated with residuals may include:

- Residuals pump materials and energy⁹
- POTW discharge fees

⁹ Labor associated with residuals pumps is calculated on the O&M sheet.

- Membrane concentrate transportation and disposal costs (when hazardous waste disposal is required)
- Used cartridge filter and membrane element transportation and disposal costs
- Holding tank or evaporation pond solids transportation and disposal costs.

As discussed in Section 3.2, although the option for concentrate recycling is among those available on the input sheet, calculations for this option are not currently implemented in the model. This option would be for regions where high overall recoveries are necessary to meet water demands.

3.13 O&M and HVAC Sheets

The O&M and heating, ventilating and air conditioning (HVAC) calculations cover two sheets: the O&M sheet (annual labor, materials and energy usage) and the HVAC sheet (HVAC capacity requirements). The O&M sheet derives annual O&M requirements for RO/NF treatment based on the engineering design, O&M critical design assumptions and input values. It determines the following O&M requirements based on the approach outlined in Section 2.4 and Appendix E:

- Operator labor for system operation and maintenance
- Managerial and clerical labor
- Influent and booster pump maintenance materials and operating energy
- Building and HVAC maintenance materials
- Energy for building lighting and HVAC.

In addition, the sheet adds the following technology-specific O&M requirements:

- Labor for pre-treatment, the membrane process system and cleaning
- Maintenance materials for pre-treatment, membrane process and cleaning equipment
- Replacement cartridge filters and membrane elements (note that disposal of these items is calculated on the residuals management sheet)
- Chemical usage (acid and antiscalant for pre-treatment and hydrochloric acid and caustic for cleaning)
- Maintenance labor and materials and operating energy for bypass booster pumps (if bypass is specified).

The sheet determines labor for pre-treatment and cleaning systems based on the quantity of equipment specified. It assumes 12 hours of labor per cartridge filter per year. For simplex basket screens (up to 400 gpm), it assumes 30 minutes of labor per cleaning cycle per screen, to clean the strainer basket. For automatic self-cleaning prescreens, it assumes 12 hours of labor per screen per year. Users can change any of these unit labor hours on the O&M assumptions sheet. The labor associated with cleaning pumps is computed using the approach discussed in Appendix E.

For other membrane process labor, the model uses a table of estimates provided by a membrane manufacturer, ranging from 4 hours per week for a 30,000 gal/day system to 200 hours per week for a 75 MGD system. The table is located on the lookup tables sheet (see Section 3.16).

The sheet calculates maintenance material costs as a percentage of pre-installation capital costs. For materials for pre-treatment and cleaning, the sheet uses the same percentage as for influent and booster pumps (1 percent). For the membrane process, it also uses 1 percent of pre-installation capital costs. Users can change either of these percentages on the O&M assumptions sheet. Replacement requirements for cartridge filters and membrane elements are calculated explicitly using the respective useful life assumptions specified on the O&M assumptions sheet (5 months for cartridge filters and 4 or 5 years for membrane elements). For these components, the model looks up a quantity discount, based on typical discounts offered by membrane element distributors. The discount is tabulated on the lookup tables sheet (see Section 3.16).

Chemical usage also is calculated explicitly using the appropriate dosages and the average inflow (for pre-treatment chemicals) or the cleaning frequency (for cleaning chemicals).

3.14 Indirect Sheet

As stated in Section 2.4, indirect capital costs are costs that are not directly related to the treatment technology used or the amount or quality of the finished water, but that are associated with the construction and installation of a treatment technology and water intake structures. The indirect sheet derives capital costs for the following components of indirect costs:

- Construction management and general contractor overhead
- Standby power
- Geotechnical
- Sitework
- Yard piping.

Appendix D contains detailed information on the derivation of these and other indirect costs. This sheet also contains calculations to estimate permit costs.

3.15 Output Sheet

The output sheet contains the list of components identified for RO/NF treatment based on the WBS approach. For each component, the output sheet provides information on size (e.g., tank capacity or pipe diameter) and quantity, as well as estimated capital cost and estimated useful life. The output sheet also contains cost estimates for indirect costs (e.g., mobilization and demobilization, site work and yard piping), add-on costs (for permitting, pilot testing and land) and O&M costs. These estimates are described generally in Section 2.4 and in more detail in Appendix D (indirect costs) and Appendix E (O&M costs). Finally, the output sheet combines the total capital cost, system useful life and annual O&M cost to estimate total annualized cost, as discussed in Section 2.4. Sections 2.1 and 2.3 provide further details about the output sheet.

As discussed in Section 2.4, the output sheet shows model results to the nearest \$1, but this precision is not meant to imply that the results are accurate to \$1. The RO/NF model underwent peer review in 2007. The majority of peer reviewers who evaluated the model expressed the opinion that resulting cost estimates would be in the range of budget estimates (+30 to -15 percent). The RO/NF model has since undergone substantial revision in response to the peer review comments. Users are encouraged to review all documentation, modify inputs and

assumptions as appropriate to their specific purpose, and form their own informed opinions about the accuracy and suitability of the results shown on the output sheet.

3.16 Ancillary Model Components

The RO/NF model contains six ancillary sheets: unit conversion factors, membrane specifications, feed water specifications, concentrate scaling recommendations, cost equations and lookup tables.

The conversion factors are used to convert input units to metric units for the train design process and to convert the design results back to input units.

The feed water specifications include the name and water analysis for each feed water. The water names are displayed in the feed water dropdown on the input sheet. The feed water analysis includes calcium, magnesium, sodium, potassium, bicarbonate, chlorine, sulfate and fluorine ion concentrations in parts per million. The silica concentration, pH and silt density index are also included in the water analysis. The specification table displays the TDS of each water, as the sum of the listed ions.

The membrane specifications include the manufacturer and name of each available membrane element, as well as information that the train design process uses to simulate the membrane's performance. The various specifications are discussed in Section 3.7. The membrane specifications in the model were obtained from a study of specification sheets for various elements and from a study of the how various manufacturer RO design programs model membrane elements. It is possible for users to add a custom element by pressing the button labeled "Add New Element" and filling in the required membrane parameters. The bottom row of the table contains the element names that appear in the input dropdown. It will likely be useful to copy the parameters from an element that already appears in the model and modify them as needed.

The concentrate scaling sheet examines the LSI and other saturation fractions. It determines whether any saturation is great enough to require the use of antiscalant, or whether saturation is so great that an antiscalant is likely to be ineffective. The input sheet uses its results to display guidance and warnings. Otherwise, it does not affect the engineering design.

The cost equations sheet uses the component-level cost curve equations from the WBS cost database to generate unit costs on an item-by-item basis.

The lookup tables sheet contains information used to calculate purchase discounts for pumps and filters. It also contains information such as charge and molecular weight for the ions in the solute and a table used to determine the ratio of pressure vessels from one stage of a train to the next.

3.17 List of Abbreviations and Symbols in this Chapter

BaSO ₄	barium sulfate
CaCO ₃	calcium carbonate
CaF ₂	calcium fluoride
CaSO ₄	calcium sulfate
DBP	disinfection byproduct

EPA	U.S. Environmental Protection Agency
gal/day	gallons per day
gfd	gallons per square foot per day
gpm	gallons per minute
HVAC	heating, ventilation and air conditioning
lbs/gal	pounds per gallon
LSI	Langelier saturation index
MGD	million gallons per day
mg/L	milligrams per liter
NF	nanofiltration
O&M	operating and maintenance
POTW	publicly owned treatment works
psi	pounds per square inch
RO	reverse osmosis
SDI	silt density index
SiO ₂	silica
SrSO ₄	strontium sulfate
TDS	total dissolved solids
TFC	thin-film composite
TFSP	Total Flux and Scaling Program
WBS	work breakdown structure

3.18 References

AWWA, 1990. American Water Works Association. *Water Quality and Treatment: A Handbook of Community Water Supplies*, 4th edition. New York: McGraw-Hill.

AWWA, 1999. American Water Works Association. *Water Quality and Treatment: A Handbook of Community Water Supplies*, 5th edition. New York: McGraw-Hill.

AWWA/ASCE, 2005. American Water Works Association and American Society of Civil Engineers. *Water Treatment Plant Design*, 4th edition. New York: McGraw-Hill.

AWWARF, 1995. AWWA Research Foundation. Application of Membrane Filtration Techniques for Compliance with the Surface Water and Groundwater Treatment Rules. October 1995.

AWWARF, 1996. AWWA Research Foundation. *Water Treatment Membrane Processes*.

Burbano et al., 2006. Burbano, Arturo, Adham, Samer (MWH) and Pearce, William (City of San Diego). "Current Trends on Membrane-Based Desalination: Findings from a Worldwide Survey of Full-Scale RO/NF Plants." Included in the Proceedings of the 2006 AWWA Annual Conference and Exposition, June 11-15, 2006, San Antonio, Texas.

Cole-Parmer, 2006. Cole-Parmer Catalog, page 673. Retrieved from http://www.coleparmer.com/catalog/vcatalog_welcome.asp?from=cwelcom, June 2006.

- Dow, 2005. Dow Liquid Separations FILMTEC Reverse Osmosis Membranes Technical Manual, July 2005, The Dow Chemical Company. Retrieved from <http://www.dow.com/liquidseps/lit/techman.htm>.
- Franks et al, 2005. Franks, Rich N., Bartels, Craig and Wilf, Mark (Hydranautics, Inc.). “The Effect of Feed Salinity on RO Membrane Salt Passage.” Included in the Proceedings of the 2005 AWWA Membrane Technology Conference, March 6-9, 2005, Phoenix, Arizona.
- Freeman and Randtke, 2006. Freeman, Scott (Black and Veatch) and Randtke, Steve (University of Kansas). Presentation at the workshop “RO and NF Design – Computer Modeling,” at the 2006 AWWA Annual Conference and Exposition, June 11, 2006, San Antonio, Texas.
- Jacangelo, J., S. Chellam and R.R. Trussell. 1998. “The Membrane Treatment.” *Civil Engineering*.
- Mickley, 2006. *Membrane Concentrate Disposal: Practices and Regulation*. Mickley and Associates for U.S. Bureau of Reclamation, Desalination and Water Purification Research and Development Program Report No. 123 (Second Edition), April 2006
- Small Business Advocacy Review Panel, 1999. Report of the Small Business Advocacy Review Panel on EPA’s Planned Proposal of the National Primary Drinking Water Regulation for Arsenic.
- U.S. EPA. 2004a. *Estimating the Value of Land for Use in Drinking Water Cost Models*. Report prepared by Science Applications International Corporation. Washington, D.C.: U.S. Environmental Protection Agency, Office of Groundwater and Drinking Water.
- U.S. EPA. 2004b. *Evaluating Permit Requirements for Inclusion in Drinking Water Cost Models*. Report prepared by Science Applications International Corporation. Washington, D.C.: U.S. Environmental Protection Agency, Office of Groundwater and Drinking Water.
- U.S. EPA. 2011. *Pilot and Bench Study Costs for Drinking Water Rules*. Report prepared by Science Applications International Corporation. Washington, D.C.: U.S. Environmental Protection Agency, Office of Groundwater and Drinking Water.
- Watson, 2002. Watson, Ian (AEPI-RosTek). Review of critical design assumptions, October 2002.
- Wolfe, 2004. Wolfe, Thomas (WaterEye Corp.). Personal communication, November, 2004.
- Wolfe, 2006. Wolfe, Thomas (WaterEye Corp.). Presentation at the workshop “RO and NF Design – Computer Modeling,” at the 2006 AWWA Annual Conference and Exposition, June 11, 2006, San Antonio, Texas.

Appendix A. Valves, Instrumentation and System Controls

A.1 Valves in the WBS Models

There are many types of valves used to control water and chemical flow rates, pressure and direction in a water treatment plant. Valves can be distinguished by function, mode of operation, materials of construction, size (i.e., diameter), design or shape and connection method. For purposes of estimating valve costs, the most important of these distinctions are function, mode of operation, size and materials of construction. Therefore, the work breakdown structure (WBS) models group valves according to these four distinctions. The WBS models identify valve size explicitly, using the same methodology used to size pipes. The WBS models also explicitly identify materials of construction. The output sheet of each model includes line item costs for valves of each material (plastic, stainless steel and cast iron), so that the user can observe variations in cost among materials.

To distinguish by function and mode of operation, the WBS models use a generic nomenclature. The WBS models identify valves as one of the following:

- Check valves
- Manual valves
- Motor/air-operated valves.

Check valves are those that serve the function of backflow prevention. They generally do not vary significantly in mode of operation or design/shape.

The other two categories of valves serve the function of flow control and are distinguished by their mode of operation (i.e., whether they are manual or automated). An example of a valve that must be a manual valve is an emergency shut-off valve that, in an extreme event such as complete power failure, can be shut off by an operator. Manual valves can vary in design according to their specific opening/closing method (e.g., hand wheel or chain). Automated valves (identified in the WBS models as motor/air operated) can be motor-operated valves, air-operated valves or solenoid valves. Solenoid valves are electrically operated on/off control valves. Motor-operated valves open and close more slowly than solenoid valves. This action reduces likelihood of a water hammer. While the different opening/closing methods for manual and automated valves have various advantages and disadvantages, cost differences among designs are relatively small and the WBS unit costs do not distinguish between them at this level of detail. The key cost difference is whether the valves are automated or manual, because of the cost of the motor, air actuator or solenoid.

A.2 Instrumentation for Process Measurements

Each of the models includes the cost of various instruments that perform process measurements. Most of these measurement devices are categorized into the following groups:

- *Hydraulic measurement instruments and control devices.* Hydraulic measurement instruments include: flow meters, pressure gauges, head loss sensors and water level meters/alarms. Hydraulic control devices include: pump control, motor control and valve control.

- *Water quality measurement and control devices.* These include water quality parameter measurement devices, such as pH meters, oxidation-reduction potential (ORP) sensors, temperature meters, turbidity meters and sampling devices and ports.

The WBS models determine instrumentation requirements for each technology based on review of the schematic flow diagram for the appropriate technology, along with certain general assumptions that are applied to all of the technologies. **Exhibit A-1** documents the general assumptions about instrumentation that are applied in the WBS models. Slightly different assumptions hold when a model is intended as an add-on to an existing process (e.g., acid feed) rather than a complete process (e.g., anion exchange).

Exhibit A-1. General Design Assumptions for Instrumentation

Instrument Type	Assumption
Chlorine analyzers	For chlorine and hypochlorite disinfection, 1 per treatment train to monitor residual
Conductivity meters	Varies by technology
Dissolved oxygen analyzers	Varies by technology
Drive controllers	1 per each pump (including booster, backwash and chemical metering pumps) or other motorized item of equipment (e.g., mixers, blowers) in fully automated systems
Electric enclosures	Only for technologies with significant electric-powered equipment outside a building structure
Flow meters	1 for the influent or treated water line and 1 for backwash discharge. Some technologies also include flow meters on process lines.
Head loss sensors	Continuous level sensors. 1 per process vessel for technologies with pressure vessels. Some technologies omit head loss sensors for systems with design flows less than 1 million gallons per day.
High/low alarms	1 per backwash tank and 1 per chemical storage tank
Level switch/alarms	1 per process basin; 2 per contact tank for chemical disinfection technologies. Technologies with chemical cleaning use 1 per chemical tank in the cleaning system.
ORP sensors	Varies by technology
Particle meters	Varies by technology
pH meters	1 each for the influent and treated water lines for systems with pH adjustment, plus others on a technology-specific basis
Pressure transducers	Included in the cost of flow meter assemblies for venturi and orifice plate meters
Sampling ports	1 per process vessel, plus 1 each for the influent line, treated water line and discharge side of the backwash line for complete process models. Others are included on a technology-specific basis.
Total dissolved solids monitors	Varies by technology
Temperature meters	Varies by technology; often 1 for the influent and/or treated water lines, except for add-on models. Some technologies omit temperature meters for systems with design flows less than 1 million gallons per day.
Total organic carbon analyzers	Varies by technology
Turbidity meters	Varies by technology

Several types of flow meters can appear in the model output: propeller, venturi, orifice plate and magnetic flow meters. In general, the choice of meter depends on the cost level and design flow of the system, although some technologies require particular types of flow meters for specific purposes. For smaller and/or low-cost systems, the preference order in the models will have propeller flow meters as a first choice; for intermediate systems, venturi flow meters top the preference order; and for larger and/or high-cost systems, the top preference is magnetic flow

meters. In all cases, the component buildup will display the price for all available types of flow meters at a given size, so that a user can assess the cost impact of different types.

The critical design assumptions sheet of each model incorporates these general assumptions. Therefore, the user can adjust instrumentation assumptions on a technology-specific basis.

Individual technologies—in particular, aeration technologies and chlorine and hypochlorite disinfection—have additional or differing instrumentation requirements.

A.3 Control Systems

Automated control systems comprise the hardware and software used to monitor and control a treatment process. There are two general types of systems: programmable logic controls (PLCs) and/or remote telemetry units (RTUs). PLCs are stand-alone microprocessor-based control systems that can be programmed to monitor and control process equipment. RTUs were originally developed to communicate with systems from remote, outdoor locations. Newer RTU models can provide full equipment control through remote operator interface (AWWA, 2001). Because the WBS cost models (except for the nontreatment model) pertain to centralized treatment facilities, the assumptions reflect the control of all system components using a PLC system; RTUs are generally more appropriate for remote communications.

PLC hardware consists of a rack-mounted system with plug-in slots for the input and output (I/O) modules, which provide connections for the instruments and equipment, and one or more central processing unit (CPU) modules, which process the monitoring data inputs and control command outputs. The PLC equipment requires a power supply unit to operate the PLC data and command processing functions. In addition, an uninterruptible power supply (UPS) will protect the PLC system from undesired features such as outages and surges that can adversely affect the performance of the PLC unit. A system operator can monitor and operate with the PLC using either a computer or an operator interface unit, which is a panel mounted on the PLC enclosure. These units can be as simple as 2-line light-emitting diode text panels or as advanced as full color touch panels. The WBS models have default assumptions that PLC systems for smaller drinking water systems will be operated using an advanced, fully-functional operator interface unit after the control system installer has programmed the PLC. Larger systems will include an operator interface unit with more limited functionality and use at least one computer workstation with PLC programming software and printers to accomplish more advanced control functions from a central location. Large systems also include plant intelligence software to assist operation of the extensive control system.

The PLC system design in the WBS models depends on the design of the treatment system, which dictates the total number and type of I/O connections. The PLC system receives input signals from and transmits output signals to ports on instruments and equipment controllers. The I/O signals may be discrete or analog, depending on the type of equipment generating or receiving the signals. Discrete signals indicate which of two conditions apply such as whether a switch is on or off. Analog signals indicate a value along a predefined range such as temperature or rate of flow. **Exhibit A-2** identifies the assumptions used in the WBS models to determine the total number of I/O connections required for the PLC system.

Exhibit A-2. I/O Port Requirements for Instrumentation and Control

Instrument Type	Inputs to and Outputs from PLC System
Alarm (level switch/alarm, high/low alarm or low alarm)	1 input and 1 output—discrete
Chlorine analyzer	1 input—analogue
Conductivity meter	1 input—analogue
Dissolved oxygen analyzer	1 input—analogue
Drive controller	3 inputs (1 for the auto switch position, 1 for the run status signal and 1 for overload or fault signal) and 1 output—discrete
Flow meter	1 input—analogue Venturi and orifice plate meters also include inputs and outputs for the associated pressure transducer (below)
Head loss sensor	1 input—discrete
Motor/air-operated valve	1 input and 1 output—analogue
ORP sensor	1 input—analogue
Particle meter	1 input—analogue
pH meter	1 input—analogue
Pressure transducer	1 input—analogue
Sampling port	1 input—discrete
Total dissolved solids monitor	1 input—discrete
Temperature meter	1 input—analogue
Total organic carbon analyzer	1 input—analogue
Turbidity meter	1 input—analogue

The degree of automated control at a treatment facility can range from none to a fully automated control system that can monitor and control the hydraulic regime at the plant, the chemicals addition system, the power system and the communication system. To reflect potential ranges in treatment costs, the WBS models can provide equipment and operator labor cost outputs for three degrees of control:

- Fully automated control with safety overrides
- Semi-automated control where instruments provide data and information to the control station, but operators manually activate valves and mechanical equipment (e.g., this option removes outputs from the PLC system and removes automated drive controllers from mechanical equipment)
- Fully manual control where operators collect data directly from the instruments and manually activate valves and mechanical equipment.

Users can select among these three control schemes using the system automation input in each WBS model (see Section 2.3). **Exhibit A-3** shows the general design assumptions about control equipment used for each control scheme in the WBS models. The paragraphs below provide additional information regarding the equipment components and calculations.

Exhibit A-3. General Design Assumptions for System Controls

Item of Control Equipment	Small System (<1 MGD)	Medium System (1–10 MGD)	Large System (>10 MGD)	WBS Assumption
PLC Rack/Power Supply	A,S	A,S	A,S	1 base and expansion bases as needed for I/O (see text)
CPU	A,S	A,S	A,S	2 per system ¹
I/O Discrete Output Module	A	A	A	1 for every 32 outputs ²
I/O Discrete Input Module	A,S	A,S	A,S	1 for every 32 inputs ²
I/O Combination Analog Module	A,S	A,S	A,S	1 for every 12 inputs (for A and S) and outputs (for A only) ³
Ethernet Module	A,S	A,S	A,S	2 per system ¹
Base Expansion Module	A,S	A,S	A,S	1 per expansion base
Base Expansion Controller Module	A,S	A,S	A,S	1 per expansion base
UPS	A,S	A,S	A,S	1 per system
Operator Interface Unit – limited functionality	NA	A,S	A,S	2 per system ¹ (see text)
Operator Interface Unit – advanced, fully functional	A,S	NA	NA	2 per system ¹ (see text)
Computer Workstations	NA	A,S	A,S	1 per operator
Laser Jet Printer	NA	A,S	A,S	1 per 4 workstations
Dot Matrix Printer	NA	A,S	A,S	1 per 4 workstations
PLC Programming Software	NA	A,S	A,S	1 per workstation
Operator Interface Software	A,S	NA	NA	1 per system
PLC Data Collection Software	NA	A,S	A,S	1 per workstation
Plant Intelligence Software	NA	A,S	A,S	1 per workstation

A = included in a fully automated system; S = included in a semi-automated system; NA = not applicable for this design size
 Notes: Fully manual systems do not include system controls

1. Includes one to provide redundancy
2. Discrete input and output modules can have fewer I/O connections, but price differences are small. To keep the equipment requirement calculation tractable, the WBS models use a 32-connection module, which will slightly overstate cost when fewer connection points are needed on the last module.
3. A combination module accommodates 8 inputs and 4 outputs. This 2-to-1 ratio is generally consistent with the ratio of analog inputs-to-outputs in the WBS models for a fully automated system.

The primary PLC system is a rack and power supply (i.e., a “base”) with nine slots for control modules.¹⁰ The CPU module requires one slot. An ethernet module necessary for PLC programming requires a second slot, leaving seven for I/O modules. If additional I/O slots are needed to accommodate instruments and equipment, then up to four additional expansion bases can be added, giving the single CPU the capacity to run up to 8,192 I/O connections. Each expansion base has nine module slots and is linked to the CPU module on the primary base.

The total number of PLC racks and power supplies include the primary rack and any expansion racks. The calculation for the total number of racks must take into account the module slots that will be occupied by all types of modules including the CPU module, the ethernet module and expansion base controller modules. Each expansion rack requires a base expansion controller module, which occupies one of the module slots on the expansion rack, leaving eight slots for

¹⁰ Bases with fewer slots are also available, but cost differences across base sizes are small. To keep the equipment requirement calculation tractable, the WBS models use a 9-slot base, which will slightly overstate cost when fewer slots are needed.

I/O modules. Each expansion rack also requires a base expansion module, which is attached to the outside of the rack and, therefore, does not require a module slot. The following calculations illustrate how the WBS models calculate total PLC racks:

IF ($plc_cpu + plc_ethernet + plc_discrete_input + plc_discrete_output + plc_combination_analog$) ≤ 9
 THEN $plc_rack = 1, plc_base_expansion = 0, plc_base_expansion_controller = 0$

IF ($plc_cpu + plc_ethernet + plc_discrete_input + plc_discrete_output + plc_combination_analog$) > 9 AND ≤ 17
 THEN $plc_rack = 2, plc_base_expansion = 1, plc_base_expansion_controller = 1$

IF ($plc_cpu + plc_ethernet + plc_discrete_input + plc_discrete_output + plc_combination_analog$) > 17 AND ≤ 25
 THEN $plc_rack = 3, plc_base_expansion = 2, plc_base_expansion_controller = 2$

IF ($plc_cpu + plc_ethernet + plc_discrete_input + plc_discrete_output + plc_combination_analog$) > 25 AND ≤ 33
 THEN $plc_rack = 4, plc_base_expansion = 3, plc_base_expansion_controller = 3$

IF ($plc_cpu + plc_ethernet + plc_discrete_input + plc_discrete_output + plc_combination_analog$) > 36 AND ≤ 41
 THEN $plc_rack = 5, plc_base_expansion = 4, plc_base_expansion_controller = 4$

A.4 List of Abbreviations and Symbols in this Appendix

CPU	central processing unit
I/O	input and output
ORP	oxidation-reduction potential
PLCs	programmable logic controls
RTUs	remote telemetry units
UPS	uninterruptible power supply
WBS	work breakdown structure

A.5 References

American Water Works Association (AWWA). 2001. *Instrumentation and Control, Manual of Water Supply Practices—M2*. Third Edition. Denver, Colorado: AWWA.

Appendix B. Building Construction Costs

B.1 Introduction

The work breakdown structure (WBS) cost database incorporates building costs from three sources: RSMeans *2020 Square Foot Costs* (RSMeans, 2020), Saylor *2020 Commercial Square Foot Building Costs* (Saylor, 2020) and the Craftsman 2020 National Building Cost Estimator (NCBE) software model (described in Craftsman, 2020). Each of these sources enables a user to create a cost estimate by combining costs for different elements of a building—for example, the foundation, exterior walls or light fixtures.

For each source, the WBS cost database includes three sets of options to represent low, medium and high building design and material qualities. Section B.2 provides descriptions of the relevant options for each source within these categories, as well as the options selected for each of the three building types used in the WBS models. The WBS models cost heating and cooling systems as individual capital cost line items separate from the building construction costs. Therefore, the building costs discussed here exclude heating and cooling systems.

For each of the three types of building, EPA used the three sources described here to develop cost buildups for 24 building sizes ranging from 500 to 200,000 square feet and tabulated costs for each of the models. The resulting costs from each model are included in the WBS cost database. The database escalates these costs from 2020 dollars using the Engineering News-Record Building Cost Index (ENR, 2020) and averages them following the same procedure as for other components, as described in Chapter 2. The WBS models use these costs to estimate costs per square foot for buildings larger than 500 square feet (ft²).

EPA also developed a fourth building type that applies only to structures smaller than 500 ft²—essentially a shed with steel walls and a roof. This additional building type allows the WBS models to use, for very small systems, building costs that reflect very inexpensive building construction methods and materials. For this type of building, EPA used the Craftsman NCBE model to estimate costs for a low-profile steel building. However, the WBS models do not use this building type for chlorine storage buildings because chlorine gas use necessitates a non-corrodible building material and special ventilation requirements. Thus, for chlorine storage buildings smaller than 500 ft², the WBS models use the same unit costs as for larger buildings.

B.2 Buildup Options and Building Quality Selections

EPA developed building cost estimates using comparable assumptions across data sources: the Craftsman NBCE model, building costs from RSMeans *2020 Square Foot Costs* and Saylor *2020 Commercial Square Foot Building Costs*. Each source provides unit costs for different building types and construction qualities.

The Craftsman NBCE model is a software model that generates building cost estimates based on user input (i.e., building size and quality of building features and fixtures). Given the variation in unit costs for components by size, it appears to function as a parametric model. The costs in the NBCE model are based on data obtained from U.S. government building cost surveys.

The RSMeans and Saylor manuals contain unit costs, usually in dollars per square foot, for various building components (e.g., exterior walls, floor structure or roof structure). The costs are based on data obtained from the construction industry and independent research of construction costs. By combining unit costs across components, one can build up a total building unit cost. The approach is essentially a WBS cost approach where most components are priced on the basis of building area, with little or no variation in the cost per unit area as building size increases. For example, the RSMeans unit cost for a foundation slab varies with the thickness of the slab (EPA chose thicker slabs for higher quality buildings), but not with the building size. Notable exceptions are the cost of exterior walls and roof structures. Exterior wall cost in dollars per ft² declines as building size increases because the ratio of exterior wall linear footage to square footage declines. For roof structures, EPA chose roof spans based on the length of a side of the building (assumed square). For building side lengths greater than 70 feet, EPA included support columns to give a maximum roof span of 70 feet. Larger buildings, therefore, may have somewhat more expensive superstructures on a per-square-foot basis, since they may have a wider roof span or support columns.

EPA chose inputs to the NBCE model and chose components from the RSMeans and Saylor manuals to reflect the different levels of building quality used in the WBS models (high, medium, low and very small low quality).

Based on the NBCE industrial building quality classifications, EPA determined that the NBCE Class 1&2 (best/good quality), Class 3 (average quality) and Class 4 (low quality) reflected WBS high, medium and low quality buildings, respectively. EPA used the NBCE low-profile steel building for very small low quality buildings.

The RSMeans and Saylor manuals do not contain building types that are closely comparable to the very small low quality building. Therefore, there are no RSMeans or Saylor costs for this type of structure. RSMeans and Saylor building cost estimates were “built” by selecting specific building elements of differing quality for each type of building from the assemblies sections of their respective manuals.

From each source, EPA obtained cost estimates for the following building areas in square feet: 500; 1,000; 2,000; 3,000; 4,000; 5,000; 7,500; 8,000; 10,000; 12,000; 15,000; 18,000; 20,000; 24,000; 25,000; 30,000; 36,000; 42,000; 48,000; 50,000; 54,000; 60,000; 100,000 and 200,000. The resulting costs do not include costs for site improvements (e.g., land, landscaping, parking and utilities), permits, furnishings and production equipment, homeland security responses or contingency allowance.

The RSMeans and Saylor costs include installation costs as well as overhead and profit for the contractors installing the building components, but do not include architectural fees or general contractor markup for general conditions, overhead and profit (RSMeans, 2020; Saylor, 2020). According to Craftsman (Ogershok, 2009), the NBCE model’s costs do not include installing contractor markup directly, but do include a markup of 30 percent for the general contractor, which they assume to also cover the installing contractor’s markup. Since the Craftsman costs were generally lower than those from Means or Saylor and since the installing contractor’s markup in Means and Saylor is usually 30 percent or more, EPA assumed that the 30 percent markup in the Craftsman costs was passed along directly to the installing contractor and further

markup would be required for the general contractor. Architectural fees and the general contractor’s markup are included in the WBS model indirect cost output, as described in Appendix D.

Each source has a different set of options. They can be grouped into six categories:

- Substructure
- Superstructure
- Exterior closure
- Interior finish
- Mechanical services, excluding heating and cooling
- Electrical services.

B.2.1 Substructure

Building substructure was selected using application scenarios for each of the three quality options. For low quality buildings, EPA assumed an average industrial use scenario. For medium quality buildings, EPA assumed a heavy industrial use scenario. For higher quality buildings, EPA assumed a heavy industrial with live loads use scenario. EPA assumed light foot traffic for the very small (less than 500 ft²) buildings (other than those used to store chlorine gas).

Exhibit B-1 shows the detailed choices that EPA made for each of the three sources.

Exhibit B-1. Substructure Selections for NBCE, RSMears and Saylor

Building Variable	Lower Quality Building	Medium Quality Building	Higher Quality Building	Very Small Lower Quality Building
Craftsman NBCE	<i>Foundation:</i> reinforced concrete pads under pilasters. <i>Floor:</i> 6" rock base, 4" concrete with reinforcing mesh.	<i>Foundation:</i> continuous reinforced concrete. <i>Floor:</i> 6" rock base, 5" concrete with reinforcing mesh or bars.	<i>Foundation:</i> continuous reinforced concrete. <i>Floor:</i> 6" rock base, 6" concrete with reinforcing mesh or bars.	<i>Foundations</i> as required for normal soil conditions; a 4" concrete floor with reinforcing mesh and a 2" sand fill.
RSMears	<i>Foundation:</i> poured concrete; strip and spread footings. <i>Slab:</i> 4" reinforced, industrial concrete with vapor barrier and granular base. Site preparation for slab and trench for foundation wall and footing. 4' foundation wall.	<i>Foundation:</i> poured concrete; strip and spread footings. <i>Slab:</i> 5" reinforced, heavy industrial concrete with vapor barrier and granular base. Site preparation for slab and trench for foundation wall and footing. 4' foundation wall.	<i>Foundation:</i> poured concrete; strip and spread footings. <i>Slab:</i> 6" reinforced, heavy industrial concrete with vapor barrier and granular base. Site preparation for slab and trench for foundation wall and footing. 4' foundation wall.	not applicable
Saylor	<i>Foundation:</i> concrete strip and spread footings, 4' foundation wall. <i>Slab on grade:</i> reinforced concrete, vapor barrier, 4" thick, on 4' sand or gravel base.	<i>Foundation:</i> concrete strip and spread footings, 4' foundation wall. <i>Slab on grade:</i> reinforced concrete, vapor barrier, 5" thick, on 4' sand or gravel base.	<i>Foundation:</i> concrete strip and spread footings, 4' foundation wall. <i>Slab on grade:</i> reinforced concrete, vapor barrier, 6" thick, on 4' sand or gravel base.	not applicable

' = feet; " = inches

B.2.2 Superstructure

EPA assumed the same quality of superstructure for each of the three quality options—metal deck and open web steel joists, supported by columns and exterior walls. However, the superstructure support column spans range up to 70 feet, depending upon building size. To establish the column span, EPA computed the length of a building side, assuming the building to be square. For buildings with side lengths larger than 70 feet, EPA included support columns in a square grid to provide a roof span of 70 feet or less, assuming that the roof would also be supported on the exterior walls. For instance, a 10,000 ft² building (100 feet on a side) would have one support column in the center, with a 50 foot roof span. A 30,000 ft² building (173 feet on a side) would have four support columns at 58 foot intervals. Since the sources included roof spans in increments of 10 feet, EPA rounded up to a 60 foot roof span for this building. EPA used a steel building quality superstructure for the very small (less than 500 ft²) buildings (other than those used to store chlorine gas).

Exhibit B-2 displays the superstructure options that EPA selected for each source.

Exhibit B-2. Superstructure Selections for NBCE, RSMeans and Saylor

Building Variable	Lower Quality Building	Medium Quality Building	Higher Quality Building	Very Small Lower Quality Building
Craftsman NBCE	<i>Roof structure:</i> glu-lams wood or steel trusses on steel intermediate columns, short span. <i>Roof cover:</i> panelized roof system, ½" plywood sheathing, 4-ply built-up roof. 10 ft ² of skylight per 2,500 ft ² of floor area (1-2'x 4' skylight 40' to 50' o.c.).	<i>Roof structure:</i> glu-lams wood or steel trusses on steel intermediate columns, short span. <i>Roof cover:</i> panelized roof system, ½" plywood sheathing, 4-ply built-up roof. 24 ft ² of skylight per 2,500 ft ² of floor area (1-4'x 6' skylight 40' to 50' o.c.).	<i>Roof structure:</i> glu-lams wood or steel trusses on steel intermediate columns, span exceeds 70'. <i>Roof cover:</i> panelized roof system, ½" plywood sheathing, 4-ply built-up roof. 32 ft ² of skylight per 2,500 ft ² of floor area (1-4'x 8' skylight 40' to 50' o.c.).	Steel roof purlins 4½ to 5½ feet on centers, 26-gauge galvanized steel on roof
RSMeans	<i>Roof:</i> 1.5" galvanized metal deck, open web steel joists, joist girders, on columns and walls; total load = 60-65 lbs/ft ² . Column spacing chosen to give a maximum span of 70', with the building assumed square. Steel columns. <i>Roof cover:</i> Built-up tar and gravel roof covering with flashing, perlite/EPS composite insulation. Roof hatches with curb.	Same as lower quality	Same as lower quality	not applicable
Saylor	<i>Roof:</i> metal deck, open web steel joists, on columns and walls. Wide flange steel columns, steel beams and girders. Column spacing chosen to give a maximum span of 70', with the building assumed square. <i>Roof cover:</i> built-up tar and gravel.	Same as lower quality	Same as lower quality	not applicable

' = feet; " = inches; EPS = expanded polystyrene; o.c. = on center

B.2.3 Exterior Closure

EPA used different building exterior qualities to estimate unit costs that vary by exterior material. EPA selected reinforced concrete block exteriors for the lower quality buildings, reinforced tilt-up concrete panel exteriors for the medium quality buildings¹¹ and brick-faced, reinforced cavity/composition wall exteriors for the higher quality buildings. EPA used corrugated metal exteriors for the very small lower quality structures (smaller than 500 ft²).

A cavity wall (e.g., masonry) is a wall in which the inner and outer wythes are separated by an air space, but tied together with wires or metal stays. A composition wall is a wall combining different materials to work as a single unit. A tilt-up wall is a method of concrete construction in which wall sections are cast horizontally at a location adjacent to their eventual position and tilted into place after removal of forms.

Exhibit B-3 shows the exterior closure options that EPA selected for each model.

Exhibit B-3. Exterior Closure Selections for NBCE, RSMeans and Saylor

Building Variable	Lower Quality Building	Medium Quality Building	Higher Quality Building	Very Small Lower Quality Building
Craftsman NBCE	8" reinforced concrete block or brick, unpainted. (Same for both lower and medium quality.)	8" reinforced concrete block or brick, unpainted. (Same for both lower and medium quality.)	8" reinforced concrete block or brick with pilasters 20' on centers, painted sides and rear exterior, front wall brick veneer	Steel frames/bents set 20' to 24' on centers, steel wall girts 3½' to 4½' on centers, post and beam type end wall frames, 26-gauge galvanized steel on ends and sides
RSMeans	Concrete block, reinforced, regular weight, hollow, 4x8x16', 2,000 psi	Tilt-up concrete panels, broom finish, 5½" thick, 3,000 psi	Brick face composite wall-double wythe: utility brick, concrete block backup masonry, 8" thick, perlite core fill.	not applicable
Saylor	Concrete block, 4x8x16', reinforced	Tilt-up concrete panel, 6" thick, no pilasters.	Brick cavity wall, reinforced, 10" thick.	not applicable

' = feet; " = inches; psi = pounds per square inch

B.2.4 Interior Finish

Choices of interior finish reflect the quality and duty of the interior construction materials such as floor coverings, wall coverings and ceilings. EPA selected functional, minimally attractive interior finishes for the lower quality buildings and more functional and attractive interiors for medium and higher quality buildings. EPA also selected functional, unattractive interior finishes for the very small (less than 500 ft²) buildings (other than those used to store chlorine gas).

Exhibit B-4 shows the interior finish options that EPA selected for each source.

¹¹ Tilt-up concrete panel exteriors were selected in the RSMeans and Saylor cost estimation buildups. Tilt-up concrete panels were not an exterior option in the Craftsman NBCE cost estimation model; therefore, reinforced concrete block exterior was selected in the Craftsman NBCE cost estimation model for medium quality buildings.

Exhibit B-4. Interior Finish Selections for NBCE, RSMeans and Saylor

Building Variable	Lower Quality Building	Medium Quality Building	Higher Quality Building	Very Small Lower Quality Building
Craftsman NBCE	Concrete floors. Rest rooms: unfinished wallboard partitions and 2 low cost fixtures.	Concrete floors. Rest rooms: painted gypsum wallboard partitions and 2 average fixtures.	Concrete floors. Rest rooms: enameled gypsum wallboard partitions, 3 good fixtures, vinyl asbestos tile floors.	Minimal quality, minimal duty, functional, unattractive
RSMeans	One minimal quality 2-fixture restroom per 5,000 ft ² building area. Unpainted walls. Concrete floors. Fiberglass ceiling board on exposed grid system covering 10 percent of building area.	One minimal quality 2-fixture restroom per 5,000 ft ² building area. Painted walls. Vinyl composition tile floors covering 10 percent of building area. Fiberglass ceiling board on exposed grid system covering 10 percent of building area.	One high quality 3-fixture restroom per 5,000 ft ² building area. Acrylic glazed walls. Vinyl composition tile floors covering 10 percent of building area. Fiberglass ceiling board on exposed grid system covering 10 percent of building area.	not applicable
Saylor	One restroom per 5,000 ft ² building area, with 2 economy fixtures, baked enamel partitions. Unpainted walls. Concrete floors. Ceiling: 5/8" gypsum board on metal frame, covering 10 percent of building area.	One restroom per 5,000 ft ² building area, with 2 standard fixtures, baked enamel partitions. Painted walls. Vinyl composition floor covering 10 percent of building area. Ceiling: 5/8" gypsum board on metal frame, covering 10 percent of building area.	One restroom per 5,000 ft ² building area, with 3 standard fixtures, baked enamel partitions. Painted walls. Vinyl composition floor covering 10 percent of building area. Ceiling: 5/8" gypsum board on metal frame, covering 10 percent of building area.	not applicable

' = feet; " = inches

B.2.5 Mechanical Services

Mechanical services include fire protection, plumbing, heating, ventilation and cooling. The WBS models cost heating and cooling systems as individual capital cost line items separate from the building construction costs, so the mechanical services included in the building costs are limited to fire protection, plumbing and ventilation. EPA assumed no sprinkler systems for the lower quality buildings and normal hazard wet sprinkler systems for medium and higher quality buildings. EPA also assumed no sprinkler systems for the very small (less than 500 ft²) buildings (other than those used to store chlorine gas).

Exhibit B-5 shows the mechanical services options that EPA selected for each source.

Exhibit B-5. Mechanical Services Selections NBCE, RSMears and Saylor

Building Variable	Lower Quality Building	Medium Quality Building	Higher Quality Building	Very Small Lower Quality Building
Craftsman NBCE	No sprinklers. 1 small rotary vent per 2,500 ft ² of floor area.	Sprinklers. 1 medium rotary vent per 2,500 ft ² of floor area. (Same for both medium and higher quality.)	Sprinklers. 1 medium rotary vent per 2,500 ft ² of floor area. (Same for both medium and higher quality.)	Minimal quality, minimal duty, functional, no sprinklers
RSMears	Gas-fired water heater. No sprinklers.	Gas-fired water heater. Wet pipe sprinkler system. (Same for both medium and higher quality.)	Gas-fired water heater. Wet pipe sprinkler system. (Same for both medium and higher quality.)	not applicable
Saylor	Gas-fired water heater (1 per 5,000 ft ²), 50 gallon, 100 GPH. No sprinklers.	Gas-fired water heater (1 per 5,000 ft ²), 50 gallon, 100 GPH. Exposed wet sprinkler system, normal hazard. (Same for both medium and higher quality.)	Gas-fired water heater (1 per 5,000 ft ²), 50 gallon, 100 GPH. Exposed wet sprinkler system, normal hazard. (Same for both medium and higher quality.)	not applicable

' = feet; " = inches; GPH = gallons per hour

B.2.6 Electrical Services

EPA included the cost of light fixtures and convenience power, along with associated wiring and conduits. EPA selected inexpensive lighting fixtures that provide minimal lighting and a minimal number of wall switches and receptacles for the lower quality buildings and selected increasingly expensive lighting fixtures that provide bright lighting and an increased number of wall switches and receptacles for the medium and higher quality buildings. EPA also selected minimal lighting fixtures for the very small (less than 500 ft²) buildings (other than those used to store chlorine gas).

EPA did not include electrical feed, switchgear, motor control centers, etc. in building costs. These costs are likely to vary significantly by technology for buildings of the same size and quality; for example, a mid-sized reverse osmosis system and a small packaged conventional filtration system might occupy roughly the same footprint in similar buildings, but the reverse osmosis system will likely have much greater power requirements. It is therefore not appropriate to base these costs on the building's area or quality. These costs are included in the indirect cost buildup based on a percentage of process cost, as described in Appendix D.

Exhibit B-6 shows the electrical services options that EPA selected for each source.

Exhibit B-6. Electrical Services Selections for NBCE, RSMeans and Saylor

Building Variable	Lower Quality Building	Medium Quality Building	Higher Quality Building	Very Small Lower Quality Building
Craftsman NBCE	<i>Lighting:</i> low cost incandescent fixtures, 20'x30' spacing	<i>Lighting:</i> low cost single tube fluorescent fixtures 20'x20' spacing	<i>Lighting:</i> 4" single tube fluorescent fixtures 10'x12' spacing	Minimal quality, minimal duty, basic wiring and minimal lighting fixtures
RSMeans	<i>Lighting:</i> Incandescent fixtures recess mounted, type A: 1 W/ft ² , 8 FC. 6 lighting fixtures, 1 wall switch and 2.5 receptacles per 1,000 ft ² . 1 W miscellaneous power.	<i>Lighting:</i> Fluorescent fixtures recess mounted in ceiling: T-12, 40 W lamps, 2 W/ft ² , 40 FC. 10 lighting fixtures, 2.5 wall switches and 5 receptacles per 1,000 ft ² . 1.5 W miscellaneous power.	<i>Lighting:</i> Fluorescent fixtures recess mounted in ceiling: T-12, 40 W lamps, 4 W/ft ² , 80 FC. 20 lighting fixtures, 5 wall switches and 10 receptacles per 1,000 ft ² . 3 W miscellaneous power.	not applicable
Saylor	<i>Lighting:</i> Incandescent fixtures, surface mounted, 100 W, commercial grade, 10 per 1,000 ft ² for 1 W/ft ² total. 1 commercial grade single-pole switch and 2.5 commercial-grade duplex receptacles per 1,000 ft ² . In slab/PVC conduit and wire for 60 A current, length assumed equal to building perimeter for a square building.	<i>Lighting:</i> Fluorescent fixtures, recessed, 2 13 W bulbs each, 16 per 1,000 ft ² for 2 W/ft ² total. 2.5 commercial grade single-pole switches and 5 commercial-grade duplex receptacles per 1,000 ft ² . EMT conduit and wire for 60 A current, length assumed equal to building perimeter for a square building.	<i>Lighting:</i> Fluorescent fixtures, recessed, 2 13 W bulbs each, 31 per 1,000 ft ² for 4 W/ft ² total. 5 commercial grade single-pole switches and 10 commercial-grade duplex receptacles per 1,000 ft ² . RGS conduit and wire for 60 A current, length assumed equal to building perimeter for a square building.	not applicable

' = feet; " = inches; A = amp; EMT = electrical metallic tubing; FC = foot candles; PVC = polyvinyl chloride; RGS = rigid galvanized steel; W = watt

B.3 List of Abbreviations and Symbols in this Appendix

EPA	U.S. Environmental Protection Agency
ft ²	square feet
NBCE	National Building Cost Estimator
WBS	work breakdown structure

B.4 References

Craftsman Book Company. 2020. *2020 National Building Cost Manual*. 68th Edition.

Engineering News-Record (ENR). 2020. *Building and Construction Cost Indexes*. Retrieved from <http://enr.construction.com/economics/>

Ogershok, Dave, Craftsman Book Company. 2009. Personal communication with Danielle Glitz, SAIC. 6 March.

RSMeans. 2020. *2020 Square Foot Costs*. 41st Annual Edition. Rockland, Massachusetts: the Gordian Group.

Saylor Publications, Inc. 2020. *2020 Commercial Square Foot Building Costs Manual*.

Appendix C. Residuals Management Costs

C.1 Introduction

The purpose of this appendix is to outline the approach used to estimate costs for managing the residuals generated by different drinking water treatment technologies. The work breakdown structure (WBS) model for each treatment technology includes its own residuals cost estimate. Each model allows the user to choose from different residual management options that reflect the methods most likely to be used for the drinking water treatment technology being modeled. Based on the residuals management option selected, each model identifies the specific component equipment and operating and maintenance (O&M) requirements and generates costs using the WBS approach based on engineering design. Costs for residuals management equipment appear as line items in the model output, as is the case for other WBS elements. The residuals management design also affects indirect costs, land costs and building costs.

The residuals management options available in each model are specific to the technology being modeled, driven by the types of residuals generated, their quantity, the frequency of generation (e.g., intermittent versus continuous) and their characteristics. There are, however, similarities among groups of technologies that generate similar residuals. **Exhibit C-1**, below, lists the technology groups, the residuals generated and the frequency of generation.

The technology-specific chapters of this report identify the residuals management options available in each model. Because many of the options are similar within (or even across) technology groups, this appendix describes the methodology and assumptions used for each option in a single location, rather than repeating the information in each technology chapter. The residuals management options that may be included in a given model include the following:

- Holding tanks (with or without coagulant addition)
- Direct discharge to surface water
- Discharge to a publicly owned treatment works (POTW)
- Recycle to treatment plant headworks
- Evaporation ponds
- Septic system
- Off-site disposal (non-hazardous, hazardous, radioactive or hazardous and radioactive)
- Land application
- Liquid hazardous waste disposal
- Deep well injection
- Off-gas treatment.

Section C.2, below, describes general design methods and assumptions common across residuals management options. With two exceptions, subsequent sections describe each of the above options. Deep well injection is included as an option only in the reverse osmosis/nanofiltration model and, therefore, is discussed in detail in the chapter relating to that model. Off-gas treatment is relevant only to aeration technologies and, therefore, is discussed in detail in chapters relating to aeration models (e.g., packed tower aeration, multi-stage bubble aeration).

Exhibit C-1. Technologies and Residuals Generated

Residuals Generated	Type of residual	Generation Frequency	Technologies
Spent regenerant or brine ¹	Liquid	Intermittent or continuous	Adsorptive Media, Anion Exchange, Cation Exchange
Spent backwash	Liquid	Intermittent	Adsorptive Media, Anion Exchange, Biologically Active Filtration, Biological Treatment, Cation Exchange, Greensand Filtration, Granular Activated Carbon
Spent media or resin	Solid	Intermittent	Adsorptive Media, Anion Exchange, Biologically Active Filtration, Biological Treatment, Cation Exchange, Greensand Filtration, Granular Activated Carbon
Membrane concentrate	Liquid	Continuous	Reverse Osmosis/Nanofiltration
Spent backwash/tank drain and crossflow	Liquid	Intermittent	Low-pressure Membranes (Microfiltration/Ultrafiltration)
Cleaning waste	Liquid	Intermittent	Reverse Osmosis/Nanofiltration, Low-pressure Membranes (Microfiltration/Ultrafiltration)
Spent membrane modules/elements	Solid	Intermittent	Reverse Osmosis/Nanofiltration, Low-pressure Membranes (Microfiltration/Ultrafiltration)
Used cartridge filters	Solid	Intermittent	Reverse Osmosis/Nanofiltration
Off-gas	Gas	Continuous	Packed Tower Aeration, Multi-stage Bubble Aeration, Diffuse Aeration, Tray Aeration
Spent lamps, ballasts and intensity sensors	Solid	Intermittent	Ultraviolet Disinfection, Ultraviolet Advanced Oxidation

The chlorine gas, hypochlorite, chlorine dioxide, chloramine, nontreatment, ozone, permanganate addition, phosphate feed, caustic feed and acid feed models are not shown because no process residuals are generated.

Note:

1. Generated when the technology is used with media regeneration, rather than on a throw away basis.

C.2 General Assumptions

Some of the general assumptions used in developing the costs for management of residuals are listed below:

- For intermittently generated liquid residuals (e.g., filter backwash), the models calculate residuals quantities based on the volume of a single generation event (e.g., backwashing one vessel) and assuming a staggered schedule between generation events (e.g., if vessels must be backwashed every 48 hours and there are two vessels in operation, the facility will backwash vessel one at 0 and 48 hours and backwash vessel two at 24 and 72 hours).
- For intermittently generated liquid residuals, flow rates depend on whether flow equalization is used (e.g., through the use of holding tanks, as described in Section C.3).
- Without flow equalization, the maximum residuals flow rate for intermittently generated liquid residuals is *single generation event volume/event duration*.
- With flow equalization, the models assume residuals are released continuously during the time between generation events. Therefore, the maximum residuals flow rate for intermittently generated liquid residuals is *(single generation event volume/time between events) x capacity factor*. The variable, *capacity factor*, is present to account for less than perfect staggering between generation events. The models assume *capacity factor* equals

2, but the user can change this assumption on the critical design assumptions sheet of each model.

- The models size residuals piping, valves and other downstream equipment based on the *maximum* flow rates calculated as described above for intermittently generated liquid residuals and on the *maximum* continuous flow rate determined by the engineering models for continuously generated liquid residuals.
- The models assume the length of interconnecting piping between treatment process equipment and residuals management equipment is equal to 1 times the overall system building layout length. Like the pipe length assumptions documented in **Exhibit 2-10**, this assumption is designed to account for the cost of fittings.
- With a few exceptions (noted in the individual model chapters), the models assume an *additional* 40 feet of piping is required for liquid residuals to reach their ultimate destination (e.g., the discharge point, head of the treatment plant or evaporation pond). Except when this piping is used to recycle the residual, the models assume this piping is buried and, therefore, include the cost of excavation, bedding, thrust blocks, backfill and compaction for the additional pipe length. The user can change the assumption about the length of the additional residuals piping on critical design assumptions sheet of each model.
- The models generally assume that total suspended solids (TSS) in the influent water are completely removed during treatment and accumulate in the residuals generated. This assumption provides a conservative (high) estimate of the TSS concentration in the residuals. Assumptions about the concentration of TSS in the influent water vary on a technology-by-technology basis, but the user can change the assumption on the critical design assumptions sheet of each model.

C.3 Holding Tanks

The purpose of a holding tank is to equalize the rate of flow at which residuals are released or discharged. A holding tank may be desirable for intermittently generated liquid residuals that ultimately are recycled to the treatment plant headworks or discharged to a POTW. The instantaneous flow of intermittently generated liquid residuals (e.g., filter backwash) during a generation event can be quite high. The use of a holding tank allows the discharge of these residuals over the time between generation events, so that the ultimate flow is lower, but more continuous. When residuals such as filter backwash are recycled to the head of a treatment plant, recommended engineering practice is that the recycle stream should be no more than 5 percent to 10 percent of total system flow (U.S. EPA, 2002; U.S. EPA, 1996). Flow equalization through the use of a holding tank may be necessary to meet this generally recommended engineering practice. It also may be reasonable to include a holding tank for other discharge options (e.g., to prevent instantaneous flow from overwhelming the capacity of a POTW).

When holding tanks are used for intermittently generated liquid residuals, the models determine the capacity required as follows: *single generation event volume x capacity factor*. This capacity factor is the same variable discussed in Section C.2 and is intended to account for less than perfect staggering between generation events.

Holding tanks can also be desirable for certain continuously generated liquid residuals (e.g., membrane reject) to accommodate variations in flow that occur as influent flow varies. In this

case, the models determine the capacity required based on a desired detention time. The user can change this detention time on the critical design assumptions sheet of the appropriate models.

When holding tanks are included, residuals pumps are required to move residuals from the holding tank to their ultimate destination. The models size these pumps based on maximum residuals flow rate, as discussed in Section C.2. The models also include maintenance labor, materials and energy for these pumps in the O&M calculations using the same approach described for booster pumps in Appendix E.

When holding tanks are used, they can result in the generation of secondary residuals in the form of solids that settle in the holding tank. The models also allow for the addition of coagulant to the holding tank to increase the percentage of TSS removed. Users can model this option by changing the appropriate triggering variable on the critical design assumptions sheet of each model. When the coagulant addition option is chosen, users also can choose the coagulant used. Options available (specified on the critical design assumptions sheet) are polymers, ferric chloride or both ferric chloride and polymers.

By default, holding tanks can be constructed of plastic, fiberglass or steel or they can be open concrete basins. When the coagulant addition option is chosen, however, the models automatically assume the tanks will be open concrete basins, to allow for easier solids cleanout. The models also size the tanks so that a minimum settling time is achieved. When coagulant addition is chosen, the models also add other required equipment, specifically mixers and dry feeders or metering pumps.

The following are the model assumptions relevant to solids generation and coagulant addition:

- Without coagulant addition, most models assume that 25 percent of the TSS present in the residuals is removed in a holding tank¹²
- With coagulant addition, this assumption increases to 50 percent
- With coagulant addition, the holding tanks must provide a minimum settling time of 90 minutes
- Coagulant dose is 10 milligrams per liter
- Coagulant sludge production factor is 1 pounds of sludge per pound of polymers added and 0.99 pounds of sludge per pound of ferric chloride added
- Holding tank solid density is 25 pounds per cubic foot
- Holding tank solids are removed when the solids accumulation reaches 10 percent of tank capacity.

The user can change each of these assumptions on the critical design assumptions sheet of the individual models.

¹² Exceptions are models, such as anion exchange, that assume low influent solids or include pretreatment filtration to remove influent solids. These models assume no settling in the holding tank without coagulant addition, because of the low solids content present (or remaining) in the water being treated.

C.4 Direct Discharge to Surface Water

Some liquid residuals may be amenable to direct discharge to surface water. Such discharges require a National Pollutant Discharge Elimination System permit, the costs of which are included in the add-on costs line item for permits. The only items of capital equipment required for direct discharges are piping and valves, although the models will include pumps if holding tanks are used in conjunction with direct discharge (see Section C.3, above).

C.5 Discharge to POTW

Discharge to a POTW is another possible management option for liquid residuals. The discharge should meet certain pretreatment requirements and must not overwhelm the capacity of the POTW. The only items of capital equipment required for POTW discharges are piping and valves, although the models will include pumps if holding tanks are used in conjunction with POTW discharge (see Section C.3, above).

Discharge to a POTW, however, entails certain charges that are included in the O&M costs of each model when this discharge option is included. POTW rate structures vary nationwide, but the most common types of charges are the following:

- Flat fees (e.g., dollars per month).
- Volume-based fees (e.g., dollars per 1,000 gallons discharged).
- TSS-based fees (e.g., dollars per pound of TSS in the discharge if over a certain TSS concentration). For this fee type, the models assume that the POTW TSS discharge limit over which a fee is imposed to be 250 parts per million (which is the most common limit for cities with a limit on TSS).

Individual POTW rate structures can reflect a combination of one or more of these fee types. To model POTW charges in a way that is nationally representative, the models include all three fee types and calculate them based on unit charges that represent the average for each fee type based on data from AWWA (2013). The user can change these average unit charges in the data extracted from the central WBS cost database. Alternatively, the user can model a specific type of POTW rate structure by selecting the appropriate option on the critical design assumptions sheet of each model. The user can indicate which fee types to include (e.g., flat fee only). The model will then use “typical” unit charges for the selected fee type(s). These “typical” unit charges, which can be changed in the data extracted from the WBS cost database, reflect the average including only cities that use that specific fee type (i.e., the average not counting zeros).

C.6 Recycle to Treatment Plant Headworks

Certain liquid residuals can be recycled to the treatment plant headworks provided the system complies with the backwash recycling rule and the practice does not negatively impact finished water quality. The recommended engineering practice is that the recycle stream should be no more than 5 to 10 percent of total system flow (U.S. EPA, 2002; U.S. EPA, 1996). The only items of capital equipment required for recycling are piping and valves, although a holding tank (and, therefore, pumps) also would be necessary in most cases to meet the recommendation.

C.7 Evaporation Ponds

When large quantities of liquid residuals are generated (e.g., spent brine from ion exchange), an evaporation pond can be an appropriate management method, particularly for facilities in dry climates. Holding tanks are never necessary with an evaporation pond, even for designs with intermittent generation frequency, because the design of the pond would provide sufficient capacity to handle instantaneous flow. A minimum of two cells is recommended to ensure availability of storage space during cleaning, maintenance or emergency conditions (U.S. EPA, 1987).

When evaporation ponds are selected, the models include the following evaporation pond capital expenses: excavation, backfill, lining and dike construction. Also, when evaporation ponds are selected, the models always include the cost of a geotechnical investigation (see Appendix D). These items are in addition to the pipes and valves required to deliver residuals to the pond. The models make the following assumptions to design evaporation ponds:

- Arid climate with annual average precipitation of 70 centimeters per year (cm/yr)
- Average annual pan evaporation rate is 180 cm/yr
- Evaporation ratio (which takes into account conversion of pan to lake evaporation rate and the effect of salinity) of 0.7
- 180 days of storage with no net evaporation
- Evaporation pond safety factor (which accounts for years with below average evaporation) of 1.1
- Maximum evaporation pond cell area of 5 acres.

The user can change each of these assumptions on the critical design assumptions sheet in each model that includes the evaporation pond option. If evaporation ponds are selected, the user should also review the other climate-based assumptions included in the model (e.g., the heating and cooling requirements on the O&M assumptions sheet) to determine that they are sufficiently consistent with the assumption of an arid climate that is implicit in the selection of evaporation ponds as a residuals management method.

The use of an evaporation pond results in the generation of a secondary residual stream in the form of evaporation pond solids. The models calculate the accumulation of evaporation pond solids by including all suspended *and* dissolved solids present in the residuals. The models assume evaporation pond solids removal frequency of once per year. Users can change this latter assumption on the critical design assumption sheet of the appropriate models.

C.8 Septic System

Based on comments from peer reviewers, discharge to an in-ground septic tank and drain field (a septic system) might be an option for some liquid residuals with intermittent generation in small systems using certain technologies (e.g., adsorptive media, anion exchange). Users selecting this option should evaluate whether the characteristics of the residuals are appropriate for this type of discharge. Holding tanks are never necessary with septic systems because the design of the septic tank would provide sufficient capacity to handle instantaneous flow.

When a septic system is selected, the models include the following capital expenses:

- Septic tanks
- Excavation for septic tanks
- Distribution boxes
- Distribution pipe (perforated polyvinyl chloride)
- Drain field trench excavation
- Drain field gravel.

These items are in addition to the pipes and valves required to deliver residuals to the septic tank. Also, when a septic system is selected, the models always include the cost of a geotechnical investigation (see Appendix D). The models make the following assumptions to design septic systems:

- Minimum septic tank discharge time of 2 days
- Minimum septic tank volume of 1,000 gallons
- Maximum septic tank volume of 100,000 gallons
- Septic tank volume safety factor of 150 percent
- Long-term acceptance rate (a value, based on soil type, used by states/localities to determine the minimum drain field infiltration area) of 0.5 gallons per day per square foot
- Septic drain field trench width of 4 feet
- Septic drain field trench depth of 4 feet
- Septic drain field trench gravel depth below distribution pipe of 1 foot
- A minimum of two septic drain field trenches
- A maximum septic drain field trench length of 100 feet
- 8 feet between drain field trenches
- Septic drain field trench total gravel depth of 28 inches, based on 1 foot below and 1 foot above the distribution pipe and a 4 inch pipe diameter
- Septic drain field buffer distance of 10 feet
- Septic tank overexcavation depth of 1 foot above and to each side of the tank
- A maximum of 7 distribution pipe connections per distribution box
- Septic system distribution pipe diameter of 4 inches.

These assumptions are based on values typically found in state and local regulations for septic systems. The user can change each of these assumptions on the critical design assumptions sheet of each model that includes the septic system option. The use of a septic system results in the generation of a secondary residual stream in the form of septic tank solids. The models calculate the accumulation and disposal cost for these solids using the same assumptions used for holding tank solids (except that addition of coagulant is not included for septic systems).

C.9 Off-Site Disposal

For solid residuals, including secondary residuals like holding tank solids or evaporation pond solids, most of the models offer two options: disposal in a hazardous or non-hazardous off-site landfill. The models do not include disposal in an on-site landfill as an option. This option would be economically viable only for facilities with an existing on-site landfill—a factor that is highly site-specific. For these facilities, the cost of this option would be less than that for off-site

disposal, because it would involve much lower transportation costs. Therefore, the off-site disposal options available in the models provide a conservative cost estimate for these facilities.

For certain solid residuals, many of the models also offer two additional options: off-site disposal as a radioactive waste or off-site disposal as a hazardous and radioactive waste. The radioactive waste disposal options assume that the residuals are classified as low-level radioactive wastes (LLRW), instead of technologically-enhanced, naturally-occurring radioactive materials (TENORM). In some cases, TENORM is accepted at traditional non-hazardous or hazardous waste disposal facility. In such cases, disposal costs would be lower than those at specialized radioactive waste disposal sites. Therefore, the LLRW disposal costs assumed in the models provide a conservative cost estimate for cases where residuals might be classified instead as TENORM.

The models calculate annual disposal costs for non-hazardous solid residuals as follows:

$$\text{Annual disposal costs} = \text{Disposal costs} + \text{Transportation costs}$$

where:

Disposal costs = quantity of solids per disposal event (in tons per event) x disposal frequency (in events per year) x unit cost for non-hazardous waste disposal (in dollars per ton)

Transportation costs = quantity of solids per disposal event (in tons per event) x disposal frequency (in events per year) x distance to disposal site (in miles) x unit cost for non-hazardous waste transportation (in dollars per ton per mile).

The disposal costs for hazardous, radioactive and hazardous radioactive solid residuals are calculated in a similar fashion. For transportation costs, however, there is a minimum charge per shipment applied. If transportation costs calculated based on dollars per ton per mile are less than this minimum, the models calculate transportation costs based on this minimum.

The following are the model assumptions relevant to off-site landfill disposal:

- 10 miles to the nearest non-hazardous waste disposal site
- 200 miles to the nearest hazardous waste disposal site
- 700 miles to the nearest radioactive or hazardous radioactive waste disposal site
- Maximum waste shipment size of 18 tons.

The user can change each of these assumptions on the critical design assumptions sheet of each model.

C.10 Land Application

When secondary solids (e.g., holding tank solids, evaporation pond solids) are non-hazardous, most models provide the option of assuming land application instead of landfill disposal. Users can select this option on the critical design assumptions sheet. When land application is chosen, the models assume that transportation and disposal costs for the secondary solids are zero,

although they still include the operator labor costs associated with managing the secondary solids.

C.11 Liquid Hazardous Waste Disposal

In some site-specific cases, the only viable option for certain liquid residuals (e.g., anion exchange brine) might be off-site disposal as a hazardous waste. When this option is chosen, the models automatically include a holding tank, which is required to store the residuals for shipment. Any solids that settle in the holding tank also are assumed to require hazardous waste disposal.

The models calculate costs for the liquid hazardous waste disposal option similarly to the off-site hazardous waste landfill option (e.g., disposal cost + transportation cost, with a minimum charge per shipment), except that unit costs are different. These unit costs are specific to off-site liquid hazardous waste disposal, instead of off-site hazardous waste solids landfilling, and expressed in dollars per gallon or dollars per gallon per mile. The models assume the maximum liquid hazardous waste shipment size is 6,000 gallons.

C.12 List of Abbreviations and Symbols in this Appendix

cm/yr	centimeters per year
LLRW	low-level radioactive waste
O&M	operating and maintenance
POTW	publicly owned treatment works
TENORM	technologically-enhanced, naturally-occurring radioactive materials
TSS	total suspended solids
WBS	work breakdown structure

C.13 References

American Water Works Association (AWWA). 2013. *2012 Water and Wastewater Rate Survey*. Denver, Colorado: AWWA. February.

U.S. Environmental Protection Agency (U.S. EPA). 1987. *Dewatering Municipal Wastewater Sludge*. EPA Design Manual. EPA/625/1-87/014. September.

U.S. EPA. 1996. *Technology Transfer Handbook: Management of Water Treatment Plant Residuals*. United States Environmental Protection Agency, Office of Research and Development. EPA 625-R-95-008. April.

U.S. EPA. 2002. *Filter Backwash Recycling Rule: Technical Guidance Manual*. United States Environmental Protection Agency, Office of Groundwater and Drinking Water. EPA 816-R-02-014. December.

Appendix D. Indirect Capital Costs

D.1 Introduction

Indirect capital costs are costs that are not directly related to the treatment technology used or the amount or quality of the treated water produced, but are associated with the construction and installation of a treatment technology and appurtenant water intake structures. These costs represent some of the expenditures required in order to get a technology or the treated water production process up and running. They include indirect material costs (such as yard piping and wiring), indirect labor costs (such as process engineering) and indirect burden expenses (such as administrative costs).

Indirect capital costs included in the work breakdown structure (WBS) models include the following:

- Mobilization and demobilization
- Architectural fees for treatment building
- Equipment delivery, equipment installation and contractor overhead and profit
- Site work
- Yard piping
- Geotechnical
- Standby power
- Electrical infrastructure
- Instrumentation and control
- Process engineering
- Contingency
- Miscellaneous allowance
- Legal, fiscal and administrative
- Sales tax
- Financing during construction
- Construction management and general contractor overhead
- City index.

The following sections describe each of these indirect cost elements in more detail, address their effect on capital costs and explain the reasoning behind including them as an additional indirect capital cost allowance or contingency.

D.2 Mobilization and Demobilization

Mobilization and demobilization costs are costs incurred by the contractor to assemble crews and equipment onsite and to dismantle semi-permanent and temporary construction facilities once the job is completed. The types of equipment that may be needed include: backhoes, bulldozers, front-end loaders, self-propelled scrapers, pavers, pavement rollers, sheeps-foot rollers, rubber tire rollers, cranes, temporary generators, trucks (e.g., water and fuel trucks) and trailers. In some construction contracts, mobilization costs also include performance bonds and insurance.

To estimate mobilization and demobilization costs in the absence of site-specific data, the WBS models use a multiplication factor of 2 to 5 percent. The models apply this multiplication factor to direct process costs, building costs and the physical portions of indirect capital costs (site work, yard piping, geotechnical, standby power, electrical, instrumentation and control and miscellaneous). Examples of mobilization and demobilization percentages include:

- Buckeye, Arizona Water System Infrastructure Improvements (multiple projects) Mobilization/Demobilization/Bonds/Insurance = 5 percent (Scoutten, Inc., 2009)
- City of New Port Richey Maytum Water Treatment Plant Modifications, Mobilization/Demobilization (limit included in bid instructions) = 4 percent (Tampa Bay Water, 2006)
- Alton Water Works Mobilization = 1 percent (AWWC, 1999)
- Fairfax Water Authority New Intake, Mobilization = 4.6 percent, Demobilization = 1.8 percent, Total = 6.4 percent (FWA, 2003)
- Fairfax Water Authority Trunk Sewer Project Mobilization = 5 percent (FWA, 2003)
- Forest Park Water Treatment Plant, Chalfont, PA = 0.26 percent (Allis, 2005).

The last example, for the Forest Park treatment plant, applied to a retrofit of an existing conventional filtration facility with a membrane system. The project involved modifications to existing buildings and treatment basins and the construction of one new building. Since the project involved less new construction than a greenfield project, the mobilization cost may be lower than it otherwise would be.

Mobilization/demobilization costs tend to be proportionately higher for smaller projects because of fixed costs that are the same regardless of project size. For example, if construction requires use of a large crane, then the mobilization/demobilization cost will be the same regardless of whether it is onsite for a long time to complete a large construction project or a short time to complete a small project. Therefore, small projects will most likely have mobilization/demobilization percentages in the higher end of the range and larger projects will tend to have values in the lower end of the range. The default values in the WBS models reflect this type of variation. For small systems with a design flow less than 1 million gallons per day (MGD), the default mobilization/demobilization factor is 5 percent. For medium systems (design flows between 1 MGD and 10 MGD), the default factor is 4 percent and for large systems (design flows above 10 MGD), the default factor is 2 percent. The models make an exception in the case of small systems that use pre-engineered package treatment plants. Because these package plants typically are skid-mounted, they require only a short time to install onsite and should use a minimum of heavy equipment in the process. Therefore, the models assume a mobilization/demobilization factor of 0 percent for small, pre-engineered package systems. The user can change this assumption on the indirect assumptions sheet of each model.

Because the installation costs in the models include rental of equipment for installation (see Section D.4.2), there may be some redundancy between the default mobilization and demobilization costs and the installation costs (which are included in the model unit costs). The extent of this redundancy is difficult to determine, but is a potential source of conservatism in model cost estimates (i.e., the potential redundancy would tend to make model cost results higher).

D.3 Architectural Fees for Treatment Building

The architectural fees for the treatment building include the costs of designing the structure and preparing technical drawings. By convention, the architectural fee also includes the fees for structural, electrical and mechanical engineering associated with the treatment building (RSMMeans, 2013). Furthermore, the architectural fees include the costs of preparing final drawings and the tender document package. The building costs in the WBS cost database (see Appendix B) do not include architectural fees, so the fees are added as an indirect cost. The models apply the architectural percentage only to treatment building costs, not to other process costs.

The WBS models use architectural fees from RSMMeans (2013), based upon the direct cost of the building, as shown in **Exhibit D-1**. The models make an exception in the case of small systems with a design flow of less than 1 MGD. Because they are typically housed in small, prefabricated buildings that require a minimum of design and engineering, the models assume no architectural fee for these small systems. The user can change this assumption on the indirect assumptions sheet of each model.

Exhibit D-1. Architectural Fees

Building Direct Cost Range	Architectural Fee ^a
<\$250,000	9.0%
\$250,000 to \$500,000	8.0%
\$500,000 to \$1,000,000	7.0%
\$1,000,000 to \$5,000,000	6.2%
\$5,000,000 to \$10,000,000	5.3%
\$10,000,000 to \$50,000,000	4.9%
>\$50,000,000	4.5%

a. The architectural fee is a percentage of the direct cost for buildings. It includes a structural engineering fee, as well as mechanical and electrical engineering fees that are associated with the building.

Source: RSMMeans (2013), reference table R011110-10.

D.4 Equipment Delivery, Equipment Installation and Contractor Overhead and Profit

The equipment unit cost estimates in the WBS database include the cost of equipment delivery, equipment installation and contractor overhead and profit (O&P). Because these costs are included in the direct or process costs, the default value of this multiplier in the WBS models is 0 percent. If the user has site-specific or technology-specific data that show delivery, installation or O&P costs outside of typical ranges, the user can change this factor on the indirect assumptions sheet of each model to better account for actual installation costs.

The sources of unit cost quotes include manufacturers, vendors, published construction cost data reference books and peer-reviewed literature. Price quotes for an item vary across sources because of inherent price variability or product quality differences that are not relevant to overall performance. The U.S. Environmental Protection Agency (EPA) addressed this source of price variability by including quotes from multiple vendors in the WBS cost database; the unit costs

used in the WBS models are simple averages across vendor quotes. Differences also arise because vendors include different information in price quotes. For example, prices obtained from RSMMeans (2013) include all components needed for installed process costs (i.e., delivered equipment, installation and O&P costs). Quotes from other sources may not include installation costs, contractor O&P or transportation costs. Thus, before EPA calculated average costs, all prices needed to be adjusted to the same installed cost basis. EPA converted costs to this basis by adding transportation, installation and O&P costs where they were missing from the original unit price estimates.

D.4.1 Equipment Delivery

Incorporating delivery costs in unit costs that will be used for a national cost analysis is challenging because of variability in the methods used to assess transportation costs. For example, transportation costs can be based on a cost per mile, a cost per unit of weight, a cost per unit of volume, a cost per region or within a radius or a proportion of sales price. EPA developed standardized transportation cost multipliers that vary by equipment type and size. The type of multiplier selected for each equipment category is based on a likely method of transportation.

For tanks, vessels and towers, EPA applied transportation costs that are scaled to equipment volume units (e.g., gallons). These costs are based on quotes for shipping from several vendors for tanks of varying volumes and materials. For steel tanks, the costs range from a minimum of \$600 for tanks of 1,000 gallons or less to a maximum of \$9,000 for tanks of 280,000 gallons or greater. For plastic/fiberglass tanks, the costs range from a minimum of \$120 for tanks of 1,000 gallons or less to a maximum of \$2,800 for tanks of 50,000 gallons or greater.

To estimate transportation costs for pipe, EPA calculated delivery costs per linear foot of pipe using vendor delivery cost estimates and linear feet/truck load estimates. EPA obtained a vendor delivery estimate of \$1,000 for a truckload of steel pipe. Information obtained from vendors was used to estimate the number of linear feet of each size pipe that could fit in a truckload.

For valves, pumps, blowers and mixers, EPA developed transportation cost estimates based on equipment weight and costs for “less than a load” (LTL) shipments obtained from vendors. The estimates assume an average delivery distance of 100 miles. For shipping cost estimation purposes, average weights were assumed for the small, medium and large sizes of valves, pumps, blowers and mixers. The assigned weights (which are based on the actual weights of valves, pumps, blowers and mixers for which EPA received vendor quotes) are as follows:

- Small steel valves ~ 30 pounds
- Medium steel valves ~ 80 pounds
- Large steel valves ~ 400 pounds
- Small pumps / blowers ~ 100 pounds
- Medium pumps / blowers ~ 300 pounds
- Large pumps / blowers ~ 600 pounds
- Small mixers ~ 50 pounds
- Medium mixers ~ 100 pounds
- Large mixers ~ 400 pounds.

Since the density of 304 stainless steel is approximately 5.6 times greater than the density of polyvinyl chloride, the following weights were assigned to plastic valves:

- Small plastic valve ~ 5 pounds
- Medium plastic valves ~ 15 pounds
- Large plastic valves ~ 70 pounds.

Exhibit D-2 provides the weight categories and LTL costs for valves, pumps, blowers and mixers, along with a complete summary of transportation cost methods for all categories of equipment.

EPA assumed a 2.5 percent markup on instrumentation, based on typical shipping charges from two vendors for large orders (\$600 to greater than \$4000). For system control components, EPA assumed no transportation costs, because the vendors contacted did not charge for shipping on large orders (greater than \$49 to greater than \$300). EPA assumed a 5 percent markup on miscellaneous equipment and filter components for membrane systems. Transportation costs for chemicals, resins and filter media are averages of delivery costs obtained from vendors.

D.4.2 Installation, Overhead and Profit

EPA incorporated installation and O&P costs using multipliers derived from RSMeans (2013) cost data. RSMeans provides complete installed cost estimates for the unit costs in its database. The following cost components are reported for each unit cost:

- Bare material costs, including delivery
- Installation labor, materials and any rental cost for installation equipment
- Overhead for installing contractor (i.e., labor and business overhead costs)
- Profit for installing contractor (i.e., a 10 percent rate of profit charged on materials, installation and overhead costs).

These component cost data provide enough information to calculate adjustment factors that can be applied to price quotes that exclude installation and O&P costs. By dividing total unit cost, which includes all components, by bare material cost including delivery, EPA obtained adjustment factors for several types of equipment in the WBS cost database. For example, if the bare material cost, including delivery, for an item of equipment is \$1.00 and the total unit cost is \$1.78, then the adjustment factor is 1.78. When unit costs obtained for the database did not include installation, overhead and profit (as is typical when obtaining costs from manufacturers), EPA applied these adjustment factors to escalate the unit costs so that they represented the full installed cost. For example, if a manufacturer's price for a 20,000 gallon steel tank was \$25,000, EPA would first add delivery cost (\$1,000 per 10,000 gallons capacity, as described in Section D.4.1), resulting in a cost with delivery of \$27,000. EPA would then multiply that cost by the appropriate adjustment factor (for instance, 1.17) to obtain a complete unit cost—that is, the total unit cost in this example would be $(\$25,000 + \$2,000) \times 1.17 = \$31,500$.

Most of the installation and O&P multipliers in the WBS cost database fall between 1.03 and 1.73, with an average around 1.36.

Exhibit D-2. Transportation Cost Estimation Methods

Equipment Category	Transportation Costs (year 2020 dollars)
Vessels, Tanks, Towers – steel	Varies by tank volume in gallons, from a minimum of \$600 for tanks of 1,000 gallons or less to a maximum of \$9,000 for tanks of 280,000 gallons and greater
Vessels, Tanks, Towers – plastic/fiberglass	Varies by tank volume in gallons, from a minimum of \$120 for tanks of 1,000 gallons or less to a maximum of \$2,800 for tanks of 50,000 gallons and greater
Pipes	Varies by pipe diameter and material of construction. Plastic pipes: range is \$0.37 to \$208 per 100 linear feet. Iron and steel pipes: range is \$32.68 to \$494 per 100 linear feet.
Valves-steel/iron Weight Class 60 LTL rate = \$189.13 per 100 lb	Small valves: \$57 (1" to 4" diameter) Medium valves: \$151 (5" to 9" diameter) Large valves: \$757 (>9" diameter)
Valves-plastic Weight Class 70 – plastics LTL rate = \$189.13 per 100 lb	Small valves: \$9 (1" to 3" diameter) Medium valves: \$28 (4" to 6" diameter) Large valves: \$132 (>6" diameter)
Pumps and blowers Weight Class 85 LTL rate = \$48.81 to \$189.13 per 100 lb depending on total weight	Small units: \$189 (0 to 50 gpm) Medium units: \$595 (51 to 300 gpm) Large units: \$1,757 (>300 gpm)
Mixers Weight Class 85 LTL rate = \$48.81 to \$189.13 per 100 lb depending on total weight	Small mixers: \$95 (includes mounted and portable mixers) Medium mixers: \$189 (includes inline and static mixers) Large mixers: \$978 (includes turbine, rapid, flocculant, impeller mixers)
Instrumentation	2.5% of equipment cost
System Controls	None
Miscellaneous Equipment	5% of equipment cost
RO/NF and MF/UF Skids and Equipment	5% of equipment cost
Chemicals, Resins and Filter Media	\$0.26 per lb for hazardous materials \$0.32 per lb for filter media and resins \$0.22 per lb for 150 lb chlorine cylinders \$0.29 per lb for 1 ton chlorine cylinders \$0.07 per lb for all other chemicals

lb = pound; gpm = gallons per minute; " = inch; RO/NF = reverse osmosis/nanofiltration; MF/UF = microfiltration/ultrafiltration

D.5 Site Work

Every construction site requires a certain amount of site preparation and finish work. Site work costs include site preparation, excavation and backfilling, temporary and permanent road construction, retaining wall construction, final grading, landscaping, parking lots, fencing, storm water control structures, yard structures, site cleanup, waste disposal and utilities.

Estimating the site work cost based on a factor applied to the direct capital cost is an approach commonly used when detailed information about the site plan is not known. Under this approach, site work costs are typically estimated between 5 and 15 percent of the direct capital costs, depending on project size and scope.

Site work costs vary directly with the land area requirement. The WBS models generate land area estimates, which allows the models to use an alternative cost estimation approach based on total project land area instead of total project costs. RSMeans (2013) provides an analysis of actual reported project and component costs for different types of construction. Of the many building categories reported in the summary database, the “factory” category best fits the scope of construction associated with drinking water treatment plants. Therefore, the models use the national average median project cost for site work at factories from RSMeans (2013). The WBS cost database automatically updates this unit cost to current year dollars using the Engineering News-Record (ENR) Building Cost Index (see Chapter 2). The models compute a site work cost based on this unit cost and the total project land area, excluding land used for residuals holding lagoons and evaporation ponds. Since the models include the cost of excavation and backfill for these facilities, there is no need to include them in the site work calculations.

EPA believes that using an approach based on land area instead of direct process costs provides a better estimate of site work costs because the unit costs from RSMeans (2013) are primarily based on quantities of area and earthwork volume. Furthermore, this approach is less sensitive to cost fluctuations caused by high cost equipment—the site work cost for a 0.5-acre project site will be the same regardless of whether the treatment building houses chemical addition or a membrane filtration process. This is particularly important because expensive, advanced treatment technologies often have smaller footprints than lower-cost, conventional technologies such as conventional filtration. Basing site work costs on process costs will tend to overstate site work costs for such advanced technologies.

Although the default site work cost in the WBS models reflects a median value, the user can enter a different rate in the data extracted from the WBS cost database based on site-specific conditions. A higher cost factor should be entered for projects where the site conditions may require higher-than-average site work costs (e.g., a site with steep terrain that may require retaining walls). Conversely, a lower rate should be entered for projects where the site conditions may require lower-than-average site work costs (e.g., a site where little grading is needed and where requirements for infrastructure and other site improvement are minimal or where portions are already in-place).

D.6 Yard Piping

Yard piping costs reflect the costs to install piping for untreated, partially treated and treated water to and from the site, between new treatment plant buildings or between existing and new treatment units. It does not include piping of treatment residuals to a residuals treatment system, to disposal in a sewer or to a direct discharge connection; those costs are included as explicit capital cost line items in the relevant WBS technology models, as discussed in Appendix C.

Yard piping costs include the following components:

- Trench excavation, backfill and pipe bedding
- Piping from the boundary of the building buffer zone to and from the building inlet and building outlet and in between buildings that house water treatment components
- Optionally, piping from the water source to the property boundary and piping from the property boundary to the distribution system connection

- Thrust blocks.

The sections below describe each of these components.

D.6.1 Trench Excavation, Backfill and Pipe Bedding

Costs of pipe contained in the WBS cost database are installed costs for aboveground pipes within the treatment facility. Yard piping generally is installed below ground. Therefore, yard piping entails additional costs. These costs include trench excavation costs, bedding costs, backfill costs and thrust block costs (discussed in Section D.6.3).

Technology land area requirements are calculated on a basis of starting with a square building with the required footprint and adding a non-fire buffer (10 feet) on three sides of each building and a fire buffer (40 feet) on the fourth side. The general configuration assumption is that the fire buffer will be located along the front side and the distance between buildings will be two times the non-fire buffer distance (20 feet) and, therefore, yard piping will not cross the fire buffer area. Thus, the minimum initial trench length is 20 feet (10 feet at inlet and 10 feet at outlet) for a system with one building or 30 feet (20 feet inlet and outlet and 10 feet between buildings) for a system with two buildings. Since the inlet and outlet piping may not always line up and may extend inside the building perimeter, an offset distance is added to the 10 foot buffer distance based on the building size. The offset distance is assumed to be $\frac{1}{4}$ the length of one side of the building footprint (based on square root of total building footprint).

The models assume yard piping will be buried with the top of the pipe set at or below the local frost depth. Where frost depth is less than 30 inches, a minimum depth of 30 inches is assumed to provide a protective cover. The default frost depth is 38 inches and corresponds to the frost depth in St. Louis. Users can change the frost depth on the indirect assumptions sheet of each model based, for example, on the climate data for a selected city in the climate database (AFCCC, 2000). Trench depth also incorporates the pipe diameter and the bedding depth, which the models assume to be 6 inches below the bottom of the pipe. This default value is sufficient to approximate bedding requirements for large size pipes laid in soils where bedding is necessary. The user has the option of changing the default value on the indirect assumptions sheet of each model.

Trench width is equal to the pipe diameter plus 1 foot on either side. Trench volume is based on the calculated trench length times the trench cross-sectional area, which incorporates trench width and depth and assumes sloped trench sides, with an angle of 45 degrees (expressed in radians on the indirect assumptions sheet). Excavation and backfill costs are based on total trench volume plus thrust block volume and the unit cost for excavation and backfill. Although backfill quantities are generally smaller than excavation quantities, they are assumed to be the same in the WBS models. This approach is assumed to cover to the cost of backfill and the cost of spreading or hauling excess soil off site. Pipe bedding volume accounts for the bedding depth, incorporating additional volume to account for the sloped sides of the trench and the assumption that the bedding covers 25 percent of the pipe diameter. The user can change this latter assumption on the indirect assumptions sheet of each model.

D.6.2 Piping

The basic assumptions for yard piping from the boundary of building buffer zone to and from the building inlet and building outlet and in between buildings are:

- Pipe length will be equal to trench length plus two times the trench depth.
- Pipe costs will be based on an equivalent pipe length, which will include an additional length to account for cost of fittings (e.g., elbows). The equivalent length will be equal to two times the pipe length, using the same factor used for process piping within the buildings (see Section 2.4).
- Yard piping costs do not include valves.
- Piping materials, diameter and unit cost are the same as those selected in the treatment model for inlet and outlet piping within the building.

In addition, the indirect assumptions sheet in each model contains an optional assumption for the length of yard piping from the water source and another optional assumption for the desired length of yard piping to the distribution system. Therefore, if the technology is not the initial step in the treatment train, the default value length of pipe from the water source should be 0 feet, because there is already a pipe from the water source to the existing facility. Similarly, if the technology is not the last technology in the treatment train, then the default value should be 0 feet. As a default, these assumptions are set to zero.

D.6.3 Thrust Blocks

Yard piping costs include concrete thrust blocks to hold small pipe elbows and other fittings in place. The basis of the thrust block volume calculation is thrust force in pounds. The models derive thrust force using a lookup table based on pipe diameter. Users can modify the thrust force assumptions by editing the engineering lookup table extracted from the WBS cost database. The values in the lookup table assume a pipe test pressure of 150 pounds per square inch and a pipe elbow angle of 90 degrees and account for block weight. Although both vertical and horizontal elbows are expected in every pipe-laying job, the thrust block calculations assume horizontal thrust blocks.

Using the data from the thrust force lookup table, the models calculate bearing surface area based on a conservative approach found in U.S. Army Corps of Engineers guidance (U.S. ACOE, 1992). The calculation is:

$$\text{Area} = 1.5 * T / (\text{Soil Density} * K_p * \text{Depth} * R)$$

where:

1.5 is a safety factor, which is typical for thrust block design

T is the thrust force required, derived as discussed above

Soil Density is the minimum soil bulk density, which the models assume is 1.55 grams per cubic centimeter (97 pounds per cubic foot) consistent with loamy sand, which is also on the lower end of the range for sandy soils (1.5–1.8) and the upper end of the range for silty clay (1.4–1.5) (MN NRSC, 2003)

K_p is the coefficient of passive pressure, which the models assume to be 3, based on an internal angle of friction of the soil (phi) of 30 degrees

Depth is the depth to bottom of the block, which the models calculate based on trench depth and pipe diameter

R is a reduction factor of 0.467, based on phi of 30 degrees and a vertical bearing surface (CADOT, 2001, Figure 8).

Users can adjust soil density, Kp and R on the indirect assumption sheet of each model. Note that this approach is conservative in that it considers only the bearing force of the vertical surface, which is perpendicular to the thrust force, and ignores the frictional force exerted on the bottom surface of the block. Use of deeper trench depths will result in lower thrust block costs.

D.7 Geotechnical Investigation

Construction cost estimates generally include a geotechnical allowance to provide for investigation of subsurface conditions. Subsurface conditions can affect the foundation design and construction technique. For example, a high groundwater table or soft substrate may require special construction techniques such as piles and dewatering. Thus, the actual costs of addressing subsurface conditions are site specific and can vary considerably. In addition, where a system is adding treatment technology to a site with existing structures and, therefore, the site already has an existing geotechnical investigation, additional geotechnical investigation may not be required. To account for these variations, the models include assumptions that allow the user to select whether geotechnical investigation costs should be included for low, medium and high cost estimates. The default values for these assumptions include geotechnical costs only for high-cost systems. However, the models always include geotechnical costs (regardless of the value selected for these assumptions) when certain components are included in the technology design, such as septic systems, evaporation ponds or below-grade structures like basins.

Geotechnical investigations can be as simple as digging trenches or test pits to determine the soil conditions underlying small, lightweight structures. For larger, heavier structures, site investigations generally involve drilling boreholes to extract samples of rock or soil for further study. Cost estimates in the WBS models reflect either test pit costs or borehole costs, depending on the building footprint size. For footprints of 2,000 ft² or smaller, the WBS models have costs based on hand digging test pits. All larger structures have costs based on the costs of drilling boreholes. The following sections describe the method for estimating costs for each approach.

D.7.1 Borehole Cost Analysis

The cost analysis for drilling boreholes includes preparation activities (e.g., staking the field) and actual drilling. Thus, a key cost driver is the number of boreholes needed. An additional factor is the required drilling depth.

For a large industrial building, a borehole should be drilled at the expected location for each column foundation and at locations where concentrated loads are expected to occur such as under tanks and heavy equipment. The models assume four boreholes is reasonable for structures in the range of 2,000 to 4,000 ft². For larger structures, the models assume an additional borehole for every 1,000 ft² in additional space. Thus, the requirement for structures in the range of 4,001 to 5,000 ft² is five boreholes. This approach is based on the assumption that column footings are spaced approximately 32 feet apart.

Drilling depth depends on a structure’s weight and existing knowledge of subsurface conditions. Nevertheless, a rough criterion used to develop WBS cost estimates is that boreholes should penetrate at least 1.5 times the width of the footings below the lowest portion of the footing (Krynine and Judd, 1957). The lowest portion of the footing must be below the frost line, which ranges from almost 0 feet to more than 5 feet in the continental United States. The WBS models assume a frost line depth of 38 inches, an additional safety depth of 22 inches and a footing width of 3 feet to obtain a minimum borehole depth of approximately 10 feet (5 feet + 1.5 x 3 feet).

EPA selected three different boring depths to represent a range of geologic conditions and building bearing loads. A boring depth of 10 feet applies to relatively light structures in areas where the soil conditions are predictable without any expectation of deeper strata that exhibit poor shear strength. A boring depth of 25 feet applies to moderately heavy structures in areas where subsurface conditions are less well defined, but no severe conditions are expected and where underground structures, such as basins, as deep as 20 feet need to be constructed. Similarly, a boring depth of 50 feet deep applies to heavy structures in areas where extreme or unknown subsurface conditions (such as strata with poor shear strength) may exist.

EPA developed cost estimates based on cost data for drilling activities that use a truck-mounted, 2.5-inch auger with casing and sampling from RSMMeans (2013). **Exhibit D-3** identifies the cost elements included in borehole drilling. The WBS cost database automatically updates the unit costs for these elements to current year dollars using the ENR Construction Cost Index (see Chapter 2). Costs are applied based on the selected borehole depth and total structure area rounded up to the nearest thousand ft².

Exhibit D-3. Cost Elements Included in Borehole Drilling

Item
<ul style="list-style-type: none"> • Borings, initial field stake out and determination of elevations • Borings, drawings showing boring details • Borings, report and recommendations from professional engineer • Borings, mobilization and demobilization, minimum • Borings, drill rig and crew with truck mounted auger (output 55 feet/day) • Borings, cased borings in earth, with samples, 2.5-inch diameter.

Source: RSMMeans, 2013, 02 32 13.10-0200.

D.7.2 Test Pit Cost Analysis

For smaller, less expensive buildings, boreholes are less cost effective compared to test pits or trenches that can be dug by hand or by using earth moving equipment if it is already available at the site. Because geotechnical investigations may precede site work, excavating equipment may be available to dig test pits. Therefore, for small buildings, the models use hand-dug test pits as the basis for costs. The models assume one pit for buildings up to 1,000 ft² and two pits for buildings of 1,001 to 2,000 ft².

Pit widths range from 4 feet by 4 feet to 6 feet by 8 feet (Krynine and Judd, 1957). Because this test method is limited to small buildings, the models assume pits that are 4 feet by 4 feet wide. Pit depth of 7 feet is based on a footing width of 2 feet and a frost depth of 5 feet (5 feet + 1.5 x 2

feet). The unit excavation and backfill costs are based on data from RSMMeans (2013) for hand dug pits in heavy soil. The cost of surveying and the soil sample evaluation report and recommendation from a Professional Engineer are assumed to be the same as for borings.

D.8 Standby Power

A new treatment facility sometimes requires a standby power source that can produce enough energy to operate the facility in the event of an electricity outage. Thus, the power rating or capacity of the standby generator should be sufficient to power critical operating components at the rated maximum flow capacity of the equipment (i.e., the design flow). Critical components in a treatment plant include pumps, lighting and ventilation. In addition, standby power can be required to provide space heating (if an electrical resistance heater or heat pump is used) and/or cooling in the event of a power outage. As a default, the WBS models do not include heating or cooling in their estimate of standby power requirements. The user can change the assumptions about inclusion of heating and/or cooling in standby power on the indirect assumptions sheet of each model.¹³

Also as a default, the models do not include standby power at all for small systems with a design flow of less than 1 MGD. These small systems typically operate for only a few hours each day, placing water in storage for use during the rest of the day. This operating procedure means small systems can handle short term power outages simply by postponing their operating hours, without the need for standby power systems. The user can change the assumption about including standby power for small systems on the indirect assumptions sheet of each model.

The generation capacity requirement for critical systems is based on the maximum daily load, which is the potential energy demand to meet production at the design flow rate. Since the energy requirements calculated in the models are based on continuous operation (24 hours/day and 365 days/year), the maximum power requirement in kilowatts (KW) can be estimated using the following equation:

$$\text{Power requirement for critical operating components (KW)} = \frac{[\text{annual power use by critical operating components (MWh/yr)} / 365 (\text{day/yr}) / 24 (\text{hr/day})] * 1,000 (\text{KW/MW})}{1,000 (\text{KW/MW})}$$

where:

hr = hours

MW = megawatt

MWh/yr = megawatt hours per year

yr = years

Standby power costs primarily comprise equipment purchase (e.g., a generator) and installation. Additional costs include fuel purchase and storage. Annual fuel costs for standby power generation are hard to estimate or predict, given the unpredictable nature of using the standby power generator. Typical standby generators consist of diesel engine powered generators

¹³ Note that if the assumption about including heating in standby power is changed, heating requirements will only be included in standby power if an electrical resistance heater or heat pump is used, because the other heating options (e.g., natural gas heat) do not use electricity.

(NREL, 2003). Installation costs include provisions for a foundation, fuel storage and louvered housings for larger systems. For the diesel generators typically used for standby power, EPA used installed unit costs from RSMMeans (2009a). The WBS cost database automatically updates these unit costs to current year dollars using the Producer Price Index from the Bureau of Labor Statistics for motors, generators and motor generator sets (see Chapter 2). The models multiply the appropriate unit cost, which users can change by modifying the data extracted from the WBS cost database, by the calculated standby power requirement in KW, after applying a minimum requirement of 1.5 KW (based on the smallest available standby power generator).

D.9 Electrical

The electrical cost allowance in a construction cost estimate will primarily account for electric wiring inside structures, such as wiring for motors, duct banks, motor control centers, relays and lighting. The unit costs for buildings in the WBS models (see Appendix B) already incorporate general building electrical, such as building wiring and lighting fixtures and electrical engineering associated with those components. In addition, certain electrical costs (motor/drive controllers, variable frequency drives and switches) are included in direct costs for system controls and pumps. Technologies with significant process equipment located outside include an electrical enclosure as an explicit line item. Thus, the indirect cost electrical allowance only accounts for additional electrical equipment associated with the treatment facility, including outdoor lighting, yard wiring, switchgear, transformers and miscellaneous wiring. Yard wiring consists primarily of the infrastructure that connects a new treatment facility to the power grid and, if necessary, converts voltage.

Typical electrical percentages include:

- Building electrical as a percentage of building cost = 7.7 to 13.0 percent, depending on building size and quality (Association for the Advancement of Cost Engineering International [AACEI] building cost model results)
- Seymour, Indiana electrical costs as a percentage of non-electrical process costs = 12.1 percent (AWWC, 2001a)
- St. Joseph, Missouri electrical costs as a percentage of non-electrical process costs = 8.7 percent (AWWC, 2001b).

Based on these data, the electrical percentage in the WBS models is 10 percent as a default. Users can change this assumption on the indirect assumptions sheet of each model.

D.10 Instrumentation and Control

Instrumentation and control (I&C) costs include a facility control system and software to operate the system. The WBS models include detailed process cost estimates for instrumentation and control, as described in Appendix A. Therefore, the default value for I&C on the indirect assumptions sheet is 0 percent. This line item remains among the indirect costs on the output sheet of each model, however, to allow the user to incorporate any site-specific or technology-specific data that cannot be accommodated by altering the I&C design assumptions in the WBS models.

D.11 Process Engineering

Process engineering costs include treatment process engineering, unit operation construction supervision, travel, system start-up engineering, operating and maintenance manual development and production of record drawings. Process engineering as a percent of installed process capital cost ranges from 5 to 20 percent. For example, Brayton Point Power Plant Water Works process engineering costs were estimated at 8 percent of installed capital costs (Stone and Webster, 2001).

The ratio of process engineering to installed process capital cost varies based on system size and the complexity of the treatment process. In particular, engineering cost as a percentage of process cost tends to decrease as the size of the treatment plant increases. The default values in the WBS models reflect this pattern: 8, 12 and 20 percent for large, medium and small systems, respectively. The WBS models apply these percentages to installed process costs, but not building costs, because structural, mechanical and electrical engineering fees are included in the architectural fee (Section D.3).

The process engineering percentages at 13 EPA demonstration sites for low-flow packaged systems ranged from 20 to 80 percent, with a mean of 36 percent (U.S. EPA, 2004). These percentages, however, also include permitting and administrative costs. Because these costs are separate line items in the WBS models, these percentages overstate stand-alone process engineering costs. Furthermore, engineering costs can be higher for technologies in the demonstration phase than for those in wide use. Therefore, EPA retained its assumption of 20 percent process engineering cost for small systems.

D.12 Contingency Cost

Contingency cost reflects the degree of risk that management assigns to a project. This cost should reflect the statistical probability of additional project costs because of uncertainties and unlikely or unforeseen events (AACEI, 1996). These unforeseeable additional costs to the project occur because of changes in design, materials, construction methods and/or project schedule. Contingency reflects a judgment by project management or bidders to account for unforeseeable costs, thereby avoiding cost overruns. Contingency costs are included as part of a construction contract allowing the contractor to be paid extra upon authorization of design and construction changes by the project engineer (AACEI, 1996).

The risk of additional unforeseen costs associated with construction projects tends to vary with project size and complexity. Therefore, EPA developed contingency factors using both project size (i.e., total direct cost) and complexity (i.e., the technology being modeled) as input variables. Ideally, a contingency cost estimate is based on statistical data or experience from similar projects. By their nature, however, contingency costs are site specific and difficult to predict; two estimators may recommend different contingency budgets for the same project (Burger, 2003). EPA examined recommended contingency values, tabulated by project size, from an economic analysis of water services (GeoEconomics Associates Inc., 2002). The recommendations are presented in **Exhibit D-4**. These contingency rates, which range from 2 to 10 percent, are applied to the base costs (i.e., direct costs) to derive contingency cost. These rates apply to projects of low to average complexity. Water treatment construction projects typically fall into this category, depending on the technology being installed.

Exhibit D-4. Recommended Contingency Rates from an Economic Analysis of Water Services

Project Base (Direct) Cost	Contingency as a Percent of Base Costs
Up to \$100,000	10%
\$100,000 to \$500,000	8%
\$500,000 to \$1,500,000	6%
\$1,500,000 to \$3,000,000	4%
Over \$3,000,000	2%

Source: GeoEconomics Associates Inc. (2002)

The WBS models would ideally include only the part of a contingency budget that is actually spent, rather than the total amount budgeted. EPA therefore considered a Construction Industry Institute (2001) study, which included both budget estimates and actual spending for contingency in a series of heavy construction projects. **Exhibit D-5** presents the relevant results. The factors are expressed as a percentage of the total budget, rather than direct costs. These projects are not limited to water treatment systems and include a variety of heavy construction projects. The data in **Exhibit D-5** show that, with the exception of very large projects (those with total project costs of over \$100 million), the contingency cost tends to decrease as project size increased. The average contingency factor decreases from 6 to 4 percent before increasing to 7 percent for very large projects. Such very large projects are generally beyond the size of projects that can be modeled using the WBS models. **Exhibit D-5** also shows that unforeseen problems during construction tend to account for a higher share of contingency cost than design or procurement problems.

Exhibit D-5. Average Contingency Costs in Budgets for Heavy Industrial Projects

Project Size	Total Cost Budget	Contingency Budget Estimate	Contingency (% of budget)	Final Project Cost	Contingency Costs Incurred by Project Phase (Design / Procurement / Construction)	Contingency Incurred / Budgeted
<\$15	8.09	0.46	6%	\$7.76	0.34 (0.04 / 0.10 / 0.20)	74%
\$15-\$50	30.22	1.55	5%	\$29.51	1.15 (0.20 / 0.30 / 0.65)	74%
\$50-\$100	70.70	3.09	4%	\$68.19	2.24 (0.25 / 0.83 / 1.16)	72%
>\$100	214.02	15.56	7%	\$206.50	13.63 (2.00 / 4.24 / 7.39)	87%

All costs are in millions of dollars. Incurred contingency costs exclude three phases: Project Planning Phase, Demolition and Start Up.

Source: CII (2001)

The contingency factors in **Exhibit D-5** are higher than the recommended values in **Exhibit D-4**. Because **Exhibit D-5** data is empirical and the basis for the estimates in **Exhibit D-4** is not clear, EPA based its contingency factors in the WBS models primarily on the values in **Exhibit D-5**, but incorporated additional price categories below \$15 million with contingency factors above 6 percent. To create the contingency factors, EPA first converted the figures in **Exhibit D-5**, which are expressed as percentages of a total budget, to markups. For instance, if the contingency budget is 7 percent of a total budget, it represents a markup of $7 / (100 - 7)$ percent = 7.5 percent. EPA modified the markups by a factor of 0.77, which is the average ratio of incurred to budgeted

contingency costs in **Exhibit D-5**. **Exhibit D-6** presents the resulting base contingency factors. These represent the contingency or risk prior to consideration of technology complexity.

Exhibit D-6. WBS Model Contingency Factors Prior to Consideration of Technology Complexity

Project Direct Cost Range	Base Contingency Factor
<\$500,000	6.7%
\$500,000 to \$3,000,000	5.8%
\$3,000,000 to \$15,000,000	4.9%*
\$15,000,000 to \$50,000,000	4.1%*
\$50,000,000 to \$100,000,000	3.2%*
>\$100,000,000	5.8%*

* Percentages based on CII-Benchmarking & Metrics Analysis Results (CII, 2001).

While there are techniques and computer programs designed to estimate contingency factors for large projects based on construction activity risk simulation, the engineering costing literature and the example projects EPA reviewed do not provide specific quantitative guidance regarding the effect of project complexity on contingency costs. Nevertheless, the anecdotal evidence suggests that risks (and, therefore, contingency costs) increase when project complexity increases.

Among the WBS technologies, project complexity depends on the type of technology employed and the general degree of experience with the technology as it will be applied. Well-established technologies, which have a depth of construction and technology installation and operational history under a variety of conditions, are expected to have low risk with respect to unforeseen problems during construction and installation. Recently developed technologies or ones that have had limited application to a variety of water quality conditions and project sizes (or to the conditions at the project in question) are expected to have a higher degree of risk.

To account for differences in contingency values associated with technology type and project complexity, EPA identified four categories of project complexity and assigned multipliers that the models use to adjust the contingency factors (up or down) from **Exhibit D-6**:

- Low complexity = base contingency factor x 0.5
- Average complexity = base contingency factor x 1.0
- High complexity = base contingency factor x 1.5
- Very high complexity = base contingency factor x 2.0.

Thus, for each technology, the applied contingency factor combines the effects of project size and technology complexity to obtain the project specific contingency factor. EPA assigned a project complexity category to each WBS technology based on general knowledge and the application history of the technology to drinking water treatment. **Exhibit D-7** shows this default complexity category assignment. The user can change these values on the indirect assumptions sheet of each model if specific knowledge of the technology and its expected performance under the site-specific conditions warrant such a change.

The WBS models assume that contingency costs are incurred only in high cost scenarios (see Section 2.3). For low and medium cost estimates, the models assume construction is completed with a minimum of unforeseen site-specific costs and, therefore, that none of the contingency budget is incurred. Users can change this assumption on the indirect assumptions sheet of each model.

Exhibit D-7. WBS Default Complexity Factors by Technology

Technology	Risk Level Assigned to Technology	Default Complexity Factor
Acid Feed	Low	0.5
Cation Exchange	Low	0.5
Caustic Feed	Low	0.5
Chloramine	Low	0.5
Nontreatment Options	Low	0.5
Phosphate Feed	Low	0.5
Permanganate Addition	Low	0.5
Granular Activated Carbon	Average	1
Chlorine Gas	Average	1
Diffuse Aeration	Average	1
Packed Tower Aeration	Average	1
Adsorptive Media	High	1.5
Anion Exchange	High	1.5
Biological Treatment	High	1.5
Biologically Active Filtration	High	1.5
Chlorine Dioxide	High	1.5
Low-pressure Membranes (Microfiltration/Ultrafiltration)	High	1.5
Greensand Filtration	High	1.5
Hypochlorite	High	1.5
Multi-stage Bubble Aeration	High	1.5
Ozone	High	1.5
Reverse Osmosis/Nanofiltration	High	1.5
Tray Aeration	High	1.5
Ultraviolet Advanced Oxidation Processes	Very high	2
Ultraviolet Disinfection	Very high	2

D.13 Miscellaneous Allowance

In a cost estimate for a construction project, an allowance may be included for conditions or events that the estimator can anticipate, but whose cost is not known with any degree of certainty. If, for example, the site is expected to have contaminated soil that may require remediation, the allowance will incorporate the resulting costs. An allowance differs from a contingency cost, which provides contract coverage for unpredictable conditions. The allowance funds account for anticipated additional costs that should become apparent at a later stage of the project (for example, upon completion of the site investigation activities and the detailed engineering design). Much of this cost is associated with knowledge of site-related conditions.

In a national average cost estimate such as the one that the WBS models generate, it is not possible to allow for the specific conditions associated with any given site. However, the models include an allowance line item to simulate an average effect due to such conditions. The line also

accounts for the level of detail in the WBS design, since the models do not include all minor process components.

The WBS models assume a miscellaneous allowance of 10 percent as a default. Since the allowance addresses a modeling uncertainty, there is little guidance available from the cost estimation literature. Instead, the assumption must be validated by comparing WBS output to actual water treatment facility construction costs. Users can change the miscellaneous allowance on the indirect assumptions sheet of each model.

D.14 Legal, Fiscal and Administrative

This category includes project management, accounting and administrative activities related to the project, excluding permitting. The cost can range from 2 to 5 percent of the process cost. In the WBS models, this category is considered to account for administrative costs that the purchaser incurs in the course of procurement. These costs are distinct from the construction management fee, which is included as a separate indirect cost (Section D.17). The WBS models use a default value of 2 percent. Users can change this assumption on the indirect assumptions sheet of each model.

D.15 Sales Tax

Water treatment plant projects may be exempt from the sales tax, particularly those constructed with public funds. The default value in the WBS models is 0 percent, which reflects the status of taxes in social cost analysis. Taxes are considered a transfer payment and not an actual social cost, which is based on the concept of opportunity cost. Transfer payments are not included in social cost analysis, so a default value of 0 percent is appropriate for social cost analysis. The WBS models include a sales tax line item among indirect costs because the models can also be used for private cost analysis (e.g., for a specific utility), which includes transfer payments. Users can enter a sales tax percentage on the indirect assumptions sheet of each model in cases where consideration of transfer payments is appropriate.

D.16 Financing During Construction

Engineering cost estimates include interest for financing of the project. Drinking water systems can obtain financing through various sources including Drinking Water State Revolving Funds (DWSRF), public-sector financing, private-sector borrowing or equity instruments. **Exhibit D-8** shows interest rates for drinking water treatment projects derived from the EPA 2006 Community Water Systems Survey. The default value in the WBS models is 5 percent, which is toward the higher end of the range of financing costs for public and private systems, and implicitly assumes 1 year of financing during construction. For small systems with design flow less than 1 MGD, the models assume 0 percent financing during construction, implicitly accounting for the very short construction time required for these systems. Users can change the assumptions for both large and small systems on the indirect assumptions sheet of each model.

Exhibit D-8. Average Interest Rates for Capital Funds

System Ownership Type	Lender	Average Interest Rate (All System Sizes)	Range of Average Interest Rates
Public	DWSRF	2.3	1.0 – 3.5
Public	Other Public Sector	3.5	0.5 – 4.4
Public	Private Sector	4.6	4.2 – 5.0
Public	Other	3.9	0.0 – 4.9
Private	DWSRF	5.6	0.8 – 6.2
Private	Other Public Sector	4.4	3.1 – 5.5
Private	Private Sector	6.5	4.3 – 7.7
Private	Other	5.9	0.0 – 10.0
All Systems	DWSRF	2.6	1.0 – 4.3
All Systems	Other Public Sector	3.8	1.9 – 4.5
All Systems	Private Sector	5.2	4.3 – 5.5
All Systems	Other	4.3	0.0 – 10.0
All Systems	All Lenders	Data not available	0.0 – 10.0

DWSRF = Drinking Water State Revolving Funds

D.17 Construction Management and General Contractor Overhead

As discussed in Section D.4.2, the component costs in the WBS cost database include the cost of installation, including O&P for the installing contractor. However, the installation cost does not cover the cost of insurance, performance bonds, job supervision or other costs associated with the general contractor. The WBS models account for these costs by combining costs and fees for the following items:

- Builder’s risk insurance
- Performance bonds
- Construction management.

Builder’s risk insurance is casualty insurance for the project during construction and may cover various risks, such as vandalism, fire, theft or natural disasters. According to RSMeans (2009c), a national average rate is 0.34 percent of the project cost. EPA adopted this assumption for the WBS models. Users can adjust this rate on the indirect assumptions sheet of each model.

Performance bonds compensate the owner for losses due to contractor failure to complete work according to specifications. RSMeans (2006) estimates the costs based on the total direct cost of the project, as described in **Exhibit D-9**.

Exhibit D-9. Cost of Performance Bonds

Project Direct Cost Range	Performance Bond Cost
<\$100,000	2.5%
\$100,000 to \$500,000	\$2,500 plus 1.5% of the amount over \$100,000
\$500,000 to \$2,500,000	\$8,500 plus 1.0% of the amount over \$500,000
\$2,500,000 to \$5,000,000	\$28,500 plus 0.75% of the amount over \$2,500,000
\$5,000,000 to \$7,500,000	\$47,250 plus 0.70% of the amount over \$5,000,000
>\$7,500,000	\$64,750 plus 0.60% of the amount over \$7,500,000

Source: RSMeans (2006), reference table R013113-80.

The construction management fee covers the cost of job supervision, an on-site office, main office overhead and profit. Various sources provide individual estimates for these items, but the WBS models roll them into a construction management fee to reflect a cost structure that the owner might see. RSMeans (2009c) provides a table of typical construction management rates for jobs of various sizes. EPA adapted those rates to develop those shown in **Exhibit D-10**.

Exhibit D-10. Construction Management Fees

Project Direct Cost Range	Construction Management Fee
<\$100,000	10%
\$100,000 to \$250,000	9%
\$250,000 to \$1,000,000	6%
\$1,000,000 to \$5,000,000	5%
\$5,000,000 to \$10,000,000	4%
>\$10,000,000	3.2% ^a

a. The reference quotes a fee range of 2.5% to 4% for a \$50 million project. The WBS models assume an intermediate rate for projects over \$10 million.

Source: RSMeans (2009c), division 01 11 31.20.

The indirect line item for construction management and general contractor overhead sums all of these costs. The costs can be omitted individually on the indirect assumptions sheet of each model, either by an assumption that directly controls inclusion or exclusion or by setting the appropriate percentage to zero. For example, in the case of small systems that use pre-engineered package treatment plants, the models exclude the construction management fee portion by default and include only the performance bond and builder’s risk insurance. Because package plants typically are skid-mounted and assembled offsite, they typically do not require a general contractor to supervise their installation. Instead, their installation is managed by a single entity, often the vendor that supplied the package.

D.18 City Index

This indirect cost accounts for city-specific and regional variability in materials and construction costs. The city index factor included in the WBS models is expressed as a decimal number, assuming a national average of 1.0. The default value in the WBS models is set to the national average of 1.0, which is appropriate for estimating national compliance costs. Users wishing to adjust estimated costs to be more reflective of potential costs in specific geographic locations can

change the city index value on the output sheet. For example, to estimate costs for a city where construction costs are 90 percent of the national average, the user would change the city index to 0.9. One source for region- or location-specific adjustment factors is RSMMeans (2013), which publishes average construction cost indices for various three-digit zip code locations.

D.19 List of Abbreviations and Symbols in this Appendix

DWSRF	Drinking Water State Revolving Funds
EPA	U.S. Environmental Protection Agency
ENR	Engineering News-Record
ft ²	square feet
I&C	instrumentation and control
KW	kilowatt
LTL	less than a load
MGD	million gallons per day
O&P	overhead and profit
WBS	work breakdown structure

D.20 References

Association for the Advancement of Cost Engineering International (AACEI). 1996. *Certification Study Guide*. Morgantown, West Virginia.

Allis, William A. 2005. Personal communication with L. Petruzzi, SAIC. April.

Air Force Combat Climatology Center (AFCCC). 2000. *Engineering Weather Data: 2000 International Edition*. Published by the National Climatic Data Center.

American Water Works Corporation (AWWC). 1999. *Preliminary Cost Estimate Summary: Alton Water Treatment Plant, H&S no. 1862*. 7 January.

AWWC. 2001a. *Seymour, Indiana Process Cost Estimate*.

AWWC. 2001b. *St. Joseph, Missouri Cost Estimate*.

Burger, Riaan. 2003. "Contingency, Quantifying the Uncertainty." *Cost Engineering* 45, no. 8. 8 August.

California Department of Transportation (CADOT). 2001. *Earth Pressure Theory and Application*.

Construction Industry Institute (CII). 2001. *Benchmarking & Metrics Analysis Results*. Austin, Texas. May.

Fairfax Water Authority (FWA). 2003. *New Construction Works Brochures*. Virginia.

GeoEconomics Associates Incorporated. 2002. *An Economic Analysis of Water Services*. Chapter 5.

Krynine, D.P. and W.R. Judd. 1957. *Principles of Engineering Geology and Geotechnics*. McGraw-Hill. New York.

Minnesota Natural Resources Conservation Services (MN NRSC). 2003. *General Guide for Estimating Moist Soil Density*. 10 May.

National Renewable Energy Laboratory (NREL). 2003. *Gas-Fired Distributed Energy Resource Technology Characterizations*. U.S. Department of Energy.

RSMeans. 2006. *Facilities Construction Cost Data*. 21st Annual Edition. Kingston, Massachusetts: RSMeans Company.

RSMeans. 2009a. *Assemblies Cost Data*. 34th Annual Edition. Kingston, Massachusetts: RSMeans Company.

RSMeans. 2009b. *Building Construction Cost Data*. 67th Annual Edition. Kingston, Massachusetts: RSMeans Company.

RSMeans. 2009c. *Facilities Construction Cost Data*. 24th Annual Edition. Kingston, Massachusetts: RSMeans Company.

RSMeans. 2013. *Facilities Construction Cost Data 2014*. 29th Annual Edition. Norwell, Massachusetts: Reed Construction Data LLC.

Scoutten, Inc. 2009. *Opinion of Probable Cost for Town Of Buckeye Water And Wastewater Infrastructure and Water Resources Improvements Associated with 2009 Development Fees*. Revised 11 May. Retrieved from <http://www.buckeyeaz.gov/DocumentView.aspx?DID=640>

Stone and Webster. 2001. *Brayton Point Station Permit Renewal Application*. Five Volumes.

Tampa Bay Water. 2006. *West Pasco Infrastructure Project, Maytum WTP Modifications, Project No. 05903*. Memorandum from Kenneth R. Herd, Director of Operations and Facilities, to Jerry L. Maxwell, General Manager. 1 December.

United States Army Corp of Engineers (U.S. ACOE). 1992. *Revision of Thrust Block Criteria in TM 5-813-5/AFM 88-10 VOL. 5 Appendix C*. Publication Number: ETL 1110-3-446. 20 August.

U.S. Environmental Protection Agency (U.S. EPA). 2004. *Capital Costs of Arsenic Removal Technologies, U.S. EPA Arsenic Removal Demonstration Project, Round 1*. EPA-600-R-04-201. Cincinnati, OH: U.S. EPA, National Risk Management Research Laboratory.

Appendix E. General Assumptions for Operating and Maintenance Costs

E.1 Introduction

The work breakdown structure (WBS) models calculate operating and maintenance (O&M) costs independently for each treatment technology. Nevertheless, there are several general assumptions and estimation functions that are common to the O&M estimates across the treatment models. This appendix describes those assumptions and functions. Any O&M cost element that is technology-specific is included in the chapter describing that technology in the main document.

The O&M costs estimated in the WBS models primarily include annual expenses for:

- Labor to operate and maintain the new treatment equipment
- Chemicals required by the treatment
- Materials needed to carry out maintenance (including small tools)
- Energy.

Costs for commercial liability insurance, inspection fees, domestic waste disposal, property insurance and other miscellaneous expenditures that are not directly related to the operation of the technology are included in the WBS models by applying a miscellaneous allowance to the total annual O&M costs. This calculation uses the same miscellaneous allowance percentage that is applied to capital costs as an indirect line item (see Appendix D). Users can change this percentage on the indirect assumptions sheet of each model.

The WBS models calculate O&M costs based on the inputs provided by the user on the input sheet and values specified on the O&M assumptions sheet. These inputs include system size, raw and finished water quality parameters and other factors that affect operation requirements such as an option in the activated alumina model to regenerate media or operate on a throw away basis. The design equations and assumptions incorporated in the O&M sheets are described below.

Despite provisions for user inputs, there are several factors that can affect site-specific O&M costs in ways that are not readily reflected in the WBS outputs. These include:

- Operator expertise
- Equipment quality, design, installation and degree of automation
- Environmental conditions (e.g., changes in raw water quality over time).

Some O&M costs components, such as energy for pumping water or chemicals for treatment, are well defined and readily estimated using an engineering cost approach. Other O&M cost drivers, however, depend on multiple factors that are difficult to quantify and, therefore, represent a challenge for estimating costs. For example, the required level of effort to operate or maintain a technology depends on the level of complexity and sophistication of the installed technology, the size of the treatment system, the professional level or education and training of the operator and state and local regulations for process staffing.

To complicate matters further, there are trade-offs between system capital costs and O&M costs. Higher cost equipment may require less intensive maintenance or less hands-on operation. For example, using mixers and tanks to prepare brine solution for regenerating an anion exchanger might reduce equipment costs compared to using salt saturators. However, salt saturators require less labor to use and potentially reduce the need for a salt storage facility. Also high quality, highly automated systems can significantly reduce labor requirements, but increase capital costs. The U.S. Environmental Protection Agency (EPA) included some adjustments to O&M costs in the WBS models to account for some types of savings, which are described below.

E.2 Labor Costs

The WBS models calculate the annual hours of O&M labor in the following categories:

- Operator labor for operation and maintenance of process equipment
- Operator labor for building maintenance
- Managerial and clerical labor.

The WBS model labor hour estimates are intended to be incremental. That is, they only include labor associated with the new treatment system components.

E.2.1 Operator Labor for Operation and Maintenance of Process Equipment

System operation includes the following primary tasks:

- Collecting data from process instruments and recording system operating parameters
- Preventative maintenance and calibration of process instruments
- Verifying the proper operation of pumps, valves and other equipment and controlling the treatment process by adjusting this equipment
- Preventative maintenance of pumps, valves and other equipment
- Inspection and maintenance of chemical supplies
- Visual inspection of the treatment facility and system components
- Other, technology-specific tasks (e.g., managing regeneration, backwash or media replacement).

Labor required for these tasks is sensitive to the level of system automation. As discussed in Section 2.3 and Appendix A, the user has the option to choose from three levels of automation: manual, semi-automated and fully automated. The assumptions about labor required for each task vary depending on the level of automation selected, as shown in **Exhibit E-1** and discussed below. Users can change these assumptions, if desired, on the O&M assumptions sheet of each model.

EPA compared model results using these assumptions with annual labor hours reported for 12 different water treatment facilities. Most of the resulting model estimates were within +50 percent to -30 percent of the annual labor hours reported for the sample facilities.

Exhibit E-1. Operator Labor Assumptions for Three Levels of Automation

Task	Manual	Semi-automated	Automated
Record system operating parameters from process instruments (includes routine sampling)	5 minutes per day per instrument	5 minutes per day	5 minutes per day
Preventative maintenance and calibration of process instruments	10 minutes per month per instrument	10 minutes per month per instrument	10 minutes per month per instrument
Verify and adjust pump operating parameters	5 minutes per day per pump	5 minutes per day per pump	None
Preventative maintenance of pumps	30.25 hours per year per pump	30.25 hours per year per pump	30.25 hours per year per pump
Verify and adjust valve positions	5 minutes per week per valve	5 minutes per week per valve	None
Preventative maintenance and inspection of valves	5 minutes per year per valve	5 minutes per year per valve	5 minutes per year per valve
Visual inspection of facility	1 minute per day per 100 square feet of facility	1 minute per day per 100 square feet of facility	1 minute per day per 100 square feet of facility
Inspect and maintain chemical supplies	120 minutes per month per chemical supply tank	120 minutes per month per chemical supply tank	120 minutes per month per chemical supply tank

Collecting Data from Process Instruments and Recording System Operating Parameters

For manual systems, the models assume 5 minutes per day per instrument associated with day-to-day operation of the treatment process (e.g., flow meter, head loss sensor). Instruments associated with intermittent processes (e.g., backwash flow meters) are not included in this estimate, because observation of these instruments is included the operator labor associated with managing the intermittent process. In semi-automated and automated systems, the control system handles the task of collecting information from the various process instruments, so operator labor is reduced to 5 minutes per day to keep a record of operating parameters.

Preventative Maintenance and Calibration of Process Instruments

Regardless of the level of automation, the models assume 5 minutes per month for each instrument, including those associated with intermittent processes. While some instruments (e.g., chlorine residual analyzers) may require calibration more frequently than monthly, others (e.g., head loss sensors) will require limited, less frequent maintenance. Therefore, the models use 10 minutes per month as an average across the various types of instruments.

Verify and Adjust Pump Operating Parameters

For manual and semi-automated systems, the models assume 5 minutes per day per pump, including metering pumps associated with continuous chemical feed processes. Pumps associated with intermittent processes (e.g., backwash pumps) are not included in this estimate,

because operation of these pumps is included the operator labor associated with managing the intermittent process. In automated systems, the control system handles this task, so no additional operator labor is required.

Preventative Maintenance of Pumps

Regardless of level of automation, the models assume 30.25 hours per year for large, frequently operated pumps (e.g., booster pumps). This estimate does not include small chemical metering pumps, but does include backwash pumps when these are operated more frequently than weekly. The estimate of 30.25 hours per year is based on a list of recommended pump maintenance activities from a vendor, combined with an independent engineering estimate of hours required for each activity, as shown in **Exhibit E-2**.

Exhibit E-2. Pump Maintenance Activities

Task	Interval	Estimated Minutes/Task	Estimated Hours/Year
Check bearing temperature	Monthly	5	1
Changing lubricant/ adjusting power level	Monthly	30	6
Disassemble for inspection, reassemble	Monthly	60	12
Check oil	Quarterly	10	0.67
Check lubricated bearings for saponification	Quarterly	10	0.67
Removal of bearings and replace, reassemble	Quarterly	60	4
Check packing and replace if necessary, reassemble	6 months	60	2
Vibration readings	6 months	10	0.33
Remove casing and inspect pump	Annual	120	2
If parts are worn, replace	Annual	varies	covered by pump materials percentage and pump useful life
Clean deposits and/ or scaling	Annual	60	1
Clean out stuffing box piping	Annual	30	0.5
Measure and record suction and discharge pipe head	Annual	5	0.08
Total All Tasks	Annual	1,815	30.25

Verify and Adjust Valve Positions

For manual and semi-automated systems, the models assume 5 minutes per week per valve on the main process line. In automated systems, the control system handles this task, so no additional operator labor is required.

Preventative Maintenance and Inspection of Valves

Regardless of level of automation, the models assume 5 minutes per year per valve on the main process line.

Visual Inspection of Facility

Regardless of level of automation, the models assume 1 minute per week per 100 square feet (ft²) of treatment system floor plan to conduct visual inspection of the overall process. This daily inspection is in addition to inspection conducted as part of routine operation and maintenance of major operational components (instruments, pumps and valves), as discussed above.

Inspect and Maintain Chemical Supplies

The models assume that chemical supplies, whether they are associated with continuous addition or intermittent use, require additional attention beyond that included in daily visual inspection. In particular, they also require labor associated with receiving chemical shipments. Regardless of level of automation, the models assume 120 minutes per month for each chemical storage tank. Although counted on the basis of the number of tanks, this estimate is intended to cover all components associated with the chemical supply system (e.g., checking pipes and valves for leaks and inspecting and maintaining small metering pumps).

Technology-Specific Tasks

Many of the technologies include activities in addition to day-to-day operation that may require operator attention, depending on the level of automation (e.g., intermittent regeneration, backwash or media replacement). Where this is the case, the technology chapters in the main document describe the specific assumptions required to calculate operator labor.

E.2.2 Labor for Building Maintenance

The WBS models include a building maintenance cost based on the building area (i.e., using a unit cost in dollars per square foot per year). EPA developed this cost based on two sources: Whitestone Research (2009) and RSMeans (2013). Specifically, EPA selected a list of appropriate building maintenance repair and repair tasks from those listed in the two sources. The selected tasks include those associated with preventative maintenance, small repairs and major repairs. EPA estimated a frequency for each task by averaging the frequency recommended in each of the two sources. **Exhibit E-3** identifies the tasks included in the maintenance and repair buildup. The models include maintenance and repair tasks for heating and cooling systems only for buildings with the relevant systems. To avoid double-counting, the task list does not include tasks in the following categories:

- Maintenance of treatment system components that are already explicitly considered in the models' maintenance labor and materials costs (e.g., pumps, valves, instruments)
- Full replacement of items that are explicitly given a useful life in the models (e.g., piping, heating and cooling systems)
- Repair tasks with a lower frequency than the useful life assumed in the models for the related WBS line item (e.g., skylight replacement has a recommended frequency of 40 years, whereas the models assume a useful life for the entire building of 37 to 40 years).

For the buildup, EPA assumed a baseline building area of 4,000 ft² and building components corresponding to a medium-quality building (see the assumptions in Appendix B). EPA estimated costs for each task using data from RSMeans (2013) and assuming that preventative maintenance and minor repairs would be conducted using in-house labor, while major repairs would be conducted using outside contractors. These costs include both labor and materials.

Because repair needs do not follow a strict schedule, EPA annualized costs with no discount rate—that is, a \$100 task with a typical frequency of 5 years is assigned an annual cost of \$20.

Labor accounts for most of the cost for the maintenance and repair tasks. Further, the Building Cost Index and Construction Cost Index, the only two cost indices in the WBS cost database that combine labor and material costs, do not include the costs of materials that are likely to be used in building maintenance. The WBS cost database therefore uses the Employment Cost Index to escalate the building maintenance costs to current year dollars.

Exhibit E-3. Building Maintenance and Repair Tasks

- Minor repairs and refinishing for concrete floors
- Repairs and waterproofing for exterior concrete block walls
- Repairs and refinishing for doors
- Roofing debris removal and inspections
- Minor repairs and replacement for roofing membranes and flashing
- Repairs to skylights
- Repairs and refinishing for interior concrete block walls
- Repairs and refinishing for drywall
- Office painting
- Vinyl tile flooring replacement
- Repairs, refinishing and replacement for acoustic tile ceilings
- Preventive maintenance, repairs and replacement for lavatories and lavatory fixtures
- Water heater preventive maintenance, cleaning and servicing, overhauls and replacement
- Repairs to pipe joints and fittings
- Cleaning of drains
- Maintenance, repair and replacement of gutters
- Repair and replacement of fans
- Inspection and replacement of sprinkler systems
- Maintenance, inspection, repair and replacement of electrical systems including switchgear, receptacles, wiring devices, voice/data outlets and structure ground
- Replacement of lamps, ballasts and lighting fixtures
- Standby generator maintenance and inspection
- Preventive maintenance of computers

E.2.3 Managerial and Administrative Labor

The models contain an assumption that managerial and administrative support levels for a new treatment plant are equal to 10 percent of the total operator hours for system operation and maintenance. This estimate is not intended to represent total administrative and managerial time at a drinking water system, because total time includes many tasks unrelated to operating a new treatment train. It only represents incremental time needed to provide administrative support for the new treatment plant, e.g., processing supply orders. It also does not include labor time associated with recordkeeping and reporting burden estimates that EPA must estimate and report independently to comply with Paperwork Reduction Act requirements. Users can change the 10

percent assumption for either or both of managerial and administrative labor on the O&M assumptions sheet of each model.

E.2.4 Labor Unit Costs

To estimate the cost of the labor calculated in each of the categories above, the models multiply labor hours by unit costs from the WBS cost database. These unit costs reflect average loaded wage rates for applicable labor categories (i.e. technical, managerial and administrative) and vary across system size. The WBS cost database uses the Employment Cost Index to escalate the rates to current year dollars. Users can change the wage rates, if desired, in the data extracted from the WBS cost database.

E.3 Chemicals

Each of the WBS models calculates annual chemical usage (in pounds or gallons per year) on a technology-specific basis. The technology chapters in the main document describe these calculations. In some models, these calculations also reflect the selected option for regeneration or disposal of spent chemicals. Annual chemical costs equal the product of the annual chemical requirements and the unit chemical costs in the WBS cost database.

E.4 Materials

The WBS models calculate the annual cost of materials in the following categories:

- Materials for maintenance of booster or influent pumps
- Materials for maintenance and operation of other, technology-specific equipment
- Replacement of technology-specific equipment that occurs on an annual basis
- Materials for building maintenance.

Pumps are operated continuously (or nearly continuously) and require preventive and routine maintenance. Pumps are common to all the technologies. Each of the models assumes the annual cost of materials for pumps is equal to 1 percent of their pre-installation capital cost to account for consumable supplies and small parts requiring frequent replacement. This assumption is based on input from the technology experts who reviewed the WBS models and commented that the initial assumption of 5 percent was too high. Users can change this assumption on the O&M assumptions sheet of each model. Although accidents or improper operation can result in a need for major repairs that increase maintenance materials costs beyond 1 percent, the models do not include these types of costs.

Some of the technologies include other equipment that may require significant maintenance (e.g., the blowers in the packed tower aeration and multi-stage bubble aeration technologies). The models for these technologies include annual costs for maintenance materials. The technology chapters in this document describe the specific calculations. In general, these calculations are based a percentage of the pre-installation capital cost of the equipment.

Some of the technologies also include equipment components (e.g., membrane filter cartridges) that require frequent replacement. Rather than treat these components as frequently replaced capital items, the models handle the replacement costs in the O&M sheet. The replacement cost calculations are based on assumptions about replacement frequency and unit costs from the WBS

component cost database. The specific calculations are in the technology sections of the main document.

The WBS models compute a cost for building maintenance that combines labor and materials. The cost is discussed in Section E.2.2.

E.5 Energy

All of the WBS models calculate the annual cost of energy in the following categories:

- Energy for operation of booster or influent pumps
- Energy for operation of other, technology-specific items of equipment
- Energy for lighting
- Energy for ventilation
- Energy for cooling
- Energy for heating.

E.5.1 Energy for Pumps and Other Equipment

Booster or influent pumps are equipment common to all the technologies. Because these pumps are operated continuously (or nearly continuously), they can represent significant energy consumption. Therefore, each of the WBS models calculates pump operating horsepower based on average flow, pump head and pump efficiency. The models then convert this operating horsepower to megawatt-hours/year assuming continuous operation. To calculate annual cost, the models then multiply the annual power requirement by the unit cost for electricity contained in the WBS component cost database.

Some of the technologies include other equipment that consumes significant quantities of energy (e.g., blowers, backwash pumps, mixers). For those technologies, the model also calculates the energy for such equipment explicitly. The technology chapters in the main document describe the specific energy calculations. In general, those calculations are similar to the energy calculation for pumps.

E.5.2 Energy for Lighting

The models calculate annual lighting requirements based on the building square footage estimate and the quality level of the building (see Appendix B). The building capital costs in the WBS cost database include the cost of light fixtures for the following light requirements:

- Sheds and low quality buildings, 0.3 watts/hour/ft² of building area
- Mid quality buildings, 0.6 watts/hour/ft² of building area
- High quality buildings, 1.2 watts/hour/ft² of building area.

Multiplying the appropriate light requirement by 8.8 results in an energy usage rate in kilowatt hours per ft² per year. This conversion is based on operation of the lights 24 hours per day, 365 days per year. EPA evaluated these assumptions by calculating the granular activated carbon contactor, pipe gallery and furnace area lighting requirements at the Richard Miller Water Treatment Plant in Cincinnati, Ohio. For this facility, the lighting requirements are 1.5, 1.0 and 0.8 watts per hour per ft² for the contactor, pipe gallery and regeneration areas, respectively, with

a weighted average of 1.0 watt per hour per ft², which is between the mid and high quality values that EPA uses in the models. Users can change the lighting requirement for each level of building quality on the O&M assumptions sheet of each model.

Because many systems are not lit during times an operator is not present, the models reduce lighting energy requirements when a full-time operator presence is not required (possible for small systems for many technologies) using the following factor (with a maximum of 1 to account for large systems that might require more than one full-time operator):

$$\text{Operator hours per year} / (24 \times 365).$$

E.5.3 Energy for Ventilation

The models calculate ventilation requirements based on the assumptions shown in **Exhibit E-4**. The technology experts who reviewed the assumptions for the WBS models confirmed the reasonableness of these assumptions, although one expert commented that the air change rate for pumps could be lower for systems in a northern climate. The WBS models continue to use the value shown, however, because it is believed to be more reasonable for a national average estimate and results in a more conservative (i.e., higher) estimate of ventilation energy consumption. All of the models use these same assumptions with the exception of chlorination, which has special ventilation requirements as described in that technology section. Users can change the ventilation assumptions, if desired, on the O&M assumptions sheet of each WBS technology model.

Exhibit E-4. Assumptions for Calculating Ventilation Requirements

Variable	Value used
Ventilation air change rate for contactor areas	3 air changes/hour
Ventilation air change rate for pump areas	20 air changes/hour
Ventilation air change rate for chemical storage areas	2 air changes/hour
Ventilation air change rate for offices	2 air changes/hour
Pressure drop across ventilation fans	0.25 pounds/ ft ²
Number of days with mechanical ventilation for small systems (less than 1 MGD)	90 days/year
Number of days with mechanical ventilation for medium systems (1 to 10 MGD)	120 days/year
Number of days with mechanical ventilation for large systems (greater than 10 MGD)	185 days/year

MGD = million gallons per day

The models first use the air change rate assumptions to calculate an overall weighted average air change rate for each building based on the equipment present in that building. The models then use this weighted average air change rate for each building in the following formula:

$$\text{Ventilation energy (kWh/yr)} = \text{DAYS} \times 24 \times 0.746 \times P_{\text{drop}} \times \text{FP} \times \text{H} \times A_{\text{changes}} / 33,000$$

where:

DAYS = days per year with mechanical ventilation

P_{drop} = pressure drop across ventilation fans (pounds/ft²)

FP = building footprint (ft²)

H = building height (feet)

A_{changes} = weighted average air change rate for the building (air changes/hour)

E.5.4 Energy for Heating and Cooling

The models calculate heating and cooling requirements based on the assumptions shown in **Exhibit E-5**. Users can change these assumptions, if desired, on the O&M assumptions sheet of each WBS technology model. These assumptions are described in greater detail below.

R-values are a measure of the effective resistance to heat flow of an insulating barrier such as a building envelope. The R-values assumed in the models (20 for walls, 49 for ceilings) are based on minimum requirements from the 2021 International Energy Conservation Code for commercial buildings in the majority of climate zones, assuming construction materials consistent with those used to develop the unit building costs (see Appendix B) (ICC, 2021). The user can change these values to reflect higher efficiency construction materials. In doing so, however, the user should also examine the unit building costs extracted from the WBS cost database to determine if they are consistent with the use of such construction materials.

Exhibit E-5. Assumptions for Calculating Heating and Cooling Requirements

Variable	Value used
R-value for walls	20 hour - ft ² - °F /BTU
R-value for ceilings	49 hour - ft ² - °F /BTU
Annual heating degree days	4,260 degree days
Annual cooling degree days	1,415 degree days
Heating ventilation/infiltration load	168,679 BTU/cfm
Cooling ventilation/infiltration load	51,771 BTU/cfm
Electric resistance heating efficiency	98%
Heat pump heating coefficient of performance	3.3
Natural gas non-condensing furnace efficiency	85%
Natural gas condensing furnace efficiency	90%
Standard oil furnace efficiency	82%
Mid-efficiency oil furnace efficiency	90%
Air conditioning energy efficiency ratio	11.8 BTU/Whr
Heat pump cooling energy efficiency ratio	11.8 BTU/Whr

BTU = British thermal unit; cfm = cubic feet per minute; Whr = watt hour

Annual heating and cooling degree days are based on data from the U.S. Energy Information Administration (U.S. EIA, 2021). Specifically, the values used in the models (4,260 heating degree days and 1,415 cooling degree days) are the national average of regional, population-weighted data. EPA derived the heating and cooling ventilation/infiltration load values from data in the Air Force Combat Climatology Center Engineering Weather Data Version 1.0 (U.S. Air Force, 2000). Specifically, EPA selected climate data for 21 cities distributed geographically

throughout the United States and calculated total annual heating and cooling losses. The values used in the WBS models (168,679 BTU/cfm heating load and 51,771 BTU/cfm cooling load) are those for the city (St. Louis) that represents the median total annual heating and cooling loss from among the 21 cities. In combination, the degree day and ventilation/infiltration load values used in the models are intended to represent a climate that produces a nationally representative total heating and cooling requirement. The user can change these values to represent a specific different climate. In doing so, however, the user should select values for the heating and cooling measures, respectively, that are consistent with one another (i.e., reflective of a realistic climate).

The remaining values in the exhibit are related to the efficiency and performance of heating and air conditioning equipment. Electric resistance heating efficiency is based on information from the U.S. Department of Energy (U.S. DOE, 1997) in combination with guidance from Rosen (2021). The heat pump heating coefficient of performance is based on requirements from the Federal Energy Management Program, assuming a heat pump that is air-cooled and in the 135,000 to less than 240,000 BTU per hour category (U.S. DOE, 2021). The four furnace efficiency assumptions consider minimum efficiencies as outlined in Title 42 of the U.S. Code Chapter 77, Subchapter III: Improving Energy Efficiency, as well as trends and definitions from the Appliance Standards Awareness Project (ASAP, 2021). EPA derived the air conditioning and heat pump cooling energy efficiency ratios by converting the minimum Seasonal Energy Efficiency Ratios for single-package units outlined in 10 CFR 430.32 to approximate energy efficiency ratios using the formula outlined in Engebrecht and Hendron (2010). The user can modify these values, as desired, to reflect the use of more or less efficient equipment.

The WBS models use the assumptions in **Exhibit E-5**, along with estimated building dimensions, to calculate total annual heating and cooling losses. The models consider both conductance losses and ventilation/infiltration losses. The models calculate conductance losses for each building using the following formulae:

$$\begin{aligned} \text{Conductance heating loss} &= 4 \times S \times H \times H_{DD} \times 24 / R_{\text{wall}} + FP \times H_{DD} \times 24 / R_{\text{ceiling}} \\ \text{Conductance cooling loss} &= 4 \times S \times H \times C_{DD} \times 24 / R_{\text{wall}} + FP \times C_{DD} \times 24 / R_{\text{ceiling}} \end{aligned}$$

where:

- S = length of building side in feet (assumed to equal the square root of the building footprint)
- H = building height (feet)
- H_{DD} = annual heating degree-days
- C_{DD} = annual cooling degree-days
- FP = building footprint (ft²)
- R_{wall} = R-value for walls
- R_{ceiling} = R-value for ceiling.

The equations above represent the total heat transfer in British thermal units (BTU)/year through all four walls and the ceiling of each building. The models assume heat transfer through the building floor is negligible.

To calculate ventilation and infiltration losses, the models first calculate the air exchange rate in cubic feet per minute (cfm) for each building using the following formula:

$$\text{Air exchange rate (cfm)} = \text{FP} \times \text{H} \times \text{A}_{\text{changes}} / 60$$

where:

H = building height (feet)

FP = building footprint (ft²)

A_{changes} = weighted average air change rate for the building (air changes/hour, as described above in the section on ventilation)

Note that, unlike the calculation for ventilation energy use, this calculation does not incorporate assumptions about the frequency of mechanical ventilation. This is because heating and cooling losses occur regardless of whether ventilation is achieved by mechanical or natural means.

The models then apply the air exchange rate calculated above to determine ventilation and infiltration losses (in BTU/year) for each building using the following formulae:

$$\text{Heating ventilation and infiltration heat loss} = \text{CFM} \times \text{H}_{\text{Vload}}$$

$$\text{Cooling ventilation and infiltration heat loss} = \text{CFM} \times \text{C}_{\text{Vload}}$$

where:

CFM = air exchange rate (cfm, as calculated above)

H_{Vload} = heating ventilation/infiltration load (in BTU/cfm)

C_{Vload} = cooling ventilation/infiltration load (in BTU/cfm)

The models then sum conductance losses and ventilation/infiltration losses to determine total annual heating and cooling requirements for each building. For cooling, the models add cooling required to compensate for the waste heat generated by pumps (and other technology-specific mechanical equipment).

The models then calculate heating and cooling energy consumption for each of several options using these requirements, BTU values for the appropriate fuel (i.e., electricity, natural gas or oil) and the efficiency factors shown in **Exhibit E-5**. For heating, the options are electric resistance heating, electric heat pump, natural gas condensing or non-condensing furnace and standard or mid-efficiency oil furnace. For cooling, the options are conventional air conditioning and electric heat pump.

The models determine whether to include heating and cooling costs (both capital and O&M) based on building size, system design flow and user input for component level (see Section 2.3), as shown in **Exhibit E-6**. Users can change these assumptions on the indirect assumptions sheet of each model. When heating and/or cooling are included, the models choose among the heating and cooling system options based on the total annualized cost of each option (annual energy cost, plus capital cost of the system annualized as discussed in Section 2.4). The models select the option with the lowest annualized cost for inclusion in the system capital costs and add the corresponding annual energy cost to O&M costs.

Exhibit E-6. WBS Model Assumptions Regarding Inclusion of Heating and Cooling

Building Square Footage	Component Cost Level Selected	System Design Flow: Less than 1 MGD	System Design Flow: 1 to 10 MGD	System Design Flow: 10 MGD or greater
500 or greater	Low	Neither	Heating Only	Heating and Cooling
500 or greater	Medium	Heating Only	Heating and Cooling	Heating and Cooling
500 or greater	High	Heating and Cooling	Heating and Cooling	Heating and Cooling
Less than 500	Low or Medium	Neither	Neither	Heating Only
Less than 500	High	Heating Only	Heating Only	Heating Only

MGD = million gallons per day

E.5.5 Energy Unit Costs

To estimate the cost of the energy consumption calculated in each of the categories above, the models use unit costs from the WBS component cost database. These unit costs represent national averages for each fuel (electricity, natural gas and diesel) obtained from the U.S. Department of Energy’s Energy Information Administration. Because energy costs are highly variable, users can change these energy unit costs, if desired, in the data extracted from the WBS cost database.

E.6 List of Abbreviations and Symbols in this Appendix

BTU	British thermal unit
cfm	cubic feet per minute
EPA	U.S. Environmental Protection Agency
ft ²	square feet
kWh	kilowatt hour
MGD	million gallons per day
O&M	operating and maintenance
U.S. DOE	U.S. Department of Energy
WBS	work breakdown structure
Whr	watt hour

E.7 References

Appliance Standards Awareness Project. 2021. *Furnaces*. Retrieved from: <https://appliance-standards.org/product/furnaces>

Code of Federal Regulations. Title 10. Part 430.32 *Energy and water conservation standards and their compliance dates*. Retrieved from: <https://www.ecfr.gov/current/title-10/chapter-II/subchapter-D/part-430/subpart-C/section-430.32>

Engbrecht, C. and Hendron, R. 2010. *Building America House Simulation Protocols*. Building Technologies Program. Retrieved from: <https://www.nrel.gov/docs/fy11osti/49246.pdf>

International Code Council (ICC). 2021. *2021 International Energy Conservation Code: Chapter 4 [CE] Commercial Energy Efficiency*. Retrieved from: <https://codes.iccsafe.org/content/IECC2021P2/chapter-4-ce-commercial-energy-efficiency>

Rosen, M. A. 2021. Chapter 4 – Exergy analysis. In El Haj Assad, M. and Rosen, M.A. (Eds.), *Design and Performance Optimization of Renewable Energy Systems* (pp. 43-60). Academic Press. <https://doi.org/10.1016/C2019-0-03733-8>

RSMeans. 2013. *Facilities Maintenance and Repair Cost Data 2014*. 21st Annual Edition. Norwell, Massachusetts: Reed Construction Data.

U.S. Air Force. 2000. *Air Force Combat Climatology Center Engineering Weather Data*. Version 1.0.

U.S. Code. Chapter 77, Subchapter III: IMPROVING ENERGY EFFICIENCY. From Title 42—THE PUBLIC HEALTH AND WELFARE. Retrieved from: <https://uscode.house.gov/view.xhtml?path=/prelim@title42/chapter77/subchapter3&edition=prelim>

U.S. Department of Energy (DOE). 1997. *Saving Energy with Electric Resistance Heating*. DOE/GO-10097-381. FS 230. Retrieved from: <https://www.nrel.gov/docs/legosti/fy97/6987.pdf>

U.S. DOE. 2021. *Incorporate Minimum Efficiency Requirements for Heating and Cooling Products into Federal Acquisition Documents*. Office of Energy Efficiency and Renewable Energy, Federal Energy Management Program. Retrieved from: <https://www.energy.gov/eere/femp/incorporate-minimum-efficiency-requirements-heating-and-cooling-products-federal>

U.S. Energy Information Administration. 2021. *Monthly Energy Review*. Table 1.9. Retrieved from: <https://www.eia.gov/energyexplained/units-and-calculators/degree-days.php>

Whitestone Research. 2009. *The Whitestone Facility Maintenance and Repair Cost Reference 2009-2010*. Fourteenth Annual Edition. October.