

APPENDIX A

List of Environmental Permits at the Los Alamos National Laboratory

[This page is intentionally blank.]

List of Environmental Permits at the Los Alamos National Laboratory

Name	Activity	Issuing and Revision Dates	Expiration Date	Administering Agency
NM0028355 Authorization to Discharge [from Outfalls] Under the National Pollutant Discharge Elimination System	A permit authorizing the Laboratory to discharge industrial and sanitary liquid effluents through outfalls under specific conditions, including water quality requirements and monitoring requirements.	Issued August 12, 2014 Effective October 1, 2014 Modified May 1, 2015	September 30, 2019	U.S. Environmental Protection Agency (EPA)
NM0890010515-1 Los Alamos National Laboratory Hazardous Waste Facility Permit	A permit regulating management of hazardous wastes at the Laboratory, including storage and treatment. The permit also has standards for closure of indoor and outdoor areas used for hazardous waste storage or disposal.	Renewed November 2010	December 2020	New Mexico Environment Department (NMED)
EPA-HQ-OW-2015-0499-0118 National Pollutant Discharge Elimination System, Pesticide General Permit	A permit authorizing the discharge of pesticides at the Laboratory that have potential to enter waters of the U.S.	Issued October 31, 2011 Reissued October 31, 2016	October 31, 2021	EPA
P100-R2M Clean Air Act, Title V Operating Permit	A permit regulating air emissions from Laboratory operations (i.e., emissions from the power plant, asphalt batch plant, permanent generators, etc.). These emissions are subject to operating, monitoring, and record-keeping requirements.	Issued August 7, 2009 Reissued October 17, 2018	February 27, 2020	NMED
New Mexico Air Quality Control Act Construction Permits	Permits regulating construction or modification of air emissions sources, including the following:			NMED
	<ul style="list-style-type: none"> Technical Area 03 power plant Permit modification 2 (NSR 2195-M3) 	Issued September 27, 2000 Reissued July 26, 2018	None	
	<ul style="list-style-type: none"> Asphalt plant at Technical Area 60 Permit revision 1 (GCP3-2195-G-R1) 	Issued October 29, 2002 Reissued September 12, 2006	None	
	<ul style="list-style-type: none"> 1600-kilowatt generator at Technical Area 33 Permit revision 4 (NSR 2195-FR4) 	Issued October 10, 2002 Reissued December 12, 2013	None	
	<ul style="list-style-type: none"> Two 20-kilowatt generators and one 225-kilowatt generator at Technical Area 33 (NSR 2195-P) 	Issued August 8, 2007	None	
	<ul style="list-style-type: none"> Data disintegrator (NSR 2195-HR1) Chemistry and Metallurgy Research Replacement facility, Radiological 	Issued October 22, 2003 Revised June 14, 2006 Issued September 16, 2005 Reissued September 25, 2012	None	

List of Environmental Permits at the Los Alamos National Laboratory

Name	Activity	Issuing and Revision Dates	Expiration Date	Administering Agency
	Laboratory/Utility/Office Building Permit revision 2 (NSR 2195-N-R2) <ul style="list-style-type: none"> • LANL exemption notifications - rock crusher removed (NSR 2195) • Technical Area 35, building 213, beryllium machining (NSR 632 R1) • Technical Area 03, building 141, beryllium technology facility (NSR 634 M2R1) • Technical Area 55 beryllium machining (NSR 1081 M1R7) 	Issued June 16, 1999 Issued December 26, 1985 Revised June 14, 2006 Issued October 30, 1986 Revised June 14, 2006 Issued July 1, 1994 Revised June 14, 2006	None None None None	
Clean Water Act, Section 404/401 Permits	The U.S. Army Corps of Engineers authorizes certain work within water courses at the Laboratory under Clean Water Act Section 404 permits. The projects below were authorized to operate under a Section 404 nationwide permit with Section 401 certification.	Effective March 19, 2017 (all current nationwide Section 404 permits) – a previous version was in effect until March 18, 2017	March 18, 2022 (all current nationwide Section 404 permits)	U.S. Army Corps of Engineers
	Water Canyon Storm Water Controls SPA-2011—00512-ABQ	24-Feb-17	March 17, 2017 (Remains on 5 years of active monitoring and annual reporting.)	
	Mortandad Wetland Enhancement SPA-2016-00179-ABQ	10-Aug-17	March 18, 2022	
	Canon de Valle Storm Water Controls SPA-2016-00179-ABQ	21-Mar-18	March 18, 2022	
	Mid-Mortandad Storm Water Controls SPA-2016-00179-ABQ	27-Mar-18	March 18, 2022	
	TA-72 Shooting Range Storm Water Controls SPA-2011-00253-AQB	28-Jan-2019	March 18, 2022	

List of Environmental Permits at the Los Alamos National Laboratory

Name	Activity	Issuing and Revision Dates	Expiration Date	Administering Agency
National Pollutant Discharge Elimination System General Permit for Discharges from Construction Activities	A general permit (not LANL-specific) authorizing the discharge of pollutants during construction activities under specific conditions. Conditions include water quality requirements, inspection requirements, erosion and sediment controls, notices of intent to discharge, preparation of storm water pollution prevention plans, and other conditions.	Effective February 16, 2017 (A previous permit expired on February 16, 2017.)	February 16, 2022	EPA
NMR050013 National Pollutant Discharge Elimination System Multi-Sector General Permit for Storm Water Discharges Associated with Industrial Activity	A general permit (not LANL-specific) authorizing facilities with some industrial activities to discharge storm water and some non-storm-water runoff. The permit provides specific conditions for the authorization, including pollutant limits to meet water quality standards, inspection requirements, compliance with biological and cultural resource protection laws, and other conditions.	Effective June 4, 2015	June 4, 2020	EPA
NM0030759 [Individual Permit] Authorization to Discharge [from Solid Waste Management Units and Areas of Concern] Under the National Pollutant Discharge Elimination System	A permit authorizing the Laboratory to discharge storm water from 405 solid waste management units and areas of concern under specific conditions. Conditions include requirements for monitoring and for corrective actions where necessary to minimize pollutants in the storm water discharges.	Issued November 1, 2010	October 31, 2015 Application for renewal submitted to the EPA in 2014 Administratively extended by the EPA pending issuance of new permit	EPA
Groundwater Discharge Permit DP-857	A permit authorizing discharges to groundwater from the Laboratory's sanitary wastewater system plant and the Sanitary Effluent Reclamation Facility	Issued December 16, 2016 Previous permit issued July 20, 1992, and administratively continued until the current permit issued	December 16, 2021	NMED
Groundwater Discharge Permit DP-1589	A permit authorizing discharges to groundwater from the Laboratory's eight septic tank/disposal systems	Issued July 22, 2016	July 22, 2021	NMED
Groundwater Discharge Permit DP-1132	A permit authorizing discharges from the TA-50 Radioactive Liquid Waste Treatment Facility to three locations: (1) Outfall 051, (2) Solar Evaporation Tank, or a mechanical evaporator system.	Issued August 29, 2018	August 29, 2023	NMED
Groundwater Discharge	A permit authorizing discharges from	Issued July 27, 2015 to Los	July 27, 2020	NMED

List of Environmental Permits at the Los Alamos National Laboratory

Name	Activity	Issuing and Revision Dates	Expiration Date	Administering Agency
Permit DP-1793	activities related to groundwater remediation projects into ground and surface water.	Alamos National Security (LANS) LLC and transferred to N3B April 30, 2018		
Groundwater Discharge Permit DP-1835	A permit authorizing the discharge of water contaminants from the injection of treated groundwater into the regional aquifer beneath Los Alamos National Laboratory (LANL).	Issued August 31, 2016 to Los Alamos National Security (LANS) LLC and transferred to N3B on April 30, 2018.	November 3, 2021	NMED

APPENDIX B

Hazardous Waste Management Facility Maps

Document Number	Title
13-0079-04	Topographic Map Showing the Location of Hazardous Waste Management Units at Technical Area 39
13-0079-06	Topographic Map Showing the Location of Hazardous Waste Management Units at Technical Area 54, Area L
13-0079-07	Topographic Map Showing the Location of Hazardous Waste Management Units at Technical Area 54, Area G
13-0079-08	Topographic Map Showing the Location of Hazardous Waste Management Units at Technical Area 54, West
18-129-13	Topographical Map Showing the Location of the Hazardous Waste Management Units at Technical Area 63
18-129-14	Topographic Map Showing the Location of Hazardous Waste Management Units at Technical Area 55
18-129-15	Topographic Map Showing the Location of Hazardous Waste Management Units at Technical Area 36
18-129-16	Topographic Map Showing the Location of Hazardous Waste Management Units at Technical Area 14
18-129-17	Topographic Map Showing the Location of Hazardous Waste Management Units at Technical Area 50
18-129-20	Topographic Map Showing the Location of Hazardous Waste Management Units at Technical Area 3
18-129-21	Topographic Map Showing the Location of Hazardous Waste Management Units at Technical Area 16

Topographic Map Showing the Location of Hazardous Waste Management Units at Technical Area 39

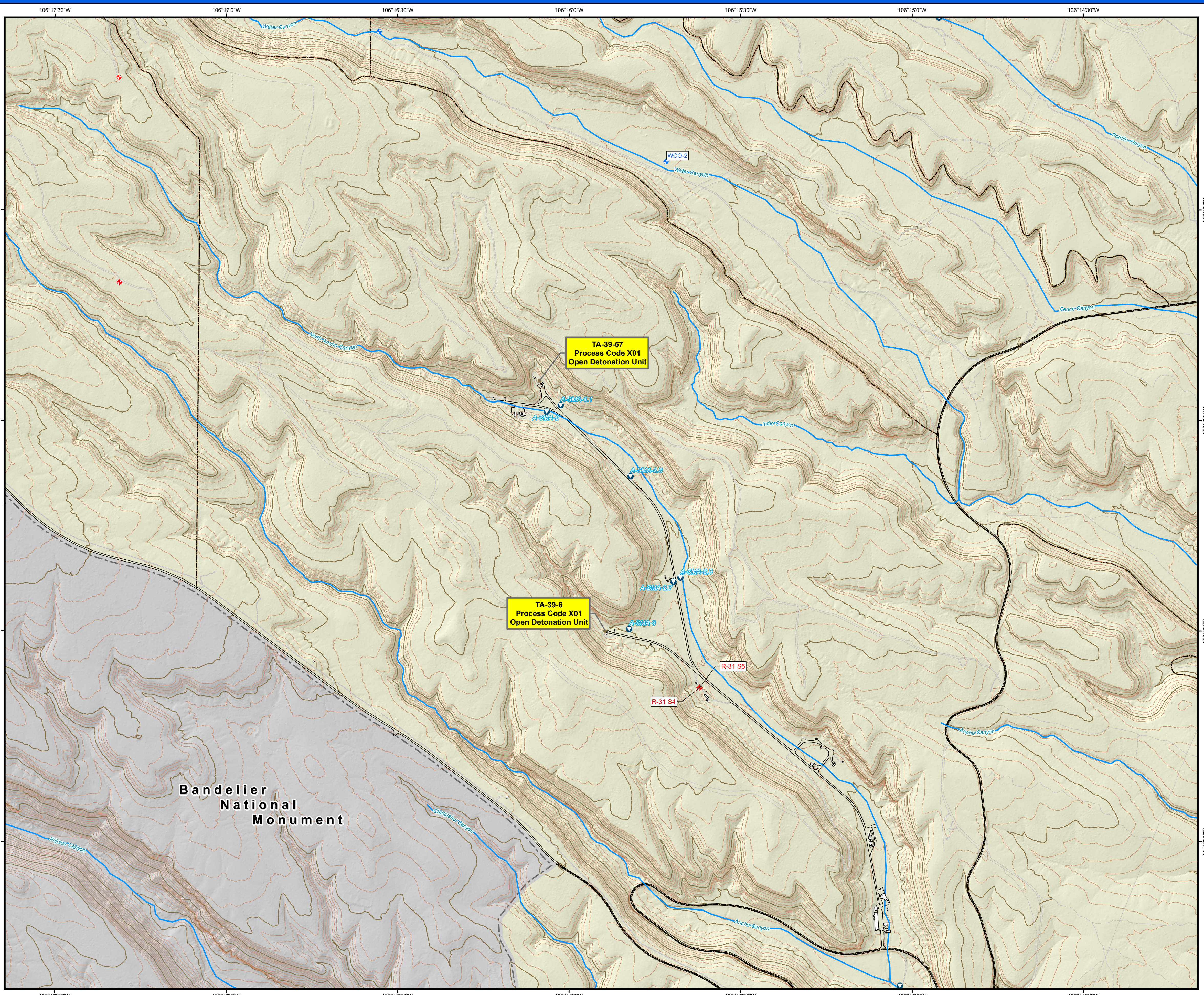

	Alluvial monitoring well
	Intermediate monitoring well
	Regional monitoring well
	Water supply well
	Springs
	NPDES Permitted Outfalls
	Site Monitoring Areas (SMAs)
	Drainage
	Contours, 100 ft
	Contours, 20 ft
	Roads, paved
	Roads, dirt
	Hazardous Waste Management Unit
	Structures
	LANL Boundary
	Technical Area

Kilometers: 0.25 0.125 0 0.25 0.5

Miles: 0.25 0.125 0 0.25 0.5

1:8,500

Revised by Bethann McVicker, 05 March 2019 Map #13-0079-04

**New Mexico State Plane Coordinate System
Central Zone US Ft
North American Datum 1983
National Geodetic Vertical Datum 1929**

Note: Labeled wells, outfalls, springs, and SMAs are within 1 mile of structure 39-57 and 39-6.

DISCLAIMER: This map was created for work processes associated with the LANL Hazardous Waste Facility Permit. All other uses for this map should be confirmed with OIO-DO staff.

Topographic Map Showing the Location of Hazardous Waste Management Units at Technical Area 54, Area L

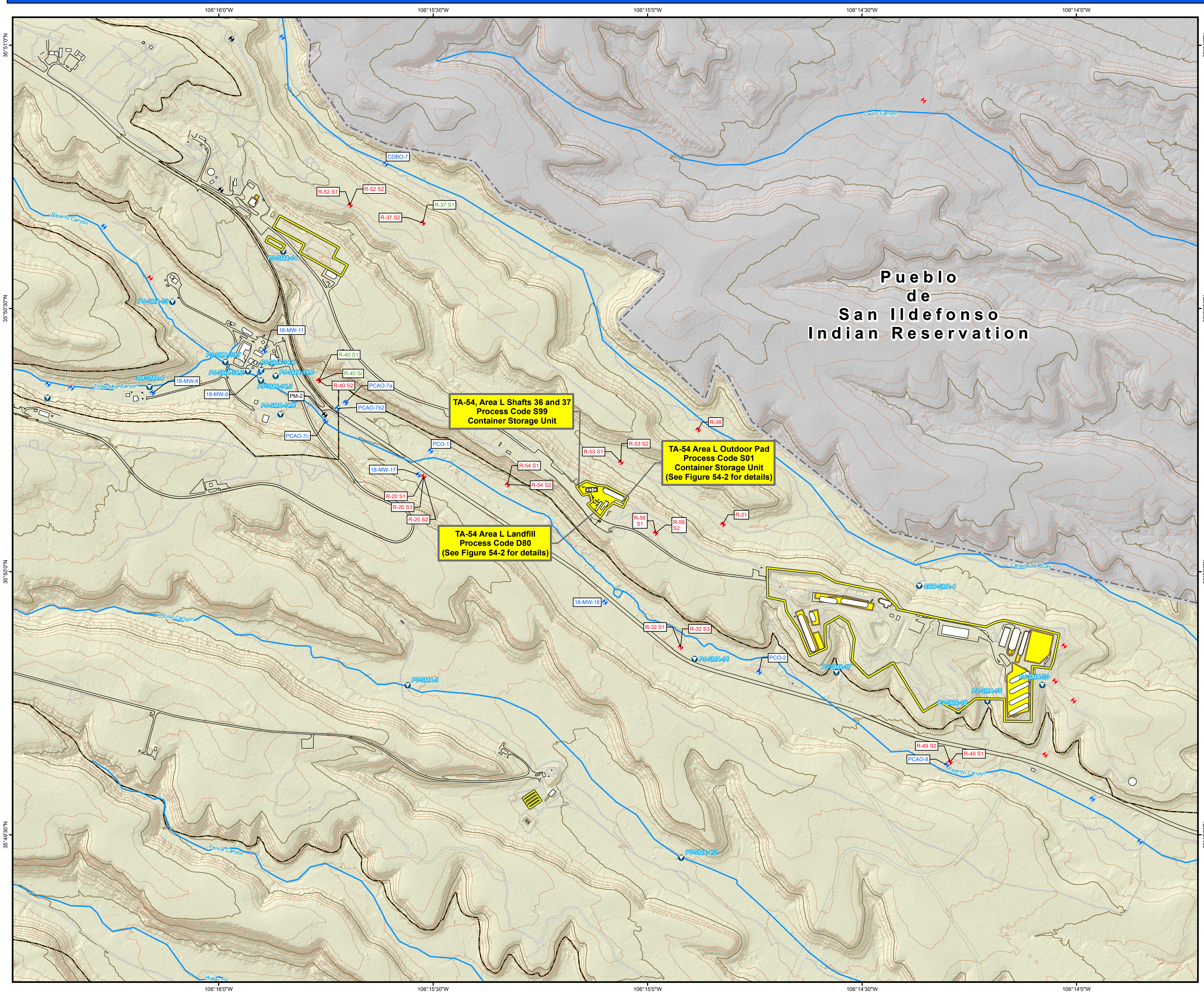

	Alluvial monitoring well
	Intermediate monitoring well
	Regional monitoring well
	Water supply well
	Springs
	NPDES Permitted Outfalls
	Site Monitoring Areas (SMAs)
	Drainage
	Contours, 100 ft
	Contours, 20 ft
	Roads, paved
	Roads, dirt
	Hazardous Waste Management Unit
	Area Boundary
	Structures
	LANL Boundary
	Technical Area

Kilometers: 0.25 0.125 0 0.25 0.5

Miles: 0.25 0.125 0 0.25 0.5

1:6,750

Revised by Bethann McVicker, 05 March 2019 Map #13-0079-06

New Mexico State Plane Coordinate System
Central Zone US Ft
North American Datum 1983
National Geodetic Vertical Datum 1929

Note: Labeled wells, outfalls, springs, and SMAs are within 1 mile of AREA L

DISCLAIMER: This map was created for work processes associated with the LANL Hazardous Waste Facility Permit. All other uses for this map should be confirmed with OIO-DO staff.

Topographic Map Showing the Location of Hazardous Waste Management Units at Technical Area 54, Area G

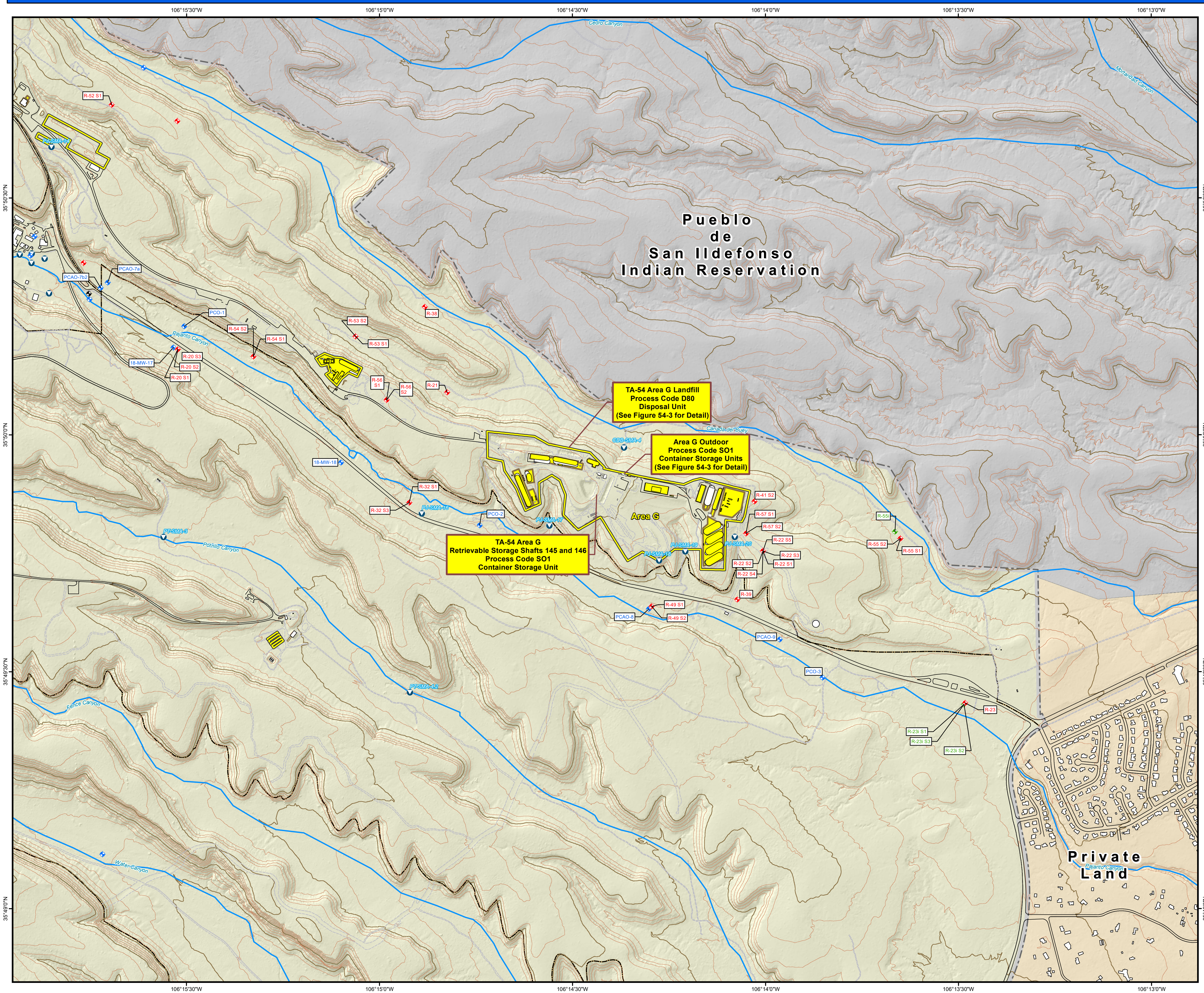

- + Alluvial monitoring well
- + Intermediate monitoring well
- + Regional monitoring well
- + Water supply well
- Springs
- NPDES Permitted Outfalls
- ▽ Site Monitoring Areas (SMAs)
- Drainage
- Contours, 100 ft
- Contours, 20 ft
- Roads, paved
- Roads, dirt
- Hazardous Waste Management Unit
- Area Boundary
- Structures
- LANL Boundary
- Technical Area

Kilometers: 0.25 0.125 0 0.25 0.5

Miles: 0.25 0.125 0 0.25 0.5

1:7,500

Revised by Bethann McVicker, 05 March 2019 Map #13-0079-07

New Mexico State Plane Coordinate System
Central Zone US Ft
North American Datum 1983
National Geodetic Vertical Datum 1929

Note: Labeled wells, outfalls, springs, and SMAs are within 1 mile of AREA G

DISCLAIMER: This map was created for work processes associated with the LANL Hazardous Waste Facility Permit. All other uses for this map should be confirmed with OIO-DO staff.

Topographic Map Showing the Location of Hazardous Waste Management Units at Technical Area 54, West

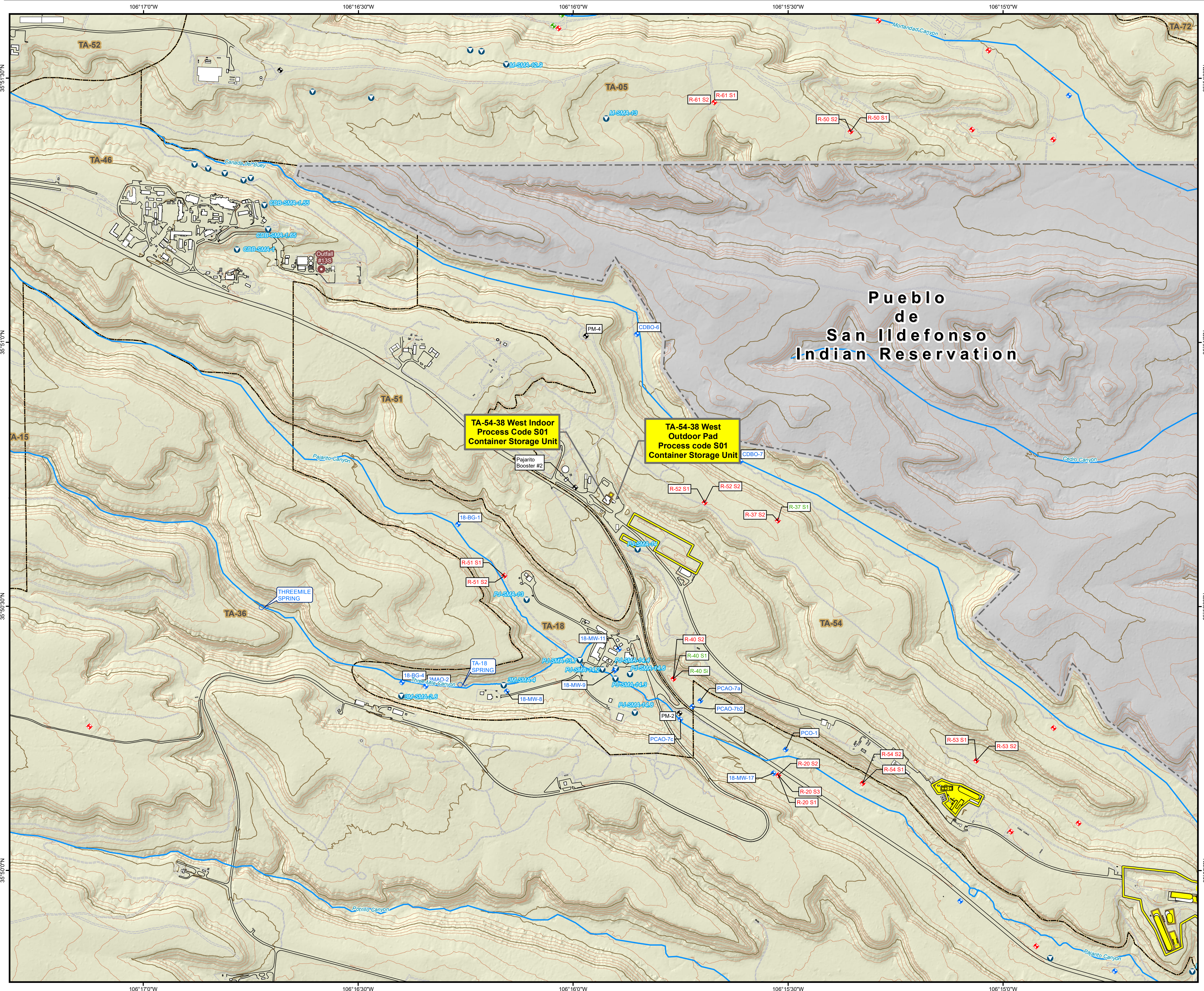

	Alluvial monitoring well
	Intermediate monitoring well
	Regional monitoring well
	Water supply well
	Springs
	NPDES Permitted Outfalls
	Site Monitoring Areas (SMAs)
	Drainage
	Contours, 100 ft
	Contours, 20 ft
	Roads, paved
	Roads, dirt
	Hazardous Waste Management Unit
	Area Boundary
	Structures
	LANL Boundary
	Technical Area

0.25 0.125 0 0.25 0.5
Kilometers

0.25 0.125 0 0.25 0.5
Miles
1:6,750

Revised by Bethann McVicker, 05 March 2019 Map #13-0079-08

New Mexico State Plane Coordinate System
Central Zone US Ft
North American Datum 1983
National Geodetic Vertical Datum 1929

Note: Labeled wells, outfalls, springs, and SMAs are within 1 mile of structure 54-0038

DISCLAIMER: This map was created for work processes associated with the LANL Hazardous Waste Facility Permit. All other uses for this map should be confirmed with OIO-DO staff.

Topographical Map Showing the Location of Hazardous Waste Management Unit at Technical Area (TA) 63

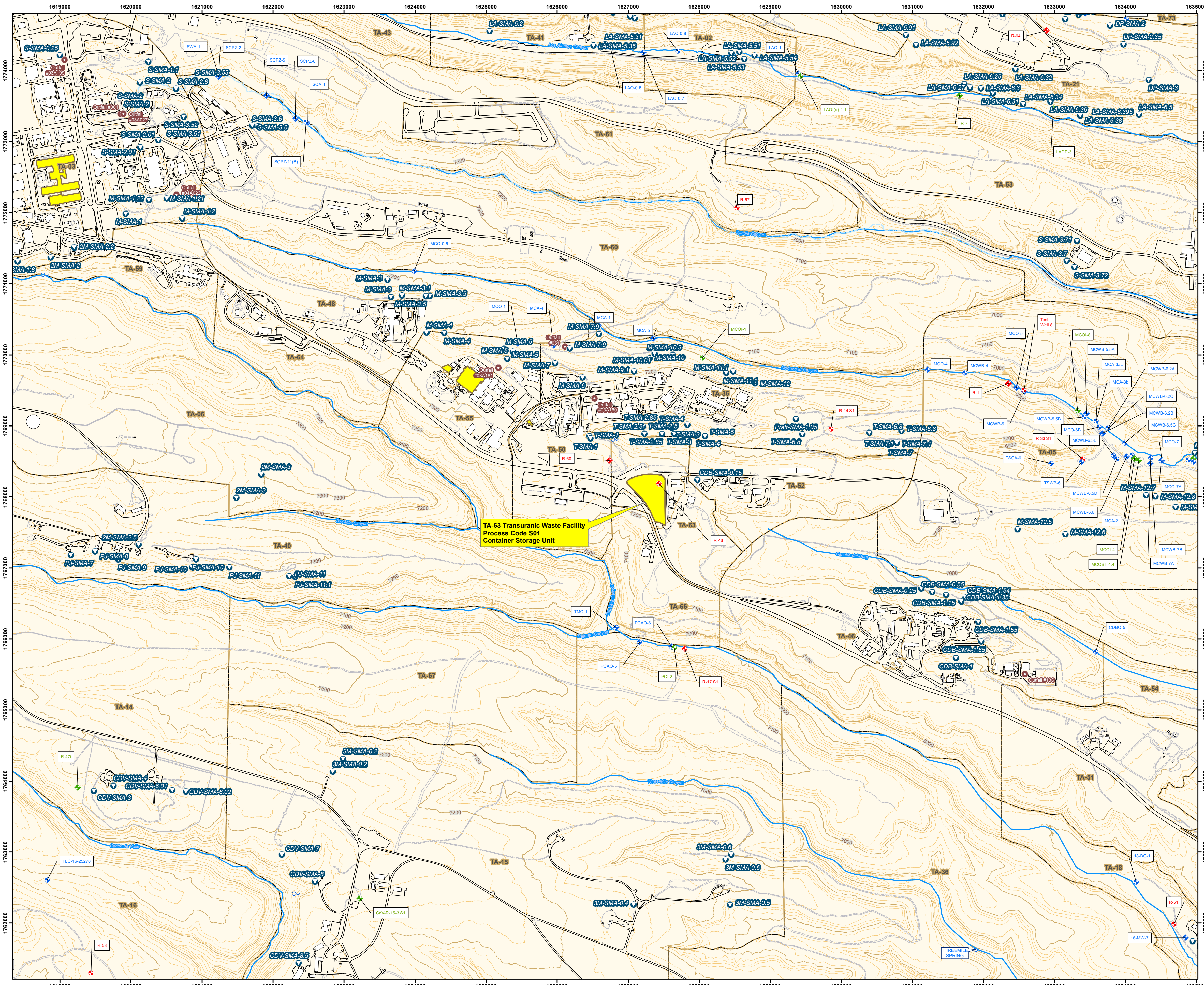

Legend

- + Alluvial
- + Intermediate
- + Regional
- NPDES Permitted Outfalls
- ▼ Site Monitoring Areas (SMAs)
- Springs
- Streams, Perennial
- Drainage
- Roads, paved
- Roads, dirt
- Contours, 20 ft
- Contours, 100 ft
- RCRA-Regulated Waste Management Unit
- Structures
- TAs

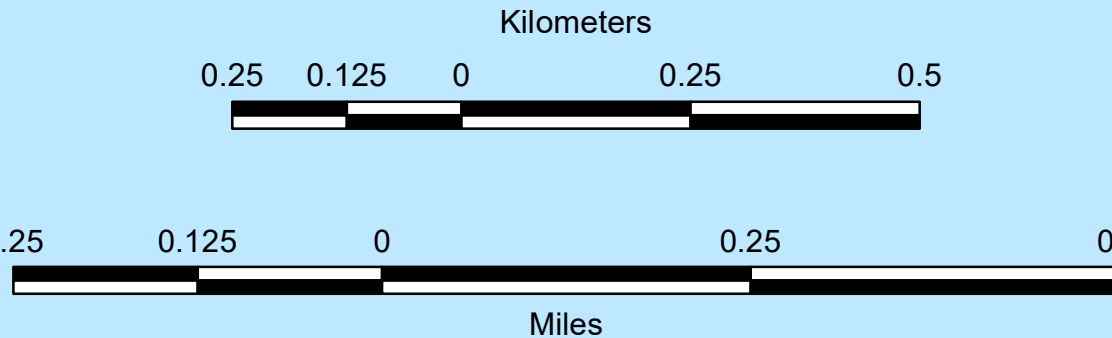

State Plane Cordinate System, New Mexico Central Zone.
1983 North American Datum.
Map Units in feet.

Grid provides NM State Plane coordinates in feet.
Grid interval: 1000 ft

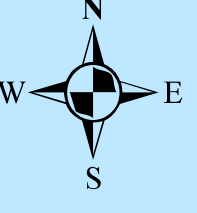

DISCLAIMER: This map was created for work processes associated with RCRA Permit. All other uses for this map should be confirmed with EPC-RCRA staff.

Note: Labeled wells, outfalls, springs, and SMAs are within 1 mile of TA-63.

GIS: Ben Sutter, ADBI-SI/Bethann McVicker
Revised Date: 13 March 2019
Map Number: 17-0042-0718-129-13

Topographic Map Showing the Location of Hazardous Waste Management Units at Technical Area 55

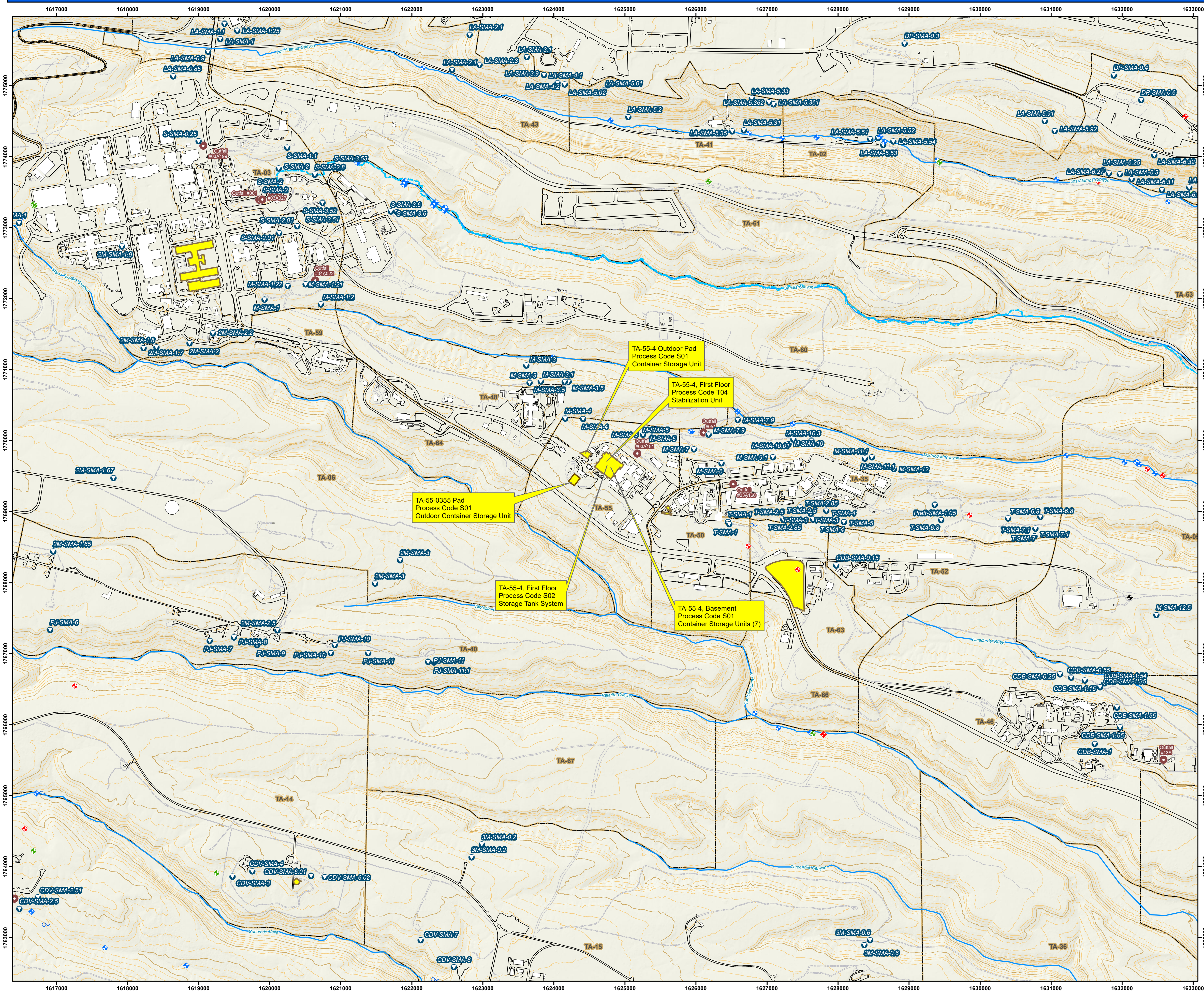

- Alluvial monitoring well
- Intermediate monitoring well
- Regional monitoring well
- Water supply well
- Springs
- NPDES Permitted Outfalls
- Site Monitoring Areas (SMAs)
- Streams, Perennial
- Drainage
- Contours, 100 ft
- Contours, 20 ft
- Roads, paved
- Roads, dirt
- Hazardous Waste Management Unit
- Structures
- TAs

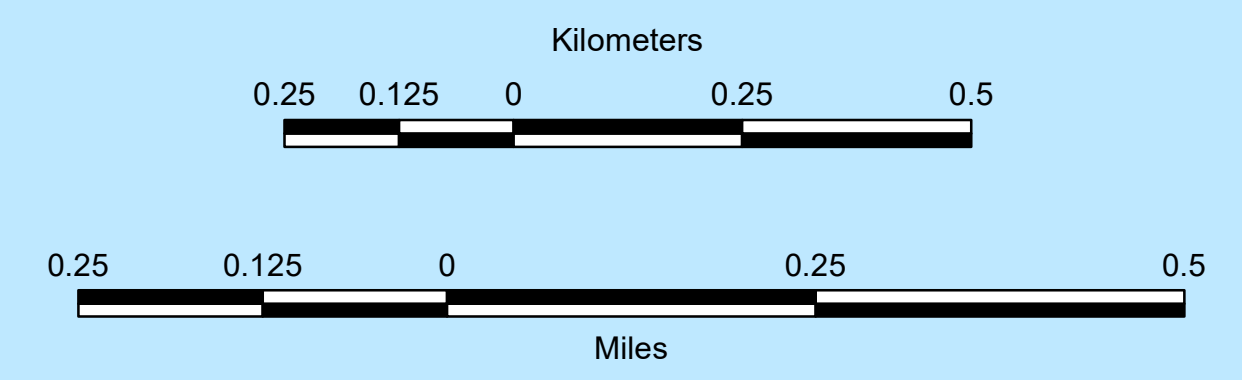
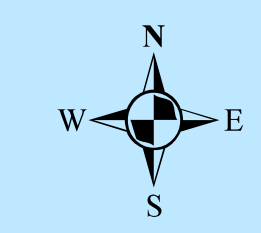

State Plane Cordinate System, New Mexico Central Zone.
 1983 North American Datum. NGVD 1929
 Map Units in feet.

Grid provides NM State Plane coordinates in feet.
 Grid interval: 1000 ft

DISCLAIMER: This map was created for work processes associated with RCRA Permit.
 All other uses for this map should be confirmed with EPC-RCRA staff.

Map Produced by ADBI-SI, Ben Sutter/Bethann McVicker
 Updated Date: 13 March 2019
 Map Reference Number: 17-0042-08_TA55/18-129-14

Topographic Map Showing the Location of Hazardous Waste Management Unit at Technical Area 36

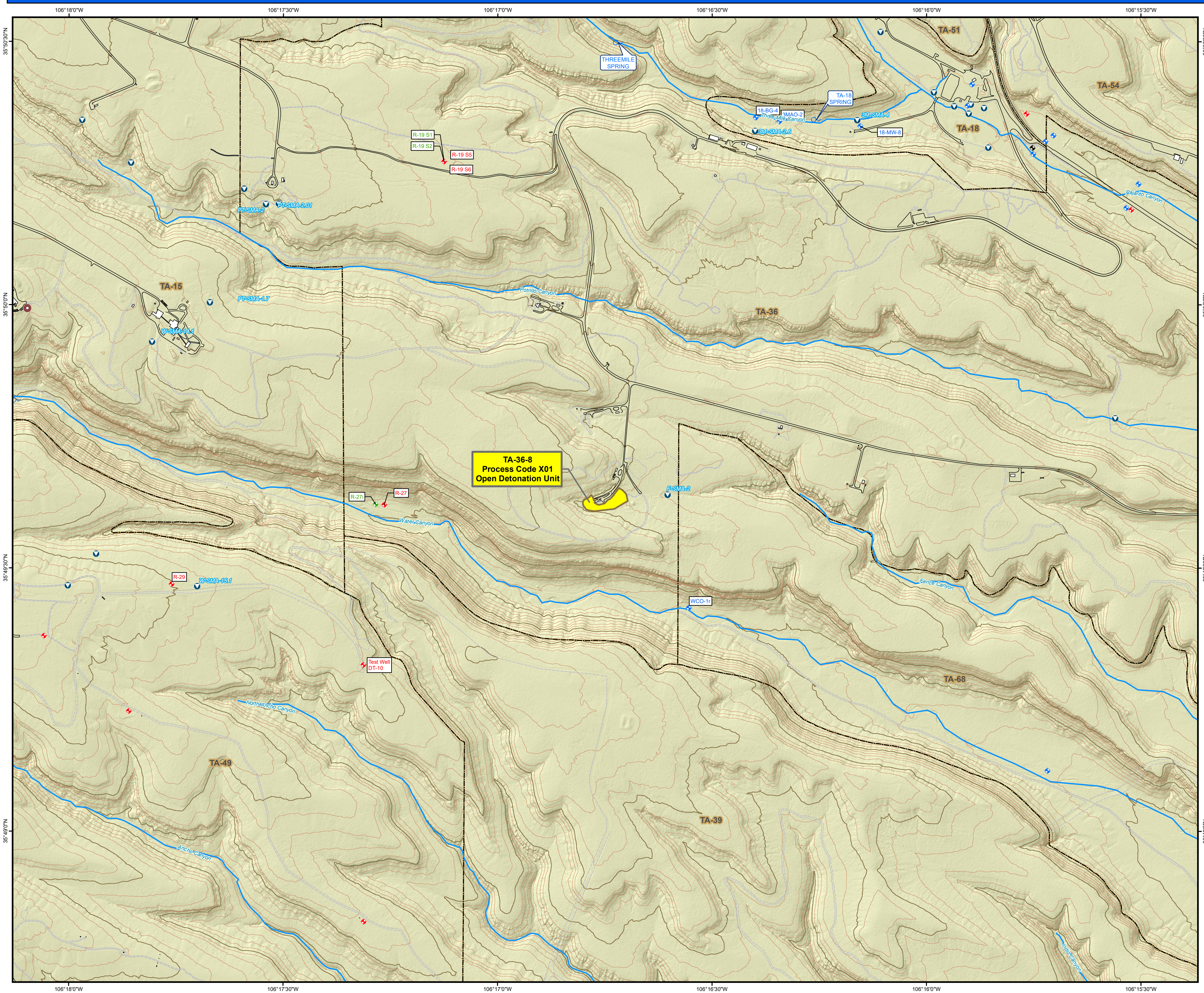

	Alluvial monitoring well
	Intermediate monitoring well
	Regional monitoring well
	Water supply well
	Springs
	NPDES Permitted Outfalls
	Site Monitoring Areas (SMAs)
	Drainage
	Contours, 100 ft
	Contours, 20 ft
	Roads, paved
	Roads, dirt
	Hazardous Waste Management Unit
	Structures
	Technical Area

0.25 0.125 0 0.25 0.5
Kilometers

0.25 0.125 0 0.25 0.5
Miles
1:6,750

Updated by Bethann McVicker, 03 March 2019 Map #18-129-15
New Mexico State Plane Coordinate System
Central Zone US Ft
North American Datum 1983
National Geodetic Vertical Datum 1929

Note: Labeled wells, outfalls, springs, and SMAs are within 1 mile of structure 36-8.

DISCLAIMER: This map was created for work processes associated with the LANL Hazardous Waste Facility Permit. All other uses for this map should be confirmed with OIO-DO staff.

Topographic Map Showing the Location of Hazardous Waste Management Units at Technical Area 14

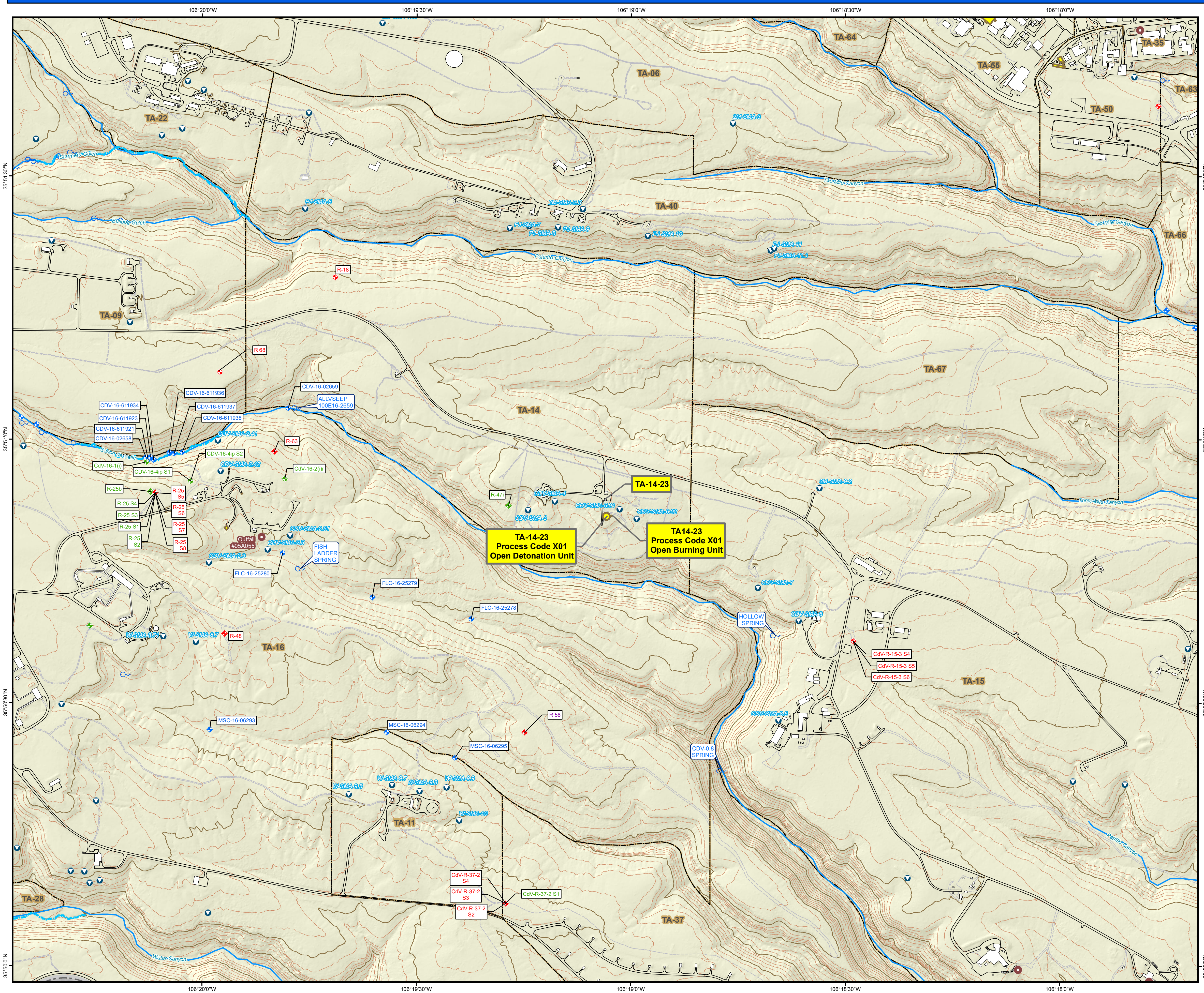

- + Alluvial monitoring well
- + Intermediate monitoring well
- + Regional monitoring well
- + Water supply well
- Springs
- NPDES Permitted Outfalls
- ▽ Site Monitoring Areas (SMAs)
- Streams, Perennial
- Drainage
- Contours, 100 ft
- Contours, 20 ft
- Roads, paved
- Roads, dirt
- Hazardous Waste Management Unit
- Structures
- Technical Area

Revised by Bethann McVicker, 05 March 2019 Map #18-129-16

New Mexico State Plane Coordinate System
Central Zone US Ft
North American Datum 1983
National Geodetic Vertical Datum 1929

Note: Labeled wells, outfalls, springs, and SMAs are within 1 mile of structure 14-23.

DISCLAIMER: This map was created for work processes associated with the LANL Hazardous Waste Facility Permit. All other uses for this map should be confirmed with IF PROG staff.

Topographic Map Showing the Location of Hazardous Waste Management Units at Technical Area 50

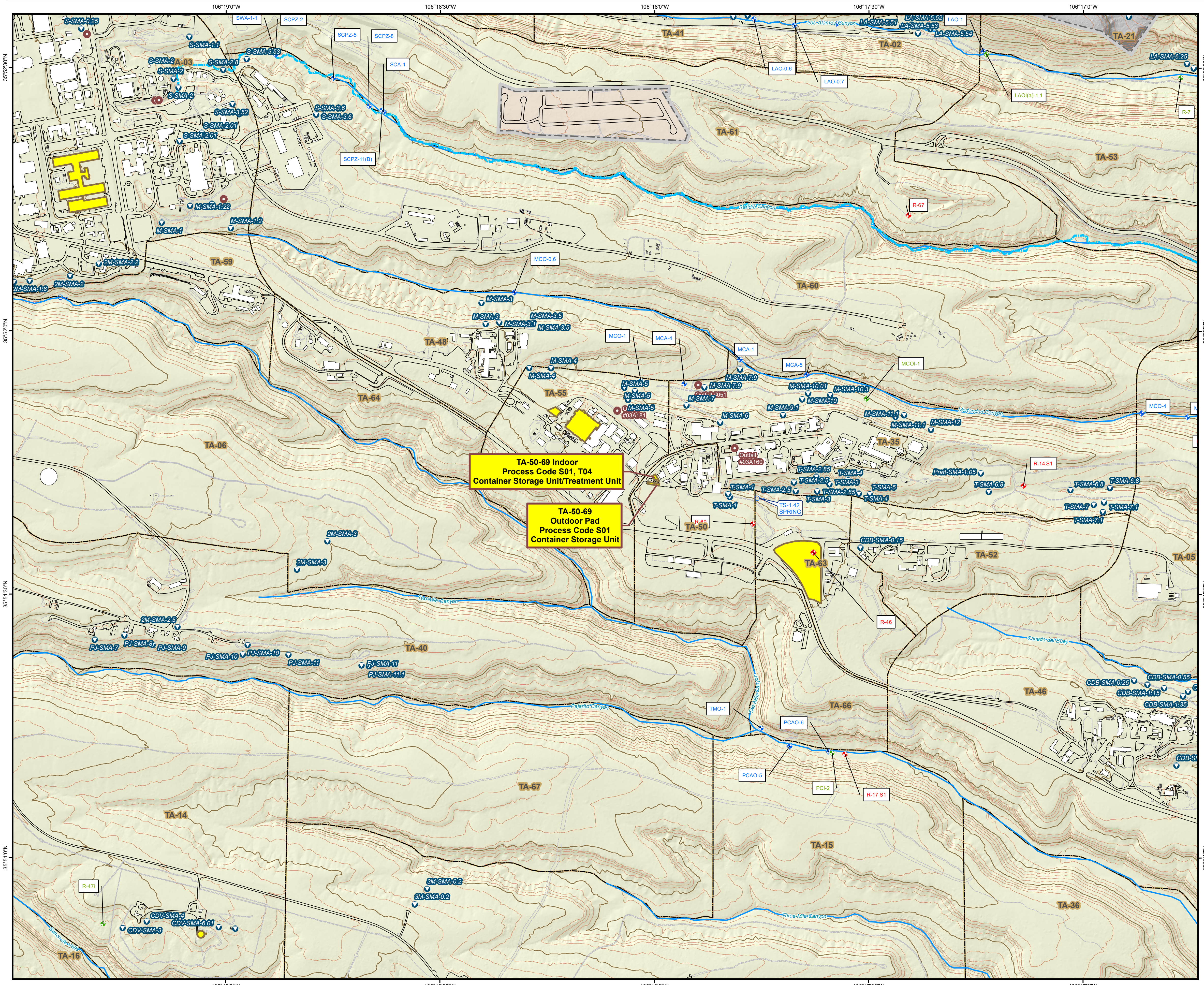

Legend

- ◆ Alluvial monitoring well
- ◆ Intermediate monitoring well
- ◆ Regional monitoring well
- ◆ Water supply well
- Springs
- NPDES Permitted Outfalls
- ▽ Site Monitoring Areas (SMAs)
- Streams, Perennial
- Drainage
- Contours, 100 ft
- Contours, 20 ft
- Roads, paved
- Roads, dirt
- Hazardous Waste Management Unit
- Structures
- Technical Area

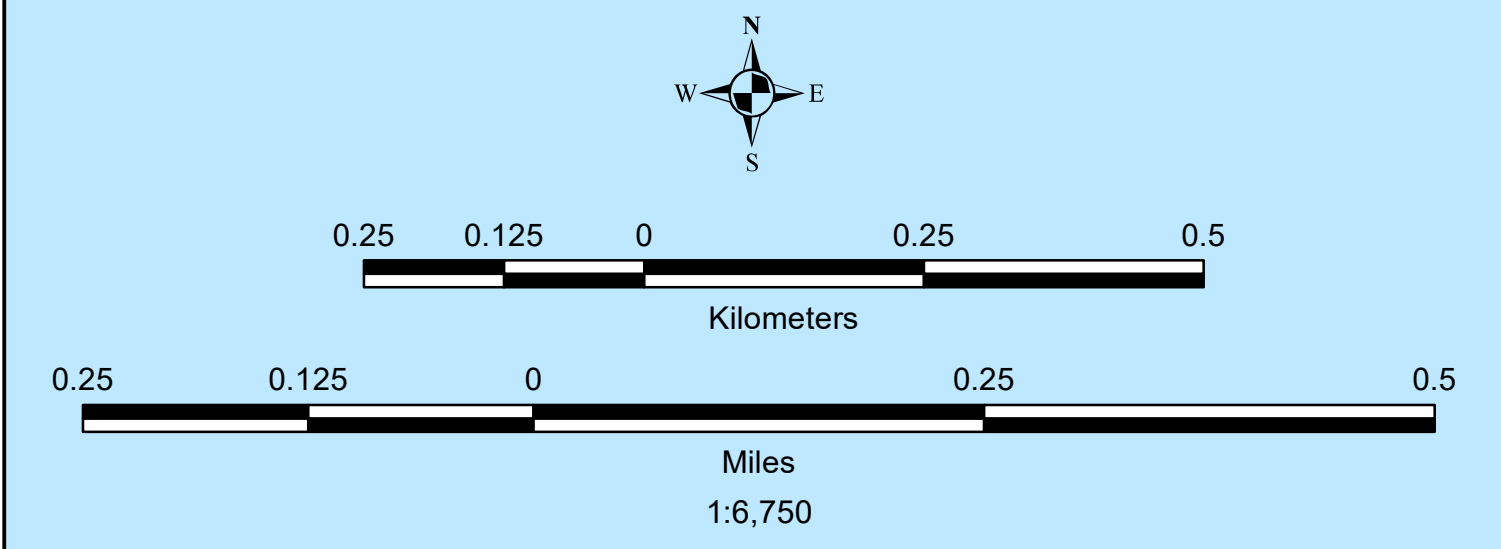

Revised by Bethann McVicker, 04 March 2019 Map #18-129-17

New Mexico State Plane Coordinate System
Central Zone US Ft
North American Datum 1983
National Geodetic Vertical Datum 1929

Note: Labeled wells, outfalls, springs, and SMAs are within 1 mile of structure 50-69.

DISCLAIMER: This map was created for work processes associated with the LANL Hazardous Waste Facility Permit. All other uses for this map should be confirmed with IF PROG staff.

Topographic Map Showing the Location of Hazardous Waste Management Units at Technical Area 3

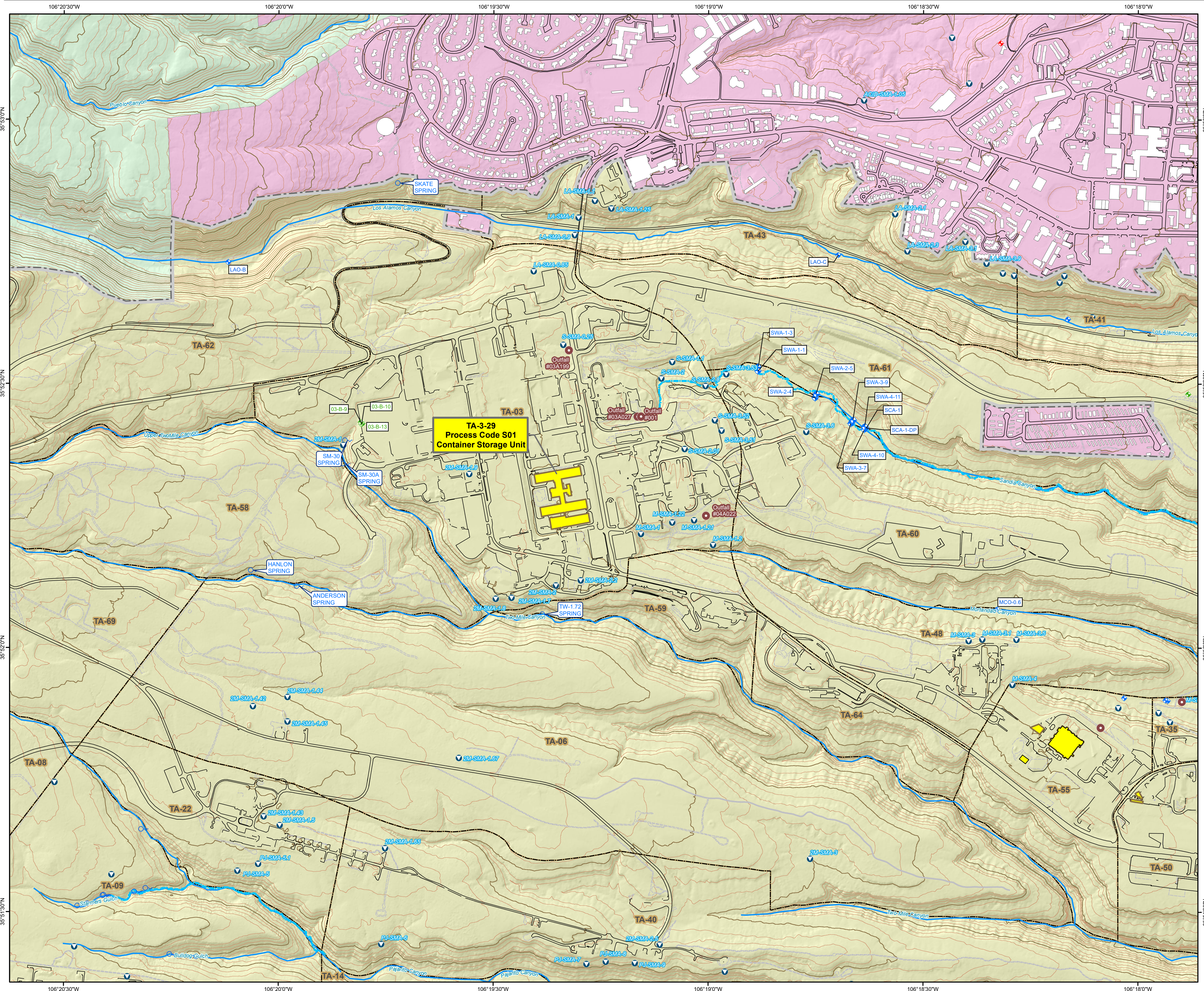

	Alluvial monitoring well
	Intermediate monitoring well
	Regional monitoring well
	Water supply well
	Springs
	NPDES Permitted Outfalls
	Site Monitoring Areas (SMAs)
	Streams, Perennial
	Drainage
	Contours, 100 ft
	Contours, 20 ft
	Roads, paved
	Roads, dirt
	Hazardous Waste Management Unit
	Structures
	LANL Boundary
	Technical Area
Boundary	
	Department of Energy
	Private Land
	US Forest Service

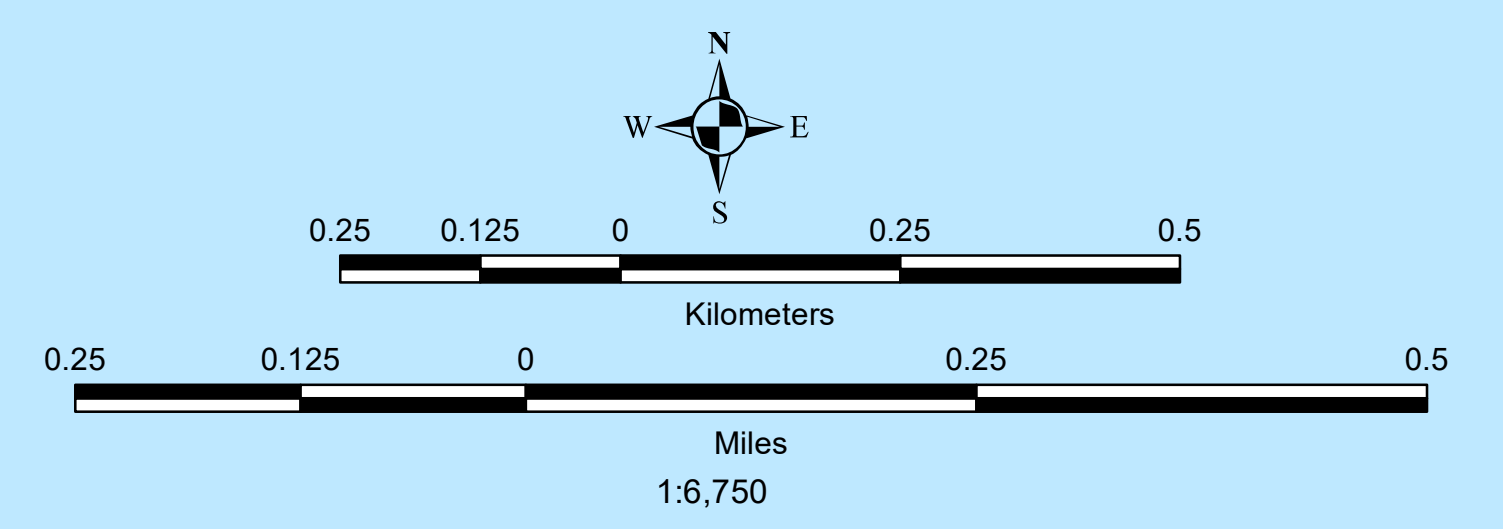

Revised by Bethann McVicker, 13 March 2019 Map #18-129-20

**New Mexico State Plane Coordinate System
Central Zone US Ft
North American Datum 1983
National Geodetic Vertical Datum 1929**

Note: Labeled wells, outfalls, springs, and SMAs are within 1 mile of structure 3-29.

DISCLAIMER: This map was created for work processes associated with the LANL Hazardous Waste Facility Permit. All other uses for this map should be confirmed with IF PROG staff.

Topographic Map Showing the Location of Hazardous Waste Management Units at Technical Area 16

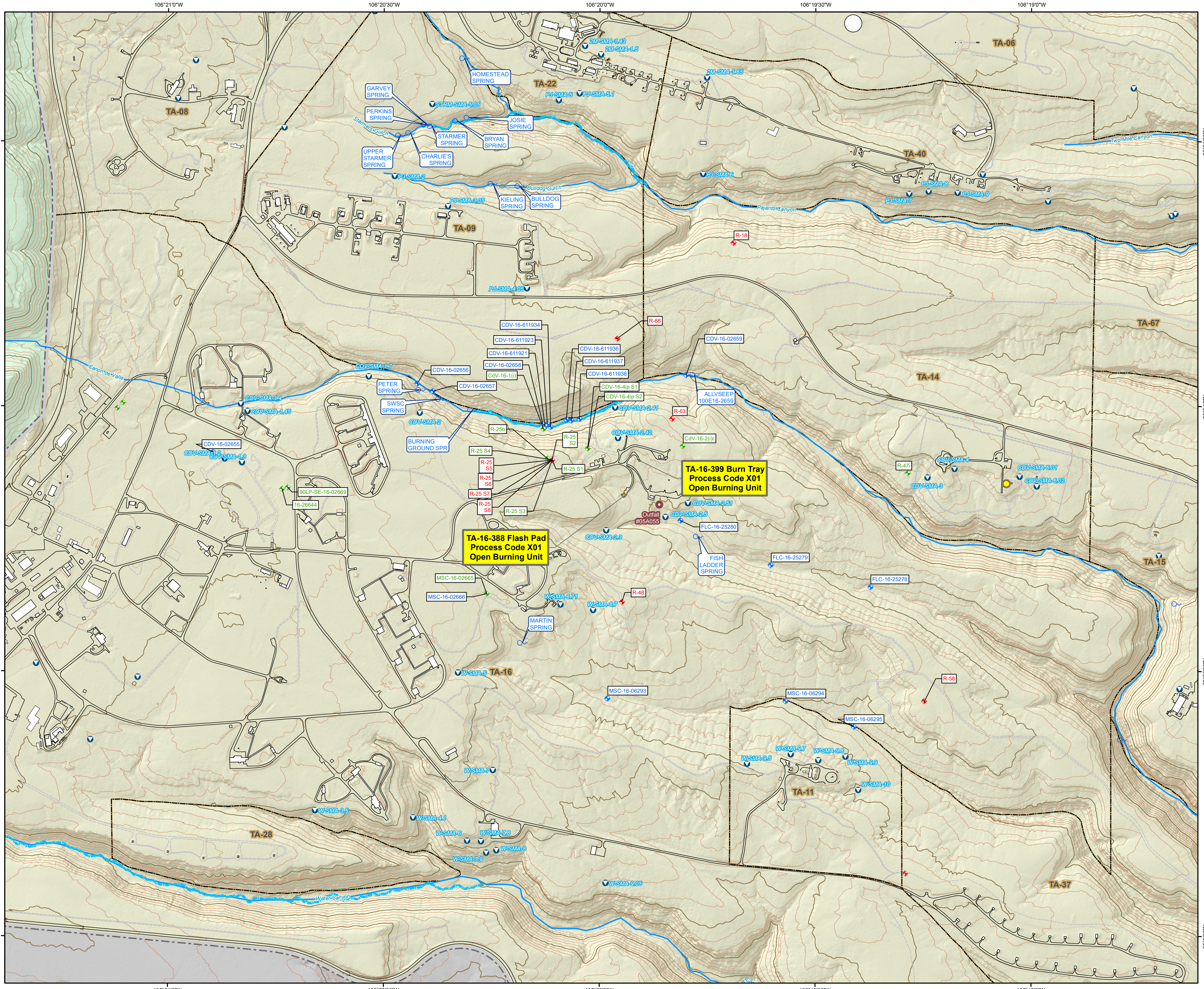

APPENDIX C

Map 1 – Los Alamos National Laboratory Technical Area Map

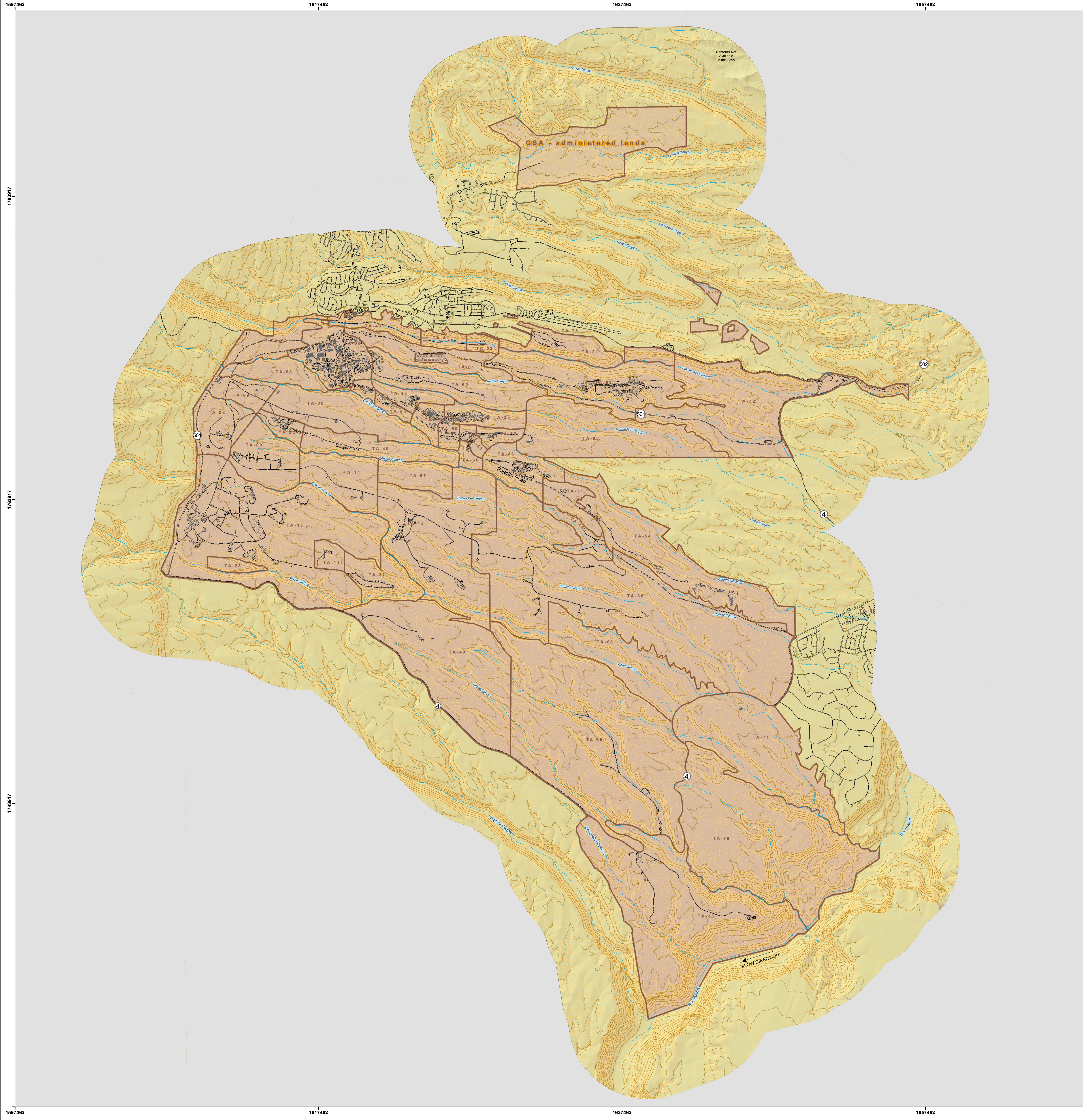

MAP 1

Technical Areas of Los Alamos National Laboratory (LANL)

Legend

- Drainages
- Contours, 100 ft
- Contours 20 ft
- Roads, paved
- Buildings
- Technical Areas
- One Mile Surrounding LANL

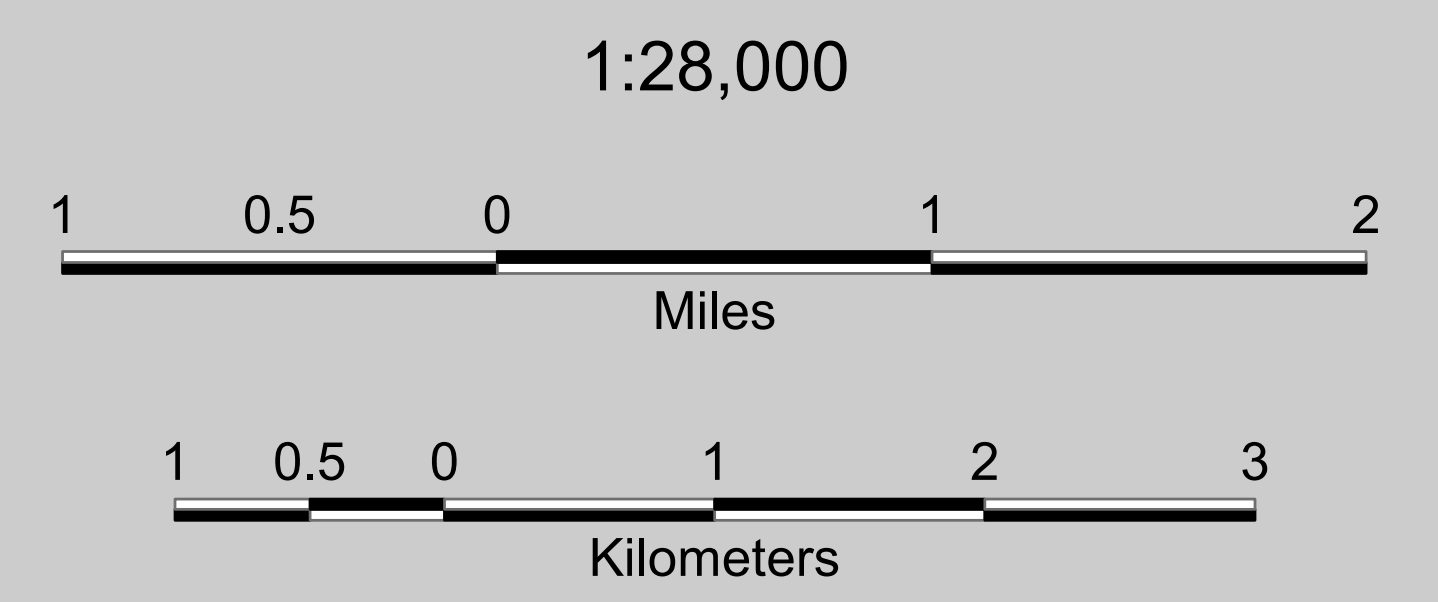

State Plane Coordinate System
 New Mexico, Central Zone, US Feet
 NAD 1983 Datum
 National Geodetic Vertical Datum 1929

WES-EDA GIS Team
 Prepared by : Kathryn Bennett
 Date: June 18, 2009
 Map Reference #: 13-0079-12
 Map updated by Ben Sutter, June 19, 2018
 OI-FD

DISCLAIMER: This map was created for work processes associated with the LANL Hazardous Waste Facility Permit. All other uses for this map should be confirmed with OI-FD staff.

APPENDIX D

Map 2 - Sanitary Sewer and Storm Drain Systems and National Pollutant Discharge Elimination System (NPDES) Outfall Locations

MAP 2

Los Alamos National Laboratory Sanitary Sewer and Storm Drain Systems and National Pollutant Discharge Elimination System (NPDES) Outfall Locations

2018 SEWER SYSTEM

- NPDES Permitted outfalls
- Sewer line
- Storm drain
- Major roadway
- Minor road
- Structure
- TA Boundary
- LANL Boundary

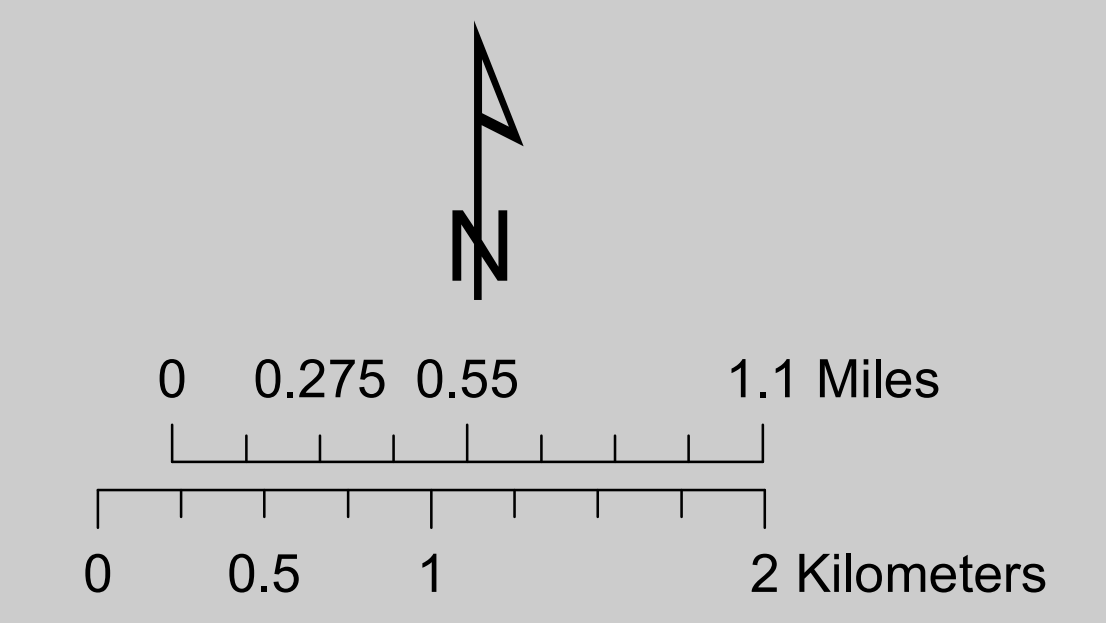

1:22,669

State Plane Coordinate System
New Mexico, Central Zone, US Feet
NAD 1983 Datum



OIO-DO GIS Team
Prepared by :W. Red Star
Date: May 2, 2013
Reformatted January 23, 2018 (B. Sutter)
Map Reference #: 13-0079-13

DISCLAIMER: This map was created for work processes associated with the LANL Hazardous Waste Facility Permit. All other uses for this map should be confirmed with OI-FD staff.

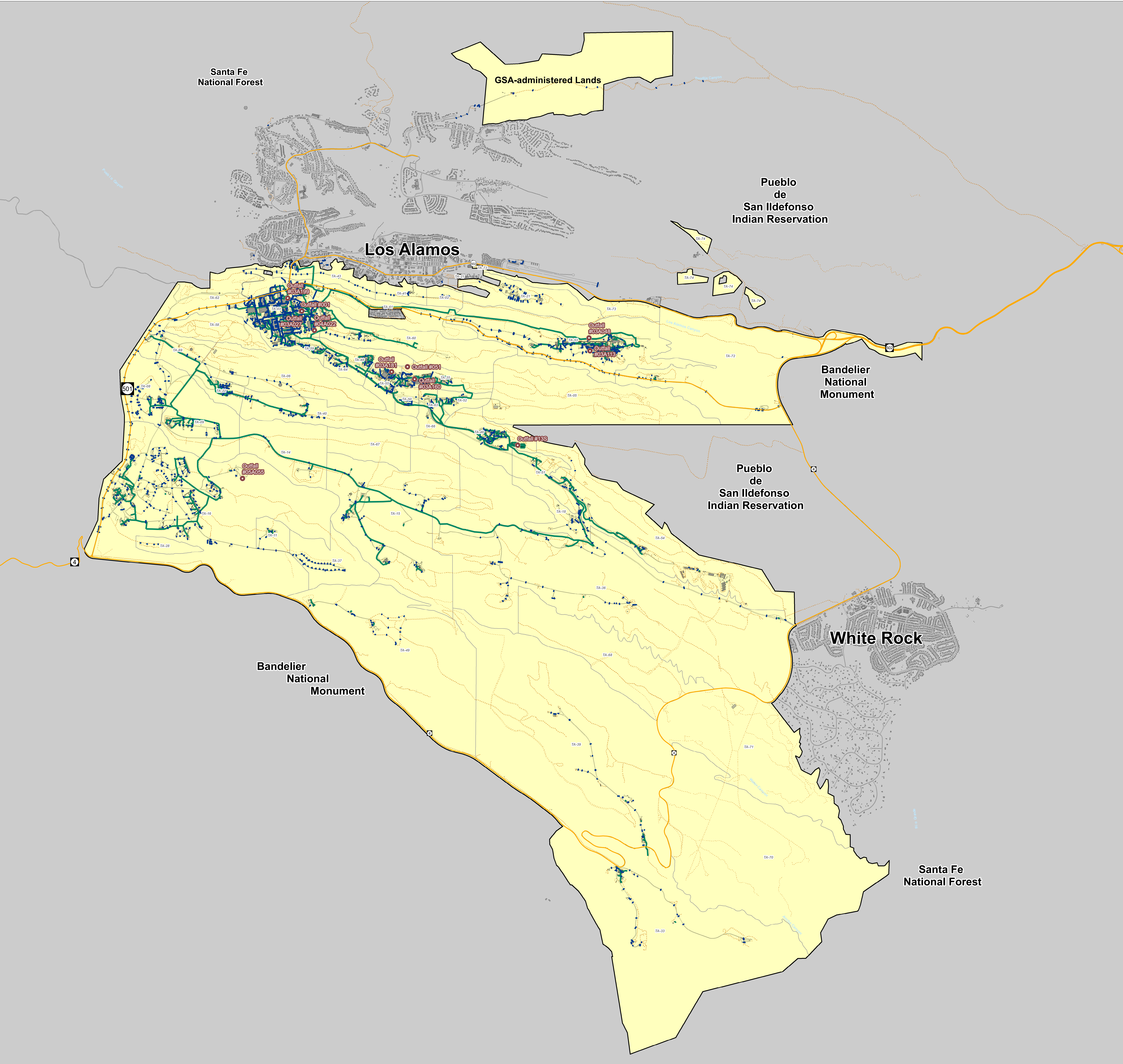















APPENDIX E

Map 3 - Location Map of Water Supply Wells, Monitoring Wells, Springs, and Other Surface Water Bodies

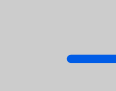
MAP 3

Location Map of Water Supply Wells, Monitoring Wells, Springs, and Other Surface Water Bodies

2017 Monitoring Wells

-  Alluvial
-  Intermediate
-  Regional
-  Water Supply Well
-  Springs
-  Streams
-  Drainage
-  Rio Grande
-  Major road
-  Minor road
-  Pond
-  Structure
-  Technical area boundary
-  LANL Boundary

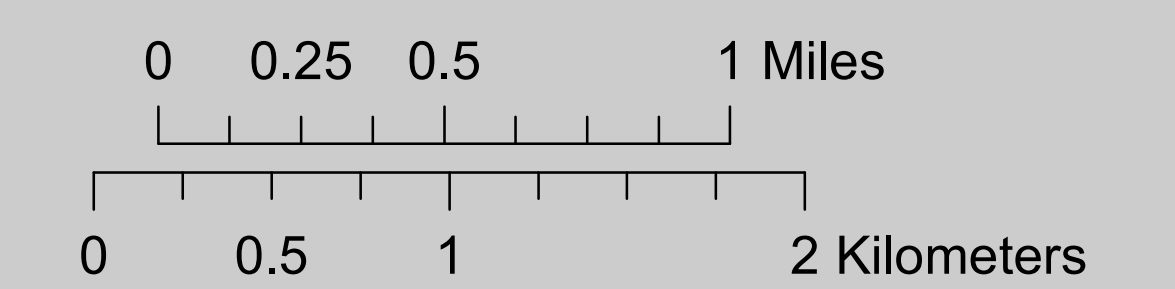

State Plane Coordinate System
New Mexico, Central Zone, US Feet
NAD 1983 Datum

Map Number: 18-084-01
Revised by Bethann McVicker, IFPROG, March 1, 2019.

DISCLAIMER: This map was created for work processes associated with the LANL Hazardous Waste Facility Permit. All other uses for this map should be confirmed with OI-FD staff.

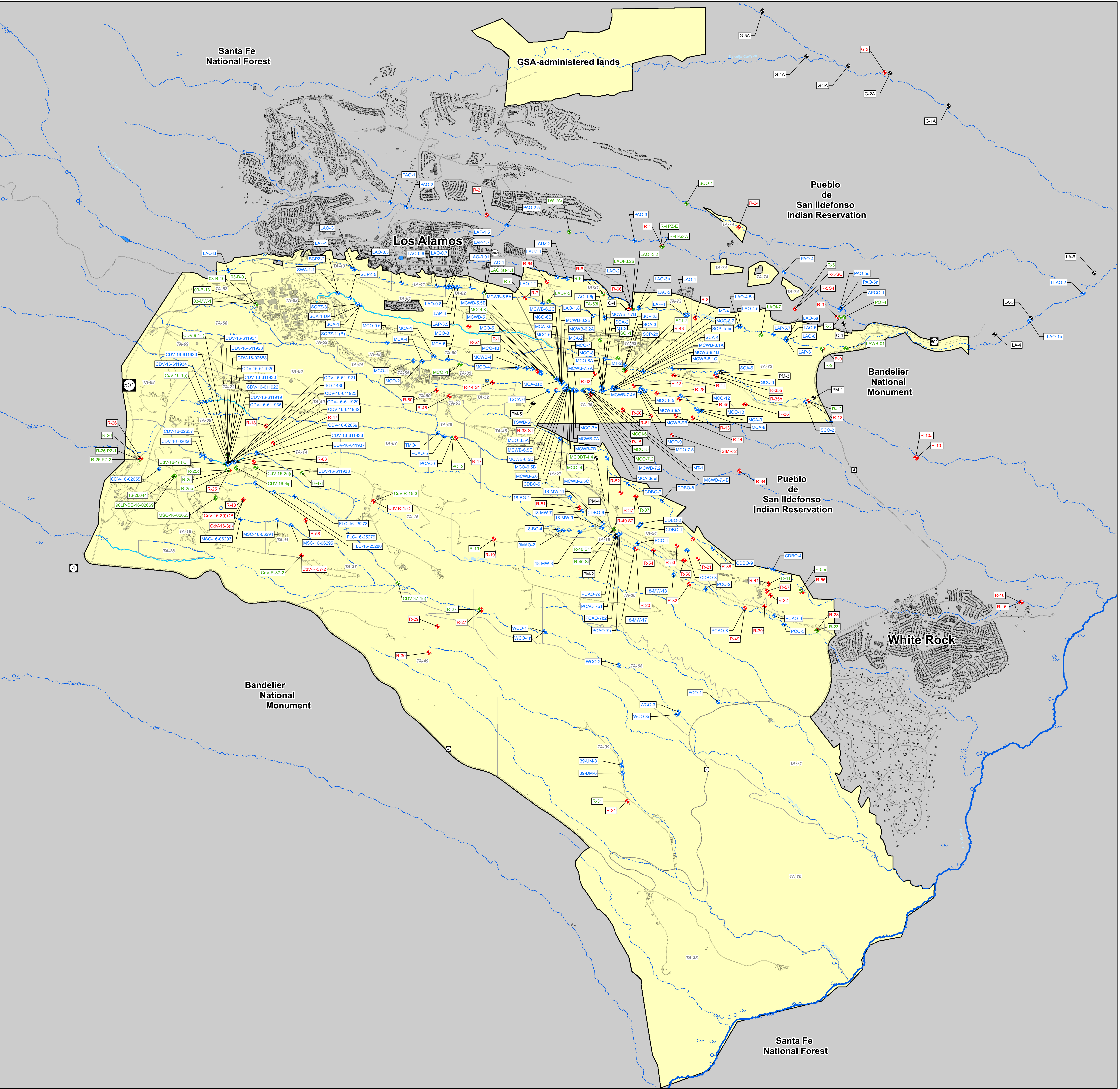

APPENDIX F

Signatory Authority Letter

[This page is intentionally blank.]



*Environmental Protection & Compliance
Division*

Los Alamos National Laboratory
PO Box 1663, K490
Los Alamos, NM 87545
505-667-0666

Symbol: EPC-DO: 18-453
LAUR: 18-31574
Date: **DEC 11 2018**

Ms. Anne L. Idsal, Regional Administrator
U.S. Environmental Protection Agency, Region 6
1445 Ross Avenue, Suite 1200
Mail Code: 6RA
Dallas, TX 75202-2733

**Subject: Notification of Triad National Security, LLC, Signatory Officials and
Authorized Representatives for NPDES Permits**

Dear Ms. Idsal:

The purpose of this letter is to provide an update to the U. S. Environmental Protection Agency (EPA) Region 6 on the Triad National Security, LLC delegation of authority for signature of documents associated with the various Los Alamos National Laboratory (LANL) NPDES Permits, pursuant to 40 CFR 122.22(c). This letter supersedes and replaces the signatory authority letter dated March 14, 2018 (ADESH: 18-017).

The positions of Associate Laboratory Director of Environment, Safety, Health & Quality and Safeguards & Security (ESHQSS), and Division Leader of the Environmental Protection & Compliance Division (EPC-DO) are identified as Triad's primary signatory officials under 40 CFR 122.22(a) for certifying and signing permit applications (including Notice of Intents (NOIs)) required under the LANL NPDES Industrial Point Source Outfall Permit (Permit No. NM0028355), the NPDES Storm Water Construction General Permit, the NPDES Multi-Sector General Permit (Permit No. NMR050013), and the NPDES Pesticide General Permit (Permit No. NMG87B113).

The following positions are hereby designated as authorized representatives under 40 CFR 122.22(b) to sign reports, Storm Water Pollution Prevention Plans, Discharge Monitoring Reports, Pesticide Discharge Management Plans, and any other compliance documentation required by the permits:

EPC-DO: 18-453
Ms. Anne L. Idsal

DEC 11 2018

Page 2

NPDES Industrial Point Source Outfall Permit (No. NM0028355)

- Positions listed as primary signatory officials above.
- Group Leader or Team Leaders within the Environmental Compliance Programs Group.
- Responsible Facility Operations Director (FOD).

NPDES Construction General Permit:

- Positions listed as primary signatory officials above.
- Group Leader or Team Leaders within the Environmental Compliance Programs Group.
- Cognizant Project Manager, Construction Manager, or Subcontractor Technical Representative for the regulated construction activity.

NPDES Multi-Sector General Permit (ID No. NMR053195)

- Positions listed as primary signatory officials above.
- Group Leader or Team Leaders within the Environmental Compliance Programs Group.
- Division Leader, Deputy Division Leader, or Group Leader of the LANL division responsible for the overall operation of the regulated facility or activity.
- Responsible FOD; Deputy FOD, Operations Manager; or Deployed Environment, Safety, & Health Manager responsible for the overall operation of the regulated facility or activity.

NPDES Pesticide General Permit (No. NM687A041)

- Positions listed as primary signatory officials above.
- Group Leader or Team Leaders within the Environmental Compliance Programs Group.

If you have questions, please contact me at (505) 667-7269 or at etorres@lanl.gov.

Sincerely,

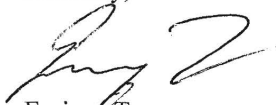

Enrique Torres
Division Leader
Environmental Protection & Compliance Division

ET/TWL/MTS:jdm

EPC-DO: 18-453
Ms. Anne L. Idsal

DEC 11 2018

Page 3

Attachment(s): None.

Copy: Nancy Williams, USEPA, Region 6, williams.nancy@epa.gov, (E-File)
Brent E. Larsen, USEPA, Region 6, Larsen.brent@epa.gov, (E-File)
Robert Houston, USEPA, Region 6, Houston.robert@epa.gov, (E-File)
Sarah Holcomb, NMED, sarah.holcomb@state.nm.us, (E-File)
Karen E. Armijo, LASO-MA-LS, Karen.armijo@nnsa.doe.gov, (E-File)
Jody Pugh, NA-LA, jody.pugh@nnsa.doe.gov, (E-File)
Michael W. Hazen, ESHQSS, mhazen@lanl.gov, (E-File)
William R. Mairson, ESHQSS, wrmairson@lanl.gov, (E-File)
Enrique Torres, EPC-DO, etorres@lanl.gov, (E-File)
Taunia Van Valkenburg, EPC-CP, tauniav@lanl.gov, (E-File)
Michael T. Saladen, EPC-CP, saladen@lanl.gov, (E-File)
Terrill W. Lemke, EPC-CP, tlemke@lanl.gov, (E-File)
Tim Dolan, GC-ESH, tdolan@lanl.gov, (E-File)
emla.docs@em.doe.gov, (E-File)
locatesteam@lanl.gov, (E-File)
epc-correspondence@lanl.gov, (E-File)
adesh-records@lanl.gov, (E-File)

APPENDIX G

Historical and Existing National Pollutant Discharge Elimination System (NPDES) Outfall Status Summary

[This page is intentionally left blank.]

List of Historical and Existing NPDES Outfalls at the Los Alamos National Laboratory				
Outfall ID No.	TA	Building	Watershed	Status
Outfalls to be Re-Permitted in 2019				
01A001	3	22	Sandia	Re-Permit 2019
13S	46	347	Canada del Buey	Re-Permit 2019
051	50	1	Mortandad	Re-Permit 2019
03A022	3	66	Mortandad	Re-Permit 2019
03A027	3	2327	Sandia	Re-Permit 2019
03A048	53	964, 979	Los Alamos	Re-Permit 2019
03A113	53	293, 952	Sandia	Re-Permit 2019
03A160	3	124	Mortandad	Re-Permit 2019
03A181	55	6	Mortandad	Re-Permit 2019
03A199	3	1837	Sandia	Re-Permit 2019
05A055	16	1508	Canyon de Valle	Re-Permit 2019
Historical Outfalls Removed from the Permit				
01S	3		Sandia	Prior to 95
02S	9		Pajarito	Prior to 94
01A 002	3	22		Combined with 001
03S	16		Water	Prior to 94
01A 003	3	22		Combined with 001
04S	18		Pajarito	Prior to 94
01A 004	3	22		Combined with 001
05S	21	STP	Los Alamos	3/10/1998
01A 005	3	22		Combined with 001
06S	41	STP		Prior to 94
02A 006	21	357		Eliminated
07S	46		Canada del Buey	Prior to 94
02A 007	16	540	Valle	5/15/1998
08S	48	5		Combined with 10S
02A 008	22	6		Eliminated 6/84
09S	53		Los Alamos	Prior to 94
03A 009	3	102	Two Mile	7/31/1996
10S	35		Mortandad	Deleted Prior to 94
04A 010	3	105		Eliminated 4/87
11S	8	9		Combined with 02S
04A 011	22	5		Eliminated 4/87
12S	46		Canada del Buey	Prior to 94
04A 012	35	67		Eliminated 4/87
04A 013	46	30	Canada del Buey	Deleted 12/6/1995
04A 014	46	88	Canada del Buey	Deleted 7/11/1995
04A 015	48	1		Combined with 045
04A 016	48	1	Mortandad	Deleted 9/19/1997
04A 017	53	2		Combined with 114
04A 018	46	24, 59, 76	Canada del Buey	Deleted 12/6/1995
03A 019	2	44		Eliminated 5/16/90
03A 020	2	49	Los Alamos	Deleted 7/11/1995
03A 021	3	29	Mortandad	October 2011
03A 023	3	163, 287	Sandia	Deleted 7/11/1995
03A 024	3	187	Sandia	Request deletion 8-04
03A 025	3	208	Two Mile	Deleted 7/20/1998
03A 026	3	208		Combined with 025
03A 028	15	185, 202	Water	Deleted August 2007
03A 029	16	340		Combined with 054

**List of Historical and Existing NPDES Outfalls at the
Los Alamos National Laboratory**

Outfall ID No.	TA	Building	Watershed	Status
03A 030	21	2		Eliminated 4/87
03A 031	21	143	Los Alamos	Deleted 7/11/1995
03A 032	21	150	Los Alamos	Deleted 7/31/1996
03A 033	21	152	Los Alamos	Deleted 3/1/1986
03A 034	21	166, 167	Los Alamos	Deleted 9/19/1997
03A 035	21	210	Los Alamos	Deleted 9/19/1997
03A 036	21	152, 155, 220	Los Alamos	Deleted 9/19/1997
03A 037	21	314	Los Alamos	Deleted 7/31/1996
03A 038	33	114	Chaquehi	Deleted 9/19/1997
03A 039	35	33		Eliminated
03A 040	43	1	Los Alamos	Deleted 1/11/1999
03A 041	43	1		Combined with 040
03A 042	46	1	Canada del Buey	Deleted 3/10/1998
03A 043	46	31	Canada del Buey	Deleted 7/31/1996
03A 044	46	86		Eliminated 4/87
03A 045	48	1	Mortandad	Deleted 12/6/1999
03A 046	48	1		Combined with 045
03A 047	53	60	Los Alamos	Request deletion 8-04
03A 049	53	64	Los Alamos	Request deletion 8-04
03A158	21	209	Los Alamos	Deleted August 2007
50	21	257	Los Alamos	Last DMR 6/65
05A 052	16	380	Water	Deleted Prior to 94
05A 053	16	410	Water	Deleted 1/14/1998
05A 054	16	340	Valle	Deleted 7/20/1998
05A 056	16	260	Valle	Deleted 1/14/1998
05A 057	16	265,267	Valle	Prior to 94
05A 058	16	300-306	Water	Deleted 7/31/1996
04A 059	16	460		Combined with 072
03A 060	16	430	Water	Deleted 7/31/1996
05A 061	16	280	Valle	Deleted 7/31/1996
05A 062	16	342	Valle	Deleted 7/31/1996
05A 063	16	400	Water	Deleted 12/5/1995
05A 064	22	34	Pajarito	Eliminated
05A 065	22	1	Pajarito	Eliminated
05A 066	9A	21, 28, 29, 32, 33, 34, 35, 37, 38, 40	Valle	Deleted 3/10/1998
05A 067	9B	41, 42, 43, 45, 46	Valle	Deleted 3/10/1998
05A 068	9	48	Valle	Deleted 3/10/1998
05A 069	11	50	Water	Deleted 5/15/1998
04A 070	16	220	Valle	Deleted 9/19/1997
05A 071	16	430	Water	Deleted 3/10/1998
05A 072	16	460	Water	Deleted 9/19/1997
06A 073	16	222	Valle	Deleted 1/14/1998
06A 074	8	22	Valle	Deleted 9/19/1997
06A 075	8	21	Valle	Deleted 1/14/1998
04A 076	8	70	Valle	Combined with 115
06A 077	22	52	Pajarito	Eliminated
06A 078	22	34	Pajarito	Deleted 7/31/1996
06A 079	40	4	Pajarito	Deleted 5/15/1998
06A 080	40	5	Pajarito	Deleted 5/15/1998
06A 081	40	8	Pajarito	Deleted 3/10/1998
06A 082	40	12	Pajarito	Deleted 1/14/1998

**List of Historical and Existing NPDES Outfalls at the
Los Alamos National Laboratory**

Outfall ID No.	TA	Building	Watershed	Status
04A 083	16	202	Water	Deleted 9/19/1997
04A 084	22	5		Eliminated 4/87
04A 085	22	6		Eliminated
04A 086	3	216		Eliminated 4/87
04A 087	35	46		Eliminated 4/87
04A 088	35	67		Eliminated 4/87
04A 089	35	34		Eliminated
04A 090	35	85		Eliminated 4/87
04A 091	16	450	Water	Deleted 9/19/1997
04A 092	16	370	Water	Deleted 1/14/1998
04A 093	15	203	Valle	Deleted Prior to 94
04A 094	3	170	Sandia	9/19/1997
95	3	170		Eliminated 4/87
05A 096	11	51	Valle	Deleted 5/15/1998
05A 097	11	52	Water	Request deletion 8-04
03A 098	59	1	Two Mile	Deleted 12/6/1995
06A 099	40	23	Pajarito	Deleted 9/19/1997
06A 100	40	15	Pajarito	Deleted 5/15/1998
04A 101	40	9	Pajarito	Deleted 9/19/1997
04A 102	1	40		Eliminated 6/25/91
04A 103	15	40		Eliminated 6/25/91
06A 104	18	30, 31		Eliminated 4/87
04A 105	15	138		Eliminated
06A 106	36	1	Three Mile	Deleted 1/11/1999
02A 108	0			Eliminated
07A 109	3	73	Sandia	Deleted 8/4/1995
04A 110	3	73		Eliminated 2/89
04A 111	52	1		Eliminated 4/87
04A 112	52	11		Eliminated 4/87
03A 114	53	2	Sandia	Deleted 7/11/1995
04A 115	8	70	Valle	Deleted 9/19/1997
04A 116	35	29		Eliminated 4/87
04A 117	46	41	Canada del Buey	Deleted 7/11/1995
04A 118	Paj #4		Canada del Buey	Deleted 10/13/1999
04A 119	Paj #5			Eliminated 4/87
120	3		discharge	Eliminated
04A 121	15	263		Eliminated 4/87
04A 122	15	45		Eliminated 4/87
06A 123	15	R183	Valle	Deleted 1/14/1998
03A 124	46	169	Canada del Buey	Deleted 12/6/1995
03A 125	53	28	Sandia	Deleted 7/20/1998
04A 126	48	8	Mortandad	Deleted 12/6/1995
04A 127	35	213	Mortandad	Deleted 9/19/1997
128	22	91	Two Mile	Deleted 12/5/1995
02A 129	21	357	Los Alamos	Deleted October 2011
03A 130	11	30	Water	Deleted October 2011
04A 131	48	1	Mortandad	Deleted 1/14/1998
06A 132	35	87	Mortandad	Deleted 3/10/1998
04A 133	53	19	Sandia	Eliminated
04A 134	16	478		Eliminated 5/16/90
04A 135	53	18	Sandia	Deleted 8/16/1995

List of Historical and Existing NPDES Outfalls at the Los Alamos National Laboratory				
Outfall ID No.	TA	Building	Watershed	Status
03A 136	46	200	Canada del Buey	Deleted 12/6/1995
04A 176	Guaje # 6		Rendija	Deleted 8/23/1999
04A 177	Guaje Booster 1		Guaje	Deleted 10/13/1999
04A 178	LA Booster 1		Los Alamos	Prior to 94
04A 179	Paj.		Water blwdwn	
03A 180	43	44	Los Alamos	Deleted 7/11/1995
04A 182	21	1003	Los Alamos	Deleted 5/15/1998
06A 183	3	510	Sandia	Deleted 8/16/1995
03A 184	53	17	Sandia	Deleted 8/16/1995
03A 185	15 (DARHT)	312	Water	Deleted October 2011
04A 186	Otowi #4		Los Alamos	Deleted 10/13/1999

APPENDIX H

Notice of Changed Conditions and/or Planned Changes (March 2012 – February 2019)

[This page is intentionally left blank.]

List of Notices of Changed Conditions and/or Planned Changes (March 2012 – February 2019)				
Outfall ID No.	Document Number	Title	Date	Description
001	LAUR-12-20001	ENV-RCRA-12-0063, Los Alamos National Laboratory, NPDES Permit No. NM0028355, Notice of Planned Change at NPDES Outfall 001, Sanitary Effluent Reclamation Facility Expansion	3/6/2012	Provided the design drawings for the expansion of the Sanitary Effluent Reclamation Facility.
	LAUR-19-20785	EPC-CP-DO: 19-032, Los Alamos National Laboratory, National Pollutant Discharge Elimination System, Permit No NM0028355, Notice of Planned Change for the Sanitary Effluent Reclamation Facility	2/5/2019	Add the capability to pump and ship wastewater from the evaporation basins to an offsite disposal facility.
	LAUR-19-21477	EPC-DO: 19-056, Los Alamos National Laboratory, National Pollutant Discharge Elimination System, Permit No. NM0028355, Notice of Planned Change to Reroute the Reverse Osmosis Reject to the Sanitary Waste Water System (SWWS)	2/22/19	Add the capability to send reverse osmosis concentrate to the SWWS or the evaporation basins.
13S	LAUR-12-22119	ENV-RCRA-12-0137, Supplemental Reapplication Information and Notice of Planned Change in Sewage Sludge Disposal Practice at the Los Alamos National Laboratory Sanitary Wastewater System Facility NPDES Permit NM0028355.	8/15/2012	Notice of a planned change to begin composting bio solids at the SWWS. The facility plans to land apply final composted material per the requirements of 40 CFR §503.13, §503.32(a) and §503.33(b) (1) through (b) (8).
	LAUR-12-22609	ENV-RCRA-12-0154, Notice of Intent of Planned Change in Sewage Sludge Disposal Practice at the Los Alamos National Laboratory's Sanitary Wastewater System Facility.	7/31/2012	Notice of Intent to compost bio-solids at SWWS.
	LAUR-14-26554	ENV-DO-14-0233, NPDES Permit No. NM0028355, Notice of Changed Condition, Supplemental NPDES Reapplication Information for Outfall 13S.	8/27/2014	<ul style="list-style-type: none"> • Notice of change to include wastewater from septic tanks at remote locations and wash facilities with de minimus quantities of high explosives. • Notice of change to include contaminated storm water with de minimus quantities of high explosives.
03A022	No Notice of Planned Change/Notice of Changed Condition Submitted.			
03A027	LAUR-13-27719	ENV-DO-13-0235, NPDES Permit No. NM0028355, Notice of Planned Change, Outfall 03A027	10/24/2013	Notice of a volume test to determine if the existing blowdown line is sufficient to handle the volume of cooling water that will be associated with next generation computing system.

List of Notices of Changed Conditions and/or Planned Changes (March 2012 – February 2019)				
Outfall ID No.	Document Number	Title	Date	Description
03A048	No Notice of Planned Change/Notice of Changed Condition Submitted.			
03A113	No Notice of Planned Change/Notice of Changed Condition Submitted.			
03A181	LAUR-18-23841	EPC-DO: 18-199 NPDES Permit No. NM0028355 Notice of Planned Change at NPDES Outfall 03A181	5/8/2018	A de-chlorination system was added to the overflow line of the TA-55-006 Cooling Tower System to ensure adequate de-chlorination before release to the outfall.
03A199	No Notice of Planned Change/Notice of Changed Condition Submitted.			
03A160	LAUR-12-26607	ENV-RCRA-12-0260 NPDES Permit NM0028355 Bypass of Treatment report for Outfall 03A160	11/28/2012	The makeup water valve that supplied water to the cooling towers became stuck in the open position causing the cooling tower tanks to overflow. Water overflowed the cooling tower tanks and discharged to the outfall without being treated by the copper ion exchange columns.
	LAUR-18-24611	EPC-DO-18-216 Los Alamos National Laboratory NPDES Permit NM0028355 Notice of Planned Change at NPDES Outfall 03A160	5/31/2018	Notification that the cooling tower blowdown was routed from the outfall to the Sanitary Wastewater System. Intent is to maintain the outfall as an operational backup.
051	LAUR-16-23486	EPC-DO-16-116, NPDES Permit No. NM 0028355 Notice of Planned Change Outfall 051	6/3/2016	Updates information provided in the 2012 NPDES Permit Application for the TA-50 RLWTF Upgrade Project. This includes updated information and drawings for a single store reinforced concrete building, approximately 8,000 square feet in area, located immediately west of the existing RLWTF, and intended to house the new low level waste treatment operations, control room, analytical laboratory and effluent treatment tanks.
	LAUR-16-28128	EPC-DO-16-324, Los Alamos National Laboratory NPDES Permit No. NM0028355 Notice of Planned Change at NPDES Outfall 051	11/29/2016	Notice that the RLWTF intends to change the location within the facility where the NPDES compliance samples are collected from the effluent water prior to discharge to Outfall 051.
	LAUR-18-23962	EPC-DO: 18-202, NPDES Permit No. NM0028355 Notification of Pre-Start Surrogate Water Test Radioactive Liquid Waste Treatment Facility Upgrade Project	5/22/2018	Notice that approximately 10,000 gallons of tap water containing non-radioactive salts will be tested in the new RLW treatment facility to test the equipment.

List of Notices of Changed Conditions and/or Planned Changes (March 2012 – February 2019)				
Outfall ID No.	Document Number	Title	Date	Description
05A055	LAUR-18-28868	EPC-DO: 18-326 NPDES Permit No. NM0028355, Notification of Change Condition, TA-16 High Explosive Wastewater Treatment Facility (HEWTF) Outfall 05A055.	9/26/2018	Notice that the HEWTF may choose to bypass the granulated activated carbon tanks and/or ion exchange columns during treatment of wastewater prior to its discharge to the evaporator.

[This page is intentionally left blank.]



*Environmental Protection Division
Water Quality & RCRA Group (ENV-RCR)*
P.O. Box 1663, M704
Los Alamos, New Mexico 87545
(505) 667-0666

*National Nuclear Security Administration
Los Alamos Site Office, A316*
3747 West Jemez Road
Los Alamos, New Mexico 87545
(505) 667-5794/FAX (505) 667-5948

Date: March 6, 2012
Refer To: ENV-RCRA-12-0063
LAUR: 12- 20001

Ms. Hannah Branning
U.S. Environmental Protection Agency, Region 6
Water Quality Protection Division
Planning and Analysis Branch (6EN)
1445 Ross Avenue, Suite 1200
Dallas, Texas 75202-2733

Dear Ms. Branning:

**SUBJECT: LOS ALAMOS NATIONAL LABORATORY, NPDES PERMIT NO.
NM0028355, NOTICE OF PLANNED CHANGE AT NPDES OUTFALL 001,
SERF EXPANSION**

The National Pollutant Discharge Elimination System (NPDES) Permit No. NM0028355 for the National Nuclear Security Administration (NNSA) and Los Alamos National Security, LLC (LANS) at Los Alamos National Laboratory (the Laboratory) requires the permittees to notify the U. S. Environmental Protection Agency (EPA) regarding any physical alterations or additions to the permitted facility that could significantly change the nature or increase the quantity of pollutants discharged (see Part III.D.1.a. *Reporting Requirements*).

The purpose of this letter is to provide design drawings for the expansion of the Sanitary Effluent Reclamation Facility (SERF) located at Technical Area 3 (TA-3). The SERF will reduce the concentration of PCBs at Outfall 001 and will provide make-up water for cooling towers and the Power Plant at TA-3. A Notice of Planned Change sent to your office in September 2009 (Ref: ENV-RCRA-09-171) explained a functional test run of the existing SERF. A second Operational Readiness run was conducted in August 2011 to determine PCB treatment effectiveness using precipitation, microfiltration, and reverse osmosis. As explained in the most recent Quarterly Progress Report (Ref: ENV-RCRA-12-0014) and in the recently submitted NPDES Permit No. NM0028355 Re-application, expansion of the SERF and installation of two additional evaporation basins began in July 2011. Design drawings have been submitted and are being provided here for your records (Enclosures 1 and 2).

An Equal Opportunity Employer / Operated by Los Alamos National Security LLC for DOE/NNSA

Ms. Hannah Branning
ENV-RCRA-12-0063

- 2 -

March 6, 2012

Please contact Marc Bailey at (505) 665-8135 or Mike Saladen at (505) 665-6085 of the Water Quality and RCRA Group (ENV-RCRA) if you have questions.

Sincerely,



Anthony R. Grieggs
Group Leader
Water Quality & RCRA Group
Los Alamos National Security, LLC

Sincerely,

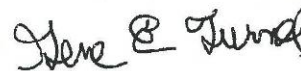

Gene E. Turner
Environmental Permitting Manager
Environmental Projects Office
Los Alamos Site Office
National Nuclear Security Administration

ARG:GET:MB/lm

Cy: Isaac Chen, USEPA/Region 6, Dallas, TX, w/enc.
James Bearzi, NMED/SWQB, Santa Fe, NM, w/enc.
Jerry Schlepner, NMED/GWQB, Santa Fe, NM, w/enc.
Jim Davis, NMED/RPD, Santa Fe, NM, w/enc.
George Rael, LASO-EO, w/enc., A316, (E-File)
Steve Yanicak, LASO-GOV, w/enc., M894, (E-File)
Carl A. Beard, PADOPS, w/o enc., A102, (E-File)
Michael T. Brandt, ADESHQ, w/o enc., K491, (E-File)
Alison M. Dorries, ENV-DO, w/o enc., K491, (E-file)
Scotty W. Jones, ENV-DO, w/o enc., K491, (E-File)
Andrew Erickson, UI-DO, w/enc., K760, (E-File)
Gary Blauert, ES-UI, w/enc., K718, (E-File)
Mike Saladen, ENV-RCRA, w/o enc., K490, (E-File)
Marc Bailey, ENV-RCRA, w/enc., K490, (E-File)
Bob Beers, ENV-RCRA, w/enc., K490, (E-File)
ENV-RCRA File, w/enc., M704, (E-File)
IRM-RMMSO, w/enc., A150, (E-File)



Enclosure 1

ENV-RCRA-12-0063

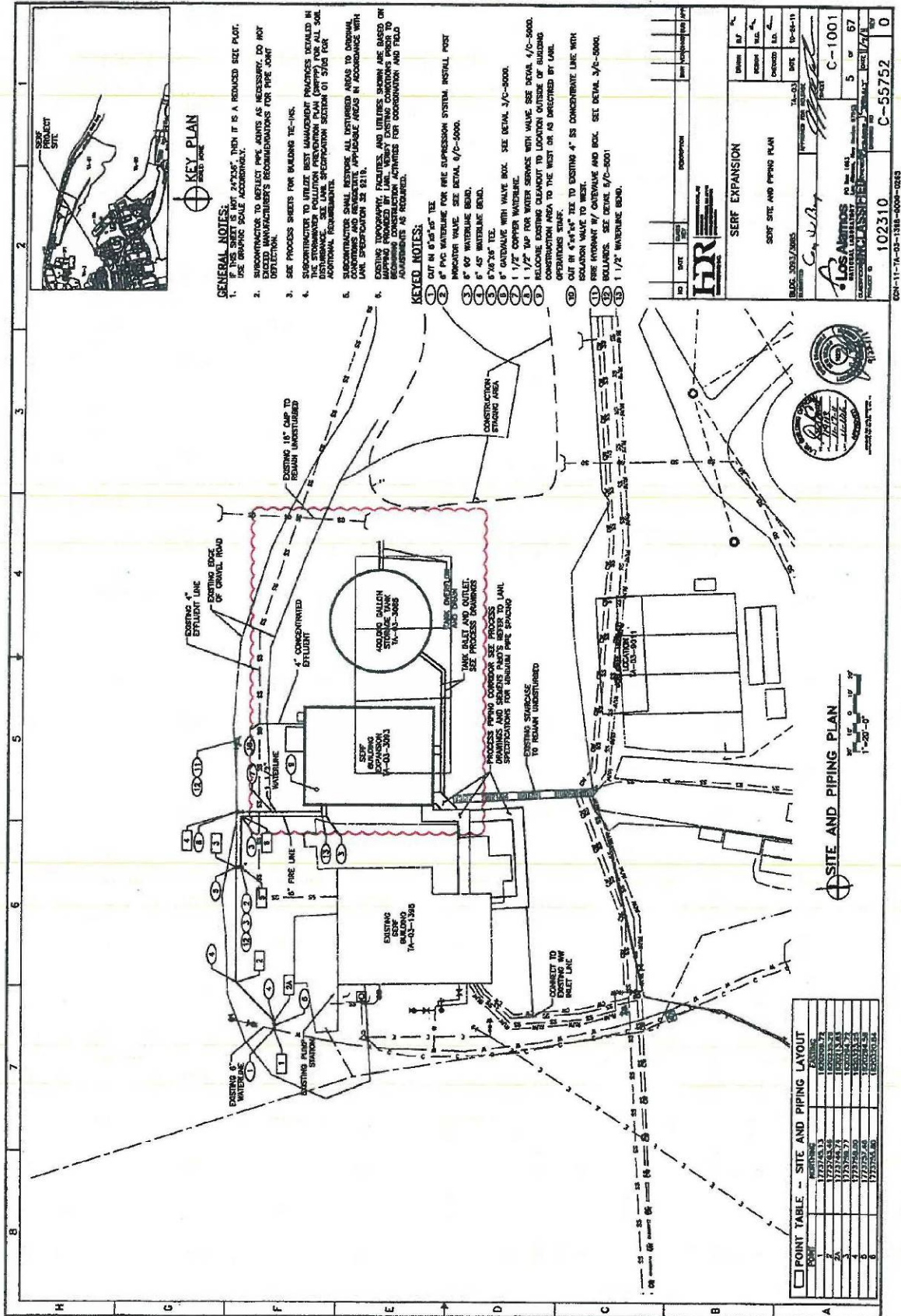
Laur-12-20001

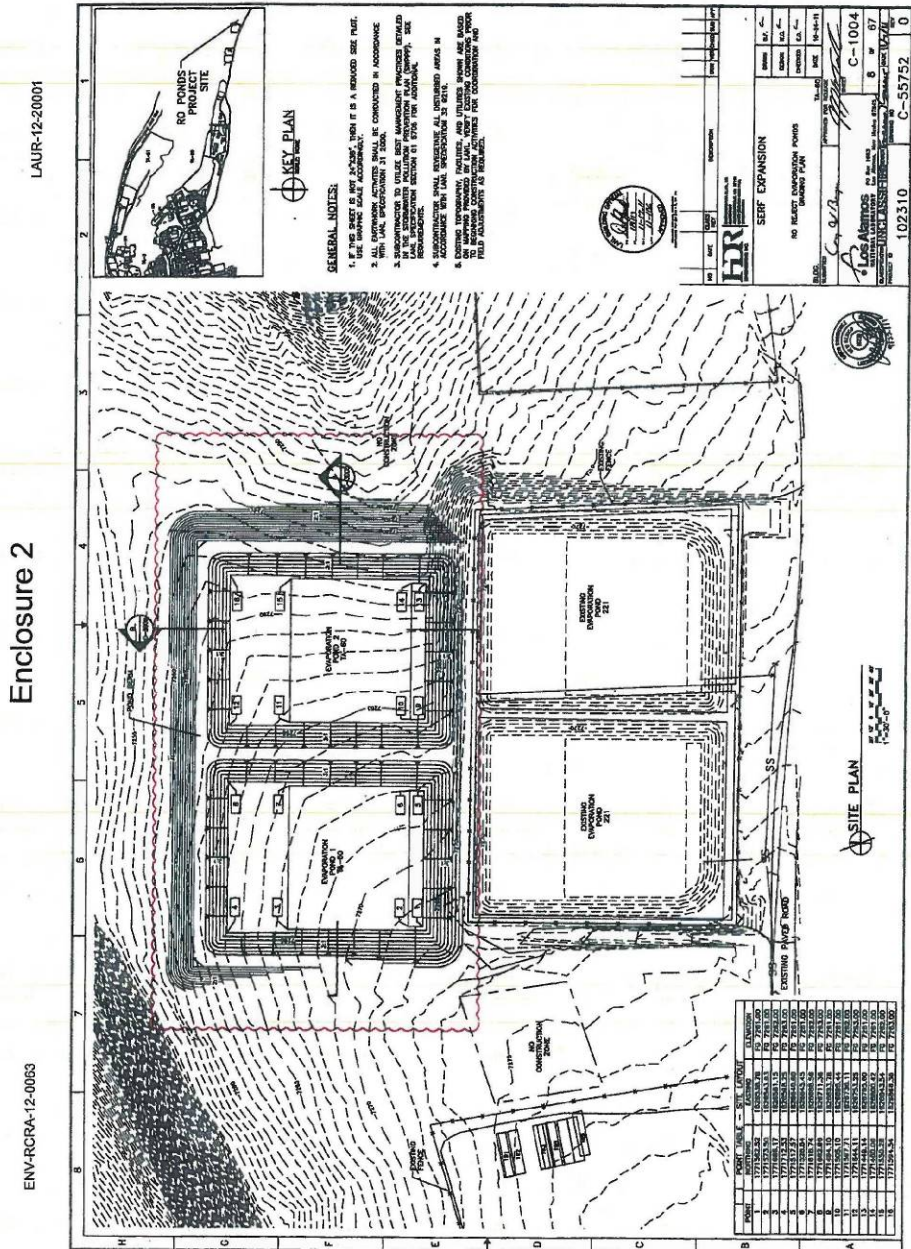

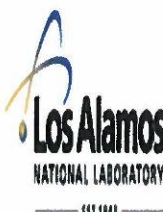

WQ & RCRA GROUP LOG SHEET				
Document Identification				
	ESH&Q Doc. #:	Enclosures:	Attachments:	LAUR No.
	ENV-Group: ENV-RCRA	Yes: x	Yes:	12-20001
	Doc. #: 12-0063	No:	No:	
Is this a response to an action item		Yes:	No: x	
E Mail <input type="checkbox"/>		Document Date: 3/6/2012		
Memo <input type="checkbox"/>		Due Date:		
Letter <input checked="" type="checkbox"/>				
To:	Hannah Branning			
Subject:	NPDES Permit No. NM0028355, Notice of Planned Change at NPDES Outfall 01, SERF Expansion			
Action:				
Background / Issues				
Authorizing Official	Name	Signature	Date	
From (Ghost Writer)	Marc Bailey			
Author	A. Grieggs & G. Turner			
Group Leader				
Deputy Group Leader				
Division Leader				
ADESH				
DOE				
LC-LESH Review				
Coordinated with Facility or Program				
Comments:	ED441350996US ED441350996US 			
Hand Deliver:	Express Mail: <input checked="" type="checkbox"/>	FedEX:	CRRR:	Regular Mail Service:
Group Office Use Only				
Final Distribution: Louella	Scanned by:		Louella	
Time: 10:19	Date: 3/14/12	Date:	3/15/2012	
		Logged by:	Louella	
Distribution to IRM-RMMSO, A150:		Date:	3/15/2012	
E-File 10:09 3/14/12				



Signature/Review/Coordination Sheet

This form is to accompany all documents requiring review, approval, or signature by the Laboratory Director or Designee.

Date March 6, 2012	Deadline A.S.A.P.	Is this a response to an action item? Yes <input type="checkbox"/> No <input checked="" type="checkbox"/>
From: ENV-RCRA-12-0063	Name: Marc Bailey MS: K-490	<input type="checkbox"/> Call for Pick-up Name: Louella B. Medina Phone: 7-0666

Title: Identify document, briefly describing subject matter.
 Los Alamos National Laboratory, NPDES Permit No. NM0028355, Notice of Planned Change At NPDES Outfall 001, SERF Expansion

Action Information Only

Background/Issues:
 NPDES Permit No. NM0028355 requires the permittees to notify the U. S. Environmental Protection Agency (EPA) regarding any physical alterations or additions to the permitted facility that could significantly change the nature or increase the quantity of pollutants discharged (see Part III.D.1.a. Reporting Requirements). The purpose of this letter is to notify EPA of changes to the Sanitary Effluent Reclamation Facility (SERF) that will allow more sanitary effluent to be treated and re-used as part of the Outfall Reduction Project.

ACTION requested of Laboratory Director or Designee:
 Review and endorse

PAD Endorsement

Name (print)	Signature	Date
Carl A. Beard	na	

AD Endorsement

Name (print)	Signature	Date
Michael T. Brandt	na	

Coordinated with

1. Name (print)	Signature	Date
Alison M. Dorries		3/7/12
2. Name (print)	Signature	Date
Anthony R. Grieggs		3/7/12
3. Name (print)	Signature	Date
Mike Saladen		3/7/12
4. Name (print)	Signature	Date
Marc Bailey		3/7/12
5. Name (print)	Signature	Date

Please ensure appropriate inter/intra Directorate/Divisional coordination and review prior to submittal to the Director's Office.
 Form 1824 (1/07)



*Environmental Protection & Compliance
Division*

Los Alamos National Laboratory
PO Box 1663, K490
Los Alamos, NM 87545
505-667-0666

Symbol: EPC-DO: 19-032
LAUR: 19-20785
Date: **FEB 05 2019**

Ms. Nancy Williams
U.S. Environmental Protection Agency, Region 6
Compliance Assurance and Enforcement Division
Water Enforcement Branch (6EN)
1445 Ross Avenue, Suite 1200
Dallas, TX 75202-2733

Subject: Los Alamos National Laboratory, National Pollutant Discharge Elimination System, Permit No. NM0028355, Notice of Planned Change for the Sanitary Effluent Reclamation Facility

Dear Ms. Williams:

The National Pollutant Discharge Elimination System (NPDES) Permit No. NM0028355 for the Nuclear Security Administration (NNSA) and Triad National Security, LLC (Triad) requires the permittee(s) to notify the U. S. Environmental Protection Agency (EPA) of any physical alterations or additions to a permitted facility that could significantly change the nature or increase the quantity of pollutants discharged (see Part III.D.1.a. Report Requirements). This notice of change was written to notify about a change at the Sanitary Effluent Reclamation Facility (SERF). SERF must pump wastewater from the evaporation basins and properly dispose of it off-site due to capacity issues. Several major snow events in December 2018 and January 2019 in the Los Alamos area resulted in snowfall amounts of 40 inches, which is affecting the storage capacity within the basins.

To ensure storage capacity is not exceeded, the facility plans to pump and ship approximately 300,000 gallons of non-hazardous wastewater to a facility in Arizona, Liquid Environmental Solutions (LES), for disposal over the next several months. The SERF facility is reserving the right to ship additional wastewater offsite in the future that cannot be evaporated due to natural phenomena such as high precipitation events or other factors such as maintenance.

Please contact Patricia Vardaro-Charles at (505) 665-4644 or Michael T. Saladen at (505) 665-6085 of the Environmental Compliance Programs Group (EPC-CP) if you have questions.

EPC-DO: 19-032
Ms. Nancy Williams

FEB 05 2019

Page 2

Sincerely,



Taunia S. Van Valkenburg
Group Leader

TVV/MTS/PVC:jdm

Copy: Sarah Holcomb, NMED/SWQB, sarah.Holcomb@state.nm.us (Hard copy, E-File)
Shelly Lemon, NMED/SWQB, Shelly.Lemon@state.nm.us (E-File)
Erin Shea, NMED/SWQB, erin.shea@state.nm.us (E-File)
Michelle Hunter, NMED/GWQB, michelle.hunter@state.nm.us (E-File)
Karen E. Armijo, NA-LA, Karen.armijo@nnsa.doe.gov (E-File)
Michael W. Hazen, mhazen@lanl.gov (E-File)
William R. Mairson, wmarison@lanl.gov (E-File)
Enrique Torres, EPC-DO, etorres@lanl.gov (E-File)
Taunia S. Van Valkenburg, EPC-CP, tauniav@lanl.gov (E-File)
Michael T. Saladen, EPC-CP, saladen@lanl.gov (E-File)
Patricia Vardaro-Charles, EPC-CP, vardaro@lanl.gov (E-File)
Andrew Erickson, UI-DO, erickson@lanl.gov, (E-File)
Lawrence Chavez, UI-OPS, lvchavez@lanl.gov, (E-File)
William Foley, EPC-CP, bfoley@lanl.gov, (E-File)
locatesteam@lanl.gov, (E-File)
epc-correspondence@lanl.gov, (E-File)
adesh-records@lanl.gov, (E-File)



Environmental Protection Division
Water Quality & RCRA Group (ENV-RCRA)
P.O. Box 1663, MS K490
Los Alamos, New Mexico 87545
505-667-0666

Date: **AUG 15 2012**
Refer To: ENV-RCRA-12-0137
LAUR: 12-22119

Ms. Claudia Hosch, Chief
NPDES Permits and TMDL Branch (6WQ)
U.S. Environmental Protection Agency (EPA), Region 6
1445 Ross Avenue, Suite 1200
Dallas, TX 75202-2733

Dear Ms. Hosch:

**SUBJECT: SUPPLEMENTAL REAPPLICATION INFORMATION AND NOTICE OF
PLANNED CHANGE IN SEWAGE SLUDGE DISPOSAL PRACTICE AT THE LOS
ALAMOS NATIONAL LABORATORY SANITARY WASTE WATER SYSTEM
FACILITY - NPDES PERMIT NM0028355**

The purpose of this letter is to provide supplemental information to the reapplication package submitted to EPA on January 27, 2012 and to inform you of a planned change in the Laboratory's sewage sludge disposal practice at the Laboratory. Beginning later this summer the Department of Energy/Los Alamos National Security (DOE/LANS) will begin composting biosolids at the Sanitary Waste Water System Plant.

An Equal Opportunity Employer / Operated by Los Alamos National Security LLC, for the U.S. Department of Energy's NNSA

Ms. Claudia Hosch
ENV-RCRA-12-0137

-2-

The material derived from sewage sludge will meet the high quality pollutant concentrations in Table 3 of 40 CFR §503.13, the more stringent Class A pathogen requirements in 40 CFR §503.32(a); and one of the eight vector attraction reduction requirements in 40 CFR §503.33(b)(1) through (b)(8). The final composted soil amendment will be land applied at the TA-60 Sigma Mesa Staging Area. The Staging Area is subject to the conditions of the TA-60 Roads and Ground Facility Multi-Sector General Permit Storm Water Pollution Prevention Plan. Compost material derived from sewage sludge that does not meet the three quality requirements above will not be land applied.

Please contact Michael T. Saladen at (505) 665-6085 of the Water Quality & RCRA Group (ENV-RCRA) if you have questions.

Sincerely,



Anthony R. Grieggs
Group Leader
Water Quality & RCRA Group (ENV-RCRA)
Los Alamos National Security, LLC

ARG:RG/lm

Enclosures:

1. Composting Facility Registration Form
2. Location of Sanitary Waste Water System (SWWS) at TA-46
3. Sanitary Waste Water Facility (additional view)
4. SWWS Facility Site Plan (traffic flow, electric transmission and storm water flows)
5. SWWS Sludge Drying Bed Return Water Flows
6. SWWS Process Schematic
7. NOI to NMED GWQB
8. TA-60 Roads and Grounds Facility MSGP SWPPP Map and Compost Application Site

Cy: Hannah Branning, USEPA/Region 6, Dallas TX, w/enc.
Isaac Chen, USEPA/Region 6, Dallas TX, w/enc.
James Hogan, NMED/SWQB, Santa Fe, NM, w/enc.
Carl A. Beard, PADOPS, A102
Michael T. Brandt, ADESH, (E-File)
Alison M. Dorries, ENV-DO, E-File
Michael T. Saladen, ENV-RCRA, (E-File)
Robert M. Gallegos, ENV-RCRA, (E-File)
IRM-RMMSO, A150, (E-File)
ENV-RCRA Correspondence File, K490

An Equal Opportunity Employer / Operated by Los Alamos National Security LLC, for the U.S. Department of Energy's NNSA

ENCLOSURE 1

Composting Facility Registration Form

ENV-RCRA-12-0137

LAUR-12-22119

AUG 15 2012

Date: _____

12-0137

Enclosure 1

LAUR-12-22119

Composting Facility Registration Form (modified version of NMED form)

Notice to Registrant: The New Mexico Solid Waste Rules (SWR), 20.9.3.27 NMAC, requires the registration of a composting facility with the New Mexico Environment Department. A composting facility means a facility, other than a transformation facility, that is capable of providing biological stabilization of organic material. The owner or operator of a composting facility must apply for a registration at least 30 days prior to any operations and every five years thereafter. Existing composting facilities shall apply for a registration at least 30 days prior to the expiration of their existing permit or registration, or within two years after the effective date of these regulations (August 2, 2007), whichever occurs first. A composting facility that fails to file a timely and complete application for registration is deemed an unpermitted solid waste facility, subjecting the owner or operator to penalties, permit requirements and nuisance abatement orders. Composting facilities required to register shall accept only source separated compostable materials. If a composting facility has or plans to increase its operational rate to more than 25 tons per day annual average, it must additionally comply with SWR 20.9.3.28 NMAC.

This form is provided to assist you in completing the registration process. Return the completed form with all attachments to: c/o Manager, Permit Section, Solid Waste Bureau, New Mexico Environment Department, 1190 St. Francis Drive, P.O. Box 5469, Santa Fe, New Mexico 87502-5469.

I. General Information

Facility Name: Sanitary Waste Water System (SWWS) – Composting Operation

Facility Owner: Los Alamos National Security (LANS)/Department of Energy (DOE)

Mailing Address: P.O. Box 1663 Mail Stop: K476, Los Alamos, New Mexico 87545

Telephone: (505) 665-7884 Contact Person: John Naranjo, Operations Manager

Facility Operator: John Naranjo

Mailing Address: Same as above

Telephone: 505.665.7884

Contact Person: SAME

Physical Address of Facility Address: Los Alamos National Laboratory, Technical Area 46 (TA-46) Building 333 – See Enclosure 2

Legal Description of Property: 35° 51' 08"N 106° 16' 29W

Land Use and Zoning of Facility: Federal Facility - TA-46 is a restricted area. Public access is allowed only under approved personnel escort. See Enclosure 2

12-0137

Enclosure 1

LAUR-12-22119

II. Facility Layout

Attach a map of the facility location indicating the land use and zoning of the surrounding area, parcel size, setbacks, and locations of all water courses or wetlands within 200' of the facility.

Attach a Site Map of the Facility Identifying:

- Name and location of facility and North arrow for direction
- Locate any adjacent roads or highways
- Facility boundary and dimensions, fencing, gates, entrances and exits
- All compost storage, loading, and unloading areas
- Traffic flow pattern
- Location of all buildings, structures and utilities – including overhead electrical lines

Enclosure 2: indicates the location of all Technical areas at Los Alamos National Laboratory with respect to the Los Alamos town site, San Ildefonso Pueblo, White Rock town site, Bandelier National Monument, the Santa Fe National Forest, Santa Fe and Los Alamos Counties. The composting operation will be located at the SWWS facility at TA-46. Enclosure 2 includes the main roads and highways. The site is accessed through an adjacent roadway off the Parjarito corridor.

Enclosure 3: view includes the roads into, and within the facility. Public access to the facility is not allowed. TA-46 is a restricted area.

Enclosure 4: includes a detailed view of the SWWS facilities, including the facility entrance (exit same), treatment facilities, compost storage area. The view also contains the location of the ephemeral water course, Canada del Buey.

Enclosure 5: indicates route and direction of sludge drying beds return water system.

Enclosure 6: schematic provides an overview of a treatment process and return water flows.

Enclosure 7: NOI to NMED GWQB.

Enclosure 8: TA-60 Roads and Grounds Facility Multi-Sector SWPPP Map and Composted Soil Amendment Application Site.

III. Operations

Anticipated Start-Up Date (for new facilities): September 1, 2012

Days/Hours of Operation: M-F; 7:30 to 4:30

On-Site Equipment and Storage Containers

12-0137

Enclosure 1

LAUR-12-22119

Type: <u>Large Dump Truck</u>	Number: <u>1</u>	Size: <u>6-10yd3</u>
Type: <u>Bobcat Loaders</u>	Number: <u>1</u>	Size: <u>1/2</u>
Type: <u>Temperature Probes</u>	Number: <u>3</u>	Size: <u>36"-48"</u>
Type: _____	Number: _____	Size: _____

Compostable Stream:

- a. Origin and Market (Indicate company name, country, state, county and/or municipality):

Biosolids are generated on-site and will serve as the principal raw compost material. A number of bulking agent source streams have been identified. These include: 1) wood chips and green materials from Laboratory sites generated from activities of the Laboratory's Road and Grounds organization; 2) wood chips from Los Alamos County; 3) wood chips from local lumber mills (e.g. Conley's Lumber); and 4) shredded paper from the Laboratory's Materials Recycling Facility(MRF).

The final composted soil amendment will be land applied on Laboratory property at the TA-60 Sigma Mesa Staging Area. The Staging Area is subject to the conditions of the TA-60 Roads and Ground Facility Multi-Sector General Permit (MSGP) - #NMR05GB21 - Storm Water Pollution Prevention Plan (SWPPP). An amendment to the SWPPP will include the addition of a 2.5-acre site consisting of shrub oak and dense grass land vegetation. The site is ideally suited for land application for beneficial use of exceptional quality compost (see enclosure # 8). The soil amendment will be applied to a 3" thickness. Located on a mesa top, the topography is generally flat and includes a number of natural swales. Depth to ground water is >1000 ft. The receiving water is Sandia Canyon. In addition to the natural controls, berms will be constructed to ensure soil amendment is not transported to water courses. Coverage of this site under the SWPPP ensures that a documented, implementable process is in place to reduce the possibility that soil amendment will reach a water course. The soil amendment application site will be subject to periodic inspections and corrective actions as specified in the SWPPP.

- b. Type/Composition (e.g., manure, food waste, mulch, etc.):

In 2011 the SWWS Facility generated approximately 30 yds³ of Biosolids. Biosolids will serve as the principal raw compost material. Wood chips will serve as the primary bulking agent.

- c. Operational Rate (Estimated volume of compostables to be accepted by the facility each day):

In 2011 the SWWS facility generated approximately 30 yds³ of sludge. The Facility will request bulking materials as needed on a monthly basis. At an approximate production rate of 30 yds³ per year, potentially 6-10 yds³ of bulking material will be utilized each month.

12-0137

Enclosure 1

LAUR-12-22119

- d. Solid Waste Component (Per 20.9.3.29 NMAC), provide plan for disposal of solid wastes that are unavoidably collected):

Only source separated bulking materials will be accepted at the Facility. Solid waste discovered in the source separated bulking materials will be collected daily and placed in receptacles and routed to the local transfer station as is the current practice. Biosolids which are not composted are place in 14ft³ leak proof and covered roll-off bins and landfilled as is the current practiced. Compost not meeting part 503 Class A – high quality will be taken to a landfill permitted to receive special waste.

OPERATIONS PLAN:

Attach an Operations Plan describing procedures for compostables acceptance, storage, processing and removal. The plan shall address the following items:

- Use of signs indicating location of the site, hours of operation, emergency telephone numbers, delivery instructions and to state that fires and scavenging are prohibited
- Means of controlling access to the facility (through use of fencing, gates, locks or other means)
- Use of leak-proof and non-biodegradable storage containers
- Means to control litter and prevent and extinguish fires
- Sufficient unloading areas to meet peak demands
- Means of controlling and mitigating noise and odors
- Conduct of safe and sanitary composting operations
- Frequency of solid waste removal, which shall be by the end of the operating day, unless otherwise approved in the registration
- For composting facilities that accept sewage sludge, provide a plan showing testing methods and procedures for compliance with 40 CFR 503 and 20.6.2 NMAC
- If applicable, demonstrate that a groundwater discharge permit has been applied for. ; go to http://www.nmenv.state.nm.us/gwb/forms/documents/Notice_of_Intent.doc for Notice of Intent, complete and submit to Ground Water Quality Bureau.
- Describe the process, loading rate, proposed capacity, size and operational rate, and the expected disposition rate of the compost from the facility
- Procedures to be taken if unauthorized waste is received
- Procedures in response to emergency situations and equipment break down to ensure that stored materials and compost will be removed in a timely manner to avoid nuisances or hazards
- Record keeping requirements
 - Submit an annual report to the Department within 45 days from the end of each calendar year, per Subsection J of 20.9.3.27 NMAC to include:
 1. the type and weight or volume of recyclable material received during the year;
 2. the type and weight or volume of recyclable material sold or otherwise disposed off site during the year;
 3. final disposition of material sold or otherwise disposed off-site; and
 4. any other information as requested by the Secretary.
- Facility personnel requirements and duties

12-0137

Enclosure 1

LAUR-12-22119

- Have a certified operator or representative present at all times while the facility is being operated
- Personnel training requirements (safety, operations, etc.)
- Update the registration if there are any significant changes in operation or of ownership
- Any additional information requested by the Secretary

Operations Plan

The SWWS Composting Facility is located at Los Alamos National Laboratory in Technical Area 46 (TA-46). The Facility is isolated from other LANL facilities. Technical Area 46 is a restricted area and public access to the SWWS Facility is controlled. The Facility can be accessed by the public, but only through an approved escort. The Facility is enclosed within a fenced area. The main gate serves as the entrance and exit into the Facility and is equipped with a locking gate. Signs are posted at the entrance to the Facility which provides warnings and instructions.

Sludge from the clarifiers (wasting) is directed to the sand sludge drying beds for dewatering. The sludge beds are equipped with an under drain system which returns water to the head works of the SWWS Plant (See Enclosure 5). Composting will take place on two of the sludge drying beds (see Enclosure 4).

Only source separated bulking materials will be accepted at the Facility. The rate at which bulking materials are to be brought onsite will correspond to the rate at which biosolids are made ready for composting. This is estimated to be 6-10 yds³ per month. Consequently, limited area is needed for bulking material storage (see Enclosure 4). Very little solid waste will be generated from the source separated bulking materials. Any solid waste generated will be collected daily and placed in receptacles and routed to the local transfer station as is the current practice. In conjunction with this registration and pursuant to 20.9.3 and 20.6.2 a notice of intent has been filed with NMED's Ground Water Quality Bureau. A copy of the NOI to the Groundwater Bureau is attached (See Enclosure 7).

In 2011 sludge production at Facility was approximately 30 yds³. At this biosolids production rate, the Facility will request bulking materials as needed and estimates the need for 6-10 yd³ of bulking materials per month. Sludge from the applied bed will be re-located to the composting bed. The Facility will use the static aerated pile composting method. The procedures on formation of a static pile are well documented and SWWS Operators have successfully completed NMED's Compost Certification Course. SWWS biosolids will be mixed with appropriate bulking materials at an anticipated ratio of 40% biosolids to 60% bulking material by volume. This ratio / mix may vary in order to meet the proper C:N ratio based on the composition of bulking material. Once mixed, the material will be piled over a bed of approximately 10 – 12" of wood shavings. The pile height will not exceed 5'. Another 10" of wood chips will be placed above the mix to provide added levels of odor and vector controls. Compost operations conducted over the drying beds will provide a closed

12-0137

Enclosure 1

LAUR-12-22119

system for liquids and further facilitate a safe and sanitary operation. The SWWS's *Operation and Maintenance Manual* includes a number of procedures on how odors are controlled for the Facility.

To record pathogen and vector attraction reduction, temperatures and moisture content will be monitored and logged twice per day. Once the 15 day active stage is completed, the compost will be cured for 30-45 days. Once the product is cured (pile ambient temperatures reached), and before land application, sampling and analysis pursuant to Part 503 (and specified below) will be conducted. An estimated 150 yds³ of composted soil amendment will be generated annually.

The final composted soil amendment will be land applied at the TA-60 Sigma Mesa Staging Area. The Staging Area is subject to the conditions of the TA-60 Roads and Ground Facility NPDES Multi-Sector General Permit (MSGP) - Storm Water Pollution Prevention Plan (SWPPP).

Compliance with 40 CFR 503 will be achieved as follows:

The SWWS Facility will use the Static Aerated Pile composting method to produce an "exceptional quality" (EQ) biosolid or Composted Soil Amendment. Only EQ biosolids will be land applied at LANL. EQ biosolids meet the Part 503 pollutant concentration limits (Table 3 of Section 503.13) as well as Class A pathogen reduction requirements and one of the first eight vector attraction reduction options listed in 503.33(b)(1) through (b)(8). At anticipated rates of production, the monitoring frequency for metals and fecal coliform will be no more than once per quarter. Specified monitoring rates are established in Table 1 of §503.16. Monitoring will take place prior to land application. Monitoring for fecal coliform bacteria will be conducted close to the time of final use.

Table 1 of §503.16—Frequency of Monitoring—Land Application

Amount of sewage sludge ¹ (metric tons per 365 day period)	Frequency
Greater than zero but less than 290	Once per year.
Equal to or greater than 290 but less than 1,500	Once per quarter (four times per year).

¹Either the amount of bulk sewage sludge applied to the land or the amount of sewage sludge prepared for sale or give-away in a bag or other container for application to the land (dry weight basis).

Monitoring Considerations for Class A - High Quality Compost

Parameter	Frequency ¹	Sample Type and Amount	When	Sample Location	Methods
Metals ²	Annually or Quarterly	Composite ³ (7 grab samples)	Before ⁴ Use or Land Application	On-Site at varying depths and locations within pile	SW-846
Fecal Coliform	Annually or Quarterly	7 individual grab samples over a 14 day period ³	Before ⁴ Use or Land Application	On-site at varying depths and locations within pile	SM-9221 E (MPN) SM-9222 D (membrane filter)

12-0137

Enclosure 1

LAUR-12-22119

1. §503.16—Frequency of Monitoring—Land Application
2. §503.13 – Table 1 and Table 3
3. No fixed number – Guidance
4. Close to the time of use or disposal

To ensure Class A Pathogen Reduction in the aerated static pile composting processes, temperatures will be taken at multiple points at a range of depths throughout the composting medium. Pathogen reduction will take place at the same time as vector attraction reduction. The temperature of the sewage sludge must be maintained at 55°C or higher for three (3) consecutive days. The following information will be recorded and documented: description of the composting method, the date and times temperatures maintained above 55°C and 2 temperature readings at least 7 hours apart.

Description of Compost Method	Date / Time	Temperature °C	Temperature °C	Sampler
		Time #1	Time #2	

Vector Attraction Reduction Option 5 will be used. This option requires aerobic treatment (e.g. composting) of the sewage sludge for at least 14 consecutive days at over 40°C (104°F) with an average temperature of over 45°C (113°F). The following information will be recorded and documented: description of the composting method, the date and times temperatures maintained above 40°C - 45°C, documenting average temperatures and 2 temperature readings at least 7 hours apart.

Description of Treatment Process	Date / Time	Temperature °C	Temperature °C	Sampler
		Time #1	Time #2	

The SWWS Facility maintains an emergency protocol for each of its major processes. The protocol is outlined in the *Wastewater Treatment Facility Operation Manual*. By procedure, a logical sequence of steps are to be followed by the operator on duty in responding to emergencies: identifying the emergency, investigating its extent, deciding on proper initial course of action, taking corrective action to rectify the situation, and following up with a post-emergency investigation.

To prepare for the annual report required by 20.9.3.27, the following information will be maintained and recorded:

- Amount of source separated bulking material brought on-site
- Amount of biosolids generated and used in the composting process
- Final disposition of compost material

The report will be submitted to NMED Solid Waste Bureau within 45 days of the end of the calendar year.

The SWWS Facility currently has 3 operators certified per 20.9.7. A certified operator will be on-site during hours of composting operations. SWWS operators are subject to an extensive training plan that requires instruction in operations and safety and, in part, includes the following course work, hands on training and certifications:

- Maintenance Worker
- Fork lift operator

12-0137

Enclosure 1

LAUR-12-22119

- Incidental crane operator
- Sanitary Waste Water System
- Chemical Hazard Communication
- Corrosives Hazard Training
- Electric Safety Basics
- Excavation Fill Soil Disturbance
- Fork Lift Operator
- Incidental Crane Operator
- NM State Waste Water Certification
- NM State Compost Certification
- Radiological Worker II Training
- Lockout/Tagout Authorized Worker
- Air Monitoring for Confined Spaces
- Fall Protection
- First Aid

20.9.3.28 ADDITIONAL REGISTRATION REQUIREMENTS FOR COMPOSTING FACILITIES THAT ACCEPT GREATER THAN 25 TONS PER DAY COMPOSTABLE MATERIAL OR GREATER THAN 5 TONS PER DAY OF MATERIAL THAT WOULD OTHERWISE BECOME SPECIAL WASTE.

Not Applicable

IV. ACKNOWLEDGEMENTS

- A. I AM AWARE THAT THE OWNER OR OPERATOR IS REQUIRED TO COMPLY WITH ALL OF THE TERMS OF THE APPROVED REGISTRATION _____ INITIALS
- B. I AM AWARE THAT THE OWNER OR OPERATOR MUST UPDATE THIS REGISTRATION TO REFLECT ANY MATERIAL CHANGES IN OPERATIONS (PRIOR TO IMPLEMENTING SUCH CHANGES)
_____ INITIALS

The undersigned attests the information provided is true and accurate.

Signature and Title

Date

Telephone

ENCLOSURE 2

Location of Sanitary Waste Water Systems (SWWS) at TA-46

ENV-RCRA-12-0137

LAUR-12-22119

Date: AUG 15 2012

Technical Areas

- TA-00 OFF SITE
- TA-02 OMEGA SITE
- TA-03 SOUTH MESA SITE
- TA-05 BETA SITE
- TA-06 TWO MILE MESA SOUTH SITE
- TA-08 ANCHOR WEST SITE
- TA-09 ANCHOR EAST SITE
- TA-11 K SITE
- TA-14 Q SITE
- TA-15 R SITE
- TA-16 S SITE
- TA-18 PALARITO LABORATORY
- TA-21 DF SITE
- TA-22 TD SITE
- TA-28 MAGAZINE AREA
- TA-33 HP SITE
- TA-35 TEN SITE
- TA-36 KAPPA SITE
- TA-37 MAGAZINE AREA C
- TA-39 ANCHO CANYON SITE
- TA-40 DF SITE
- TA-41 W SITE
- TA-43 HEALTH RESEARCH LABORATORY
- TA-46 W4 SITE
- TA-48 RADIOCHEMISTRY SITE
- TA-49 RIOLOS MESA SITE
- TA-50 WASTE MANAGEMENT SITE
- TA-51 ENVIRONMENTAL RESEARCH SITE
- TA-52 REACTOR DEVELOPMENT SITE
- TA-53 LOS ALAMOS NEUTRON SCIENCE CENTER
- TA-54 WASTE DISPOSAL SITE
- TA-55 PLUTONIUM FACILITY SITE
- TA-57 FENTON HILL
- TA-58 TWO MILE MESA NORTH SITE
- TA-59 OH SITE
- TA-66 SIGMA MESA SITE
- TA-61 EAST JEMEZ SITE
- TA-62 NORTHWEST SITE
- TA-63 PALARITO SERVICE SITE
- TA-64 CENTRAL GUARD SITE
- TA-65 CENTRAL TECHNICAL SUPPORT SITE
- TA-67 PALARITO MESA SITE
- TA-68 WATER CANYON SITE
- TA-69 ANCHOR NORTH SITE
- TA-70 RIO GRANDE SITE
- TA-71 SOUTHEAST SITE
- TA-72 EAST ENTRY SITE
- TA-73 AIRPORT SITE
- TA-74 OTOWI SITE

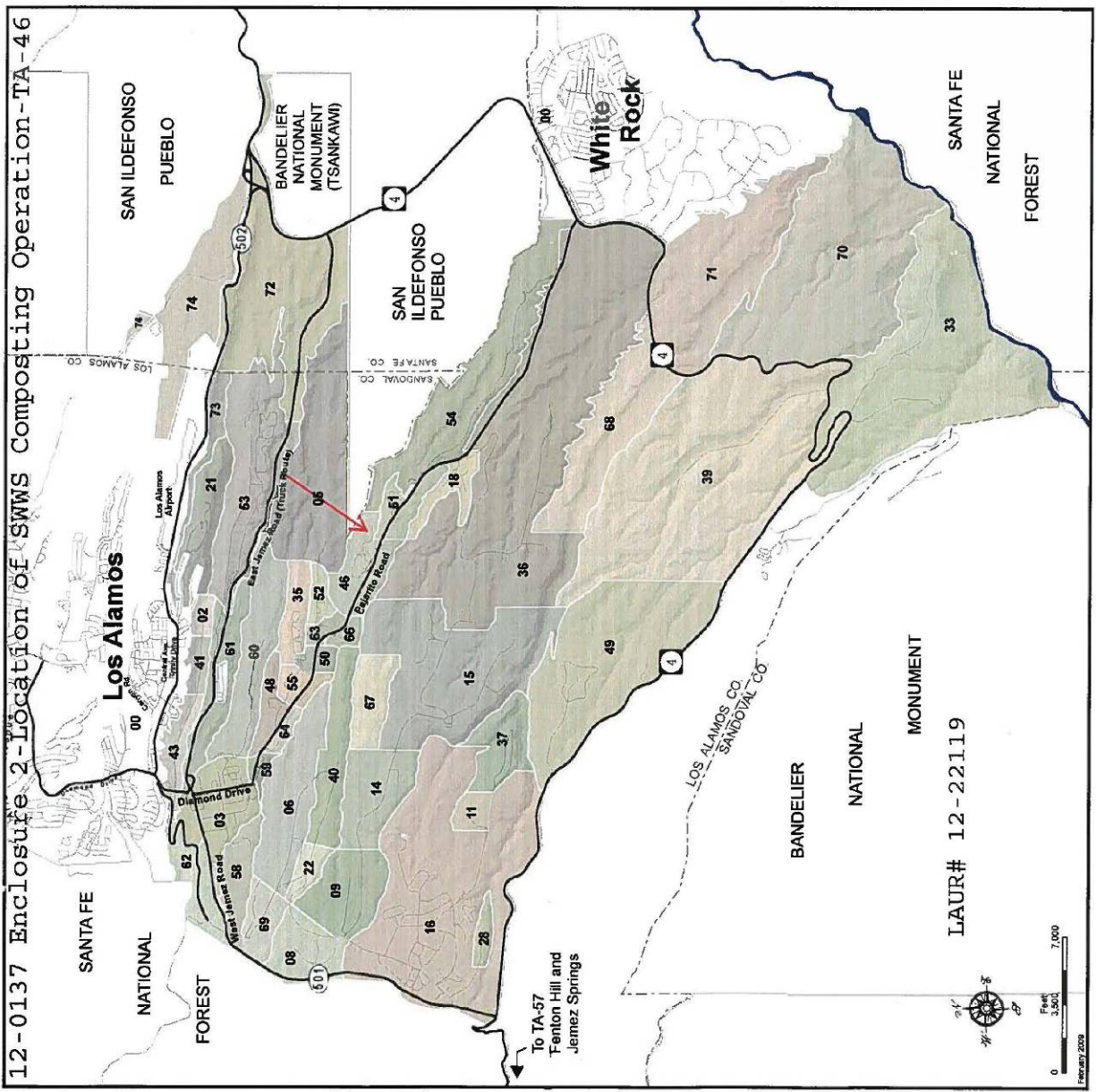

ENCLOSURE 3

Sanitary Waste Water Facility (additional view)

ENV-RCRA-12-0137

LAUR-12-22119

AUG 1 5 2012

Date: _____

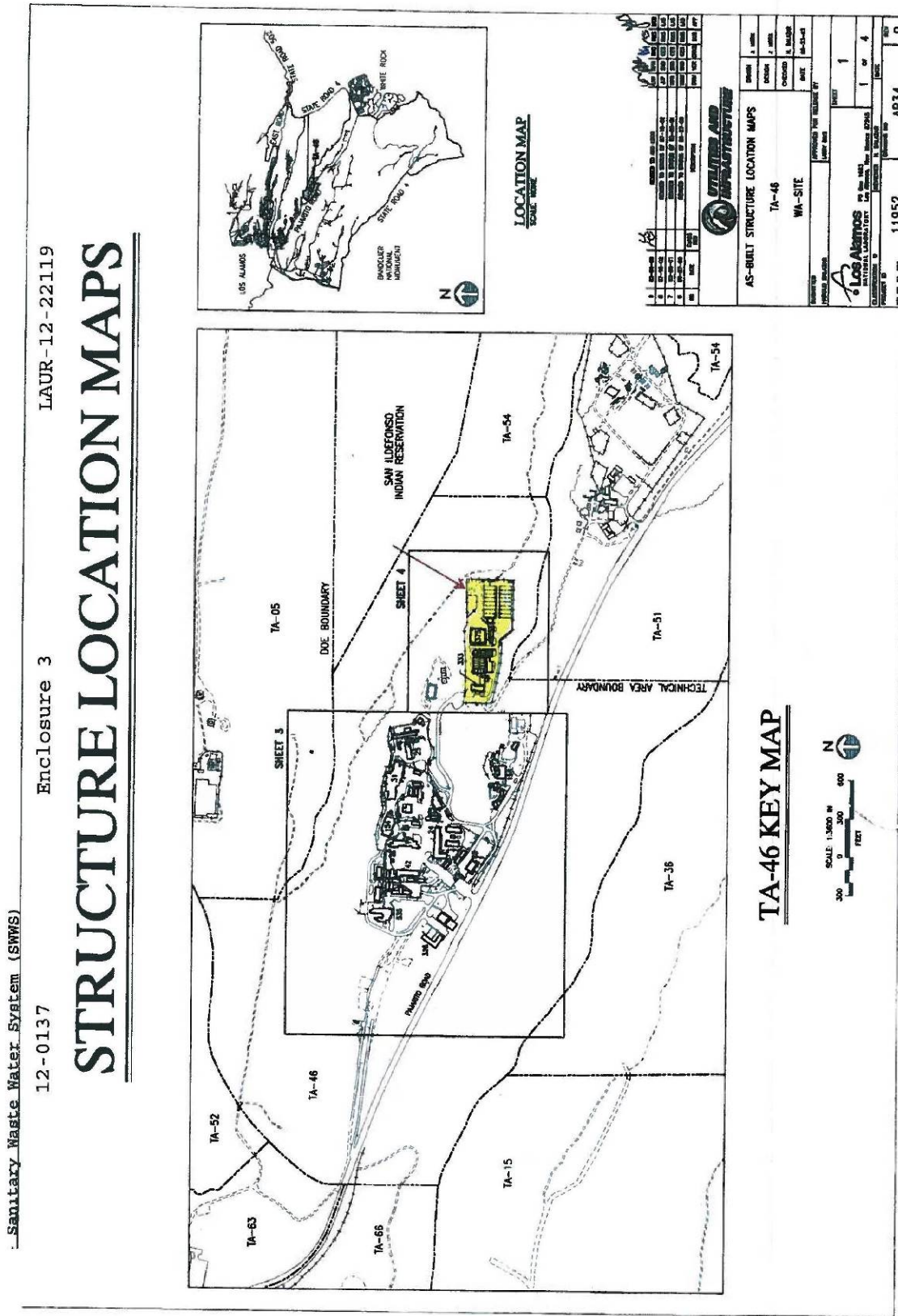

ENCLOSURE 4

SWWS Facility Site Plan (traffic flow, electric transmission and storm
water flows)

ENV-RCRA-12-0137

LAUR-12-22119

AUG 15 2012

Date: _____

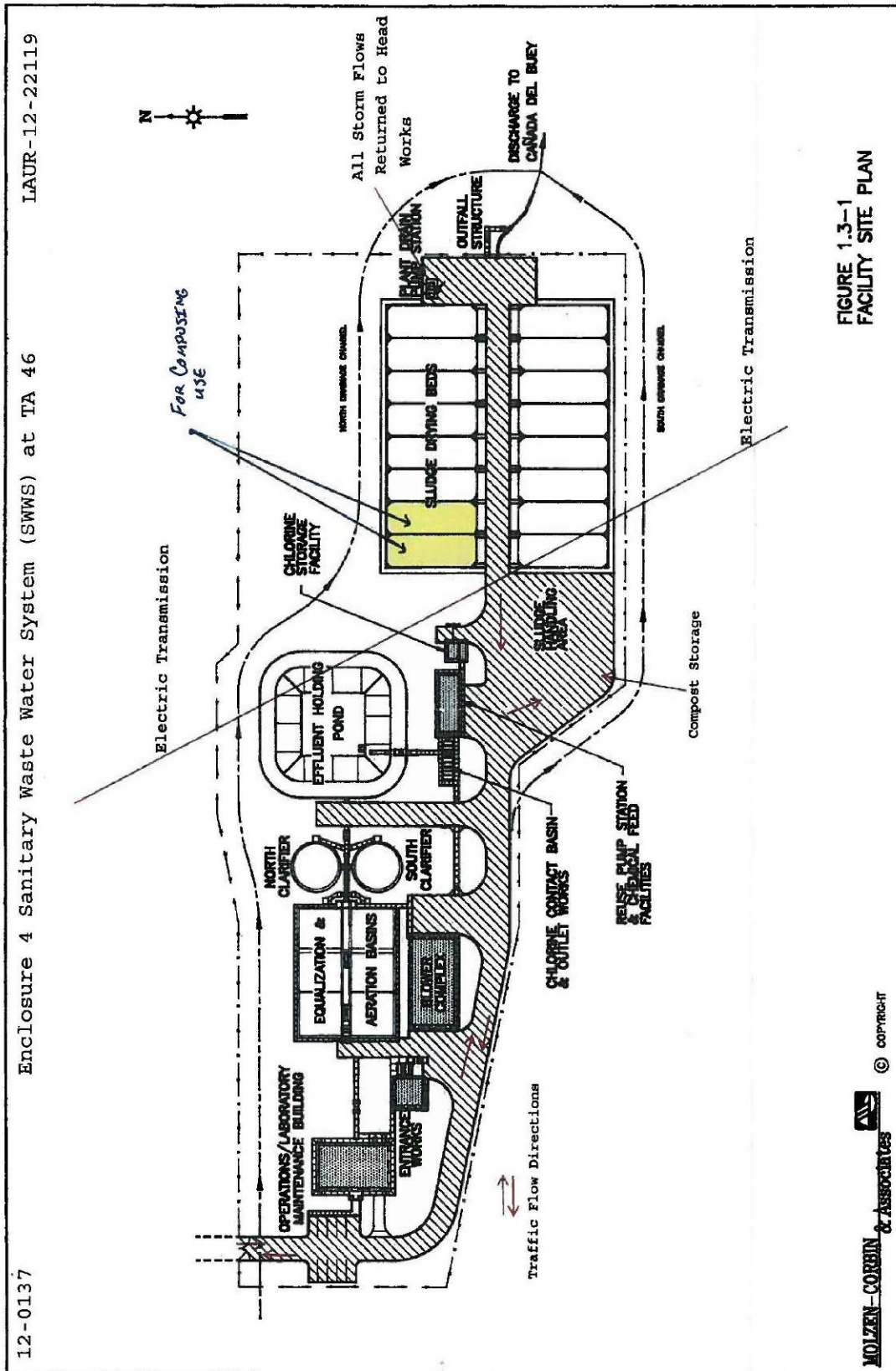

ENCLOSURE 5

SWWS Sludge Drying Bed Return Water Flows

ENV-RCRA-12-0137

LAUR-12-22119

Date: AUG 15 2012

LAUR# 12-22119

Enclosure 5

Attachment 4 - SWS Sludge Drying Beds Return Water System

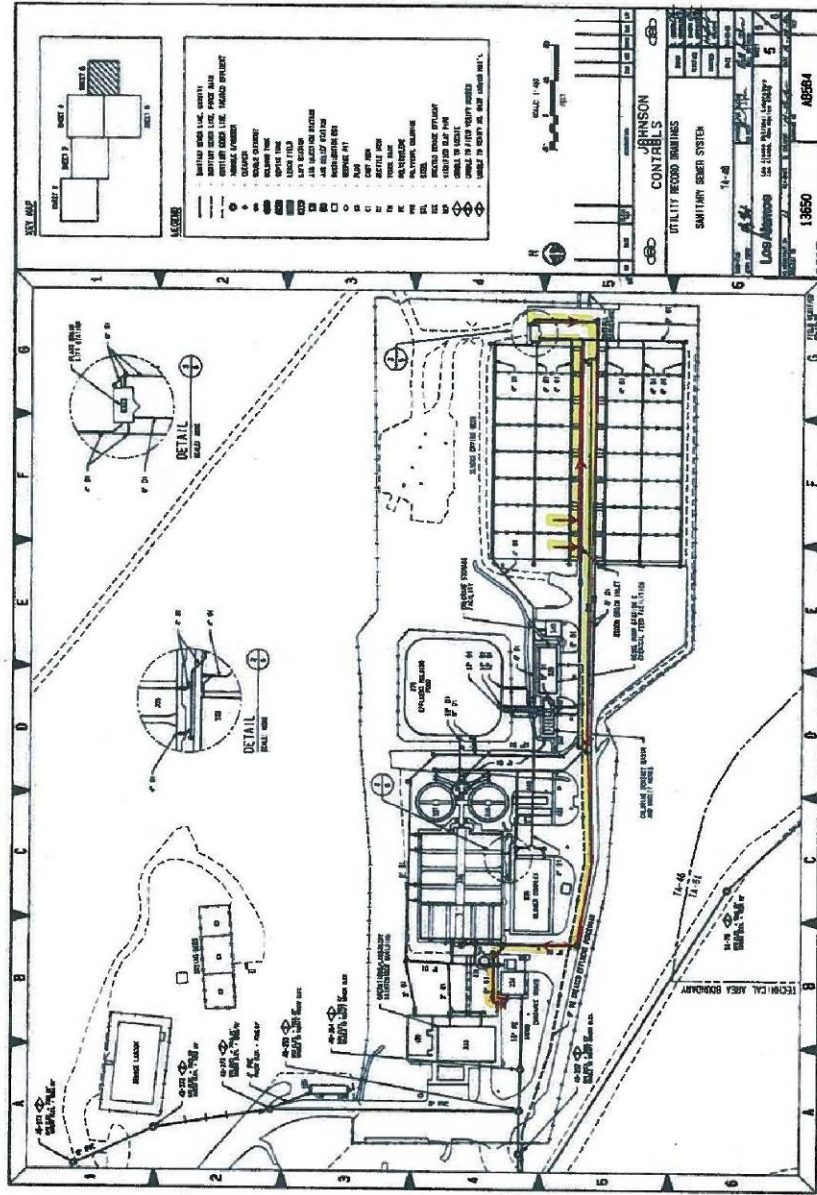

ENCLOSURE 6

SWWS Process Schematic

ENV-RCRA-12-0137

LAUR-12-22119

Date: **AUG 15 2012**

12-0137

Process Schematic

ENCLOSURE 6

LAUR# 12-22119

**SANITARY WASTEWATER SYSTEMS (SWWS) PLANT
TA-46 BUILDING 333 (ADMIN. /CONTROL ROOM/LAB)
OUTFALL #13S**

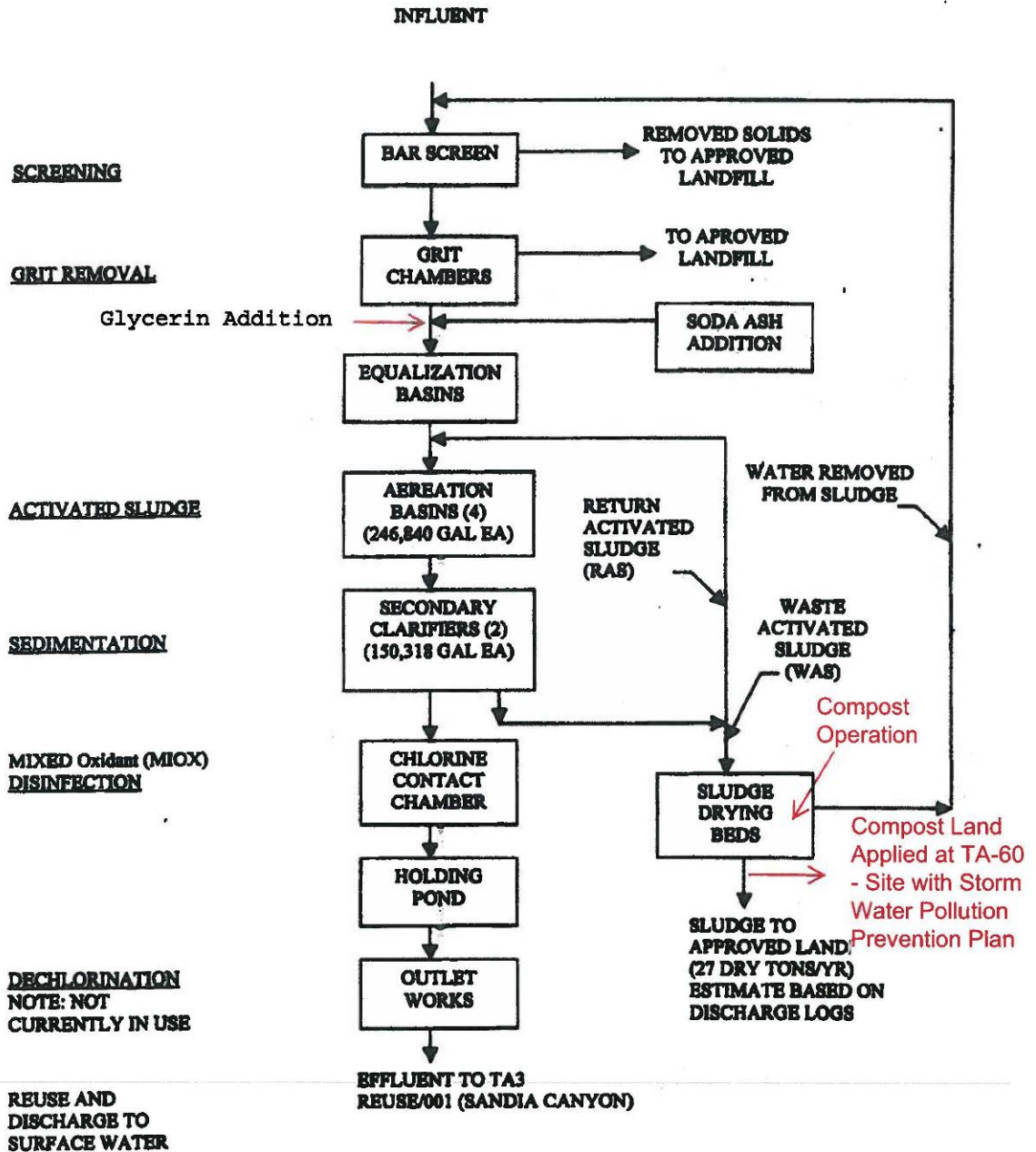

ENCLOSURE 7

NOI to NMED GWQB

ENV-RCRA-12-0137

LAUR-12-22119

Date: **AUG 15 2012**



New Mexico Environment Department
Ground Water Quality Bureau

**Ground Water Quality Bureau –
Pollution Prevention Section
Notice of Intent**

1. Name and mailing address of person proposing to discharge:

John D. Naranjo, Operations Manager

Work Phone: (505) 665-7884

Sanitary Waste Water System (SWWS) Composting Facility

Cell/Home Phone (505) 231-0513

Los Alamos National Laboratory

Fax: (505)667-7746

PO Box 1663; Mail Stop J972 – Los Alamos, NM 87545

Email: john@lanl.gov

2. Name of facility:

Sanitary Waste Water System (SWWS) Composting Operation

3. Physical location of discharge (if applicable, give street address, township, range, section, distance from closest town or landmark, directions to facility, location map):

The SWWS is located at Los Alamos National Laboratory in Technical Area 46. Latitude - 35° 51' 08"N and Longitude – 106° 16' 29"W – See Enclosure 4 and 5.

4. Type of operation generating the discharge (e.g., truck wash, food processing plant, restaurant, etc.):

Through a conventional waste water treatment process, the SWWS facility treats sanitary waste water, process water, cooling water, storm water, and waste water discharged to the sanitary sewer and/or collected in storage tanks from all technical areas at the Laboratory. All waste water discharged to the SWWS Plant must comply with the facility's Waste Acceptance Criteria. The facility's effluent discharge is permitted under NPDES # NM0028355 and DP-857. Waste sludge from the SWWS is mixed with a polymer, and discharged to the sludge drying beds. Decanted water from the digester and/or sludge drying beds is recycled to the head works for treatment. Enclosures 6, 7 and 8 provide a description of the process. The SWWS Facility will use the Static Aerated Pile composting method to produce an "exceptional quality"(EQ) biosolid or EQ composted soil amendment. Only EQ soil amendments will be land applied at LANL (see question #5). EQ soil amendments meet the 40 CFR Part 503 pollutant concentration limits (Table 3 of Section 503.13) as well as Class A pathogen reduction requirements and one of the first eight vector attraction reduction options listed in 503.33(b)(1) through (b)(8).

5. Source(s) of the discharge. Describe how the wastewater, sludge, or other discharges processed and/or disposed at your facility are generated. Identify all sources. Attach additional pages if needed:

Composting will take place on two of the sludge drying beds (see Enclosure #6). In the static pile design, composting feed stocks and bulking materials will be placed under and over the sludge to facilitate aeration and provide added levels of odor and vector controls. Compost operations conducted over the drying beds will provide a closed system for liquids and further facilitate a safe and sanitary operation. Decanted water from the digester and/or sludge drying beds is recycled to the head works for treatment. Waters generated from the composting operation will be returned to the head works of the treatment plant. See Enclosure 7 and 8.

No discharge to ground water will occur from the composting dewatering operation. The final soil amendment will be land applied on Laboratory property at the TA-60 Sigma Mesa Staging Area. The



New Mexico Environment Department
Ground Water Quality Bureau

Ground Water Quality Bureau –
Pollution Prevention Section
Notice of Intent

Staging Area is subject to the conditions of the TA-60 Roads and Ground Facility Multi-Sector General Permit (MSGP) - #NMR05GB21 - Storm Water Pollution Prevention Plan (SWPPP). An amendment to the SWPPP will include the addition of a 2.5-acre site consisting of shrub oak and dense grassland vegetation. The site is ideally suited for land application for beneficial use of the final soil amendment. (see Enclosure 2). The soil amendment will be applied to a 3" thickness. Located on a mesa top, the topography is generally flat and includes a number of natural swales. Depth to ground water is >1000 ft. The receiving water is Sandia Canyon. In addition to the natural controls, berms will be constructed to ensure soil amendments are not transported to water courses. Coverage of this site under the SWPPP ensures that a documented, implementable process is in place to reduce the possibility that compost materials will reach a water course. The compost application site will be subject to periodic inspections and corrective actions as specified in the SWPPP.

6. Expected contaminants in the discharge (e.g., nitrate-nitrogen, metals, organic compounds, salts, etc.) include estimated concentration if known, and copies of results of laboratory analyses, if available:

No discharge to ground water will occur from the composting dewatering operation. The return stream (to head works) from the dewatering process contains ammonia, nitrates, chloride, organic compounds, phosphorus, methane, hydrogen sulfide, microorganisms. The final composted soil amendment will be land applied as specified above. The composted soil amendment will meet 40 CFR Part 503 requirements for land application: the pollutant concentrations for high quality sewage sludge in 503.13(b)(3), the more stringent Class A pathogen requirements in 503.32(a), and one of vector attraction reduction requirements in 503.33(b)(1) through 503.33(b)(8).

7. Describe all components of wastewater processing, treatment, storage, and disposal system (e.g., grease interceptor, lagoon, septic tank/leachfield, etc.) include size, site layout map, plans and specifications, etc. if available:

Wastewater is received at the SWWS from a sanitary wastewater collection system and is routed through (see attached process schematic) a bar screen → grit chamber → splitter box → equalization basins → aeration basins → secondary clarifiers → chlorine contact chamber. The sludge generated is discharged to drying beds. See Enclosure 6, 7 and 8. Composting will take place on two of the sludge drying beds (see Enclosure #8). Water generated from the composting operation will be returned to the head works of the treatment plant.

8. Estimated depth to ground water (ft):

1000' to 1300' (Regional) – 2010 Ground Water Level Status Report

Signature: Andrew W. Erickson

Date: 7/26/12

Printed name: Andrew W. Erickson

Title: Facility Operations Director
Utilities and Institutional Facilities

Please return this form to:

NMED Ground Water Quality Bureau
P.O. Box 5469
Santa Fe, New Mexico 87502-5469

Telephone: 505-827-2900
Fax: 505-827-2965

December 4, 2008 Page 1 of 1
Notice of Intent

Ground Water Quality Bureau – Pollution Prevention Section
Notice of Intent

ENCLOSURE 7

12-0137

LAUR-12-22119

ENCLOSURE 8

TA-60 Roads and Grounds Facility MSGP SWPPP Map & Compost
Application Site

ENV-RCRA-12-0137

LAUR-12-22119

AUG 15 2012

Date: _____

LAUR 12-22119
**ROADS AND GROUNDS
OPERATIONAL SWPPP
SIGMA MESA
STAGING AREA**

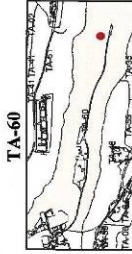

LEGEND

	DRAINAGE PATTERN
	DIRECTION OF FLOW
	FRS
	VEHICLE STORAGE
	ROCK CHECK DAM
	CONSTRUCTION MATERIAL PILE
	SAMPLER
	SHED
	DISCHARGE PTS.
	RUN ON POINT
	EQUIPMENT STORAGE
	EARTHEN BERM
	SIGMA MESA STAGING AREA BOUNDARY
	PAVED AREAS
	DIRT ROADS
	DITCH
	SPILL
	FENCE
	20 FT CONTOURS
	GRAVEL
	PROPOSED BERM



U07001 Rev.1
Classification: U Reviewer: K. Salazar Date: 16-JUL-2012

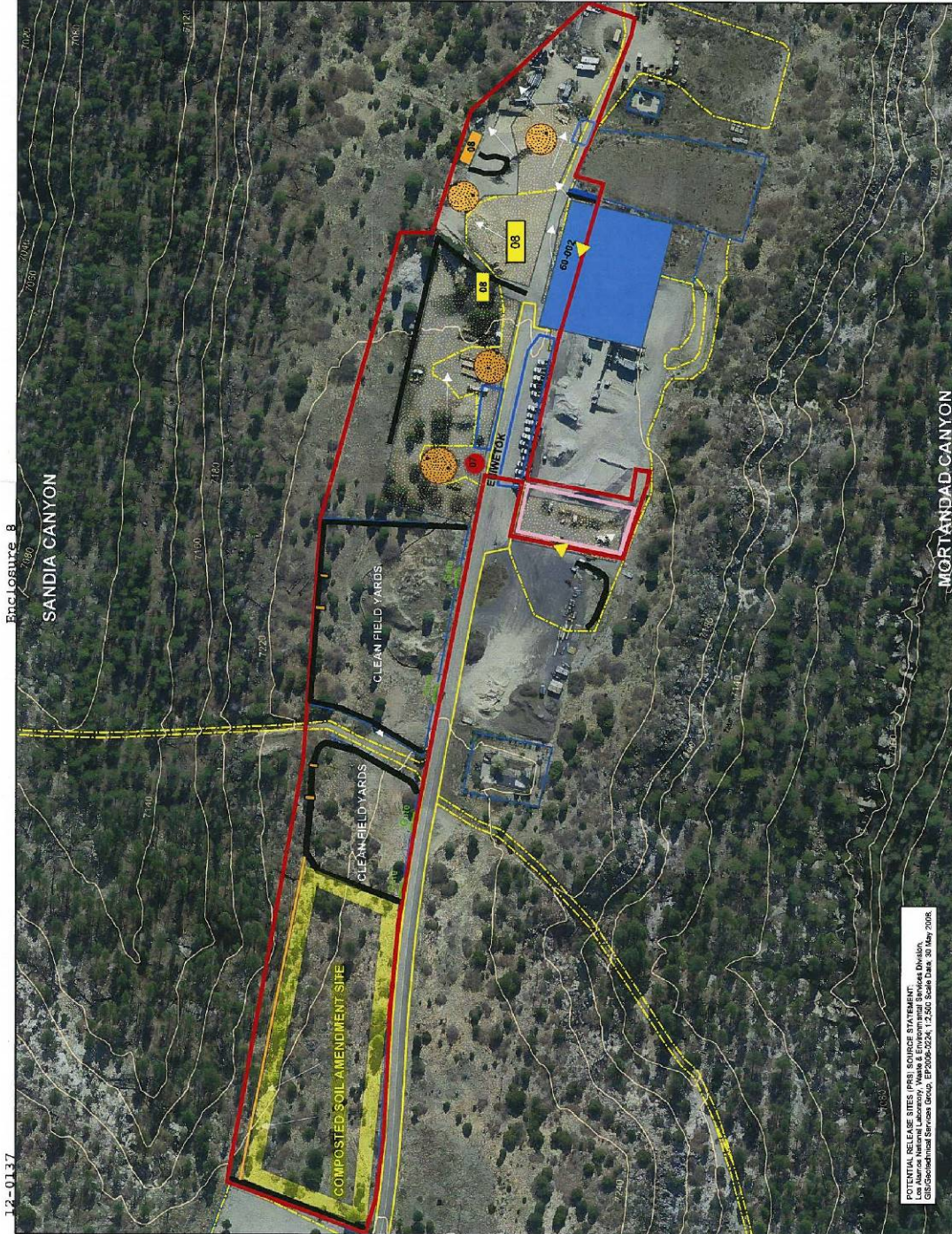

POTENTIAL RELEASE SITES (PRS) SOURCE STATEMENT.
Los Alamos National Laboratory, Waste & Environmental Services Division,
600 Goddard Street, Suite 600, Los Alamos, NM 87545, 12-22119, 31 May 2008.



Environmental Protection Division
Water Quality & RCRA Group (ENV-RCRA)
P.O. Box 1663, Mail Stop K490
Los Alamos, New Mexico 87545
(505) 667-0666

Date: JUL 31 2012
Refer To: ENV-RCRA-12-0154
LAUR: 12-22609

Mr. Jerry Schoeppner, Bureau Chief
New Mexico Environment Department
Ground Water Quality Bureau
Harold Runnels Building, Room N2250
1190 St. Francis Drive
P.O. Box 26110
Santa Fe, New Mexico 87502

Mr. James Hogan, Acting Bureau Chief
New Mexico Environment Department
Surface Water Quality Bureau
Harold Runnels Building, Room N2050
1190 St. Francis Drive
PO Box 5469
Santa Fe, New Mexico 87502-5469

Dear: Mr. Schoeppner and Mr. Hogan:

**SUBJECT: NOTICE OF INTENT OF PLANNED CHANGE IN SEWAGE SLUDGE DISPOSAL
PRACTICE AT THE LOS ALAMOS NATIONAL LABORATORY'S SANITARY
WASTE WATER SYSTEM FACILITY**

The purpose of this letter is to inform you of a planned change in the Laboratory's biosolids disposal practice. Beginning later this summer the Laboratory will begin composting biosolids at the Sanitary Waste Water System (SWWS) Facility. Enclosed is a Notice of Intent, submitted pursuant to 20.6.2 and 20.9.3 NMAC, conveying pertinent details of the project. Other supporting information is also enclosed for your information.

The composting of biosolids will take place on the SWWS sludge drying beds. These beds are equipped with an under drain system and all waters generated from the composting dewatering operation will return to head works of the plant.

The final composted soil amendment will be land applied and will meet the high quality pollutant concentrations in Table 3 of 40 CFR 503.13, the more stringent Class A pathogen requirements in 40 CFR 503.32(a); and one of the eight vector attraction reduction requirements in 40 CFR 503.33(b)(1)

Mr. Jerry Schoeppner & Mr. James Hogan - 2 -
ENV-RCRA-12-0154

through (b)(8). Compost material derived from sewage sludge that does not meet the three exceptional quality requirements above will not be land applied.

The final soil amendment will be land applied on Laboratory property at the TA-60 Sigma Mesa Staging Area. The Staging Area is subject to the conditions of the TA-60 Roads and Ground Facility Multi-Sector General Permit (MSGP) - #NMR05GB21 - Storm Water Pollution Prevention Plan (SWPPP). An amendment to the SWPPP will include the addition of a 2.5-acre site consisting of shrub oak and dense grassland vegetation. The site is ideally suited for land application for beneficial use of the final soil amendment. Coverage of this site under the SWPPP ensures that a documented, implementable process is in place to reduce the possibility that compost materials will reach a watercourse. The application site will be subject to periodic inspections and corrective actions as specified in the SWPPP.

Please contact Mike Saladen at (505) 665-6085 of the Water Quality and RCRA Group (ENV-RCRA) if you have questions or need additional information.

Sincerely,

Anthony R. Grieggs
Group Leader
Water Quality & RCRA Group (ENV-RCRA)

ARG:RMG/lm

Enclosure:

1. GWQB Notice of Intent
2. TA-60 Roads and Grounds Facility MSGP SWPPP Map and Compost Application Site
3. Composting Facility Registration Form
4. Location of Sanitary Waste Water System (SWWS) at TA-46
5. Sanitary Waste Water Facility (additional view)
6. SWWS Facility Site Plan (traffic flow, electric transmission and storm water flows)
7. SWWS Sludge Drying Bed Return Water Flows
8. SWWS Process Schematic.

Cy: Gene Turner, LASO-EPO, w/enc., A316, (E-File)
Carl A. Beard, PADOPS, w/o enc., A102
Michael T. Brandt, ADESH, w/o enc., (E-File)
Alison M. Dorries, ENV-DO, w/o enc., (E-File)
Michael T. Saladen, ENV-RCRA, w/enc., (E-File)
Robert M. Gallegos, ENV-RCRA, w/enc., (E-File)
IRM-RMMSO, A150, (E-File)
ENV-RCRA Correspondence File, w/enc., K490

An Equal Opportunity Employer / Operated by Los Alamos National Security, LLC for the U.S. Department of Energy's NNSA

ENCLOSURE 1

GWQB Notice of Intent

ENV-RCRA-12-0154

LAUR-12-22609

Date: **JUL 3 1 2012**



New Mexico Environment Department
Ground Water Quality Bureau

Ground Water Quality Bureau –
Pollution Prevention Section
Notice of Intent

1. Name and mailing address of person proposing to discharge:

Robert M. Ortiz, Operations Manager

Work Phone: (505) 665-3959

Sanitary Waste Water System (SWWS) Composting Facility

Cell/Home Phone (505) 699-0975

Los Alamos National Laboratory

Fax: (505) 667-9057

PO Box 1663; Mail Stop J972 – Los Alamos, NM 87545

Email: robo@lanl.gov

2. Name of facility:

Sanitary Waste Water System (SWWS) Composting Operation

3. Physical location of discharge (if applicable, give street address, township, range, section, distance from closest town or landmark, directions to facility, location map):

The SWWS is located at Los Alamos National Laboratory in Technical Area 46. Latitude - 35° 51' 08"N and Longitude – 106° 16' 29"W – See Enclosure 4 and 5.

4. Type of operation generating the discharge (e.g., truck wash, food processing plant, restaurant, etc.):

Through a conventional waste water treatment process, the SWWS facility treats sanitary waste water, process water, cooling water, storm water, and waste water discharged to the sanitary sewer and/or collected in storage tanks from all technical areas at the Laboratory. All waste water discharged to the SWWS Plant must comply with the facility's Waste Acceptance Criteria. The facility's effluent discharge is permitted under NPDES # NM0028355 and DP-857. Waste sludge from the SWWS is mixed with a polymer, and discharged to the sludge drying beds. Decanted water from the digester and/or sludge drying beds is recycled to the head works for treatment. Enclosures 6, 7 and 8 provide a description of the process. The SWWS Facility will use the Static Aerated Pile composting method to produce an "exceptional quality"(EQ) biosolid or EQ composted soil amendment. Only EQ soil amendments will be land applied at LANL (see question #5). EQ soil amendments meet the 40 CFR Part 503 pollutant concentration limits (Table 3 of Section 503.13) as well as Class A pathogen reduction requirements and one of the first eight vector attraction reduction options listed in 503.33(b)(1) through (b)(8).

5. Source(s) of the discharge. Describe how the wastewater, sludge, or other discharges processed and/or disposed at your facility are generated. Identify all sources. Attach additional pages if needed:

Composting will take place on two of the sludge drying beds (see Enclosure #6). In the static pile design, composting feed stocks and bulking materials will be placed under and over the sludge to facilitate aeration and provide added levels of odor and vector controls. Compost operations conducted over the drying beds will provide a closed system for liquids and further facilitate a safe and sanitary operation. Decanted water from the digester and/or sludge drying beds is recycled to the head works for treatment. Waters generated from the composting operation will be returned to the head works of the treatment plant. See Enclosure 7 and 8.

No discharge to ground water will occur from the composting dewatering operation. The final soil amendment will be land applied on Laboratory property at the TA-60 Sigma Mesa Staging Area. The



New Mexico Environment Department
Ground Water Quality Bureau

Ground Water Quality Bureau –
Pollution Prevention Section
Notice of Intent

Staging Area is subject to the conditions of the TA-60 Roads and Ground Facility Multi-Sector General Permit (MSGP) - #NMR05GB21 - Storm Water Pollution Prevention Plan (SWPPP). An amendment to the SWPPP will include the addition of a 2.5-acre site consisting of shrub oak and dense grassland vegetation. The site is ideally suited for land application for beneficial use of the final soil amendment. (see Enclosure 2). The soil amendment will be applied to a 3" thickness. Located on a mesa top, the topography is generally flat and includes a number of natural swales. Depth to ground water is >1000 ft. The receiving water is Sandia Canyon. In addition to the natural controls, berms will be constructed to ensure soil amendments are not transported to water courses. Coverage of this site under the SWPPP ensures that a documented, implementable process is in place to reduce the possibility that compost materials will reach a water course. The compost application site will be subject to periodic inspections and corrective actions as specified in the SWPPP.

6. Expected contaminants in the discharge (e.g., nitrate-nitrogen, metals, organic compounds, salts, etc.) Include estimated concentration if known, and copies of results of laboratory analyses, if available:

No discharge to ground water will occur from the composting dewatering operation. The return stream (to head works) from the dewatering process contains ammonia, nitrates, chloride, organic compounds, phosphorus, methane, hydrogen sulfide, microorganisms. The final composted soil amendment will be land applied as specified above. The composted soil amendment will meet 40 CFR Part 503 requirements for land application: the pollutant concentrations for high quality sewage sludge in 503.13(b)(3), the more stringent Class A pathogen requirements in 503.32(a), and one of vector attraction reduction requirements in 503.33(b)(1) through 503.33(b)(8).

7. Describe all components of wastewater processing, treatment, storage, and disposal system (e.g., grease interceptor, lagoon, septic tank/leachfield, etc.) Include sizes, site layout map, plans and specifications, etc. if available:

Wastewater is received at the SWWS from a sanitary wastewater collection system and is routed through a bar screen » grit chamber » splitter box » equalization basins » aeration basins » secondary clarifiers » chlorine contact chamber. The sludge generated is discharged to drying beds. See Enclosure 6, 7 and 8. Composting will take place on two of the sludge drying beds (see Enclosure #6). Waters generated from the composting operation will be returned to the head works of the treatment plant.

8. Estimated depth to ground water (ft):

1000' to 1300' (Regional) – 2010 Ground Water Level Status Report

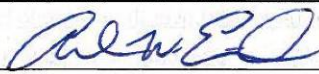
Signature:  Date: 7/26/12

Printed name: Andrew W. Erickson Title: Facility Operations Director
Utilities & Institutional Facilities

Please return this form to:
NMED Ground Water Quality Bureau
P.O. Box 5469
Santa Fe, New Mexico 87502-5469

Telephone: 505-827-2900
Fax: 505-827-2965

ENCLOSURE 2

TA-6- Roads and Grounds Facility MSGP SWPPP Map and Compost
Application Site

ENV-RCRA-12-0154

LAUR-12-22609

Date: **JUL 3 1 2012**

LAUR 12-22609
ROADS AND GROUNDS
OPERATIONAL SWPPP
SIGMA MESA
STAGING AREA

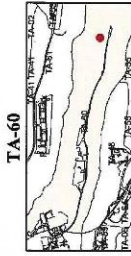

LEGEND

	DRAINAGE PATTERN
	DIRECTION OF FLOW
	PRS
	VEHICLE STORAGE
	ROCK CHECK DAM
	CONSTRUCTION MATERIAL PILE
	SAMPLER
	SHED
	DISCHARGE PTS.
	RUN ON POINT
	EQUIPMENT STORAGE
	EARTHEN BERM
	SIGMA MESA STAGING AREA BOUNDARY
	PAVED AREAS
	DIRT ROADS
	DITCH
	SPILL
	FENCE
	20 FT CONTOURS
	GRAVEL
	PROPOSED BERM



U07001 Rev.1
Classification: U Reviewer: K. Salazar Date: 08-JUL-2012

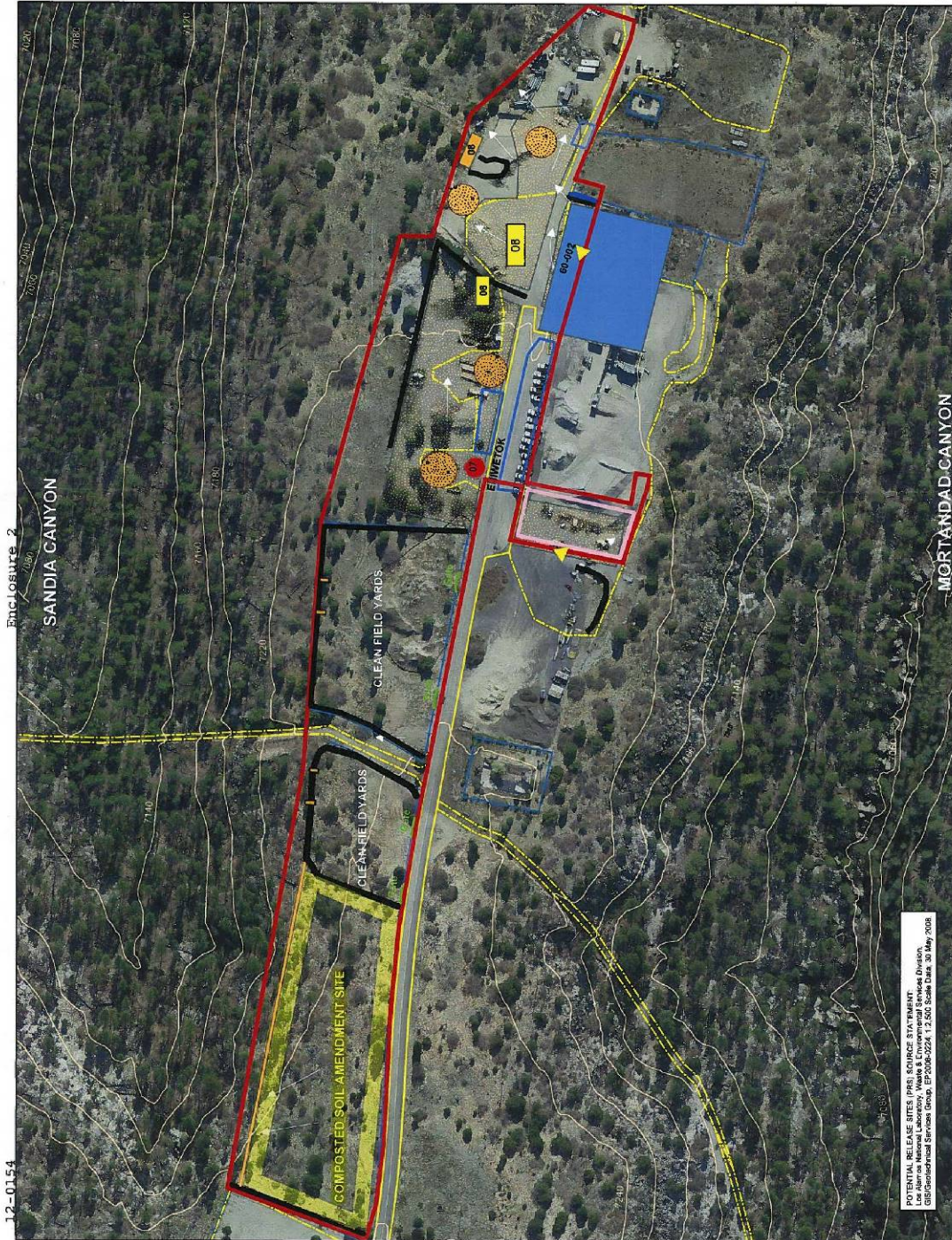

POTENTIAL RELEASE SITES (PRS) SOURCE STATEMENT
Los Alamos National Laboratory, Waste & Environmental Services Division
10000 Research Parkway, ES 508-9254, 12:50, Santa Fe, NM, July 2008

ENCLOSURE 3

Composting Facility Registration Form

ENV-RCRA-12-0154

LAUR-12-22609

Date: **JUL 3 1 2012**

12-0154

Enclosure 3

LAUR-12-22609

Composting Facility Registration Form (modified version of NMED form)

Notice to Registrant: The New Mexico Solid Waste Rules (SWR), 20.9.3.27 NMAC, requires the registration of a composting facility with the New Mexico Environment Department. A composting facility means a facility, other than a transformation facility, that is capable of providing biological stabilization of organic material. The owner or operator of a composting facility must apply for a registration at least 30 days prior to any operations and every five years thereafter. Existing composting facilities shall apply for a registration at least 30 days prior to the expiration of their existing permit or registration, or within two years after the effective date of these regulations (August 2, 2007), whichever occurs first. A composting facility that fails to file a timely and complete application for registration is deemed an unpermitted solid waste facility, subjecting the owner or operator to penalties, permit requirements and nuisance abatement orders. Composting facilities required to register shall accept only source separated compostable materials. If a composting facility has or plans to increase its operational rate to more than 25 tons per day annual average, it must additionally comply with SWR 20.9.3.28 NMAC.

This form is provided to assist you in completing the registration process. Return the completed form with all attachments to: c/o Manager, Permit Section, Solid Waste Bureau, New Mexico Environment Department, 1190 St. Francis Drive, P.O. Box 5469, Santa Fe, New Mexico 87502-5469.

I. General Information

Facility Name: Sanitary Waste Water System (SWWS) – Composting Operation

Facility Owner: Los Alamos National Security (LANS)/Department of Energy (DOE)

Mailing Address: P.O. Box 1663 Mail Stop: K476, Los Alamos, New Mexico 87545

Telephone: (505) 665-3959 Contact Person: Robert M. Ortiz, Operations Manager

Facility Operator: Los Alamos National Security (LANS)/Department of Energy (DOE)

Mailing Address: Same as above

Telephone: 505.665. 3959 Contact Person Robert M. Ortiz, Operations Manager

Physical Address of Facility Address: Los Alamos National Laboratory, Technical Area 46 (TA-46) Building 333 – See Enclosure 2(enclosure 4)

Legal Description of Property: 35° 51' 08" N 106° 16' 29W

Land Use and Zoning of Facility: Federal Facility - TA-46 is a restricted area. Public access is allowed only under approved personnel escort. See Enclosure 2(enclosure 4)

12-0154

Enclosure 3

LAUR-12-22609

II. **Facility Layout**

Attach a map of the facility location indicating the land use and zoning of the surrounding area, parcel size, setbacks, and locations of all water courses or wetlands within 200' of the facility.

Attach a Site Map of the Facility Identifying:

- Name and location of facility and North arrow for direction
- Locate any adjacent roads or highways
- Facility boundary and dimensions, fencing, gates, entrances and exits
- All compost storage, loading, and unloading areas
- Traffic flow pattern
- Location of all buildings, structures and utilities – including overhead electrical lines

Enclosure 2: indicates the location of all Technical areas at Los Alamos National Laboratory with respect to the Los Alamos town site, San Ildefonso Pueblo, White Rock town site, Bandelier National Monument, the Santa Fe National Forest, Santa Fe and Los Alamos Counties. The composting operation will be located at the SWWS facility at TA-46. Enclosure 2 includes the main roads and highways. The site is accessed through an adjacent roadway off the Parjarito corridor.

Enclosure 3: view includes the roads into, and within the facility. Public access to the facility is not allowed. TA-46 is a restricted area.

Enclosure 4: includes a detailed view of the SWWS facilities, including the facility entrance (exit same), treatment facilities, compost storage area. The view also contains the location of the ephemeral water course, Canada del Buey.

Enclosure 5: indicates route and direction of sludge drying beds return water system.

Enclosure 6: schematic provides an overview of a treatment process and return water flows.

Enclosure 7: NOI to NMED GWQB.

Enclosure 8: TA-60 Roads and Grounds Facility Multi-Sector SWPPP Map and Composted Soil Amendment Application Site.

III. **Operations**

Anticipated Start-Up Date (for new facilities): September 1, 2012

Days/Hours of Operation: M-F; 7:30 to 4:30

On-Site Equipment and Storage Containers

12-0154

Enclosure 3

LAUR-12-22609

Type: <u>Large Dump Truck</u>	Number: <u>1</u>	Size: <u>6-10yd3</u>
Type: <u>Bobcat Loaders</u>	Number: <u>1</u>	Size: <u>1/2</u>
Type: <u>Temperature Probes</u>	Number: <u>3</u>	Size: <u>36"-48"</u>
Type: _____	Number: _____	Size: _____

Compostable Stream:

- a. Origin and Market (Indicate company name, country, state, county and/or municipality):

Biosolids are generated on-site and will serve as the principal raw compost material. A number of bulking agent source streams have been identified. These include: 1) wood chips and green materials from Laboratory sites generated from activities of the Laboratory's Road and Grounds organization; 2) wood chips from Los Alamos County; 3) wood chips from local lumber mills; and 4) shredded paper from the Laboratory's Materials Recycling Facility(MRF).

The final composted soil amendment will be land applied on Laboratory property at the TA-60 Sigma Mesa Staging Area. The Staging Area is subject to the conditions of the TA-60 Roads and Ground Facility Multi-Sector General Permit (MSGP) - #NMR05GB21 - Storm Water Pollution Prevention Plan (SWPPP). An amendment to the SWPPP will include the addition of a 2.5-acre site consisting of shrub oak and dense grass land vegetation. The site is ideally suited for land application for beneficial use of exceptional quality compost (see enclosure # 8)(enclosure #2). The soil amendment will be applied to a 3" thickness. Located on a mesa top, the topography is generally flat and includes a number of natural swales. Depth to ground water is >1000 ft. The receiving water is Sandia Canyon. In addition to the natural controls, berms will be constructed to ensure soil amendment is not transported to water courses. Coverage of this site under the SWPPP ensures that a documented, implementable process is in place to reduce the possibility that soil amendment will reach a water course. The soil amendment application site will be subject to periodic inspections and corrective actions as specified in the SWPPP.

- b. Type/Composition (e.g., manure, food waste, mulch, ect.):

In 2011 the SWWS Facility generated approximately 30 yds³ of Biosolids. Biosolids will serve as the principal raw compost material. Wood chips will serve as the primary bulking agent.

- c. Operational Rate (Estimated volume of compostables to be accepted by the facility each day):

In 2011 the SWWS facility generated approximately 30 yds³ of sludge. The Facility will request bulking materials as needed on a monthly basis. At an approximate production rate of 30 yds³ per year, potentially 6-10 yd³ of bulking material will be utilized each month.

12-0154

Enclsure 3

LAUR-12-22609

- d. Solid Waste Component (Per 20.9.3.29 NMAC), provide plan for disposal of solid wastes that are unavoidably collected):

Only source separated bulking materials will be accepted at the Facility. Solid waste discovered in the source separated bulking materials will be collected daily and placed in receptacles and routed to the local transfer station as is the current practice. Biosolids which are not composted are place in 14ft³ leak proof and covered roll-off bins and landfilled as is the current practiced. Compost not meeting part 503 Class A – high quality will be taken to a landfill permitted to receive special waste.

OPERATIONS PLAN:

Attach an Operations Plan describing procedures for compostables acceptance, storage, processing and removal. The plan shall address the following items:

- Use of signs indicating location of the site, hours of operation, emergency telephone numbers, delivery instructions and to state that fires and scavenging are prohibited
- Means of controlling access to the facility (through use of fencing, gates, locks or other means)
- Use of leak-proof and non-biodegradable storage containers
- Means to control litter and prevent and extinguish fires
- Sufficient unloading areas to meet peak demands
- Means of controlling and mitigating noise and odors
- Conduct of safe and sanitary composting operations
- Frequency of solid waste removal, which shall be by the end of the operating day, unless otherwise approved in the registration
- For composting facilities that accept sewage sludge, provide a plan showing testing methods and procedures for compliance with 40 CFR 503 and 20.6.2 NMAC
- If applicable, demonstrate that a groundwater discharge permit has been applied for. ; go to http://www.nmenv.state.nm.us/gwb/forms/documents/Notice_of_Intent.doc for Notice of Intent, complete and submit to Ground Water Quality Bureau.
- Describe the process, loading rate, proposed capacity, size and operational rate, and the expected disposition rate of the compost from the facility
- Procedures to be taken if unauthorized waste is received
- Procedures in response to emergency situations and equipment break down to ensure that stored materials and compost will be removed in a timely manner to avoid nuisances or hazards
- Record keeping requirements
 - Submit an annual report to the Department within 45 days from the end of each calendar year, per Subsection J of 20.9.3.27 NMAC to include:
 1. the type and weight or volume of recyclable material received during the year;
 2. the type and weight or volume of recyclable material sold or otherwise disposed off site during the year;
 3. final disposition of material sold or otherwise disposed off-site; and
 4. any other information as requested by the Secretary.
- Facility personnel requirements and duties
 - Have a certified operator or representative present at all times while the facility is being operated

12-0154

Enclosure 3

LAUR-12-22609

- Personnel training requirements (safety, operations, etc.)
- Update the registration if there are any significant changes in operation or of ownership
- Any additional information requested by the Secretary

Operations Plan

The SWWS Composting Facility is located at Los Alamos National Laboratory in Technical Area 46 (TA-46). The Facility is isolated from other LANL facilities. Technical Area 46 is a restricted area and public access to the SWWS Facility is controlled. The Facility can be accessed by the public, but only through an approved escort. The Facility is enclosed within a fenced area. The main gate serves as the entrance and exit into the Facility and is equipped with a locking gate. Signs are posted at the entrance to the Facility which provides warnings and instructions.

Sludge from the clarifiers (wasting) is directed to the sand sludge drying beds for dewatering. The sludge beds are equipped with an under drain system which returns water to the head works of the SWWS Plant (See Enclosure 5) (enclosure 7). Composting will take place on two of the sludge drying beds (see Enclosure 4) (enclosure 6).

Only source separated bulking materials will be accepted at the Facility. The rate at which bulking materials are to be brought onsite will correspond to the rate at which biosolids are made ready for composting. This is estimated to be 6-10 yds³ per month. Consequently, limited area is needed for bulking material storage (see Enclosure 4) (enclosure 6). Very little solid waste will be generated from the source separated bulking materials. Any solid waste generated will be collected daily and placed in receptacles and routed to the local transfer station as is the current practice. In conjunction with this registration and pursuant to 20.9.3 and 20.6.2 a notice of intent has been filed with NMED's Ground Water Quality Bureau. A copy of the NOI to the Groundwater Bureau is attached (See Enclosure 7) (enclosure 1).

In 2011 sludge production at Facility was approximately 30 yds³. At this biosolids production rate, the Facility will request bulking materials as needed and estimates the need for 6-10 yd³ of bulking materials per month. Sludge from the applied bed will be re-located to the composting bed. The Facility will use the static aerated pile composting method. The procedures on formation of a static pile are well documented and SWWS Operators have successfully completed NMED's Compost Certification Course. SWWS biosolids will be mixed with appropriate bulking materials at an anticipated ratio of 40% biosolids to 60% bulking material by volume. This ratio / mix may vary in order to meet the proper C:N ratio based on the composition of bulking material. Once mixed, the material will be piled over a bed of approximately 10 – 12" of wood shavings. The pile height will not exceed 5'. Another 10" of wood chips will be placed above the mix to provide added levels of odor and vector controls. Compost operations conducted over the drying beds will provide a closed system for liquids and further facilitate a safe and sanitary operation. The SWWS's *Operation and Maintenance Manual* includes a number of procedures on how odors are controlled for the Facility.

12-0154

Enclosure 3

LAUR-12-22609

To record pathogen and vector attraction reduction, temperatures and moisture content will be monitored and logged twice per day. Once the 15 day active stage is completed, the compost will be cured for 30-45 days. Once the product is cured (pile ambient temperatures reached), and before land application, sampling and analysis pursuant to Part 503 (and specified below) will be conducted. An estimated 150 yds³ of composted soil amendment will be generated annually.

The final composted soil amendment will be land applied at the TA-60 Sigma Mesa Staging Area. The Staging Area is subject to the conditions of the TA-60 Roads and Ground Facility NPDES Multi-Sector General Permit (MSGP) - Storm Water Pollution Prevention Plan (SWPPP).

Compliance with 40 CFR 503 will be achieved as follows:

The SWWS Facility will use the Static Aerated Pile composting method to produce an "exceptional quality" (EQ) biosolid or Composted Soil Amendment. Only EQ biosolids will be land applied at LANL. EQ biosolids meet the Part 503 pollutant concentration limits (Table 3 of Section 503.13) as well as Class A pathogen reduction requirements and one of the first eight vector attraction reduction options listed in 503.33(b)(1) through (b)(8). At anticipated rates of production, the monitoring frequency for metals and fecal coliform will be no more than once per quarter. Specified monitoring rates are established in Table 1 of §503.16. Monitoring will take place prior to land application. Monitoring for fecal coliform bacteria will be conducted close to the time of final use.

Table 1 of §503.16—Frequency of Monitoring—Land Application

Amount of sewage sludge ¹ (metric tons per 365 day period)	Frequency
Greater than zero but less than 290	Once per year.
Equal to or greater than 290 but less than 1,500	Once per quarter (four times per year).

¹Either the amount of bulk sewage sludge applied to the land or the amount of sewage sludge prepared for sale or give-away in a bag or other container for application to the land (dry weight basis).

Monitoring Considerations for Class A - High Quality Compost

Parameter	Frequency ¹	Sample Type and Amount	When ⁴	Sample Location	Methods
Metals ²	Annually or Quarterly	Composite ³ (7 grab samples)	Before ⁴ Use or Land Application	On-Site at varying depths and locations within pile	SW-846
Fecal Coliform	Annually or Quarterly	7 individual grab samples over a 14 day period ³	Before ⁴ Use or Land Application	On-site at varying depths and locations within pile	SM-9221 E (MPN) SM-9222 D (membrane filter)

1. §503.16—Frequency of Monitoring—Land Application
2. §503.13 – Table 1 and Table 3
3. No fixed number – Guidance
4. Close to the time of use or disposal

12-0154

Enclosure 3

LAUR-12-22609

To ensure Class A Pathogen Reduction in the aerated static pile composting processes, temperatures will be taken at multiple points at a range of depths throughout the composting medium. Pathogen reduction will take place at the same time as vector attraction reduction. The temperature of the sewage sludge must be maintained at 55°C or higher for three (3) consecutive days. The following information will be recorded and documented: description of the composting method, the date and times temperatures maintained above 55°C and 2 temperature readings at least 7 hours apart.

Description of Compost Method	Date / Time	Temperature °C	Temperature °C	Sampler
		Time #1	Time #2	

Vector Attraction Reduction Option 5 will be used. This option requires aerobic treatment (e.g. composting) of the sewage sludge for at least 14 consecutive days at over 40°C (104°F) with an average temperature of over 45°C (113°F). The following information will be recorded and documented: description of the composting method, the date and times temperatures maintained above 40°C - 45°C, documenting average temperatures and 2 temperature readings at least 7 hours apart.

Description of Treatment Process	Date / Time	Temperature °C	Temperature °C	Sampler
		Time #1	Time #2	

The SWWS Facility maintains an emergency protocol for each of its major processes. The protocol is outlined in the *Wastewater Treatment Facility Operation Manual*. By procedure, a logical sequence of steps are to be followed by the operator on duty in responding to emergencies: identifying the emergency, investigating its extent, deciding on proper initial course of action, taking corrective action to rectify the situation, and following up with a post-emergency investigation.

To prepare for the annual report required by 20.9.3.27, the following information will be maintained and recorded:

- Amount of source separated bulking material brought on-site
- Amount of biosolids generated and used in the composting process
- Final disposition of compost material

The report will be submitted to NMED Solid Waste Bureau within 45 days of the end of the calendar year.

The SWWS Facility currently has 3 operators certified per 20.9.7. A certified operator will be on-site during hours of composting operations. SWWS operators are subject to an extensive training plan that requires instruction in operations and safety and, in part, includes the following course work, hands on training and certifications:

- Maintenance Worker
- Fork lift operator
- Incidental crane operator
- Sanitary Waste Water System
- Chemical Hazard Communication
- Corrosives Hazard Training

12-0154

Enclosure 3

LAUR-12-22609

- Electric Safety Basics
- Excavation Fill Soil Disturbance
- Fork Lift Operator
- Incidental Crane Operator
- NM State Waste Water Certification
- NM State Compost Certification
- Radiological Worker II Training
- Lockout/Tagout Authorized Worker
- Air Monitoring for Confined Spaces
- Fall Protection
- First Aid

20.9.3.28 ADDITIONAL REGISTRATION REQUIREMENTS FOR COMPOSTING FACILITIES THAT ACCEPT GREATER THAN 25 TONS PER DAY COMPOSTABLE MATERIAL OR GREATER THAN 5 TONS PER DAY OF MATERIAL THAT WOULD OTHERWISE BECOME SPECIAL WASTE.

Not Applicable

IV. ACKNOWLEDGEMENTS

- A. I AM AWARE THAT THE OWNER OR OPERATOR IS REQUIRED TO COMPLY WITH ALL OF THE TERMS OF THE APPROVED REGISTRATION AME INITIALS
- B. I AM AWARE THAT THE OWNER OR OPERATOR MUST UPDATE THIS REGISTRATION TO REFLECT ANY MATERIAL CHANGES IN OPERATIONS (PRIOR TO IMPLEMENTING SUCH CHANGES)
AME INITIALS

The undersigned attests the information provided is true and accurate.

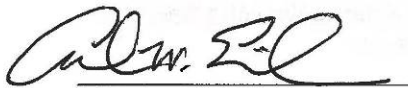

Signature and Title

7/26/12
Date

(505) 667-4222
Telephone

Facility Operations Director, UI

ENCLOSURE 4

Location of Sanitary Waste Water System (SWWS) at TA-46

ENV-RCRA-12-0154

LAUR-12-22609

JUL 3 1 2012

Date: _____

LAUR-12-22609

Technical Areas

- TA-00 OFF SITE
- TA-02 OMEGA SITE
- TA-03 SOUTH MESA SITE
- TA-05 BETA SITE
- TA-06 TWO MILE MESA SOUTH SITE
- TA-08 ANCHOR WEST SITE
- TA-09 ANCHOR EAST SITE
- TA-11 K SITE
- TA-14 O SITE
- TA-15 R SITE
- TA-16 S SITE
- TA-18 PALARITO LABORATORY
- TA-21 DP SITE
- TA-22 TD SITE
- TA-25 MAGAZINE AREA
- TA-33 HP SITE
- TA-35 TEN SITE
- TA-36 KAPPA SITE
- TA-37 MAGAZINE AREA C
- TA-39 ANCHO CANYON SITE
- TA-40 DF SITE
- TA-41 W SITE
- TA-43 HEALTH RESEARCH LABORATORY
- TA-46 HA SITE
- TA-48 RADIOCHEMISTRY SITE
- TA-49 FRIELES MESA SITE
- TA-50 WASTE MANAGEMENT SITE
- TA-51 ENVIRONMENTAL RESEARCH SITE
- TA-52 REACTOR DEVELOPMENT SITE
- TA-53 LOS ALAMOS NEUTRON SCIENCE CENTER
- TA-54 WASTE DISPOSAL SITE
- TA-55 PLUTONIUM FACILITY SITE
- TA-57 FENTON HILL
- TA-58 TWO MILE MESA NORTH SITE
- TA-59 OH SITE
- TA-60 SIGMA MESA SITE
- TA-61 EAST JEMEZ SITE
- TA-62 NORTHWEST SITE
- TA-63 PALARITO SERVICE SITE
- TA-64 CENTRAL GUARD SITE
- TA-66 CENTRAL TECHNICAL SUPPORT SITE
- TA-67 PALARITO MESA SITE
- TA-68 WATER CANYON SITE
- TA-69 ANCHOR NORTH SITE
- TA-70 RIO GRANDE SITE
- TA-71 SOUTHEAST SITE
- TA-72 EAST ENTRY SITE
- TA-73 AIRPORT SITE
- TA-74 OTOMI SITE

Enclosure 4

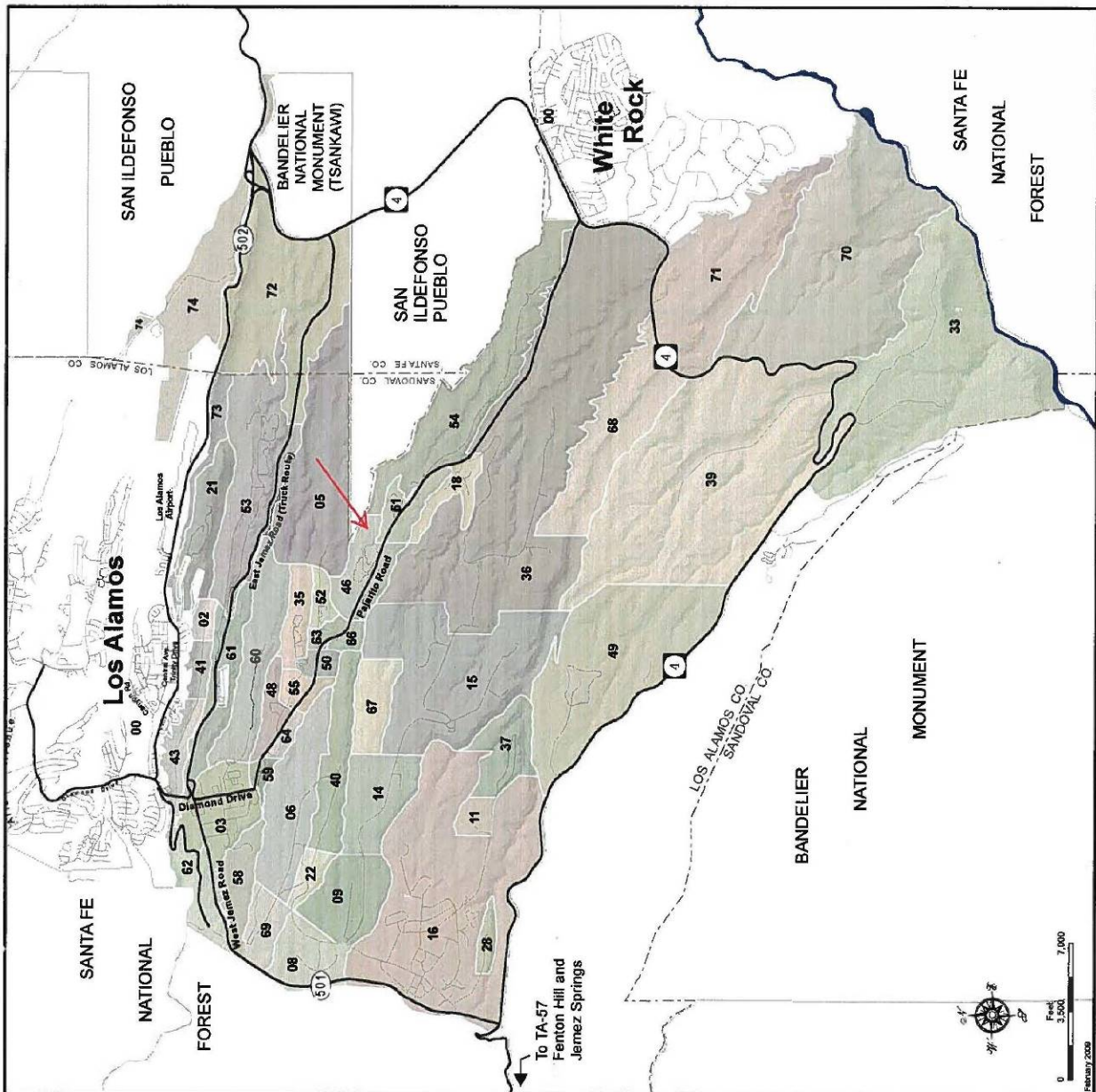

12-0154

ENCLOSURE 5

Sanitary Waste Water Facility (addition view)

ENV-RCRA-12-0154

LAUR-12-22609

JUL 3 1 2012

Date: _____

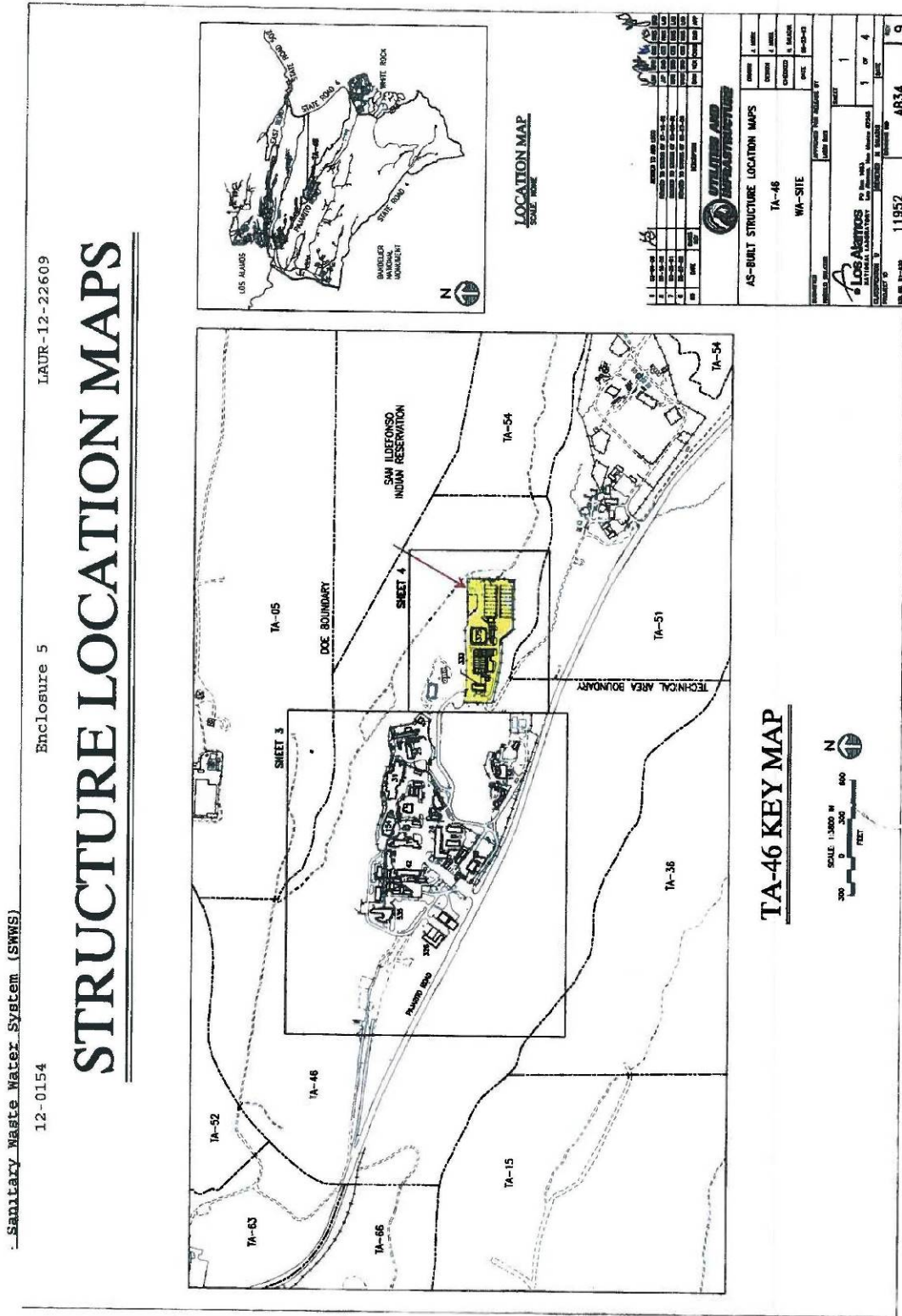

ENCLOSURE 6

SWWS Facility Site Plan (traffic flow, electric transmission and storm
water flows)

ENV-RCRA-12-0154

LAUR-12-22609

JUL 3 1 2012

Date: _____

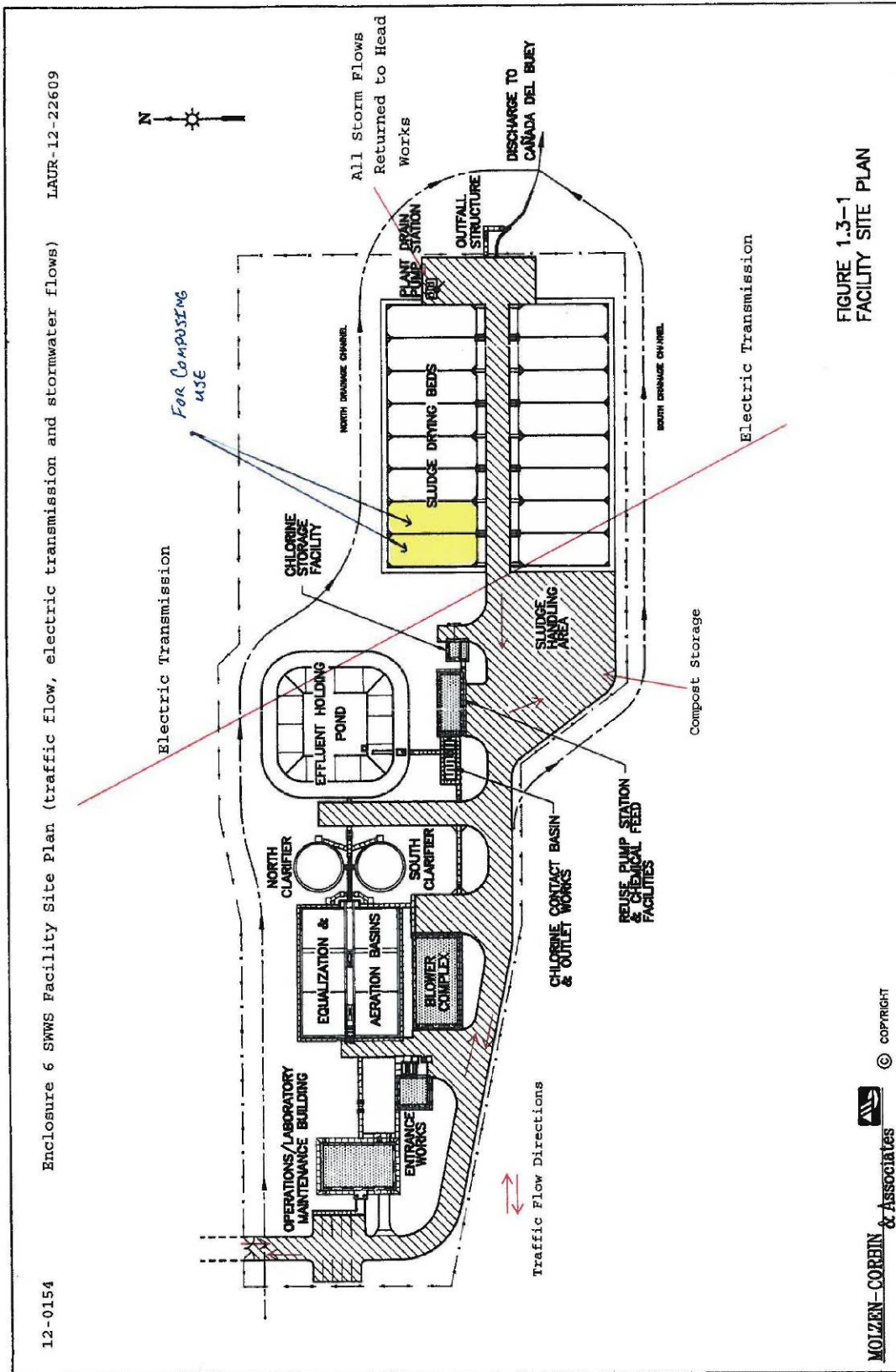

FIGURE 1.3-1
FACILITY SITE PLAN

ENCLOSURE 7

SWWS Sludge Drying Bed Return Water Flows

ENV-RCRA-12-0154

LAUR-12-22609

JUL 3 1 2012

Date: _____

LAUR 12-22609

Enclosure 7

12-0154

SWS Sludge Drying Beds Return Water System

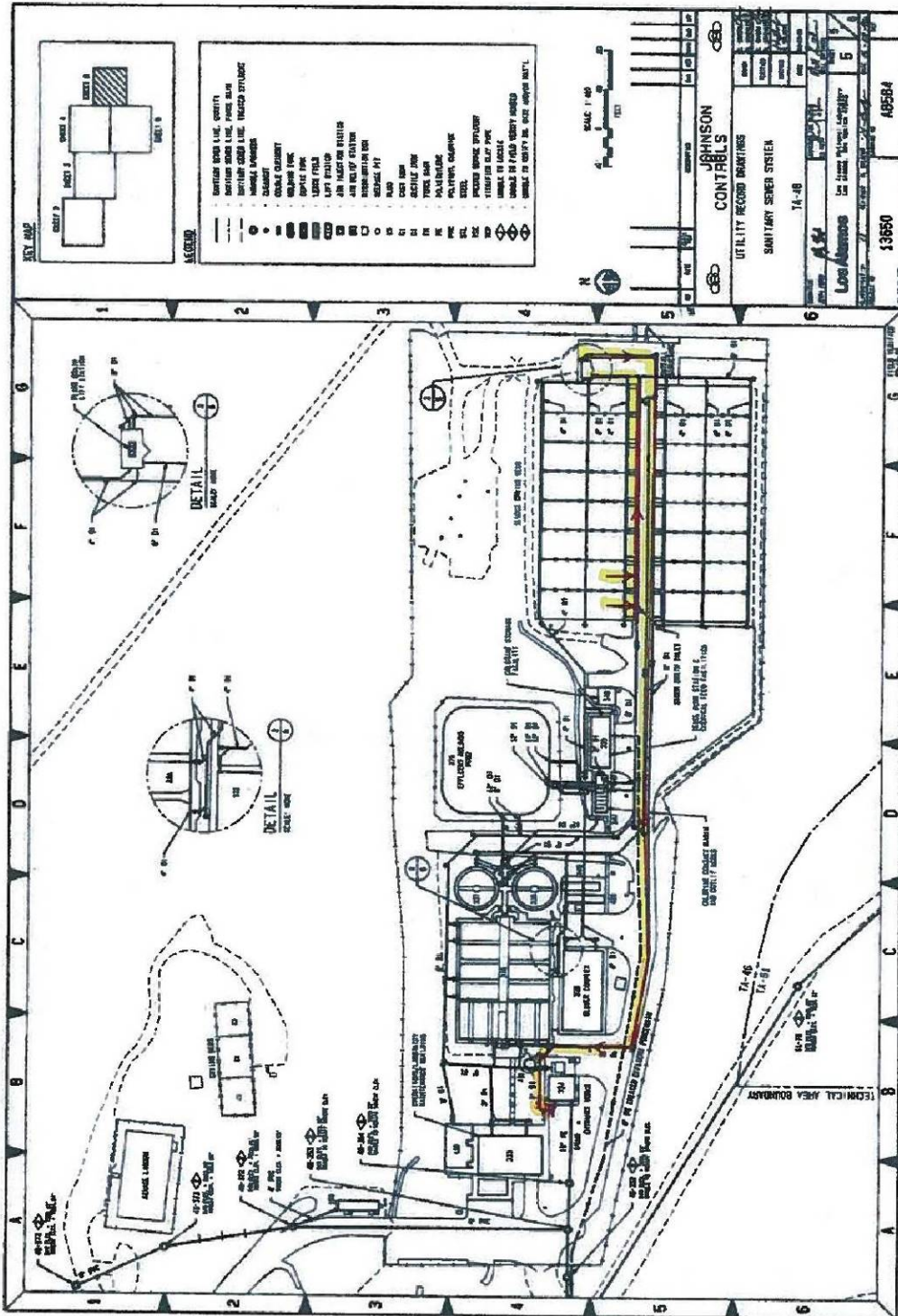

ENCLOSURE 8

SWWS Process Schematic

ENV-RCRA-12-0154

LAUR-12-22609

Date: **JUL 3 1 2012**

Process Schematic

ENCLOSURE 8

12-0154
LAUR 12 22609

SANITARY WASTEWATER SYSTEMS (SWWS) PLANT
TA-46 BUILDING 333 (ADMIN./CONTROL ROOM/LAB)
OUTFALL #13S

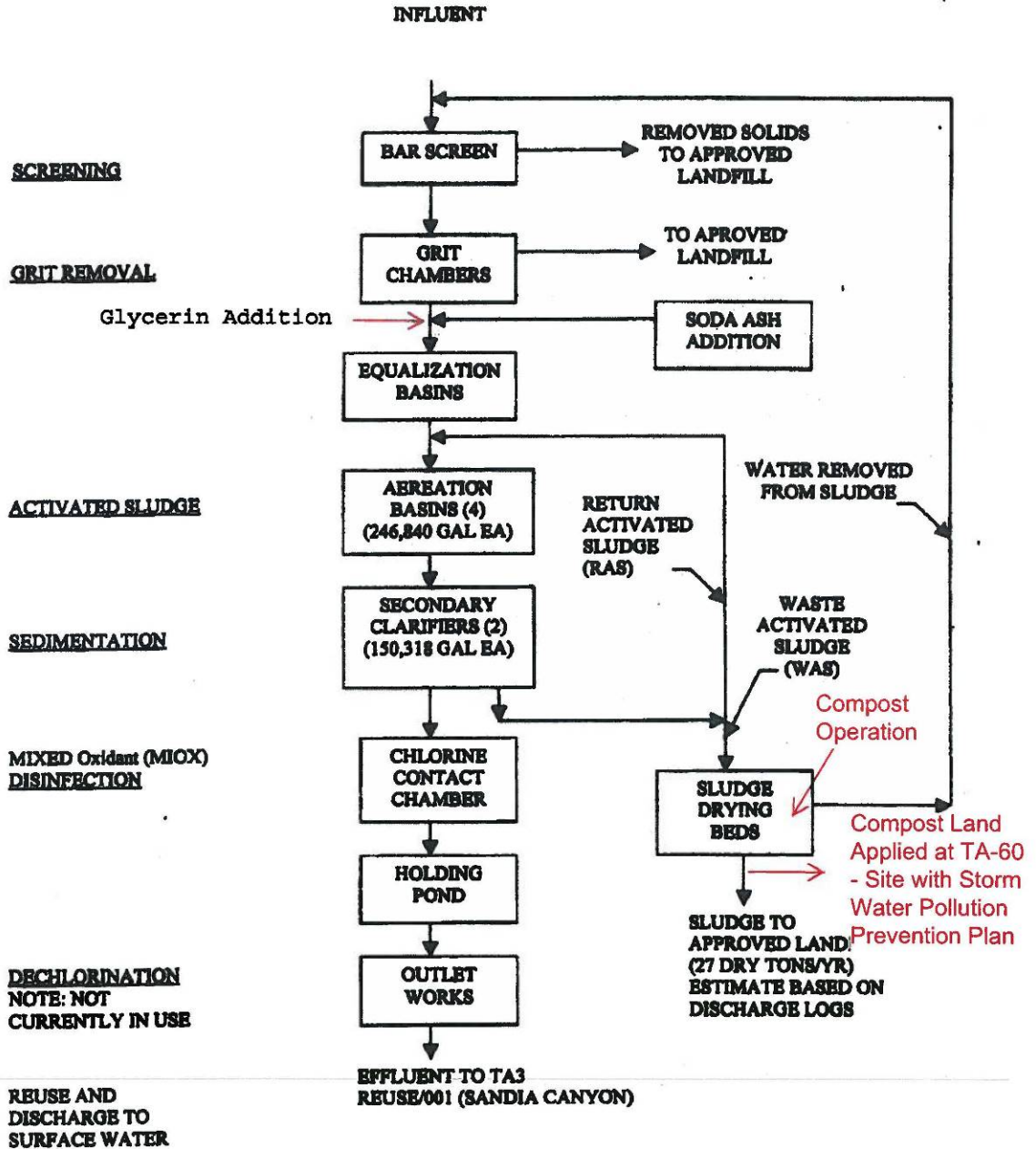



Signature/Review/Coordination Sheet

This form is to accompany all documents requiring review, approval, or signature by the Laboratory Director or Designee.

Date July 25, 2012	Deadline Program Driven	Is this a response to an action item? Yes <input type="checkbox"/> No <input checked="" type="checkbox"/>
From: ENV-RCRA Name: Robert M. Gallegos MS: K490		<input checked="" type="checkbox"/> Call for Pick-up Name: Linda M. Salazar Phone: 7-7407

Title: Identify document, briefly describing subject matter.
ENV-RCRA-12-0154 Notice of Intent of Planned Change in Sewage Sludge Disposal Practice at the Los Alamos National Laboratory's Sanitary Waste Water System Facility

Action Information Only

Background/Issues:
The Laboratory is to begin composting biosolids at the Sanitary Waste Water System (SWWS) Facility. The New Mexico Solid Waste Management Rules (20.9) require the facility be registered prior to operation. The Solid Waste Rule also requires a Notice of Intent to Discharge (NOI) be filed with the NMED's Groundwater Quality Bureau. This is the NOI portion of the Registration process.

Routine Report.

The date is left blank on this correspondence pending routing approval and will be stamped before release

ACTION requested of Laboratory Director or Designee:
Review and Endorse

PAD Endorsement

Name (print)	Signature	Date
Carl A. Beard	na	

AD Endorsement

Name (print)	Signature	Date
Michael T. Brandt	na	

Coordinated with

1. Name (print)	Signature	Date
Alison M. Dorries		7/31/12
2. Name (print)	Signature	Date
Anthony R. Grieggs		7/25/12
3. Name (print)	Signature	Date
Michael T. Saladen		7/25/12
4. Name (print)	Signature	Date
Marc A. Bailey		7/25/12
5. Name (print)	Signature	Date
Robert M. Gallegos		7/25/12

Please ensure appropriate inter/intra Directorate/Divisional coordination and review prior to submittal to the Director's Office.
Form 1824 (1/07)

ENV-RCRA-12-0154

Laur-12-22609

1824 Coordination sheet (continued)

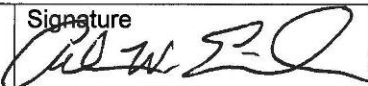
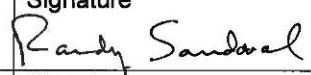
Name (<i>print</i>)	Signature	Date
Andrew W. Erickson		7/26/12
Randy J. Sandoval		7/26/12
Name (<i>print</i>)	Signature	Date
Name (<i>print</i>)	Signature	Date
Name (<i>print</i>)	Signature	Date
Name (<i>print</i>)	Signature	Date



*Environmental Protection Division
Environmental Compliance Programs (ENV-CP)
PO Box 1663, K490
Los Alamos, New Mexico 87545
(505) 667-0666*

*National Nuclear Security Administration
Los Alamos Field Office, A316
3747 West Jemez Road
Los Alamos, New Mexico, 87545
(505) 667-5794/Fax (505) 667-5948*

Date: **AUG 27 2014**
Symbol: ENV-DO-14-0233
LAUR: 14-26554

Locates Action No.: N/A

Ms. Gladys Gooden-Jackson
U.S. Environmental Protection Agency, Region 6
Compliance Assurance and Enforcement Division
Water Enforcement Branch (6EN)
1445 Ross Avenue, Suite 1200
Dallas, TX 75202-2733

Dear Ms. Gooden-Jackson:

Subject: NPDES Permit No. NM0028355, Notice of Changed Condition, Supplemental NPDES Reapplication Information For Outfall 13S

In February 2012 the U.S. Department of Energy and Los Alamos National Security, LLC (DOE/LANS) submitted the Reapplication for NPDES Permit No. NM0028355. Table 4 on Page 3 of 13 of the Fact Sheet for Outfall 13S (Sanitary Wastewater Systems Plant- [SWWS]), did not identify a potential contaminant of concern (High Explosive- [HE]) associated with showers and sinks located in buildings or areas adjacent to HE processing facilities. These showers and sinks are used by personnel to wash off after they have doffed their personnel protective equipment (PPE) clothing and by custodial personnel when mopping these areas. Approximately 50 – 100 gallons per day of soap and wash water are discharged into the sanitary collection system and potentially contains de minimis quantities of HE (predominantly HMX and/or RDX). Facility personnel take precautions to reduce/eliminate HE cross contamination before showering or washing their hands. Monitoring for HE has been initiated at Outfalls 13S and 001 and in the sanitary collection system in the areas that handle high explosives to evaluate if HE is present in detectable amounts.

Additionally, the basement at TA-36 Building 86 (Pulse Intense X-ray-[PIXY]) was flooded by storm water runoff during rain events in September 2013 and July 2014. Storm water runoff was captured by the facility's sump. Analyses of the captured storm water indicated the presence of oil & grease (2.4 mg/L), Uranium (8.74 mg/L), Uranium-234 (0.389 pi/L, Uranium-238 (3.74 pCi/L), and HMX (0.601 ug/L). The facility has requested the contaminated storm water be disposed at the SWWS Plant until the facility has completed corrective actions to address the flooding (i.e., cleaning and sealing of the basement floor and

Ms. Gladys Gooden-Jackson
ENV-DO-14-0233

- 2 -

correct drainage problems). The SWWS Plant may accept, on a case-by-case basis, waste streams that do not meet the facility's Waste Acceptance Criteria (WAC) if best management practices or other measures are implemented to reduce any potential impacts to the treatment facility and effluent quality.

An updated Table 4 is included as Enclosure 1 to identify these waste streams. Please include this information in the administrative record for the NPDES Permit Reapplication.

Please contact Marc Bailey at (505) 665-8135 of the Laboratory's Environmental Compliance Programs (ENV-CP) or Mike Saladen (505) 665-6085, ENV-CP, if you have questions or need additional information.

Sincerely,

Anthony R. Grieggs
Group Leader
Environmental Compliance Programs (ENV-CP)
Los Alamos National Security, LLC

Sincerely,

Gene E. Turner
Environmental Permitting Manager
Environmental Projects Office
Los Alamos Field Office
U.S. Department of Energy

ARG:GET:MAB/ms

Enclosure: Updated Table 4, Outfall 13S Fact Sheet, 2012 NPDES Permit Reapplication

Cy: Isaac Chen, U.S. EPA Region 6, Dallas, TX, (E-File)
Bruce Yurdin, NMED/SWQB, Santa Fe, NM, (E-File)
James Hogan, NMED/SWQB, Santa Fe, NM, (E-File)
Erin Trujillo, NMED/SWQB, Santa Fe, NM, (E-File)
Jerry Schoeppner, NMED/GWQB, Santa Fe, NM, (E-File)
Thomas Skibitski, NMED/DOE/OB, Albuquerque, NM, (E-File)
Steven M. Yanicak, NMED/DOE/OB, (E-File)
Courtney A. Perkins, NMED/DOE/OB, (E-File)
Steve Rydeen, San Ildefonso Pueblo, Santa Fe, NM, (E-File)
Gene E. Turner, NA-LA, (E-File)
Kirsten Laskey, NA-LA, (E-File)
Carl A. Beard, PADOPS, (E-File aosburn@lanl.gov)
Michael T. Brandt, ADESH, (E-File)
Racanna Sharp-Geiger, ADESH, (E-File)
Alison M. Dorries, ENV-DO, (E-File)
Andrew W. Erickson, UI-DO, (E-File)
Lawrence V. Chavez, UI-OPS, (E-File)
Michael T. Saladen, ENV-CP, (E-File)
Marc A. Bailey, ENV-CP, (E-File)
Robert S. Beers, ENV-CP, (E-File)

Cy (continued):

Robert M. Gallegos, ENV-CP, (E-File)

LASOmailbox@nnsa.doe.gov, (E-File)

locatsteam@lanl.gov, (E-File)

env-correspondence@lanl.gov, (E-File)

2012 NPDES Permit Re-Application
Outfall 13S, SWWS
LAUR-14-26554
UPDATE August 19, 2014

Updated Table 4 identifies the contaminants listed on the WPFs for the influent received by the SWWS Plant for treatment.

Table 4
Potential Contaminants Associated with SWWS Influent

Waste Stream Type	Description	Hazardous Substances from Form 2C, Table 2C-4 Identified on WPFs	
Process	Wastewater discharged to the sanitary sewer from non-radiological laboratories, process equipment, and areas.	Acetic acid Ammonium chloride Chlorine Copper chloride Cupric sulfite Ferric sulfate	Ferrous sulfate Nitric acid Potassium hydroxide Sodium hydroxide Sodium nitrite Zinc sulfate
ER	Water generated due to groundwater monitoring well drilling and sampling activities.	Ammonia Benzene Chlordane Chlorine Dichlorobenzene[1,3] Dieldrin	Endosulfan Endrin Ethylbenzene Heptachlor Toluene Xylene
Cooling	Blow Down from Cooling Towers and Systems	Ammonia Chlorine Cupric sulfate Maleic acid Phosphoric acid	Potassium hydroxide Sodium bisulfite Sodium hydroxide Sodium nitrite Sulfuric acid
Sanitary	Wastewater from septic tanks at remote locations.	Chlorine Toluene	Xylene
Waste Stream Type	Description	Other Substances Not on Table 2C-4	
Sanitary	Wastewater from septic tanks at remote locations and wash facilities within the High Explosives complex.	Deminius Quantities of High Explosives (predominantly RDX, HMX)	
Storm Water	Contaminated Storm Water	Deminius Quantities of High Explosives (predominantly RDX, HMX)	

ED441352436US



Form 1824

Signature/Review/Coordination Sheet

This form is to accompany all documents requiring review, approval, or signature by the Laboratory Director or Designee.

Today's Date 08/19/14	Deadline Date 8-20-14	Is this a response to an action item? Yes <input type="checkbox"/> No <input checked="" type="checkbox"/>
From: Marc Bailey Organization: ENV-CP	<input type="checkbox"/> Call for Pick-up Name: Barbara Bushong Phone: 7-4218	

Title: Identify document, briefly describing subject matter.
ENV-DO-14-027; NPDES Permit No. NM0028355, Notice of Changed Condition, Supplemental NPDES Reapplication Information For Outfall 13S

Summary/Detail

NPDES Permit No. NM0028355 requires the permittees to notify the U. S. Environmental Protection Agency (EPA) regarding any physical alterations or additions to the permitted facility that could significantly change the nature or increase the quantity of pollutants discharged (see Part III.D.1.a. Reporting Requirements). The purpose of this letter is to notify EPA of contaminants of concern (de minimis HE) that could be discharged to the SWWS collection system or accepted on a cases by case basis for treatment at SWWS, that was not previously identified in the 2012 MPDES Permit Reapplication.

The date is left blank on this correspondence pending routing approval and will be stamped before release.

ACTION requested of Laboratory Director or Designee:
Review and endorse.

PAD Endorsement

Name (print)	Signature	Date
Carl A. Beard, PADOPS	na	

AD Endorsement

Name (print)	Signature	Date
Michael T. Brandt, ADESH	na	

Coordinated with

1. Name (print)	Signature	Date
Alison M. Dorries, ENV-DO	<i>Alison Dorries</i>	8/26/14
2. Name (print)	Signature	Date
Anthony R. Grieggs, ENV-CP	<i>ARG</i>	8/25/14
3. Name (print)	Signature	Date
Michael T. Saladen, ENV-CP	<i>Michael Saladen</i>	8/22/14
4. Name (print)	Signature	Date
Marc A. Bailey, ENV-CP	<i>Marc Bailey</i>	8/22/14
5. Name (print)	Signature	Date

Please ensure appropriate PAD/AD/Division coordination and review prior to submittal to the Director's Office.
Form 1824 (8/12)



Environmental Protection Division

Environmental Compliance Programs (ENV-CP)
PO Box 1663, K490
Los Alamos, New Mexico 87545
(505) 667-0666

National Nuclear Security Administration

Los Alamos Field Office, A316
3747 West Jemez Road
Los Alamos, New Mexico, 87545
(505) 667-5794/FAX (505) 667-5948

Date: **OCT 24 2013**
Symbol: ENV-DO-13-0235
LAUR: 13-27719

Ms. Jan Walker
U.S. Environmental Protection Agency, Region 6
Compliance Assurance and Enforcement Division
Water Enforcement Branch (6EN)
1445 Ross Avenue, Suite 1200
Dallas, TX 75202-2733

Dear Ms. Walker:

Subject: NPDES Permit No. NM0028355, Notice of Planned Change, Outfall 03A027

The purpose of this correspondence is to provide a Notice of Planned Change at Outfall 03A027 in response to a new computing system scheduled for start-up in 2015 at the Strategic Computing Complex (SCC). This new system will result in added cooling requirements at the SCC and therefore, increased volume of discharge to Outfall 03A027. As part of the design package, the existing blow down line must be tested to determine if it will be sufficient to handle the added volume or if a new larger diameter line is required.

To validate calculated flow rates in the blow down piping from the SCC to Outfall 03A027, Facilities personnel will attach a three or four inch connection (including de-chlorinator and water meter) to a fire hydrant and run the fire hose to the first manhole in the blow down piping system. Personnel will be stationed at each of the downstream manholes in the blow down piping to observe and record water levels. As the flow rate is increased incrementally, data points will be recorded including flow rate, total gallons discharged, and manhole levels. Based on a nominal flow rate of 200 gpm over the course of 60-120 minutes (time to measure the levels in all the manholes), it is expected the test will result in a total volume discharged to Outfall 03A027, in the 12,000 – 24,000 gallons range. Potential erosion due to the elevated velocity in the vicinity of the outfall pipe will be mitigated by installation of a flow diverter on the end of the pipe. Compliance samples will be collected during the test to ensure the requirements of NPDES Permit No. NM0028355 are met.

Ms. Jan Walker
ENV-DO-13-0235

- 2 -

Please contact Marc A. Bailey at (505) 665-8135 or Michael T. Saladen at (505) 665-6085 of the Environmental Compliance Programs (ENV-CP) if you have questions.

Sincerely,

Anthony R. Grieggs
Group Leader
Environmental Compliance Programs (ENV-CP)
Los Alamos National Security, LLC

Sincerely,

Gene E. Turner
Environmental Permitting Manager
Environmental Projects Office
Los Alamos Field Office
Department of Energy

ARG:GET:MAB/lm

Cy: Bruce Yurdin, NMED/SWQB, Santa Fe, NM
James Hogan, NMED/SWQB, Santa Fe, NM, (E-File)
Erin Trujillo, NMED/SWQB, Santa Fe, NM, (E-File)
Jerry Schoepner, NMED/GWQB, Santa Fe, NM
Thomas Skibitski, NMED/DOE/OB, Albuquerque, NM
Courtney A. Perkins, NMED/DOE/OB, (E-File)
Steve Rydeen, San Ildefonso Pueblo, Santa Fe, NM
Gene E. Turner, NA-OO-LA, (E-File)
Eric L. Trujillo, NA-OO-LA, (E-File)
Carl A. Beard, PADOPS, (E-File)
Michael T. Brandt, ADESH, (E-File)
Alison M. Dorries, ENV-DO, (E-File)
Marc A. Bailey, ENV-CP, (E-File)
LASOmailbox@nnsa.doe.gov, (E-File)
locatsteam@lanl.gov, (E-File)
ENV-DO Correspondence File, K490



Environmental Protection Division
Environmental Compliance Programs
PO Box 1663, K490
Los Alamos, New Mexico 87545
(505) 667-0666

Date: **MAY 08 2018**
Symbol: EPC-DO: 18-199
LA-UR: 18-23841
Locates Action No.: N/A

Ms. Nancy Williams
U.S. Environmental Protection Agency, Region 6
Compliance Assurance and Enforcement Division
Water Enforcement Branch (6EN)
1445 Ross Avenue, Suite 1200
Dallas, Texas 75202-2733

Subject: National Pollutant Discharge Elimination System (NPDES) Permit No. NM0028355, Notice of Planned Change at NPDES Outfall 03A181

Dear Ms. Williams:

The National Pollutant Discharge Elimination System (NPDES) Permit No. NM0028355 for the National Nuclear Security Administration and Los Alamos National Security, LLC (NNSA/LANS) require the permittee(s) to notify the U. S. Environmental Protection Agency (EPA) regarding any physical alterations or additions to the permitted facility that could significantly change the nature or increase the quantity of pollutants discharged (see Part III.D.1.a. Reporting Requirements). The Facility Operations staff at Outfall 03A181 have added a de-chlorination system to the overflow line of the TA-55-0006 cooling tower system to ensure adequate de-chlorination before release to the outfall. As originally installed, the TA-55-0006 overflow line bypassed the de-chlorination process and discharged directly to the outfall. To address this inadequate design, the cooling towers have been operated in such a manner as to eliminate any possibility of the basins discharging to the overflow. This is not an optimal configuration for the system to operate necessitating the need to configure the overflow so that discharges through this line would be de-chlorinated to meet the NPDES Permit requirements. The system is configured as depicted in the attached drawing (Enclosure 1) and the Safety Data Sheet (SDS) for the de-chlorination tablets (Enclosure 2) is also attached.

Ms. Nancy Williams
EPC-DO: 18-199

2

Please contact Patty Vardaro-Charles at (505) 665-4644 or Michael T. Saladen at (505) 665-6085 of the Environmental Compliance Programs Group if you have questions.

Sincerely,



Taunia S. Van Valkenburg
Group Leader

TSVV/MTS/PVC/EAG:kr

Enclosure: 1) National Pollutant Discharge Elimination System (NPDES) Permit No. NM0028355,
Notice of Planned Change at Outfall 03A181 - Configuration
2) Safety Data Sheet for ENVIRO-C[®] De-Chlorination Tablets

Cy: Shelly Lemon, NMED/SWQB, Santa Fe, NM, (E-File)
Erin Trujillo, NMED/SWQB, Santa Fe, NM, (E-File)
Michelle Hunter, NMED/GWQB, Santa Fe, NM, (E-File)
Karen E. Armijo, NA-LA, (E-File)
Carol A. Brown, NA-LA, (E-File)
Craig S. Leasure, PADOPS, (E-File)
William R. Mairson, PADOPS, (E-File)
Enrique Torres, EPC-DO, (E-File)
Taunia Van Valkenburg, EPC-CP (E-File)
Michael T. Saladen, EPC-CP, (E-File)
Patty Vardaro-Charles, EPC-CP, (E-File)
adesh-records@lanl.gov, (E-File)
epccat@lanl.gov, (E-File)
epc-correspondence@lanl.gov, (E-File)

ENCLOSURE 1

National Pollutant Discharge Elimination System
(NPDES) Permit No. NM0028355, Notice of Planned
Change at Outfall 03A181 - Configuration

EPC-DO: 18-199

LA-UR-18-23841

Date: MAY 08 2018

LA-UR-18-23841

TA-55-0006 Cooling Tower Configuration

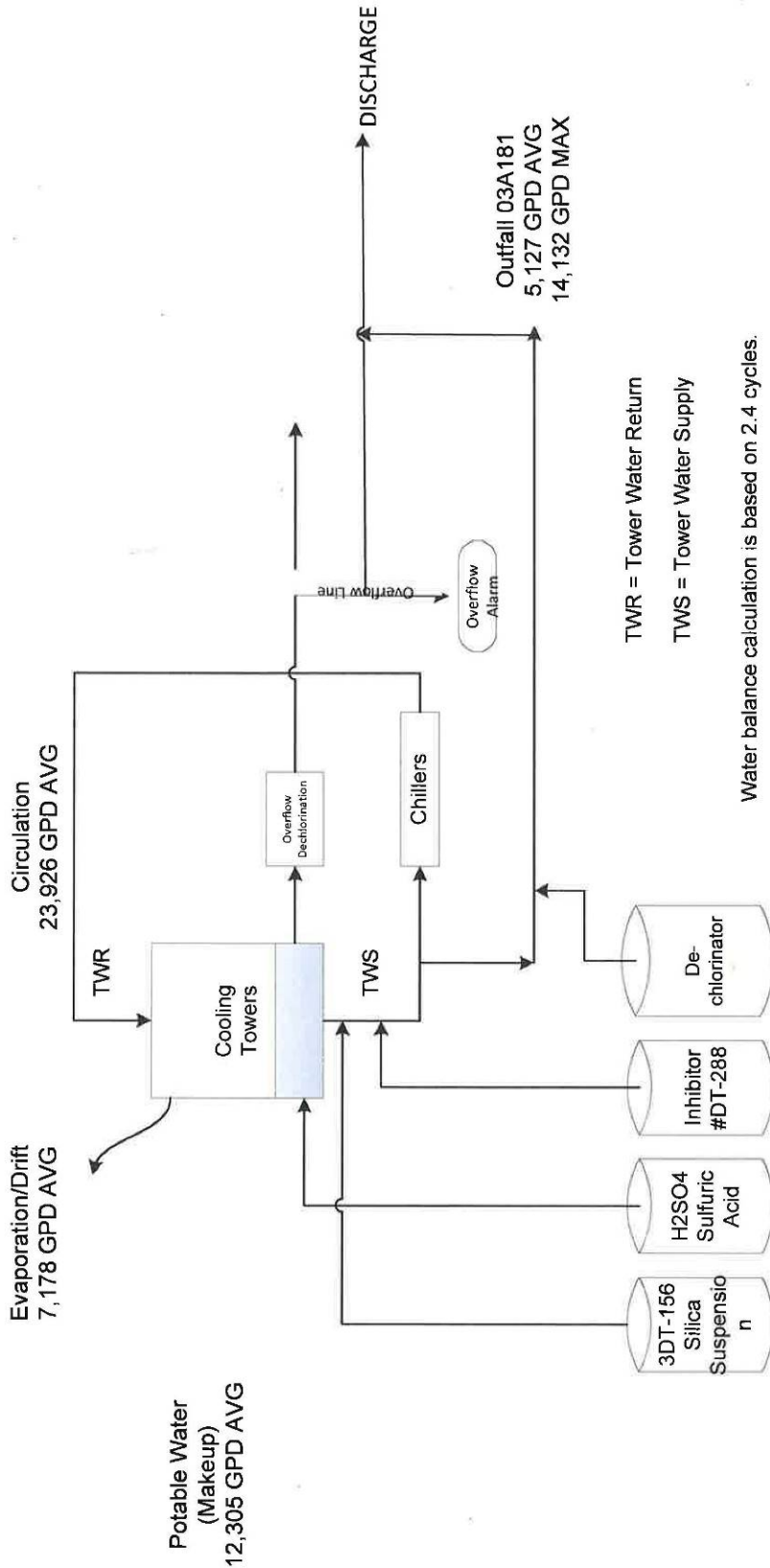

PROCESS SCHEMATIC
PLUTONIUM FACILITY COOLING TOWERS
TA-55-6
2018 NPDES Permit Re-Application
OUTFALL 03A181

ENCLOSURE 2

Safety Data Sheet for ENVIRO-C[®] De-Chlorination Tablets

EPC-DO: 18-199

LA-UR-18-23841

Date: MAY 08 2018



SAFETY DATA SHEET
ENVIRO-C® DECHLORINATION TABLETS

EMERGENCY TELEPHONE: (800) 424-9300
DATE PREPARED: JANUARY 2017

I. PRODUCT AND COMPANY IDENTIFICATION

PRODUCT NAME	Enviro-C®
CHEMICAL NAME	Ascorbic Acid Tablets
CHEMICAL ABSTRACT SERVICE NO.	CAS #50-81-7
CHEMICAL FAMILY	Organic Acid
FORMULA	C ₆ H ₈ O ₆
SUPPLIER	Norweco, Inc. 220 Republic St. Norwalk, OH USA 44857
EMERGENCY TELEPHONE NUMBER	(800) 424-9300
TECHNICAL PHONE NUMBER	(800) NORWECO, (800) 667-9326

II. HAZARDOUS IDENTIFICATION

EMERGENCY OVERVIEW	May cause irritation to eyes, skin and respiratory system on contact. Ingestion may irritate gastrointestinal tract. Ingestion of small amounts is not likely to produce harmful effects. Chronic ingestion of large quantities may cause gastrointestinal effects including nausea, diarrhea, urine acidification, oxalate and uric crystallization in the bladder and kidneys, decreased reaction times, psychomotor coordination.
POTENTIAL ACUTE HEALTH EFFECTS	
INHALATION	Inhalation may irritate the nose, throat and upper respiratory tract.
INGESTION	Ingestion of small amounts is not likely to produce harmful effects. Chronic ingestion of large quantities may cause gastrointestinal effects including nausea, diarrhea, urine acidification, oxalate and uric crystallization in the bladder and kidneys, decreased reaction times, psychomotor coordination. May cause skin irritation.
SKIN	May irritate eyes.
EYES	May irritate eyes.
OVER EXPOSURE SIGNS/SYMPOMS	
INHALATION	Adverse symptoms may include the following: nose, throat and respiratory tract irritation
INGESTION	Adverse symptoms may include the following: gastrointestinal tract irritation large quantities may cause gastrointestinal effects including nausea, diarrhea, urine acidification, oxalate and uric crystallization in the bladder and kidneys, decreased reaction times, psychomotor coordination.
SKIN	Adverse symptoms may include the following: irritation
EYES	Adverse symptoms may include the following: irritation
MEDICAL CONDITIONS AGGRAVATED BY OVEREXPOSURE	Not available

III. CONSUMPTION/INFORMATION ON INGREDIENTS

ASCORBIC ACID	75%
INERT INGREDIENTS	25%

THERE ARE NO ADDITIONAL INGREDIENTS PRESENT, WITHIN THE CURRENT KNOWLEDGE OF THE SUPPLIER AND IN THE CONCENTRATIONS APPLICABLE THAT ARE CLASSIFIED AS HAZARDOUS TO HEALTH OR THE ENVIRONMENT AND HENCE REQUIRE REPORTING IN THIS SECTION.

IV. FIRST AID PROCEDURES

If ingestion, irritation, any type of overexposure or symptoms of overexposure occur during or persists after use of this product, contact a POISON CONTROL CENTER, EMERGENCY ROOM OR PHYSICIAN immediately; have Safety Data Sheet information available. Never give anything by mouth to an unconscious or convulsing person.	
EYE CONTACT	Flush eyes with plenty of water. If irritation persists, seek medical attention.
SKIN CONTACT	Wash with soap and water. Seek medical attention if irritation develops.
INHALATION	Remove to fresh air.
INGESTION	Do not induce vomiting. Rinse mouth. If adverse symptoms develop, seek medical attention.
NOTE TO PHYSICIAN	No specific treatment. Treat symptomatically. Contact poison treatment specialist immediately if large quantities have been ingested.

V. FIRE-FIGHTING MEASURES

FLAMMABILITY OF THE PRODUCT	Not available
EXTINGUISHING MEDIA	
SUITABLE	Use any fire fighting agent appropriate for surrounding material; use water spray, carbon dioxide, dry chemical or foam.
NOT SUITABLE	Not applicable
SPECIAL EXPOSURE HAZARDS	As with most organic solids, combustion is possible at elevated temperatures.
HAZARDOUS COMBUSTION PRODUCTS	Oxides of carbon (CO, CO ₂)
SPECIAL FIREFIGHTING PROCEDURES	Use water to cool nearby containers and structures. Wear full protective equipment, including suitable respiratory protection.

VI. ACCIDENTAL RELEASE MEASURES

PERSONAL PRECAUTIONS	Wear appropriate personal protective equipment if required.
ENVIRONMENTAL PRECAUTIONS	Not Applicable
LARGE SPILL	Sweep or scoop into clean, dry disposal container. Flush spill area with water.
SMALL SPILL	Sweep or scoop into clean, dry disposal container. Flush spill area with water.
REFERENCE TO OTHER SECTIONS	See Section I for emergency contact information. See Section VIII for information on appropriate personal protective equipment. See Section XIII for additional waste treatment information.

VII. HANDLING AND STORAGE

HANDLING	Use proper equipment for lifting and transporting all containers. Use sensible industrial hygiene and housekeeping practices. Use caution in handling spilled material. Put on appropriate personal protective equipment (see Section VIII). Do not swallow. Do not get in eyes or on skin or clothing. Use only with adequate ventilation. Wear appropriate respirator when ventilation is inadequate. Keep in the original container with the lid securely closed. Wash thoroughly after handling. Avoid all situations that could lead to harmful exposure.
STORAGE	Store in a cool, dry, well-ventilated area away from incompatible materials. Keep containers tightly closed and protect them from physical damage. Protect from direct light and minimize contact with air. Keep material dry. Keep away from oxidizers, acids and other chemicals. Do not reuse or refill empty containers. Offer to recycling if available or place in trash collection. Do not contaminate food or feed by storage or disposal of this product.

EPC-CP-18-199

norweco[®]

LA-UR-23841

SAFETY DATA SHEET
ENVIRO-C[®] DECHLORINATION TABLETS

EMERGENCY TELEPHONE: (800) 424-9300
DATE PREPARED: JANUARY 2017

I. PRODUCT AND COMPANY IDENTIFICATION

PRODUCT NAME	Enviro-C [®]
CHEMICAL NAME	Ascorbic Acid Tablets
CHEMICAL ABSTRACT SERVICE NO.	CAS #50-81-7
CHEMICAL FAMILY	Organic Acid
FORMULA	C ₆ H ₈ O ₆
SUPPLIER	Norweco, Inc. 220 Republic St. Norwalk, OH USA 44857
EMERGENCY TELEPHONE NUMBER	(800) 424-9300
TECHNICAL PHONE NUMBER	(800) NORWECO, (800) 667-9326

II. HAZARDOUS IDENTIFICATION

EMERGENCY OVERVIEW	May cause irritation to eyes, skin and respiratory system on contact. Ingestion may irritate gastrointestinal tract. Ingestion of small amounts is not likely to produce harmful effects. Chronic ingestion of large quantities may cause gastrointestinal effects including nausea, diarrhea, urine acidification, oxalate and uric crystallization in the bladder and kidneys, decreased reaction times, psychomotor coordination.
POTENTIAL ACUTE HEALTH EFFECTS	
INHALATION	Inhalation may irritate the nose, throat and upper respiratory tract.
INGESTION	Ingestion of small amounts is not likely to produce harmful effects. Chronic ingestion of large quantities may cause gastrointestinal effects including nausea, diarrhea, urine acidification, oxalate and uric crystallization in the bladder and kidneys, decreased reaction times, psychomotor coordination. May cause skin irritation.
SKIN	May irritate eyes.
EYES	
OVER EXPOSURE SIGNS/SYMPOMS	
INHALATION	Adverse symptoms may include the following: nose, throat and respiratory tract irritation
INGESTION	Adverse symptoms may include the following: gastrointestinal tract irritation large quantities may cause gastrointestinal effects including nausea, diarrhea, urine acidification, oxalate and uric crystallization in the bladder and kidneys, decreased reaction times, psychomotor coordination.
SKIN	Adverse symptoms may include the following: irritation
EYES	Adverse symptoms may include the following: irritation
MEDICAL CONDITIONS AGGRAVATED BY OVEREXPOSURE	Not available

III. CONSUMPTION/INFORMATION ON INGREDIENTS

ASCORBIC ACID	75%
INERT INGREDIENTS	25%

THERE ARE NO ADDITIONAL INGREDIENTS PRESENT, WITHIN THE CURRENT KNOWLEDGE OF THE SUPPLIER AND IN THE CONCENTRATIONS APPLICABLE THAT ARE CLASSIFIED AS HAZARDOUS TO HEALTH OR THE ENVIRONMENT AND HENCE REQUIRE REPORTING IN THIS SECTION.

IV. FIRST AID PROCEDURES

PHYSICIAN IMMEDIATELY	If ingestion, irritation, any type of overexposure or symptoms of overexposure occur during or persists after use of this product, contact a POISON CONTROL CENTER, EMERGENCY ROOM OR PHYSICIAN immediately; have Safety Data Sheet information available. Never give anything by mouth to an unconscious or convulsing person.
EYE CONTACT	Flush eyes with plenty of water. If irritation persists, seek medical attention.
SKIN CONTACT	Wash with soap and water. Seek medical attention if irritation develops.
INHALATION	Remove to fresh air.
INGESTION	Do not induce vomiting. Rinse mouth. If adverse symptoms develop, seek medical attention.
NOTE TO PHYSICIAN	No specific treatment. Treat symptomatically. Contact poison treatment specialist immediately if large quantities have been ingested.

V. FIRE-FIGHTING MEASURES

FLAMMABILITY OF THE PRODUCT	Not available
EXTINGUISHING MEDIA	
SUITABLE	Use any fire fighting agent appropriate for surrounding material; use water spray, carbon dioxide, dry chemical or foam.
NOT SUITABLE	Not applicable
SPECIAL EXPOSURE HAZARDS	As with most organic solids, combustion is possible at elevated temperatures.
HAZARDOUS COMBUSTION PRODUCTS	Oxides of carbon (CO, CO ₂)
SPECIAL FIREFIGHTING PROCEDURES	Use water to cool nearby containers and structures. Wear full protective equipment, including suitable respiratory protection.

VI. ACCIDENTAL RELEASE MEASURES

PERSONAL PRECAUTIONS	Wear appropriate personal protective equipment if required.
ENVIRONMENTAL PRECAUTIONS	Not Applicable
LARGE SPILL	Sweep or scoop into clean, dry disposal container. Flush spill area with water.
SMALL SPILL	Sweep or scoop into clean, dry disposal container. Flush spill area with water.
REFERENCE TO OTHER SECTIONS	See Section I for emergency contact information. See Section VIII for information on appropriate personal protective equipment. See Section XIII for additional waste treatment information.

VII. HANDLING AND STORAGE

HANDLING	Use proper equipment for lifting and transporting all containers. Use sensible industrial hygiene and housekeeping practices. Use caution in handling spilled material. Put on appropriate personal protective equipment (see Section VIII). Do not swallow. Do not get in eyes or on skin or clothing. Use only with adequate ventilation. Wear appropriate respirator when ventilation is inadequate. Keep in the original container with the lid securely closed. Wash thoroughly after handling. Avoid all situations that could lead to harmful exposure.
STORAGE	Store in a cool, dry, well-ventilated area away from incompatible materials. Keep containers tightly closed and protect them from physical damage. Protect from direct light and minimize contact with air. Keep material dry. Keep away from oxidizers, acids and other chemicals. Do not reuse or refill empty containers. Offer to recycling if available or place in trash collection. Do not contaminate food or feed by storage or disposal of this product.

norweco®

SAFETY DATA SHEET ENVIRO-C® DECHLORINATION TABLETS

PAGE 2
DATE PREPARED: JANUARY 2017

VIII. EXPOSURE CONTROLS AND PERSONAL PROTECTION

CONSULT LOCAL AUTHORITIES FOR ACCEPTABLE EXPOSURE LIMITS

RECOMMENDED MONITORING PROCEDURES
ENGINEERING MEASURES
HYGIENE MEASURES

Per OSHA & ACGIH no permissible exposure limits have been established.
Use adequate general or local exhaust ventilation to keep fume and/or dust level as low as possible.
Wash hands, forearms and face thoroughly after handling chemical products, before eating, smoking, using the lavatory and at the end of the working period. Appropriate techniques should be used to remove potentially contaminated clothing. Wash contaminated clothing before reusing. Ensure that eyewash stations and safety showers are close to the workstation location.

PERSONAL PROTECTION

EYES
HANDS
GLOVES
RESPIRATORY

Safety glasses
Gloves should be worn
Natural or synthetic rubber
Respiratory protection is not required under normal use, however when necessary, use NIOSH/MSHA approved respirator following manufacturer's recommendations. NIOSH approved dust mask is essential where dusting may occur.

SKIN

Boots, aprons or chemical suits as required to prevent skin contact.

ENVIRONMENTAL EXPOSURE CONTROLS

Not applicable

IX. PHYSICAL AND CHEMICAL PROPERTIES

PHYSICAL STATE	Solid	DENSITY (lbs/gal)	12.7
FLASH POINT	Not available	VAPOR PRESSURE	Not available
DECOMPOSITION TEMPERATURE	Not available	VAPOR DENSITY	Not available
MATERIAL SUPPORTS COMBUSTION	Not applicable	VOLATILITY	Not available
COLOR	Orange tablet	EVAPORATION RATE	Not available
ODOR	Slight citrus odor	VISCOSITY	Not applicable
pH	1% Aqueous Solution, 2 to 3	SOLUBILITY	33g/100 mL water @ 25°C
BOILING/CONDENSATION POINT	Not available	WATER SOLUBILITY AT ROOM TEMPERATURE	Not available
MELTING/FREEZING POINT	Not available	PARTITION COEFFICIENT NOCTANOL/WATER	Not available
SPECIFIC GRAVITY	Not available	% SOLID (WWW)	Not available

X. STABILITY AND REACTIVITY

STABILITY	Stable
CONDITIONS TO AVOID	Exposure to light, air, moisture and high temperatures
MATERIALS TO AVOID	Incompatible with strong acids, strong bases and strong oxidizers
HAZARDOUS COMBUSTION PRODUCTS	Oxides of carbon (CO, CO ₂)
POSSIBILITY OF HAZARDOUS REACTIONS	Not applicable

XI. TOXICOLOGICAL INFORMATION

PERMISSIBLE ACUTE	No permissible exposure limits have been established by OSHA.
INHALATION	Inhalation may irritate the nose, throat and upper respiratory tract.
EYE/SKIN	Excessive contact may cause skin irritation. Eye contact may cause irritation.
INGESTION	Ingestion of small amounts is not likely to produce harmful effects. Chronic ingestion of large quantities may cause gastrointestinal effects including nausea, diarrhea, urine acidification, oxalate and uric crystallization in the bladder and kidneys, decreased reaction times, psychomotor coordination.
CHRONIC	Chronic ingestion of large quantities may cause gastrointestinal effects including nausea, diarrhea, urine acidification, oxalate and uric crystallization in the bladder and kidneys, decreased reaction times, psychomotor coordination.

XII. ECOLOGICAL INFORMATION

ECOLOGICAL TOXICITY VALUES	No information available
ENVIRONMENTAL EFFECTS	Not applicable
BIODEGRADABILITY	Not applicable

XIII. DISPOSAL CONSIDERATIONS

WASTE DISPOSAL	Dispose in accordance with all local, state and federal regulations.
----------------	----------------------------------------------------------------------

XIV. TRANSPORTATION INFORMATION

IDENTIFICATION NUMBER	Not applicable	I.M.O. DESCRIPTION	Non-Hazardous
PACKING GROUP	Not applicable	U.S. DOT SHIPPING NAME	Non-Hazardous Tablets
REPORTABLE QUANTITY	Not applicable	U.S. DOT HAZARD CLASS	Non-Hazardous
HMIS/NFPA RATING	Not applicable		

XV. REGULATORY INFORMATION

UNITED STATES INVENTORY (TSCA)	Yes
CANADA REGULATIONS (WHIMIS)	Not controlled
CERCLA HAZARDOUS SUBSTANCE	No
SARA TITLE III	Non-hazardous

XVI. OTHER INFORMATION

OTHER SPECIAL	Not applicable
DATE OF ISSUE	January 21, 2017

THIS SAFETY DATA SHEET IS OFFERED SOLELY FOR YOUR INFORMATION, CONSIDERATION AND INVESTIGATION. THE INFORMATION CONTAINED IN THIS DATA SHEET IS BASED ON PRESENT SCIENTIFIC AND TECHNICAL KNOWLEDGE. THE PURPOSE OF THIS INFORMATION IS TO DRAW ATTENTION TO THE HEALTH AND SAFETY ASPECTS CONCERNING THE PRODUCT AND TO RECOMMEND PRECAUTIONARY MEASURES FOR THE STORAGE AND HANDLING OF THE PRODUCT. NORWALK WASTEWATER EQUIPMENT COMPANY PROVIDES NO REPRESENTATIONS OR WARRANTIES, EITHER EXPRESSED OR IMPLIED, AND ASSUMES NO RESPONSIBILITY FOR THE ACCURACY OR COMPLETENESS OF THE DATA CONTAINED HEREIN. NO LIABILITY CAN BE ACCEPTED FOR ANY FAILURE TO OBSERVE THE PRECAUTIONARY MEASURES DESCRIBED IN THIS DATA SHEET OR FOR ANY MISUSE OF THIS PRODUCT.



Environmental Protection Division
Water Quality & RCRA Group (ENV-RCRA)
P.O. Box 1663, Mail Stop K490
Los Alamos, New Mexico 87545
(505) 667-0666

Date: **NOV 30 2012**
Refer To: ENV-RCRA-12-0260
LAUR: 12-26607

Ms. Hannah Branning
U.S. Environmental Protection Agency, Region 6
Compliance and Assurance Division
Water Enforcement Branch (6EN)
1445 Ross Avenue, Suite 1200
Dallas, Texas 75202-2733

Mr. Richard Powell
Surface Water Quality Bureau
New Mexico Environment Department
Harold Runnels Building, N2050
1190 St. Francis Drive
P.O. Box 5469
Santa Fe, NM 87502-5469

Dear Ms. Branning and Mr. Powell:

**SUBJECT: NPDES PERMIT NO. NM0028355, BYPASS OF TREATMENT REPORT FOR
NPDES OUTFALL 03A160, NOVEMBER 28, 2012**

Enclosed for your review is the Bypass of Treatment Report for an unplanned release at the cooling towers at NPDES Outfall 03A160 (Enclosure 1) as required by Part II.B. of the Laboratory's NPDES Permit. Twenty-four hour notifications were made to your offices on November 28, 2012.

On the morning of November 28, 2012 at approximately 5:45 AM, facility personnel discovered overflowing tanks on the cooling tower system at the Technical Area 35 (TA-35) National High Magnetic Field Laboratory (NPDES Outfall 03A160). The makeup water valve supplying water to the cooling system was stuck in the open position. The stuck valve was immediately isolated to stop the overflowing condition.

The water overflowing the tanks bypassed the copper ion exchange columns. The water entered area drop inlets connected to the culvert where the cooling tower normally discharges (after final treatment) to the environment. The system was shut down before a compliance sample could be collected.

An Equal Opportunity Employer / Operated by Los Alamos National Security, LLC for the Department of Energy's NNSA

Ms. Hannah Branning and Mr. Richard Powell - 2 -
ENV-RCRA-12-0260

Please contact Marc Bailey at (505) 665-8135 or Bob Beers at (505) 667-7969 if you have questions regarding this report.

Sincerely,



Michael T. Saladen
Group Leader (Acting)
Water Quality & RCRA Group (ENV-RCRA)

MTS:MB/lm

Enclosure: Bypass of Treatment Report, Outfall 03A160, November 28, 2012

Cy: James Hogan, NMED/SWQB, Santa Fe, NM, w/enc.
Jim Davis, NMED/RPD, Santa Fe, NM, w/enc.
Thomas Skibitski, NMED/DOE/OB, Albuquerque, NM, w/enc.
Steven M. Yanicak, NMED/DOE/OB, w/enc, (E-File)
Steve Rydeen, San Ildefonso Pueblo, Santa Fe, NM, w/enc.
Gene E. Turner, LASO-EPO, w/enc., (E-File)
Carl A. Beard, PADOPS, w/o enc., A102
Michael T. Brandt, ADESH, w/o enc., (E-File)
Alison M. Dorries, ENV-DO, w/o enc., (E-File)
Michael T. Saladen, ENV-RCRA, w/enc., (E-File)
Marc A. Bailey, ENV-RCRA, w/enc., (E-File)
IRM-RMMSO File w/enc., (E-File)
ENV-RCRA Correspondence File, w/enc., K490

ENCLOSURE 1

Bypass of Treatment Report, Outfall 03A160, November 28, 2012

ENV-RCRA-12-0260

LAUR-12-26607

Date: NOV 30 2012

Los Alamos National Laboratory
NPDES Permit No. NM0028355
Bypass of Treatment Report, Outfall 03A160, November 28, 2012

1. Location of discharge

NPDES Outfall 03A160, Technical Area (TA)-35 National High Magnetic Field Laboratory (NHMFL) Cooling Tower.

2. Description of discharge which bypassed treatment

On the morning of November 28, 2012 at approximately 5:45 AM, facility personnel discovered overflowing tanks on the cooling tower system at the TA-35 NHMFL (NPDES Outfall 03A160). The makeup water valve supplying water to the cooling system was stuck in the open position. An estimated 55,000 gallons of water discharged directly to area drop inlets.

3. Impact upon the receiving waters

Outfall 03A160 intermittently discharges into Mortandad Canyon, an ephemeral tributary to the Rio Grande. No adverse impacts were observed.

4. Cause of treatment bypass

The makeup water valve supplying water to the cooling system was stuck in the open position causing the tank to overflow. This discharge did not go through the ion exchange treatment for copper removal.

5. Duration of condition if uncorrected

The overflow occurred after normal work hours for an estimated 9 hours before being discovered.

6. Steps taken to eliminate and prevent recurrence of the condition

Facility personnel will perform maintenance on the solenoid that operates the makeup water valve and will investigate the possibility of having the control room alarm tied in to the site-wide 24 hour alarm system.

7. Steps taken to minimize any adverse impact to navigable water

No adverse impact to navigable waters is anticipated as the discharge did not cross the Laboratory boundary or reach the Rio Grande.

Michael T. Saladen
Group Leader, (Acting)
Water Quality and RCRA Group

Date: 11/30/12

I certify under penalty of law that this document and all attachments were prepared under my direction or supervision in accordance with a system designed to assure that qualified personnel properly gather and evaluate the information submitted. Based on my inquiry of the person or persons who manage the system, or those persons directly responsible for gathering the information, the information submitted is, to the best of my knowledge and belief, true, accurate, and complete. I am aware that there are significant penalties for submitting false information, including the possibility of fine and imprisonment for knowing violations.

Medina, Louella B

From: Bailey, Marc A
Sent: Friday, November 30, 2012 2:34 PM
To: Branning.hannah@Epa.gov; Richard.Powell@state.nm.us
Cc: Beers, Bob; Saladen, Michael T; Gallegos, Robert M; Turner, Gene E; Alexander, Rick A; Medina, Louella B
Subject: NPDES Permit No. NM0028355 Five Day Written Report Bypass Of Treatment Outfall 03A160
Attachments: Bypass of Treatment ReportSIGNED 03A160 11-28-12.docx.pdf
Follow Up Flag: Follow up
Flag Status: Flagged

Ms. Branning and Mr. Powell-

Attached is the required 5 day written noncompliance report for the bypass of treatment at Outfall 03A160 that occurred on Wednesday, November 28, 2012. A hard copy will be placed in the mail on Monday December 3, 2012 (tracking number ED442503557US). The required 24-hour notifications were made to your offices on November 28, 2012.

Please contact me if additional information would be helpful.



Marc Bailey
ENV-RCRA Group
Water Quality Permitting & Compliance
TA59-96-208, MS K490
505-665-8135
marc@lanl.gov

ED442503557US



Signature/Review/Coordination Sheet

This form is to accompany all documents requiring review, approval, or signature by the Laboratory Director or Designee.

Date 11-29-12	Deadline 12-3-12	Is this a response to an action item? Yes <input type="checkbox"/> No <input checked="" type="checkbox"/>
From: ENV-RCRA Name: Marc Bailey	MS: K490	<input checked="" type="checkbox"/> Call for Pick-up Name: Linda M. Salazar Phone: 7-7407

Title: Identify document, briefly describing subject matter.
ENV-RCRA-12-0260
Required five-day written bypass of report for total overflowing cooling tower system at Outfall 03A160 November 28, 2012

Action Information Only

Background/Issues:
Non-routine Report

Unanticipated bypass of treatment facilities require 24 hour notification to EPA Region 6 and NMED-SWQB (completed 11-28-12 14:23 and 14:30 respectively) followed by a 5-day written noncompliance report. A makeup valve stuck in the open position after hours causing a cooling system tank to overflow and bypass the copper ion exchange treatment at Outfall 03A160.

The date is left blank on this correspondence pending routine approval and will be stamped before release.

ACTION requested of Laboratory Director or Designee:
Review and Endorse.

PAD Endorsement

Name (print)	Signature	Date
Carl A. Beard	na	

AD Endorsement

Name (print)	Signature	Date
Michael T. Brandt	cc Mike Brandt	

Coordinated with

1. Name (print)	Signature	Date
Alison M. Dorries		11/30/12
2. Name (print)	Signature	Date
Michael T. Saladen		11/30/12
3. Name (print)	Signature	Date
Robert S. Beers		11/30/12
4. Name (print)	Signature	Date
Marc A. Bailey		11/30/12
5. Name (print)	Signature	Date

Please ensure appropriate inter/intra Directorate/Divisional coordination and review prior to submittal to the Director's Office.
Form 1824 (1/07)



Environmental Protection & Compliance Division
Los Alamos National Laboratory
PO Box 1663, K490
Los Alamos, New Mexico 87545
(505) 667-0666

Date: **MAY 3 1 2018**
Symbol: EPC-DO: 18-216
LA-UR: 18-24611
Locates Action No.: N/A

Ms. Nancy Williams
U.S. Environmental Protection Agency, Region 6
Compliance Assurance and Enforcement Division
Water Enforcement Branch (6EN)
1445 Ross Avenue, Suite 1200
Dallas, TX 75202-2733

**Subject: LOS ALAMOS NATIONAL LABORATORY, NATIONAL POLLUTANT
DISCHARGE ELIMINATION SYSTEM PERMIT NO. NM0028355, NOTICE OF
PLANNED CHANGE AT NPDES OUTFALL 03A160**

Dear Ms. Williams:

National Pollutant Discharge Elimination System (NPDES) Permit No. NM0028355 for the National Nuclear Security Administration and Los Alamos National Security, LLC at Los Alamos National Laboratory (LANL) requires the permittees to notify the U. S. Environmental Protection Agency regarding any physical alterations or additions to the permitted facility that could significantly change the nature or increase the quantity of pollutants discharged (see Part III.D.1.a. *Reporting Requirements*).

On May 5th, 2018, discharge to the outfall was eliminated and the cooling tower blow down has been re-routed to the LANL's Sanitary Wastewater System (SWWS) by way of a sanitary drain at TA-35 Building 126 (see Enclosure 1). The cooling tower will no longer discharge to the 03A160 outfall. LANL will continue to maintain 03A160 as a permitted outfall in case of an operational upset. This outfall supports a user program and the ability to discharge must be maintained.

Ms. Nancy Williams
EPC-DO: 18-216

- 2 -

Please contact Patricia Vardaro-Charles at (505) 665-4644 or Mike Saladen at (505) 665-6085 of the Environmental Protection and Compliance Group if you have questions.

Sincerely,



Taunia S. Van Valkenburg
Group Leader

TSVV/MTS/PVC:cmh

Enclosure: 1) NPDES Permit No. NM0028355, Notice of Planned Change at Outfall 03A160

Copy: Nancy Williams, EPA Region 6 Permitting and Compliance, Dallas, TX (Hard copy, E-File)
Sarah Holcomb, NMED/SWQB, Santa Fe, NM, (Hard copy, E-File)
Shelly Lemon, NMED/SWQB, Santa Fe, NM, (E-File)
Erin Trujillo, NMED/SWQB, Santa Fe, NM, (E-File)
Michelle Hunter, NMED/GWQB, Santa Fe, NM, (E-File)
Susan A. Lucas-Kamat, NMED/DOE/OB, Albuquerque, NM, (E-File)
Jody M. Pugh, NA-LA, (E-File)
Darlene Rodriguez, LASO-MA-LS, (E-File)
Raymond Martinez, Pueblo de San Ildefonso, Santa Fe, NM, (E-File)
Karen E. Armijo, NA-LA, (E-File)
Annette Russell, EM-LA, (E-File)
Craig S. Leasure, PADOPS, (E-File)
William R. Mairson, ADESH, (E-File)
John C. Bretzke, ADESH, (E-File)
Enrique Torres, EPC-DO, (E-File)
Clifford Kirkland, STO-FOD, (E-File)
Marc Gallegos, DESHF-STO, (E-File)
Taunia S. Van Valkenburg, EPC-CP, (E-File)
Michael T. Saladen, EPC-CP, (E-File)
Patricia Vardaro-Charles, EPC-CP, (E-File)
Robert M. Gallegos, EPC-CP, (E-File + hard copy)
Elizabeth Gray, EPC-CP, (E-File)
Ellena I. Martinez, EPC-CP, (E-File)
locatsteam@lanl.gov, (E-File)
epc-correspondence@lanl.gov, (E-File)
adesh-records@lanl.gov, (E-File)

ENCLOSURE 1

NPDES Permit No. NM0028355, Notice of Planned
Change at Outfall 03A160

EPC-DO: 18-216

LA-UR-18-24611

Date: MAY 3 1 2018

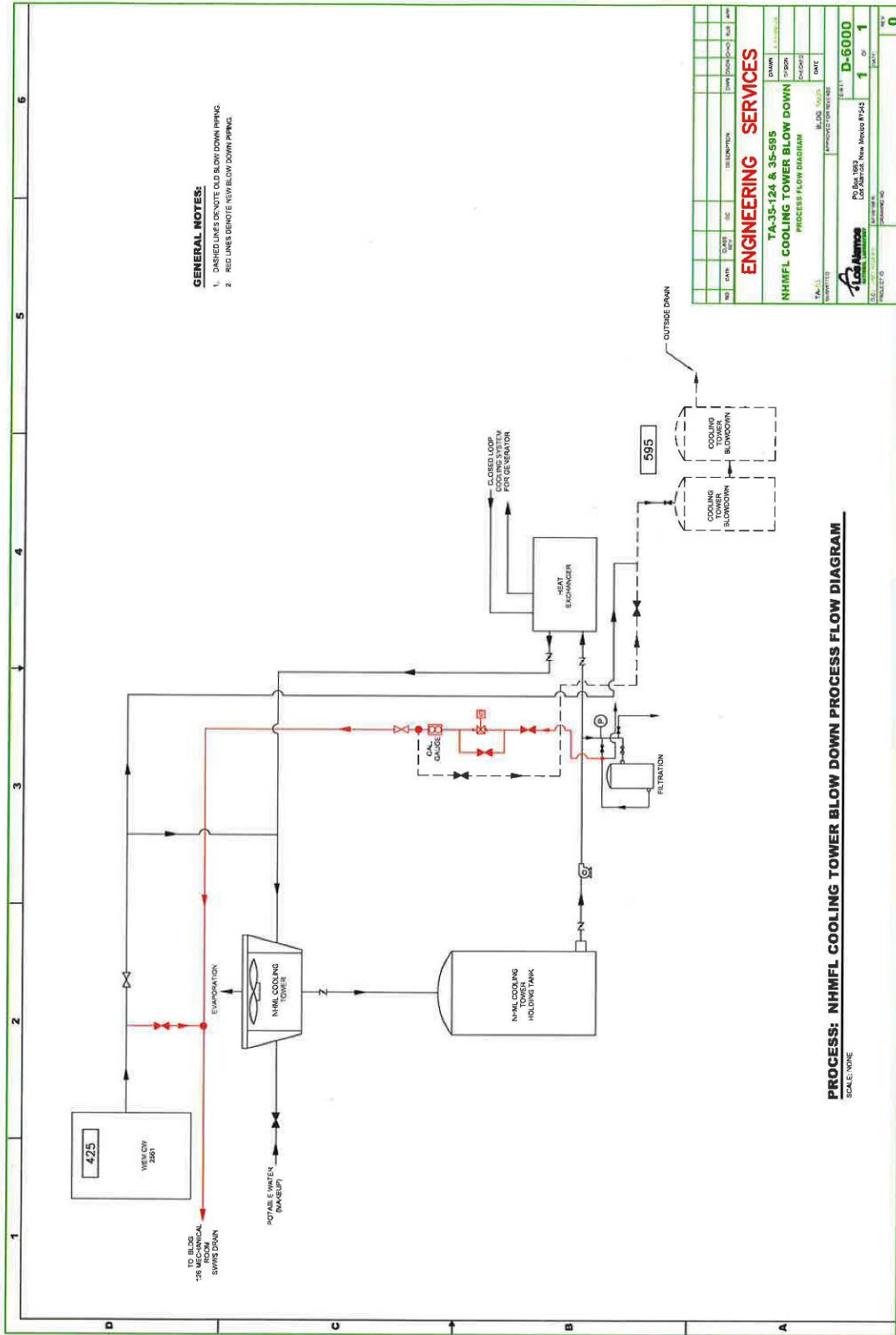

EPC-DO: 18-216

LA-UR-18-24611



Environmental Protection & Compliance Division
Environmental Compliance Programs (EPC-CP)
PO Box 1663, K490
Los Alamos, New Mexico 87545
(505) 667-0666



National Nuclear Security Administration
Los Alamos Field Office, A316
3747 West Jemez Road
Los Alamos, New Mexico, 87544
(505) 606-0397/Fax (505) 284-7522

Date: JUN 03 2016
Symbol: EPC-DO-16-116
LA-UR: 16-23486
Locates Action No.: N/A

Ms. Gladys Gooden-Jackson
U.S. Environmental Protection Agency, Region 6
Compliance Assurance and Enforcement Division
Water Enforcement Branch (6EN)
1445 Ross Avenue, Suite 1200
Dallas, TX 75202-2733

Dear Ms. Gooden-Jackson:

Subject: NPDES Permit No. NM0028355, Notice of Planned Change, Outfall 051

The NPDES Permit No. NM0028355 issued to the U. S. Department of Energy and Los Alamos National Security, LLC (DOE/LANS) for the Los Alamos National Laboratory requires the permittees to notify the U.S. Environmental Protection Agency (EPA) regarding any physical alterations or additions to the permitted facility that could significantly change the nature or increase the quantity of pollutants discharged (Part III.D.1.a, *Reporting Requirements*). This letter provides information regarding the TA-50 Radioactive Liquid Waste Treatment Facility – Upgrade Project (RLWTF-UP) and supplemental information for the DOE/LANS’ 2012 NPDES Permit Reapplication, submitted January 27, 2012 (ENV-DO-12-0002). Enclosure 1 is updated information from the 2012 NPDES Permit Reapplication for the existing TA-50 RLWTF. Enclosure 2 contains drawings from the RLWTF-UP Low Level Waste Subproject Final Design submitted to the New Mexico Environment Department in April 2014.

Ms. Gladys Gooden-Jackson
EPC-DO-16-116

- 2 -

The scope of the RLWTF-UP includes constructing a single-story reinforced concrete building (TA-50, Building 230), approximately 8,000 square feet in area and immediately west of the existing RLWTF (TA-50, Building 1), to house the following:

- Processing equipment for treating low-level radioactive liquid waste,
- A control room,
- An analytical laboratory,
- Change rooms for operators,
- Two 10,000 gallon treated effluent tanks, and
- A separate utility building to house mechanical and electrical equipment

The RLWTF-UP will be a replacement of the low-level radioactive liquid waste treatment capability currently in the existing RLWTF (TA-50, Building 1). RLWTF-UP began construction at the end of January 2015 and is scheduled to be operational by June 2018. The RLWTF-UP will not result in any change to the (1) location of the discharge, (2) quantity or quality of the discharge, or (3) the character of water contaminants received, treated, or discharged. Updates will be provided to EPA regarding any changes to the project schedule.

Please contact Marc A. Bailey of Environmental Compliance Programs (EPC-CP) Group, at (505) 665-8135 or Jordan Arnswald of the NA-LA National Security Missions - Program Integration Office (NA-LA-NS-PI) at (505) 667-6764 if you have questions.

Sincerely,



John P. McCann
Acting Division Leader
Environmental Protection & Compliance Division
Los Alamos National Security, LLC

Sincerely,



Jody M. Pugh
Assistant Manager
National Security Missions
Los Alamos Field Office

JPM:JMP:MTS:MAB/lm

Enclosures:

1. Updated Information, 2012 NPDES Permit Reapplication, Outfall 051, RLWTF
2. Drawings From The RLWTF-UP Low Level Waste Subproject Final Design

Cy: James Hogan, NMED/SWQB, Santa Fe, NM, (E-File)
Bruce Yurdin, NMED/SWQB, Santa Fe, NM
Michelle Hunter, NMED/GWQB, Santa Fe, NM, (E-File)
Steve Rydeen, San Ildefonso Pueblo, Santa Fe, NM, (E-File)
Susan A. Lucas-Kamat, NMED/DOE/OB, Albuquerque, NM, (E-File)
Steve Yanicak, NMED/DOE/OB, (E-File)

Ms. Gladys Gooden-Jackson
EPC-DO-16-116

- 3 -

Cy (continued):

Jordan Arnsward, NA-LA-NS-PI, (E-File)
Kirsten Laskey, EM-LA-SUP, (E-File)
Craig S. Leasure, PADOPS, (E-File)
William R. Mairson, PADOPS, (E-File)
Michael T. Brandt, ADESH, (E-File)
Raeanna Sharp-Geiger, ADESH, (E-File)
John P. McCann, EPC-DO, (E-File)
Robert C. Mason, TA-55-DO, (E-File)
Hugh A. McGovern, TA-55-DO, (E-File)
John C. Del Signore, TA-55-RLW, (E-File)
Michael T. Saladen, EPC-CP, (E-File)
Marc A. Bailey, EPC-CP, (E-File)
Robert M. Gallegos, EPC-CP, (E-File + hard copy)
Saundra Martinez, OIO-DO, (E-File)
Karen Armijo, LASO-NS-LP, (E-File)
LASOmailbox@nnsa.doe.gov, (E-File)
emla.docs@em.doe.gov, (E-File)
locatsteam@lanl.gov, (E-File)
epc-correspondence@lanl.gov, (E-File)

ENCLOSURE 1

Updated Information, 2012 NPDES Permit Reapplication,
Outfall 051, RLWTF

EPC-DO-16-116

LA-UR-23486

Date: JUN 03 2016

EPC-DO-16-116

ENCLOSURE 1

LA-UR-16-23486

Location of New LLW Treatment Building (50-0230)
West of Existing RLWTF (50-0001)

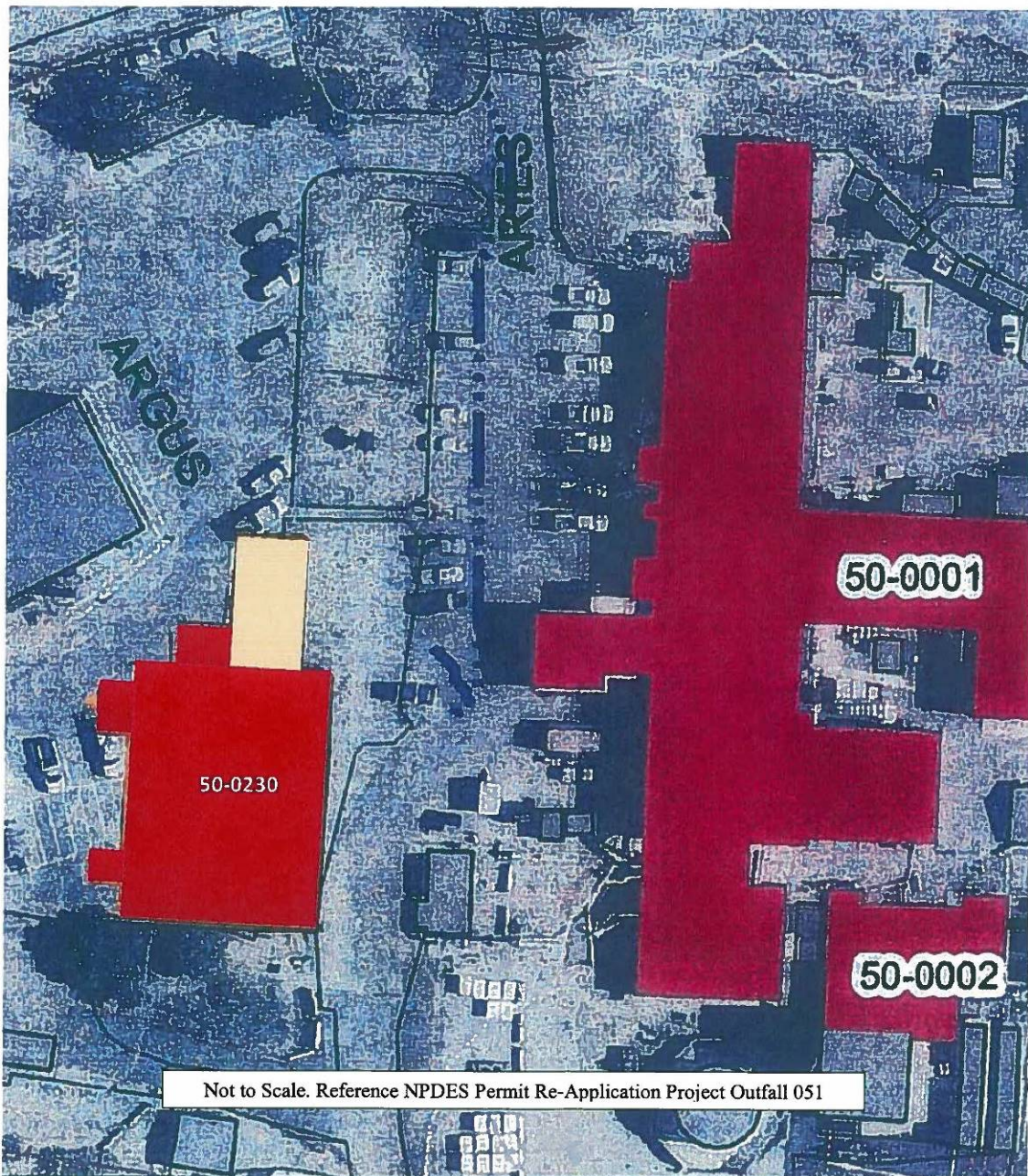

EPC-DO-16-116

ENCLOSURE 1

LA-UR-16-23486

**UPDATE TO NPDES PERMIT RE-APPLICATION
OUTFALL FACT SHEET, EFFECTIVE WHEN TA-50-230 IS FULLY OPERATIONAL**

Outfall ID No.	Outfall Location	Outfall Category	Receiving Stream
051	TA-50-1 TA-50-230	Radioactive Liquid Waste Treatment Facility (RLWTF)	Effluent Canyon, a Tributary to Mortandad Canyon

SOURCE OF DISCHARGE

Outfall 051 is located at TA-50 and discharges treated radioactive liquid wastewater effluent from the Radioactive Liquid Waste Treatment Facility (RLWTF) at TA-50-230 into Effluent Canyon, a tributary of Mortandad Canyon. Table 1 identifies the location of the RLWTF and provides a description of influent sources that it receives.

**Table 1
Sources for Discharge to Outfall 051**

TA	Bldgs	Description
50	1 230	Radioactive Liquid Waste Treatment Facility <ul style="list-style-type: none"> - Process water from radiochemistry laboratories, duct washing systems, radiological areas, boilers, and process areas. - Cooling water from systems located in radiological areas. - Storm and surface water (including samples) collected from sumps, manholes, and vaults. - Environmental Restoration (ER) waste water generated by groundwater monitoring and sampling activities at performed at LANL.

Figure 1 provides a process flow diagram for LLW treatment at RLWTF.

WATER TREATMENT PROCESS

The RLWTF treats low-level and transuranic (TRU) radioactive liquid wastewater delivered from processes at various generator facilities to TA-50 by underground collection system or by tanker truck. All wastewater discharged into the RLWTF must comply with the facility's Waste Acceptance Criteria and must have a completed/approved Waste Profile Form (Appendix N). The NPDES sample point for this outfall allows for the collection of a sample after the final treatment process. The RLWTF includes two different treatment processes as follows:

- **Low-Level Radioactive Liquid Waste (RLW) Treatment Process** - Low-level influent is received at the facility through the Radioactive Liquid Waste Collection System (see Appendix J, K) where it is routed through a pH adjustment chamber and collected in the influent tanks. RLW is fed from the influent tanks to the clarifiers where it is treated by chemical precipitation and flocculation (sodium hydroxide, magnesium hydroxide, ferric chloride, sulfate, or other chemicals) to remove silica and radionuclides. The clarified water is drawn off and filtered. The RLW may then be treated by ion exchange or is sent to a Reverse Osmosis (RO) unit. The RO permeate (treated water) is routed to effluent storage tanks prior to being discharged to the effluent evaporator, TA-52 solar evaporation tanks (anticipated to be operational within the next 5 years), or the NPDES outfall. If the effluent is to be discharged to Outfall 051 it is further treated with ion exchange to remove copper/zinc and may have magnesium/calcium salts added to adjust the hardness prior to discharge. Secondary waste treatment processes are also included for RO concentrate (Secondary RO) and sludge (vacuum filter/dewatering). These processes result in recycle streams back to the influent tanks and to other

EPC-DO-16-116

ENCLOSURE 1

LA-UR-16-23486

~~process units, and concentrated and solid waste streams shipped as low-level radioactive waste.~~
Low-level influent, from both the underground collection system and from tanker trucks, is received at the WMRM Facility, Building 50-250, from where it is pumped to Building 50-230 for treatment. Treatment steps consist of filtration (a roughing filter), chemical addition and mixing, solids precipitation in a reaction tank, microfiltration, reverse osmosis, ion exchange, and activated carbon treatment.

Three secondary waste streams are generated by the low-level RLW treatment process:

- Solids (e.g. sand, mop strings) removed by the roughing filter,
- Solids removed by the microfilter and dewatered by a rotary filter press, and
- A concentrated solution generating by evaporating the reverse osmosis waste stream

These secondary streams are collected in 55-gallon drums for disposal as non-hazardous radioactive solid wastes.

- **TRU RLW Treatment Process** - ~~TRU RLW is received at the facility through an underground, doubled-walled pipe collection system from TA-55 (see Appendix J, K) and is collected at the TA-50-66 influent tanks. The TRU influent is routed from TA-50-66 to the treatment tank in Room 60 where it is treated by chemical precipitation (sodium hydroxide) to remove radionuclides. Solids from the tank are collected in a sludge tank, allowed to settle, and are then solidified with cement in a drum tumbler. The cement drums are shipped and disposed of as TRU waste. The treated water is routed to the low-level treatment plant for either additional treatment or for storage pending shipment off-site for LLW disposal.~~ Transuranic influent is received, from an underground piping system, in tanks at Building 50-066, from where, it is pumped into Room 60 of Building 50-001 for treatment. Treatment steps include chemical addition and mixing, precipitation in a reaction tank, and collection of solids in a sludge tank. Solids are allowed to settle, then solidified with cement in 55-gallon drums, then shipped to WIPP for disposal as solid transuranic waste. The treated influent, no longer transuranic, is routed to the low-level RLW treatment process for either additional treatment in Building 50-230, or for storage in Building 50-248 pending shipment offsite for treatment and disposal as solid low-level radioactive waste

The water treatment codes provided in Table 2 have been assigned to this outfall.

Table 2
Water Treatment Codes Assigned to the RLWTF and Outfall 051

Treatment Code	Treatment Process	Description
1F	Evaporation	Waste Reduction Evaporator, Mechanical Evaporator, and/or Solar Evaporation Tanks
1G	Flocculation	Clarifiers
1O	Mixing	Various
1S	Reverse Osmosis (Hyperfiltration)	RO Units
1U	Sedimentation (Settling)	Sludge
1Q	Multimedia Filtration	Pressure and Cartridge Filters used for Particulate Removal; microfiltration
1R	Rapid Sand Filtration	Gravity Media Filter for Particulate Removal
2C	Chemical Precipitation	Sodium hydroxide, magnesium hydroxide, magnesium sulfate, sodium aluminate, co-polymer, and ferric sulfate are used to promote precipitation of radionuclides and silica removal
2G	Coagulation	Clarifiers Reaction tank

EPC-DO-16-116

ENCLOSURE 1

LA-UR-16-23486

Table 2 (continued)

Treatment Code	Treatment Process	Description
2J	Ion Exchange	Perchlorate, copper, and zinc removal
2K	Neutralization	Influent neutralization
5Q	Landfill	Drums of TRU and LLW Waste
5U	Vacuum Filtration	Vacuum filter for LLW sludge

TREATMENT CHEMICALS AND POTENTIAL CONTAMINANTS

The water treatment processes identified in Table 2 utilize chemicals to control pH, promote precipitation, and flocculation. Table 3 identifies the treatment chemicals that are used at the RLWTF.

Table 3
Treatment Chemicals Used at the RLWTF

Treatment Code	Treatment Process	Description
Ferric Sulfate	Promote Precipitation/Flocculation	Ferric Sulfate
Magnesium Hydroxide	Promote Precipitation/Flocculation	NA
Carbon Dioxide	Adjust pH	NA
Sulfuric Acid 93%	Adjust pH	Sulfuric Acid
Magnesium Sulfate	Precipitation/Flocculation	NA
Polymers	Precipitation/Flocculation	NA
Granulated Activated Carbon (GAC)	Removal of Organic Compounds	NA
EDTA	Membrane Cleaning	EDTA
Sodium bisulfite	Membrane Cleaning	Sodium Bisulfite
Dishwashing Soap	Membrane Cleaning	NA
Ionac SR-6	Ion Exchange Resin	NA
Hydrochloric Acid	Reduce pH	Hydrochloric Acid
Solid Sodium Hydroxide	Precipitation/Flocculation	Sodium Hydroxide
SCU	Ion Exchange Media	NA
SCP	Ion Exchange Media	NA
Sodium Aluminate	Precipitation/Flocculation	NA
WEST W-126	Ionic Co-polymer used as a Flocculent	2-Propanoic Acid

ENCLOSURE 2

Drawings From The RLWTF-UP Low Level
Waste Subproject Final Design

EPC-DO-16-116

LA-UR-23486

Date: JUN 03 2016

LA-UR-16-23486

ENCLOSURE 2

EPC-DO-16-116

New LLW Equipment Plan North (RLWTF-UP Low Level Waste Subproject Final Design)

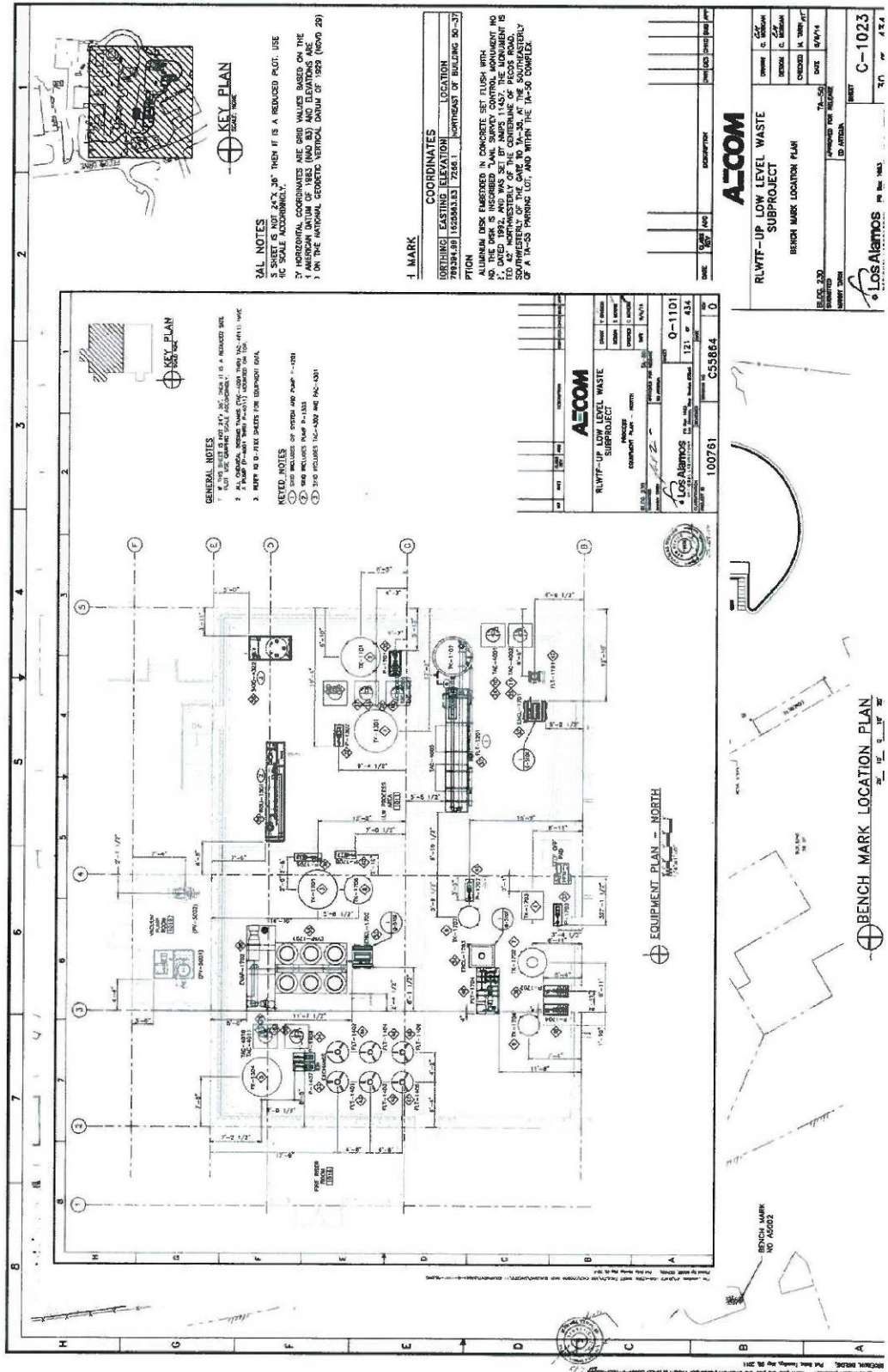

LA-UR-16-23486

ENCLOSURE 2

EPC-DO-16-116

New LLW Floor Plan South (RLWTF-UP Low Level Waste Subproject Final Design)

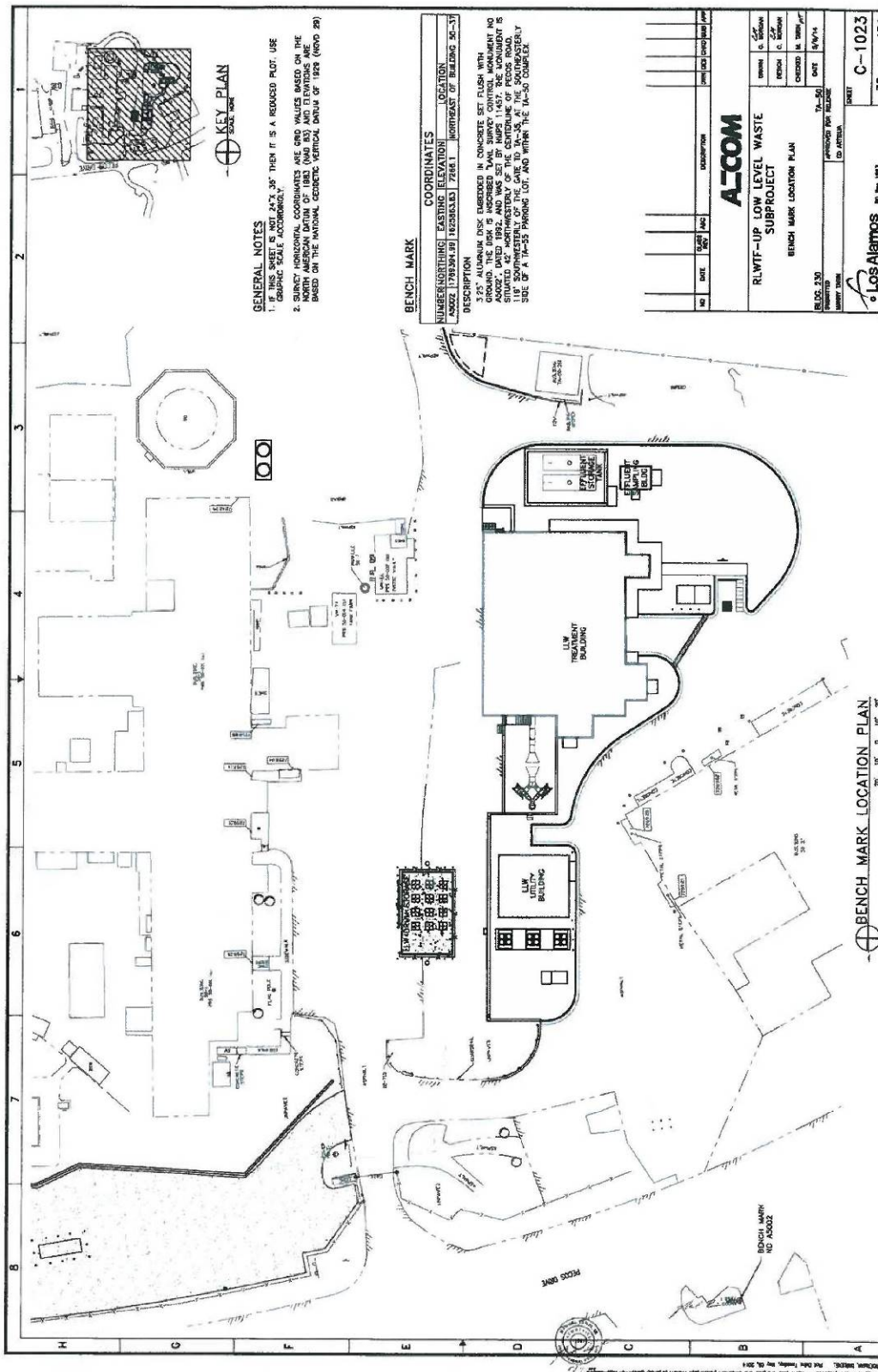

[This page is intentionally left blank.]



Environmental Protection & Compliance Division
Environmental Compliance Programs (EPC-CP)
PO Box 1663, K490
Los Alamos, New Mexico 87545
(505) 667-0666

National Nuclear Security Administration
Los Alamos Field Office, A316
3747 West Jemez Road
Los Alamos, New Mexico, 87544
(505) 665-7314/Fax (505) 667-5948

Date: NOV 29 2016
Symbol: EPC-DO-16-324
LA-UR: 16-28128
Locates Action No.: N/A

Ms. Gladys Gooden-Jackson
U.S. Environmental Protection Agency, Region 6
Compliance Assurance and Enforcement Division
Water Enforcement Branch (6EN)
1445 Ross Avenue, Suite 1200
Dallas, TX 75202-2733

Dear Ms. Gooden-Jackson:

Subject: Los Alamos National Laboratory NPDES Permit No. NM0028355, Notice of Planned Change at NPDES Outfall 051

The National Pollutant Discharge Elimination System (NPDES) Permit No. NM0028355 for the National Nuclear Security Administration (NNSA) and Los Alamos National Security, LLC (LANS) requires the permittee(s) to notify the U. S. Environmental Protection Agency (EPA) regarding any physical alterations or additions to the permitted facility that could significantly change the nature or increase the quantity of pollutants discharged (see Part III.D.1.a. *Reporting Requirements*).

The Laboratory's TA-50 Radioactive Liquid Waste Treatment Facility (RLWTF) intends to change the location within the facility at which NPDES compliance samples are collected from effluent water that is discharged to the environment via Outfall 051. The new location is in Room 34B at the RLWTF. This is the room in which the two effluent tanks, referred to as the North and South Frac tanks, reside.

Effluent water from the Frac tanks provides a 'net positive suction head' for the discharge pump that pumps the effluent to Outfall 051. As a discharge occurs from the Frac tanks, water will be pumped from the discharge line by a small sample pump that will recirculate about 1 gallon/minute back to the Frac tank. A sampling port, from which NPDES samples can be collected, is installed on this recirculation line. This new NPDES compliance sampling capability is shown in the photos 1, 2 and 3 (See Enclosure 1). Also enclosed for your review is the updated RLWTF schematic that documents the change in the

Ms. Gladys Gooden-Jackson
EPC-DO-16-324

- 2 -

sampling point location (See Enclosure 2).

Please contact Marc A. Bailey at (505) 665-8135 of the Environmental Protection and Compliance Division, Compliance Programs (EPC-CP) or Karen Armijo of the National Nuclear Security Administration, Los Alamos Field Office at (505) 665-7314 if you have questions.

Sincerely,



John C. Bretzke
Division Leader
Environmental Protection and Compliance Division
Los Alamos National Security, LLC

Sincerely,



Karen E. Armijo
Permitting and Compliance Program Manager
National Nuclear Security Administration
Los Alamos Field Office
U.S. Department of Energy

JCB:KEA:MTS:MAB/lm

Enclosures:

1. Photos of Sampling Pumps, NPDES Outfall Sampling Location and South Frac Tank at RLWTF
2. Updated TA-50 Treatment Schematic, Including Sampling Location Change

Cy: Shelly Lemon, NMED/SWQB, Santa Fe, NM, (E-File)
Erin Trujillo, NMED/SWQB, Santa Fe, NM, (E-File)
Susan A. Lucas-Kamat, NMED/DOE/OB, Albuquerque, NM, (E-File)
Steve Yanicak, NMED/DOE/OB, (E-File)
Karen E. Armijo, NA-LA, (E-File)
Craig S. Leasure, PADOPS, (E-File)
William R. Marison, PADOPS, (E-File)
Michael T. Brandt, ADESH, (E-File)
Raeanna Sharp-Geiger, ADESH, (E-File)
Hugh McGovern, TA-55-RLW, (E-File)
Pete Worland, TA-55-RLW, (E-File)
Michael T. Saladen, EPC-CP, (E-File)
Marc A. Bailey, EPC-CP, (E-File)
Robert M. Gallegos, EPC-CP, (E-File + hard copy)
Ellena I. Martinez, EPC-CP, (E-File)
LASOmailbox@nnsa.doe.gov, (E-File)
locatsteam@lanl.gov, (E-File)
epc-correspondence@lanl.gov, (E-File)

ENCLOSURE 1

Photos of Sampling Pumps, NPDES Outfall Sampling
Location and South Frac Tank at RLWTF

EPC-DO-16-324

LA-UR-16-28128

Date: NOV 29 2016

EPC-DO-16-324

LA-UR-16-28128

Enclosure 1

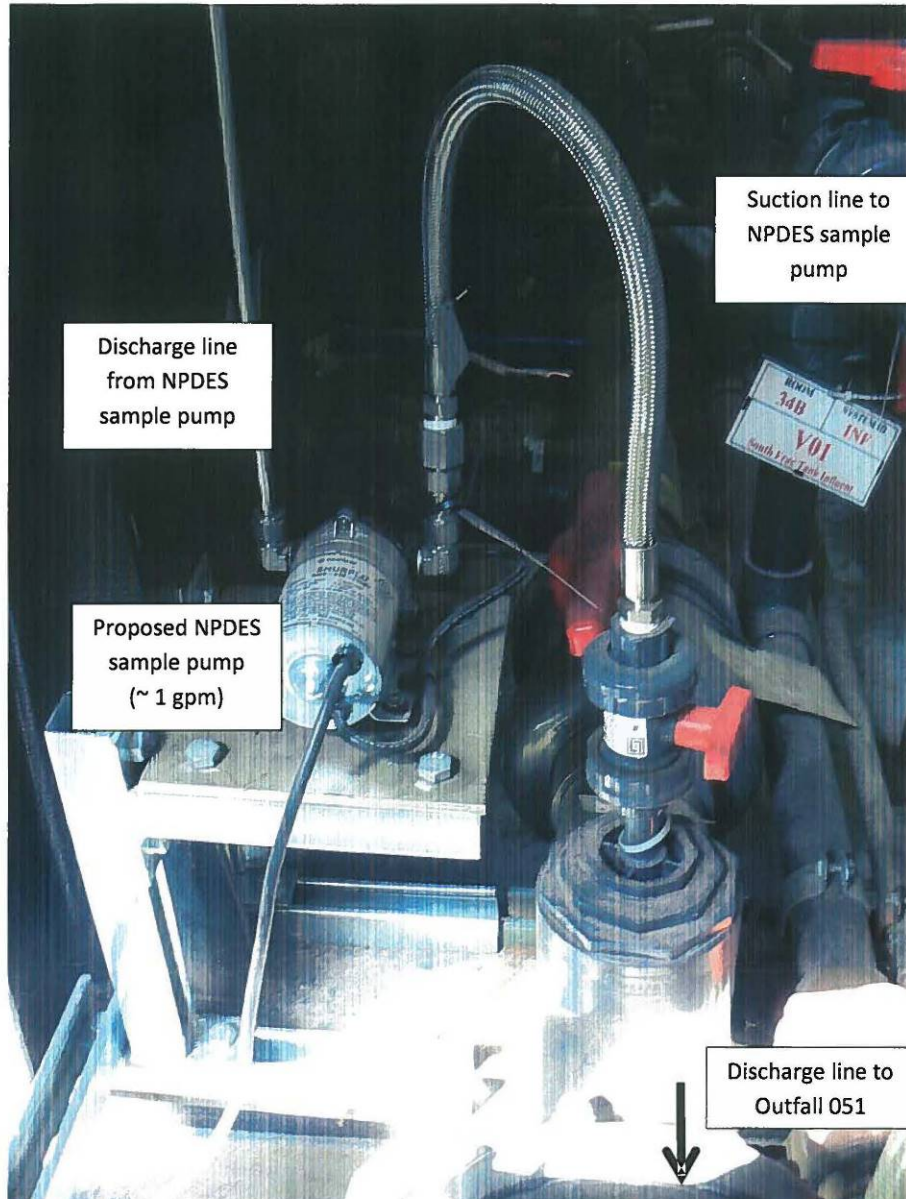

Photo 1

EPC-DO-16-324

LA-UR-16-28128

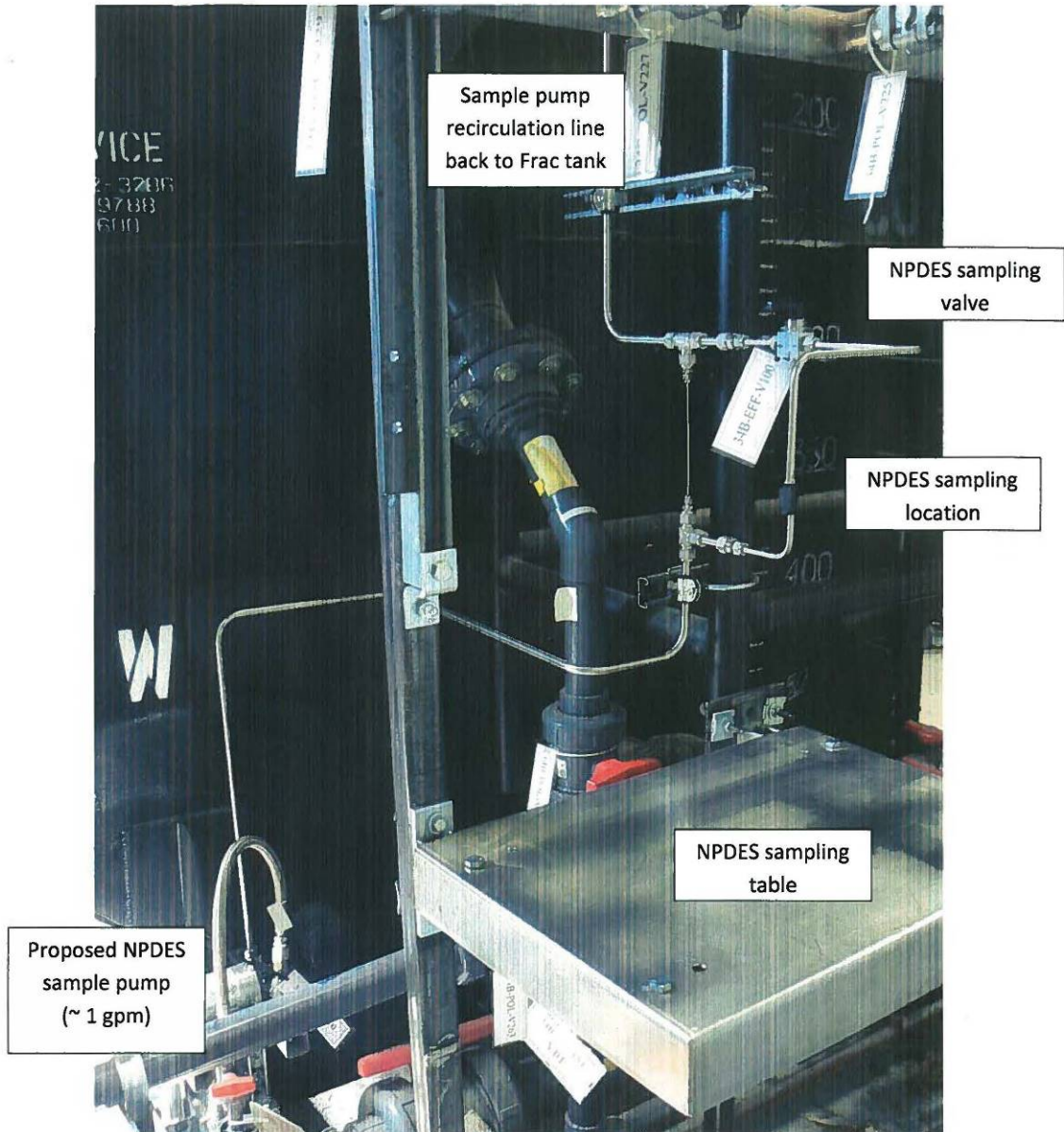

Photo 2

EPC-DO-16-324

LA-UR-16-28128

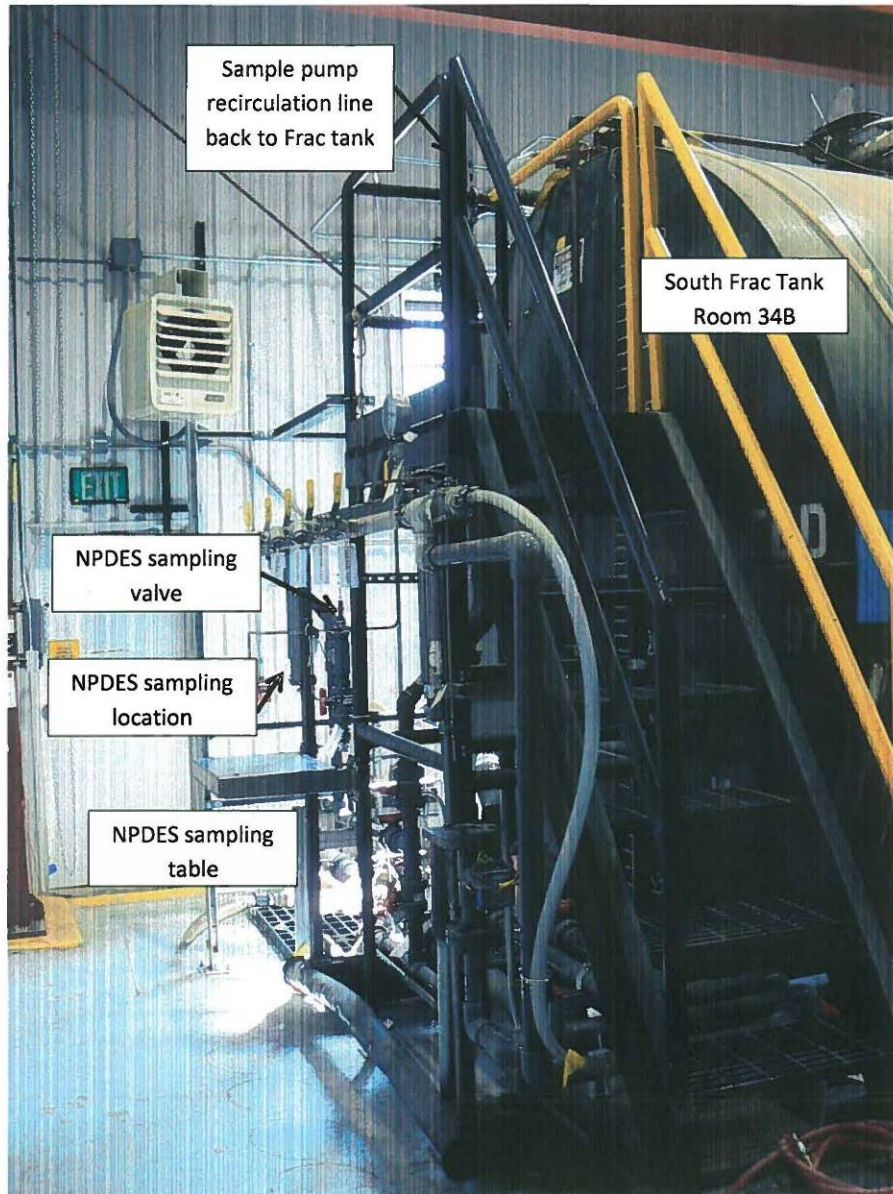

Photo 3

ENCLOSURE 2

Updated TA-50 Treatment Schematic, Including
Sampling Location Change

EPC-DO-16-324

LA-UR-16-28128

Date: NOV 29 2016

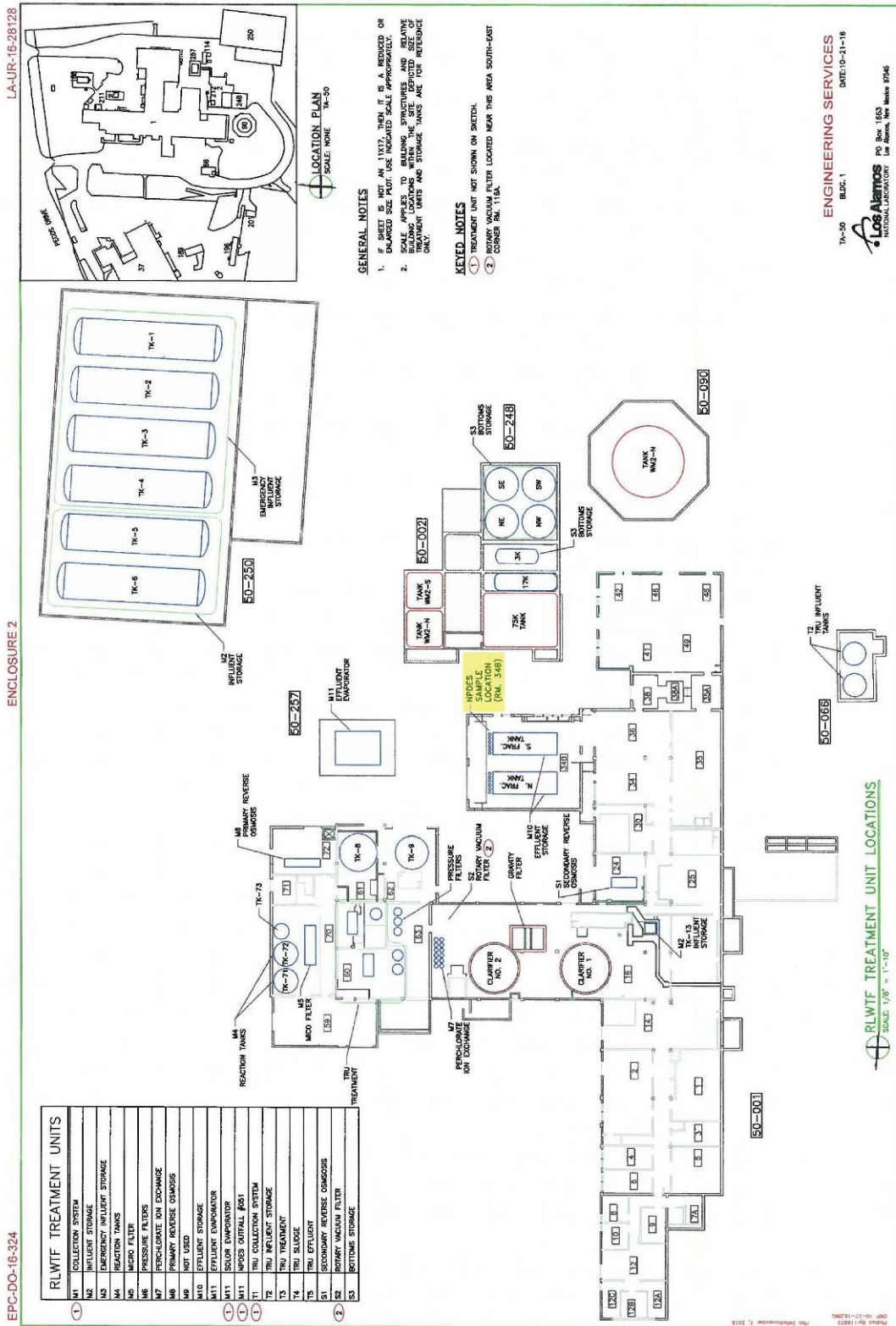

LA-UR-16-28128

ENCLOSURE 2

EPC-DO-16-324

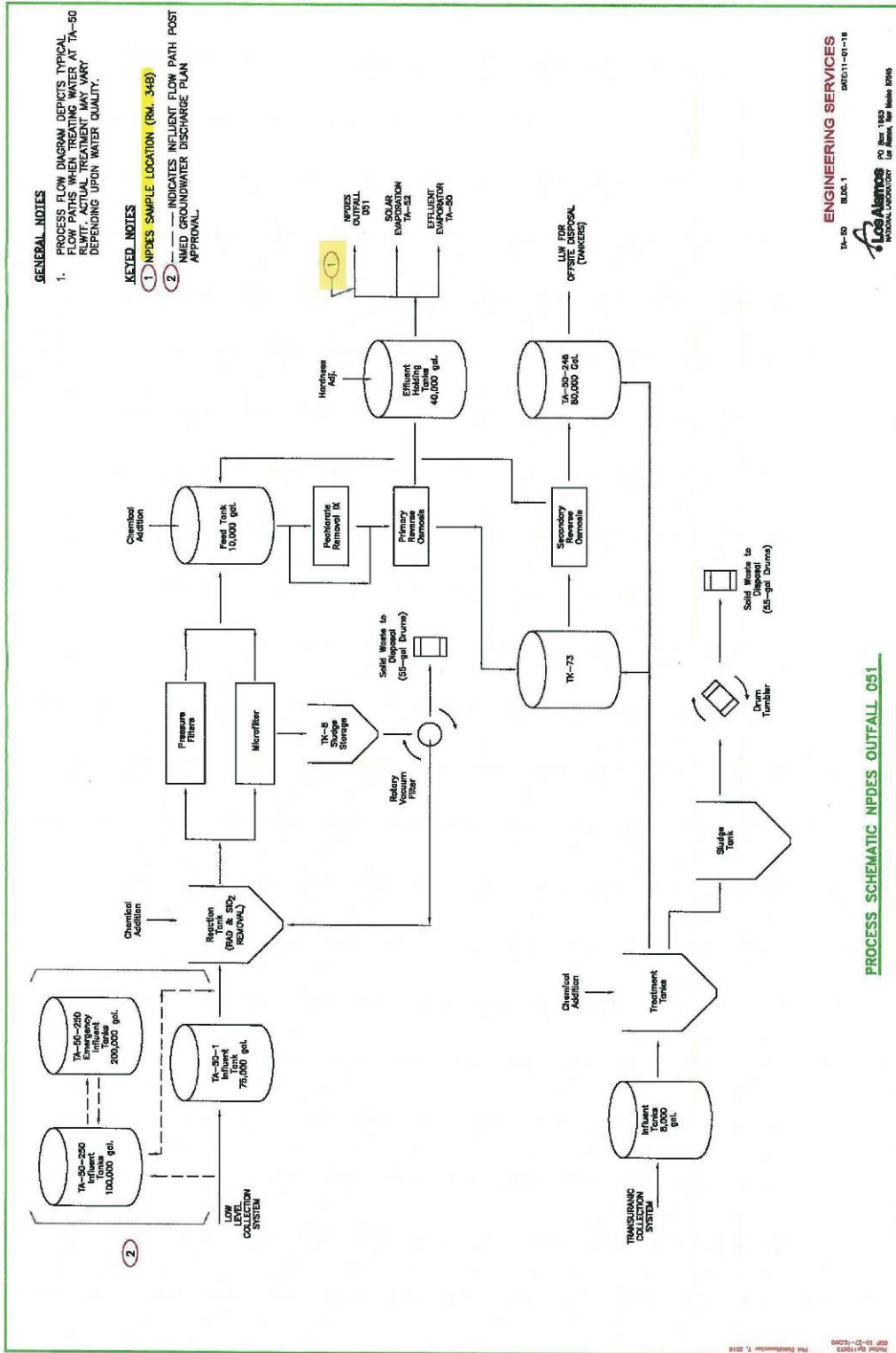



***Environmental Protection & Compliance Division
Environmental Compliance Programs***

PO Box 1663, K490
Los Alamos, New Mexico 87545
(505) 667-0666

Date: **MAY 22 2018**
Symbol: EPC-DO: 18-202
LAUR: 18-23962

Locates Action No.: NA

Ms. Nancy Williams
U.S. Environmental Protection Agency, Region 6
Compliance Assurance and Enforcement Division
Water Enforcement Branch (6EN)
1445 Ross Avenue, Suite 1200
Dallas, Texas 75202-2733

**SUBJECT: NPDES Permit No. NM0028355, Notification of Pre-Start Surrogate Water Test,
Radioactive Liquid Waste Treatment Facility Upgrade Project**

Dear Ms. Williams:

The National Pollutant Discharge Elimination System (NPDES) Permit No. NM0028355 for the National Nuclear Security Administration and Los Alamos National Security, LLC (NNSA/LANS) requires the permittee(s) to notify the U. S. Environmental Protection Agency (EPA) regarding any physical alterations or additions to the permitted facility that could significantly change the nature or increase the quantity of pollutants discharged (see Part III.D.1.a. Reporting Requirements).

The Radioactive Liquid Waste Treatment Facility Upgrade Project (RLWTF UP) will not result in any change to the (1) location of the discharge, (2) quantity or quality of the discharge, or (3) the character of water contaminants received, treated, or discharged. With construction of the RLWTF UP essentially complete, the next activity leading towards startup is a surrogate test of the RLWTF UP treatment units. This letter provides EPA with notification of the planned surrogate test and that it will occur within the next 45 days.

Approximately ten thousand gallons of tap water containing non-radioactive salts will be introduced to the RLWTF UP. The concentration of salts will be formulated in such quantities as to imitate the constituents in the design basis influent stream. Enclosure 1 provides a list of the 15 constituents that will be monitored during the surrogate test. Neodymium, samarium and cerium—non-radioactive metals—will be used as surrogate elements for plutonium, americium and uranium.

Ms. Nancy Williams
EPC-DO: 18-202

- 2 -

The surrogate test water will be fed to each RLWTF UP treatment process. Samples will be collected from the process streams and analyzed for each of the 15 constituents listed in Enclosure 1. Chemical analyses of these samples will determine if the treatment process removes contaminants as per the design requirements.

The performance of the surrogate test will take approximately 7 days. Each daily activity is identified below.

- Day 1: Development of surrogate water.
- Day 2: Pre-filling and pre-dosing operational tanks.
- Day 3: Feed surrogate water to the RLWTF UP and collect/analyze samples.
- Day 4: Operate the low pressure / low temperature evaporator and produce a drum of evaporator concentrate.
- Day 5: Operate the rotary filter press and produce a drum of sludge.
- Day 6: Analyze analytical data.
- Day 7: Prepare written surrogate test report.

Following completion of the test, the surrogate water will be stored in the 75,000-gal. influent tank, blended with low-level influent to the RLWTF, treated, and discharged to the mechanical evaporator system (MES). There will not be a release of the surrogate liquid, or any other liquid, through the RLWTF permitted outfall 051.

Please contact Patty Vardaro-Charles at (505) 665-4644 or Michael T. Saladen at (505) 665-6085 of the Environmental Compliance Programs (EPC-CP) Group if you have questions.

Sincerely,



Taunia Van Valkenburg
Group Leader

TVV:MTS:PVC:kr

Ms. Nancy Williams
EPC-DO: 18-202

- 3 -

Cy: Shelly Lemon, NMED/SWQB, Santa Fe, NM, (E-File)
Erin Trujillo, NMED/SWQB, Santa Fe, NM, (E-File)
Jody M. Pugh, NA-LA, (E-File)
Karen E. Armijo, NA-LA, (E-File)
Darlene Rodriguez, NA-LA, (E-File)
Craig S. Leasure, PADOPS, (E-File)
William R. Mairson, ADESH, (E-File)
Enrique Torres, EPC-DO, (E-File)
Denise C. Gelston, TA-55-RLW, (E-File)
Alvin M. Aragon, TA-55-RLW, (E-File)
John C. Del Signore, TA-55-RLW, (E-File)
Vincent P. Worland, TA-55-RLW, (E-File)
Randal S. Johnson, DESHF-TA55, (E-File)
Michael T. Saladen, EPC-CP, (E-File)
Patricia A. Vardaro-Charles, (E-File)
Ellena I. Martinez, EPC-CP, (E-File)
adesh-records@lanl.gov, (E-File)
locatsteam@lanl.gov, U1700075, (E-File)
epc-correspondence@lanl.gov, (E-File)

ENCLOSURE 1

Surrogate Test Water Quality Parameters

EPC-DO: 18-202

LA-UR-18-23962

Date: MAY 22 2018

EPC-DO-18-202

ENCLOSURE 1

LA-UR-18-23962

SURROGATE TEST WATER QUALITY PARAMETERS

Fifteen non-radioactive water quality parameters will be monitored during the surrogate test. The criteria for success of the surrogate test will be judged by determining both the overall removal of constituents by the entire process and by determining of the removal of constituents by each of the TA-50-LLW treatment units. The pH of the solutions will be monitored; it is not a parameter that is removed by treatment.

Cerium and Samarium will serve as non-radioactive surrogate constituents for Plutonium and Americium; Neodymium will serve as a non-radioactive surrogate for Uranium.

The fifteen water quality parameters are listed below:

1. pH
2. Nitrate-Nitrogen, $\text{NO}_3\text{-N}$
3. Nitrite-Nitrogen, $\text{NO}_2\text{-N}$
4. Ammonia-Nitrogen, $\text{NH}_3\text{-N}$
5. Perchlorate, ClO_4
6. Fluoride, F
7. Copper, Cu
8. Zinc, Zn
9. Silica, SiO_2
10. Total Dissolved Solids, TDS
11. Total Suspended Solids, TSS
12. Chemical Oxygen Demand, COD
13. Cerium, Ce
14. Samarium, Sm
15. Neodymium, Nd

[This page is intentionally left blank.]



Environmental Protection & Compliance Division

Los Alamos National Laboratory
P.O. Box 1663, LANL MS K490
Los Alamos, New Mexico 87545
(505) 667-0666



National Nuclear Security Administration

Los Alamos Field Office
3747 West Jemez Road, LANL MS A316
Los Alamos, New Mexico 87545
(505) 667-5948/FAX (505) 606-2132

Date: **SEP 26 2018**

Symbol: EPC-DO: 18-326

LA-UR: 18-28868

Locates Action No.: N/A

Ms. Nancy Williams
U.S. Environmental Protection Agency (EPA), Region 6
Compliance Assurance and Enforcement Division
Water Enforcement Branch (6EN)
1445 Ross Avenue, Suite 1200
Dallas, Texas 75202-2733

Subject: NPDES Permit No. NM0028355, Notification of Change Condition, TA-16 High Explosive Wastewater Treatment Facility (HEWTF), Outfall 05A055

Dear Ms. Williams:

The National Pollutant Discharge Elimination System (NPDES) Permit No. NM0028355 for the National Nuclear Security Administration and Los Alamos National Security, LLC (NNSA/LANS) requires the permittee(s) to notify the U. S. Environmental Protection Agency (EPA) regarding any physical alterations or additions to the permitted facility that could significantly change the nature or increase the quantity of pollutants discharged (see Part III.D.1.a. Reporting Requirements).

The HEWTF is used to treat high explosives (HE) contaminated wastewater, storm water, and cooling tower blowdown that is collected in a pumper truck from various sumps, tanks, and facilities at TA-9, 11, and 16. Trucked wastewater is discharged to one of two sand filters where it is filtered and collected in a storage tank. The HEWTF is a batch treatment process that pumps filtered wastewater from the storage tank through cartridge filters to an equalization tank; circulated through granular activated carbon (GAC) tanks and ion exchange columns; and is stored in post treatment tanks. The treatment process is designed to circulate the wastewater through the process multiple times prior to pumping it to an electric evaporator or discharging to the permitted Outfall 05A055. Since November of 2007, the HEWTF has used the electric evaporator and not discharged through the permitted outfall. The permittees will continue to use the evaporator except under abnormal conditions.

Ms. Nancy Williams
EPC-DO: 18-326

2

The purpose of this letter is to notify the EPA that the permittees may choose to bypass the GAC tanks and/or ion exchange columns during the treatment of wastewater prior to its discharge to the evaporator. An updated process schematic is provided in Enclosure 1. The permittees will continue to treat wastewater through both the GAC tanks and ion exchange columns should a discharge to the environment using Outfall 05A055 be required. Therefore, this clarification regarding the use of the treatment equipment will not affect the effluent quality or quantity when discharging through Outfall 05A055.

Please contact Patricia Vardaro-Charles at (505) 665-4644 of the Environmental Protection and Compliance Division, Compliance Programs (EPC-CP) or Karen Armijo of the National Nuclear Security Administration, Los Alamos Field office at (505) 665-7314 if you have questions.

Sincerely,

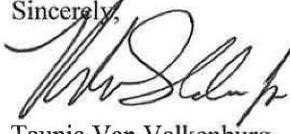

Taunia Van Valkenburg
Group Leader

Sincerely,



Karen E. Armijo
Permitting and Compliance Program Manager

TVV/KEA/MTS/PVC:jdm

Enclosure: 1) NPDES Permit No. NM0028355, Notice of Change at the High Explosives Wastewater Treatment Facility (HEWTF), Outfall 05A055 - Schematic

Copy: Nancy Williams, EPA Region 6, (Hard + E-File)
Sarah Holcomb, NMED/SWQB (E-File)
Shelly Lemon, NMED/SWQB, (E-File)
Karen E. Armijo, NA-LA, (E-File)
Carol Brown, NA-LA, (E-File)
Craig S. Leasure, PADOPS, (E-File)
William R. Mairson, ADESH, (E-File)
Enrique Torres, EPC-DO, (E-File)
Bob Lechel, DESHF-WFO, (E-File)
Kelkenny Baleen, DESHF-WFO, (E-File)
Darren Hanson, J8, (E-File)
Taunia Van Valkenburg, EPC-CP, (E-File)
Michael T. Saladen, EPC-CP, (E-File)
Patricia A. Vardaro-Charles, (E-File)
Jennifer Griffin, (E-File)
adesh-records@lanl.gov, (E-File)
locatesteam@lanl.gov, (E-File)
epc-correspondence@lanl.gov, (E-File)

ENCLOSURE 1

NPDES Permit No. NM0028355, Notice of Change at
the High Explosives Wastewater Treatment Facility
(HEWTF), Outfall 05A055 - Schematic

EPC-DO: 18-326

LA-UR-18-28868

Date: SEP 26 2018

Process Schematic for the High Explosives Wastewater Treatment Facility (HEWTF), TA-16-1508

NOTICE OF CHANGED CONDITION
August 2018

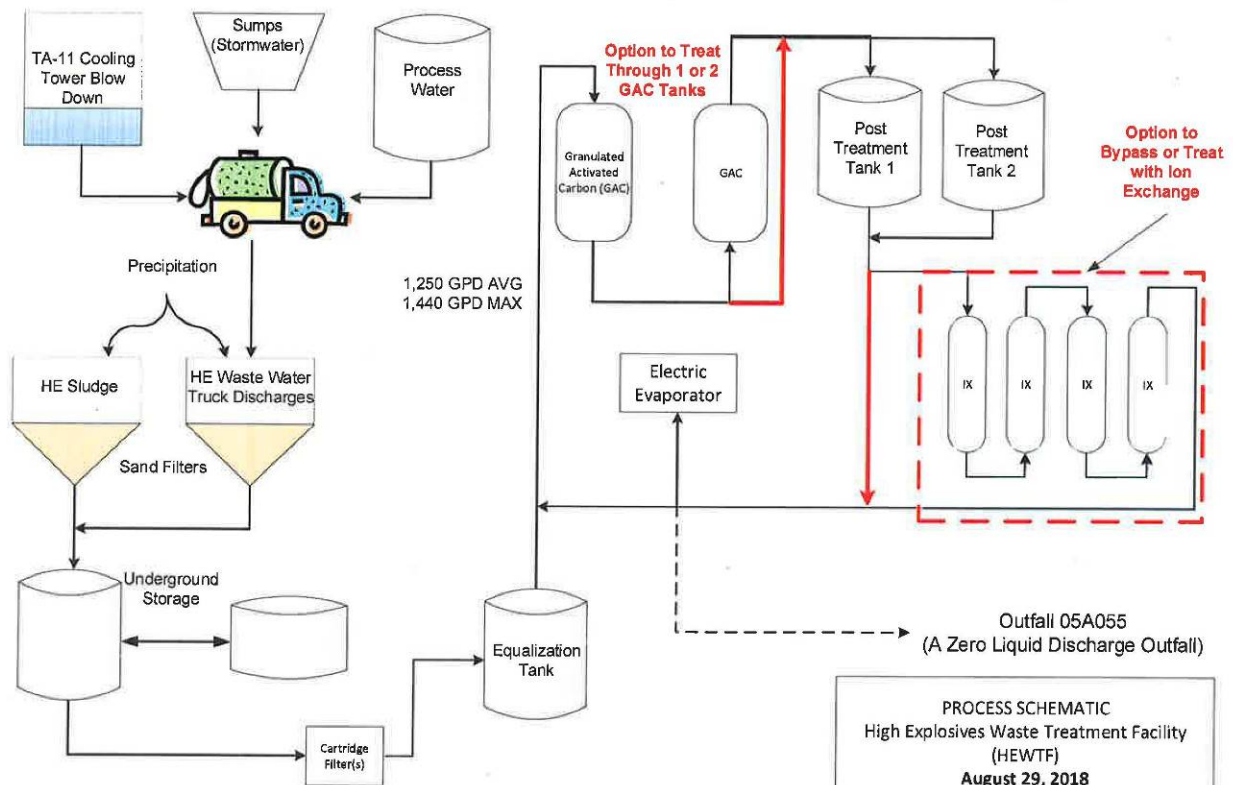

NOTE 1: Operators have the capability to route water for treatment through granulated activated carbon (GAC) filters and/or ion exchange as needed to meet the feed requirements to the evaporator or discharge requirements to Outfall 05A055.

NOTE 2: Operators have the capability to evaporate effluent or discharge to Outfall 05A055.

PROCESS SCHEMATIC
High Explosives Waste Treatment Facility
(HEWTF)
August 29, 2018
2012 NPDES Permit Re-Application
OUTFALL 05A055



*Environmental Protection & Compliance
Division*

Los Alamos National Laboratory
PO Box 1663, K490
Los Alamos, NM 87545
505-667-0666

Symbol: EPC-DO: 19-032

LAUR: 19-20785

Date: FEB 05 2019

Ms. Nancy Williams
U.S. Environmental Protection Agency, Region 6
Compliance Assurance and Enforcement Division
Water Enforcement Branch (6EN)
1445 Ross Avenue, Suite 1200
Dallas, TX 75202-2733

Subject: **Los Alamos National Laboratory, National Pollutant Discharge Elimination System, Permit No. NM0028355, Notice of Planned Change for the Sanitary Effluent Reclamation Facility**

Dear Ms. Williams:

The National Pollutant Discharge Elimination System (NPDES) Permit No. NM0028355 for the Nuclear Security Administration (NNSA) and Triad National Security, LLC (Triad) requires the permittee(s) to notify the U. S. Environmental Protection Agency (EPA) of any physical alterations or additions to a permitted facility that could significantly change the nature or increase the quantity of pollutants discharged (see Part III.D.1.a. Report Requirements). This notice of change was written to notify about a change at the Sanitary Effluent Reclamation Facility (SERF). SERF must pump wastewater from the evaporation basins and properly dispose of it off-site due to capacity issues. Several major snow events in December 2018 and January 2019 in the Los Alamos area resulted in snowfall amounts of 40 inches, which is affecting the storage capacity within the basins.

To ensure storage capacity is not exceeded, the facility plans to pump and ship approximately 300,000 gallons of non-hazardous wastewater to a facility in Arizona, Liquid Environmental Solutions (LES), for disposal over the next several months. The SERF facility is reserving the right to ship additional wastewater offsite in the future that cannot be evaporated due to natural phenomena such as high precipitation events or other factors such as maintenance.

Please contact Patricia Vardaro-Charles at (505) 665-4644 or Michael T. Saladen at (505) 665-6085 of the Environmental Compliance Programs Group (EPC-CP) if you have questions.

EPC-DO: 19-032
Ms. Nancy Williams

FEB 05 2019

Page 2

Sincerely,



Taunia S. Van Valkenburg
Group Leader

TVV/MTS/PVC:jdm

Copy: Sarah Holcomb, NMED/SWQB, sarah.Holcomb@state.nm.us (Hard copy, E-File)
Shelly Lemon, NMED/SWQB, Shelly.Lemon@state.nm.us (E-File)
Erin Shea, NMED/SWQB, erin.shea@state.nm.us (E-File)
Michelle Hunter, NMED/GWQB, michelle.hunter@state.nm.us (E-File)
Karen E. Armijo, NA-LA, Karen.armijo@nnsa.doe.gov (E-File)
Michael W. Hazen, mhazen@lanl.gov (E-File)
William R. Mairson, wmarison@lanl.gov (E-File)
Enrique Torres, EPC-DO, etorres@lanl.gov (E-File)
Taunia S. Van Valkenburg, EPC-CP, tauniav@lanl.gov (E-File)
Michael T. Saladen, EPC-CP, saladen@lanl.gov (E-File)
Patricia Vardaro-Charles, EPC-CP, vardaro@lanl.gov (E-File)
Andrew Erickson, UI-DO, erickson@lanl.gov (E-File)
Lawrence Chavez, UI-OPS, lvchavez@lanl.gov (E-File)
William Foley, EPC-CP, bfoley@lanl.gov (E-File)
locatesteam@lanl.gov (E-File)
epc-correspondence@lanl.gov (E-File)
adesh-records@lanl.gov (E-File)



*Environmental Protection & Compliance
Division*

Los Alamos National Laboratory
PO Box 1663, K490
Los Alamos, NM 87545
505-667-0666

Symbol: EPC-DO: 19-056
LAUR: 19-21477
Date: **FEB 22 2019**

Ms. Nancy Williams
U.S. Environmental Protection Agency, Region 6
Compliance Assurance and Enforcement Division
Water Enforcement Branch (6EN)
1445 Ross Avenue, Suite 1200
Dallas, TX 75202-2733

Subject: Los Alamos National Laboratory, National Pollutant Discharge Elimination System, Permit No. NM0028355, Notice of Planned Change to Reroute the Reverse Osmosis Reject to the Sanitary Waste Water System (SWWS)

Dear Ms. Williams:

The National Pollutant Discharge Elimination System (NPDES) Permit No. NM0028355 for the Nuclear Security Administration (NNSA) and Triad National Security, LLC (Triad) requires the permittee(s) to notify the U. S. Environmental Protection Agency (EPA) of any physical alterations or additions to a permitted facility that could significantly change the nature or increase the quantity of pollutants discharged (see Part III.D.1.a. Report Requirements).

This notice of change discusses a modification at the Sanitary Effluent Reclamation Facility (SERF) that will allow for reverse osmosis (RO) reject wastewater to be discharged to the SERF evaporation basins and/or to the head-works of the Sanitary Waste Water System (SWWS). This change potentially impacts both Outfall 001 and Outfall 13S.

Attached for your review is a revised process schematic for SERF that shows the revised flow pathway for RO reject to SWWS (Attachment 1). This change is necessary to support ongoing operations at SERF, which are currently limited due to the volume of water in the evaporation basins. The water volume in the basins has been impacted by abnormally high precipitation received during the months of December 2018 through February 2019 (approximately 4 inches of rain and over 3.5 feet of snow, and more precipitation is forecasted over the next few days).

EPC-DO: 19-056
Ms. Nancy Williams

FEB 22 2019

Page 2

To ensure that the volume is maintained within permitted and/or design limits, operations personnel at the SERF will implement the following actions:

- Continue to pump and ship approximately 300,000 gallons of non-hazardous wastewater to Liquid Environmental Solutions (LES) in Arizona
- Reroute the RO reject to SWWS. The estimated maximum volume would be 10,000 gallons per day or approximately 10% of the SWWS influent
- Redistribute water between the five SERF basins to maintain the required freeboard
- Continue to use mechanical aerators to enhance the evaporation rate as temperature and weather conditions permit

Please contact Patricia Vardaro-Charles at (505) 665-4644 or Michael T. Saladen at (505) 665-6085 of the Environmental Compliance Programs Group (EPC-CP) if you have questions.

Sincerely,



Taunia S. Van Valkenburg
Group Leader

TVV/MTS/PVC:jdm

Attachment(s): Attachment 1 NPDES Permit No. NM0028355, SERF Process Schematic Showing the RO Reject Reroute to SWWS

Copy: Sarah Holcomb, NMED/SWQB, sarah.Holcomb@state.nm.us (Hard copy, E-File)
Shelly Lemon, NMED/SWQB, Shelly.Lemon@state.nm.us (E-File)
Erin Shea, NMED/SWQB, erin.shea@state.nm.us (E-File)
Michelle Hunter, NMED/GWQB, michelle.hunter@state.nm.us (E-File)
Karen E. Armijo, NA-LA, Karen.armijo@nnsa.doe.gov (E-File)
Michael W. Hazen, mhazen@lanl.gov (E-File)
William R. Mairson, wmarison@lanl.gov (E-File)
Enrique Torres, EPC-DO, etorres@lanl.gov (E-File)
Taunia S. Van Valkenburg, EPC-CP, tauniav@lanl.gov (E-File)
Michael T. Saladen, EPC-CP, saladen@lanl.gov (E-File)
Patricia Vardaro-Charles, EPC-CP, vardaro@lanl.gov (E-File)
Andrew Erickson, UI-DO, erickson@lanl.gov (E-File)
Christopher Booton, UI-SERF, cbooton@lanl.gov (E-File)

EPC-DO: 19-056
Ms. Nancy Williams

FEB 22 2019

Page 3

Randy Vigil, revigil@lanl.gov, (E-File)
Lawrence Chavez, UI-OPS, lvchavez@lanl.gov, (E-File)
William Foley, EPC-CP, bfoley@lanl.gov, (E-File)
locatsteam@lanl.gov, (E-File)
epc-correspondence@lanl.gov, (E-File)
adesh-records@lanl.gov, (E-File)

ATTACHMENT 1

NPDES Permit No. NM0028355, SERF
Process Schematic Showing the RO Reject
Reroute to SWWS

EPC-DO: 19-056

LAUR-19-21477

Date: FEB 22 2019

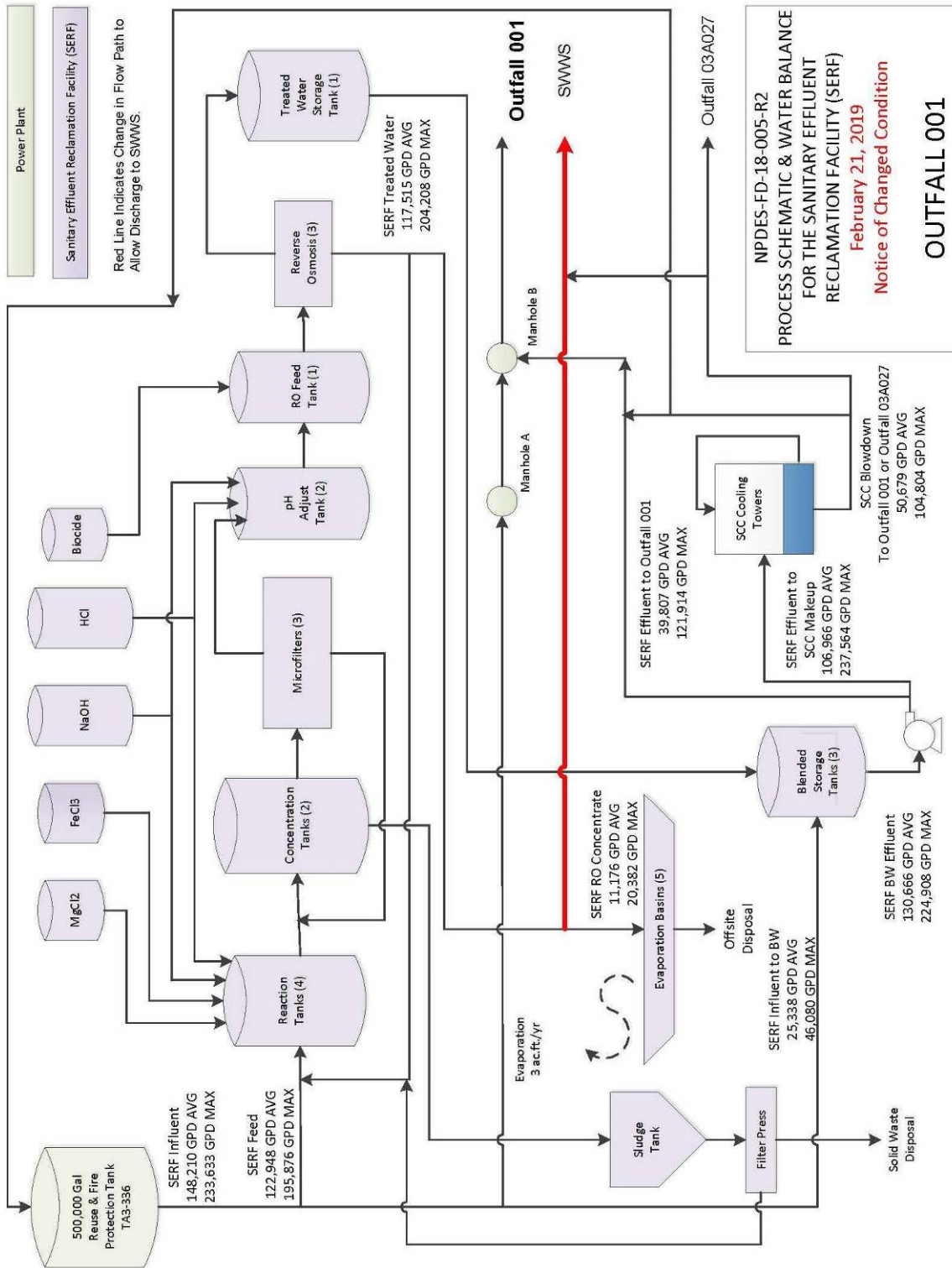

APPENDIX I

LA-UR-18-20700, EP2018-0036, Surface Water Data at Los Alamos National Laboratory, Water Year 2014

[This page is intentionally left blank.]

ESHID-602877

LA-UR-18-20700
February 2018
EP2018-0036

Surface Water Data at Los Alamos National Laboratory, Water Year 2014

Prepared by the Associate Directorate for Environmental Management

Los Alamos National Laboratory, operated by Los Alamos National Security, LLC, for the U.S. Department of Energy (DOE) under Contract No. DE-AC52-06NA253 and under DOE Office of Environmental Management Contract No. DE-EM0003528, has prepared this document. The public may copy and use this document without charge, provided that this notice and any statement of authorship are reproduced on all copies.

CONTENTS

INTRODUCTION.....	1
Qualifiers	1
STREAM DISCHARGE GAGE STATIONS	3
Station Identification Numbers	3
Data Collection and Computation.....	3
Accuracy of Records	4
Data Presentation.....	4
Los Alamos/Pueblo Watershed.....	7
E026 Los Alamos Canyon below Ice Rink.....	9
E030 Los Alamos Canyon above DP Canyon.....	12
E038 DP Canyon above TA-21	15
E039.1 DP Canyon below Grade Control Structure	18
E040 DP Canyon above Los Alamos Canyon.....	21
E042.1 Los Alamos above Low Head Weir.....	24
E050.1 Los Alamos Canyon below Low Head Weir.....	27
E055 Pueblo Canyon above Acid Canyon	30
E055.5 South Fork of Acid Canyon	33
E056 Acid Canyon above Pueblo Canyon	36
E059.5 Pueblo Canyon below LAC WWTF.....	39
E060.1 Pueblo Canyon below Grade Control Structure.....	42
Sandia Watershed.....	45
E121 Sandia Canyon Right Fork at Power Plant.....	46
E122 Sandia Canyon near Roads and Grounds at TA-3	49
E123 Sandia Canyon below Wetlands	52
E124 Sandia above Firing Range.....	55
E125 Sandia Canyon above SR 4.....	58
Mortandad Watershed.....	61
E201 Mortandad Canyon above Ten Site Canyon.....	62
E201.5 Ten Site Canyon above Mortandad Canyon.....	65
E204 Mortandad Canyon at LANL Boundary	68
E229.3 Cañada del Buey at SR-4	71
Pajarito Watershed.....	74
E240 Pajarito Canyon below SR 501	75
E245.5 Pajarito Canyon above Three Mile Canyon	78
E246 Three Mile Canyon above Pajarito Canyon	81
E250 Pajarito Canyon above SR 4.....	84
Water/Cañon de Valle Watershed.....	87
E252 Water Canyon above SR 501	89
E253 Cañon de Valle above SR 501	92
E256 Cañon de Valle below MDA P.....	95
E265 Water Canyon below SR 4.....	98
E267 Potrillo Canyon above SR 4.....	101
Ancho/Chaquehui Watershed	104
E275 Ancho Canyon below SR 4	105
E338 Chaquehui at TA-33.....	108
E340 Chaquehui Tributary at TA-33.....	111

Surface Water Data, Water Year 2014

PRECIPITATION GAGE STATIONS	114
Data Collection and Computation.....	114
Accuracy of Records	114
Data Presentation.....	114
Extended Precipitation Network.....	115
E038 DP Canyon above TA-21	116
E042.1 Los Alamos above Low Head Weir.....	119
R055.5 South Fork of Acid Canyon	121
E121.9 Sandia Canyon East of Power Plant.....	123
E200.5 Mortandad Canyon Tributary Batch Plant at Sigma.....	125
E203 Mortandad Canyon below Sediment Traps.....	127
E240 Pajarito Canyon below SR 501	129
E245.5 Pajarito Canyon above Three Mile Canyon	131
E253 Cañon de Valle above SR 501	133
E257 Cañon de Valle Tributary at TA-16 Burn Grounds	135
E262.4 PHERMEX.....	137
E265 Water Canyon below SR 4.....	139
E267.4 TA-36 Minie Site.....	141
E340 Chaquehui Tributary at TA-33.....	143
Meteorological Tower Data	145
TA-06 Meteorological Tower	146
TA-49 Meteorological Tower	148
TA-53 Meteorological Tower	150
TA-54 White Rock Meteorological Tower	152
North Community Meteorological Tower	154
REFERENCES.....	156
ABBREVIATIONS, ACRONYMS, AND GLOSSARY	156

Figures

Figure 1	Location of watersheds, canyons, streams, stream gages, and rain gages on LANL property	2
Figure 2	The total monthly volume (acre-ft) for WY2014 for Los Alamos Canyon and DP Canyon.....	8
Figure 3	The total monthly volume (acre-ft) for WY2014 for Acid Canyon and Pueblo Canyon.....	8
Figure 4	The total monthly volume (acre-ft) for WY2014 for Sandia Canyon	45
Figure 5	Total monthly volume (acre-ft) for WY2014 in Mortandad Canyon and Cañada del Buey	61
Figure 6	Total monthly volume (acre-ft) for WY2014 for Pajarito Canyon	74
Figure 7	Total monthly volume (acre-ft) for WY2014 in Water Canyon, Cañon de Valle, and Fence Canyon.....	88

Surface Water Data, Water Year 2014

Figure 8	Total monthly volume (acre-ft) for WY2014 in Ancho Canyon and Chaquehui Canyon.....	104
Figure 9	Total monthly precipitation for the extended precipitation network gages for WY2014, excluding December 2013 to March 2014, when the gages were shut down for winter.....	116
Figure 10	The total monthly precipitation for the meteorological towers for WY2014.....	145

INTRODUCTION

The annual water data report from Los Alamos National Laboratory (LANL) contains flow data from 34 stream gage stations and precipitation data from the extended network, meteorological observation stations, and precipitation emergency notification stations that cover most of LANL's property (see Figure 1). Data are collected from LANL's upper boundary, approximated by NM 501, to the lower boundary, approximated by NM 4. Gage station data are used to support the monitoring of Los Alamos/Pueblo Canyons under the March 2005 Compliance Order on Consent, the Buckman Direct Diversion Emergency Notification System, monitoring of Sandia Canyon for wetland stabilization, LANL's Environmental Surveillance Program, and activities directed by the Water Canyon/Cañon de Valle investigation report. Precipitation gage station data support all the programs that the stream discharge gage stations support as well as the Multi-Sector General Permit.

Los Alamos, New Mexico, has a semiarid climate with an average rainfall of about 19 in. per year. Over 30% of the area is dominated by ponderosa pine stands at higher elevations that transition to piñon-juniper woodlands as elevation decreases. The Pajarito Plateau is separated into fingerlike mesas by west-to-east-oriented canyons. The majority of the stream discharge gage stations are located within ephemeral streams. These streams flow briefly in response to precipitation that occurs in the surrounding area or snowmelt runoff from higher elevations. The remainder of the year, the streams are dry with no flow. Perennial springs are present on the flanks of the Jemez Mountains and supply base flow to the upper reaches of some canyons, but the volume of flow is insufficient to maintain surface flows across the facility mostly because of losses in stream channel transmission. The remainder of the stream gage stations are located in either intermittent or perennial streams.

Qualifiers

Raw data are qualified using a standard set of numbers to better determine the quality of the data. Qualifiers are noted within the daily peak discharge tables with a letter or letters. Unless otherwise noted, the data are qualified as good continuous records. Some of the data were reliably estimated. Data are reliably estimated during short periods of time using precipitation data to verify no precipitation and/or, when applicable, upstream or downstream stream-gage data.

Qualifier Description	Qualifier	Comments
Missing data	M	Data were missing for an unknown or inexplicable reason.
Ice	I	Ice was present.
Testing	T	Field crews were present on-site and tested the equipment.
Equipment malfunction	E	Equipment failure occurred or equipment was rendered inoperable by high-flow event.
Silting and scouring	SS	A datum shift was applied because of silting or scouring.
Datum shift	DS	A datum shift was applied to the data.
Inactive	IA	The gage was inactive because of an event that damaged the station beyond immediate repair.
Snow	S	Precipitation as snow.

Surface Water Data, Water Year 2014

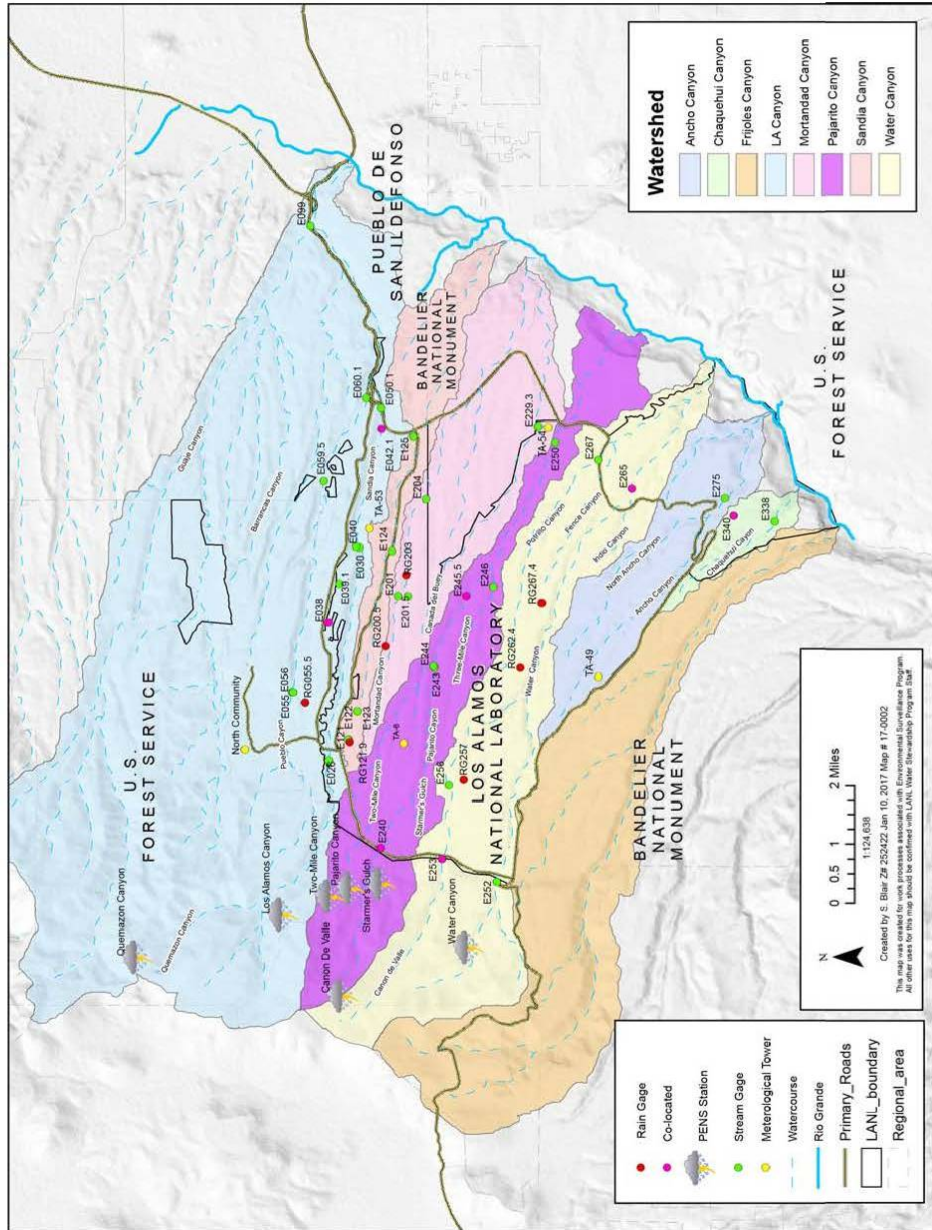

Figure 1 Location of watersheds, canyons, streams, stream gages, and rain gages on LANL property

STREAM DISCHARGE GAGE STATIONS

Station Identification Numbers

The U.S. Geological Survey (USGS), Water Resources Division, assigns a unique identification number to each stream gage station it establishes. All sites numbered since 1950 are part of the downstream order system. In this report, the station numbers increase from upstream to downstream.

This report adheres to the USGS convention of downstream order system. Because of the proximity of stations in this network, the first five digits of all station numbers are 08313. This five-digit number string is replaced with the letter E in the station number as an abbreviation.

Data Collection and Computation

A complete record at a gage station includes stage and discharge measurements from a stream or channel, directly observed factors that affect the stage/discharge relationship, and weather records. Integrated 5-min records of stage were provided from a data logger or direct readings were collected and verified on-site. Discharge is measured using meters and methods adopted by the USGS. The methods can be found in the USGS Technique of Water Resources Investigations, Book 3 (Carter and Davidian 1968), Chapter A6; and the USGS Water Supply Paper 2175 (Rantz 1982).

Rating curves were developed using the stage-discharge relationship curve determined from measured stage and the corresponding discharge. When it is necessary to define the discharge extremes outside the range for current meter measurements, the curve is extended using logarithmic plotting; velocity area studies; results of indirect measurements of peak discharge, such as slope area or contracted opening measurements, and computations of flow over dams or weirs; or step-backwater techniques.

Daily peak discharge is computed by applying daily peak gage height (stage) to the stage discharge curves or tables. If the stage-discharge relationship is subject to change because of frequent or continual change in the physical features that form the control, the daily peak discharge is computed by the shifting-control method. In the shifting-control method, correction factors based on individual discharge measurements and notes by personnel taking the measurements are applied to the gage heights before discharges are determined from the curves or tables. Occasionally, during high-magnitude events, the gage equipment will not capture the peak gage height. In such cases, when a visual high-water mark has been observed, the peak gage height is estimated.

The shifting-control method is also used if the stage-discharge relationship for a station is temporarily changed by natural vegetation, aggradation and degradation or debris, and sediment accumulation on the control. At some canyon bottom, northern, and perennial stream gage stations, the stage-discharge relationship is affected by ice in the winter and it is not possible to compute discharge. Temperature data, precipitation data, and discharge records from nearby stations are used to estimate discharge during these periods.

For some gage stations, periods occur when no gage height record is obtained or the recorded gage height is so faulty that it cannot be used to compute daily discharge or contents. This occurs when the data logger stops recording or otherwise fails to operate properly. For such periods, the daily discharge is estimated on the basis of recorded range-in-stage, previous and subsequent records, discharge measurements, weather records, and record comparisons made against other stations in the same or nearby basins.

Surface Water Data, Water Year 2014

Accuracy of Records

The following two factors determine the accuracy of stream discharge records:

- Stability of the stage-discharge relationship or, if the control is unstable, the frequency of discharge measurements
- Accuracy of measurements of stage, accuracy of discharge measurements, and interpretations of records

The number of significant figures used to report daily peak discharge is based solely on the magnitude of the discharge value. The same method is applied to the monthly summary table in acre-ft per year:

If the value (ft ³ /s) is	Then it is reported as
less than 1 ft ³ /s	nearest hundredth
1–10 ft ³ /s	nearest tenth
10–1000 ft ³ /s	whole number
above 1000 ft ³ /s	three significant figures

Data Presentation

The records published in this report consist of three parts for each stream discharge gage station:

- Station analysis summary
- Station manuscript description with photo
- Data table for the water year (October 1, 2013, to September 30, 2014)

The station analysis supplements each daily values table and includes a description of monitoring equipment, problems associated with data collection during the water year, and other information used to compute stream flow discharge.

Equipment: A description of the monitoring equipment is provided.

Fieldwork: The fieldwork completed for each stream gage is shown in a table. Inspection site visits and maintenance site visits are tabulated for the stream gage and for the ISCO samplers present at the site.

Datum Correction: Datum corrections for the period of record are listed.

Gage-Height Record: Information is provided regarding the stage record itself, including accuracy and periods of inoperability.

The station manuscript provides data under various headings: station location, drainage area, revised records, period of record, gage, average volume, and other points pertinent to station operation and regulation. Each continuous record of discharge includes the following categories of descriptions.

Rating: A description of the rating used to calculate discharge at the stream gage site.

Location: The most accurate and available maps, coupled with the light detection and ranging digital elevation model (LIDAR DEM) using North American Datum of 1983 (NAD 83), provide location information.

Surface Water Data, Water Year 2014

Drainage Area: The most accurate and available maps provide drainage area measurements. The accuracy of drainage area measurements varies, depending on the type of map available for this purpose.

Revised Records: Because of new information, published records occasionally are found to be incorrect, and revisions are printed in later reports. If the record has been revised, the report in which the most recently revised figure was first published is given.

Period of Record: The period of record is the time during which published records exist for a station or its equivalent station. An equivalent station is one that was in operation when the present station was not in operation and was located so that its records can reasonably be considered equivalent to records from the present station.

Gage: This section describes the type of gage in current use. Under this heading, the datum of the current gage referred to in the National Geodetic Vertical Datum of 1929 (NGVD 29) (see Abbreviations, Acronyms, and Glossary) is a condensed history of the types, locations, and data of previous gages.

Average Volume: The average volume is the average of the annual discharged volume beginning in the 2012 water year (WY2012).

Maximum Discharge for Period of Record: The record includes the maximum stage and discharge. Unless otherwise qualified, the maximum discharge or content is the instantaneous maximum corresponding to the highest stage that occurred. The highest stage may have been obtained from a graphic or digital recorder, a crest-stage gage, by direct observation of a non-recording gage or high-water-mark surveys. The minimum stage and discharge are included for perennial streams.

If the maximum stage did not occur on the same day as the maximum discharge or content, it is given separately. Maximum discharge before WY2010 should be considered estimated because of differences in the current validation and verification methodology.

Maximum Discharge for Current Water Year: Maximums given are similar to those for the period of record. The time for occurrence of peaks is expressed in 24-h local standard time. For example, 12:30 A.M. is 0030 and 1:30 P.M. is 1330. The minimums for perennial streams are recorded in a similar manner as the maximums.

The daily table of discharge records for stream discharge gage stations gives the daily peak discharge for each day of the water year. In the monthly summary for the table, the row titled "Total Volume (acre-ft)" contains the sum of the daily figures of volume for each month in acre-feet, the row titled "Max Daily Peak (acre-ft)" contains the maximum daily volume for the month in acre-feet, the row titled "Min Daily Peak (acre-ft)" contains the minimum daily volume for the month in acre-feet, and the row titled "Missing Days" contains the number of days missing for each month.

Surface Water Data, Water Year 2014

Summary of Discharges from Stream Monitoring Stations for WY2014

Canyon Sites	Estimated Days with Flow	Total Volume (acre-ft)	Instantaneous Maximum Discharge (ft ³ /s)
E026 Los Alamos Canyon below Ice Rink ^a	35 ^a	7.3 ^a	54 ^a
E030 Los Alamos Canyon above DP Canyon	25	29	292
E038 DP Canyon above TA-21	52	46	270
E039.1 DP Canyon below Grade Control Structure	240	117	317
E040 DP Canyon above Los Alamos Canyon ^a	28 ^a	52.7 ^a	268 ^a
E042.1 Los Alamos above Low Head Weir ^a	23 ^a	91.9 ^a	210 ^a
E050.1 Los Alamos Canyon below Low Head Weir	32	67	214
E055 Pueblo Canyon above Acid Canyon	37	16.7	71
E055.5 South Fork of Acid Canyon	33	1.6	16
E056 Acid Canyon above Pueblo Canyon	101	11.7	45
E059.5 Pueblo Canyon below WWTF ^a	98 ^a	52 ^a	97 ^a
E060.1 Pueblo Canyon below Grade Control Structure	23	27	54
E121 Sandia Canyon Right Fork at Power Plant	364	191	66
E122 Sandia Canyon Left Fork at Asphalt Plant	365	53.8	19
E123 Sandia Canyon below Wetlands	331	702	109
E124 Sandia above Firing Range ^a	2 ^a	1.1 ^a	50 ^a
E125 Sandia Canyon above SR 4	22	4.5	58
E201 Mortandad Canyon above Ten Site Canyon	8	9.43	93
E201.5 Ten Site Canyon above Mortandad Canyon	7	19.1	105
E204 Mortandad Canyon at LANL Boundary	10	0.40	6.5
E229.3 Cañada del Buey at SR-4	11	0.71	11
E240 Pajarito Canyon below SR 501	10	6.5	141
E245.5 Pajarito Canyon above Three Mile Canyon	26	250	424
E246 Three Mile Canyon above Pajarito Canyon ^a	3 ^a	0.87 ^a	5.4 ^a
E250 Pajarito Canyon above SR 4	n/a ^b	n/a	n/a
E252 Water Canyon above SR 501 ^a	21 ^a	7.97 ^a	21 ^a
E253 Cañon de Valle above SR 501 ^a	0 ^a	0 ^a	0 ^a
E256 Cañon de Valle below MDA-P ^a	6 ^a	0.01 ^a	0.06 ^a
E265 Water Canyon below SR 4	4	10.4	52
E267 Potrillo Canyon above SR 4 ^a	3 ^a	1.4 ^a	25 ^a
E275 Ancho Canyon below SR 4	6	4	74
E338 Chaquehui at TA-33	7	8.2	179
E340 Chaquehui Tributary at TA-33	1	0.06	4.2

^a This gage was in operation for only part of the water year.

^b n/a = Not applicable. Gage not in operation for water year.

Los Alamos/Pueblo Watershed

The Los Alamos Canyon/Pueblo Canyon watershed is located at the northern end of Los Alamos County and LANL. The watershed heads on U.S. Forest Service land in the Sierra de los Valles to the west and northwest of LANL. The highest point in the watershed is at the summit of Pajarito Mountain at an elevation of 3182 m (10,441 ft). The watershed extends eastward from the headwaters across the Pajarito Plateau for about 30.4 km (18.9 mi) to its confluence with the Rio Grande at an elevation of 1678 m (5504 ft). The Los Alamos/Pueblo watershed encompasses approximately 57 mi². The watershed includes Los Alamos, Pueblo, and DP Canyons. Bayo, Guaje, Rendija, and Barrancas Canyons are tributary canyons in the watershed. The watershed contains numerous springs, perennial and ephemeral stream segments, and alluvial groundwater. Portions of Santa Fe National Forest, U.S. Department of Energy– (DOE-) managed property, Los Alamos County (including the Los Alamos townsite), Santa Fe County, and San Ildefonso Pueblo tribal lands are located within the Los Alamos/Pueblo watershed.

Pueblo Canyon is located on the north side of the Los Alamos townsite and extends from the Jemez Mountains to its confluence with Los Alamos Canyon, approximately 4.5 mi east of the Los Alamos townsite at the intersection of NM 502 and NM 4. Los Alamos Canyon is the southernmost canyon in the watershed. The Los Alamos/Pueblo watershed contains, or may influence, five wetland areas totaling approximately 12.16 acres.

Figure 2 shows the total volume of discharge per month from the upper boundary station in Los Alamos Canyon to the lower boundary stations. As the discharge travels downstream, a considerable amount of transmission loss typically occurs from station to station. During the monsoon season, discharge will not always begin at the upper boundary stations (upper boundary is E026, lower boundary is E050.1) and is highly dependent on the storm track.

Figure 3 shows the total volume of discharge per month from the stream gage discharge stations within Acid and Pueblo Canyons, located within the Los Alamos/Pueblo watershed. Station E055 is the highest station within Acid Canyon and receives the most discharge within this particular section of the watershed. As discharge travels downstream, it is lost via channel transmission. The remainder of the sites within Acid Canyon did not have any discharge. Gage E060.1 is located downstream of the Los Alamos County Waste Water Treatment Facility (WWTF) and the Pueblo Canyon grade-control structure. The treatment facility releases effluent daily. Most of the year, this discharge does not reach E060.1, located 1.71 mi downstream of the WWTF.

Surface Water Data, Water Year 2014

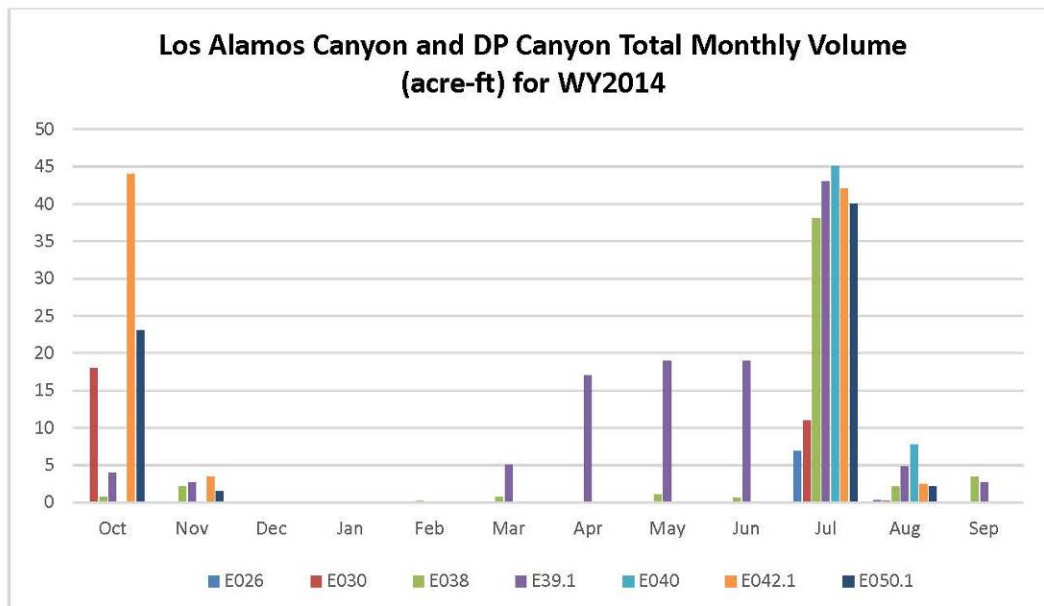

Figure 2 The total monthly volume (acre-ft) for WY2014 for Los Alamos Canyon and DP Canyon

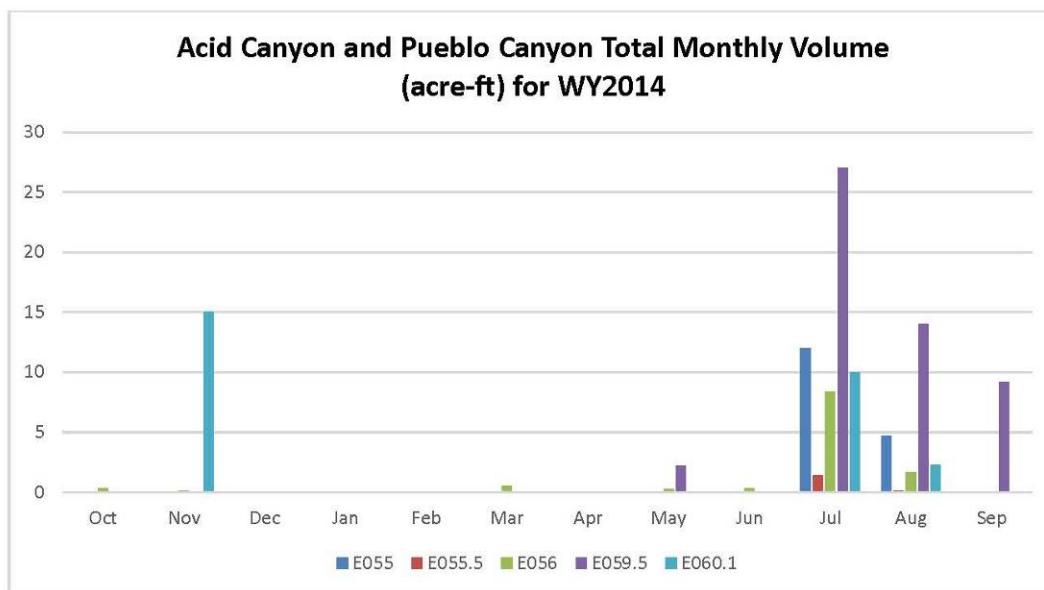

Figure 3 The total monthly volume (acre-ft) for WY2014 for Acid Canyon and Pueblo Canyon

Surface Water Data, Water Year 2014

E026 Los Alamos Canyon below Ice Rink

Location. Lat 35° 52' 49", long -106° 19' 30", NE ¼, Sec. 17, T. 19 N., R. 6 E., Los Alamos County.

Drainage Area. 7.07 mi².

Period of Record. February 26, 2001, to September 30, 2014.

Revised Record. Drainage area (2006); Section (2007).

Gage. Data logger with radio telemetry. Elevation of gage is 7177 ft using LANL LIDAR DEM with NAD 83.

Average Volume. 3 yr, 139 acre-ft/yr.

Maximum Discharge for Period of Record. Maximum discharge, 850 ft³/s, September 13, 2013, maximum gage height exceeded.

Maximum Discharge for Current Water Year. Maximum discharge, 54 ft³/s, July 31, 2014, gage height 1.51 ft.



E026 Stream gage downstream view

Surface Water Data, Water Year 2014

Equipment. The station is equipped with a Sutron 9210 data logger (5-min interval), an MDS 4710 radio transceiver, and a shaft encoder float system. The system is powered by a solar-panel battery system housed in a National Electrical Manufacturers Association (NEMA) shelter on top of a 24-in. corrugated metal pipe (CMP) well. The station is equipped with two ISCO samplers (one 12-count 1-L glass and polyethylene bottle sampler and one 24-count 1-L polyethylene bottle sampler) to collect water-quality samples. The ISCO samplers are housed in a separate 3- × 4-ft metal box. The samplers are triggered by stage through the data logger. An outside staff gage is available for reference. No provision has been made for measurement above the wading stage. All high-flow measurements will be by slope-area or critical-depth computation methods.

Fieldwork

Number of Stream Gage Inspections	Number of Stream Gage Maintenance Visits	Number of ISCO 12-Count Sampler Inspections	Number of ISCO 12-Count Sampler Maintenance Visits	Number of ISCO 24-Count Sampler Inspections	Number of ISCO 24-Count Sampler Maintenance Visits
30	5	19	1	1	1

Datum Correction. Levels run on November 21, 2001, found the gage to be within limits.

Gage-Height Record. The data logger referenced to the inside staff gage gave a complete and satisfactory record, except for October 1, 2013, through January 23, 2014, and August 7, 2014, because of equipment failure.

Rating. The channel at the gage is about 20 ft wide and straight for 20 ft upstream where it bends to the left and then runs straight for about 150 ft downstream. The streambed through this reach is primarily gravel with cobbles. The low-flow control is a rock-and-gravel riffle located 15 ft downstream from the gage. The channel is the control for medium and high stages. The buildup and scour of this control lead to shift changes during the water year.

Rating No. 3 was developed based on measurements made during the period of record.

Flow is partially regulated by the Los Alamos Reservoir about 1.5 mi upstream of the gage and the draining of this reservoir. The gage of reference at this station is the inside reference point (the RP measure). At low and medium flows, the staff plate stage reading will be lower than the stilling well stage reading.

One discharge measurement was made during the year.

Discharge. Discharges were computed from Rating No. 3.

Surface Water Data, Water Year 2014

E026 Daily Peak Discharge (ft³/s)

Day	Oct	Nov	Dec	Jan	Feb	Mar	Apr	May	Jun	Jul	Aug	Sep
1	E*	E	E	E	0	0	0	0	0	0	0.28	0
2	E	E	E	E	0	0	0	0	0	0	0.06	0
3	E	E	E	E	0	0	0	0	0	0	0.05	0.01
4	E	E	E	E	0	0	0	0	0	0	2.6	0
5	E	E	E	E	0	0	0	0	0	0	0.06	0
6	E	E	E	E	0	0	0	0	0	0	0	0
7	E	E	E	E	0	0	0	0	0	14	E	0
8	E	E	E	E	0	0	0	0	0	1.4	5.0	0.01
9	E	E	E	E	0	0	0	0	0	0	0	0
10	E	E	E	E	0	0	0	0	0	0	0	0
11	E	E	E	E	0	0	0	0	0	0	0	0
12	E	E	E	E	0	0	0	0.28	0	0	0	0
13	E	E	E	E	0	0	0	0.07	0	0	0	0
14	E	E	E	E	0	0	0	0.48	0	0	0.07	0
15	E	E	E	E	0	0	0	0.16	0	0	0.07	0
16	E	E	E	E	0	0	0.22	0.28	0	0	0.09	0
17	E	E	E	E	0	0	0	0	0	0	0	0
18	E	E	E	E	0	0	0	0	0	0	0	0
19	E	E	E	E	0	0	0	0	0	0.41	0	0
20	E	E	E	E	0	0	0	0	0	0.02	0	0
21	E	E	E	E	0	0	0	0	0	0	0	0
22	E	E	E	E	0	0	0	0	0	0	0	0
23	E	E	E	E	0	0	0	0	0	0.04	0	0
24	E	E	E	0	0	0	0	0.01	0	0	0	0
25	E	E	E	0	0	0	0	6.4	0	0	0.01	0
26	E	E	E	0	0	0	0	0	0	0	0.01	0
27	E	E	E	0	0	0	0	0	0	0.84	0	0
28	E	E	E	0	0	0	0.05	0	0	0	0	0
29	E	E	E	0		0	0.05	0	0	17	0	0
30	E	E	E	0		0	0	0	0	0.84	0.01	0.01
31	E		E	0		0		0		54	0.01	

* E represents equipment failure.

E026 Monthly Summary Table

	Oct	Nov	Dec	Jan	Feb	Mar	Apr	May	Jun	Jul	Aug	Sep	WY
Total Volume (acre-ft)	E*	E	E	0	0		0.01	0.07	0	6.9	0.33	0	7.3
Max Daily Peak (ft ³ /s)	E	E	E	0	0	0	0.22	6.4	0	54	5.0	0.01	54
Min Daily Peak (ft ³ /s)	E	E	E	0	0	0	0	0	0	0	0	0	0
Missing Days	31	30	31	23	0	0	0	0	0	0	1	0	116

* E represents equipment failure.

Surface Water Data, Water Year 2014

E030 Los Alamos Canyon above DP Canyon

Location. Lat 35° 52' 21", long -106° 15' 36", SW ¼, Sec. 13, T. 19 N., R. 6 E., Los Alamos County.

Drainage Area. 8.57 mi².

Period of Record. July 1994 to September 30, 2014.

Revised Record. Drainage area (2006); Township (2007).

Gage. Data logger with radio telemetry and concrete control. Elevation of gage is 6619 ft using LANL LIDAR DEM with NAD 83.

Average Volume. 3 yr, 65 acre-ft/yr.

Maximum Discharge for Period of Record. Maximum discharge, 970 ft³/s, September 13, 2013, gage height 4.04 ft.

Maximum Discharge for Current Water Year. Maximum discharge, 54 ft³/s, July 31, 2014, gage height 1.5 ft.



E030 Stream gage downstream view

Surface Water Data, Water Year 2014

Equipment. The station is equipped with a Sutron 9210 data logger (5-min interval), an MDS 4710 radio transceiver, and a shaft encoder float system. The system is powered by a solar-panel battery system housed in a NEMA shelter on an 18-in. CMP well on the left bank. The station is equipped with an ISCO pump sampler (12-count 1-L glass or polyethylene bottles) to collect water-quality samples. The ISCO sampler is housed in a separate shelter, a 3- × 4-ft metal box. The sampler is triggered by stage through the data logger. An outside staff gage is available for reference. No provision has been made for direct discharge measurements above the wading stages.

Fieldwork

Number of Stream Gage Inspections	Number of Stream Gage Maintenance Visits	Number of ISCO 12-Count Sampler Inspections	Number of ISCO 12-Count Sampler Maintenance Visits	Number of ISCO 24-Count Sampler Inspections	Number of ISCO 24-Count Sampler Maintenance Visits
27	5	22	1	n/a*	n/a

* n/a = Not applicable.

Datum Correction. None.

Gage-Height Record. The data logger referenced to the outside staff gage gave a complete and satisfactory record for the entire year.

Rating. The streambed is sand and gravel and subject to slight movement during flow events. The channel is straight for 300 ft above the gage and 50 ft below. Vegetation on the bank is sparse grass.

Rating No. 3 was used for the entire water year.

No discharge measurements were made during the year.

Discharge. Discharge was computed using Rating No. 3.

Surface Water Data, Water Year 2014

E030 Daily Peak Discharge (ft³/s)

Day	Oct	Nov	Dec	Jan	Feb	Mar	Apr	May	Jun	Jul	Aug	Sep
1	0.06	0	0	0	0	0	0	0	0	0	0	0
2	4.6	0	0	0	0	0	0	0	0	0	0	0
3	4.6	0	0	0	0	0	0	0	0	0	0	0
4	1.6	0.95	0	0	0	0	0	0	0	0	0.64	0
5	0	0.06	0	0	0	0	0	0	0	0	0	0
6	0	0.03	0	0	0	0	0	0	0	0	0	0
7	0	0.10	0	0	0	0	0	0	0	1.2	0	0
8	0	0	0	0	0	0	0	0	0	3.2	0	0
9	0	0	0	0	0	0	0	0	0	0.01	0	0
10	2.4	0	0	0	0	0	0	0	0	0.01	0	0
11	1.3	0	0	0	0	0	0	0	0	0.01	0	0
12	1.2	0	0	0	0	0	0	0	0	0.01	0	0
13	0	0	0	0	0	0	0	0	0	0.01	0	0
14	0	0	0	0	0	0	0	0	0	0.01	0	0
15	0	0	0	0	0	0	0	0	0	2.9	0	0
16	0.01	0	0	0	0	0	0	0	0	0.01	0	0
17	0	0	0	0	0	0	0	0	0	0	0	0
18	0	0	0	0	0	0	0	0	0	0	0	0
19	0	0	0	0	0	0	0	0	0	0	0	0
20	0	0	0	0	0	0	0	0	0	0	0	0
21	0	0	0	0	0	0	0	0	0	0	0	0
22	0	0	0	0	0	0	0	0	0	0	0	0
23	0	0	0	0	0	0	0	0	0	0	0	0
24	0	0	0	0	0	0	0	0	0	0	0	0
25	0	0	0	0	0	0	0	0	0	0	0	0
26	0	0	0	0	0	0	0	0	0	0	0	0
27	0	0	0	0	0	0	0	0	0	0	0	0
28	0	0	0	0	0	0	0	0	0	0	0	0
29	0	0	0	0		0	0	0	0	23	0	0
30	0	0	0	0		0	0	0	0	0	0	0
31	0		0	0		0		0		292	0	

E030 Monthly Summary Table

	Oct	Nov	Dec	Jan	Feb	Mar	Apr	May	Jun	Jul	Aug	Sep	WY
Total Volume (acre-ft)	18	0.12	0	0	0	0	0	0	0	11	0.16	0	29
Max Daily Peak (ft ³ /s)	4.6	0.95	0	0	0	0	0	0	0	292	0.64	0	292
Min Daily Peak (ft ³ /s)	0	0	0	0	0	0	0	0	0	0	0	0	0
Missing Days	0	0	0	0	0	0	0	0	0	0	0	0	0

Surface Water Data, Water Year 2014

E038 DP Canyon above TA-21

Location. Lat 35° 52' 49", long -106° 16' 58", SW ¼, sec. 14, T. 19 N., R. 6 E., Los Alamos County.

Drainage Area. 0.22 mi².

Period of Record. April 26, 2000, to September 30, 2014.

Revised Record. Drainage area (2006); Section (2007).

Gage. Data logger with radio telemetry. Elevation of gage is 7087 ft using LANL LIDAR DEM with NAD 83.

Average Volume. 3 yr, 43 acre-ft/yr.

Maximum Discharge for Period of Record. Maximum discharge, 310 ft³/s, July 12, 2013, and September 13, 2013, gage height 4.5 ft.

Maximum Discharge for Current Water Year. Maximum discharge, 292 ft³/s, July 31, 2014, gage height 3.6 ft.



E038 Stream gage upstream view

Surface Water Data, Water Year 2014

Equipment. The station is equipped with a Sutron 9210 data logger (5-min interval), an MDS 4710 radio transceiver, and a Sutron Accububble self-contained bubbler system. The system is powered by a solar-panel battery system housed in a NEMA shelter. The station is equipped with two ISCO pump samplers (one 12-count 1-L glass or polyethylene bottle sampler and one 24-count 1-L polyethylene bottle sampler) to collect water-quality samples. The ISCO samplers are housed in a separate shelter, a 3- × 4-ft metal box. The samplers are triggered by stage through the data logger. An outside staff gage is available for reference. No provision has been made for discharge measurements above the wading stage. All high-flow measurement will be by slope-area or peak-flow computation methods.

The station is also equipped with a tipping bucket rain gage, Rain Collection II. All equipment is powered with a solar-panel battery-charging system.

Fieldwork

Number of Stream Gage Inspections	Number of Stream Gage Maintenance Visits	Number of ISCO 12-Count Sampler Inspections	Number of ISCO 12-Count Sampler Maintenance Visits	Number of ISCO 24-Count Sampler Inspections	Number of ISCO 24-Count Sampler Maintenance Visits
26	9	20	1	20	1

Datum Correction. Levels run in July 2005 show the gage to be within limits.

Gage-Height Record. The data logger referenced to the outside gage gave a complete and satisfactory record for the year, except for November 6, 7, 26, and 27, 2013, because of equipment malfunction and December 1, 2, and 5–13, 2013; January 30, and 31, 2014; February 1, 2, 4, 12–25, and 27, 2014; and March 19, 2014, because of ice.

Rating. The channel is about 10 ft wide and straight for about 30 ft upstream and downstream. The streambed through this reach is primarily sand, gravel, and larger boulders. The low-flow control is a rock outcrop downstream from the gage about 5 ft away. The channel is the control for medium and high stages.

Rating No. 3 was developed using past discharge measurements and verified with current measurements.

No discharge measurements were made during the year.

Discharge. Discharge was computed using Rating No. 3.

Surface Water Data, Water Year 2014

E038 Daily Peak Discharge (ft³/s)

Day	Oct	Nov	Dec	Jan	Feb	Mar	Apr	May	Jun	Jul	Aug	Sep
1	0	0	I ^a	0	I	3.2	0	0.28	0	0	25.8	0
2	0	0	I	0	I	0.31	0	0	0	0.24	0.04	0
3	0	0	0	0	0	0	0	0	0	0	0	0
4	0	17	0	0	I	0	0	0	0	0	36	0
5	0	0	I	0	0	0	0	0	0	0	9.5	132
6	0	E ^b	I	0	0	0	0	0	0	0	0	0.11
7	0	E	I	0	0.24	0	0	0	6.6	0	0	0
8	0	0	I	0	2.3	0	0	0	0	46	0	0
9	0	0	I	0	0	0	0	0	0	0.24	0	0
10	2.3	0	I	0	0	0	0	0	0	0	0	0
11	0	0	I	0	0	0	0	0	0	0	0	0
12	0	0	I	0	I	0	0	0	0	0	0	0
13	0.44	0	I	0	I	0	0	0	0	0	0	0
14	0	0	0	0	I	0.13	0	0	0	32	0	0
15	0.37	0.24	0	0	I	0.06	0	0	0	270	0	0
16	0.18	0	0	0	I	0	0	0	0	19	0	0
17	0	0	0	0	I	0	0	0	0	0.42	0	0
18	0	0	0	0	I	0	0	0	0	0	0	0
19	0	0	0	0	I	I	0	0	0	17	0	0
20	0	0	0	0	I	0	0	0	0	6.8	0	0
21	0	2.0	0	0	I	0	0	0	15	1.2	0	0
22	0	0.15	0	0	I	0	0	3.6	0	0	0.40	0
23	0	0.02	0	0	I	0	0	23	0	0	0	0
24	6.8	20	0	0	I	0	0	2.6	0	0	0	0
25	0.04	3.6	0	0	I	0	0	2.5	0	0	0	0
26	0	E	0	0	0	0	0	0	0	0.72	0	0
27	0	E	0	0	I	0	0	0	0	148	0	0
28	0	0	0	0	0.11	0	0	0.40	0	4.6	0	0
29	0	0	0	0		0	0	0	0	94	0	47
30	0	0	0	I		0	0	0	0	0	0.20	0
31	0		0	I		0		0		210	0	

^aI represents ice present.

^bE represents equipment failure.

E038 Monthly Summary Table

	Oct	Nov	Dec	Jan	Feb	Mar	Apr	May	Jun	Jul	Aug	Sep	WY
Total Volume (acre-ft)	0.68	2.1	0	0	0.17	0.7	0	1.1	0.64	38	2.1	3.4	46
Max Daily Peak (ft ³ /s)	6.8	20	0	0	2.3	3.2	0	23	15	270	36	132	270
Min Daily Peak (ft ³ /s)	0	0	0	0	0	0	0	0	0	0	0	0	0
Missing Days	0	4	11	2	18	0	0	0	0	0	0	0	35

Surface Water Data, Water Year 2014

E039.1 DP Canyon below Grade Control Structure

Location. Lat 35° 52' 40", long -106° 16' 17", SE ¼, Sec. 14, T. 19 N., R. 6 E., Los Alamos County.

Drainage Area. 0.40 mi².

Period of Record. April 4, 2010, to September 30, 2014.

Revised Record. None.

Gage. Data logger with radio telemetry. Elevation of gage is 7016 ft using LANL LIDAR DEM with NAD 83.

Average Volume. 3 yr, 92 acre-ft/yr.

Maximum Discharge for Period of Record. Maximum discharge, 400 ft³/s, September 13, 2013, gage height 4.0 ft.

Maximum Discharge for Current Water Year. Maximum discharge, 317 ft³/s, July 15, 2014, gage height 3.56 ft.



E039.1 Stream gage upstream view

Surface Water Data, Water Year 2014

Equipment. The station is equipped with a Sutron 9210 data logger (5-min interval), an MDS 4710 radio transceiver, a shaft encoder float system, and a Sutron Accubar bubble sensor. The system is powered by a solar-panel battery system housed in a NEMA shelter. A trapezoidal supercritical flume with a 1-ft-wide throat controls flow through the gage reach. No provision has been made for direct discharge measurements above the wading stage. An outside staff gage is available for reference. The station is equipped with two ISCO pump samplers (one 12-count 1-L glass or polyethylene bottle sampler and one 24-count 1-L polyethylene bottle sampler) to collect water-quality samples. The ISCOs are housed in a 3- × 4-ft steel storage box, separate from the other instrumentation. The samplers are triggered by stage through the data logger. All high-flow measurements will be by slope-area or peak-flow computation methods.

Fieldwork

Number of Stream Gage Inspections	Number of Stream Gage Maintenance Visits	Number of ISCO 12-Count Sampler Inspections	Number of ISCO 12-Count Sampler Maintenance Visits	Number of ISCO 24-Count Sampler Inspections	Number of ISCO 24-Count Sampler Maintenance Visits
27	5	21	1	21	1

Datum Correction. None

Gage-Height Record. The data logger referenced to the outside gage gave a complete and satisfactory record for the year, except for March 7–22, 2014, because of ice.

Rating. Rating No. 1 is based on precalibrated data for a trapezoidal supercritical flume with a 1-ft-wide throat (Kilpatrick and Schneider 1983) and was used throughout the period.

No discharge measurements were made during the year.

Discharge. Discharge was computed using Rating No. 1.

Surface Water Data, Water Year 2014

E039.1 Daily Peak Discharge (ft³/s)

Day	Oct	Nov	Dec	Jan	Feb	Mar	Apr	May	Jun	Jul	Aug	Sep
1	0.04	0.04	0	0	0	0	0.28	0.28	0.32	0.32	8	0.04
2	0.04	0.04	0	0	0	0	0.28	0.28	0.32	0.32	0.11	0.04
3	0.04	0.04	0	0	0	0	0.28	0.28	0.32	0.11	0.07	0.04
4	0.04	21	0	0	0	0.04	0.28	0.28	0.32	0.11	14	0.04
5	0.04	0.32	0	0	0	0	0.45	0.28	0.32	0.11	2.4	14
6	0.04	0.07	0	0	0	0	0.32	0.28	0.32	0.11	0.11	0.07
7	0.04	0.07	0	0	0	I*	0.28	0.28	0.83	0.11	0.07	0.07
8	0.04	0	0	0	0.04	I	0.28	0.28	0.35	19.3	0.07	0.04
9	0.04	0	0	0	0	I	0.28	0.28	0.35	1.02	0.07	0.07
10	0.11	0	0	0	0	I	0.28	0.28	0.32	0.14	0.18	0.04
11	0.11	0	0	0	0.04	I	0.28	0.28	0.32	0.14	0.07	0.04
12	0.11	0	0	0	0	I	0.28	0.28	0.32	0.11	0.11	0.04
13	0.11	0	0.04	0	0	I	0.32	0.28	0.32	0.11	0.04	0.04
14	0.07	0	0	0	0	I	0.28	0.28	0.32	15.12	0.04	0.07
15	0.93	0	0	0.04	0.04	I	0.28	0.28	0.32	317	0.04	0.04
16	0.64	0	0	0	0.04	I	0.28	0.28	0.32	12	0.04	0.07
17	0.07	0	0	0	0	I	0.28	0.28	0.32	0.14	0.04	0.04
18	0.07	0	0	0	0	I	0.28	0.28	0.32	0.14	0.04	0.07
19	0.07	0	0	0	0	I	0.28	0.28	0.32	9.06	0.04	0.04
20	0.04	0	0	0	0	I	0.28	0.28	0.32	0.93	0.04	0.04
21	0.04	0	0	0	0	I	0.28	0.28	0.54	0.07	0.04	0.04
22	0.04	0	0	0	0	I	0.28	0.35	0.35	0.07	0.04	0.04
23	0.04	0	0	0	0	0.28	0.32	4.5	0.35	0.07	0.04	0.04
24	4.7	0	0	0	0	0.28	0.28	4.7	0.32	0.07	0.04	0.04
25	0.45	0	0	0	0	0.28	0.28	2.2	0.32	0.04	0.04	0.04
26	0.07	0	0	0.04	0	0.28	0.28	0.35	0.32	0.04	0.07	0.04
27	0.07	0	0	0	0	0.28	0.28	0.35	0.32	22	0.04	0.04
28	0.07	0	0.04	0	0	0.28	0.28	0.35	0.32	2.7	0.04	0.04
29	0.04	0	0	0		0.28	0.28	0.32	0.32	66	0.07	0.11
30	0.04	0	0	0.04		0.32	0.28	0.32	0.32	0.11	0.04	0.04
31	0.04		0	0		0.28		0.32		250	0.04	

*I represents ice present.

E039.1 Monthly Summary Table

	Oct	Nov	Dec	Jan	Feb	Mar	Apr	May	Jun	Jul	Aug	Sep	WY
Total Volume (acre-ft)	44	2.7	0.01	0	0.01	5	17	19	19	43	4.8	2.7	117
Max Daily Peak (ft ³ /s)	4.7	21	0.04	0.04	0.04	0.32	0.45	4.7	0.83	317	8	14	317
Min Daily Peak (ft ³ /s)	0.04	0	0	0	0	0	0.28	0.28	0.32	0.04	0.04	0.04	0
Missing Days	0	0	0	0	0	16	0	0	0	0	0	0	16

Surface Water Data, Water Year 2014

E040 DP Canyon above Los Alamos Canyon

Location. Lat 35° 52' 24", long -106° 15' 34", SW ¼, Sec. 13, T. 19 N., R. 6 E., Los Alamos County.

Drainage Area. 0.60 mi².

Period of Record. May 1999 to September 30, 2014.

Revised Record. Drainage area (2006); Section (2007).

Gage. Data logger with radio telemetry and concrete control. Elevation of gage is 6621 ft using LANL LIDAR DEM with NAD 83.

Average Volume. 3 yr, 28 acre-ft/yr.

Maximum Discharge for Period of Record. Maximum discharge, 550 ft³/s, September 13, 2013, gage height 6.12 ft.

Maximum Discharge for Current Water Year. Maximum discharge, 316 ft³/s, July 15, 2014, gage height 3.56 ft.



E040 Stream gage upstream view

Surface Water Data, Water Year 2014

Equipment. The station is equipped with a Sutron 9210 data logger (5-min interval), an MDS 4710 radio transceiver, and a Milltronics sonic probe. The system is powered by a solar-panel battery system. All equipment is housed in a NEMA shelter. The station is equipped with an ISCO pump sampler (12-count 1-L glass or polyethylene bottles) to collect water-quality samples. The sampler is housed in a 3- x 4-ft metal box. The sampler is triggered by stage through the data logger. An outside staff gage is available for reference. High-flow measurements can be made from the bridge upstream of the gage.

Fieldwork

Number of Stream Gage Inspections	Number of Stream Gage Visits	Number of ISCO 12-Count Sampler Inspections	Number of ISCO 12-Count Sampler Maintenance Visits	Number of ISCO 24-Count Sampler Inspections	Number of ISCO 24-Count Sampler Maintenance Visits
31	10	24	2	n/a*	n/a

* n/a = Not applicable.

Datum Correction. None from levels.

Gage-Height Record. The data logger referenced to the outside staff gage gave a complete and satisfactory record, except from October 1, 2013, through February 20, 2014, because of equipment malfunction.

Rating. The channel is about 15 ft wide and bends to the right above the gage and straight for about 100 ft downstream. The streambed through this reach is primarily sand with large boulders. The control at this site is concrete with a "V" notch in the middle for low flow. The channel becomes the control for medium to high flows. No discharge measurements were made during the year.

Discharge. Discharge was computed using Rating No. 3.

Surface Water Data, Water Year 2014

E040 Daily Peak Discharge (ft³/s)

Day	Oct	Nov	Dec	Jan	Feb	Mar	Apr	May	Jun	Jul	Aug	Sep
1	E*	E	E	E	E	0	0	0	0	0	4.4	0
2	E	E	E	E	E	0	0	0	0	0	1.9	0
3	E	E	E	E	E	0	0	0	0	0	1.3	0
4	E	E	E	E	E	0	0	0	0	0	12	0
5	E	E	E	E	E	0	0	0	0	0	0.02	0
6	E	E	E	E	E	0	0	0	0	0	0.03	0
7	E	E	E	E	E	0	0	0	0	0	0.02	0
8	E	E	E	E	E	0	0	0	0	11	0.02	0
9	E	E	E	E	E	0	0	0	0	2.2	0.02	0
10	E	E	E	E	E	0	0	0	0	0	0.01	0
11	E	E	E	E	E	0	0	0	0	0	0.02	0
12	E	E	E	E	E	0	0	0	0	0	0	0
13	E	E	E	E	E	0	0	0	0	0	0	0
14	E	E	E	E	E	0	0	0	0	15	0	0
15	E	E	E	E	E	0	0	0	0	268	0	0
16	E	E	E	E	E	0	0	0	0	11	0	0
17	E	E	E	E	E	0	0	0	0	0.49	0	0
18	E	E	E	E	E	0	0	0	0	0.56	0	0
19	E	E	E	E	E	0	0	0	0	1.6	0	0
20	E	E	E	E	E	0	0	0	0	0.67	0	0
21	E	E	E	E	0	0	0	0	0	0.63	0	0
22	E	E	E	E	0	0	0	0	0	0	0	0
23	E	E	E	E	0	0	0	0	0	0	0	0
24	E	E	E	E	0	0	0	0	0	0.01	0	0
25	E	E	E	E	0	0	0	0	0	0.01	0	0
26	E	E	E	E	0	0	0	0	0	0.01	0	0
27	E	E	E	E	0	0	0	0	0	21	0	0
28	E	E	E	E	0	0	0	0	0	0.03	0	0
29	E	E	E	E		0	0	0	0	95	0	0
30	E	E	E	E		0	0	0	0	0	0	0
31	E		E	E		0		0		239	0	

*E represents equipment failure.

E040 Monthly Summary Table

	Oct	Nov	Dec	Jan	Feb	Mar	Apr	May	Jun	Jul	Aug	Sep	WY
Total Volume (acre-ft)	E*	E	E	E	0	0	0	0	0	45	7.7	0	52.7
Max Daily Peak (ft ³ /s)	E	E	E	E	0	0	0	0	0	268	4.4	0	268
Min Daily Peak (ft ³ /s)	E	E	E	E	0	0	0	0	0	0	0	0	0
Missing Days	31	30	31	31	8	0	0	0	0	0	0	0	131

*E represents equipment failure.

Surface Water Data, Water Year 2014

E042.1 Los Alamos above Low Head Weir

Location. Lat 35° 52' 2", long -106° 13' 25", NW ¼, Sec. 20, T. 19 N., R. 7 E., Santa Fe County.

Drainage Area. 10.13 mi².

Period of Record. May 4, 2010, to September 30, 2014.

Revised Record. None.

Gage. Data logger with radio telemetry. Elevation of gage is 6377 ft using LANL LIDAR DEM with NAD 83.

Average Volume. 3 yr, 392 acre-ft/yr.

Maximum Discharge for Period of Record. Maximum discharge, 740 ft³/s, September 13, 2013, gage height 5.59 ft.

Maximum Discharge for Current Water Year. Maximum discharge, 210 ft³/s, July 31, 2014, gage height 2.87 ft.



E042.1 Stream gage upstream view

Surface Water Data, Water Year 2014

Equipment. The station is equipped with a Sutron 9210 data logger (5-min interval), an MDS 4710 radio transceiver, a shaft encoder float system, and a Sutron Accubar air-purge bubble sensor, housed in a NEMA shelter. The shelter is secured atop a stilling well, a vertical 2-ft-diameter CMP. An outside staff gage is available for reference. A trapezoidal supercritical flume with a 1-ft-wide throat controls flow through the gage reach. No provision has been made for direct discharge measurements above the wading stage.

Two ISCO pump samplers (one 12-count 1-L glass and polyethylene bottle sampler and one 24-count 1-L polyethylene bottle sampler) to collect water-quality samples are triggered by stage through the data logger. The station is powered by a solar-panel battery system. The samplers and batteries are in a 3- x 4-ft steel storage box, separate from the other instrumentation. A tipping bucket rain gage with 0.01-in. resolution is mounted about 30 ft from the station. Cellular telemetry with a speech modem provides remote data retrieval.

Fieldwork

Number of Stream Gage Inspections	Number of Stream Gage Maintenance Visits	Number of ISCO 12-Count Sampler Inspections	Number of ISCO 12-Count Sampler Maintenance Visits	Number of ISCO 24-Count Sampler Inspections	Number of ISCO 24-Count Sampler Maintenance Visits
35	11	25	1	25	2

Datum Correction. None.

Gage-Height Record. The data logger referenced to the outside staff gage gave a complete and satisfactory record, except for November 13, 2013, through January 21, 2014, because of equipment malfunction.

Rating. Rating No. 1 is based on precalibrated data for the flume used (Kilpatrick and Schneider 1983) and was used throughout the period.

No discharge measurements were made during the year.

Discharge. Discharge was computed directly by Rating No. 1 for the entire water year. Days estimated were based on precipitation and nearby gage stations for verification. Flow is partially regulated by the Los Alamos Reservoir, located about 7.8 mi upstream.

Surface Water Data, Water Year 2014

E042.1 Daily Mean Discharge (ft³/s)

Day	Oct	Nov	Dec	Jan	Feb	Mar	Apr	May	Jun	Jul	Aug	Sep
1	0	0	E*	E	0	0	0	0	0	0	0.05	0
2	18	0	E	E	0	0	0	0	0	0	0	0
3	18	0	E	E	0	0	0	0	0	0	0	0
4	5.4	1.1	E	E	0	0	0	0	0	0	3.4	0
5	0.04	1.2	E	E	0	0	0	0	0	0	0.11	0
6	0	1.1	E	E	0	0	0	0	0	0	0.04	0
7	0	0	E	E	0	0	0	0	0	0	0	0
8	0	0	E	E	0	0	0	0	0	12	0	0
9	0	0	E	E	0	0	0	0	0	3.8	0	0
10	0.66	0	E	E	0	0	0	0	0	0	0	0
11	0.76	0	E	E	0	0	0	0	0	0	0	0
12	0.58	0	E	E	0	0	0	0	0	0	0	0
13	0.07	E	E	E	0	0	0	0	0	0	0	0
14	0	E	E	E	0	0	0	0	0	4.2	0	0
15	0	E	E	E	0	0	0	0	0	115	0	0
16	0	E	E	E	0	0	0	0	0	0.69	0	0
17	0	E	E	E	0	0	0	0	0	0	0	0
18	0	E	E	E	0	0	0	0	0	0	0	0
19	0	E	E	E	0	0	0	0	0	0	0	0
20	0	E	E	E	0	0	0	0	0	0	0	0
21	0	E	E	E	0	0	0	0	0	0	0	0
22	0	E	E	0	0	0	0	0	0	0	0	0
23	0	E	E	0	0	0	0	0	0	0	0	0
24	0	E	E	0	0	0	0	0	0	0	0	0
25	0	E	E	0	0	0	0	0	0	0	0	0
26	0	E	E	0	0	0	0	0	0	0	0	0
27	0	E	E	0	0	0	0	0	0	0	0	0
28	0	E	E	0	0	0	0	0	0	0	0	0
29	0	E	E	0		0	0	0	0	92	0	0
30	0	E	E	0		0	0	0	0	0.07	0	0
31	0		E	0		0		0		210	0	

*E represents equipment failure.

E042.1 Monthly Summary Table

	Oct	Nov	Dec	Jan	Feb	Mar	Apr	May	Jun	Jul	Aug	Sep	WY
Total Volume (acre-ft)	44	3.4	E*	E	0	0	0	0	0	42	2.5	0	91.9
Max Daily Peak (ft ³ /s)	5.4	1.2	E	0	0	0	0	0	0	210	3.4	0	200
Min Daily Peak (ft ³ /s)	0	0	0	0	0	0	0	0	0	0	0	0	0
Missing Days	0	18	31	21	0	0	0	0	0	0	0	0	70

*E represents equipment failure.

Surface Water Data, Water Year 2014

E050.1 Los Alamos Canyon below Low Head Weir

Location. Lat 35° 52' 2", long -106° 13' 3", NE ¼, sec. 20, T. 19 N., R. 7 E., Santa Fe County.

Drainage Area. 10.44 mi².

Period of Record. July 22, 2010, to September 30, 2014.

Revised Record. None.

Gage. Data logger with radio telemetry. Elevation of gage is 6340 ft using LANL LIDAR DEM with NAD 83.

Average Volume. 3 yr, 151 acre-ft/yr.

Maximum Discharge for Period of Record. Maximum discharge, 740 ft³/s, September 13, 2013, gage height 5.81 ft.

Maximum Discharge for Current Water Year. Maximum discharge, 214 ft³/s, July 31, 2014, gage height 2.9 ft.



E050.1 Stream gage downstream view

Surface Water Data, Water Year 2014

Equipment. The station is equipped with a Sutron 9210 data logger (5-min interval), an MDS 4710 radio transceiver, a shaft encoder float system, and a Sutron Accubar air-purge bubble sensor, housed in a NEMA shelter. The shelter is secured atop a stilling well, a vertical 2-ft-diameter CMP. An outside staff gage is available for reference. A trapezoidal supercritical flume with a 1-ft-wide throat controls flow through the gage reach. No provision has been made for direct discharge measurements above the wading stage.

The station is equipped with two ISCO pump samplers (one 12-count 1-L glass or polyethylene bottle sampler and one 24-count polyethylene bottle sampler) to collect water-quality samples. The ISCOs samplers are housed in a separate shelter, a 3- x 4-ft metal box. The samplers are triggered by stage through the data logger. A line-of-sight radio transceiver provides 5-min stage data from the bubble sensor and encoder.

Fieldwork

Number of Stream Gage Inspections	Number of Stream Gage Maintenance Visits	Number of ISCO 12-Count Sampler Inspections	Number of ISCO 12-Count Sampler Maintenance Visits	Number of ISCO 24-Count Sampler Inspections	Number of ISCO 24-Count Sampler Maintenance Visits
57	8	23	2	23	1

Datum Correction. None.

Gage-Height Record. The data logger referenced to the outside staff gage gave a complete and satisfactory record for the entire year.

Rating. Rating No. 1 is based on precalibrated data for the flume used (Kilpatrick and Schneider 1983) and was used throughout the period.

No discharge measurements were made during the year.

Discharge. Discharge was computed by directly applying Rating No. 1 for the entire water year.

Surface Water Data, Water Year 2014

E050.1 Daily Peak Discharge (ft³/s)

Day	Oct	Nov	Dec	Jan	Feb	Mar	Apr	May	Jun	Jul	Aug	Sep
1	0.18	0	0	0	0	0	0	0	0	0	0.35	0
2	6.4	0	0	0	0	0	0	0	0	0	0.76	0
3	6.7	0	0	0	0	0	0	0	0	0	0.04	0
4	4.7	3.2	0	0	0	0	0	0	0	0	0.25	0
5	0.18	3.2	0	0	0	0	0	0	0	0	0.11	0
6	0.11	0.15	0	0	0	0	0	0	0	0	0	0
7	0	0	0	0	0	0	0	0	0	0	0	0
8	0	0	0	0	0	0	0	0	0	0.07	0	0
9	0	0	0	0	0	0	0	0	0	0	0	0
10	1.2	0	0	0	0	0	0	0	0	0	0	0
11	1.3	0	0	0	0	0	0	0	0	0	0	0
12	1.2	0	0	0	0	0	0	0	0	0	0	0
13	0.18	0	0	0	0	0	0	0	0	0	0	0
14	0.11	0	0	0	0	0	0	0	0	0.18	0	0
15	0.04	0	0	0	0	0	0	0	0	49	0	0
16	0	0	0	0	0	0	0	0	0	1.6	0	0
17	0	0	0	0	0	0	0	0	0	0.11	0	0
18	0	0	0	0	0	0	0	0	0	0.0	0	0
19	0	0	0	0	0	0	0	0	0	0.0	0	0
20	0	0	0	0	0	0	0	0	0	0.0	0	0
21	0	0	0	0	0	0	0	0	0	0.0	0	0
22	0	0	0	0	0	0	0	0.07	0	0.0	0	0
23	0	0	0	0	0	0	0	0.04	0	0.0	0	0
24	0.04	0	0	0	0	0	0	0.04	0	0.0	0	0
25	0	0	0	0	0	0	0	0	0	0.0	0	0
26	0	0	0	0	0	0	0	0	0	0.0	0	0
27	0	0	0	0	0	0	0	0	0	0.0	0	0
28	0	0	0	0	0	0	0	0	0	0.0	0	0
29	0	0	0	0		0	0	0	0	63	0	0
30	0	0	0	0		0	0	0	0	0.18	0	0
31	0		0	0		0		0		214	0	

E050.1 Monthly Summary Table

	Oct	Nov	Dec	Jan	Feb	Mar	Apr	May	Jun	Jul	Aug	Sep	WY
Total Volume (acre-ft)	23	1.5	0	0	0	0	0	0.01	0	40	2.1	0	67
Max Daily Peak (ft ³ /s)	6.7	3.2	0	0	0	0	0	0.07	0	214	0.76	0	214
Min Daily Peak (ft ³ /s)	0	0	0	0	0	0	0	0	0	0	0	0	0
Missing Days	0	0	0	0	0	0	0	0	0	0	0	0	0

Surface Water Data, Water Year 2014

E055 Pueblo Canyon above Acid Canyon

Location. Lat 35° 53' 20", long -106° 18' 14", SE ¼, Sec. 9, T. 19 N., R. 6 E., Los Alamos County.

Drainage Area. 3.42 mi².

Period of Record. October 1, 2002, to September 30, 2014.

Revised Record. Average discharge (2007, 2008).

Gage. Data logger with radio telemetry. Elevation of gage is 6943 ft using LANL LIDAR DEM with NAD 83.

Average Volume. 3 yr, 56 acre-ft/yr.

Maximum Discharge for Period of Record. Maximum discharge, 1200 ft³/s, September 13, 2013, gage height 6.86 ft.

Maximum Discharge for Current Water Year. Maximum discharge, 71 ft³/s, July 31, 2014, gage height 2.4 ft.



E055 Stream gage upstream view

Surface Water Data, Water Year 2014

Equipment. The station is equipped with a Sutron 9210 data logger (5-min interval), an MDS 4710 radio tranceiver, and a Sutron Accubar bubble sensor. The system is powered by a solar-panel battery system housed in a NEMA shelter. The station is equipped with an ISCO pump sampler (12-count 1-L glass or polyethylene bottles) to collect water-quality samples. The ISCO sampler is housed in a separate shelter, a 3- x 4-ft metal box. The sampler is triggered by stage through the data logger. An outside staff gage is available for reference. No provision has been made for direct discharge measurements above the wading stage.

Fieldwork

Number of Stream Gage Inspections	Number of Stream Gage Maintenance Visits	Number of ISCO 12-Count Sampler Inspections	Number of ISCO 12-Count Sampler Maintenance Visits	Number of ISCO 24-Count Sampler Inspections	Number of ISCO 24-Count Sampler Maintenance Visits
25	3	20	1	n/a*	n/a

* n/a = Not applicable.

Datum Correction. None.

Gage-Height Record. The data logger referenced to the outside staff gage gave a complete and satisfactory record for the entire year.

Rating. The channel comes into the gage from a left-to-right bend and bends hard left at about 100 ft below the gage. The bed consists of unstable sand and gravel with some boulders. The left bank downstream from the gage is heavily wooded, tending to hold the flow to the right, away from the reach of the gage. The lower end of any stage-discharge relation will be unstable here. Rating No. 2 was developed using the current year's measurements and one critical-depth measurement of 850 ft³/s and various low-flow measurements from previous years. The low-water definition is poor, and the high end needs to be confirmed. The low end of the rating was verified by a dye study and was used to enhance the rating. Rating No. 2 is good. Rating No.3 was developed using Rating No. 2 and by extending the upper range.

One discharge measurement was made during the year.

Discharge. Discharge was computed using Rating No. 3.

Surface Water Data, Water Year 2014

E055 Daily Peak Discharge (ft³/s)

Day	Oct	Nov	Dec	Jan	Feb	Mar	Apr	May	Jun	Jul	Aug	Sep
1	0	0	0	0	0	0	0	0	0	0	0.95	0
2	0	0	0	0	0	0	0	0	0	0	0.34	0
3	0	0	0	0	0	0	0	0	0	0	0.18	0
4	0	0	0	0	0	0	0	0	0	0	0.18	0
5	0	0	0	0	0	0	0	0	0	0	0.18	0
6	0	0	0	0	0	0	0	0	0	0	0.18	0
7	0	0	0	0	0	0	0	0	0	0.09	0.18	0
8	0	0	0	0	0	0	0	0	0	3.6	0.18	0
9	0	0	0	0	0	0	0	0	0	0.18	0.18	0
10	0	0	0	0	0	0	0	0	0	0.18	0.18	0
11	0	0	0	0	0	0	0	0	0	0.18	0.18	0
12	0	0	0	0	0	0	0	0	0	0.18	0.18	0
13	0	0	0	0	0	0	0	0	0	0.18	0	0
14	0	0	0	0	0	0	0	0	0	0.31	0	0
15	0	0	0	0	0	0	0	0	0	1.9	0	0
16	0	0	0	0	0	0	0	0	0	0.18	0	0
17	0	0	0	0	0	0	0	0	0	0.18	0	0
18	0	0	0	0	0	0	0	0	0	0.18	0	0
19	0	0	0	0	0	0	0	0	0	1.8	0	0
20	0	0	0	0	0	0	0	0	0	0.18	0	0
21	0	0	0	0	0	0	0	0	0	0.18	0	0
22	0	0	0	0	0	0	0	0	0	0.18	0	0
23	0	0	0	0	0	0	0	0	0	0.18	0	0
24	0	0	0	0	0	0	0	0	0	0.18	0	0
25	0	0	0	0	0	0	0	0	0	0.18	0	0
26	0	0	0	0	0	0	0	0	0	0.18	0	0
27	0	0	0	0	0	0	0	0	0	0.81	0	0
28	0	0	0	0	0	0	0	0	0	0.18	0	0
29	0	0	0	0		0	0	0	0	9.6	0	0
30	0	0	0	0		0	0	0	0	0.21	0	0
31	0		0	0		0		0		71	0	

E055 Monthly Summary Table

	Oct	Nov	Dec	Jan	Feb	Mar	Apr	May	Jun	Jul	Aug	Sep	WY
Total Volume (acre-ft)	0	0	0	0	0	0	0	0	0	12	4.7	0	16.7
Max Daily Peak (acre-ft)	0	0	0	0	0	0	0	0	0	71	0.95	0	71
Min Daily Peak (acre-ft)	0	0	0	0	0	0	0	0	0	0	0	0	0
Missing Days	0	0	0	0	0	0	0	0	0	0	0	0	0

Surface Water Data, Water Year 2014

E055.5 South Fork of Acid Canyon

Location. Lat 35° 53' 10", long -106° 18' 26", SE ¼, Sec. 9, T. 19 N., R. 6 E., Los Alamos County.

Drainage Area. 0.08 mi².

Period of Record. August 18, 2004, to September 30, 2014.

Revised Record. Period of record (2009).

Gage. Data logger with radio telemetry. Elevation of gage is 7101 ft using LANL LIDAR DEM with NAD 83.

Average Volume. 3 yr, 2 acre-ft/yr.

Maximum Discharge for Period of Record. Maximum discharge 90 ft³/s, September 13, 2013, gage height 6.2 ft.

Maximum Discharge for Current Water Year. Maximum discharge 16 ft³/s, July 15, 2014, gage height 5.36 ft.



E055.5 Stream gage upstream view

Surface Water Data, Water Year 2014

Equipment. The station is equipped with a Sutron 9210 data logger (5-min interval), an MDS 4710 radio transceiver, and a Sutron Accubar bubble sensor, housed in a NEMA shelter on the left bank. The system is powered by a solar-panel battery system. The station is equipped with an ISCO pump sampler (12-count 1-L glass or polyethylene bottles) to collect water-quality samples. The samples are triggered by stage through the data logger. The samplers are housed in a separate shelter, a 3- x 4-ft metal box. An outside staff gage is available for reference. No provision has been made for discharge measurements above the wading stage.

The station is also equipped with a tipping bucket rain gage, Rain Collection II. All equipment is powered with a solar-panel battery-charging system.

Fieldwork

Number of Stream Gage Inspections	Number of Stream Gage Maintenance Visits	Number of ISCO 12-Count Sampler Inspections	Number of ISCO 12-Count Sampler Maintenance Visits	Number of ISCO 24-Count Sampler Inspections	Number of ISCO 24-Count Sampler Maintenance Visits
26	4	20	1	n/a*	n/a

* n/a = Not applicable.

Datum Correction. None. The levels from November 8, 2005, found the gage to be within limits. No corrections were needed.

Gage-Height Record. The data logger referenced to the outside staff gage gave a complete and satisfactory record for the entire year.

Rating. The channel is straight for about 75 ft upstream and 100 ft downstream. The channel is trapezoidal with little vegetation. The bed is rock with gravel and should not be subject to very much movement.

Rating No. 1 was developed by one discharge measurement of low flow and one slope-area measurement of peak flow. The rating curve was extended to 6.22, based on a critical-depth computation.

No discharge measurements were made during the year.

Discharge. Discharge was computed by applying Rating No. 1.

Surface Water Data, Water Year 2014

E055.5 Daily Peak Discharge (ft³/s)

Day	Oct	Nov	Dec	Jan	Feb	Mar	Apr	May	Jun	Jul	Aug	Sep
1	0	0	0	0	0	0	0 DS*	0 DS	0 DS	0	0.02	0
2	0	0	0	0	0	0	0 DS	0 DS	0 DS	0	0.02	0
3	0	0	0	0	0	0	0 DS	0 DS	0 DS	0	0.02	0.03
4	0	0	0	0	0	0	0 DS	0 DS	0 DS	0	0.02	0
5	0	0	0	0	0	0	0 DS	0 DS	0 DS	0	0.02	0.01
6	0	0	0	0	0	0	0 DS	0 DS	0 DS	0	0.02	0
7	0	0	0	0	0	0	0 DS	0 DS	0 DS	0	0	0
8	0	0	0	0	0	0	0 DS	0 DS	0 DS	4.3	0	0
9	0	0	0	0	0	0	0 DS	0 DS	0 DS	0.02	0	0
10	0	0	0	0	0	0	0 DS	0 DS	0 DS	0.02	0	0
11	0	0	0	0	0	0	0 DS	0 DS	0 DS	0.02	0	0
12	0	0	0	0	0	0	0 DS	0 DS	0 DS	0.02	0	0
13	0	0	0	0	0	0	0 DS	0 DS	0 DS	0.02	0	0
14	0	0	0	0	0	0	0 DS	0 DS	0 DS	0.02	0	0
15	0	0	0	0	0	0	0 DS	0 DS	0 DS	16	0	0
16	0	0	0	0	0	0	0 DS	0 DS	0 DS	0.02	0	0
17	0	0	0	0	0	0	0 DS	0 DS	0 DS	0.02	0	0
18	0	0	0	0	0	0	0 DS	0 DS	0 DS	0.02	0	0
19	0	0	0	0	0	0	0 DS	0 DS	0 DS	0.02	0	0
20	0	0	0	0	0	0	0 DS	0 DS	0 DS	0.02	0	0
21	0	0	0	0	0	0	0 DS	0 DS	0 DS	0.02	0	0
22	0	0	0	0	0	0	0 DS	0 DS	0 DS	0.02	0	0
23	0	0	0	0	0	0	0 DS	0 DS	0 DS	0.02	0	0
24	0	0	0	0	0	0	0 DS	0 DS	0 DS	0.02	0	0
25	0	0	0	0	0	0	0 DS	0 DS	0 DS	0.02	0	0
26	0	0	0	0	0	0	0 DS	0 DS	0 DS	0.02	0	0
27	0	0	0	0	0	0	0 DS	0 DS	0 DS	1.7	0	0
28	0	0	0	0	0	0	0 DS	0 DS	0 DS	0.02	0	0
29	0	0	0	0		0	0 DS	0 DS	0 DS	0.03	0	0
30	0	0	0	0		0	0 DS	0 DS	0 DS	0.02	0	0
31	0		0	0		0		0 DS		12	0	

* DS represents datum shift.

E055.5 Monthly Summary Table

	Oct	Nov	Dec	Jan	Feb	Mar	Apr	May	Jun	Jul	Aug	Sep	WY
Total Volume (acre-ft)	0	0	0	0	0	0	0 DS*	0 DS	0 DS	1.4	0.12	0.04	1.6
Max Daily Peak (ft ³ /s)	0	0	0	0	0	0	0	0	0	16	0.02	0.03	16
Min Daily Peak (ft ³ /s)	0	0	0	0	0	0	0	0	0	0	0	0	0
Missing Days	0	0	0	0	0	0	0	0	0	0	0	0	0

* DS represents datum shift.

Surface Water Data, Water Year 2014

E056 Acid Canyon above Pueblo Canyon

Location. Lat 35° 53' 19", long -106° 18' 14" SE ¼, Sec. 9, T, 19 N., R. 6 E., Los Alamos County.

Drainage Area. 0.452 mi².

Period of Record. October 1, 2006, to September 30, 2014.

Revised Record. Period of record (2008).

Average Volume. 3 yr, 49 acre-ft/yr.

Gage. Data logger with radio telemetry. Elevation of gage is 6944 ft using LANL LIDAR DEM with NAD 83.

Maximum Discharge for Period of Record. Maximum discharge, 470 ft³/s, September 13, 2013, gage height 8.6 ft.

Maximum Discharge for Current Water Year. Maximum discharge, 45 ft³/s, July 31, 2014, gage height 3.9 ft.



E056 Stream gage downstream view

Surface Water Data, Water Year 2014

Equipment. The station is equipped with a Sutron 9210 data logger (5-min interval), an MDS 4710 radio transceiver, and a Sutron Accubar bubble sensor mounted on a 6-in. channel cantilevered over the streambed. The system is powered by a solar-panel battery system housed in a NEMA shelter. The station is equipped with an ISCO pump sampler (12-count 1-L glass or polyethylene bottles) to collect water-quality samples. An ISCO sampler is housed in a separate shelter, a 3- × 4-ft metal box. The sampler is triggered by stage through the data logger. An outside staff gage is available for reference. No provisions have been made for measurements above the wading stage.

Fieldwork

Number of Stream Gage Inspections	Number of Stream Gage Maintenance Visits	Number of ISCO 12-Count Sampler Inspections	Number of ISCO 12-Count Sampler Maintenance Visits	Number of ISCO 24-Count Sampler Inspections	Number of ISCO 24-Count Sampler Maintenance Visits
25	7	20	1	n/a*	n/a

* n/a = Not applicable.

Datum Correction. None. The levels are from June 6, 2006. The gage is within acceptable limits.

Gage-Height Record. The data logger referenced to the outside staff gage gave a complete and satisfactory record for the entire year.

Rating. The channel is about 20 ft wide and straight for about 15 ft upstream and straight for about 40 ft downstream and 20 ft above the confluence of Pueblo Canyon. The streambed through this reach is primarily sand and cobbles. The low-water control is a 90-degree sharp-crested weir. At high flow, the channel becomes the control.

Rating No. 3 is based on four discharge measurements and six indirect measurements made by a concurrent dye study at the site. Shifts were applied to low flow using "V" diagrams. Rating No. 4 is based on Rating No. 3 with an extension of the upper range.

No discharge measurements were taken during the year.

Discharge. Discharge was computed by applying the gage height to Rating No. 4.

Surface Water Data, Water Year 2014

E056 Daily Peak Discharge (ft³/s)

Day	Oct	Nov	Dec	Jan	Feb	Mar	Apr	May	Jun	Jul	Aug	Sep
1	0.02	0.01	0	0 DS*	0 DS	0	0 DS	0	0.02	0	0.33	0
2	0.01	0.01	0	0 DS	0 DS	0	0 DS	0	0.03	0	0.09	0
3	0.01	0.01	0	0 DS	0 DS	0	0 DS	0	0.03	0	0.08	0
4	0.01	0.99	0	0 DS	0 DS	0	0 DS	0	0.02	0	0.36	0
5	0.01	0.01	0	0 DS	0 DS	0	0 DS	0	0.02	0	0.10	0
6	0	0.01	0	0 DS	0 DS	0	0 DS	0	0.02	0	0.09	0
7	0	0	0	0 DS	0 DS	0	0 DS	0	0.02	0	0.08	0
8	0	0	0	0 DS	0 DS	0	0 DS	0	0.02	16	0.07	0
9	0	0	0	0 DS	0 DS	0	0 DS	0	0.02	0.07	0.06	0
10	0	0	0	0 DS	0 DS	0	0 DS	0	0.01	0.03	0.05	0
11	0	0	0	0 DS	0 DS	0	0 DS	0	0	0.03	0.05	0
12	0	0	0	0 DS	0 DS	0	0 DS	0	0	0.03	0.05	0
13	0	0	0	0 DS	0 DS	0	0 DS	0	0	0.03	0.04	0
14	0	0	0	0 DS	0 DS	0	0 DS	0	0	1.2	0.03	0
15	0	0	0	0 DS	0 DS	0	0 DS	0	0	31	0.03	0
16	0	0	0	0 DS	0 DS	0	0 DS	0	0	0.34	0.03	0
17	0.01	0	0	0 DS	0 DS	0	0 DS	0	0	0.03	0.02	0
18	0.01	0	0	0 DS	0 DS	1.7	0 DS	0	0	0.03	0.01	0
19	0.02	0	0	0 DS	0 DS	0.02	0 DS	0	0	5.5	0	0
20	0.02	0	0	0 DS	0 DS	0.02	0 DS	0	0	0.04	0	0
21	0.02	0	0	0 DS	0 DS	0.02	0 DS	0	0	0.03	0	0
22	0.02	0	0	0 DS	0 DS	0.01	0 DS	0	0	0.04	0	0
23	0.02	0	0	0 DS	0 DS	0.01	0 DS	0.52	0	0.04	0	0
24	0.02	0	0	0 DS	0 DS	0.01	0 DS	0.16	0	0.04	0	0
25	0.02	0	0	0 DS	0 DS	0.01	0 DS	0.02	0	0.04	0	0
26	0.01	0	0	0 DS	0 DS	0.01	0 DS	0.02	0	0.03	0	0
27	0.01	0	0	0 DS	0 DS	0.01	0 DS	0.02	0	5.4	0	0
28	0.01	0	0	0 DS	0 DS	0.01	0 DS	0.02	0	0.05	0	0
29	0.01	0	0	0 DS		0.01	0 DS	0.02	0	24	0	0
30	0.01	0	0	0 DS		0.01	0 DS	0.02	0	0.04	0	0
31	0.01		0	0 DS		0		0.03		45	0	

* DS represents datum shift.

E056 Monthly Summary Table

	Oct	Nov	Dec	Jan	Feb	Mar	Apr	May	Jun	Jul	Aug	Sep	WY
Total (acre-ft)	0.33	0.1	0	0 DS*	0 DS	0.56	0 DS	0.26	0.35	8.4	1.7	0	11.7
Max Daily Peak (acre-ft)	0.02	0.99	0	0 DS	0 DS	1.7	0 DS	0.52	0.03	45	0.36	0	45
Min Daily Peak (acre-ft)	0	0	0	0 DS	0 DS	0	0 DS	0	0	0	0	0	0
Missing Days	0	0	0	0	0	0	0	0	0	0	0	0	0

* DS represents datum shift.

Surface Water Data, Water Year 2014

E059.5 Pueblo Canyon below LAC WWTF

Location. Lat 35° 52' 52.72" N, long -106° 14' 22.89" W, Zone 13S, NM23, T. 19 N., R. 7 E., Santa Fe County.

Drainage Area. 3.26 mi².

Period of Record. May 10, 2014, to September 30, 2014.

Revised Record. None.

Gage. Data logger with radio telemetry. Elevation of gage is 6483 ft using LANL LIDAR DEM with NAD 83.

Average Volume. <1 yr, 52 acre-ft/yr.

Maximum Discharge for Period of Record. Maximum discharge, 97 ft³/s, July 31, 2014, gage height, 6.23 ft.

Maximum Discharge for Current Water Year. Maximum discharge, 97 ft³/s, July 31, 2014, gage height, 6.23 ft.



E059.5 Stream gage upstream view

Surface Water Data, Water Year 2014

Equipment. The station is equipped with a Sutron 9210 data logger (5-min interval), an MDS 4710 radio transceiver, and a Sutron Accubar bubble sensor. Two ISCO pump samplers (one 12-count 1-L glass and polyethylene bottle sampler and one 24-count 1-L polyethylene bottle sampler) to collect water-quality samples are triggered by stage through the data logger. The station is powered by a solar-panel battery system. The samplers and batteries are in a 3- × 4-ft steel storage box, separate from the other instrumentation. No flow-control structure exists in the channel. An outside staff gage is available for reference. No provision has been made for discharge measurements above the wading stage.

Fieldwork

Number of Stream Gage Inspections	Number of Stream Gage Maintenance Visits	Number of ISCO 12-Count Sampler Inspections	Number of ISCO 12-Count Sampler Maintenance Visits	Number of ISCO 24-Count Sampler Inspections	Number of ISCO 24-Count Sampler Maintenance Visits
12	3	n/a*	n/a	n/a	n/a

* n/a = Not applicable.

Datum Correction. None.

Gage-Height Record. The data logger referenced to the outside staff gage gave a complete and satisfactory record from May 10, 2014, through September 30, 2014. The gage was installed on May 10, 2014.

Rating. Open channel.

Rating No. 1 was developed from a step-backwater survey conducted in September 2010. The control is the channel at all flows. The channel bed is highly mobile sand, and stage shifts will be required to account for frequent reshaping of the channel by discharge.

No discharge measurements were made during the year.

Discharge. Discharge was computed using Rating No. 1.

Surface Water Data, Water Year 2014

E059.5 Daily Peak Discharge (ft³/s)

Day	Oct	Nov	Dec	Jan	Feb	Mar	Apr	May	Jun	Jul	Aug	Sep
1	ND*	ND	ND	ND	ND	ND	ND	ND	0.07	0	0.47	1.4
2	ND	ND	ND	ND	ND	ND	ND	ND	0	0	0	0.85
3	ND	ND	ND	ND	ND	ND	ND	ND	0	0	0	1.0
4	ND	ND	ND	ND	ND	ND	ND	ND	0.03	0	1.8	0.10
5	ND	ND	ND	ND	ND	ND	ND	ND	0	0	1.1	0.13
6	ND	ND	ND	ND	ND	ND	ND	ND	0	0	0.85	0.85
7	ND	ND	ND	ND	ND	ND	ND	ND	0	0	0.85	2.2
8	ND	ND	ND	ND	ND	ND	ND	ND	0	0.17	1.8	0.50
9	ND	ND	ND	ND	ND	ND	ND	ND	0	0.17	1.7	0.20
10	ND	ND	ND	ND	ND	ND	ND	0	0	0.17	13	0.85
11	ND	ND	ND	ND	ND	ND	ND	0.27	0	0.17	1.7	0.13
12	ND	ND	ND	ND	ND	ND	ND	0.33	0	0.17	1.4	0.13
13	ND	ND	ND	ND	ND	ND	ND	0.03	0	0.17	1.0	0.17
14	ND	ND	ND	ND	ND	ND	ND	0.03	0	0.17	1.4	0.17
15	ND	ND	ND	ND	ND	ND	ND	0	0	8.4	1.1	0.17
16	ND	ND	ND	ND	ND	ND	ND	0	0	0	1.1	0.17
17	ND	ND	ND	ND	ND	ND	ND	0	0	0	1.0	0.40
18	ND	ND	ND	ND	ND	ND	ND	0.13	0	0	1.4	0.17
19	ND	ND	ND	ND	ND	ND	ND	0	0	0	0.85	0.17
20	ND	ND	ND	ND	ND	ND	ND	0.85	0	0.1	1.4	0.17
21	ND	ND	ND	ND	ND	ND	ND	0.60	0	0.1	1.0	0.27
22	ND	ND	ND	ND	ND	ND	ND	0.60	0	0.1	1.8	0.17
23	ND	ND	ND	ND	ND	ND	ND	0.43	0	1.4	1.4	0.85
24	ND	ND	ND	ND	ND	ND	ND	0.40	0	1.4	1.7	2.4
25	ND	ND	ND	ND	ND	ND	ND	0.37	0	1.5	1.4	0.33
26	ND	ND	ND	ND	ND	ND	ND	0.27	0	1.7	1.7	2.0
27	ND	ND	ND	ND	ND	ND	ND	0.27	0	1.7	1.8	3.1
28	ND	ND	ND	ND	ND	ND	ND	0.17	0	1.7	1.8	3.3
29	ND	ND	ND	ND		ND	ND	0.27	0	44	1.4	3.3
30	ND	ND	ND	ND		ND	ND	0.23	0	2.8	0.85	3.3
31	ND		ND	ND		ND		0.27		97	0.20	

*ND represents No data. Sampler was installed on May 10, 2014.

E059.5 Monthly Summary Table

	Oct	Nov	Dec	Jan	Feb	Mar	Apr	May	Jun	Jul	Aug	Sep	WY
Total Volume (acre-ft)	ND*	ND	ND	ND	ND	ND	ND	2.2	0.01	27	14	9.2	52
Max Daily Peak (ft³/s)	ND	ND	ND	ND	ND	ND	ND	0.85	0.07	97	1.8	3.3	97
Min Daily Peak (ft³/s)	ND	ND	ND	ND	ND	ND	ND	0	0	0	0	0	0
Missing Days	31	30	31	31	28	31	30	9	0	0	0	0	221

*ND represents No data. Sampler was installed on May 10, 2014.

Surface Water Data, Water Year 2014

E060.1 Pueblo Canyon below Grade Control Structure

Location. Lat 35° 52' 17", long -106° 12' 53", NE ¼, Sec. 20, T. 19 N., R. 7 E., Santa Fe County.

Drainage Area. 8.30 mi².

Period of Record. April 15, 2010, to September 30, 2014.

Revised Record. None.

Gage. Data logger with radio telemetry. Elevation of gage is 6329 ft using LANL LIDAR DEM with NAD 83.

Average Volume. 3 yr, 72 acre-ft/yr.

Maximum Discharge for Current Water Year. Maximum discharge, 1400 ft³/s, September 13, 2013, gage height 6.23 ft.

Maximum Discharge for Period of Record. Maximum discharge, 54 ft³/s, July 31, 2014, gage height, 1.41 ft.



E060.1 Stream gage downstream view

Surface Water Data, Water Year 2014

Equipment. The station is equipped with a Sutron 9210 data logger (5-min interval), an MDS 4710 radio transceiver, a shaft encoder float system, and a Sutron Accubar air-purge bubble sensor, housed in a NEMA shelter. The shelter is secured atop a stilling well, a vertical 2.5-ft-diameter corrugated metal culvert pipe. An outside staff gage is available for reference. A trapezoidal supercritical flume with a 1-ft-wide throat controls flow through the gage reach. No provision has been made for direct discharge measurements above the wading stage.

Two ISCO pump samplers (one 12-count 1-L glass and polyethylene bottle sampler and one 24-count 1-L polyethylene bottle sampler) to collect water-quality samples are triggered by stage through the data logger. The station is powered by a solar-panel battery system. The samplers and batteries are in a 3- x 4-ft steel storage box, separate from the other instrumentation. A line-of-sight radio transceiver provides 5-min stage data from the encoder and bubbler.

Fieldwork

Number of Stream Gage Inspections	Number of Stream Gage Maintenance Visits	Number of ISCO 12-Count Sampler Inspections	Number of ISCO 12-Count Sampler Maintenance Visits	Number of ISCO 24-Count Sampler Inspections	Number of ISCO 24-Count Sampler Maintenance Visits
62	18	21	1	21	1

Datum Correction. None.

Gage-Height Record. The data logger referenced to the outside staff gage gave a complete and satisfactory record, except for June 8 and 9, 2014, because of equipment malfunction.

Rating. Rating No. 1 is based on precalibrated data for the flume used (Kilpatrick and Schneider 1983) and was used throughout the period.

No discharge measurements were taken during the year.

Discharge. Discharge was computed by directly applying Rating No. 1 for the entire water year.

Surface Water Data, Water Year 2014

E060.1 Daily Peak Discharge (ft³/s)

Day	Oct	Nov	Dec	Jan	Feb	Mar	Apr	May	Jun	Jul	Aug	Sep
1	0	0	0	0	0	0	0	0	0	0	0.86	0
2	0	0	0	0	0	0	0	0	0	0	0.29	0
3	0	0	0	0	0	0	0	0	0	0	0.29	0
4	0	1.7	0	0	0	0	0	0	0	0	0.08	0
5	0	1.6	0	0	0	0	0	0	0	0	0	0
6	0	2.3	0	0	0	0	0	0	0	0	0	0
7	0	2.2	0	0	0	0	0	0	0	0	0	0
8	0	1.7	0	0	0	0	0	0	E	0	0	0
9	0	0.25	0	0	0	0	0	0	E	0	0	0
10	0	0.04	0	0	0	0	0	0	0	0	0	0
11	0	1.19	0	0	0	0	0	0	0	0	0	0
12	0	1.07	0	0	0	0	0	0	0	0	0	0
13	0	0.50	0	0	0	0	0	0	0	0	0	0
14	0	0.22	0	0	0	0	0	0	0	0.18	0	0
15	0	0	0	0	0	0	0	0	0	0.86	0	0
16	0	0	0	0	0	0	0	0	0	0.15	0	0
17	0	0	0	0	0	0	0	0	0	0.08	0	0
18	0	0	0	0	0	0	0	0	0	0	0	0
19	0	0	0.11	0	0	0	0	0	0	0	0	0
20	0	0	0.08	0	0	0	0	0	0	0	0	0
21	0	0	0	0	0	0	0	0	0	0	0	0
22	0	0	0	0	0	0	0	0	0	0	0	0
23	0	0	0	0	0	0	0	0	0	0	0	0
24	0	0	0	0	0	0	0	0	0	0	0	0
25	0	0	0	0	0	0	0	0	0	0	0	0
26	0	0	0	0	0	0	0	0	0	0	0	0
27	0	0	0	0	0	0	0	0	0	0	0	0
28	0	0	0	0	0	0	0	0	0	0	0	0
29	0	0	0	0		0	0	0	0	0.50	0	0
30	0	0	0	0		0	0	0	0	0	0	0
31	0		0	0		0		0		54	0	

E060.1 Monthly Summary Table

	Oct	Nov	Dec	Jan	Feb	Mar	Apr	May	Jun	Jul	Aug	Sep	WY
Total Volume (acre-ft)	0	15	0.01	0	0	0	0	0	0	10	2.3	0	27
Max Daily Peak (ft ³ /s)	0	2.3	0.11	0	0	0	0	0	0	54	0.86	0	54
Min Daily Peak (ft ³ /s)	0	0	0	0	0	0	0	0	0	0	0	0	0
Missing Days	0	0	0	0	0	0	0	0	2	0	0	0	2

Sandia Watershed

The Sandia Canyon and Mortandad Canyon watersheds are located within the central part of LANL. The Sandia watershed heads on LANL property within Technical Area 03 (TA-03) at an elevation of approximately 7300 ft and trends east-southeast across LANL property, Bandelier National Monument, and San Ildefonso Pueblo. Sandia Canyon empties into the Rio Grande in White Rock Canyon at an elevation of 5450 ft. The area of the Sandia watershed is approximately 5.5 mi². There are no significant tributaries to the Sandia watershed. Perennial stream flow occurs in the upper and middle portions of the canyon system as a result of sanitary wastewater and cooling tower effluent discharge to the canyon from operating facilities. The only known perennial spring in the watershed (Sandia Spring) is located in lower Sandia Canyon near the Rio Grande. The Sandia watershed contains, or may influence, eight wetland areas totaling approximately 5.39 acres.

Figure 4 shows the total monthly volume of discharge for the five stream gage discharge stations within Sandia watershed. Station E123 is located downstream of the Sandia wetland. Gage stations E121 and E122 both discharge into the wetland. Station E121 is directly downstream from the power plant and receives a constant or nearly constant base flow from the power plant. Station E124 is located in lower Sandia Canyon, adjacent to East Jemez Road. Station E125 is located near the edge of LANL property at the intersection of East Jemez Road and NM-4. Both E124 and E125 rarely have flow. Variations within the discharge are the result of the precipitation events throughout the monsoon season or a change in the volume of effluent from the cooling tower.

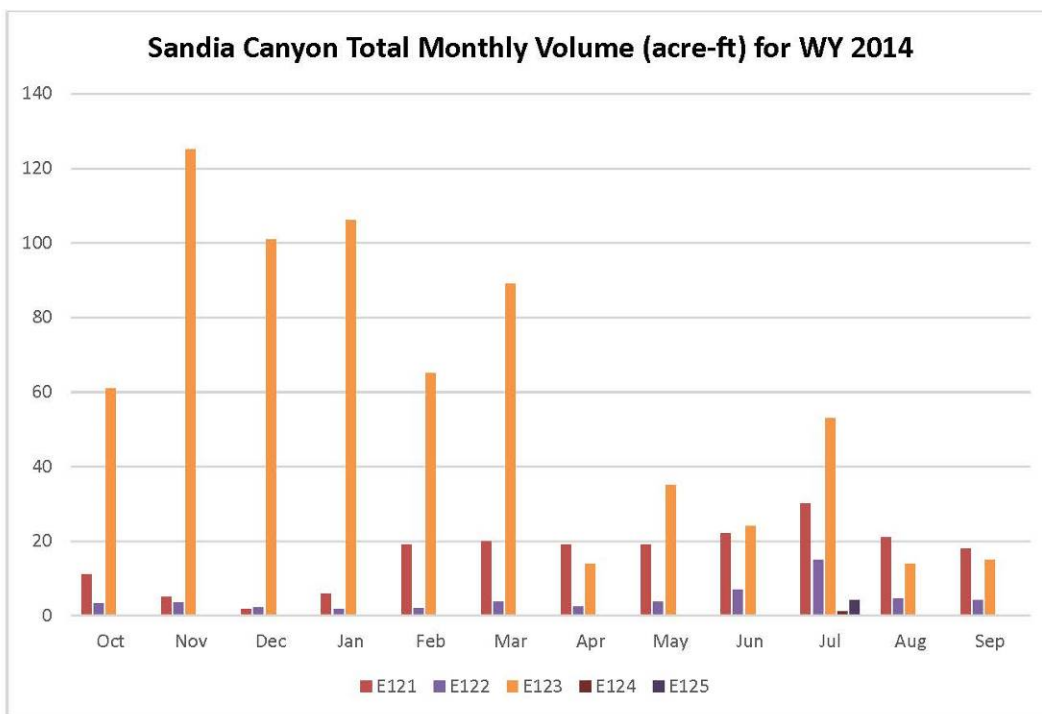

Figure 4 The total monthly volume (acre-ft) for WY2014 for Sandia Canyon

Surface Water Data, Water Year 2014

E121 Sandia Canyon Right Fork at Power Plant

Location. Lat 35° 52' 31", long -106° 19' 7", SW ¼, Sec. 16, T. 19 N., R. 6 E., Los Alamos County.

Drainage Area. 0.08 mi².

Period of Record. October 1, 2006, to September 30, 2014.

Revised Record. Period of record (2008).

Gage. Data logger with radio telemetry. Elevation of gage is 7280 ft using LANL LIDAR DEM with NAD 83.

Average Volume. 3 yr, 275 acre-ft/yr.

Maximum Discharge for Current Water Year. Maximum discharge, 191 ft³/s, June 21, 2002, from peak-flow computation, gage height 7.62 ft.

Maximum Discharge for Period of Record. Maximum discharge, 66 ft³/s, July 31, 2014, gage height 7.25 ft.

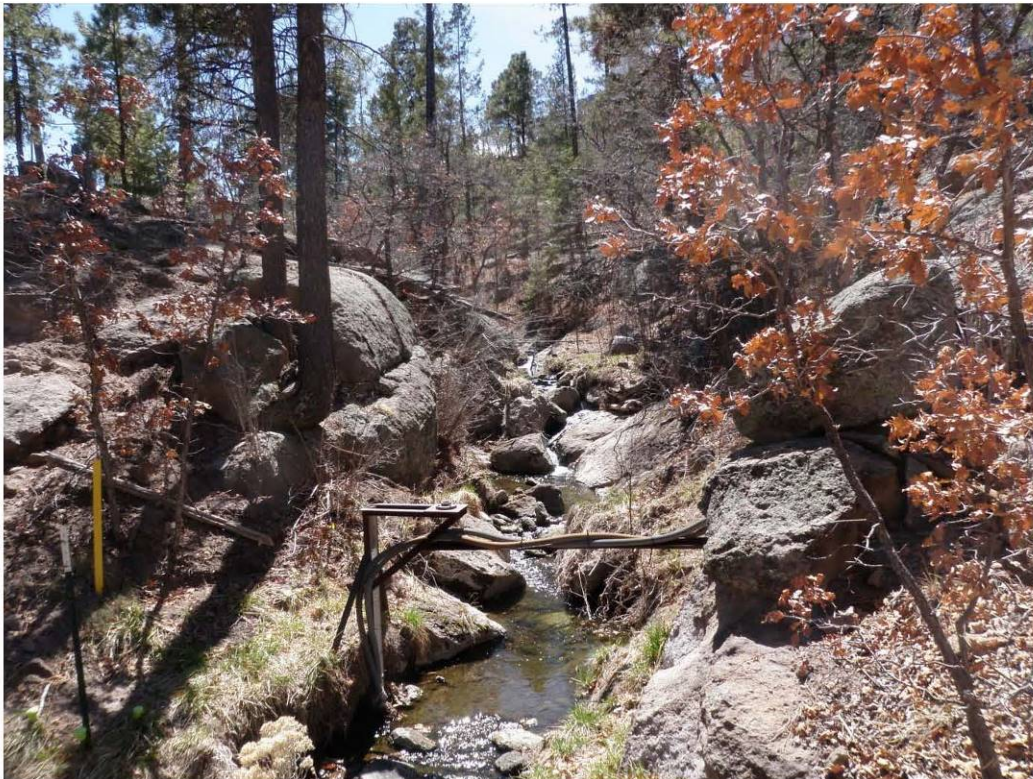

E121 Stream gage upstream view

Surface Water Data, Water Year 2014

Equipment. The station is equipped with a Sutron 9210 data logger (5-min interval), an MDS 4710 radio transceiver, and a Sutron Accubar bubble sensor. The system is powered by a solar-panel battery system housed in a NEMA shelter. The station is equipped with an ISCO pump sampler (12-count 1-L glass and polyethylene bottles) to collect water-quality samples. The ISCO sampler is housed in a separate shelter, a 3- × 4-ft metal box. The sampler is triggered by stage through the data logger. An outside staff gage is available for reference. No provision has been made for direct measurements above the wading stage.

Fieldwork

Number of Stream Gage Inspections	Number of Stream Gage Maintenance Visits	Number of ISCO 12-Count Sampler Inspections	Number of ISCO 12-Count Sampler Maintenance Visits	Number of ISCO 24-Count Sampler Inspections	Number of ISCO 24-Count Sampler Maintenance Visits
20	3	13	1	14	0

Datum Correction. None.

Gage-Height Record. The data logger referenced to the outside staff gage gave a complete and satisfactory record for the year, except for January 23, 2014, when maintenance was performed.

Rating. The channel is straight for about 30 ft with a steep upstream slope and straight for 50 ft downstream with a sharp slope. The streambed through this reach consists primarily of sand, gravel, and cobbles, more so below the gage. The low-water control is a bedrock riffle below the gage.

Rating No. 5 was developed based on previous measurements verified with the current year's measurements.

Eight discharge measurements were made during the year.

Discharge. Discharge was computed by applying Rating No. 5.

Surface Water Data, Water Year 2014

E121 Daily Mean Discharge (ft³/s)

Day	Oct	Nov	Dec	Jan	Feb	Mar	Apr	May	Jun	Jul	Aug	Sep
1	0.37	0.24	0.16	0.02	0.35	1.2	0.41	0.39	0.35	0.44	1.3	0.34
2	0.35	0.20	0.27	0.02	0.35	0.48	0.43	0.34	0.35	0.46	0.41	0.39
3	0.34	0.21	0.29	0.02	0.35	0.35	0.39	0.41	0.35	0.41	0.41	0.37
4	0.35	0.44	0.24	0.02	0.37	0.43	0.39	0.34	0.30	0.43	23	0.34
5	0.37	0.34	0.03	0.02	0.46	0.35	0.39	0.32	0.29	0.41	0.41	3.1
6	0.41	0.23	0.03	0.02	0.46	0.35	0.37	0.29	0.41	0.41	0.41	0.37
7	0.35	0.29	0.02	0.02	0.46	0.30	0.46	0.29	4.2	63	0.39	0.35
8	0.37	0.27	0.02	0.02	0.46	0.35	0.41	0.30	0.41	61	0.39	0.39
9	0.39	0.26	0.02	0.02	0.35	0.30	0.39	0.30	0.41	2.5	0.50	0.37
10	1.5	0.32	0.04	0.02	0.46	0.34	0.39	0.43	0.39	0.64	0.43	0.34
11	0.34	0.27	0.06	0.02	0.37	0.34	0.37	0.27	0.34	0.39	0.39	0.26
12	0.32	0.34	0.07	0.02	0.37	0.34	0.43	0.29	0.43	0.30	0.37	0.32
13	0.37	0.24	0.12	0.02	0.35	0.39	0.48	0.32	0.48	0.29	0.37	0.34
14	0.32	0.26	0.09	0.02	0.39	1.1	0.30	0.35	0.41	0.32	0.37	0.35
15	0.34	0.27	0.15	0.02	0.37	0.39	0.35	0.34	0.41	10	10	0.41
16	0.64	0.23	0.24	0.02	0.35	0.34	0.37	0.34	0.41	2.6	0.35	0.39
17	0.35	0.26	0.26	0.02	0.39	0.35	0.32	0.34	0.41	0.68	0.39	0.64
18	0.35	0.21	0.26	0.02	0.37	0.34	0.34	0.44	0.41	0.37	0.48	0.39
19	0.35	0.32	0.02	0.03	0.37	0.32	0.34	0.32	0.41	11	0.35	0.61
20	0.32	0.17	0.02	0.02	0.34	0.39	0.35	0.29	0.34	0.43	0.29	0.39
21	0.32	0.24	0.02	0.02	0.37	0.32	0.34	0.30	1.7	0.43	0.37	0.37
22	0.30	0.11	0.02	0.02	0.37	0.32	0.32	1.6	0.39	0.32	0.81	0.43
23	0.30	0.03	0.02	T	0.35	0.35	0.34	13	0.43	0.23	0.35	0.41
24	0.50	0.03	0.02	0.34	0.39	0.37	0.34	1.40	0.43	0.21	0.35	0.32
25	0.26	0.11	0.02	0.39	0.35	0.39	0.43	0.77	0.37	0.32	0.41	0.21
26	0.32	0.12	0.02	0.37	0.37	0.34	0.34	0.35	0.34	0.39	0.46	0.29
27	0.21	0.10	0.02	0.37	1.0	0.35	0.32	0.34	0.34	29	0.39	0.35
28	0.24	0.15	0.02	0.35	0.34	0.37	0.32	0.35	0.41	0.43	0.24	0.34
29	0.27	0.17	0.02	0.41		0.39	0.37	0.43	0.41	36	0.21	4.2
30	0.23	0.23	0.02	0.35		0.34	0.29	0.35	0.41	0.27	0.35	0.37
31	0.24		0.02	0.37		0.35		0.35		66	0.35	

E121 Monthly Summary Table

	Oct	Nov	Dec	Jan	Feb	Mar	Apr	May	Jun	Jul	Aug	Sep	WY
Total Volume (acre-ft)	11	5.1	1.8	6	19	20	19	19	22	30	21	18	191
Max Daily Peak (ft³/s)	1.5	0.44	0.29	0.41	1.0	1.2	0.48	13	4.2	66	23	4.2	66
Min Daily Peak (ft³/s)	0.23	0.11	0.02	0.02	0.34	0.30	0.29	0.29	0.29	0.21	0.21	0.21	0.02
Missing Days	0	0	0	1	0	0	0	0	0	0	0	0	1

Surface Water Data, Water Year 2014

E122 Sandia Canyon near Roads and Grounds at TA-3

Location. Lat 35° 52' 31", long -106° 9' 6", SW ¼, Sec. 16, T. 19 N., R. 6 E., Los Alamos County.

Drainage Area. 0.08 mi².

Period of Record. October 1, 2006, to September 30, 2014.

Revised Record. None.

Gage. Data logger with radio telemetry. Elevation of gage is 7288 ft using LANL LIDAR DEM with NAD 83.

Average Volume. 3 yr, 61 acre-ft/yr.

Maximum Discharge for Period of Record. Maximum discharge, 18 ft³/s, September 13, 2013, gage height 3.03 ft.

Maximum Discharge for Current Water Year. Maximum discharge, 19 ft³/s, July 31, 2014, gage height 7.62 ft.



E122 Stream gage downstream view

Surface Water Data, Water Year 2014

Equipment. The station is equipped with a Sutron 9210 data logger (5-min interval), an MDS 4710 radio transceiver, and a Milltronics sonic probe. The system is powered by a solar-panel battery system housed in a NEMA shelter. The station is also equipped with an ISCO pump sampler to collect water-quality samples. The ISCO sampler is housed in a separate shelter, a 3- × 4-ft metal box. The sampler is triggered by stage through the data logger. An outside staff gage is available for reference. No provision has been made for discharge measurements above the wading stage.

Fieldwork

Number of Stream Gage Inspections	Number of Stream Gage Maintenance Visits	Number of ISCO 12-Count Sampler Inspections	Number of ISCO 12-Count Sampler Maintenance Visits	Number of ISCO 24-Count Sampler Inspections	Number of ISCO 24-Count Sampler Maintenance Visits
19	3	12	0	13	2

Datum Correction. None. The levels of July 25, 2005, found the gage to be within limits.

Gage-Height Record. The data logger referenced to the outside staff gage gave a complete and satisfactory record the entire year.

Rating. The channel is straight for about 20 ft above the gage with a steep downstream slope and straight for 15 ft downstream with a sharp slope 5 ft downstream. The streambed through this reach is primarily bedrock with some cobbles below the gage. The low-water control is a bedrock riffle below the gage.

Rating No. 2 was developed based on the measurements made the previous year and verified with measurements made this year.

Seven discharge measurements were made during the year.

Discharge. Discharge was computed from Rating No. 2.

Surface Water Data, Water Year 2014

E122 Daily Mean Discharge (ft³/s)

Day	Oct	Nov	Dec	Jan	Feb	Mar	Apr	May	Jun	Jul	Aug	Sep
1	0.07	0.15	0.17	0.13	0.13	0.98	0.17	0.15	0.21	0.29	0.34	0.11
2	0.19	0.18	0.18	0.11	0.14	0.32	0.15	0.17	0.17	0.26	0.13	0.14
3	0.16	0.16	0.20	0.19	0.15	0.16	0.12	0.17	0.18	0.39	0.14	0.15
4	0.16	2.3	0.18	0.13	0.14	0.16	0.14	0.18	0.18	0.39	5.3	0.12
5	0.15	0.25	0.17	0.11	0.12	0.17	0.15	0.15	0.26	0.27	0.15	1.6
6	0.18	0.15	0.16	0.11	0.13	0.17	0.15	0.17	0.26	0.34	0.15	0.11
7	0.16	0.19	0.16	0.13	0.15	0.19	0.13	0.17	2.4	13	0.14	0.12
8	0.15	0.17	0.16	0.13	0.15	0.15	0.16	0.17	0.29	9.7	0.14	0.13
9	0.15	0.16	0.14	0.15	0.16	0.19	0.16	0.19	0.25	0.34	0.15	0.11
10	1.7	0.18	0.16	0.12	0.22	0.20	0.19	0.17	0.33	0.93	0.13	0.12
11	0.16	0.18	0.15	0.13	0.17	0.18	0.16	0.17	0.25	0.34	0.13	0.14
12	0.17	0.17	0.18	0.14	0.16	0.13	0.15	0.17	0.26	0.29	0.13	0.14
13	0.53	0.16	0.16	0.14	0.17	0.13	0.54	0.15	0.49	0.30	0.13	0.13
14	0.15	0.17	0.17	0.13	0.18	0.90	0.15	0.18	0.25	3.6	0.13	0.13
15	0.56	0.58	0.16	0.15	0.20	0.22	0.16	0.19	0.29	3.7	3.0	0.11
16	0.62	0.33	0.16	0.15	0.19	0.15	0.15	0.18	0.25	1.2	0.13	0.11
17	0.17	0.16	0.18	0.17	0.19	0.14	0.17	0.30	0.27	0.27	0.12	0.11
18	0.18	0.17	0.13	0.15	0.16	0.13	0.14	0.33	0.26	0.30	0.13	0.14
19	0.17	0.18	0.15	0.17	0.18	0.12	0.16	0.17	0.26	5.2	0.14	0.13
20	0.20	0.16	0.13	0.18	0.14	0.17	0.15	0.21	0.26	0.30	0.13	0.12
21	0.16	1.0	0.13	0.18	0.18	0.15	0.16	0.19	1.4	0.37	0.13	0.12
22	0.16	0.34	0.13	0.17	0.19	0.12	0.14	1.4	0.32	0.29	0.27	0.15
23	0.17	0.19	0.13	0.13	0.17	0.15	0.13	5.8	0.26	0.27	0.12	0.12
24	1.5	0.18	0.17	0.17	0.16	0.17	0.14	1.3	0.27	0.30	0.13	0.15
25	0.23	0.23	0.14	0.17	0.19	0.16	0.18	0.45	0.29	0.27	0.13	0.14
26	0.17	0.18	0.15	0.18	0.15	0.15	0.26	0.21	0.26	0.34	0.15	0.14
27	0.17	0.15	0.12	0.17	0.95	0.12	0.17	0.21	0.27	6.2	0.14	0.15
28	0.16	0.16	0.16	0.14	0.17	0.13	0.13	0.22	0.26	1.1	0.11	0.13
29	0.17	0.17	0.13	0.20		0.13	0.17	0.18	0.29	12	0.15	0.56
30	0.19	0.22	0.12	0.20		0.14	0.13	0.21	0.27	0.49	0.14	0.15
31	0.15		0.11	0.15		0.14		0.18		19	0.15	

E122 Monthly Summary Table

	Oct	Nov	Dec	Jan	Feb	Mar	Apr	May	Jun	Jul	Aug	Sep	WY
Total Volume (acre-ft)	3.3	3.6	2.2	1.9	2.1	3.1	2.5	3.8	6.9	15	4.6	4.1	53.8
Max Daily Peak (ft ³ /s)	1.7	2.3	0.20	0.20	0.95	0.98	0.26	5.8	2.4	19	5.3	1.6	19
Min Daily Peak (ft ³ /s)	0.07	0.15	0.11	0.11	0.13	0.12	0.13	0.15	0.21	0.27	0.11	0.11	0.07
Missing Days	0	0	0	0	0	0	0	0	0	0	0	0	0

Surface Water Data, Water Year 2014

E123 Sandia Canyon below Wetlands

Location. Lat 35° 52' 23", long -106° 18' 35", SE ¼, Sec. 16, T. 19 N., R. 6 E., Los Alamos County.

Drainage Area. 0.29 mi².

Period of Record. August 1, 1999, to September 30, 2014.

Revised Record. Drainage area (2006); Section (2007).

Gage. Data logger with radio telemetry. Elevation of gage is 7201 ft using LANL LIDAR DEM with NAD 83.

Average Volume. 3 yr, 607 acre-ft/yr.

Maximum Discharge for Period of Record. Maximum discharge 110 ft³/s, September 13, 2013, gage height 4.86 ft.

Maximum Discharge for Current Water Year. Maximum discharge, 109 ft³/s, July 31, 2014, gage height 4.89 ft.



E123 Stream gage upstream view

Surface Water Data, Water Year 2014

Equipment. The station is equipped with a Sutron 9210 data logger (5-min interval), an MDS 4710 radio transceiver, and a Sutron Accubar bubble sensor. The system is powered by a solar-panel battery system housed in a NEMA shelter. The station is also equipped with an ISCO pump sampler to collect water-quality samples. The ISCO sampler is housed in a separate shelter, a 3- × 4-ft steel storage box. The sampler is triggered by stage through the data logger. An outside staff gage is available for reference. No provision has been made for discharge measurements above the wading stage.

An auxiliary 6-in. Parshall flume, located downstream from E123, is used to verify the low-flow record.

Fieldwork

Number of Stream Gage Inspections	Number of Stream Gage Maintenance Visits	Number of ISCO 12-Count Sampler Inspections	Number of ISCO 12-Count Sampler Maintenance Visits	Number of ISCO 24-Count Sampler Inspections	Number of ISCO 24-Count Sampler Maintenance Visits
23	3	13	0	13	0

Datum Correction. None; the levels run June 27, 2008, were found to be within limits.

Gage-Height Record. The data logger referenced to the inside gage height gave a complete and satisfactory record for the year, except for December 10, 11, 24–28, 30, and 31, 2013; January 1, 2, 3, 5–9, 13–19, 21–26, 28, and 29, 2014; and February 5 and 6, 2014, when the gage was affected by ice.

Rating. The channel is trapezoidal with a rock outcrop and small depositional bars within pools. The banks have some grass, not very tall or thick. The channel is straight for about 100 ft above and below the gage. Rating No.5 was developed based on low-flow measurements and point-of-zero flow measurements during the water year and a slope-area measurement high flow in 2005.

Four discharge measurements were made during the year.

Discharge. Discharge was computed from Rating No. 5.

Surface Water Data, Water Year 2014

E123 Daily Mean Discharge (ft³/s)

Day	Oct	Nov	Dec	Jan	Feb	Mar	Apr	May	Jun	Jul	Aug	Sep
1	6.7	4.8	2.7	I*	1.9	7.2	0.66	0.66	0.90	0.55	2.5	0.28
2	1.8	4.8	3.5	I	1.9	4.1	0.50	0.78	0.97	0.55	0.13	0.32
3	0.60	4.8	2.8	I	2.0	2.3	0.60	1.0	0.66	0.45	0.10	0.28
4	0.50	15	3.5	2.4	2.1	2.6	0.66	1.1	0.25	0.45	32	0.15
5	0.97	3.5	2.7	I	I	2.6	0.66	0.66	0.15	0.50	0.18	5.6
6	1.7	3.5	10	I	I	2.2	0.25	0.25	0.41	0.50	0.28	0.32
7	0.72	3.3	12	I	3.1	1.6	1.1	0.28	12	80	0.25	0.36
8	0.78	4.1	3.0	I	2.7	2.0	1.5	0.41	0.90	76	0.21	0.36
9	1.1	3.1	3.2	I	2.2	1.4	1.0	0.45	0.78	2.1	0.28	0.32
10	11	3.2	I	2.2	3.1	1.9	0.66	0.45	0.72	1.3	0.25	0.25
11	1.6	3.1	I	3.0	2.4	1.7	0.78	0.21	0.41	0.66	0.21	0.15
12	1.2	3.6	3.0	2.3	2.2	1.9	0.21	0.25	0.78	0.21	0.18	0.25
13	3.3	4.0	3.7	I	2.3	2.0	2.0	0.36	1.5	0.25	0.18	0.28
14	0.90	3.3	3.3	I	2.6	6.0	0.36	0.66	0.60	12	0.15	0.32
15	6.0	3.5	5.3	I	2.4	3.3	0.78	0.55	0.55	20	12	0.45
16	6.0	3.5	2.5	I	2.1	1.7	0.84	0.60	0.55	2.8	0.15	0.41
17	1.8	4.0	2.5	I	2.4	2.0	0.10	0.55	0.55	0.55	0.36	0.66
18	1.4	5.0	2.8	I	2.3	2.3	0.84	0.84	0.55	0.25	0.32	0.45
19	1.4	7.9	2.5	I	2.2	2.1	0.21	0.28	0.50	18	0.28	0.55
20	1.3	7.2	2.3	2.6	1.9	2.4	0.10	0.10	0.18	0.25	0.15	0.36
21	1.4	8.7	2.3	I	2.5	1.7	0.28	0.41	3.2	0.50	0.25	0.36
22	2.0	3.5	2.4	I	2.4	1.6	0.15	7.9	0.55	0.18	1.2	0.50
23	6.8	2.8	2.8	I	2.2	1.2	0.32	18	0.60	0.07	0.28	0.45
24	13	3.5	I	I	2.6	1.9	0.21	9.8	0.50	0.05	0.32	0.15
25	6.1	4.0	I	I	2.2	2.0	0.41	3.5	0.15	0.13	0.36	0.10
26	6.0	3.8	I	I	2.2	1.6	0.55	1.6	0.18	0.28	0.55	0.25
27	6.0	3.7	I	2.1	6.3	1.3	0.50	1.5	0.18	26	0.36	0.32
28	6.0	2.5	I	I	2.3	1.4	0.90	1.2	0.50	3.2	0.10	0.32
29	6.0	3.2	2.1	I		1.4	0.45	1.1	0.50	62	0.10	2.8
30	6.3	3.5	I	2.2		0.28	0.50	1.0	0.60	0.28	0.28	0.28
31	5.2		I	2.2		0.60		0.90		109	0.32	

*I represents ice present.

E123 Monthly Summary Table

	Oct	Nov	Dec	Jan	Feb	Mar	Apr	May	Jun	Jul	Aug	Sep	WY
Total Volume (acre-ft)	61	125	101	106	65	89	14	35	24	53	14	15	702
Max Daily Peak (ft ³ /s)	6.8	15	12	3.0	6.3	7.2	1.5	9.8	12	109	32	5.6	109
Min Daily (ft ³ /s)	0.78	3.1	2.1	2.1	1.9	1.3	0.21	0.21	0.25	0.21	0.10	0.15	12
Missing Days	0	0	9	23	2	0	0	0	0	0	0	0	34

Surface Water Data, Water Year 2014

E124 Sandia above Firing Range

Location. Lat 35° 51' 54.90" N, long -106° 15' 46.36" W, Zone 13S, NM23, T. 19 N., R. 6 E., Los Alamos County.

Drainage Area. 1.14 mi².

Period of Record. October 1, 2013, to September 30, 2014.

Revised Record. None.

Gage. Data logger with radio telemetry. Elevation of gage is 6736 ft using LANL LIDAR DEM with NAD 83.

Average Volume. <1 yr, 1 acre-ft/yr.

Maximum Discharge for Period of Record. Maximum discharge 50 ft³/s, July 31, 2014, gage height 2.2 ft.

Maximum Discharge for Current Water Year. Maximum discharge 50 ft³/s, July 31, 2014, gage height 2.2 ft.



E124 Stream gage upstream view

Surface Water Data, Water Year 2014

Equipment. The station is equipped with a Sutron 9210 data logger (5-min interval), an MDS 4710 radio transceiver, and a Sutron Accubar bubble sensor. The system is powered by a solar-panel battery system housed in a NEMA shelter. The station is equipped with an ISCO pump sampler to collect water-quality samples. The ISCO sampler is housed in a separate shelter, a 3- × 4-ft metal box. The sampler is triggered by stage through the data logger. An outside staff gage is available for reference. No provision has been made for direct measurements above the wading stage.

Fieldwork

Number of Stream Gage Inspections	Number of Stream Gage Maintenance Visits	Number of ISCO 12-Count Sampler Inspections	Number of ISCO 12-Count Sampler Maintenance Visits	Number of ISCO 24-Count Sampler Inspections	Number of ISCO 24-Count Sampler Maintenance Visits
9	2	7	0	n/a*	n/a

* n/a = Not applicable.

Datum Correction. None.

Gage-Height Record. The data logger referenced to the outside staff gage gave a complete and satisfactory record from July 25, 2014, through September 30, 2014. The gage was installed on July 25, 2014.

Rating. Rating No. 2 was developed based on slope-area computations and discharge measurements.

Discharge. Discharge was computed from Rating No. 2

Surface Water Data, Water Year 2014

E124 Daily Peak Discharge (ft³/s)

Day	Oct	Nov	Dec	Jan	Feb	Mar	Apr	May	Jun	Jul	Aug	Sep
1	IA*	IA	IA	IA	IA	IA	IA	IA	IA	IA	0	0
2	IA	IA	IA	IA	IA	IA	IA	IA	IA	IA	0	0
3	IA	IA	IA	IA	IA	IA	IA	IA	IA	IA	0	0
4	IA	IA	IA	IA	IA	IA	IA	IA	IA	IA	0	0
5	IA	IA	IA	IA	IA	IA	IA	IA	IA	IA	0	0
6	IA	IA	IA	IA	IA	IA	IA	IA	IA	IA	0	0
7	IA	IA	IA	IA	IA	IA	IA	IA	IA	IA	0	0
8	IA	IA	IA	IA	IA	IA	IA	IA	IA	IA	0	0
9	IA	IA	IA	IA	IA	IA	IA	IA	IA	IA	0	0
10	IA	IA	IA	IA	IA	IA	IA	IA	IA	IA	0	0
11	IA	IA	IA	IA	IA	IA	IA	IA	IA	IA	0	0
12	IA	IA	IA	IA	IA	IA	IA	IA	IA	IA	0	0
13	IA	IA	IA	IA	IA	IA	IA	IA	IA	IA	0	0
14	IA	IA	IA	IA	IA	IA	IA	IA	IA	IA	0	0
15	IA	IA	IA	IA	IA	IA	IA	IA	IA	IA	0	0
16	IA	IA	IA	IA	IA	IA	IA	IA	IA	IA	0	0
17	IA	IA	IA	IA	IA	IA	IA	IA	IA	IA	0	0
18	IA	IA	IA	IA	IA	IA	IA	IA	IA	IA	0	0
19	IA	IA	IA	IA	IA	IA	IA	IA	IA	IA	0	0
20	IA	IA	IA	IA	IA	IA	IA	IA	IA	IA	0	0
21	IA	IA	IA	IA	IA	IA	IA	IA	IA	IA	0	0
22	IA	IA	IA	IA	IA	IA	IA	IA	IA	IA	0	0
23	IA	IA	IA	IA	IA	IA	IA	IA	IA	IA	0	0
24	IA	IA	IA	IA	IA	IA	IA	IA	IA	IA	0	0
25	IA	IA	IA	IA	IA	IA	IA	IA	IA	0	0	0
26	IA	IA	IA	IA	IA	IA	IA	IA	IA	0	0	0
27	IA	IA	IA	IA	IA	IA	IA	IA	IA	0	0	0
28	IA	IA	IA	IA	IA	IA	IA	IA	IA	0	0	0
29	IA	IA	IA	IA		IA	IA	IA	IA	0.20	0	0
30	IA	IA	IA	IA		IA	IA	IA	IA	0	0	0
31	IA		IA	IA		IA		IA		50	0	

* IA represents inactive. The gage was returned to service July 25.

E124 Monthly Summary Table

	Oct	Nov	Dec	Jan	Feb	Mar	Apr	May	Jun	Jul	Aug	Sep	WY
Total Volume (acre-ft)	IA*	IA	IA	IA	IA	IA	IA	IA	IA	1.1	0	0	1.1
Max Daily Peak (ft ³ /s)	IA	IA	IA	IA	IA	IA	IA	IA	IA	50	0	0	50
Min Daily Peak (ft ³ /s)	IA	IA	IA	IA	IA	IA	IA	IA	IA	0	0	0	0
Missing Days	31	30	31	31	28	31	30	31	30	24	0	0	297

* IA represents inactive. The gage was returned to service July 25.

Surface Water Data, Water Year 2014

E125 Sandia Canyon above SR 4

Location. Lat 35° 51' 32", long -106° 13' 34", SW ¼, Sec. 20, T. 19 N., R. 7 E., Santa Fe County.

Drainage Area. 2.05 mi².

Period of Record. October 1, 1994, to September 30, 2014.

Revised Record. Drainage area (2006).

Gage. Data logger with radio telemetry and concrete control. Elevation of gage is 6495 ft using LANL LIDAR DEM with NAD 83.

Average Volume. 3 yr, 6 acre-ft/yr.

Maximum Discharge for Period of Record. Maximum discharge, 104 ft³/s, September 13, 2013, gage height 5.08 ft.

Maximum Discharge for Current Water Year. Maximum discharge, 55 ft³/s, July 31, 2014, gage height 3.89 ft.



E125 Stream gage upstream view

Surface Water Data, Water Year 2014

Equipment. The station is equipped with a Sutron 9210 data logger (5-min interval), an MDS 4710 radio transceiver, and a shaft encoder float system. The system is powered by a solar-panel battery system. All equipment is housed in a NEMA shelter on an 18-in. CMP well. The station is equipped with an ISCO pump sampler (12-count 1-L glass and polyethylene bottles) to collect water-quality samples. The ISCO sampler is housed in a separate shelter, a 3- × 4-ft metal box. The sampler is triggered by stage through the data logger. The control is a concrete broad-crested weir. No provision has been made for measurements above the wading stage.

Fieldwork

Number of Stream Gage Inspections	Number of Stream Gage Maintenance Visits	Number of ISCO 12-Count Sampler Inspections	Number of ISCO 12-Count Sampler Maintenance Visits	Number of ISCO 24-Count Sampler Inspections	Number of ISCO 24-Count Sampler Maintenance Visits
22	6	7	1	n/a*	n/a

* n/a = Not applicable.

Datum Correction. None.

Gage-Height Record. The data logger referenced to the outside staff gage gave a complete and satisfactory record for the year, except for July 2 through July 28, 2014, because of equipment malfunction.

Rating. The channel is straight for 150 ft above and 100 ft below the gage. The bed material is sand with vegetation on the banks, and the bottom is well supported.

Rating No. 2 was developed and applied beginning October 1, 2009, to account for 1 ft of channel aggradation along the reach. The channel slopes smoothly through the reach, replacing the broad-crested concrete weir as the control. The rating was computed using Manning's equation and measured channel characteristics of the 2-ft point of zero flow (PZF) to top of weir walls at 3.20 ft. Greater flow will require the extension of Rating No. 2 with a more detailed channel survey.

No discharge measurements were made during the year.

Discharge. Discharge was directly computed from Rating No. 2.

Surface Water Data, Water Year 2014

E125 Daily Peak Discharge (ft³/s)

Day	Oct	Nov	Dec	Jan	Feb	Mar	Apr	May	Jun	Jul	Aug	Sep
1	0	0	0	0	0	0	0	0	0	0	0	0
2	0	0	0	0	0	0	0	0	0	E*	0	0
3	0	0	0	0	0	0	0	0	0	E	0	0
4	0	0	0	0	0	0	0	0	0	E	0	0
5	0	0	0	0	0	0	0	0	0	E	0	0
6	0	0	0	0	0	0	0	0	0	E	0	0
7	0	0	0	0	0	0	0	0	0	E	0	0
8	0	0	0	0	0	0	0	0	0	E	0	0
9	0	0	0	0	0	0	0	0	0	E	0	0
10	0	0	0	0	0	0	0	0	0	E	0	0
11	0	0	0	0	0	0	0	0	0	E	0	0
12	0	0	0	0	0	0	0	0	0	E	0	0
13	0	0	0	0	0	0	0	0	0	E	0	0
14	0	0	0	0	0	0	0	0	0	E	0	0
15	0	0	0	0	0	0	0	0	0	E	0	0
16	0	0	0	0	0	0	0	0	0	E	0	0
17	0	0	0	0	0	0	0	0	0	E	0	0
18	0	0	0	0	0	0	0	0	0	E	0	0
19	0	0	0	0	0	0	0	0	0	E	0	0
20	0	0	0	0	0	0	0	0	0	E	0	0
21	0	0	0	0	0	0	0	0	0	E	0	0
22	0	0	0	0	0	0	0	0	0	E	0	0
23	0	0	0	0	0	0	0	0	0	E	0	0
24	0	0	0	0	0	0	0	0	0	E	0	0
25	0	0	0	0	0	0	0	0	0	E	0	0
26	0	0	0	0	0	0	0	0	0	E	0	0
27	0	0	0	0	0	0	0	0	0	E	0	0
28	0	0	0	0	0	0	0	0	0	E	0	0
29	0	0	0	0		0	0	0	0	3.4	0	0
30	0	0	0	0		0	0	0	0	0	0	0
31	0		0	0		0		0		55	0	

* E represents equipment failure.

E125 Monthly Summary Table

	Oct	Nov	Dec	Jan	Feb	Mar	Apr	May	Jun	Jul	Aug	Sep	WY
Total Volume (acre-ft)	0	0	0	0	0	0	0	0	0	4.2	0	0.26	4.5
Max Daily Peak (ft ³ /s)	0	0	0	0	0	0	0	0	0	55	0	6.3	55
Min Daily Peak (ft ³ /s)	0	0	0	0	0	0	0	0	0	0	0	0	0
Missing Days	0	0	0	0	0	0	0	0	0	27	0	0	27

Surface Water Data, Water Year 2014

Mortandad Watershed

The Mortandad Canyon watershed is located in the central portion of LANL and covers approximately 10 mi². The watershed contains a stream that is entirely ephemeral; neither perennial springs nor natural perennial reaches occur. The Mortandad watershed trends east-to-southeast and heads on the Pajarito Plateau near the main LANL complex at TA-03 at an elevation of 7380 ft. The drainage extends from its headwaters to its confluence with the Rio Grande at an elevation of 5440 ft. Mortandad Canyon crosses San Ildefonso Pueblo land for several miles before joining the Rio Grande. The Mortandad watershed may be influenced by two significant tributaries: Ten Site Canyon and Cañada del Buey. Snowmelt runoff and storm water runoff from seasonal snow and rain storms flow for a limited distance in the upper canyon and occasionally as far as the sediment traps. Ten Site Canyon lies south of and extends parallel to Mortandad Canyon for about 1.5 mi. Ten Site Canyon joins Mortandad Canyon in the lower portion of the drainage. Cañada del Buey heads on LANL property at TA-52 and TA-36 at an elevation of approximately 7200 ft and trends east-southeast across LANL, San Ildefonso Pueblo land, and Los Alamos County and ends at its confluence with Mortandad Canyon at an elevation of 5620 ft, approximately 0.5 mi upstream of the Rio Grande.

Figure 5 shows the total monthly volume of discharge at the four stream gage stations within the Mortandad Canyon and Cañada del Buey watershed.

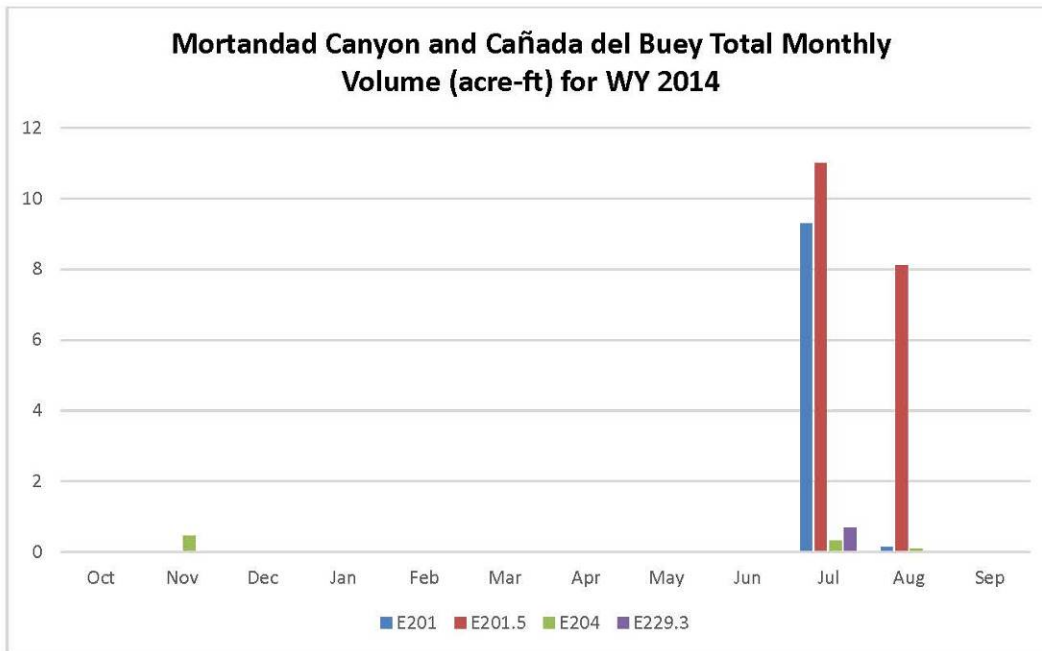

Figure 5 Total monthly volume (acre-ft) for WY2014 in Mortandad Canyon and Cañada del Buey

Surface Water Data, Water Year 2014

E201 Mortandad Canyon above Ten Site Canyon

Location. Lat 35° 51' 46", long -106° 16' 29", SW ¼, Sec. 22, T. 19 N., R. 6 E., Los Alamos County.

Drainage Area. 0.25 mi².

Period of Record. October 1, 2006, to September 30, 2014.

Revised Record. Period of Record (2008).

Gage. Data logger with radio telemetry and a steel-fabricated nonstandard flume. Elevation of the gage is 6865 ft using LANL LIDAR DEM with NAD 83.

Average Volume. 3 yr, 10 acre-ft/yr.

Maximum Discharge for Period of Record. Maximum discharge, 107 ft³/s, September 13, 2013, gage height 3.0 ft.

Maximum Discharge for Current Water Year. Maximum discharge, 93 ft³/s, July 31, 2014, gage height 2.73 ft.



E201 Stream gage upstream view

Surface Water Data, Water Year 2014

Equipment. The station is equipped with a Sutron 9210 data logger (5-min interval), an MDS 4710 radio transceiver, and a Milltronics sonic probe mounted on a 10-ft flume. The system is powered by a solar-panel battery system housed in a NEMA shelter. The station is equipped with an ISCO pump sampler to collect water-quality samples. The ISCO sampler is housed in a separate shelter, a 3- x 4-ft metal box. The sampler is triggered by stage through the data logger. An outside staff gage is available for reference. No provision has been made for measurements above the wading stage.

Fieldwork

Number of Stream Gage Inspections	Number of Stream Gage Maintenance Visits	Number of ISCO 12-Count Sampler Inspections	Number of ISCO 12-Count Sampler Maintenance Visits	Number of ISCO 24-Count Sampler Inspections	Number of ISCO 24-Count Sampler Maintenance Visits
17	8	5	2	n/a*	n/a

* n/a = Not applicable.

Datum Correction. None.

Gage-Height Record. The data logger referenced to the outside staff gage gave a complete and satisfactory record, except for November 23, 2013, through December 14, 2013; and February 13 and 14, 2014, when the gage was affected by ice.

Rating. The channel is straight above and below the modified flume. Flow is confined to the cutbanks. The channel bottom is 3 ft wide with some vegetation above and below the flume.

The streambed is sand and gravel, and the flume is subject to fill from low-flow events. The control is a fabricated steel flume 10 ft at the throat.

Rating No. 2 was developed based on slope-area computations and discharge measurements.

No discharge measurements were made during the year.

Discharge. Discharge was computed by directly applying Rating No. 2.

Surface Water Data, Water Year 2014

E201 Daily Peak Discharge (ft³/s)

Day	Oct	Nov	Dec	Jan	Feb	Mar	Apr	May	Jun	Jul	Aug	Sep
1	0	0	l	0	0	0	0	0	0	0	0	0
2	0	0	l	0	0	0	0	0	0	0	0	0
3	0	0	l	0	0	0	0	0	0	0	0	0
4	0	0	l	0	0	0	0	0	0	0	1.2	0
5	0	0	l	0	0	0	0	0	0	0	0	0
6	0	0	l	0	0	0	0	0	0	0	0	0
7	0	0	l	0	0	0	0	0	0	0	0	0
8	0	0	l	0	0	0	0	0	0	71	0	0
9	0	0	l	0	0	0	0	0	0	0.60	0	0
10	0	0	l	0	0	0	0	0	0	0	0	0
11	0	0	l	0	0	0	0	0	0	0	0	0
12	0	0	l	0	0	0	0	0	0	0	0	0
13	0	0	l	0	l	0	0	0	0	0	0	0
14	0	0	l	0	l	0	0	0	0	0	0	0
15	0	0	0	0	0	0	0	0	0	4.9	0	0
16	0	0	0	0	0	0	0	0	0	0.29	0	0
17	0	0	0	0	0	0	0	0	0	0	0	0
18	0	0	0	0	0	0	0	0	0	0	0	0
19	0	0	0	0	0	0	0	0	0	0.79	0	0
20	0	0	0	0	0	0	0	0	0	0	0	0
21	0	0	0	0	0	0	0	0	0	0	0	0
22	0	0	0	0	0	0	0	0	0	0	0	0
23	0	l	0	0	0	0	0	0	0	0	0	0
24	0	l	0	0	0	0	0	0	0	0	0	0
25	0	l	0	0	0	0	0	0	0	0	0	0
26	0	l	0	0	0	0	0	0	0	0	0	0
27	0	l	0	0	0	0	0	0	0	0	0	0
28	0	l	0	0	0	0	0	0	0	0	0	0
29	0	l	0	0		0	0	0	0	1.87	0	0
30	0	l	0	0		0	0	0	0	0	0	0
31	0		0	0		0		0		93	0	

E201 Monthly Summary Table

	Oct	Nov	Dec	Jan	Feb	Mar	Apr	May	Jun	Jul	Aug	Sep	WY
Total Volume (acre-ft)	0	0	0	0	0	0	0	0	0	9.3	0.13	0	9.43
Max Daily Peak (ft ³ /s)	0	0	0	0	0	0	0	0	0	93	1.2	0	93
Min Daily Peak (ft ³ /s)	0	0	0	0	0	0	0	0	0	0	0	0	0
Missing Days	0	8	14	15	2	0	0	0	0	0	0	0	39

Surface Water Data, Water Year 2014

E201.5 Ten Site Canyon above Mortandad Canyon

Location. Lat 35° 51' 38", long -106° 16' 30", SE ¼, Sec. 23, T. 19 N., R. 6 E., Los Alamos County.

Drainage Area. 0.32 mi².

Period of Record. October 2000 to September 30, 2014.

Revised record. Drainage area (2006).

Gage. Data logger with radio telemetry and 90° sharp-crested weir. Elevation of gage is 6858 ft using LANL LIDAR DEM with NAD 83.

Average Volume. 3 yr, 9 acre-ft/yr.

Maximum Discharge for Period of Record. Maximum discharge, 303 ft³/s, August 25, 2006, gage height 4.6 ft (from slope-area measurement of peak flow).

Maximum Discharge for Current Water Year. Maximum discharge, 105 ft³/s, July 14, 2014, gage height 4.0 ft.



E201.5 Stream gage upstream view

Surface Water Data, Water Year 2014

Equipment. The station is equipped with a Sutron 9210 data logger (5-min interval), an MDS 4710 radio transceiver, and a Sutron Accubar bubble sensor. The system is powered by a solar-panel battery system housed in a NEMA shelter. The station is also equipped with an ISCO pump sampler to collect water-quality samples. The ISCO sampler is housed in a separate shelter, a 3- × 4-ft metal box. The sampler is triggered by stage through the data logger. An outside staff gage is available for reference. No provisions have been made for measurements above the wading stage.

Fieldwork

Number of Stream Gage Inspections	Number of Stream Gage Maintenance Visits	Number of ISCO 12-Count Sampler Inspections	Number of ISCO 12-Count Sampler Maintenance Visits	Number of ISCO 24-Count Sampler Inspections	Number of ISCO 24-Count Sampler Maintenance Visits
22	8	5	0	n/a*	n/a

* n/a = Not applicable.

Datum Correction. On May 24, 2007, the gage was set to correct the datum. The gage was destroyed by flood on August 25, 2006. The bubbler outlet was reset to a gage datum of 1.33 ft.

Gage-Height Record. The data logger reference to the outside staff gage gave a complete and satisfactory record for the year.

Rating. The channel is about 8 ft wide and straight for about 60 ft upstream and straight for about 30 ft downstream. The streambed through this reach is primarily sand with gravel.

Rating No. 2 is based on a theoretical computation for the 90-degree sharp-crested weir and one critical-depth computation.

No discharge measurements were made during the year.

Discharge. Discharge was computed by directly applying Rating No. 2.

Surface Water Data, Water Year 2014

E201.5 Daily Peak Discharge (ft³/s)

Day	Oct	Nov	Dec	Jan	Feb	Mar	Apr	May	Jun	Jul	Aug	Sep
1	0	0	0	0	0	0	0	0	0	0	0	0
2	0	0	0	0	0	0	0	0	0	0	0	0
3	0	0	0	0	0	0	0	0	0	0	23	0
4	0	0	0	0	0	0	0	0	0	0	2.9	0
5	0	0	0	0	0	0	0	0	0	0	0	0
6	0	0	0	0	0	0	0	0	0	0	0	0
7	0	0	0	0	0	0	0	0	0	0	0	0
8	0	0	0	0	0	0	0	0	0	0	0	0
9	0	0	0	0	0	0	0	0	0	0	0	0
10	0	0	0	0	0	0	0	0	0	0	0	0
11	0	0	0	0	0	0	0	0	0	0	0	0
12	0	0	0	0	0	0	0	0	0	0	0	0
13	0	0	0	0	0	0	0	0	0	0	0	0
14	0	0	0	0	0	0	0	0	0	105	0	0
15	0	0	0	0	0	0	0	0	0	0	0	0
16	0	0	0	0	0	0	0	0	0	0	0	0
17	0	0	0	0	0	0	0	0	0	0	0	0
18	0	0	0	0	0	0	0	0	0	3.8	0	0
19	0	0	0	0	0	0	0	0	0	0	0	0
20	0	0	0	0	0	0	0	0	0	0	0	0
21	0	0	0	0	0	0	0	0	0	0	0	0
22	0	0	0	0	0	0	0	0	0	0	0	0
23	0	0	0	0	0	0	0	0	0	0	0	0
24	0	0	0	0	0	0	0	0	0	0	0	0
25	0	0	0	0	0	0	0	0	0	0	0	0
26	0	0	0	0	0	0	0	0	0	2.0	0	0
27	0	0	0	0	0	0	0	0	0	0	0	0
28	0	0	0	0	0	0	0	0	0	0	0	0
29	0	0	0	0		0	0	0	0	0	0	0
30	0	0	0	0		0	0	0	0	16	0	0
31	0		0	0		0		0		3.9	0	

E201.5 Monthly Summary Table

	Oct	Nov	Dec	Jan	Feb	Mar	Apr	May	Jun	Jul	Aug	Sep	WY
Total Volume (acre-ft)	0	0	0	0	0	0	0	0	0	11	8.1	0	19.1
Max Daily Peak (ft ³ /s)	0	0	0	0	0	0	0	0	0	105	23	0	105
Min Daily Peak (ft ³ /s)	0	0	0	0	0	0	0	0	0	0	0	0	0
Missing Days	0	0	0	0	0	0	0	0	0	0	0	0	0

Surface Water Data, Water Year 2014

E204 Mortandad Canyon at LANL Boundary

Location. Lat 35° 51' 21", long -106° 14' 43", NW ¼, Sec. 30, T. 19 N., R. 7 E., Santa Fe County.

Drainage Area. 1.61 mi².

Period of Record. October 1, 1993, to September 30, 2014.

Revised Record. Drainage area (2006).

Gage. Data logger with radio telemetry and concrete control. Elevation of gage is 6654 ft using LANL LIDAR DEM with NAD 83.

Average Volume. 3 yr, 2 acre-ft.

Maximum Discharge for Period of Record. Maximum discharge, 102 ft³/s, September 13, 2013, gage height 1.85 ft.

Maximum Discharge for Current Water Year. Maximum discharge, 6.5 ft³/s, July 30, 2014, gage height 1.85 ft.



E204 Stream gage upstream view

Surface Water Data, Water Year 2014

Equipment. The station is equipped with a Sutron 9210 data logger (5-min interval), an MDS 4710 radio transceiver, and shaft encoder float system. The system is powered by a solar-panel battery system housed in a NEMA shelter on top of a 24-in. CMP well. The station is equipped with an ISCO pump sampler to collect water-quality samples. The ISCO sampler is housed in a separate shelter, a 3- × 4-ft metal box. The sampler is triggered by stage through the data logger. An outside staff gage is available for reference. No provision has been made for measurements above the wading stage. All high-flow measurements will be by slope-area or critical-depth computation methods.

Fieldwork

Number of Stream Gage Inspections	Number of Stream Gage Maintenance Visits	Number of ISCO 12-Count Sampler Inspections	Number of ISCO 12-Count Sampler Maintenance Visits	Number of ISCO 24-Count Sampler Inspections	Number of ISCO 24-Count Sampler Maintenance Visits
14	4	5	2	n/a*	n/a

* n/a = Not applicable.

Datum Correction. Levels run on May 24, 2007, showed the gage to be reading within allowable limits.

Gage-Height Record. The data logger referenced to the outside staff gage gave a complete and satisfactory record.

Rating. The channel is straight above and below the gage for 100 ft. The channel is not well defined and resembles a low grass-covered swale. Flow is infrequent. The control is a broad-crested weir with a "V" notch 5 ft downstream from the gage.

Rating No. 1 was developed using slope-area computations. The PZF is well defined for the concrete broad-crested weir.

No discharge measurements were made during the year.

Discharge. No flow occurs most of the time. Discharge was computed by directly applying Rating No. 1.

Surface Water Data, Water Year 2014

E204 Daily Peak Discharge (ft³/s)

Day	Oct	Nov	Dec	Jan	Feb	Mar	Apr	May	Jun	Jul	Aug	Sep
1	0	0	0	0	0	0	0	0	0	0	0	0
2	0	0	0	0	0	0	0	0	0	0	0	0
3	0	0.20	0	0	0	0	0	0	0	0	0	0
4	0	0.10	0	0	0	0	0	0	0	0	0.18	0
5	0	0.06	0	0	0	0	0	0	0	0	0	0
6	0	0.04	0	0	0	0	0	0	0	0	0	0
7	0	0.04	0	0	0	0	0	0	0	0	0	0
8	0	0.02	0	0	0	0	0	0	0	0	0	0
9	0	0	0	0	0	0	0	0	0	0	0.18	0
10	0	0	0	0	0	0	0	0	0	0	0	0
11	0	0	0	0	0	0	0	0	0	0	0	0
12	0	0	0	0	0	0	0	0	0	0	0	0
13	0	0	0	0	0	0	0	0	0	0	0	0
14	0	0	0	0	0	0	0	0	0	0	0	0
15	0	0	0	0	0	0	0	0	0	0	0	0
16	0	0	0	0	0	0	0	0	0	0	0	0
17	0	0	0	0	0	0	0	0	0	0	0	0
18	0	0	0	0	0	0	0	0	0	0	0	0
19	0	0	0	0	0	0	0	0	0	0	0	0
20	0	0	0	0	0	0	0	0	0	0	0	0
21	0	0	0	0	0	0	0	0	0	0	0	0
22	0	0	0	0	0	0	0	0	0	0	0	0
23	0	0	0	0	0	0	0	0	0	0	0	0
24	0	0	0	0	0	0	0	0	0	0	0	0
25	0	0	0	0	0	0	0	0	0	0	0	0
26	0	0	0	0	0	0	0	0	0	0	0	0
27	0	0	0	0	0	0	0	0	0	0	0	0
28	0	0	0	0	0	0	0	0	0	0	0	0
29	0	0	0	0		0	0	0	0	0	0	0
30	0	0	0	0		0	0	0	0	6.5	0	0
31	0		0	0		0		0		0.02	0	

E204 Monthly Summary Table

	Oct	Nov	Dec	Jan	Feb	Mar	Apr	May	Jun	Jul	Aug	Sep	WY
Total Volume (acre-ft)	0	0.46	0	0	0	0	0	0	0	0.31	0.09	0	0.40
Max Daily Peak (ft ³ /s)	0	0.20	0	0	0	0	0	0	0	6.5	0.18	0	6.5
Min Daily Peak (ft ³ /s)	0	0	0	0	0	0	0	0	0	0	0	0	0
Missing Days	0	0	0	0	0	0	0	0	0	0	0	0	0

Surface Water Data, Water Year 2014

E229.3 Cañada del Buey at SR-4

Location. Lat 35° 49' 41", long -106° 13' 23", Ramon Vigil Land Grant, Los Alamos County.

Drainage Area. 1.81 mi².

Period of Record. April 24, 2013, to September 30, 2014.

Revised Record. None.

Gage. Data logger with radio telemetry. Elevation of gage is 6510 ft using LANL LIDAR DEM with NAD 83.

Average Volume. 2 yr, 4 acre-ft/yr.

Maximum Discharge for Period of Record. Maximum discharge, 28 ft³/s, August 8, 2013, gage height 1.84 ft.

Maximum Discharge for Current Water Year. Maximum discharge, 11 ft³/s, July 8, 2014, gage height 1.21 ft.



E229.3 Stream gage downstream view

Surface Water Data, Water Year 2014

Equipment. The station is equipped with a Sutron 9210 data logger (5-min interval), an MDS radio transceiver, and a Sutron Accubar air-purge bubble sensor, housed in a NEMA shelter. Also, a Milltronics Sonic probe sits atop a 2-ft-wide by 1.5-ft-deep Parshall flume. No provision has been made for direct discharge measurements above the wading stage. The station is equipped with an ISCO pump sampler (12-count 1-L glass and polyethylene bottles) to collect water-quality samples. The ISCO is housed in a separate shelter, a 3- × 4-ft metal box. The sampler is triggered by stage through the data logger. A line-of-sight radio transceiver provides 5-min stage data from the bubble sensor and probe.

Fieldwork

Number of Stream Gage Inspections	Number of Stream Gage Maintenance Visits	Number of ISCO 12-Count Sampler Inspections	Number of ISCO 12-Count Sampler Maintenance Visits	Number of ISCO 24-Count Sampler Inspections	Number of ISCO 24-Count Sampler Maintenance Visits
12	4	5	3	n/a*	n/a

* n/a = Not applicable.

Datum Correction. None.

Gage-Height Record. The data logger referenced to the outside staff gage gave a complete and satisfactory record except for November 22, 2013, through December 4, 2013, when the gage was affected by ice.

Rating. Rating No. 1 is based on the formula for a 2-ft-wide by 1.5-ft-deep Parshall flume, with additional flow added for flow over the flume, based on a broad-crested weir equation. A gabion wall, for the flume overflow, forms a raised, rectangular cross-section 1.5 ft deep × 15 ft wide.

No discharge measurements were made during the year.

Discharge. Discharge was computed by directly applying Rating No. 1.

Surface Water Data, Water Year 2014

E229.3 Daily Peak Discharge (ft³/s)

Day	Oct	Nov	Dec	Jan	Feb	Mar	Apr	May	Jun	Jul	Aug	Sep
1	0	0	I*	0	0	0	0	0	0	0	0	0
2	0	0	I	0	0	0	0	0	0	6.0	0	0
3	0	0	I	0	0	0	0	0	0.31	0	0	0
4	0	0	I	0	0	0	0	0	0	0	0	0
5	0	0	0	0	0	0	0	0	0	0	0	0
6	0	0	0	0	0	0	0	0	0	0	0	0
7	0	0	0	0	0	0	0	0	0	0	0	0
8	0	0	0.02	0	0	0	0	0	0	11	0	0
9	0	0	0	0	0	0	0	0	0	0	0	0
10	0	0	0	0	0	0	0	0	0	0	0	0
11	0	0	0	0	0	0	0	0	0	0	0	0
12	0	0	0	0	0	0	0	0	0	0	0	0
13	0	0	0	0	0	0	0	0	0	0	0	0
14	0	0	0	0	0	0	0	0	0	0	0	0
15	0	0	0	0	0	0	0	0	0	0.05	0	0
16	0	0	0	0	0	0	0	0	0	0	0	0
17	0	0	0	0	0	0	0	0	0	0	0	0
18	0	0	0	0	0	0	0	0	0	0	0	0
19	0	0	0	0	0	0	0	0	0	0	0	0
20	0	0	0	0	0	0	0	0	0	0	0	0
21	0	0	0	0	0	0	0	0	0	0	0	0
22	0	I	0	0	0	0	0	0	0	0	0	0
23	0	I	0	0	0	0	0	0	0	0	0	0
24	0	I	0	0	0	0	0	0	0	0.31	0	0
25	0	I	0	0	0	0	0	0	0	0	0	0
26	0	I	0	0	0	0	0	0	0	0.27	0.27	0
27	0	I	0	0	0	0	0	0	0	0.17	0	0
28	0	I	0	0	0	0	0	0	0	0	0	0
29	0	I	0	0		0	0	0	0	0	0	0
30	0	I	0	0		0	0	0	0	0	0	0
31	0		0	0		0.02		0		2.4	0	
31	0		0	0		0		0		0.02	0	

* I represents ice present.

E229.3 Monthly Summary Table

	Oct	Nov	Dec	Jan	Feb	Mar	Apr	May	Jun	Jul	Aug	Sep	WY
Total Volume (acre-ft)	0	0	0	0	0	0	0	0	0.01	0.69	0.01	0	0.71
Max Daily Peak (ft ³ /s)	0	0	0.02	0	0	0.02	0	0	0.31	11	0.27	0	11
Min Daily Peak (ft ³ /s)	0	0	0	0	0	0	0	0	0	0	0	0	0
Missing Days	0	9	0	0	0	0	0	0	0	0	0	0	9

Surface Water Data, Water Year 2014

Pajarito Watershed

The Pajarito Canyon watershed is located in the central portion of LANL and is approximately 13.6 mi² in area. The head of the watershed is located in the Sierra de los Valles at an elevation of 10,441 ft at Pajarito Mountain. The watershed is a long, east-southeast trending canyon that extends across Valles Caldera National Preserve land and Santa Fe National Forest before it enters LANL's western boundary. Two major tributary canyons, Twomile and Threemile Canyons, intersect Pajarito Canyon on LANL property. The watershed reaches the Rio Grande at an elevation of approximately 5410 ft. Twomile Canyon heads in the Sierra de los Valles and has a length of approximately 5 mi and a drainage area of 3.1 mi², 70% of which is on LANL land. Sections of the upper portion of Pajarito watershed burned during the Las Conchas fire in June and July 2011. Both Twomile and Threemile Canyons contain ephemeral and intermittent streams. Seasonal springs in Twomile Canyon and perennial springs in Threemile Canyon support short reaches of ephemeral and perennial flow, respectively. East of the confluence with Threemile Canyon, Pajarito Canyon is ephemeral across LANL property to a point approximately 0.4 mi upstream from the confluence with the Rio Grande. In most years, snowmelt runoff extends onto LANL property downstream to near the confluence with Threemile Canyon. In 2012 and 2013, there was minimal to no snowmelt runoff. Local runoff and stream flow from seasonal rainstorms occasionally extend downstream as far as the Rio Grande.

The Pajarito watershed contains, or may influence, 12 wetland areas totaling approximately 15.80 acres. Figure 6 shows the total monthly volume of discharge for the four stream discharge gage stations within the Pajarito watershed. E245.5 received the most discharge during the July/August monsoon months.

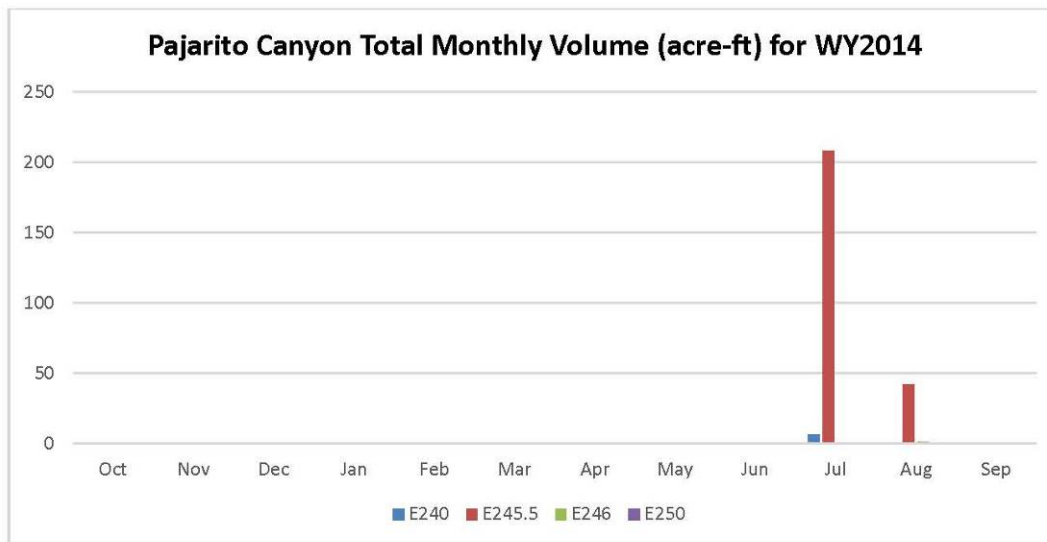

Figure 6 Total monthly volume (acre-ft) for WY2014 for Pajarito Canyon

Surface Water Data, Water Year 2014

E240 Pajarito Canyon below SR 501

Location. Lat 35° 52' 02", long -106° 21' 05", NW ¼, Sec. 19, T. 19 N., R. 6 E., Los Alamos County.

Drainage Area. 1.90 mi².

Period of Record. October 1993 to June 28, 2000 (destroyed by flood); April 2001 to September 30, 2014.

Revised Record. WDR 1997: Gage height "Extremes for Period of Record." Drainage area (2006). Levels date published as 2004, correction to December 2001 (2008).

Gage. Data logger with radio telemetry. Elevation of gage is 7719 ft using LANL LIDAR DEM with NAD 83. Formerly published as "Pajarito Canyon above Highway 501 near Los Alamos, NM" at different datum.

Average Volume. 3 yr, 18 acre-ft/yr.

Maximum Discharge for Period of Record. Maximum discharge, 1020 ft³/s, June 28, 2000, from peak-flow computation; gage height not determined.

Maximum Discharge for Current Water Year. Maximum discharge, 141 ft³/s, July 29, 2014, gage height 2.27 ft.



E240 Stream gage downstream view

Surface Water Data, Water Year 2014

Equipment. The station is equipped with a Sutron 9210 data logger (5-min interval), an MDS 4710 radio transceiver, and shaft encoder float system. The system is powered by a solar-panel battery system housed in a NEMA shelter on top of a 24-in. CMP well. The station is equipped with two ISCO pump samplers to collect water-quality samples. The ISCO samplers are housed in a separate shelter, a 3- × 4-ft metal box. The samplers are triggered by stage through the data logger. An outside staff gage is available for reference. No provision has been made for discharge measurements above the wading stage.

The station is also equipped with a rain gage, Rain Collection II. All equipment is powered with a solar-panel battery-charging system.

Fieldwork

Number of Stream Gage Inspections	Number of Stream Gage Maintenance Visits	Number of ISCO 12-Count Sampler Inspections	Number of ISCO 12-Count Sampler Maintenance Visits	Number of ISCO 24-Count Sampler Inspections	Number of ISCO 24-Count Sampler Maintenance Visits
23	8	8	3	n/a*	n/a

* n/a = Not applicable.

Datum Correction. The levels run December 11, 2001, show the gage to be within limits.

Gage-Height Record. The data logger referenced to the outside staff gage gave a complete and satisfactory record, except for April 6, 7, and 8, 2014; and September 16 and 17, 2014, when the equipment malfunctioned.

Rating. The gage is about 300 ft below the outlet of two round culverts through the NM 501 road bed. The channel bed is sand and gravel and subject to movement. The grass and brush are fairly thick in overbank areas. The banks are not high (about 1 to 2 ft in most places). Two gabions were installed in the fall of 2001, which act as low-water controls. One is 2 ft below the gage across the entire width of the channel with a 6-in. "V" notch for low water. Another gabion is 50 ft above the gage.

Rating No. 4 was developed based on the six measurements and slope area from previous years.

No discharge measurements were made during the year.

Discharge. Discharge was computed by applying the gage height to Rating No. 3 using variable shift diagrams.

Surface Water Data, Water Year 2014

E240 Daily Peak Discharge (ft³/s)

Day	Oct	Nov	Dec	Jan	Feb	Mar	Apr	May	Jun	Jul	Aug	Sep
1	0	0	0	0	0	0	0	0	0	0	0.09	0
2	0	0	0	0	0	0	0	0	0	0	0	0
3	0	0	0	0	0	0	0	0	0	0	0	0
4	0	0	0	0	0	0	0	0	0	0	0.05	0
5	0	0	0	0	0	0	0	0	0	0	0	0
6	0	0	0	0	0	0	E*	0	0	0	0	0
7	0	0	0	0	0	0	E	0	0	0.38	0	0
8	0	0	0	0	0	0	E	0	0	0	0	0
9	0	0	0	0	0	0	0	0	0	0	0	0
10	0	0	0	0	0	0	0	0	0	1.1	0	0
11	0	0	0	0	0	0	0	0	0	0	0	0
12	0	0	0	0	0	0	0	0	0	0	0	0
13	0	0	0	0	0	0	0	0	0	0	0	0
14	0	0	0	0	0	0	0	0	0	0.02	0	0
15	0	0	0	0	0	0	0	0	0	0	1.0	0
16	0	0	0	0	0	0	0	0	0	0	0	E
17	0	0	0	0	0	0	0	0	0	0	0	E
18	0	0	0	0	0	0	0	0	0	0	0	0
19	0	0	0	0	0	0	0	0	0	18	0	0
20	0	0	0	0	0	0	0	0	0	0	0	0
21	0	0	0	0	0	0	0	0	0	0	0	0
22	0	0	0	0	0	0	0	0	0	0	0	0
23	0	0	0	0	0	0	0	0	0	0	0	0
24	0	0	0	0	0	0	0	0	0	0	0	0
25	0	0	0	0	0	0	0	0	0	0	0	0
26	0	0	0	0	0	0	0	0	0	0	0	0
27	0	0	0	0	0	0	0	0	0	0.05	0	0
28	0	0	0	0	0	0	0	0	0	0	0	0
29	0	0	0	0		0	0	0	0	141	0	0
30	0	0	0	0		0	0	0	0	0	0	0
31	0		0	0		0		0		24.3	0	

* E represents equipment failure.

E240 Monthly Summary Table

	Oct	Nov	Dec	Jan	Feb	Mar	Apr	May	Jun	Jul	Aug	Sep	WY
Total Volume (acre-ft)	0	0	0	0	0	0	0	0	0	6.5	0.03	0	6.5
Max Daily Peak (ft ³ /s)	0	0	0	0	0	0	0	0	0	141	1.0	0	141
Min Daily Peak (ft ³ /s)	0	0	0	0	0	0	0	0	0	0	0	0	0
Missing Days	0	0	0	0	0	0	3	0	0	3	4	2	5

Surface Water Data, Water Year 2014

E245.5 Pajarito Canyon above Three Mile Canyon

Location. Lat 35° 50' 45.3", long -106° 16' 29", Sec. 16, T. 19 N., R. 6 E., Ramon Vigil Land Grant, Los Alamos County.

Drainage Area. 7.81 mi².

Period of Record. October 1, 2002, to September 30, 2014.

Revised Record. Drainage area (2008).

Gage. Data logger and radio telemetry. Elevation of gage is 6796 ft using LANL LIDAR DEM with NAD 83.

Average Volume. 3 yr, 226 acre-ft/yr.

Maximum Discharge for Period of Record. Maximum discharge, 630 ft³/s, September 13, 2013, gage height 4.82 ft.

Maximum Discharge for Current Water Year. Maximum discharge, 424 ft³/s, July 31, 2014, gage height 3.98 ft.



E245.5 Stream gage upstream view

Surface Water Data, Water Year 2014

Equipment. The station is equipped with a Sutron 9210 data logger (5-min interval), an MDS 4710 radio transceiver, and a Milltronics sonic probe. The system is powered by a solar-panel battery system housed in a NEMA shelter. The station is equipped with an ISCO pump sampler to collect water-quality samples. The ISCO sampler is housed in a separate shelter, a 3- × 4-ft metal box. The sampler is triggered by stage through the data logger. An outside staff gage is available for reference. No provision has been made for direct discharge measurements above the wading stage.

The station is also equipped with a tipping bucket rain gage, Rain Collection II. All equipment is powered with a solar-panel battery-charging system.

Fieldwork

Number of Stream Gage Inspections	Number of Stream Gage Maintenance Visits	Number of ISCO 12-Count Sampler Inspections	Number of ISCO 12-Count Sampler Maintenance Visits	Number of ISCO 24-Count Sampler Inspections	Number of ISCO 24-Count Sampler Maintenance Visits
23	12	11	9	n/a*	n/a

* n/a = Not applicable.

Datum Correction. Levels run May 12, 2008, show the gage to be within limits.

Gage-Height Record. The data logger referenced to the outside staff gage gave a complete and satisfactory record, except for November 14, 2013, through January 14, 2014; February 6–13, 2014; and March 3–15, 2014, when the gage was affected by ice and March 16, 2014, through May 1, 2014, when the equipment malfunctioned.

Rating. The channel is straight for 80 ft above and below the gage. The banks have some vegetation, and the streambed is sand and gravel.

Rating No. 4 was developed from previous measurements and one critical-depth computation.

No discharge measurements were made during the year.

Discharge. Discharge was computed by directly applying Rating No. 4.

Surface Water Data, Water Year 2014

Daily Peak Discharge (ft³/s) for E245.5

Day	Oct	Nov	Dec	Jan	Feb	Mar	Apr	May	Jun	Jul	Aug	Sep
1	0	0	I ^a	I	0	0	E ^b	E	0	0	58	0
2	0	0.01	I	I	0	0	E	0	0	0	0.05	0
3	0	0.01	I	I	0	I	E	0	0	0	0	0
4	0	0	I	I	0	I	E	0	0	0	178	0
5	0	0.37	I	I	0	I	E	0	0	0	104	0
6	0	0.05	I	I	I	I	E	0	0	0	0.01	0
7	0	0	I	I	I	I	E	0	0	371	0.01	0
8	0	0	I	I	I	I	E	0	0	153	0	0
9	0	0	I	I	I	I	E	0	0	1.4	0	0
10	0	0	I	I	I	I	E	0	0	0	48	0
11	0	0	I	I	I	I	E	0	0	0	0	0
12	0	0.15	I	I	I	I	E	0	0	0	0	0
13	0	0	I	I	I	I	E	0	0	0	0	0
14	0	I	I	I	0	I	E	0	0	0	0	0
15	0	I	I	0	0	I	E	0	0	339	0	0
16	0	I	I	0	0	E	E	0	0	23	0	0
17	0	I	I	0	0	E	E	0	0	0	0	0
18	0	I	I	0	0	E	E	0	0	0	0	0
19	0	I	I	0	0	E	E	0	0	89	0	0
20	0	I	I	0	0	E	E	0	0	0	0	0
21	0	I	I	0	0	E	E	0	0	0	0	0
22	0	I	I	0	0	E	E	0	0	0	0	0
23	0	I	I	0	0	E	E	0	0	0	0	0
24	0	I	I	0	0	E	E	0	0	0	0	0
25	0	I	I	0	0	E	E	0	0	0	0	0
26	0	I	I	0	0	E	E	0	0	0	0	0
27	0	I	I	0	0	E	E	0	0	34	0	0
28	0.01	I	I	0	0	E	E	0	0	16	0	0
29	0.03	I	I	0		E	E	0	0	328	0	0
30	0.01	I	I	0		E	E	0	0	0.07	0	0
31	0		I	0		E		0		424	0	

^a I represents ice present.

^b E represents equipment failure.

E245.5 Monthly Summary Table

	Oct	Nov	Dec	Jan	Feb	Mar	Apr	May	Jun	Jul	Aug	Sep	WY
Total Volume (acre-ft)	0.06	0.59	I*	0	0	0	0	0	0	208	42	0	250
Max Daily Peak (ft ³ /s)	0.03	0.15	I	0	0	0	0	0	0	424	178	0	424
Min Daily Peak (ft ³ /s)	0	0	0	0	0	0	0	0	0	0	0	0	0
Missing Days	0	17	31	14	8	29	30	0	0	0	0	0	129

* I represents ice present.

Surface Water Data, Water Year 2014

E246 Three Mile Canyon above Pajarito Canyon

Location. Lat 35° 50' 20", long -106° 16' 17", Sec. 35, T. 19 N., R. 6 E., Ramon Vigil Land Grant, Los Alamos County.

Drainage Area. 1.62 mi².

Period of Record. October 1998 to September 30, 2013.

Revised Record. Drainage area (2006).

Gage. Data logger and 9-in. Parshall flume with radio telemetry. Elevation of gage is 6759 ft using LANL LIDAR DEM with NAD 83.

Average Volume. 3 yr, 9 acre-ft/yr.

Maximum Discharge for Period of Record. Maximum discharge, 900 ft³/s, September 13, 2013, gage height 4.6 ft.

Maximum Discharge for Current Water Year. Maximum discharge, 5.4 ft³/s, August 4, 2014, gage height 1.48 ft.



E246 Stream gage upstream view

Surface Water Data, Water Year 2014

Equipment. The station is equipped with a Sutron 9210 data logger (5-min interval), an MDS 4710 radio transceiver, and a Milltronics sonic probe mounted on a 9-in. Parshall flume. The system is powered by a solar-panel battery system housed in a NEMA shelter on the right bank. The station is equipped with an ISCO pump sampler to collect water-quality samples. The ISCO sampler is housed in a separate shelter, a 3- x 4-ft metal box. The sampler is triggered by stage through the data logger. The staff gage in the 90-in. Parshall flume is the reference gage. No provision has been made for direct discharge measurements above the wading stage.

Fieldwork

Number of Stream Gage Inspections	Number of Stream Gage Maintenance Visits	Number of ISCO 12-Count Sampler Inspections	Number of ISCO 12-Count Sampler Maintenance Visits	Number of ISCO 24-Count Sampler Inspections	Number of ISCO 24-Count Sampler Maintenance Visits
15	7	6	2	n/a*	n/a

* n/a = Not applicable.

Datum Correction. None.

Gage-Height Record. The data logger referenced to the outside staff gage gave a complete and satisfactory record, except for October 1, 2014, through November 14, 2013, because of equipment malfunction, and November 23, 2013, through December 1, 2013, when the gage was affected by ice.

Rating. The channel is straight above and below the gage. Streamflow is confined to the main channel by outbanks on both sides. The bottom is 10 ft wide; the channel is prone to some shifting with vegetation on each bank. The low-water control is the 9-in. Parshall flume.

Rating No. 1 was developed based on the computation of the 9-in. Parshall flume and was extended on the basis of two critical-depth computations. The PZF is 0.00 gage height.

No discharge measurements were made during the year.

Discharge. Discharge was computed by directly applying the gage height to Rating No. 1.

Surface Water Data, Water Year 2014

E246 Daily Peak Discharge (ft³/s)

Day	Oct	Nov	Dec	Jan	Feb	Mar	Apr	May	Jun	Jul	Aug	Sep
1	E ^a	E	I ^b	0	0	0	0	0	0	0	0	0
2	E	E	0	0	0	0	0	0	0	0	0	0
3	E	E	0	0	0	0	0	0	0	0	0	0
4	E	E	0	0	0	0	0	0	0	0	5.4	0
5	E	E	0	0	0	0	0	0	0	0	2.4	0
6	E	E	0	0	0	0	0	0	0	0	0	0
7	E	E	0	0	0	0	0	0	0	0	0	0
8	E	E	0	0	0	0	0	0	0	0	0	0
9	E	E	0	0	0	0	0	0	0	0	0	0
10	E	E	0	0	0	0	0	0	0	0	0	0
11	E	E	0	0	0	0	0	0	0	0	0	0
12	E	E	0	0	0	0	0	0	0	0	0	0
13	E	E	0	0	0	0	0	0	0	0	0	0
14	E	E	0	0	0	0	0	0	0	0	0	0
15	E	0	0	0	0	0	0	0	0	0	0	0
16	E	0	0	0	0	0	0	0	0	0	0	0
17	E	0	0	0	0	0	0	0	0	0	0	0
18	E	0	0	0	0	0	0	0	0	0	0	0
19	E	0	0	0	0	0	0	0	0	0	0	0
20	E	0	0	0	0	0	0	0	0	0	0	0
21	E	0	0	0	0	0	0	0	0	0	0	0
22	E	0	0	0	0	0	0	0	0	0	0	0
23	E	I	0	0	0	0	0	0	0	0	0	0
24	E	I	0	0	0	0	0	0	0	0	0	0
25	E	I	0	0	0	0	0	0	0	0	0	0
26	E	I	0	0	0	0	0	0	0	0	0	0
27	E	I	0	0	0	0	0	0	0	0	0	0
28	E	I	0	0	0	0	0	0	0	0	0	0
29	E	I	0	0		0	0	0	0	0	0	0
30	E	I	0	0		0	0	0	0	0	0	0
31	E		0	0		0		0		0.14	0	

^a E represents equipment failure.

^b I represents ice present.

E246 Monthly Summary Table

	Oct	Nov	Dec	Jan	Feb	Mar	Apr	May	Jun	Jul	Aug	Sep	WY
Total Volume (acre-ft)	E*	0	0	0	0	0	0	0	0	0.01	0.86	0	0.87
Max Daily Peak (acre-ft)	E	0	0	0	0	0	0	0	0	0.14	5.4	0	5.4
Min Daily Peak (acre-ft)	E	0	0	0	0	0	0	0	0	0	0	0	0
Missing Days	31	22	1	0	0	0	0	0	0	0	0	0	54

* E represents equipment failure.

Surface Water Data, Water Year 2014

E250 Pajarito Canyon above SR 4

Location. Lat 35° 49' 26", long -106° 13' 40", Sec. 5, T. 18 N., R. 7 E., Ramon Vigil Land Grant, Los Alamos County.

Drainage Area. 10.6 mi².

Period of Record. November 1993 to August 25, 2006 (destroyed by flood); September 2006 to September 13, 2013 (damaged by high-flow event).

Revised Record. Drainage area (2006).

Gage. Data logger with radio telemetry and concrete control. Elevation of gage is 6535 ft using LANL LIDAR DEM with NAD 83.

Average Volume. 3 yr, 158 acre-ft/yr. Water Year 2014 not included.

Maximum Discharge for Period of Record. Maximum discharge, 960 ft³/s, September 13, 2013, gage height 5.23 ft.

Maximum Discharge for Current Water Year. Not available.



E250 Stream gage upstream view

Surface Water Data, Water Year 2014

Equipment. The station is equipped with a Sutron 9210 data logger (5-min interval), an MDS 4710 radio transceiver, and a shaft encoder float system. The system is powered by a solar-panel battery system housed in a NEMA shelter on an 18-in. CMP well. The station is equipped with an ISCO pump sampler to collect water-quality samples. The ISCO sampler is housed in a separate shelter, a 3- x 4-ft metal box. The sampler is triggered by stage through the data logger. An outside staff gage is available for reference. No provision has been made for direct discharge measurements above the wading stage.

Fieldwork

Number of Stream Gage Inspections	Number of Stream Gage Maintenance Visits	Number of ISCO 12-Count Sampler Inspections	Number of ISCO 12-Count Sampler Maintenance Visits	Number of ISCO 24-Count Sampler Inspections	Number of ISCO 24-Count Sampler Maintenance Visits
14	5	5	2	n/a*	n/a

* n/a = Not applicable.

Datum Correction. None. The most recent levels run on November 17, 2004, found the gage to be within acceptable limits.

Gage-Height Record. The data logger referenced to the outside staff gage was broken for the entire water year.

Rating. The channel is straight for 50 ft above and 100 ft below the gage. The streambed material is gravel. The control is concrete with a 90-degree weir plate.

Rating No. 1 was developed from a 90-degree weir plate formula and broad-crested weir computation above the notch. Rating No. 1 has been used and is considered good.

No discharge measurements were made during the year.

Discharge. Discharge was computed by directly applying the gage height to Rating No. 1.

Surface Water Data, Water Year 2014

E250 Daily Peak Discharge (ft³/s)

Day	Oct	Nov	Dec	Jan	Feb	Mar	Apr	May	Jun	Jul	Aug	Sep
1	E*	E	E	E	E	E	E	E	E	E	E	E
2	E	E	E	E	E	E	E	E	E	E	E	E
3	E	E	E	E	E	E	E	E	E	E	E	E
4	E	E	E	E	E	E	E	E	E	E	E	E
5	E	E	E	E	E	E	E	E	E	E	E	E
6	E	E	E	E	E	E	E	E	E	E	E	E
7	E	E	E	E	E	E	E	E	E	E	E	E
8	E	E	E	E	E	E	E	E	E	E	E	E
9	E	E	E	E	E	E	E	E	E	E	E	E
10	E	E	E	E	E	E	E	E	E	E	E	E
11	E	E	E	E	E	E	E	E	E	E	E	E
12	E	E	E	E	E	E	E	E	E	E	E	E
13	E	E	E	E	E	E	E	E	E	E	E	E
14	E	E	E	E	E	E	E	E	E	E	E	E
15	E	E	E	E	E	E	E	E	E	E	E	E
16	E	E	E	E	E	E	E	E	E	E	E	E
17	E	E	E	E	E	E	E	E	E	E	E	E
18	E	E	E	E	E	E	E	E	E	E	E	E
19	E	E	E	E	E	E	E	E	E	E	E	E
20	E	E	E	E	E	E	E	E	E	E	E	E
21	E	E	E	E	E	E	E	E	E	E	E	E
22	E	E	E	E	E	E	E	E	E	E	E	E
23	E	E	E	E	E	E	E	E	E	E	E	E
24	E	E	E	E	E	E	E	E	E	E	E	E
25	E	E	E	E	E	E	E	E	E	E	E	E
26	E	E	E	E	E	E	E	E	E	E	E	E
27	E	E	E	E	E	E	E	E	E	E	E	E
28	E	E	E	E	E	E	E	E	E	E	E	E
29	E	E	E	E		E	E	E	E	E	E	E
30	E	E	E	E		E	E	E	E	E	E	E
31	E		E	E		E		E		E	E	

* E represents equipment failure.

E250 Monthly Summary Table

	Oct	Nov	Dec	Jan	Feb	Mar	Apr	May	Jun	Jul	Aug	Sep	WY
Total Volume (acre-ft)	E*	E	E	E	E	E	E	E	E	E	E	E	E
Max Daily Peak (acre-ft)	E	E	E	E	E	E	E	E	E	E	E	E	E
Min Daily (acre-ft)	E	E	E	E	E	E	E	E	E	E	E	E	E
Missing Days	31	30	31	31	28	31	30	31	30	31	31	30	365

* E represents equipment failure.

Water/Cañon de Valle Watershed

The Water Canyon/Cañon de Valle watershed is an east-to-southeast trending drainage that originates on the eastern slopes of the Sierra de los Valles in the Valles Caldera National Preserve at an elevation of 10,380 ft. The watershed remains on the Valles Caldera National Preserve for 0.4 mi, and then passes through 2.8 mi of the Santa Fe National Forest before it crosses into LANL property at the western boundary of TA-16. Primary canyons within this watershed are Cañon de Valle, the primary tributary to Water Canyon, and Potrillo and Fence Canyons.

The Water/Cañon de Valle watershed consists mainly of occasional perennial reaches arising from springs that occur in the upper reaches of the watershed; however, streams in Potrillo and Fence Canyons are entirely ephemeral in nature. Springs on the flanks of the Jemez Mountains, west of LANL's western boundary, supply flow to the upper reaches of the Water/Cañon de Valle watershed. Perennial water exists from NM 501 to the eastern edge of TA-28 in upper Water Canyon and from Peter Seep in Cañon de Valle. Streams in middle and lower Water Canyon are ephemeral, except for a perennial reach in the lower canyon supported by Spring 5AA. The Water/Cañon de Valle watershed contains, or may influence, three wetland areas totaling approximately 0.23 acres.

Water Canyon has a channel length of 13.8 mi and a drainage area of 8.8 mi². Several perennial springs are located in the upper reaches of Water Canyon and Cañon de Valle (the major subdrainage to Water Canyon). Stream flow is ephemeral over most of the canyon passing through LANL property. Several perennial springs are located in upper Water Canyon in the Santa Fe National Forest, including Armistead and American Springs. These springs result in perennial reaches. A small perennial spring in lower Water Canyon, below the confluence with Potrillo Canyon, supports a very short perennial reach. Snowmelt seldom extends downstream as far as the LANL boundary.

Cañon de Valle originates west of LANL property, on the eastern slopes of the Sierra de los Valles in the Valles Caldera National Preserve at an elevation of 10,389 ft. The canyon extends east-southeast for 0.4 mi, crosses into the Santa Fe National Forest, and continues east-southeast for 2.8 mi before entering LANL property at the western boundary. Cañon de Valle has a channel length of 7.5 mi and a drainage area of 4.2 mi². Flow in Cañon de Valle is interrupted upstream of LANL's western boundary and is largely ephemeral on LANL property with short perennial reaches in the upper portion of the canyon. Several perennial springs located in the Santa Fe National Forest in upper Cañon de Valle result in perennial reaches.

Figure 7 shows the total monthly volume of discharge for the five stream gage discharge stations within the Water Canyon and Cañon de Valle watershed. Stream gages E252, E256, E265, and E267 received discharge during July; gages E252, E256, and E265 received discharge in August. Stream gage E253 did not receive any discharge for the 2014 water year.

Surface Water Data, Water Year 2014

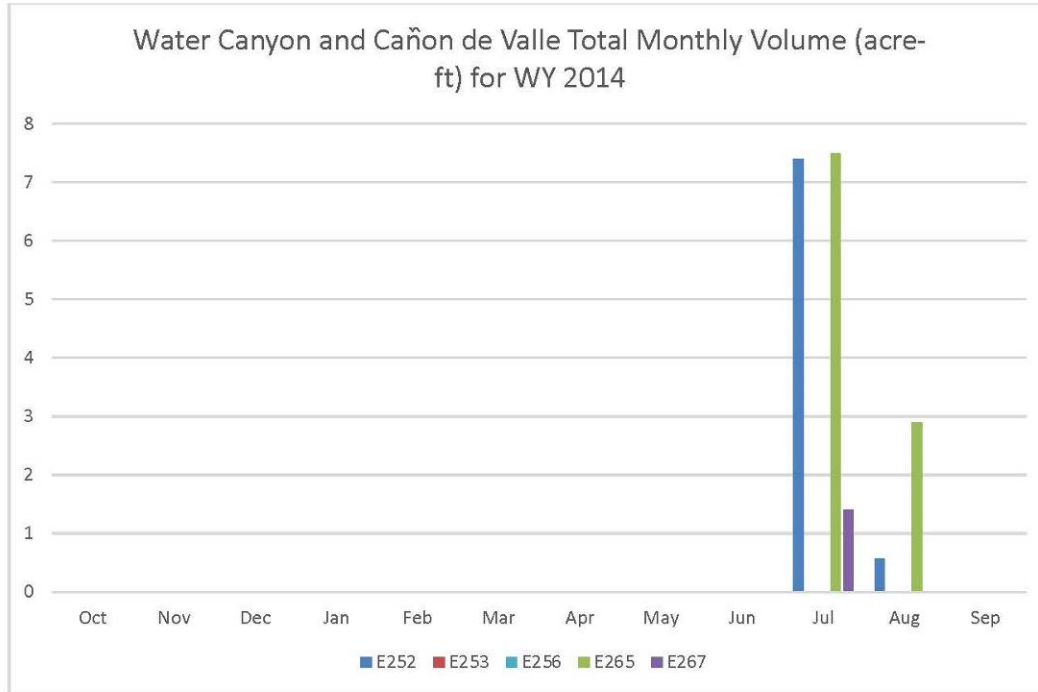

Figure 7 Total monthly volume (acre-ft) for WY2014 in Water Canyon, Cañon de Valle, and Fence Canyon. Note: Stream gage E253 did not receive any discharge in WY2014, and the maximum discharge in WY2014 for stream gage E256, <1 ft³/s, is too low to display on the plot.

Surface Water Data, Water Year 2014

E252 Water Canyon above SR 501

Location. Lat 35° 50' 18", long -106° 21' 42", Sec. 36, T. 19 N., R. 5 E., Los Alamos County in Santa Fe National Forest.

Drainage Area. 3.25 mi².

Period of Record. October 1994 to June 2000 (destroyed by flood); April 2001 to September 2014

Revised Record. Drainage area (2006).

Gage. Data logger with radio telemetry. Elevation of gage is 7556 ft using LANL LIDAR DEM with NAD 83.

Average Volume. 3 yr, 31 acre-ft/yr.

Maximum Discharge for Period of Record. Maximum discharge, 1577 ft³/s, August 21, 2011, estimated with high-water-mark survey.

Maximum Discharge for Current Water Year. Maximum discharge, 21 ft³/s, July 19, 2014, gage height 5.24 ft.



E252 Stream gage downstream view

Surface Water Data, Water Year 2014

Equipment. The station is equipped with a Sutron 9210 data logger (5-min interval), an MDS 4710 radio transceiver, and a shaft encoder float system (5-min interval). The system is powered by a solar-panel battery system housed in a NEMA shelter on a 24-in. CMP well. The station is equipped with an ISCO pump sampler to collect water-quality samples. The ISCO sampler is housed in a separate shelter, a 3- × 4-ft steel storage box. The sampler is triggered by stage through the data logger. An outside staff gage is available for reference. There is no low-water control. No provision has been made for direct discharge measurements above the wading stage.

Fieldwork

Number of Stream Gage Inspections	Number of Stream Gage Maintenance Visits	Number of ISCO 12-Count Sampler Inspections	Number of ISCO 12-Count Sampler Maintenance Visits	Number of ISCO 24-Count Sampler Inspections	Number of ISCO 24-Count Sampler Maintenance Visits
17	5	5	2	n/a*	n/a

* n/a = Not applicable.

Datum Correction. None. Levels were run when the gage was established on April 16, 2001. The new gage is at the same datum as the old and is about 20 ft upstream.

Gage-Height Record. The data logger referenced to the inside staff gage and reference point gave a complete and satisfactory record for the year, except for October 1, 2013, through November 18, 2014; August 17, 24, 30, and 31, 2014; and September 2, 2014, when the equipment malfunctioned.

Rating. The channel at the gage is 30 ft wide and straight for about 40 ft upstream, then bends to the left; downstream the gage is straight for 100 ft. The streambed through this reach is primarily sand, gravel, and cobbles. The low-flow control is a rock riffle 5 ft below the gage. The channel has been scoured and filled significantly by high flows resulting from both the Cerro Grande and Las Conchas fires.

Rating No. 4 was based on a step-backwater survey conducted on November 18, 2011, following major channel aggradation during an August 21, 2011, runoff event. Steep slopes in the gage reach and throughout the region cause considerable movement of material as either scours or fills.

No discharge measurements were made during the year.

Discharge. Discharge was computed by directly applying the inside gage height to Rating No. 4.

Surface Water Data, Water Year 2014

E252 Daily Peak Discharge (ft³/s)

Day	Oct	Nov	Dec	Jan	Feb	Mar	Apr	May	Jun	Jul	Aug	Sep
1	E*	E	0	0	0	0	0	0	0	0	1.2	0
2	E	E	0	0	E	0	0	0	0	0	0.04	E
3	E	E	0	0	0	0	0	0	0	0	0.04	0
4	E	E	0	0	0	0	0	0	0	0	0.04	0
5	E	E	0	0	0	0	0	0	0	0	0.04	0
6	E	E	0	0	0	0	0	0	0	0	0	0
7	E	E	0	0	0	0	0	0	0	0	0	0
8	E	E	0	0	0	0	0	0	0	0	0	0
9	E	E	0	0	0	0	0	0	0	0	0	0
10	E	E	0	0	0	0	0	0	0	0	0	0
11	E	E	0	0	0	0	0	0	0	0	0	0
12	E	E	0	0	0	0	0	0	0	0	0	0
13	E	E	0	0	0	0	0	0	0	0	0	0
14	E	E	0	0	0	0	0	0	0	0	0	0
15	E	E	0	0	0	0	0	0	0	0	0	0
16	E	E	0	0	0	0	0	0	0	0	0	0
17	E	E	0	0	0	0	0	0	0	0	E	0
18	E	E	0	0	0	0	0	0	0	0	0	0
19	E	0	0	0	0	0	0	0	0	21	0	0
20	E	0	0	0	0	0	0	0	0	0.16	0	0
21	E	0	0	0	0	0	0	0	0	0	0	0
22	E	0	0	0	0	0	0	0	0	0	0	0
23	E	0	0	0	0	0	0	0	0	0.01	0	0
24	E	0	0	0	0	0	0	0	0	0.23	E	0
25	E	0	0	0	0	0	0	0	0	0.5	0	0
26	E	0	0	0	0	0	0	0	0	0.55	0	0
27	E	0	0	0	0	0	0	0	0	0.26	0	0
28	E	0	0	0	0	0	0	0	0	0.17	0	0
29	E	0	0	0		0	0	0	0	0.05	0	0
30	E	0	0	0		0	0	0	0	0.03	E	0
31	E		0	0		0		0		7.2	E	

* E represents equipment failure.

E252 Monthly Summary Table

	Oct	Nov	Dec	Jan	Feb	Mar	Apr	May	Jun	Jul	Aug	Sep	WY
Total Volume (acre-ft)	E*	0	0	0	0	0	0	0	0	7.4	0.57	0	7.97
Max Daily Peak (ft ³ /s)	E	0	0	0	0	0	0	0	0	21	1.2	0	21
Min Daily Peak (ft ³ /s)	E	0	0	0	0	0	0	0	0	0	0	0	0
Missing Days	31	18	0	0	1	0	0	0	0	0	4	1	55

* E represents equipment failure.

Surface Water Data, Water Year 2014

E253 Cañon de Valle above SR 501

Location. Lat 35° 51' 6", long -106° 21' 17", NE ¼, Sec. 25, T. 19 N., R. 5 E., Los Alamos County in Santa Fe National Forest.

Drainage Area. 2.27 mi².

Period of Record. October 1994 to June 2000 (gage destroyed by flood); January 31, 2001, to September 30, 2014.

Revised Record. Period of record (2012).

Gage. Data logger and 120-degree weir plate, rain gage with radio telemetry. Elevation of gage is 7707 ft using LANL LIDAR DEM with NAD 83.

Average Volume. 3 yr, 94 acre-ft/yr.

Maximum Discharge for Period of Record. Maximum discharge, 1450 ft³/s, August 21, 2011, gage height 10 ft.

Maximum Discharge for Current Water Year. Maximum discharge, 0 ft³/s, multiple days.



E253 Stream gage upstream view

Surface Water Data, Water Year 2014

Equipment. The station is equipped with a Sutron 9210 data logger (5-min interval), an MDS 4710 radio transceiver, and a shaft encoder float system. The system is powered by a solar-panel battery system housed in a NEMA shelter on a 24-in. CMP well, 16 ft long attached to a 60-ft metal walkway. The station is equipped with an ISCO pump sampler to collect water-quality samples. The ISCO sampler is housed in a separate shelter, a 3- x 4-ft steel storage box. The sampler is triggered by stage through the data logger. An outside staff gage is available for reference. No provision has been made for direct discharge measurements above the wading stage.

The station is also equipped with a rain gage, Rain Collection II. All equipment is powered with a solar-panel battery-charging system.

Fieldwork

Number of Stream Gage Inspections	Number of Stream Gage Maintenance Visits	Number of ISCO 12-Count Sampler Inspections	Number of ISCO 12-Count Sampler Maintenance Visits	Number of ISCO 24-Count Sampler Inspections	Number of ISCO 24-Count Sampler Maintenance Visits
18	5	5	1	n/a*	n/a

* n/a = Not applicable.

Datum Correction. None. The levels were run on April 16, 2001, when the gage was reestablished.

Gage-Height Record. Stream gage E253 did not receive any discharge for the 2014 water year.

Rating. The channel at the gage is about 8 ft wide and straight for about 50 ft upstream, then bends to the left and straight for 100 ft downstream and bends to the right. The streambed through this reach is primarily gravel with cobbles. The low-flow control is a 120-degree sharp-crested weir. The channel becomes the control at high flow.

Rating No. 4 was developed from PZF measurement levels on October 28, 2011. Stage values were adjusted +0.10 for each discharge to continue to match the V-notch weir table.

No discharge measurements were made during the year.

Discharge. Discharge was computed by directly applying the gage height to Rating No. 4.

Surface Water Data, Water Year 2014

E253 Daily Peak Discharge (ft³/s)

Day	Oct	Nov	Dec	Jan	Feb	Mar	Apr	May	Jun	Jul	Aug	Sep
1	E*	E	0	0	0	0	0	0	0	0	0	0
2	E	E	0	0	E	0	0	0	0	0	0	E
3	E	E	0	0	0	0	0	0	0	0	0	0
4	E	E	0	0	0	0	0	0	0	0	0	0
5	E	E	0	0	0	0	0	0	0	0	0	0
6	E	E	0	0	0	0	0	0	0	0	0	0
7	E	E	0	0	0	0	0	0	0	0	0	0
8	E	E	0	0	0	0	0	0	0	0	0	0
9	E	0	0	0	0	0	0	0	0	0	0	0
10	E	0	0	0	0	0	0	0	0	0	0	0
11	E	0	0	0	0	0	0	0	0	0	0	0
12	E	0	0	0	0	0	0	0	0	0	0	0
13	E	0	0	0	0	0	0	0	0	0	0	0
14	E	0	0	0	0	0	0	0	0	0	0	0
15	E	0	0	0	0	0	0	0	0	0	0	0
16	E	0	0	0	0	0	0	0	0	0	0	0
17	E	0	0	0	0	0	0	0	0	0	E	0
18	E	0	0	0	0	0	0	0	0	0	0	0
19	E	0	0	0	0	0	0	0	0	0	0	0
20	E	0	0	0	0	0	0	0	0	0	0	0
21	E	0	0	0	0	0	0	0	0	0	0	0
22	E	0	0	0	0	0	0	0	0	0	0	0
23	E	0	0	0	0	0	0	0	0	0	0	0
24	E	0	0	0	0	0	0	0	0	0	E	0
25	E	0	0	0	0	0	0	0	0	0	0	0
26	E	0	0	0	0	0	0	0	0	0	0	0
27	E	0	0	0	0	0	0	0	0	0	0	0
28	E	0	0	0	0	0	0	0	0	0	0	0
29	E	0	0	0		0	0	0	0	0	0	0
30	E	0	0	0		0	0	0	0	0	E	0
31	E		0	0		0		0		0	E	

* E represents equipment failure.

E253 Monthly Summary Table

	Oct	Nov	Dec	Jan	Feb	Mar	Apr	May	Jun	Jul	Aug	Sep	WY
Total Volume (acre-ft)	E*	0	0	0	0	0	0	0	0	0	0	0	0
Max Daily Peak (ft ³ /s)	E	0	0	0	0	0	0	0	0	0	0	0	0
Min Daily Peak (ft ³ /s)	E	0	0	0	0	0	0	0	0	0	0	0	0
Missing Days	31	8	0	0	1	0	0	0	0	0	4	1	45

* E represents equipment failure.

Surface Water Data, Water Year 2014

E256 Cañon de Valle below MDA P

Location. Lat 35° 51' 01", long -106° 19' 56.4", Sec. 29, T. 19 N., R. 6 E., Ramon Vigil Land Grant, Los Alamos County.

Drainage Area. 3.25 mi².

Period of Record. January 24, 2002, to August 21, 2011; August 15, 2014, to September 30, 2014.

Revised Record. Period of record (2014).

Gage. Data logger and 24-in. Parshall flume. Elevation of gage is 7329 ft above NGVD 29 from global positioning system survey.

Average Volume. <1 yr, 0.01 acre-ft/yr.

Maximum Discharge for Period of Record. Maximum discharge, 1024 ft³/s, August 21, 2011, estimated with high-water-mark survey.

Maximum Discharge for Current Water Year. Maximum discharge, <1 ft³/s, August 15, 2014, gage height 0.23 ft.



E256 Stream gage upstream view

Surface Water Data, Water Year 2014

Equipment. The station is equipped with a Sutron 9210 data logger (5-min interval) and a Sutron Accubar bubble sensor within a 24-in. Parshall flume. The system is powered by a solar-panel battery system housed in a NEMA shelter on the left bank. The station is equipped with an ISCO pump sampler to collect water-quality samples. The ISCO sampler is housed in a separate shelter, a 3- x 4-ft metal box. An outside staff gage is available for reference. No provision has been made for discharge measurements above the wading stage. During the August 21, 2011, severe storm event, the bubbler line was destroyed along with the shelter, the data logger, and associated ISCO intake suction lines. The gage was deemed unusable. The gage site was rebuilt in August 2014.

Fieldwork

Number of Stream Gage Inspections	Number of Stream Gage Maintenance Visits	Number of ISCO 12-Count Sampler Inspections	Number of ISCO 12-Count Sampler Maintenance Visits	Number of ISCO 24-Count Sampler Inspections	Number of ISCO 24-Count Sampler Maintenance Visits
4	7	4	3	n/a*	n/a

* n/a = Not applicable.

Datum Correction. None.

Gage-Height Record. The data logger referenced to the inside staff gage gave a complete and satisfactory record from August 15, 2014, to September 20, 2014. The gage station was not in operation from August 21, 2011, to August 14, 2014.

Rating. The channel is straight for 50 ft upstream and 20 ft downstream from the gage. The streambed consists of sand with gravel and is subject to filling behind the flume from flow events and gage silting problems. The banks are covered with vegetation. Rating No. 1 is based on the 24-in. Parshall flume. The rating curve was extrapolated to accommodate the peak stage of 3.75 ft.

Discharge. Discharge was computed by applying the gage height to Rating No. 1 using variable shift.

Surface Water Data, Water Year 2014

E256 Daily Peak Discharge (ft³/s)

Day	Oct	Nov	Dec	Jan	Feb	Mar	Apr	May	Jun	Jul	Aug	Sep
1	IA*	IA	IA	IA	IA	IA	IA	IA	IA	IA	IA	0
2	IA	IA	IA	IA	IA	IA	IA	IA	IA	IA	IA	0
3	IA	IA	IA	IA	IA	IA	IA	IA	IA	IA	IA	0
4	IA	IA	IA	IA	IA	IA	IA	IA	IA	IA	IA	0.02
5	IA	IA	IA	IA	IA	IA	IA	IA	IA	IA	IA	0
6	IA	IA	IA	IA	IA	IA	IA	IA	IA	IA	IA	0
7	IA	IA	IA	IA	IA	IA	IA	IA	IA	IA	IA	0
8	IA	IA	IA	IA	IA	IA	IA	IA	IA	IA	IA	0
9	IA	IA	IA	IA	IA	IA	IA	IA	IA	IA	IA	0.02
10	IA	IA	IA	IA	IA	IA	IA	IA	IA	IA	IA	0
11	IA	IA	IA	IA	IA	IA	IA	IA	IA	IA	IA	0
12	IA	IA	IA	IA	IA	IA	IA	IA	IA	IA	IA	0
13	IA	IA	IA	IA	IA	IA	IA	IA	IA	IA	IA	0
14	IA	IA	IA	IA	IA	IA	IA	IA	IA	IA	IA	0
15	IA	IA	IA	IA	IA	IA	IA	IA	IA	IA	IA	0
16	IA	IA	IA	IA	IA	IA	IA	IA	IA	IA	0.06	0
17	IA	IA	IA	IA	IA	IA	IA	IA	IA	IA	0.05	0
18	IA	IA	IA	IA	IA	IA	IA	IA	IA	IA	0	0
19	IA	IA	IA	IA	IA	IA	IA	IA	IA	IA	0	0
20	IA	IA	IA	IA	IA	IA	IA	IA	IA	IA	0	0
21	IA	IA	IA	IA	IA	IA	IA	IA	IA	IA	0	0.02
22	IA	IA	IA	IA	IA	IA	IA	IA	IA	IA	0	0
23	IA	IA	IA	IA	IA	IA	IA	IA	IA	IA	0	0
24	IA	IA	IA	IA	IA	IA	IA	IA	IA	IA	0	0
25	IA	IA	IA	IA	IA	IA	IA	IA	IA	IA	0.02	0
26	IA	IA	IA	IA	IA	IA	IA	IA	IA	IA	0	0
27	IA	IA	IA	IA	IA	IA	IA	IA	IA	IA	0	0
28	IA	IA	IA	IA	IA	IA	IA	IA	IA	IA	0	0
29	IA	IA	IA	IA		IA	IA	IA	IA	IA	0	0
30	IA	IA	IA	IA		IA	IA	IA	IA	IA	0	0
31	IA		IA	IA		IA		IA		IA	0	

* IA represents inactive gage. Gage was returned to service August 16.

E256 Monthly Summary Table

	Oct	Nov	Dec	Jan	Feb	Mar	Apr	May	Jun	Jul	Aug	Sep	WY
Total Volume (acre-ft)	IA*	IA	IA	IA	IA	IA	IA	IA	IA	IA	0.01	0	0.01
Max Daily Peak (ft ³ /s)	IA	IA	IA	IA	IA	IA	IA	IA	IA	IA	0.06	0.02	0.06
Min Daily Peak (ft ³ /s)	IA	IA	IA	IA	IA	IA	IA	IA	IA	IA	0	0	0
Missing Days	31	30	31	31	28	31	30	31	30	31	14	0	318

* IA represents inactive gage. Gage was returned to service August 16.

Surface Water Data, Water Year 2014

E265 Water Canyon below SR 4

Location. Lat 35° 48' 18", long -106° 14' 31", Sec. 7, T. 18 N., R. 7 E., Ramon Vigil Land Grant, Los Alamos County.

Drainage Area. 13.11 mi².

Period of Record. October 1993 to September 30, 2014.

Revised Record. Drainage area (2006).

Gage. Data logger with radio telemetry and stabilized natural rock control. Elevation of gage is 6311 ft using LANL LIDAR DEM with NAD 83.

Average Volume. 3 yr, 83 acre-ft/yr.

Maximum Discharge for Period of Record. Maximum discharge, 2560 ft³/s, September 13, 2013, gage height 6.23 ft.

Maximum Discharge for Current Water Year. Maximum discharge, 52 ft³/s, July 31, 2014, gage height 1.75 ft.



E265 Stream gage upstream view

Surface Water Data, Water Year 2014

Equipment. The station is equipped with a Sutron 9210 data logger (5-min interval), an MDS 4710 radio transceiver, and a shaft encoder float system. The system is powered by a solar-panel battery system housed in a NEMA shelter on a 24-in. CMP well. The station is equipped with two ISCO pump samplers to collect water-quality samples. The ISCO samplers are housed in a separate shelter, a 3- × 4-in. metal box. The samplers are triggered by stage through the data logger. An outside staff gage is available for reference. No provision has been made for measurements above the wading stage.

The station is also equipped with a tipping bucket rain gage, Rain Collection II. All equipment is powered with a solar-panel battery-charging system.

Fieldwork

Number of Stream Gage Inspections	Number of Stream Gage Maintenance Visits	Number of ISCO 12-Count Sampler Inspections	Number of ISCO 12-Count Sampler Maintenance Visits	Number of ISCO 24-Count Sampler Inspections	Number of ISCO 24-Count Sampler Maintenance Visits
20	8	6	3	n/a*	n/a

* n/a = Not applicable.

Datum Correction. None.

Gage-Height Record. The data logger referenced to the outside staff gage gave a complete and satisfactory record for the year.

Rating. The channel is straight for 100 ft above and below the gage. The banks are low and have very little vegetation. The streambed is mostly rock with lenses of sand.

Rating No.5 was used for the entire water year.

No discharge measurements were made during the year.

Discharge. Discharge was computed by directly applying the gage height to Rating No. 5.

Surface Water Data, Water Year 2014

E265 Daily Peak Discharge (ft³/s)

Day	Oct	Nov	Dec	Jan	Feb	Mar	Apr	May	Jun	Jul	Aug	Sep
1	0	0	0	0	0	0	0	0	0	0	3.3	0
2	0	0	0	0	E	0	0	0	0	0	0	E
3	0	0	0	0	0	0	0	0	0	0	0	0
4	0	0	0	0	0	0	0	0	0	0	28	0
5	0	0	0	0	0	0	0	0	0	0	0.05	0
6	0	E*	0	0	0	0	0	0	0	0	0	0
7	0	E	0	0	0	0	0	0	0	0	0	0
8	0	E	0	0	0	0	0	0	0	0	0	0
9	0	E	0	0	0	0	0	0	0	0	0	0
10	0	E	0	0	0	0	0	0	0	0	0	0
11	0	E	0	0	0	0	0	0	0	0	0	0
12	0	E	0	0	0	0	0	0	0	0	0	0
13	0	E	0	0	0	0	0	0	0	0	0	0
14	0	E	0	0	0	0	0	0	0	0	0	0
15	0	E	0	0	0	0	0	0	0	0	0	0
16	0	E	0	0	0	0	0	0	0	0	0	0
17	0	E	0	0	0	E	0	0	0	0	E	0
18	0	E	0	0	0	E	0	0	0	0	0	0
19	0	E	0	0	0	E	0	0	0	0	0	0
20	0	E	0	0	0	E	0	0	0	0	0	0
21	0	E	0	0	0	E	0	0	0	0	0	0
22	0	E	0	0	0	E	0	0	0	0	0	0
23	0	0	0	0	0	E	0	0	0	0	0	0
24	0	0	0	0	0	E	0	0	0	0	E	0
25	0	0	0	0	0	E	0	0	0	0	0	0
26	0	0	0	0	0	E	0	0	0	0	0	0
27	0	0	0	0	0	E	0	0	0	0	0	0
28	0	0	0	0	0	0	0	0	0	0	0	0
29	0	0	0	0		0	0	0	0	0	0	0
30	0	0	0	0		0	0	0	0	0	E	0
31	0		0	0		0		0		52	E	

* E represents equipment failure.

E265 Monthly Summary Table

	Oct	Nov	Dec	Jan	Feb	Mar	Apr	May	Jun	Jul	Aug	Sep	WY
Total (acre-ft)	0	0	0	0	0	0	0	0	0	7.5	2.9	0	10.4
Max Daily Mean (ft ³ /s)	0	0	0	0	0	0	0	0	0	52	28	0	52
Min Daily Mean (ft ³ /s)	0	0	0	0	0	0	0	0	0	0	0	0	0
Missing Days	0	17	0	0	1	11	0	0	0	0	4	1	34

Surface Water Data, Water Year 2014

E267 Potrillo Canyon above SR 4

Location. Lat 35° 48' 48", long -106° 14' 00", Sec. 6, T. 18 N., R. 7 E., Ramon Vigil Land Grant, Los Alamos County.

Drainage Area. 2.26 mi².

Period of Record. October 1, 1995, to September 30, 2014

Revised Record. LA-13551-PR (1998): Station number. Drainage area (2006).

Gage. Data logger with radio telemetry and concrete control. Elevation of gage is 6455 ft using LANL LIDAR DEM with NAD 83.

Average Volume. 3 yr, 2 acre-ft/yr.

Maximum Discharge for Period of Record. Maximum discharge, 99 ft³/s, September 13, 2013, gage height 2.94 ft.

Maximum Discharge for Current Water Year. Maximum discharge, 25 ft³/s, July 2, 2014, gage height 2.12 ft.



E267 Stream gage downstream view

Surface Water Data, Water Year 2014

Equipment. The station is equipped with a Sutron 9210 data logger (5-min interval), an MDS 4710 radio transceiver, and a shaft encoder float system. The system is powered by a solar-panel battery system housed in a NEMA shelter on an 18-in. CMP well. The station is equipped with an ISCO pump sampler to collect water-quality samples. The ISCO sampler is housed in a separate shelter, a 3-x 4-ft metal box. The sampler is triggered by stage through the data logger. An outside staff gage is available for reference. No provision has been made for direct discharge measurements above the wading stage.

Fieldwork

Stream Gage Inspection	Stream Gage Maintenance	ISCO 12-Count Sampler Inspection	ISCO 12-Count Sampler Maintenance	ISCO 24-Count Sampler Inspection	ISCO 24-Count Sampler Maintenance	Number of Samples Collected
12	5	6	3	n/a*	n/a	0

* n/a = Not applicable.

Datum Correction. None.

Gage-Height Record. The data logger referenced to the outside staff gage gave a complete and satisfactory record for the year, except for October 1, 2013, through November 15, 2013; February 2–14, 2014; May 2–7, 2014; July 8–10, 2014; August 24 and 30–31, 2014; and September 2, 2014, when the equipment malfunctioned.

Rating. The channel is fairly straight for 300 ft above the gage and 150 ft below. The streambed is mostly sand. The brush is fairly thick along the stream bank. The control is a concrete broad-crested weir.

Rating No. 2 is considered good.

The original shape and definition of the rating was derived by computation using weir geometry with the slope area used to define peak discharge and slope of the upper end.

No discharge measurements were made during the year.

Discharge. Discharge was computed by directly applying the gage height to Rating No. 2.

Surface Water Data, Water Year 2014

E267 Daily Peak Discharge (ft³/s)

Day	Oct	Nov	Dec	Jan	Feb	Mar	Apr	May	Jun	Jul	Aug	Sep
1	E*	E	0	0	0	0	0	0	0	0	0	0
2	E	E	0	0	E	0	0	E	0	25	0	E
3	E	E	0	0	0	0	0	E	0	0	0	0
4	E	E	0	0	0	0	0	E	0	0	0	0
5	E	E	0	0	0	0	0	E	0	0	0	0
6	E	E	0	0	0	0	0	E	0	0	0	0
7	E	E	0	0	0	0	0	E	0	0	0	0
8	E	E	0	0	0	0	0	0	0	E	0	0
9	E	E	0	0	0	0	0	0	0	E	0	0
10	E	E	0	0	0	0	0	0	0	E	0	0
11	E	E	0	0	0	0	0	0	0	0	0	0
12	E	E	0	0	0	0	0	0	0	0	0	0
13	E	E	0	0	0	0	0	0	0	0	0	0
14	E	E	0	0	0	0	0	0	0	0	0	0
15	E	E	0	0	0	0	0	0	0	0	0	0
16	E	0	0	0	0	0	0	0	0	0	0	0
17	E	0	0	0	0	0	0	0	0	0	E	0
18	E	0	0	0	0	0	0	0	0	0	0	0
19	E	0	0	0	0	0	0	0	0	0	0	0
20	E	0	0	0	0	0	0	0	0	0	0	0
21	E	0	0	0	0	0	0	0	0	0	0	0
22	E	0	0	0	0	0	0	0	0	0	0	0
23	E	0	0	0	0	0	0	0	0	0	0	0
24	E	0	0	0	0	0	0	0	0	0	E	0
25	E	0	0	0	0	0	0	0	0	0	0	0
26	E	0	0	0	0	0	0	0	0	0	0	0
27	E	0	0	0	0	0	0	0	0	0	0	0
28	E	0	0	0	0	0	0	0	0	0	0	0
29	E	0	0	0		0	0	0	0	0.83	0	0
30	E	0	0	0		0	0	0	0	0	E	0
31	E		0	0		0		0		3.8	E	

* E represents equipment failure.

E267 Monthly Summary Table

	Oct	Nov	Dec	Jan	Feb	Mar	Apr	May	Jun	Jul	Aug	Sep	WY
Total (acre-ft)	E*	0	0	0	0	0	0	0	0	1.4	0	0	1.4
Max Daily Peak (ft ³ /s)	E	0	0	0	0	0	0	0	0	25	0	0	25
Min Daily Peak (ft ³ /s)	E	0	0	0	0	0	0	0	0	0	0	0	0
Missing Days	31	15	0	0	1	0	0	6	0	3	4	1	17

* E represents equipment failure.

Surface Water Data, Water Year 2014

Ancho/Chaquehui Watershed

Ancho Canyon is located in the southeastern portion of LANL and originates on LANL property in TA-49 at an elevation of approximately 7285 ft. The watershed extends southeast across LANL and enters the Rio Grande along the boundary between TA-33 and TA-70 at an elevation of approximately 5410 ft. Ancho Canyon is joined by North Ancho Canyon before it flows into the Rio Grande. The area of Ancho watershed is approximately 6.8 mi², and it has a channel length of 7.3 mi. Stream flow in Ancho Canyon is ephemeral over most of the canyon length, until about 0.8 mi upstream of the confluence with the Rio Grande, where Ancho Spring is located. This perennial spring supports perennial flow for a very short segment of the canyon where it converges with the Rio Grande.

Chaquehui Canyon originates in Bandelier National Monument at an elevation of 6580 ft. The watershed begins at the northeast corner of the monument, extending 0.4 mi before entering LANL property at the northwestern corner of TA-33 and trends southeast. The watershed continues across 2 mi of TA-33 and enters the Rio Grande at an elevation of 5370 ft. The area of the Chaquehui watershed is approximately 1.6 mi². Stream flow in Chaquehui Canyon is ephemeral.

Figure 8 shows the total monthly volume of discharge for the three stream gage discharge stations within the Ancho Canyon and Chaquehui Canyon watersheds. Stream gages E275 and E338 received discharge during July. Stream gage E340 received discharge only during September.

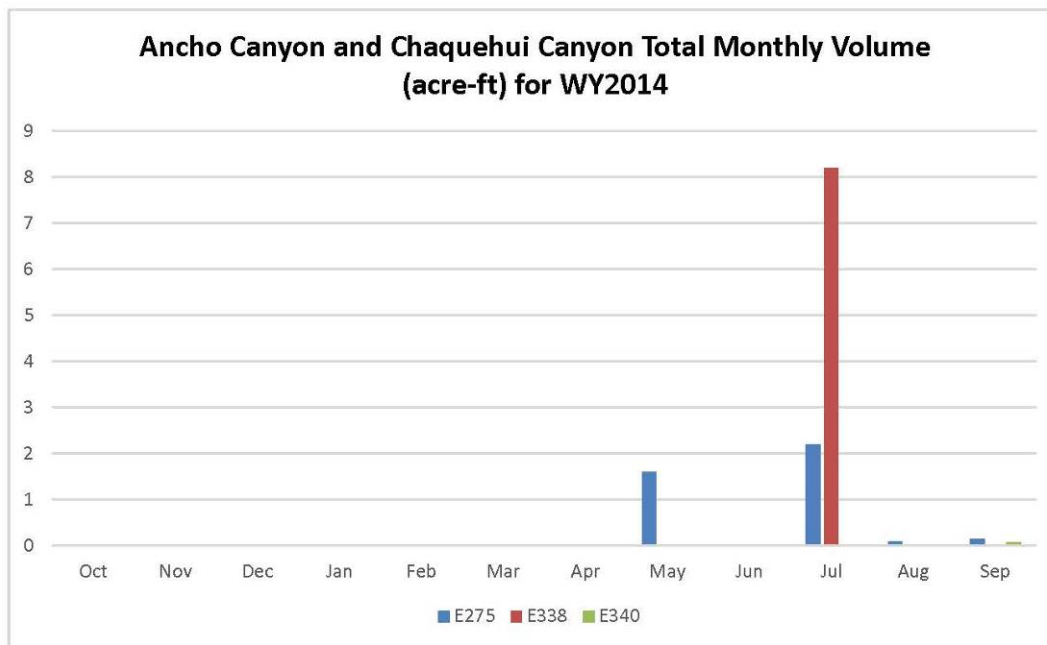

Figure 8 Total monthly volume (acre-ft) for WY2014 in Ancho Canyon and Chaquehui Canyon

Surface Water Data, Water Year 2014

E275 Ancho Canyon below SR 4

Location. Lat 35° 46' 54", long -106° 14' 42", Sec. 19, T. 18 N., R. 7 E., Ramon Vigil Land Grant, Los Alamos County.

Drainage Area. 4.75 mi².

Period of Record. December 1993 to September 30, 2014.

Revised Record. Drainage area (2006).

Gage. Data logger with radio telemetry and concrete stabilized natural control. Elevation of gage is 6193 ft using LANL LIDAR DEM with NAD 83.

Average Volume. 3 yr, 72 acre-ft/yr.

Maximum Discharge for Period of Record. Maximum discharge, 536 ft³/s, August 4, 2008, estimated from high-water-mark survey.

Maximum Discharge for Current Water Year. Maximum discharge, 74 ft³/s, July, 29, 2014, gage height 1.76 ft.



E275 Stream gage upstream view

Surface Water Data, Water Year 2014

Equipment. The station is equipped with a Sutron 9210 data logger (5-min interval), an MDS 4710 radio transceiver, and a shaft encoder float system. The system is powered by a solar-panel battery system housed in a NEMA shelter. The station is equipped with an ISCO pump sampler to collect water-quality samples. The ISCO sampler is housed in a separate shelter, a 3- x 4-ft metal box. The sampler is triggered by stage through the data logger. An outside staff gage is available for reference. No provision has been made for measurements above the wading stage.

Fieldwork

Number of Stream Gage Inspections	Number of Stream Gage Maintenance Visits	Number of ISCO 12-Count Sampler Inspections	Number of ISCO 12-Count Sampler Maintenance Visits	Number of ISCO 24-Count Sampler Inspections	Number of ISCO 24-Count Sampler Maintenance Visits
14	7	17	3	n/a*	n/a

* n/a = Not applicable.

Datum Correction. None.

Gage-Height Record. The data logger referenced to the outside gage gave a complete and satisfactory record, except for February 2, 2014; August 17, 24, 30, and 31, 2014; and September 2, 2014, when the equipment malfunctioned.

Rating. The streambed is a series of outcrops and sand pockets with moderate sand movement during flow events. The high-water channel is straight for 200 ft upstream. Flow below the gage becomes supercritical as the fall increases radically below the station. A channel a quarter-mile upstream has very low banks and may spread out to large widths. The channel contracts markedly from there to the gage. The control is a natural rock outcrop stabilized by concrete.

Rating No. 1 was developed from the PZF and previous measurement and slope area.

No discharge measurements were made during the year.

Discharge. Discharge was computed by directly applying the gage height to Rating No. 1.

Surface Water Data, Water Year 2014

E275 Daily Peak Discharge (ft³/s)

Day	Oct	Nov	Dec	Jan	Feb	Mar	Apr	May	Jun	Jul	Aug	Sep
1	0	0	0	0	0	0	0	0	0	0	0	0
2	0	0	0	0	E*	0	0	0	0	0	0	E
3	0	0	0	0	0	0	0	0	0	0	0	0
4	0	0	0	0	0	0	0	0	0	0	1.5	0
5	0	0	0	0	0	0	0	0	0	0	0	5.7
6	0	0	0	0	0	0	0	0	0	0	0	0
7	0	0	0	0	0	0	0	0	0	0	0	0
8	0	0	0	0	0	0	0	0	0	0	0	0
9	0	0	0	0	0	0	0	0	0	0	0	0
10	0	0	0	0	0	0	0	0	0	0	0	0
11	0	0	0	0	0	0	0	0	0	0	0	0
12	0	0	0	0	0	0	0	0	0	0	0	0
13	0	0	0	0	0	0	0	0	0	0	0	0
14	0	0	0	0	0	0	0	0.81	0	0	0	0
15	0	0	0	0	0	0	0	0	0	0	0	0
16	0	0	0	0	0	0	0	0	0	0	0	0
17	0	0	0	0	0	0	0	0	0	0	E	0
18	0	0	0	0	0	0	0	0	0	0	0	0
19	0	0	0	0	0	0	0	0	0	0	0	0
20	0	0	0	0	0	0	0	0	0	0	0	0
21	0	0	0	0	0	0	0	0	0	0	0	0
22	0	0	0	0	0	0	0	0	0	0	0	0
23	0	0	0	0	0	0	0	0	0	23	0	0
24	0	0	0	0	0	0	0	0	0	0	E	0
25	0	0	0	0	0	0	0	0	0	0	0	0
26	0	0	0	0	0	0	0	0	0	0	0	0
27	0	0	0	0	0	0	0	0	0	0	0	0
28	0	0	0	0	0	0	0	0	0	0	0	0
29	0	0	0	0		0	0	0	0	74	0	3.0
30	0	0	0	0		0	0	0	0	0	E	0
31	0		0	0		0		0		0	E	

* E represents equipment failure.

E275 Monthly Summary Table

	Oct	Nov	Dec	Jan	Feb	Mar	Apr	May	Jun	Jul	Aug	Sep	WY
Total (acre-ft)	0	0	0	0	0	0	0	1.6	0	2.2	0.08	0.14	4
Max Daily Peak (ft ³ /s)	0	0	0	0	0	0	0	0.81	0	74	1.5	5.7	74
Min Daily Peak (ft ³ /s)	0	0	0	0	0	0	0	0	0	0	0	0	0
Missing Days	0	0	0	0	0	0	0	0	0	0	2	1	3

Surface Water Data, Water Year 2014

E338 Chaquehui at TA-33

Location. Lat 35° 46' 11", long -106° 15' 7", Sec. 19, T. 18 N., R. 7 E., Ramon Vigil Land Grant, Los Alamos County.

Drainage Area. 12.18 mi².

Period of Record. October 1, 1999, to January 8, 2001; October 4, 2001, to September 30, 2014.

Revised Record. None.

Gage. Data logger with radio telemetry. Elevation of gage is 6227 ft using LANL LIDAR DEM with NAD 83.

Average Volume. 2 yr, 20 acre-ft/yr.

Maximum Discharge for Period of Record. Maximum discharge 239 ft³/s, September 13, 2013, gage height 2.98 ft.

Maximum Discharge for Current Water Year. Maximum discharge 179 ft³/s, July 23, 2014, gage height 2.7 ft.



E338 Stream gage downstream view

Surface Water Data, Water Year 2014

Equipment. The station is equipped with a Sutron 9210 data logger (5-min interval) and a Milltronics sonic probe. The system is powered by a solar-panel battery system housed in a NEMA shelter. The station is equipped with two ISCO samplers (one 12-count 1-L glass and polyethylene bottle sampler and one 24-count 1-L polyethylene bottle sampler) to collect water-quality samples. The ISCO samplers are housed in a separate 3- × 4-ft metal box. The samplers are triggered by stage through the data logger. An outside staff gage is available for reference. No provision has been made for measurements above the wading stage. All high-flow measurements will be by slope-area or critical-depth computation methods.

Fieldwork

Number of Stream Gage Inspections	Number of Stream Gage Maintenance Visits	Number of ISCO 12-Count Sampler Inspections	Number of ISCO 12-Count Sampler Maintenance Visits	Number of ISCO 24-Count Sampler Inspections	Number of ISCO 24-Count Sampler Maintenance Visits
14	6	8	6	n/a*	n/a

* n/a = Not applicable.

Datum Correction. None.

Gage-Height Record. The data logger referenced to the inside staff gage gave a complete and satisfactory record for the entire year.

Rating. The channel makes a 30-degree turn approximately 25 ft upgrade from the staff plate and then runs straight downgrade for 80 ft. The channel is confined by steep cutbanks on both sides that should remain stable with flows confined within the channel. The channel bottom is approximately 4 ft wide and made up of fine sand and pumice cobble. The control is the open channel.

Rating No. 1 was developed from previous measurement and slope area.

No discharge measurements were made during the year.

Discharge. Discharge was computed by directly applying the gage height to Rating No. 1.

Surface Water Data, Water Year 2014

E338 Daily Peak Discharge (ft³/s)

Day	Oct	Nov	Dec	Jan	Feb	Mar	Apr	May	Jun	Jul	Aug	Sep
1	0	0	0	0	0	0	0	0	0	0	0	0
2	0	0	0	0	0	0	0	0	0	0	0	0
3	0	0	0	0	0	0	0	0	0	0	0	0
4	0	0	0	0	0	0	0	0	0	0	0	0
5	0	0	0	0	0	0	0	0	0	0	0	0
6	0	0	0	0	0	0	0	0	0	0	0	0
7	0	0	0	0	0	0	0	0	0	0	0	0
8	0	0	0	0	0	0	0	0	0	0	0	0
9	0	0	0	0	0	0	0	0	0	0	0	0
10	0	0	0	0	0	0	0	0	0	0	0	0
11	0	0	0	0	0	0	0	0	0	0	0	0
12	0	0	0	0	0	0	0	0	0	0	0	0
13	0	0	0	0	0	0	0	0	0	0	0	0
14	0	0	0	0	0	0	0	0	0	0	0	0
15	0	0	0	0	0	0	0	0	0	0	0	0
16	0	0	0	0	0	0	0	0	0	0	0	0
17	0	0	0	0	0	0	0	0	0	0	0	0
18	0	0	0	0	0	0	0	0	0	0	0	0
19	0	0	0	0	0	0	0	0	0	0	0	0
20	0	0	0	0	0	0	0	0	0	0	0	0
21	0	0	0	0	0	0	0	0	0	0	0	0
22	0	0	0	0	0	0	0	0	0	0	0	0
23	0	0	0	0	0	0	0	0	0	179	0	0
24	0	0	0	0	0	0	0	0	0	1.1	0	0
25	0	0	0	0	0	0	0	0	0	1.3	0	0
26	0	0	0	0	0	0	0	0	0	1.1	0	0
27	0	0	0	0	0	0	0	0	0	1.3	0	0
28	0	0	0	0	0	0	0	0	0	0.73	0	0
29	0	0	0	0		0	0	0	0	20	0	0
30	0	0	0	0		0	0	0	0	0	0	0
31	0		0	0		0		0		0	0	

E338 Monthly Summary Table

	Oct	Nov	Dec	Jan	Feb	Mar	Apr	May	Jun	Jul	Aug	Sep	WY
Total (acre-ft)	0	0	0	0	0	0	0	0	0	8.2	0	0	8.2
Max Daily Peak (ft ³ /s)	0	0	0	0	0	0	0	0	0	179	0	0	179
Min Daily Peak (ft ³ /s)	0	0	0	0	0	0	0	0	0	0	0	0	0
Missing Days	0	0	0	0	0	0	0	0	0	0	0	0	0

Surface Water Data, Water Year 2014

E340 Chaquehui Tributary at TA-33

Location. Lat 35° 46' 46", long -106° 15' 1", Sec. 19, T. 18 N., R. 7 E., Ramon Vigil Land Grant, Los Alamos County.

Drainage Area. 1.33 mi².

Period of Record. February 7, 2001, to October 14, 2003; May 14, 2004, to September 30, 2014.

Revised Record. None.

Gage. Data logger with radio telemetry. Elevation of gage is 6423 ft using LANL LIDAR DEM with NAD 83.

Average Volume. 2 yr, 4 acre-ft/yr.

Maximum Discharge for Period of Record. Maximum discharge 38 ft³/s, September 14, 2013, gage height 1.2 ft.

Maximum Discharge for Current Water Year. Maximum discharge 4.2 ft³/s, September 5, 2014, gage height 0.48 ft.



E340 Stream gage, downstream to the right

Surface Water Data, Water Year 2014

Equipment. The station is equipped with a Sutron 9210 data logger (5-min interval), an MDS 4710 radio transceiver, and a Sutron Accubar bubbler sensor. The system is powered by a solar-panel battery system housed in a NEMA shelter. The station is equipped with two ISCO samplers (one 12-count 1-L glass and polyethylene bottle sampler and one 24-count 1-L polyethylene bottle sampler) to collect water-quality samples. The ISCO samplers are housed in a separate 3- x 4-ft metal box. The samplers are triggered by stage through the data logger. An outside staff gage is available for reference. No provision has been made for measurements above the wading stage. All high-flow measurements will be by slope-area or critical-depth computation methods.

Fieldwork

Number of Stream Gage Inspections	Number of Stream Gage Maintenance Visits	Number of ISCO 12-Count Sampler Inspections	Number of ISCO 12-Count Sampler Maintenance Visits	Number of ISCO 24-Count Sampler Inspections	Number of ISCO 24-Count Sampler Maintenance Visits
12	3	6	2	n/a*	n/a

* n/a = Not applicable.

Datum Correction. None.

Gage-Height Record. The data logger referenced to the inside staff gage gave a complete and satisfactory record for the year.

Rating. The channel zigzags downgrade while dropping off low bedrock shelves into sandy bottoms both above and below the gage station. The channel maintains approximately a 3-ft width while being contained by soil banks that may erode with heavy flows but otherwise remain stable with low flows. The control is a bedrock open channel and is very stable at the staff plate.

Rating No. 1 was developed from previous measurement and slope area.

No discharge measurements were made during the year.

Discharge. Discharge was computed by directly applying the gage height to Rating No. 1.

Surface Water Data, Water Year 2014

E340 Daily Peak Discharge (ft³/s)

Day	Oct	Nov	Dec	Jan	Feb	Mar	Apr	May	Jun	Jul	Aug	Sep
1	0	0	0	0	0	0	0	0	0	0	0	0
2	0	0	0	0	0	0	0	0	0	0	0	0
3	0	0	0	0	0	0	0	0	0	0	0	0
4	0	0	0	0	0	0	0	0	0	0	0	0
5	0	0	0	0	0	0	0	0	0	0	0	4.2
6	0	0	0	0	0	0	0	0	0	0	0	0
7	0	0	0	0	0	0	0	0	0	0	0	0
8	0	0	0	0	0	0	0	0	0	0	0	0
9	0	0	0	0	0	0	0	0	0	0	0	0
10	0	0	0	0	0	0	0	0	0	0	0	0
11	0	0	0	0	0	0	0	0	0	0	0	0
12	0	0	0	0	0	0	0	0	0	0	0	0
13	0	0	0	0	0	0	0	0	0	0	0	0
14	0	0	0	0	0	0	0	0	0	0	0	0
15	0	0	0	0	0	0	0	0	0	0	0	0
16	0	0	0	0	0	0	0	0	0	0	0	0
17	0	0	0	0	0	0	0	0	0	0	0	0
18	0	0	0	0	0	0	0	0	0	0	0	0
19	0	0	0	0	0	0	0	0	0	0	0	0
20	0	0	0	0	0	0	0	0	0	0	0	0
21	0	0	0	0	0	0	0	0	0	0	0	0
22	0	0	0	0	0	0	0	0	0	0	0	0
23	0	0	0	0	0	0	0	0	0	0	0	0
24	0	0	0	0	0	0	0	0	0	0	0	0
25	0	0	0	0	0	0	0	0	0	0	0	0
26	0	0	0	0	0	0	0	0	0	0	0	0
27	0	0	0	0	0	0	0	0	0	0	0	0
28	0	0	0	0	0	0	0	0	0	0	0	0
29	0	0	0	0		0	0	0	0	0	0	0
30	0	0	0	0		0	0	0	0	0	0	0
31	0		0	0		0		0		0	0	

E340 Monthly Summary Table

	Oct	Nov	Dec	Jan	Feb	Mar	Apr	May	Jun	Jul	Aug	Sep	WY
Total (acre-ft)	0	0	0	0	0	0	0	0	0	0	0	0.06	0.06
Max Daily Peak (ft ³ /s)	0	0	0	0	0	0	0	0	0	0	0	4.2	4.2
Min Daily Peak (ft ³ /s)	0	0	0	0	0	0	0	0	0	0	0	0	0
Missing Days	0	0	0	0	0	0	0	0	0	0	0	0	0

Surface Water Data, Water Year 2014

PRECIPITATION GAGE STATIONS

Data Collection and Computation

A complete record at a precipitation gage station consists of precipitation measurements directly observed using a tipping bucket. Five-minute records of precipitation were provided from a data logger, validated, and archived. The total daily precipitation is a sum of the 5-min precipitation records for the calendar day.

Accuracy of Records

The number of significant figures used to report daily precipitation is based solely on measured precipitation to the nearest hundredth.

Factors that affect the accuracy of the precipitation record include the following:

- Debris in the tipping bucket
- Precipitation in the form of hail or snow

Data Presentation

The records published in this report consist of two parts for each precipitation gage station:

- Station analysis summary with photo when available
- Data table for the water year (October 1, 2013, to September 30, 2014)

The station analysis supplements each daily values table and includes a description of gage location, the period of record, gage information, a description of monitoring equipment, fieldwork visits, the maximum daily total precipitation for the period of record and the current monsoon season, and a description of the precipitation record.

Location: The most accurate and available maps, coupled with LIDAR DEM using NAD 83, provide location information.

Period of Record: The period of record is the time during which published records exist for a station or its equivalent station. An equivalent station is one that was in operation when the present station was not in operation and was located so its records can be reasonably considered equivalent to records from the present station.

Gage: This section describes the datum of the current gage referred to in NAD 83.

Equipment: This section describes the equipment located at each site.

Fieldwork: Totals are presented for rain gage inspections and rain gage maintenance performed by field crews during the water year.

Maximum Daily Total Precipitation for Period of Record: The record includes the maximum daily precipitation. Unless otherwise qualified, the maximum precipitation is the total daily maximum.

Maximum Daily Total Precipitation for Current Monsoon Season: Maximums given are similar to those for the period of record. The time for daily totals is expressed in 24-h local standard time.

Surface Water Data, Water Year 2014

Precipitation Record: The precipitation record includes the periods when the gage station was shut down for winterization and when the record was incomplete because of problems with data collection.

The monthly total precipitation table records the total monthly precipitation from October 2013 to October 2014. The row titled "Total (in.)" contains the sum of the daily precipitation for each month in inches, the row titled "Mean Total for Period of Record (in.)" contains the mean total for each month in inches, the row titled "Max Daily Total (in.)" contains the maximum daily total precipitation for each month in inches, and the row titled "Missing Days" contains the number of days missing for each month.

The table below shows the total precipitation for May 1 to September 30, 2014. Most of the annual precipitation occurs during the monsoon season. The column titled "Days with Rain" shows the total number of days precipitation occurred during this period for each rain gage. The column titled "Total Precipitation" contains the sum of the daily precipitation for this period for each precipitation gage.

Precipitation Summary for Monsoon Season, May 1, 2013–September 30, 2014

Rain Gage	Days with Rain	Total Precipitation (in.)	Maximum Daily Total Precipitation (in.)	Elevation (ft)
E038	48	10.35	0.98	7087
E042.1	45	9.64	1.14	6379
R055.5	54	13.51	1.37	7102
E121.9	51	13.66	1.34	7336
E200.5	53	10.85	0.83	7214
E203	55	12.55	1.0	6817
E240	55	12.74	1.3	7719
E245.5	55	12.13	0.9	6796
E253	55	11.87	1.06	7719
E257	54	14.38	1.8	7360
E262.4	52	16.65	1.09	7124
E265	53	11.33	0.95	6311
E267.4	50	13.74	0.89	6865
E340	49	11.49	0.98	6423
TA-6	53	18.88	1.46	7423
TA-49	42	15.76	0.92	7045
TA-53	32	9.25	0.96	6992
TA-54	41	10.53	1.46	6553
North Community	45	11.87	0.59	7414

Extended Precipitation Network

Measurement, collection, and management of precipitation data and calculated results are required by LANL's National Pollutant Discharge Elimination System (NPDES) Multi-Sector General Permit (NMR05GB21), the Construction General Permit, and the NPDES Individual Permit for Storm Water Discharge from Solid Waste Management Units and Areas of Concern (NM0030759), issued to LANL by the U.S. Environmental Protection Agency (EPA). The precipitation data are also used by Compliance Order on Consent and environmental surveillance storm water projects to guide field activities such as monitoring station inspections and sample retrieval. The use of the extended rain gage network allows the

Surface Water Data, Water Year 2014

storm water projects to optimize field team response to only those areas where precipitation likely resulted in runoff or exceeded a pre-established trigger amount.

The extended precipitation network consists of 14 precipitation gage stations located within the LANL boundary. The gages collect 5-min precipitation data in tipping buckets. The network is active from April to November when precipitation is most likely to occur on the Pajarito Plateau. Each precipitation gage station is named after its collocated or formerly collocated stream gage station per the USGS Water Resources Division's naming convention previously described in the stream discharge gage station section of this report.

Figure 9 shows the total monthly precipitation for the 14 extended network gages from October 2013 to September 2014, with December 2013 to March 2014 omitted because the gages were shut down for winter.

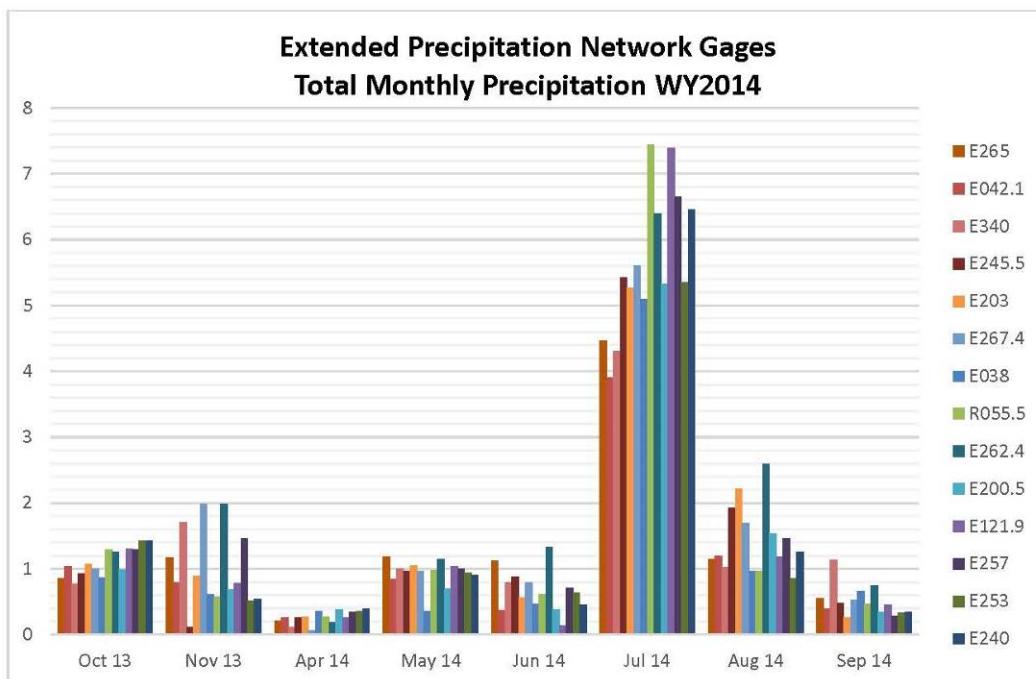

Note: The gages are listed in ascending order, from lowest elevation (E265 at 6311 ft) to highest elevation (E240 at 7719 ft).

Figure 9 Total monthly precipitation for the extended precipitation network gages for WY2014, excluding December 2013 to March 2014, when the gages were shut down for winter

E038 DP Canyon above TA-21

Location. Lat 35° 52' 49", long -106° 16' 58", SW ¼, Sec. 14, T. 19 N., R. 6 E., Los Alamos County.

Period of Record. April 23, 2008, to September 30, 2014.

Gage. Elevation of gage is 7087 ft using LANL LIDAR DEM with NAD 83.

Maximum Daily Total Precipitation for Period of Record. 2.08 in. on September 13, 2013.

Maximum Daily Total Precipitation for Monsoon Season. 0.98 in. on July 15, 2014.

Equipment. The station is equipped with a Rain Collection II tipping bucket rain gage. The equipment is powered with a solar-panel battery-charging system.

Fieldwork. The station was visited 26 times to perform inspections and 9 times to conduct maintenance.

Precipitation Record. The precipitation gage gave a complete and satisfactory record, except for November 7, 2013, to March 13, 2014, when the gage was shut down for winter.



E038 Precipitation gage

Surface Water Data, Water Year 2014

Daily Total Precipitation (in.) for E038

Day	Oct	Nov	Dec	Jan	Feb	Mar	Apr	May	Jun	Jul	Aug	Sep
1	0	0	IAa	IA	IA	IA	0	0	0	0	0.15	0
2	0	0	IA	IA	IA	IA	0	0	0	0.14	0	0
3	0	0	IA	IA	IA	IA	0	0	0	0	0	0
4	0	0.58	IA	IA	IA	IA	0	0	0	0.05	0.32	0
5	0	0.03	IA	IA	IA	IA	0.02 S	0	0	0.01	0.14	0.37
6	0	0	IA	IA	IA	IA	0.24 S	0	0	0	0	0
7	0	IA	IA	IA	IA	IA	0.01 S	0	0.23	0.01	0	0
8	0	IA	IA	IA	IA	IA	0	0	0	0.52	0	0
9	0	IA	IA	IA	IA	IA	0	0	0	0.06	0	0
10	0.12	IA	IA	IA	IA	IA	0	0	0	0	0.08	0
11	0	IA	IA	IA	IA	IA	0	0	0	0.03	0.01	0
12	0	IA	IA	IA	IA	IA	0	0	0	0	0	0.01
13	0.15 S ^b	IA	IA	IA	IA	IA	0.01	0.01	0.04	0	0.01	0
14	0	IA	IA	IA	IA	0.06	0.03 S	0	0	0.69	0	0
15	0.14 S	IA	IA	IA	IA	0.04	0	0	0	0.98	0.02	0
16	0.05 S	IA	IA	IA	IA	0	0	0	0	0.24	0	0
17	0	IA	IA	IA	IA	0	0	0	0	0.02	0	0
18	0	IA	IA	IA	IA	0	0	0	0	0	0	0
19	0	IA	IA	IA	IA	0	0.03	0	0	0.17	0	0
20	0	IA	IA	IA	IA	0	0.01	0	0	0.12	0	0
21	0	IA	IA	IA	IA	0	0	0	0.2	0.03	0.01	0
22	0	IA	IA	IA	IA	0	0	0.26	0	0	0.09	0.07
23	0	IA	IA	IA	IA	0	0	0.31	0	0	0	0
24	0.35	IA	IA	IA	IA	0	0	0.12	0	0	0	0
25	0.02	IA	IA	IA	IA	0.03	0	0.14	0	0	0	0
26	0	IA	IA	IA	IA	0	0	0	0	0.06	0.13	0
27	0	IA	IA	IA	IA	0	0.01	0	0	0.39	0	0
28	0	IA	IA	IA	IA	0	0	0	0	0.13	0	0
29	0.01	IA	IA	IA		0	0	0.01	0	0.57	0	0.21
30	0.03	IA	IA	IA		0	0	0	0	0	0	0
31	0		IA	IA		0		0		0.86	0	

^a IA represents inactive gage during seasonal shutdown.

^b S represents precipitation as snow.

Monthly Total Precipitation (in.) for E038, October 2013–October 2014

	Oct	Nov	Dec	Jan	Feb	Mar	Apr	May	Jun	Jul	Aug	Sep
Total (in.)	0.87	0.61 ^a	IA ^b	IA	IA	0.13 ^a	0.36	0.85	0.47	5.09	0.96	0.66
Mean Total for Period of Record (in.)	1.33	n/a ^c	n/a	n/a	n/a	n/a	0.70	1.0	0.25	2.55	2.40	1.80
Max Daily Total (in.)	0.35	0.58	IA	IA	IA	0.06	0.24S ^d	0.31	0.23	0.98	0.32	0.37
Missing Days	0	24	31	31	28	13	0	0	0	0	0	0

^a Partial month because of inactivity, maintenance, or equipment failure.

^b IA represents inactive gage during seasonal shutdown.

^c n/a = Not applicable.

^d S represents precipitation as snow.

Surface Water Data, Water Year 2014

E042.1 Los Alamos above Low Head Weir

Location. Lat 35° 52' 2", long -106° 13' 25", NW ¼, Sec. 20, T. 19 N., R. 7 E., Santa Fe County.

Period of Record. July 27, 2010, to September 30, 2014.

Gage. Elevation of gage is 6377 ft using LANL LIDAR DEM with NAD 83.

Maximum Daily Total Precipitation for Period of Record. 2.27 in. on September 12, 2013, estimated.

Maximum Daily Total Precipitation for Monsoon Season. 1.14 in. on July 14, 2014.

Equipment. The station is equipped with a Rain Collection II tipping bucket rain gage. The equipment is powered with a solar-panel battery-charging system.

Fieldwork. The station was visited 33 times to perform inspections and 12 times to conduct maintenance.

Precipitation Record. The precipitation gage gave a complete and satisfactory record, except for November 6, 2013, to February 11, 2014, when the gage was shut down for winter.



E042.1 Precipitation gage

Surface Water Data, Water Year 2014

Daily Total Precipitation (in.) for E042.1

Day	Oct	Nov	Dec	Jan	Feb	Mar	Apr	May	Jun	Jul	Aug	Sep
1	0	0	IA ^a	IA	IA	IA	0	0	0	0.01	0.09	0
2	0	0	IA	IA	IA	IA	0	0	0	0.29	0	0
3	0	0	IA	IA	IA	IA	0	0	0	0	0	0
4	0	0.78	IA	IA	IA	IA	0	0	0	0.01	0.21	0
5	0	0.01	IA	IA	IA	IA	0.05S ^b	0	0	0	0.12	0.06
6	0	IA	IA	IA	IA	IA	0.1S	0	0	0	0	0
7	0	IA	IA	IA	IA	IA	0.01S	0	0.17	0	0	0
8	0	IA	IA	IA	IA	IA	0	0	0	0.64	0	0
9	0	IA	IA	IA	IA	IA	0	0	0	0.02	0	0
10	0.24	IA	IA	IA	IA	IA	0	0	0	0	0.29	0
11	0	IA	IA	IA	IA	IA	0	0	0	0	0	0
12	0.01	IA	IA	IA	IA	IA	0	0.02	0	0	0	0
13	0.06S	IA	IA	IA	IA	IA	0	0	0.06	0.01	0.02	0
14	0	IA	IA	IA	IA	0.04	0.03S	0	0	1.14	0	0
15	0.24S	IA	IA	IA	IA	0.03	0	0	0	0.69	0	0.04
16	0	IA	IA	IA	IA	0	0	0	0	0.1	0	0
17	0	IA	IA	IA	IA	0	0	0	0	0	0	0
18	0	IA	IA	IA	IA	0	0	0	0	0	0	0
19	0	IA	IA	IA	IA	0	0.06	0	0	0.07	0	0
20	0	IA	IA	IA	IA	0	0.01	0	0	0.04	0	0.02
21	0	IA	IA	IA	IA	0	0	0	0.14	0.09	0.04	0
22	0	IA	IA	IA	IA	0	0	0.42	0	0	0.09	0.04
23	0	IA	IA	IA	IA	0	0	0.16	0	0	0	0
24	0.28	IA	IA	IA	IA	0	0	0.16	0	0	0	0
25	0.02	IA	IA	IA	IA	0.03	0	0.05	0	0	0	0
26	0	IA	IA	IA	IA	0.01S	0	0	0	0	0.33	0
27	0	IA	IA	IA	IA	0	0	0	0	0.08	0	0
28	0	IA	IA	IA	IA	0	0	0	0	0.07	0	0
29	0.01S	IA	IA	IA		0	0	0.03	0	0.05	0	0.23
30	0.14S	IA	IA	IA		0	0	0	0	0	0	0
31	0.04		IA	IA		0		0		0.6	0	

^a IA represents inactive gage during seasonal shutdown.

^b S represents precipitation as snow.

Monthly Total Precipitation (in.) for E042.1, October 2013–October 2014

	Oct	Nov	Dec	Jan	Feb	Mar	Apr	May	Jun	Jul	Aug	Sep
Total (in.)	1.04	0.79 ^a	IA ^b	IA	IA	0.11 ^a	0.26	0.84	0.37	3.91	1.19	0.39
Mean Total for Period of Record (in.)	0.93	n/a ^c	n/a	n/a	n/a	n/a	0.44	0.47	0.54	2.03	2.19	1.37
Max Daily Total (in.)	0.28	0.78	IA	IA	IA	0.04	0.06	0.42	0.17	1.14	0.33	0.23
Missing Days	0	25	31	31	11	0	0	0	0	0	0	0

^a Partial month because of inactivity, maintenance, or equipment failure.

^b IA represents inactive gage during seasonal shutdown.

^c n/a = Not applicable.

Surface Water Data, Water Year 2014

R055.5 South Fork of Acid Canyon

Location. Lat 35° 53' 10", long -106° 18' 26", SE ¼, Sec. 9, T. 19 N., R. 6 E., Los Alamos County.

Period of Record. July 29, 2008, to September 30, 2014.

Gage. Elevation of gage is 7102 ft using LANL LIDAR DEM with NAD 83.

Maximum Daily Total Precipitation for Period of Record. 2.26 in. on September 13, 2013.

Maximum Daily Total Precipitation for Monsoon Season. 1.37 in. on July 29, 2014.

Equipment. The station is equipped with a Rain Collection II tipping bucket rain gage. The equipment is powered with a solar-panel battery-charging system.

Fieldwork. The station was visited 26 times to perform inspections and 4 times to conduct maintenance.

Precipitation Record. The precipitation gage gave a complete and satisfactory record, except for November 6, 2013, to March 17, 2014, when the gage was shut down for winter.



R055.5 Precipitation gage

Surface Water Data, Water Year 2014

Daily Total Precipitation (in.) for R055.5

Day	Oct	Nov	Dec	Jan	Feb	Mar	Apr	May	Jun	Jul	Aug	Sep
1	0	0	IA ^a	IA	IA	IA	0	0	0	0.01	0.19	0
2	0	0	IA	IA	IA	IA	0	0	0	0.06	0	0
3	0	0	IA	IA	IA	IA	0	0	0	0	0.01	0
4	0	0.57	IA	IA	IA	IA	0	0	0	0.05	0.38	0.03
5	0	0	IA	IA	IA	IA	0	0	0	0.01	0.1	0.17
6	0	IA	IA	IA	IA	IA	0.07S ^b	0	0	0	0	0
7	0	IA	IA	IA	IA	IA	0.01	0	0.21	0.4	0	0
8	0	IA	IA	IA	IA	IA	0	0	0	1.09	0	0
9	0.01	IA	IA	IA	IA	IA	0	0	0	0.04	0	0
10	0.28	IA	IA	IA	IA	IA	0	0	0	0	0	0
11	0	IA	IA	IA	IA	IA	0	0	0	0.03	0	0
12	0.01	IA	IA	IA	IA	IA	0	0.01	0	0	0	0.01
13	0.15S	IA	IA	IA	IA	IA	0.07	0.02	0.11	0.02	0.02	0
14	0	IA	IA	IA	IA	IA	0.02S	0	0	0.83	0	0
15	0.22S	IA	IA	IA	IA	IA	0	0	0	0.88	0.06	0
16	0.19S	IA	IA	IA	IA	IA	0	0	0	0.17	0	0
17	0	IA	IA	IA	IA	IA	0	0	0.04	0.06	0	0
18	0	IA	IA	IA	IA	IA	0	0	0	0	0	0
19	0	IA	IA	IA	IA	IA	0	0.04	0	0	0.38	0
20	0	IA	IA	IA	IA	IA	0	0.02	0	0	0.14	0
21	0	IA	IA	IA	IA	IA	0	0	0	0.25	0.03	0
22	0	IA	IA	IA	IA	IA	0	0	0.21	0	0.01	0.11
23	0	IA	IA	IA	IA	IA	0	0	0.35	0	0	0.01
24	0.34	IA	IA	IA	IA	IA	0	0	0.22	0	0	0
25	0.01	IA	IA	IA	IA	IA	0.03	0	0.15	0	0	0.01
26	0	IA	IA	IA	IA	IA	0.01S	0.01	0.01	0	0.1	0.1
27	0	IA	IA	IA	IA	IA	0.02S	0.03S	0	0	0.64	0
28	0	IA	IA	IA	IA	IA	0	0	0	0	0.16	0
29	0.02S	IA	IA	IA	IA	IA	0	0	0	0	1.37	0.18
30	0.06S	IA	IA	IA	IA	IA	0	0	0.01	0	0	0
31	0	IA	IA	IA	IA	IA	0	0	0	0.96	0	IA

^a IA represents inactive gage during seasonal shutdown.

^b S represents precipitation as snow.

Monthly Total Precipitation (in.) for R055.5, October 2013–October 2014

	Oct	Nov	Dec	Jan	Feb	Mar	Apr	May	Jun	Jul	Aug	Sep
Total (in.)	1.29	0.57 ^a	IA ^b	IA	IA	0.06 ^a	0.27	0.98	0.61	7.44	0.97	0.47
Mean Total for Period of Record (in.)	1.55	0.23	IA	IA	IA	IA	1.16	1.03	0.91	3.17	2.26	2.18
Max Daily Total (in.)	0.34	0.57	IA	IA	IA	0.03	0.07S	0.35	0.25	1.37	0.38	0.18
Missing Days	0	25	31	31	28	17	0	0	0	0	0	0

^a Partial month because of inactivity, maintenance, or equipment failure.

^b IA represents inactive gage during seasonal shutdown.

Surface Water Data, Water Year 2014

E121.9 Sandia Canyon East of Power Plant

Location. Lat 35° 52' 30", long -106° 19' 10", SW ¼, Sec. 16, T. 19 N., R. 6 E., Los Alamos County.

Period of Record. May 2, 2007, to September 30, 2014.

Gage. Elevation of gage is 7336 ft using LANL LIDAR DEM with NAD 83.

Maximum Daily Total Precipitation for Period of Record. 2.35 in. on September 13, 2013.

Maximum Daily Total Precipitation for Monsoon Season. 1.34 in. on July 31, 2014.

Equipment. The station is equipped with a Rain Collection II tipping bucket rain gage. The equipment is powered with a solar-panel battery-charging system.

Fieldwork. The station was visited 10 times to perform inspections and 2 times to conduct maintenance.

Precipitation Record. The precipitation gage gave a complete and satisfactory record, except for November 18, 2013, to March 2, 2014, when the gage was shut down for winter.



E121.9 Precipitation gage

Surface Water Data, Water Year 2014

Daily Total Precipitation (in.) for E121.9

Day	Oct	Nov	Dec	Jan	Feb	Mar	Apr	May	Jun	Jul	Aug	Sep
1	0	0	IA ^a	IA	IA	IA	0	0	0	0	0.16	0
2	0	0	IA	IA	IA	IA	0	0	0	0	0	0
3	0	0	IA	IA	IA	0	0	0	0	0	0	0
4	0	0.53	IA	IA	IA	0	0	0	0	0.04	0.39	0.04
5	0	0.01	IA	IA	IA	0	0	0	0	0	0.05	0.17
6	0	0	IA	IA	IA	0	0.04S ^b	0	0	0	0	0
7	0	0	IA	IA	IA	0	0	0	0.02	1.27	0	0
8	0	0	IA	IA	IA	0	0	0	0	1.33	0	0
9	0.01	0	IA	IA	IA	0	0	0	0	0.03	0	0
10	0.35	0	IA	IA	IA	0	0	0	0	0.04	0.04	0.01
11	0	0	IA	IA	IA	0	0	0	0	0.06	0	0
12	0	0	IA	IA	IA	0	0	0.02	0	0	0	0
13	0.12	0	IA	IA	IA	0	0.11	0.01	0.01	0.02	0.05	0
14	0.01S	0	IA	IA	IA	0.21	0.03S	0	0	0.7	0	0
15	0.21S	0.21	IA	IA	IA	0.02	0	0	0	0.63	0.28	0
16	0.21S	0.03	IA	IA	IA	0	0	0	0	0.14	0	0
17	0	0	IA	IA	IA	0	0	0	0.03	0.02	0	0
18	0	IA	IA	IA	IA	0	0	0	0	0	0.00	0
19	0	IA	IA	IA	IA	0	0.02	0	0	0.41	0	0
20	0	IA	IA	IA	IA	0	0.01	0	0	0.03	0	0
21	0	IA	IA	IA	IA	0	0	0	0.08	0.04	0	0
22	0	IA	IA	IA	IA	0	0	0.21	0	0	0.11	0.05
23	0	IA	IA	IA	IA	0	0	0.36	0	0	0.01	0
24	0.29	IA	IA	IA	IA	0	0	0.28	0	0	0	0
25	0.01	IA	IA	IA	IA	0.04	0	0.14	0	0	0	0
26	0	IA	IA	IA	IA	0	0.03	0.02	0	E	0.09	0
27	0	IA	IA	IA	IA	0.01	0.02S	0	0	E	0	0
28	0	IA	IA	IA	IA	0	0	0	0	E	0	0.01
29	0.04S	IA	IA	IA		0	0	0	0	1.24	0	0.17
30	0.05S	IA	IA	IA		0	0	0	0.00	0.05	0	0
31	0.01		IA	IA		0		0		1.34	0	

^a IA represents inactive gage during seasonal shutdown.

^b S represents precipitation as snow.

Monthly Total Precipitation (in.) for E121.9, October 2013–October 2014

	Oct	Nov	Dec	Jan	Feb	Mar	Apr	May	Jun	Jul	Aug	Sep
Total (in.)	1.31	0.78 ^a	IA ^b	IA	IA	0.28 ^a	0.26	1.04	0.14	7.39 ^a	1.18	0.45
Mean Total for Period of Record (in.)	1.26	0.23	IA	IA	IA	IA	0.81	0.93	0.82	1.98	2.14	2.84
Max Daily Total (in.)	0.35	0.53	IA	IA	IA	0.21	0.11	0.36	0.08	1.34	0.39	0.17
Missing Days	0	13	31	21	28	2	0	0	0	0	0	0

^a Partial month because of inactivity, maintenance, or equipment failure.

^b IA represents inactive gage during seasonal shutdown.

Surface Water Data, Water Year 2014

E200.5 Mortandad Canyon Tributary Batch Plant at Sigma

Location. Lat 35° 51' 57", long -106° 17' 24", NE ¼, Sec. 22, T.19 N., R. 6 E., Los Alamos County.

Period of Record. July 25, 2007, to September 30 2014.

Gage. Elevation of gage is 7214 ft using LANL LIDAR DEM with NAD 83.

Maximum Daily Total Precipitation for Period of Record. 2.53 in. on September 13, 2013.

Maximum Daily Total Precipitation for Monsoon Season. 0.83 in. on July 15, 2014.

Equipment. The station is equipped with a Rain Collection II tipping bucket rain gage. The equipment is powered with a solar-panel battery-charging system.

Fieldwork. The station was visited 9 times to perform inspections and 5 times to conduct maintenance.

Precipitation Record. The precipitation gage gave a complete and satisfactory record, except for November 14, 2013, to March 10, 2014, when the gage was shut down for winter.



E200.5 Precipitation gage

Surface Water Data, Water Year 2014

Daily Total Precipitation (in.) for E200.5

Day	Oct	Nov	Dec	Jan	Feb	Mar	Apr	May	Jun	Jul	Aug	Sep
1	0	0	IA ^a	IA	IA	IA	0	0	0	0	0.24	0
2	0	0	IA	IA	IA	IA	0	0	0	0.12	0	0
3	0	0	IA	IA	IA	IA	0	0	0	0	0	0
4	0	0.67	IA	IA	IA	IA	0	0	0	0.02	0.56	0
5	0	0.02	IA	IA	IA	IA	0.07	0	0	0	0.14	0.1
6	0	0	IA	IA	IA	IA	0.21	0	0	0	0	0
7	0	0	IA	IA	IA	IA	0	0	0.18	0.07	0	0
8	0	0	IA	IA	IA	IA	0	0	0.04	0.82	0	0
9	0.01	0	IA	IA	IA	IA	0	0	0	0.04	0	0
10	0.19	0	IA	IA	IA	IA	0	0	0	0	0.28	0.01
11	0	0	IA	IA	IA	0	0	0	0	0.05	0	0
12	0.04	0	IA	IA	IA	0	0	0	0	0.08	0	0
13	0.08S ^b	0	IA	IA	IA	0	0.04	0.01	0.05	0	0.01	0
14	0.01S	IA	IA	IA	IA	0.14	0.02S	0.01	0	0.64	0	0
15	0.17S	IA	IA	IA	IA	0.03	0	0	0	0.83	0.05	0
16	0.08S	IA	IA	IA	IA	0	0	0	0	0.17	0	0.01
17	0	IA	IA	IA	IA	0	0	0	0.01	0.04	0	0
18	0	IA	IA	IA	IA	0	0	0	0	0	0	0
19	0	IA	IA	IA	IA	0	0.04	0	0	0.48	0	0
20	0	IA	IA	IA	IA	0	0.01	0	0	0.12	0	0
21	0	IA	IA	IA	IA	0	0	0	0.1	0	0.01	0
22	0	IA	IA	IA	IA	0	0	0.21	0	0	0.09	0.06
23	0	IA	IA	IA	IA	0	0	0.14	0	0	0	0
24	0.32	IA	IA	IA	IA	0	0	0.31	0	0	0	0
25	0.01	IA	IA	IA	IA	0.03	0	0.01	0	0	0	0
26	0	IA	IA	IA	IA	0	0.01	0.01	0	0.13	0.15	0
27	0	IA	IA	IA	IA	0	0	0	0	0.38	0	0
28	0	IA	IA	IA	IA	0	0	0	0	0.13	0	0
29	0.02S	IA	IA	IA		0	0	0	0	0.43	0	0.16
30	0.05S	IA	IA	IA		0	0	0	0	0.03	0	0
31	0.01		IA	IA		0		0		0.74	0	

^a IA represents inactive gage during seasonal shutdown.

^b S represents precipitation as snow.

Monthly Total Precipitation (in.) for E200.5, October 2013–October 2014

	Oct	Nov	Dec	Jan	Feb	Mar	Apr	May	Jun	Jul	Aug	Sep
Total (in.)	0.99	0.69 ^a	IA ^b	IA	IA	0.2 ^a	0.38	0.7	0.38	5.32	1.53	0.34
Mean Total for Period of record (in.)	0.98	0.15	IA	IA	IA	IA	0.26	0.72	0.31	2.36	2.52	2.44
Max Daily total (in.)	0.32	0.67	IA	IA	IA	0.14	0.21	0.31	0.18	0.83	0.56	0.16
Missing Days	0	17	31	31	28	10	0	0	0	0	0	0

^a Partial month because of inactivity, maintenance, or equipment failure.

^b IA represents inactive gage during seasonal shutdown.

Surface Water Data, Water Year 2014

E203 Mortandad Canyon below Sediment Traps

Location. Lat 35° 51' 39", long -106° 16' 6", SE ¼, Sec. 23, T. 19 N., R. 6 E., Los Alamos County.

Period of Record. May 1, 2007, to September 30, 2014.

Gage. Elevation of gage is 6817 ft using LANL LIDAR DEM with NAD 83.

Maximum Daily Total Precipitation for Period of Record. 2.34 in. on September 13, 2013.

Maximum Daily Total Precipitation for Monsoon Season. 1.0 in. on July 15, 2014.

Equipment. The station is equipped with a Rain Collection II tipping bucket rain gage. The equipment is powered with a solar-panel battery-charging system.

Fieldwork. The station was visited 8 times to perform inspections and 2 times to conduct maintenance.

Precipitation Record. The precipitation gage gave a complete and satisfactory record, except for November 13, 2013, to March 17, 2014, when the gage was shut down for winter.



E203 Precipitation gage

Surface Water Data, Water Year 2014

Daily Total Precipitation (in.) for E203

Day	Oct	Nov	Dec	Jan	Feb	Mar	Apr	May	Jun	Jul	Aug	Sep	
1	0	0	IA ^a	IA	IA	IA	0	0	0	0.01	0.34	0	
2	0	0	IA	IA	IA	IA	0	0	0	0.25	0	0	
3	0	0	IA	IA	IA	IA	0.01S ^b	0	0	0	0.01	0	
4	0	0.88	IA	IA	IA	IA	0	0	0	0.01	0.59	0	
5	0	0.01	IA	IA	IA	IA	0.07S	0	0	0	0.27	0.05	
6	0	0	IA	IA	IA	IA	0.09S	0	0	0	0	0	
7	0	0	IA	IA	IA	IA	0.01S	0	0.28	0	0	0	
8	0	0	IA	IA	IA	IA	0	0	0.01	0.79	0	0	
9	0.02H ^c	0	IA	IA	IA	IA	0	0	0	0.04	0	0	
10	0.23H	0	IA	IA	IA	IA	0	0	0	0	0.19	0.01	
11	0.01	0	IA	IA	IA	IA	0	0	0	0	0	0	
12	0	0	IA	IA	IA	IA	0	0.01	0	0.04	0	0	
13	0.13	IA	IA	IA	IA	IA	0.01	0.01	0.04	0.01	0	0	
14	0	IA	IA	IA	IA	IA	0.03S	0	0	0.8	0	0	
15	0.26S	IA	IA	IA	IA	IA	0	0.01	0	1	0.07	0	
16	0.03S	IA	IA	IA	IA	IA	0	0	0	0.11	0	0	
17	0	IA	IA	IA	IA	IA	0	0	0	0.04	0	0.00	
18	0	IA	IA	IA	IA	IA	0	0	0	0	0	0	
19	0	IA	IA	IA	IA	IA	0	0.05	0	0	0.35	0	0
20	0	IA	IA	IA	IA	IA	0	0	0	0.13	0	0	
21	0	IA	IA	IA	IA	IA	0	0	0	0.23	0.02	0.02	0
22	0	IA	IA	IA	IA	IA	0	0	0.4	0	0	0.1	0.04
23	0	IA	IA	IA	IA	IA	0	0	0.35	0	0	0	0.01
24	0.32	IA	IA	IA	IA	IA	0	0	0.21	0	0	0	0
25	0.02	IA	IA	IA	IA	IA	0.03	0	0.04	0	0	0	0
26	0	IA	IA	IA	IA	IA	0.01 S	0	0	0	0.06	0.62	0
27	0	IA	IA	IA	IA	IA	0	0	0	0	0.39	0	0
28	0	IA	IA	IA	IA	IA	0	0	0	0	0.16	0	0
29	0.02S	IA	IA	IA		0	0	0.02	0	0.16	0	0.15	
30	0.02S	IA	IA	IA		0	0	0	0	0.01	0	0	
31	0.01		IA	IA		0		0		0.88	0		

^a IA represents inactive gage during seasonal shutdown.

^b S represents precipitation as snow.

^c H represents precipitation as hail.

Monthly Total Precipitation (in.) for E203, October 2013–October 2014

	Oct	Nov	Dec	Jan	Feb	Mar	Apr	May	Jun	Jul	Aug	Sep
Total (in.)	1.07	0.89 ^a	IA ^b	IA	IA	0.04 ^a	0.27	1.05	0.56	5.26	2.21	0.26
Mean Total for Period of Record (in.)	0.97	0.30	IA	IA	IA	IA	0.45	0.74	0.53	1.82	1.73	1.60
Max Daily Total (in.)	0.26	0.88	IA	IA	IA	0.03	0.07	0.35	0.28	1.0	0.62	0.15
Missing Days	0	18	31	31	28	17	0	0	0	0	0	0

^a Partial month because of inactivity, maintenance, or equipment failure.

^b IA represents inactive gage during seasonal shutdown.

Surface Water Data, Water Year 2014

E240 Pajarito Canyon below SR 501

Location. Lat 35° 52' 02", long -106° 21' 05", NW ¼, Sec. 19, T. 19 N., R. 6 E., Los Alamos County.

Period of Record. June 5, 2002, to September 30, 2014.

Gage. Elevation of gage is 7719 ft using LANL LIDAR DEM with NAD 83.

Maximum Daily Total Precipitation for Period of Record. 2.20 in. on September 12, 2013.

Maximum Daily Total Precipitation for Monsoon Season. 1.3 in. on July 29, 2014.

Equipment. The station is equipped with a rain gage, Rain Collection II. All equipment is powered with a solar-panel battery-charging system.

Fieldwork. The station was visited 23 times to perform inspections and 8 times to conduct maintenance.

Precipitation Record. The precipitation gage gave a complete and satisfactory record, except for November 8, 2013, to March 18, 2014, when the gage was shut down for winter.



E240 Precipitation gage

Surface Water Data, Water Year 2014

Daily Total Precipitation (in.) for E240

Day	Oct	Nov	Dec	Jan	Feb	Mar	Apr	May	Jun	Jul	Aug	Sep
1	0	0	IA ^a	IA	IA	IA	0	0	0	0	0.29	0
2	0	0	IA	IA	IA	IA	0	0	0	0	0	0
3	0	0	IA	IA	IA	IA	0.02	0	0	0.02	0	0
4	0	0.51	IA	IA	IA	IA	0	0	0	0.07	0.24	0.05
5	0	0.03	IA	IA	IA	IA	0	0	0	0.01	0	0.09
6	0	0	IA	IA	IA	IA	0	0	0	0	0	0
7	0	0	IA	IA	IA	IA	0.01S ^b	0	0.26	0.44	0	0
8	0	IA	IA	IA	IA	IA	0	0	0	0.47	0.02	0
9	0.01	IA	IA	IA	IA	IA	0	0	0	0.05	0.01	0
10	0.35	IA	IA	IA	IA	IA	0	0	0	0.43	0	0
11	0.01	IA	IA	IA	IA	IA	0	0	0	0.03	0	0
12	0	IA	IA	IA	IA	IA	0	0.02	0	0	0	0
13	0.14	IA	IA	IA	IA	IA	0.14	0.08	0.09	0.04	0.12	0
14	0	IA	IA	IA	IA	IA	0.04S	0	0	0.79	0	0
15	0.04S	IA	IA	IA	IA	IA	0	0	0	0.28	0.26	0
16	0.43S	IA	IA	IA	IA	IA	0	0	0	0.01	0	0.01
17	0	IA	IA	IA	IA	IA	0	0	0.01	0	0	0
18	0	IA	IA	IA	IA	0	0	0	0	0	0.01	0
19	0	IA	IA	IA	IA	0	0.07	0	0	0.86	0.01	0
20	0	IA	IA	IA	IA	0	0.01	0	0	0.04	0	0
21	0	IA	IA	IA	IA	0	0.01	0	0.1	0.02	0	0.01
22	0	IA	IA	IA	IA	0	0	0.15	0	0	0.17	0.07
23	0	IA	IA	IA	IA	0	0	0.29	0	0	0.01	0
24	0.36	IA	IA	IA	IA	0	0	0.26	0	0	0	0
25	0.01	IA	IA	IA	IA	0.06	0	0.1	0	0	0	0
26	0	IA	IA	IA	IA	0	0.02	0	0	0.01	0.12	0
27	0	IA	IA	IA	IA	0.03	0.07S	0	0	0.29	0	0
28	0	IA	IA	IA	IA	0	0	0	0	0.17	0	0
29	0.02S	IA	IA	IA		0	0	0	0	1.3	0	0.11
30	0.03S	IA	IA	IA		0	0	0	0	0.12	0	0
31	0.02		IA	IA		0		0		1.01	0	

^a IA represents inactive gage during seasonal shutdown.

^b S represents precipitation as snow.

Monthly Total Precipitation (in.) for E240, October 2013–September 2014

	Oct	Nov	Dec	Jan	Feb	Mar	Apr	May	Jun	Jul	Aug	Sep
Total (in.)	1.42	0.54 ^a	IA ^b	IA	IA	0.09 ^a	0.39	0.9	0.46	6.46	1.26	0.34
Mean Total for Period of Record (in.)	1.32	0.42	0.02	0	0	0	0.61	1.28	0.84	2.67	2.15	2.53
Max Daily Total (in.)	0.36	0.51	IA	IA	IA	0.06	0.07	0.29	0.26	1.30	0.29	0.11
Missing Days	0	23	31	31	28	17	0	0	0	0	0	0

^a Partial month because of inactivity, maintenance, or equipment failure.

^b IA represents inactive gage during seasonal shutdown.

Surface Water Data, Water Year 2014

E245.5 Pajarito Canyon above Three Mile Canyon

Location. Lat 35° 50' 45.3", long -106° 16' 29", Sec. 16, T. 19 N., R. 6 E., Ramon Vigil Land Grant, Los Alamos County.

Period of Record. May 18, 2007, to September 30, 2014.

Gage. Elevation of gage is 6796 ft using LANL LIDAR DEM with NAD 83.

Maximum Daily Total Precipitation for Period of Record. 2.06 in. on September 13, 2013.

Maximum Daily Total Precipitation for Monsoon Season. 0.90 in. on July 15, 2014.

Equipment. The station is equipped with a Rain Collection II tipping bucket rain gage. The equipment is powered with a solar-panel battery-charging system.

Fieldwork. The station was visited 23 times to perform inspections and 12 times to conduct maintenance.

Precipitation Record. The precipitation gage gave a complete and satisfactory record, except for November 15, 2013, to March 10, 2014, when the gage was shut down for winter.



E245.5 Precipitation gage

Surface Water Data, Water Year 2014

Daily Total Precipitation (in.) for E245.5

Day	Oct	Nov	Dec	Jan	Feb	Mar	Apr	May	Jun	Jul	Aug	Sep
1	0	0.07	IA ^a	IA	IA	IA	0	0	0	0.02	0.18	0
2	0	0	IA	IA	IA	IA	0	0	0	0.34	0	0
3	0	0.01	IA	IA	IA	IA	0	0	0	0	0.02	0
4	0	0.01	IA	IA	IA	IA	0	0	0	0	0.53	0
5	0	0	IA	IA	IA	IA	0.05S ^b	0	0	0	0.29	0.13
6	0	0	IA	IA	IA	IA	0.08S	0	0	0	0	0
7	0	0.02	IA	IA	IA	IA	0.01	0	0.39	0.07	0	0
8	0	0	IA	IA	IA	IA	0.02	0	0	0.82	0	0.01
9	0	0.01	IA	IA	IA	IA	0	0	0	0.03	0	0
10	0.22	0	IA	IA	IA	IA	0	0	0	0.01	0.16	0
11	0	0	IA	IA	IA	0	0	0	0	0.07	0	0
12	0	0	IA	IA	IA	0	0	0.01	0	0.06	0	0
13	0.09	0	IA	IA	IA	0	0.02	0.01	0.07	0.02	0	0
14	0	IA	IA	IA	IA	0.15	0.02S	0.01	0	0.63	0	0
15	0.23S	IA	IA	IA	IA	0.18	0	0	0	0.9	0.03	0
16	0.07S	IA	IA	IA	IA	0.02	0	0	0	0.04	0	0
17	0	IA	IA	IA	IA	0	0	0	0	0.05	0	0
18	0	IA	IA	IA	IA	0	0	0	0	0	0	0
19	0	IA	IA	IA	IA	0	0.08	0	0	0.36	0	0
20	0	IA	IA	IA	IA	0	0.01	0	0	0.07	0	0
21	0	IA	IA	IA	IA	0	0	0	0.39	0	0.02	0
22	0	IA	IA	IA	IA	0	0	0.33	0	0.01	0.09	0.06
23	0	IA	IA	IA	IA	0	0	0.31	0	0.01	0	0
24	0.28	IA	IA	IA	IA	0	0	0.23	0	0	0	0
25	0.02	IA	IA	IA	IA	0.02	0	0.05	0.03	0	0	0
26	0	IA	IA	IA	IA	0.02	0	0	0	0.1	0.6	0
27	0	IA	IA	IA	IA	0	0	0	0	0.59	0	0
28	0	IA	IA	IA	IA	0	0	0	0	0.17	0	0
29	0.01S	IA	IA	IA		0	0	0.02	0	0.2	0	0.28
30	0.01S	IA	IA	IA		0	0	0	0	0.04	0	0
31	0.11		IA	IA		0		0		0.81	0	

^a IA represents inactive gage during seasonal shutdown.

^b S represents precipitation as snow.

Monthly Total Precipitation (in.) for E245.5, October 2013–October 2014

	Oct	Nov	Dec	Jan	Feb	Mar	Apr	May	Jun	Jul	Aug	Sep
Total (in.)	0.93	0.12	IA ^a	IA	IA	0.39 ^b	0.26	0.97	0.88	5.42	1.92	0.48
Mean Total for Period of Record (in.)	0.90	0.22	IA	IA	IA	IA	0.64	0.63	0.59	2.40	1.83	2.29
Max Daily Total (in.)	0.28	0.07	IA	IA	IA	0.18	0.08	0.33	0.39	0.90	0.60	0.28
Missing Days	0	18	31	31	28	10	0	0	0	0	0	0

^a IA represents inactive gage during seasonal shutdown.

^b Partial month because of inactivity, maintenance, or equipment failure.

Surface Water Data, Water Year 2014

E253 Cañon de Valle above SR 501

Location. Lat 35° 51' 6", long -106° 21' 17", NE ¼, Sec. 25, T. 19 N., R. 5 E., Los Alamos County in Santa Fe National Forest.

Period of Record. October 10, 2007, to September, 2014.

Gage. Elevation of gage is 7719 ft using LANL LIDAR DEM with NAD 83.

Maximum Daily Total Precipitation for Period of Record. 2.59 in. on September 13, 2013.

Maximum Daily Total Precipitation for Monsoon Season. 1.06 in. on July 19, 2014.

Equipment. The station is equipped with a Rain Collection II tipping bucket rain gage. The equipment is powered with a solar-panel battery-charging system.

Fieldwork. The station was visited 18 times to perform inspections and 5 times to conduct maintenance.

Precipitation record. The precipitation gage gave a complete and satisfactory record, except for November 8, 2013, to February 25, 2014, when the gage was shut down for winter.



E253 Precipitation gage

Surface Water Data, Water Year 2014

Daily Total Precipitation (in.) for E253

Day	Oct	Nov	Dec	Jan	Feb	Mar	Apr	May	Jun	Jul	Aug	Sep
1	0	0	IA ^a	IA	IA	IA	0	0	0	0	0.28	0
2	0	0	IA	IA	IA	IA	0	0	0	0	0	0
3	0	0	IA	IA	IA	IA	0.02	0	0	0.02	0	0
4	0	0.5	IA	IA	IA	IA	0	0	0	0.03	0.2	0.04
5	0	0.02	IA	IA	IA	IA	0	0	0	0.01	0.03	0.05
6	0	0	IA	IA	IA	IA	0.01	0	0	0	0	0
7	0	0	IA	IA	IA	IA	0	0	0.32	0.22	0	0
8	0	IA	IA	IA	IA	IA	0	0	0	0.53	0.03	0
9	0	IA	IA	IA	IA	IA	0	0	0	0.05	0	0
10	0.39	IA	IA	IA	IA	IA	0	0	0	0.22	0.02	0
11	0.01	IA	IA	IA	IA	IA	0	0	0	0.03	0	0
12	0	IA	IA	IA	IA	IA	0	0.03	0	0	0	0
13	0.1	IA	IA	IA	IA	IA	0.14	0.03	0.08	0.02	0.02	0
14	0	IA	IA	IA	IA	0.08	0.02	0	0	0.77	0	0
15	0.04S ^b	IA	IA	IA	IA	0.31	0	0	0	0.46	0.03	0
16	0.42S	IA	IA	IA	IA	0	0	0	0	0.06	0	0
17	0	IA	IA	IA	IA	0	0	0	0.04	0	0	0
18	0	IA	IA	IA	IA	0	0	0	0	0	0	0
19	0	IA	IA	IA	IA	0	0.05	0	0	1.06	0	0
20	0	IA	IA	IA	IA	0	0.01	0	0	0.07	0	0
21	0	IA	IA	IA	IA	0	0	0	0.2	0.01	0	0
22	0	IA	IA	IA	IA	0	0	0.2	0	0	0.18	0.07
23	0	IA	IA	IA	IA	0	0	0.24	0	0	0	0
24	0.36	IA	IA	IA	IA	0	0	0.28	0	0	0	0
25	0.02	IA	IA	IA	IA	0.05	0	0.14	0	0	0	0
26	0	IA	IA	IA	IA	0.01	0.02	0.02	0	0.01	0.06	0
27	0	IA	IA	IA	IA	0.03	0.09	0	0	0.32	0	0
28	0	IA	IA	IA	IA	0	0	0	0	0.17	0	0.04
29	0.03S	IA	IA	IA		0	0	0	0	0.28	0	0.13
30	0.01S	IA	IA	IA		0	0	0	0	0.35	0	0
31	0.04		IA	IA		0		0		0.66	0	

^a IA represents inactive gage during seasonal shutdown.

^b S represents precipitation as snow.

Monthly Total Precipitation (in.) for E253, October 2013–September 2014

	Oct	Nov	Dec	Jan	Feb	Mar	Apr	May	Jun	Jul	Aug	Sep
Total (in.)	1.42	0.52	IA ^a	IA	IA	0.48 ^b	0.36	0.94	0.64	5.35	0.85	0.33
Mean Total for Period of Record (in.)	2.03	0.52	IA	IA	IA	IA	0.75	0.92	1.21	5.41	6.26	1.75
Max Daily Total (in.)	0.42	0.5	IA	IA	0	0.31	0.14	0.28	0.32	1.06	0.28	0.13
Missing Days	0	23	31	31	25	0	0	0	0	0	0	0

^a IA represents inactive gage during seasonal shutdown.

^b Partial month because of inactivity, maintenance, or equipment failure.

Surface Water Data, Water Year 2014

E257 Cañon de Valle Tributary at TA-16 Burn Grounds

Location. Lat 35° 50' 47", long -106° 19' 50", Sec. 29, T. 19 N., R. 6 E., Ramon Vigil Land Grant, Los Alamos County.

Period of Record. April 27, 2007, to September 30, 2014.

Gage. Elevation of gage is 7360 ft using LANL LIDAR DEM with NAD 83.

Maximum Daily Total Precipitation for Period of Record. 2.63 in. on September 13, 2013.

Maximum Daily Total Precipitation for Monsoon Season. 1.8 in. on July 8, 2014.

Equipment. The station is equipped with a Rain Collection II tipping bucket rain gage. The equipment is powered with a solar-panel battery-charging system.

Fieldwork. The station was visited 6 times to perform inspections and 2 times to conduct maintenance.

Precipitation Record. The precipitation gage gave a complete and satisfactory record, except for November 26, 2013, to March 13, 2014, when the gage was shut down for winter.



E257 Precipitation gage

Surface Water Data, Water Year 2014

Daily Total Precipitation (in.) for E257

Day	Oct	Nov	Dec	Jan	Feb	Mar	Apr	May	Jun	Jul	Aug	Sep
1	0	0	IA	IA	IA	IA	0	0	0	0	0.21	0
2	0	0	IA	IA	IA	IA	0	0	0	0	0	0
3	0	0	IA	IA	IA	IA	0	0	0	0.02	0	0
4	0	0.6	IA	IA	IA	IA	0	0	0	0.02	0.63	0.01
5	0	0.04	IA	IA	IA	IA	0.05S	0	0	0	0.13	0.11
6	0	0	IA	IA	IA	IA	0.04S	0	0	0	0	0
7	0	0	IA	IA	IA	IA	0	0	0.37	0.6	0	0
8	0	0	IA	IA	IA	IA	0	0	0	1.8	0.01	0
9	0	0	IA	IA	IA	IA	0	0	0	0.06	0	0
10	0.32	0	IA	IA	IA	IA	0	0	0	0.02	0.09	0.01
11	0.01	0	IA	IA	IA	IA	0	0	0	0.02	0	0
12	0	0	IA	IA	IA	IA	0	0.01	0	0	0	0
13	0.11	0	IA	IA	IA	IA	0.07	0.01	0.07	0.01	0.04	0
14	0	0	IA	IA	IA	0.16	0.02S	0	0	0.64	0.01	0
15	0.08S ^a	0.29	IA	IA	IA	0.2	0	0	0	0.4	0.11	0
16	0.32S	0.03	IA	IA	IA	0	0	0	0	0.02	0	0
17	0.01	0	IA	IA	IA	0	0	0	0.05	0	0	0
18	0	0	IA	IA	IA	0	0	0	0	0	0	0
19	0	0	IA	IA	IA	0	0.07	0	0	0.82	0	0
20	0	0.02	IA	IA	IA	0	0.01	0	0	0.07	0	0
21	0	0.32	IA	IA	IA	0	0	0	0.22	0.03	0	0
22	0	0	IA	IA	IA	0	0	0.3	0	0	0.13	0.05
23	0	0	IA	IA	IA	0	0	0.36	0	0	0	0.01
24	0.35	0	IA	IA	IA	0	0	0.26	0	0	0	0
25	0.02	0.16S	IA	IA	IA	0.04S	0	0.06	0	0	0	0
26	0	IA ^b	IA	IA	IA	0.01S	0.01	0	0	0	0.1	0
27	0	IA	IA	IA	IA	0.01S	0.08	0	0	0.38	0	0
28	0	IA	IA	IA	IA	0	0	0	0	0.16	0	0.01
29	0.03S	IA	IA	IA		0	0	0	0	0.3	0	0.09
30	0.04S	IA	IA	IA		0	0	0	0	0.18	0	0
31	0.01S		IA	IA		0		0		1.1	0	

^a IA represents inactive gage during seasonal shutdown.

^b S represents precipitation as snow.

Monthly Total Precipitation (in.) for E257, October 2013–September 2014

	Oct	Nov	Dec	Jan	Feb	Mar	Apr	May	Jun	Jul	Aug	Sep
Total (in.)	1.29	1.46 ^a	IA ^b	IA	IA	0.42	0.35	1.0	0.71	6.65	1.46	0.29
Mean Total for Period of Record (in.)	1.54	0.32	IA	IA	IA	IA	1.01	0.92	0.73	3.86	3.11	2.82
Max Daily Total (in.)	0.32	0.32	IA	IA	IA	0.20	0.08	0.36	0.37	1.8	0.63	0.11
Missing Days	0	5	31	31	28	13	0	0	0	0	0	0

^a Partial month because of inactivity, maintenance, or equipment failure.

^b IA represents inactive gage during seasonal shutdown.

Surface Water Data, Water Year 2014

E262.4 PHERMEX

Location. Lat 35° 49' 57", long -106° 17' 47", Sec. 34, T. 19 N., R. 6 E., Ramon Vigil Land Grant, Los Alamos County.

Period of Record. August 8, 2004, to September, 2014.

Gage. Elevation of gage is 7124 ft using LANL LIDAR DEM with NAD 83.

Maximum Daily Total Precipitation for Period of Record. 2.27 in. on September 13, 2013.

Maximum Daily Total Precipitation for Monsoon Season. 1.09 in. on July 8, 2014.

Equipment. The station is equipped with a Rain Collection II tipping bucket rain gage. The equipment is powered with a solar-panel battery-charging system.

Fieldwork. The station was visited 7 times to perform inspections and 3 times to conduct maintenance.

Precipitation Record. The precipitation gage gave a complete and satisfactory record, except for November 26, 2013, to March 14, 2014, when the gage was shut down for winter.



E262.4 Precipitation gage

Surface Water Data, Water Year 2014

Daily Total Precipitation (in.) for E262.4

Day	Oct	Nov	Dec	Jan	Feb	Mar	Apr	May	Jun	Jul	Aug	Sep
1	0	0	IA ^a	IA	IA	IA	0	0	0	0.02	0.28	0
2	0	0	IA	IA	IA	IA	0	0	0	0.12	0	0
3	0	0	IA	IA	IA	IA	0	0	0	0	0.02	0
4	0	0.71	IA	IA	IA	IA	0	0	0	0	0.87	0
5	0	0.01	IA	IA	IA	IA	0.03S ^b	0	0	0	0.3	0.32
6	0	0	IA	IA	IA	IA	0.02S	0	0	0	0	0
7	0	0	IA	IA	IA	IA	0	0	0.45	0.22	0	0
8	0	0	IA	IA	IA	IA	0	0	0	1.09	0	0.01
9	0.02H ^c	0	IA	IA	IA	IA	0	0	0	0.05	0	0
10	0.28	0	IA	IA	IA	IA	0	0	0	0	0.25	0
11	0	0	IA	IA	IA	IA	0	0	0	0.07	0	0
12	0	0	IA	IA	IA	IA	0	0.01	0	0	0	0
13	0.1H	0.01	IA	IA	IA	IA	0.03	0.02	0.18	0.02	0	0
14	0	0	IA	IA	IA	0.19	0.01S	0	0	0.76	0	0
15	0.25S	0.24	IA	IA	IA	0.03	0	0	0	0.74	0.05	0
16	0.13S	0.02	IA	IA	IA	0	0	0	0	0	0	0
17	0	0	IA	IA	IA	0	0	0	0.01	0	0	0
18	0	0	IA	IA	IA	0	0	0	0.01	0	0	0
19	0	0	IA	IA	IA	0	0.08	0	0	0.59	0	0
20	0	0.03S	IA	IA	IA	0	0	0	0	0.04	0	0
21	0	0.43	IA	IA	IA	0	0.02	0	0.68	0	0.01	0
22	0	0	IA	IA	IA	0	0	0.24	0	0	0.12	0.11
23	0	0	IA	IA	IA	0	0	0.55	0	0.04	0	0
24	0.4	0.02S	IA	IA	IA	0	0	0.29	0	0	0	0
25	0.02	0.52S	IA	IA	IA	0.03S	0	0.04	0	0	0	0
26	0	IA	IA	IA	IA	0.01S	0	0	0	0.01	0.69	0.01
27	0	IA	IA	IA	IA	0	0	0	0	0.6	0	0
28	0	IA	IA	IA	IA	0	0	0	0	0.24	0	0
29	0.02S	IA	IA	IA		0	0	0	0	0.7	0	0.28
30	0.02S	IA	IA	IA		0	0	0	0	0.13	0	0.01
31	0.01		IA	IA		0		0		0.95	0	

^a IA represents inactive gage during seasonal shutdown.

^b S represents precipitation as snow.

^c H represents precipitation as hail.

Monthly Total Precipitation (in.) for E262.4, October 2013–September 2014

	Oct	Nov	Dec	Jan	Feb	Mar	Apr	May	Jun	Jul	Aug	Sep
Total (in.)	1.25	1.99	IA*	IA	IA	0.26	0.19	1.15	1.33	6.39	2.59	0.74
Mean Total for Period of Record (in.)	1.37	0.21	IA	IA	IA	IA	0.74	0.78	0.45	3.53	1.97	2.43
Max Daily Total (in.)	0.28	0.71	IA	IA	0.19	IA	0.08	0.55	0.68	1.09	0.87	0.32
Missing Days	0	5	31	31	28	13	0	0	0	0	0	0

* IA represents inactive gage during seasonal shutdown.

Surface Water Data, Water Year 2014

E265 Water Canyon below SR 4

Location. Lat 35° 48' 18", long -106° 14' 31" Sec. 7, T. 18 N., R. 7 E., Ramon Vigil Land Grant, Los Alamos County.

Period of Record. May 15, 2007, to September 30, 2014.

Gage. Elevation of gage is 6311 ft using LANL LIDAR DEM with NAD 83.

Maximum Daily Total Precipitation for Period of Record. 3.08 in. on September 12, 2013.

Maximum Daily Total Precipitation for Monsoon Season. 0.95 in. on July 8, 2014.

Equipment. The station is equipped with a Rain Collection II tipping bucket rain gage. The equipment is powered with a solar-panel battery-charging system.

Fieldwork. The station was visited 20 times to perform inspections and 8 times to conduct maintenance.

Precipitation Record. The precipitation gage gave a complete and satisfactory record, except for November 19, 2013, to March 10, 2014, when the gage was shut down for winter.



E265 Precipitation gage

Surface Water Data, Water Year 2014

Daily Total Precipitation (in.) for E265

Day	Oct	Nov	Dec	Jan	Feb	Mar	Apr	May	Jun	Jul	Aug	Sep
1	0	0	IA ^a	IA	IA	IA	0	0	0	0.14	0.11	0
2	0	0	IA	IA	IA	IA	0	0	0	0.4	0	0
3	0	0	IA	IA	IA	IA	0	0	0	0	0	0
4	0	0.85	IA	IA	IA	IA	0	0	0	0	0.21	0
5	0	0	IA	IA	IA	IA	0.01	0	0	0	0.26	0.21
6	0	0.01	IA	IA	IA	IA	0.02S ^b	0	0	0.04	0	0
7	0	0	IA	IA	IA	IA	0.01S	0	0.43	0	0	0
8	0	0	IA	IA	IA	IA	0	0	0.04	0.95	0	0.01
9	0	0	IA	IA	IA	IA	0	0	0	0.01	0	0
10	0.25	0	IA	IA	IA	IA	0	0	0	0.01	0.11	0
11	0.01	0	IA	IA	IA	IA	0	0	0	0	0	0
12	0.01	0	IA	IA	IA	IA	0	0	0.02	0	0	0
13	0.03	0	IA	IA	IA	IA	0	0	0.35	0	0.02	0
14	0	0	IA	IA	IA	0.05	0	0.02	0	0.51	0	0
15	0.22S	0.26	IA	IA	IA	0.05	0	0	0	0.3	0.02	0
16	0.01S	0.05	IA	IA	IA	0	0	0	0	0.01	0	0
17	0	0	IA	IA	IA	0	0	0	0.11	0.01	0	0
18	0	0	IA	IA	IA	0	0	0	0	0	0	0
19	0	IA	IA	IA	IA	0	0.16	0	0	0.45	0	0
20	0	IA	IA	IA	IA	0	0	0	0	0.03	0	0
21	0	IA	IA	IA	IA	0	0	0	0.17	0	0.03	0
22	0	IA	IA	IA	IA	0	0	0.51	0	0	0.09	0.09
23	0	IA	IA	IA	IA	0	0	0.22	0.02	0.39	0	0
24	0.27	IA	IA	IA	IA	0	0	0.35	0	0	0	0
25	0.02	IA	IA	IA	IA	0.03S	0	0.06	0	0	0	0
26	0	IA	IA	IA	IA	0	0	0	0	0.01	0.3	0
27	0	IA	IA	IA	IA	0	0.01S	0	0	0.06	0	0
28	0	IA	IA	IA	IA	0	0	0	0	0.09	0	0
29	0	IA	IA	IA		0	0	0	0	0.61	0	0.24
30	0.03S	IA	IA	IA		0	0	0	0	0.03	0	0
31	0.01		IA	IA		0		0		0.41	0	

^a IA represents inactive gage during seasonal shutdown.

^b S represents precipitation as snow.

Monthly Total Precipitation (in.) for E265, October 2013–October 2014

	Oct	Nov	Dec	Jan	Feb	Mar	Apr	May	Jun	Jul	Aug	Sep
Total (in.)	0.86	1.17 ^a	IA ^b	IA	IA	0.13	0.21	1.18	1.12	4.46	1.15	0.55
Mean Total for Period of Record (in.)	1.08	0.33	IA	IA	IA	IA	0.56	0.69	0.60	2.94	1.40	2.13
Max Daily Total (in.)	0.27	0.85	IA	IA	IA	0.05	0.16	0.51	0.43	0.95	0.26	0.24
Missing Days	0	12	31	31	28	10	0	0	0	0	0	0

^a Partial month because of inactivity, maintenance, or equipment failure.

^b IA represents inactive gage during seasonal shutdown.

Surface Water Data, Water Year 2014

E267.4 TA-36 Minie Site

Location. Lat 35° 49' 38", long -106° 16' 36", Sec. 35, T. 19 N., R. 6 E., Ramon Vigil Land Grant, Santa Fe National Forest.

Period of Record. July 13, 2007, to September 30, 2014.

Gage. Elevation of gage is 6865 ft using LANL LIDAR DEM with NAD 83.

Maximum Daily Total Precipitation for Period of Record. 2.13 in. on September 12, 2013.

Maximum Daily Total Precipitation for Monsoon Season. 0.89 in. on July 15, 2014.

Equipment. The station is equipped with a Rain Collection II tipping bucket rain gage. The equipment is powered with a solar-panel battery-charging system.

Fieldwork. The station was visited 7 times to perform inspections and 5 times to conduct maintenance.

Precipitation Record. The precipitation gage gave a complete and satisfactory record, except for November 26, 2013, to March 13, 2014, when the gage was shut down for winter.



E267.4 Precipitation gage

Surface Water Data, Water Year 2014

Daily Total Precipitation (in.) for E267.4

Day	Oct	Nov	Dec	Jan	Feb	Mar	Apr	May	Jun	Jul	Aug	Sep
1	0	0	IA ^a	IA	IA	IA	0	0	0	0.02	0.15	0
2	0	0	IA	IA	IA	IA	0	0	0	0.34	0.01	0
3	0	0	IA	IA	IA	IA	0	0	0	0	0	0
4	0	0.93	IA	IA	IA	IA	0	0	0	0	0.35	0
5	0	0.01	IA	IA	IA	IA	0	0	0	0	0.22	0.15
6	0	0	IA	IA	IA	IA	0.03S ^b	0	0	0	0	0
7	0	0	IA	IA	IA	IA	0	0	0.26	0.33	0	0
8	0	0	IA	IA	IA	IA	0	0	0.02	0.85	0	0.01
9	0.01	0	IA	IA	IA	IA	0	0	0	0.03	0	0
10	0.25	0	IA	IA	IA	IA	0	0	0	0	0.22	0
11	0	0	IA	IA	IA	IA	0	0	0	0.02	0	0
12	0	0	IA	IA	IA	IA	0	0.01	0	0	0	0
13	0.07	0.01	IA	IA	IA	IA	0.01	0	0	0.01	0.01	0
14	0	0	IA	IA	IA	0.11	0.02S	0	0	0.75	0	0
15	0.25S	0.23	IA	IA	IA	0.19	0	0	0	0.89	0.02	0
16	0.07S	0.02	IA	IA	IA	0	0	0	0	0	0	0
17	0	0	IA	IA	IA	IA	0	0	0	0.02	0	0
18	0	0	IA	IA	IA	IA	0	0	0	0	0	0
19	0	0	IA	IA	IA	IA	0	0.1	0	0	0.48	0
20	0	0.03S	IA	IA	IA	IA	0	0	0	0.03	0	0
21	0	0.34	IA	IA	IA	IA	0	0	0	0.51	0	0.02
22	0	0	IA	IA	IA	IA	0	0	0.3	0	0	0.1
23	0	0	IA	IA	IA	IA	0	0	0.33	0	0.09	0
24	0.29	0.03S	IA	IA	IA	IA	0	0	0.27	0	0	0
25	0.02	0.42S	IA	IA	IA	IA	0.04	0	0.05	0	0	0
26	0	IA	IA	IA	IA	IA	0	0	0	0	0.05	0.58
27	0	IA	IA	IA	IA	IA	0	0	0	0	0.38	0.01
28	0	IA	IA	IA	IA	IA	0	0	0	0	0.15	0
29	0.01S	IA	IA	IA	IA	IA	0	0	0.01	0	0.42	0
30	0.03S	IA	IA	IA	IA	IA	0	0	0	0	0.1	0
31	0	IA	IA	IA	IA	IA	0	0	0	0.64	0	IA

^a IA represents inactive gage during seasonal shutdown.

^b S represents precipitation as snow.

Monthly Total Precipitation (in.) for E267.4, October 2013–October 2014

	Oct	Nov	Dec	Jan	Feb	Mar	Apr	May	Jun	Jul	Aug	Sep
Total (in.)	1	2.02 ^a	IA ^b	IA	IA	0.34	0.16	0.97	0.79	5.6	1.69	0.53
Mean Total for Period of Record (in.)	1.21	0.22	IA	IA	IA	IA	0.65	0.68	0.55	2.56	1.59	2.33
Max Daily Total (in.)	0.29	0.93	IA	IA	IA	13	0.03S ^c	0.33	0.51	0.89	0.58	0.29
Missing Days	0	5	31	31	28	0.19	0	0	0	0	0	0

^a Partial month because of inactivity, maintenance, or equipment failure.

^b IA represents inactive gage during seasonal shutdown.

^c S represents precipitation as snow.

Surface Water Data, Water Year 2014

E340 Chaquehui Tributary at TA-33

Location. Lat 35° 46' 46", long -106° 15' 1", Sec. 19, T. 18 N., R. 7 E., Ramon Vigil Land Grant, Los Alamos County.

Period of Record. May 16, 2007, to September 30, 2014.

Gage. Elevation of gage is 6423 ft using LANL LIDAR DEM with NAD 83.

Maximum Daily Total Precipitation for Period of Record. 1.19 in. on July 19, 2007.

Maximum Daily Total Precipitation for Monsoon Season. 0.98 in. on July 23, 2014.

Equipment. The station is equipped with a Rain Collection II tipping bucket rain gage. Equipment is powered with a solar-panel battery-charging system.

Fieldwork. The station was visited 13 times to perform inspections and 4 times to conduct maintenance.

Precipitation Record. The precipitation gage gave a complete and satisfactory record, except for November 25, 2013, to March 11, 2014, when the gage was shut down for winter.



E340 Precipitation gage

Surface Water Data, Water Year 2014

Daily Total Precipitation (in.) for E340

Day	Oct	Nov	Dec	Jan	Feb	Mar	Apr	May	Jun	Jul	Aug	Sep
1	0	0	IA ^a	IA	IA	IA	0	0	0	0.08	0.09	0
2	0	0	IA	IA	IA	IA	0	0	0	0.31	0	0
3	0	0	IA	IA	IA	IA	0	0	0	0	0	0
4	0	0.82	IA	IA	IA	IA	0	0	0	0	0.3	0
5	0	0.01	IA	IA	IA	IA	0	0	0	0	0	0.46
6	0	0	IA	IA	IA	IA	0.01	0	0	0.03	0	0
7	0	0.01	IA	IA	IA	IA	0	0	0.16	0	0	0
8	0	0	IA	IA	IA	IA	0	0.01	0	0.65	0	0
9	0	0	IA	IA	IA	IA	0	0	0	0	0	0
10	0.19	0	IA	IA	IA	IA	0	0	0	0	0.07	0
11	0	0	IA	IA	IA	IA	0	0	0	0.01	0.02	0
12	0	0	IA	IA	IA	0	0	0.03	0	0.06	0	0
13	0.03	0.01	IA	IA	IA	0	0	0	0.18	0	0.04	0
14	0	0	IA	IA	IA	0.03	0	0.01	0	0.42	0	0
15	0.19S ^b	0.31	IA	IA	IA	0.04	0	0	0	0.27	0.11	0
16	0.01S	0.04	IA	IA	IA	0	0	0	0	0.03	0	0
17	0.01	0	IA	IA	IA	0	0	0	0.13	0	0	0
18	0	0.01	IA	IA	IA	0	0	0	0	0	0	0
19	0	0.01	IA	IA	IA	0	0.1	0	0	0.24	0	0
20	0	0.03	IA	IA	IA	0	0	0	0	0.04	0	0
21	0	0.34	IA	IA	IA	0	0	0	0.32	0	0.03	0
22	0	0	IA	IA	IA	0	0	0.38	0	0	0.09	0.29
23	0	0	IA	IA	IA	0	0	0.19	0	0.98	0	0.01
24	0.3	0.12	IA	IA	IA	0	0	0.33	0	0	0	0
25	0.02	IA	IA	IA	IA	0.03	0	0.04	0	0	0	0
26	0	IA	IA	IA	IA	0	0	0.01	0	0	0.28	0
27	0	IA	IA	IA	IA	0	0	0	0	0.04	0	0
28	0	IA	IA	IA	IA	0	0	0	0	0.09	0	0
29	0	IA	IA	IA		0	0	0	0	0.68	0	0.38
30	0.02S	IA	IA	IA		0	0	0	0	0.11	0	0
31	0		IA	IA		0		0		0.27	0	

^a IA represents inactive gage during seasonal shutdown.

^b S represents precipitation as snow.

Monthly Total Precipitation (in.) for E340, October 2013–September 2014

	Oct	Nov	Dec	Jan	Feb	Mar	Apr	May	Jun	Jul	Aug	Sep
Total (in.)	0.77	1.71 ^a	IA ^b	IA	IA	0.1 ^a	0.11	1	0.79	4.31	1.03	1.14
Mean Total for Period of Record (in.)	0.94	0.38	IA	IA	IA	IA	0.6	0.63	0.45	3.65	1.27	2.1
Max Daily Total (in.)	0.19	0.82	IA	IA	IA	0.04	0.01	0.38	0.32	0.98	0.28	0.46
Missing Days	0	6	31	31	28	11	0	0	0	0	0	0

^a Partial month because of inactivity, maintenance, or equipment failure.

^b IA represents inactive gage during seasonal shutdown.

Meteorological Tower Data

The meteorological network is a comprehensive system that measures temperature, wind, humidity, pressure, precipitation, insolation, and other meteorological variables required for DOE facilities. The collected data play a critical role in emergency planning in the event of chemical or radiological release, demonstrating regulatory compliance in the areas of air quality, water quality, and waste management as well as supporting monitoring programs in biology, hydrology, and health physics. Each station is named according to its location.

Precipitation gages from LANL's meteorological towers located throughout LANL collect 15-min precipitation data using heated tipping buckets. During snow precipitation events, the data are measured estimates of the amount of liquid precipitation from the total amount of snow. These data are commonly referred to as the snow-water equivalent. Monthly data are totaled from each meteorological tower to show monthly precipitation amounts. LANL meteorologists qualify the meteorological tower precipitation data. The data are either evaluated to be good or are replaced with a numerical code for missing data. Estimates are not made for missing data. Further documentation and precipitation information data can be found at <http://weather.lanl.gov>.

Figure 10 shows the total monthly precipitation at each of the five meteorological towers from October 2013 to September 2014.

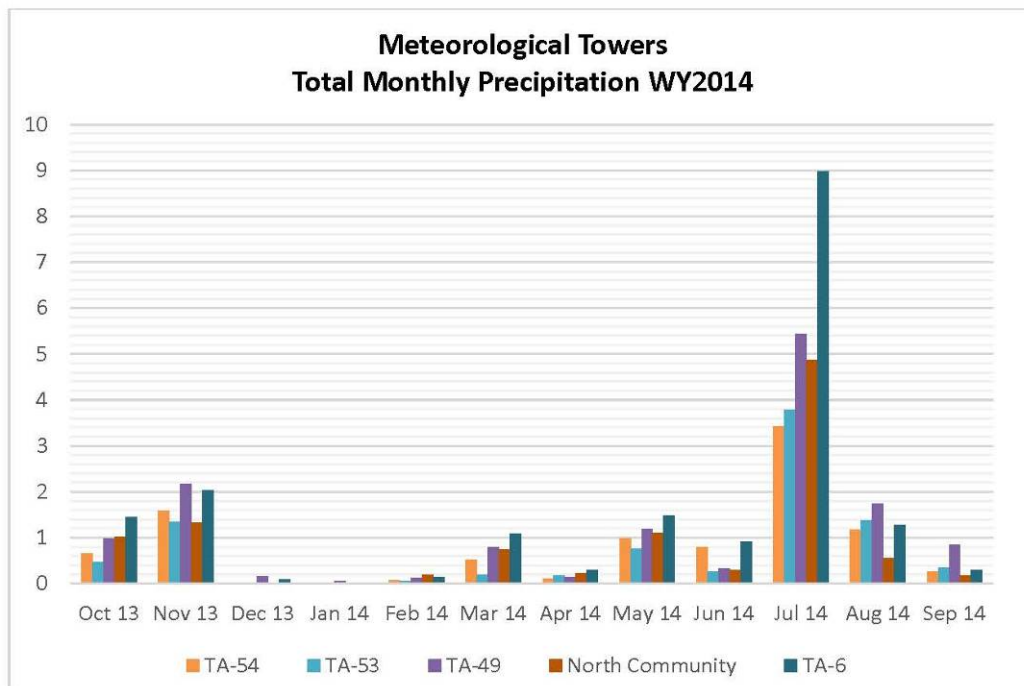

Note: The gages are listed in ascending order by elevation from TA-54 (6553 ft) to TA-06 (7427 ft).

Figure 10 The total monthly precipitation for the meteorological towers for WY2014

Surface Water Data, Water Year 2014

TA-06 Meteorological Tower

Location. Lat 35° 51' 41", long -106 19' 10.2102", NW ¼, Sec. 21, T. 19 N., R. 6 E., Los Alamos County.

Period of Record. February 1, 1990, to September 30, 2014.

Gage. Elevation of gage is 7423 ft using LANL LIDAR DEM with NAD 83.

Maximum Daily Total Precipitation for Period of Record. 2.92 in. on September 13, 2013.

Maximum Daily Total Precipitation for Monsoon Season. 2.0 in. on July 8, 2014.

Equipment. The precipitation gage consists of a heated tipping bucket with wind screen.

Precipitation Record. The precipitation gage gave a complete and satisfactory record, except for December 11, 12, 15, 16, 19, 21, 22, 25, and 27, 2013; January 1, 2, and 5, 2014; February 3, 2014; March 11 and 18, 2014; and July 11, 2014, when no data were collected because of equipment failure.



TA-06 Meteorological tower

Surface Water Data, Water Year 2014

Daily Total Precipitation (in.) for TA-06

Day	Oct	Nov	Dec	Jan	Feb	Mar	Apr	May	Jun	Jul	Aug	Sep
1	0	0	0	E*	0	0.65	0	0	0	0	0.22	0
2	0	0	0	E	0	0.04	0	0	0	0	0	0
3	0	0	0	0	E	0	0	0	0	0.01	0	0
4	0	0.7	0	0	0.02	0	0	0	0	0.02	0.53	0.01
5	0	0.01	0.01	E	0	0	0.04	0	0	0	0.07	0.07
6	0	0	0	0	0	0	0.03	0	0	0	0	0
7	0	0	0.06	0	0	0	0	0	0.4	1.46	0	0
8	0	0	0.01	0	0	0	0	0	0	2	0	0
9	0	0	0	0	0	0	0	0	0	0.03	0.01	0
10	0.36	0	0	0	0	0	0	0	0	0.04	0.02	0
11	0	0	E	0	0	E	0	0	0	E	0	0
12	0	0	E	0	0	0	0	0.01	0	0.01	0	0
13	0.13	0	0	0	0	0	0.09	0	0.09	0.01	0.02	0
14	0.01	0	0	0	0	0.31	0.02	0	0	0.86	0	0
15	0.12	0.19	E	0	0	0.03	0	0	0	0.68	0.16	0
16	0.33	0	E	0	0	0	0	0	0	0.09	0	0
17	0	0	0	0	0	0	0	0	0.02	0.01	0	0
18	0	0	0	0	0	E	0	0	0	0	0	0
19	0	0	E	0	0	0	0.04	0	0	0.9	0	0
20	0	0	0	0	0	0	0	0	0	0.03	0	0
21	0	0.91	E	0	0	0	0	0	0.4	0.05	0	0
22	0	0	E	0	0	0	0	0.37	0	0	0.14	0.08
23	0	0.18	0	0	0	0	0	0.45	0	0	0	0
24	0.4	0.04	0	0	0	0	0	0.29	0	0	0	0
25	0.01	0	E	0	0	0.03	0	0.35	0	0	0	0
26	0	0	0	0	0	0.02	0.06	0.01	0	0.04	0.11	0
27	0	0	E	0	0.12	0	0.02	0	0	0.72	0	0
28	0	0	0	0	0	0	0	0	0	0.18	0	0.01
29	0.03	0	0	0		0	0	0	0	0.58	0	0.13
30	0.05	0	0	0		0	0	0	0	0.08	0	0
31	0		0	0.02		0		0		1.17	0	

* E represents equipment failure.

Monthly Total Precipitation (in.) for TA-06, October 2013–September 2014

	Oct	Nov	Dec	Jan	Feb	Mar	Apr	May	Jun	Jul	Aug	Sep
Total (in.)	1.44	2.03	0.08*	0.02	0.14*	1.08	0.30	1.48	0.91	8.97*	1.28	0.3
Mean Total for Period of Record (in.)	1.59	0.84	0.89	0.87	0.78	0.92	0.96	1.15	1.12	2.69	3.33	2.07
Max Daily Total (in.)	0.36	0.91	0.06	0.02	0.12	0.65	0.09	0.45	0.09	1.46	0.53	0.13
Missing Days	0	0	9	3	1	2	0	0	0	1	0	0

*Partial month because of inactivity, maintenance, or equipment failure.

Surface Water Data, Water Year 2014

TA-49 Meteorological Tower

Location. Lat 35° 48' 48", long -10617' 57.483", T. 18 N., R. 6 E., Ramon Vigil Land Grant.

Period of Record. June 24, 1987, to September 30, 2014.

Gage. Elevation of gage is 7045 ft using LANL LIDAR DEM with NAD 83.

Maximum Daily Total Precipitation for Period of Record. 3.68 in. on February 27, 1988.

Maximum Daily Total Precipitation for Monsoon Season. 0.79 in. on July 29, 2014.

Equipment. The precipitation gage consists of a heated tipping bucket with wind screen.

Precipitation Record. The precipitation gage gave a complete and satisfactory record, except for February 24–26, 2014; April 18, 2014; and September 13 and 21, 2014, when no data were collected because of equipment failure.



TA-49 Precipitation gage

Surface Water Data, Water Year 2014

Daily Total Precipitation (in.) for TA-49

Day	Oct	Nov	Dec	Jan	Feb	Mar	Apr	May	Jun	Jul	Aug	Sep
1	0	0	0	0	0	0.59	0	0	0	0	0.2	0
2	0	0	0	0	0	0.04	0	0	0	0.3	0	0
3	0	0	0	0	0.07	0	0	0	0	0.01	0	0
4	0	0.64	0.01	0	0	0	0	0	0	0	0.35	0
5	0	0.01	0.01	0	0	0	0	0	0	0	0.07	0.39
6	0	0	0	0	0	0	0	0	0	0	0	0
7	0	0	0.04	0	0	0	0	0	0.22	0.03	0	0
8	0	0	0.02	0	0	0	0	0	0	0.77	0	0
9	0	0	0	0	0	0	0	0	0	0.03	0	0
10	0.24	0	0	0	0	0	0	0	0	0	0.24	0.03
11	0	0	0	0	0	0	0	0	0	0.04	0	0
12	0	0	0	0	0	0	0	0.01	0	0	0	0
13	0.05	0	0	0	0	0	0.01	0	0.32	0	0	E*
14	0	0	0	0	0	0.12	0.01	0	0	0.59	0	0
15	0.33	0.25	0	0	0	0.02	0	0	0	0.51	0	0
16	0	0.03	0	0	0	0	0	0	0	0.02	0	0
17	0	0	0	0	0	0	0	0	0.03	0	0	0
18	0	0	0	0	0	0	E	0	0	0	0	0
19	0	0	0	0	0	0	0.06	0	0	0.6	0	0
20	0	0.02	0	0	0	0	0	0	0	0.01	0	0
21	0	0.92	0.04	0	0	0	0	0	0.59	0	0	E
22	0	0.01	0.03	0	0	0	0	0.25	0	0	0.11	0.14
23	0	0.23	0	0	0	0	0	0.6	0	0.11	0	0
24	0.3	0.05	0	0	E	0	0	0.3	0	0	0	0
25	0.03	0	0	0	E	0.02	0	0.03	0	0	0	0
26	0	0	0	0	E	0.01	0.03	0	0	0	0.77	0
27	0	0	0	0	0.05	0	0.01	0	0	0.69	0	0
28	0	0	0	0	0	0	0	0	0	0.18	0	0
29	0.01	0	0	0		0	0.01	0	0	0.79	0	0.29
30	0.02	0	0	0		0	0	0	0	0.21	0	0
31	0		0	0.06		0		0		0.54	0	

* E represents equipment failure.

Monthly Total Precipitation (in.) for TA-49, October 2013–September 2014

	Oct	Nov	Dec	Jan	Feb	Mar	Apr	May	Jun	Jul	Aug	Sep
Total (in.)	0.98	2.16	0.15	0.06	0.12	0.80	0.13	1.19	1.16	5.43	1.74	0.85
Mean Total for Period of Record (in.)	1.55	0.86	0.83	0.88	0.76	0.88	0.87	1.03	0.93	2.27	2.84	1.97
Max Daily Total (in.)	0.33	0.92	0.04	0.06	0.07	0.59	0.06	0.25	0.59	0.79	0.77	0.39
Missing Days	0	0	0	0	3	0	1	0	0	0	0	2

Surface Water Data, Water Year 2014

TA-53 Meteorological Tower

Location. Lat 35° 52' 12", long -106° 15' 15", NW ¼, Sec. 24, T. 19 N., R. 6 E., Los Alamos County.

Period of Record. February 8, 1992, to September 30, 2014.

Gage. Elevation of gage is 6992 ft using LANL LIDAR DEM with NAD 83.

Maximum Daily Total Precipitation for Period of Record. 2.01 in. on September 12, 2013.

Maximum Daily Total Precipitation for Monsoon Season. 0.96 in. on July 31, 2014.

Equipment. The precipitation gage consists of a heated tipping bucket with wind screen.

Precipitation Record. The precipitation gage gave a complete and satisfactory record, except for September 21, 2014, when no data were collected because of equipment failure.



TA-53 Precipitation gage (foreground) and meteorological tower (background)

Surface Water Data, Water Year 2014

Daily Total Precipitation (in.) for TA-53

Day	Oct	Nov	Dec	Jan	Feb	Mar	Apr	May	Jun	Jul	Aug	Sep
1	0	0	0	0	0	0.18	0	0	0	0	0.16	0
2	0	0	0	0	0	0	0	0	0	0.27	0	0
3	0	0	0	0	0.01	0	0	0	0	0	0	0
4	0	0.87	0	0	0	0	0	0	0	0	0.22	0
5	0	0	0	0	0	0	0.08	0	0	0	0.1	0.2
6	0	0	0	0	0	0	0.08	0	0	0	0	0
7	0	0	0	0	0	0	0	0	0.13	0	0	0
8	0	0	0.01	0	0	0	0	0	0	0.72	0	0
9	0.01	0	0	0	0	0	0	0	0	0	0	0
10	0.14	0	0	0	0	0	0	0	0	0	0.48	0
11	0	0	0	0	0	0	0	0	0	0	0	0
12	0	0	0	0	0	0	0	0	0	0	0	0
13	0.06	0	0	0	0	0	0	0	0.02	0	0	0
14	0	0	0	0	0	0.01	0.01	0	0	0.57	0	0
15	0.08	0.03	0	0	0	0	0	0	0	0.84	0	0
16	0	0	0	0	0	0	0	0	0	0.08	0	0
17	0	0	0	0	0	0	0	0	0	0	0	0
18	0	0	0	0	0	0	0	0	0	0.01	0	0
19	0	0	0	0	0	0	0	0	0	0.07	0	0
20	0	0	0	0	0	0	0	0	0	0.05	0	0
21	0	0.37	0	0	0	0	0	0	0.1	0.06	0.01	E*
22	0	0	0	0	0	0	0	0.42	0	0	0.01	0
23	0	0.07	0	0	0	0	0	0.22	0	0	0	0
24	0.17	0	0	0	0	0	0	0.1	0	0	0	0
25	0	0	0	0	0	0	0	0	0	0	0	0
26	0	0	0	0	0	0	0	0	0	0	0.4	0
27	0	0	0	0	0.04	0	0	0	0	0.09	0	0
28	0	0	0	0	0	0	0	0	0	0.03	0	0
29	0	0	0	0		0	0	0.02	0	0.03	0	0.15
30	0	0	0	0		0	0	0	0	0	0	0
31	0		0	0		0		0		0.96	0	

* E represents equipment failure.

Monthly Total Precipitation (in.) for TA-53, October 2013–September 2014

	Oct	Nov	Dec	Jan	Feb	Mar	Apr	May	Jun	Jul	Aug	Sep
Total (in.)	0.46	1.34	0.01	0.00	0.05	0.19	0.17	0.76	0.25	3.78	1.38	0.35
Mean Total for Period of Record (in.)	1.33	0.66	0.71	0.73	0.65	0.78	0.82	1.00	0.82	1.85	2.49	1.59
Max Daily Total (in.)	0.17	0.87	0.01	0	0	0.158	0.08	0.42	0.13	0.96	0.48	0.20
Missing Days	0	0	0	0	0	0	0	0	0	0	0	1

Surface Water Data, Water Year 2014

TA-54 White Rock Meteorological Tower

Location. Lat 35° 49' 33", long -106° 13' 24", T. 18 N., R. 7 E., Ramon Vigil Land Grant.

Period of Record. January 29, 1992, to September 30, 2014.

Gage. Elevation of gage is 6553 ft using LANL LIDAR DEM with NAD 83.

Maximum Daily Total Precipitation for Period of Record. 3.28 in. on September 12, 2013.

Maximum Daily Total Precipitation for Monsoon Season. 1.46 in. on July 8, 2014.

Equipment. The precipitation gage consists of a heated tipping bucket with wind screen.

Precipitation Record. The precipitation gage gave a complete and satisfactory record, except for October 30, 2013; November 5, 6, 8–10, 22, 24, 26, 29, and 30, 2013; December 2–31, 2014; January 1–6 and 8, 2014; March 7, 2014; June 19, 2014; and September 15, 17, and 21, 2014, when no data were collected because of equipment failure.

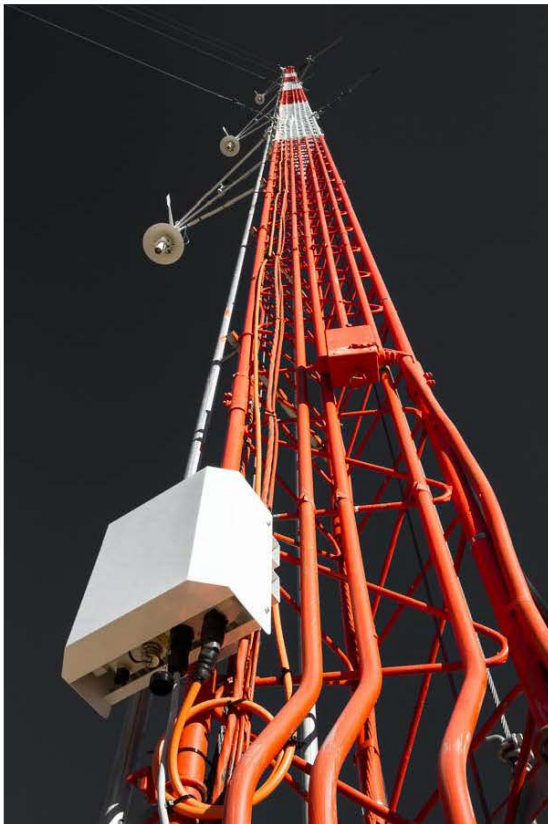

TA-54 Meteorological tower

Surface Water Data, Water Year 2014

Daily Total Precipitation (in.) for TA-54

Day	Oct	Nov	Dec	Jan	Feb	Mar	Apr	May	Jun	Jul	Aug	Sep
1	0	0	0	E ^a	0	0.45	0	0	0	0.11	0.12	0
2	0	0	E	E	0	0.01	0	0	0	0.65	0	0
3	0	E	E	E	0.05	0	0	0	0	0.02	0	0
4	0	0.81	E	E	0	0	0	0	0	0	0.08	0
5	0	E	E	E	0	E	0.03	0	0	0	0.27	0.06
6	0	E	E	E	0	0	0.01	0	0	0.03	0	0
7	E	0	E	0	0	E	0	0	0.47	0	0	0
8	0	E	E	E	0	0	0	0	0.01	1.46	0	0
9	0	E	E	0	0	0	0	0	0	0.01	0	0
10	0.27	E	E	0	0	0	0	0	0	0	0.1	0
11	0	0	E	0	0	0	0	0	0	0	0	0
12	0	0	E	0	0	0	0	0.02	0	0	0	0
13	0.01	0	E	0	0	0	0	0	0.19	0	0.01	0
14	0	0	E	0	0	0.04	0	0	E	0.53	0	0
15	0.12	0.14	E	0	0	0	0	0	0	0.36	0.02	E
16	0	0	E	0	0	0	0	0	0	0	0	0
17	0	0	E	0	0	0	0	0	E	0	0	E
18	0	0	E	0	0	0	0	0	0	0	0	0
19	0	0	E	0	0	0	0.07	0	E	0.04	0	0
20	0	0	E	0	0	0	0	0	0	0	0	0
21	0	0.52	E	0	0	0	0	0	0.13	0	0.02	E
22	0	E	E	0	0	0	0	0.53	0	0	0.09	0.01
23	0	0.09	E	0	0	0	0	0.12	0	0.01	0	0
24	0.24	E	E	0	0	0	0	0.26	0	0	0	0
25	0.01	0.02	E	0	0	0.01	0	0.05	0	0	0	0
26	0	IA ^b	E	0	0	0	0	0	0	0	0.46	0
27	0	0	E	0	0.02	0	0	0	0	0.1	0	0
28	0	0	E	0	0	0	0	0	0	0.06	0	0
29	0	E	E	0		0	0	0	0	0.06	0	0.19
30	E	E	E	0		0	0	0	0	0	0	0
31	0		E	0.01		0		0		0.54	0	

^a E represents equipment failure.

^b IA represents inactive gage during seasonal shutdown.

Monthly Total Precipitation (in.) for TA-54, October 2013–September 2014

	Oct	Nov	Dec	Jan	Feb	Mar	Apr	May	Jun	Jul	Aug	Sep
Total (in.)	0.65*	1.58*	0.0*	0.01	0.07	0.51	0.11	0.98	0.8*	3.98	1.17	0.26
Mean Total for Period of Record (in.)	1.40	0.68	0.66	0.59	0.52	0.76	0.73	0.84	0.93	1.97	2.43	1.65
Max Daily Total (in.)	0.24	0.81	0	0.01	0.05	0.45	0.07	0.53	0.47	1.46	0.46	0.19
Missing Days	1	10	30	7	0	0	0	0	1	0	0	3

*Partial month because of inactivity, maintenance, or equipment failure.

Surface Water Data, Water Year 2014

North Community Meteorological Tower

Location. Lat 35° 54' 3", long -106° 19' 18", NE ¼, Sec. 5, T. 19 N., R. 6 E., Los Alamos County.

Period of Record. January 1, 1986, to September 30, 2014.

Gage. Elevation of gage is 7414 ft using LANL LIDAR DEM with NAD 83.

Maximum Daily Total Precipitation for Period of Record. 2.58 in. on September 12, 2013.

Maximum Daily Total Precipitation for Monsoon Season. 0.70 in. on July 8, 2014.

Equipment. The precipitation gage consists of a heated tipping bucket with wind screen.

Precipitation Record. The precipitation gage gave a complete and satisfactory record, except for December 10–14 and 18, 2013; March 18 and 23–24, 2014; May 18 and 28, 2014; June 18, 2014; and September 21, 2014, when no data were collected because of equipment failure.

No image available for the North Community precipitation gage.

Surface Water Data, Water Year 2014

Daily Total Precipitation (in.) for North Community

Day	Oct	Nov	Dec	Jan	Feb	Mar	Apr	May	Jun	Jul	Aug	Sep
1	0	0	0	0	0	0.53	0	0	0	0	0.16	0
2	0	0	0	0	0	0.03	0	0	0	0	0	0
3	0	0	0	0	0.01	0	0	0	0	0	0.01	0
4	0	0.38	0	0	0.03	0	0	0	0	0.06	0.06	0.01
5	0	0	0	0	0	0	0	0	0	0	0.01	0.06
6	0	0	0	0	0	0	0	0	0	0	0	0
7	0	0	0.01	0	0	0	0	0	0.16	0.6	0	0
8	0	0	0	0	0	0	0	0	0	0.7	0	0
9	0	0	0	0	0	0	0	0	0	0.02	0	0
10	0.26	0	E*	0	0	0	0	0	0	0.01	0	0
11	0	0	E	0	0	0	0	0	0	0.07	0	0
12	0	0	E	0	0	0	0	0.02	0	0	0	0.02
13	0.14	0	E	0	0	0	0.11	0	0.06	0.01	0.02	0
14	0	0	E	0	0	0.08	0.01	E	0	0.53	0	0
15	0.32	0.15	0	0	0	0.04	0	0	0	0.5	0.11	0
16	0	0.05	0	0	0	0	0	0	0	0.07	0	0
17	0	0	0	0	0	0	0	0	0	0	0	0
18	0	0	E	0	0	E	0	0	IA	0	0	0
19	0	0	0	0	0	0	0.03	0	0	0.23	0	0
20	0	0	0	0	0	0	0	0	0	0.01	0	0
21	0	0.6	0	0	0	0	0	0	0.08	0.01	0	E
22	0	0.03	0	0	0	0	0	0.16	0	0	0.1	0.03
23	0	0.08	0	0	0	E	0	0.39	0	0	0	0
24	0.26	0.01	0	0	0	E	0	0.25	0	0	0	0
25	0	0.03	0	0	0	0.01	0	0.27	0	0	0	0
26	0	0	0	0	0	0.05	0.07	0.01	0	0.59	0.08	0
27	0	0	0	0	0.15	0	0	0	0	0.35	0	0
28	0	0	0	0	0	0	0	E	0	0.08	0	0
29	0	0	0	0		0	0	0	0	0.54	0	0.05
30	0.04	0	0	0		0	0	E	0	0	0	0
31	0		0	0.01		0		0		0.48	0	

* E represents equipment failure.

Monthly Total Precipitation (in.) for North Community, October 2013–October 2014

	Oct	Nov	Dec	Jan	Feb	Mar	Apr	May	Jun	Jul	Aug	Sep	Oct
Total (in.)	1.02	1.33	0.01	0.01	0.19	0.74	0.22	1.1*	0.30	4.86	0.55	0.17	0.67
Mean Total for Period of Record (in.)	1.69	0.80	0.82	0.82	0.76	0.92	1.02	1.12	1.24	2.73	3.45	1.67	1.64
Max Daily Total (in.)	0.32	0.60	0.01	0.01	0.15	0.53	0.11	0.39	0.16	0.59	0.11	0.06	0.09
Missing Days	0	0	6	0	0	3	0	1	1	0	0	1	0

Surface Water Data, Water Year 2014

*Partial month because of inactivity, maintenance, or equipment failure.

REFERENCES

Carter, R.W., and J. Davidian, 1968. *Techniques of Water-Resources Investigations of the United States Geological Survey, General Procedure for Gaging Streams*. Book 3, Chapter A6, U.S. Geological Survey.

Kilpatrick, F.A., and V.R. Schneider, 1983. *Techniques of Water-Resources Investigations of the United States Geological Survey, General Procedure for Gaging Streams*. Book 3, Chapter A14, U.S. Geological Survey.

LANL, 2013 Site Discharge Pollution Prevention Plan, Revision 1, NPDES Permit No. NM0030759, Volumes 1–5.

National Geodetic Vertical Datum of 1929.

North American Datum of 1983.

Rantz, S.E., 1982. *Measurement and Computation of Stream Flow Volume 1: Measurement of Stage and Discharge*. Geological Survey Water-Supply Paper 2175. U.S. Geological Survey.

Previous LANL reports in this series: "Surface Water Data at Los Alamos National Laboratory" for Water Years (WY) 1995 to 2013 are available in pdf format. The reports can be accessed at the electronic public reading room at <http://epr.lanl.gov>.

ABBREVIATIONS, ACRONYMS, AND GLOSSARY

Acre-foot (acre-ft) is the quantity of water required to cover 1 acre to a depth of 1 foot and is equivalent to 43,560 cubic feet, 325,851 gallons, or 1233.49 cubic meters.

CMP is corrugated metal pipe.

Construction General Permit is a permit from the U.S. Environmental Protection Agency that allows for storm water discharges from construction activities.

Control designates a feature downstream from the gage that determines the stage-discharge relation at the gage. This feature may be a natural constriction of the channel, an artificial structure, or a uniform cross-section over a long reach of the channel.

Control structure as used in this report is a structure on a stream or canal used to regulate the flow or stage of the stream.

Cubic feet per second (ft³/s, cfs) is the rate of discharge representing a volume of 1 cubic foot passing a given point during 1 second; it is equivalent to 7.48 gallons per second, 448.8 gallons per minute, or 0.02832 cubic meters per second.

DOE U.S. Department of Energy

Discharge is the volume of water (or more broadly, the volume of fluid, including suspended sediment) that passes a given point within a given period of time.

Drainage area of a stream at a specified location is that area measured in a horizontal plane and enclosed by a topographic divide from which direct surface runoff from precipitation normally drains by

gravity into the stream above the specified point. Figures of drainage areas provided herein include all closed basins, or noncontributing areas, within the area, unless otherwise noted.

Environmental Protection Agency (U.S.) (EPA) is the federal agency that enforces regulations to protect the environment and human health.

Extended precipitation network is the LANL precipitation monitoring gage network from which precipitation data are obtained.

Gage height (GH) is the water-surface elevation referred to in some arbitrary gage data. GH is often used interchangeably with the more general term "stage," although GH is more appropriate when used with a reading on a gage.

Gage station is a particular site on a stream, canal, lake, or reservoir in which systematic observations of hydrologic data are obtained.

HWM is high-water mark.

Individual Permit is a National Pollutant Discharge Elimination System individual permit issued by the EPA that authorizes the discharge of storm water associated with industrial activities at Los Alamos National Laboratory.

Instantaneous discharge is the discharge at a particular instance of time.

ISCO is a reference to Teledyne ISCO, Inc., which is an automated sampler manufacturer.

LANL is Los Alamos National Laboratory.

LIDAR DEM is light detection and ranging digital elevation model.

Mean discharge (mean) is the arithmetic mean of individual daily mean discharges during a specific period.

Meteorological observation network is a network of towers that provides year-round meteorological data.

Multi-Sector General Permit is a National Pollutant Discharge Elimination System permit issued by the EPA that authorizes the discharge of storm water associated with industrial activities.

National Geodetic Vertical Datum of 1929 (NGVD 29) is the National standard reference datum for elevations.

NEMA is the National Electrical Manufacturers Association.

North American Datum of 1983 (NAD 83) is the official horizontal datum for use in the North and Central American geodetic networks. Based on the Geodetic Reference System 1980 ellipsoid, it was developed using satellite and remote sensing imagery and is the default datum used at LANL and most global positioning system units today.

NPDES is National Pollutant Discharge Elimination System.

Point of zero flow (PZF) is the gage height at which no flow occurs.

Surface Water Data, Water Year 2014

Precipitation emergency notification stations (PENS) is a precipitation notification system for LANL to provide emergency notification during monsoon rain events.

Reference point (RP) is a permanent gage height reference used to calibrate stage measurements.

Site Discharge Pollution Prevention Plan is a LANL report updated annually that provides information on each of the seven major watersheds of the Pajarito Plateau and related storm water monitoring activities within the watersheds.

SR means "State Road" and is the former designation for NM 4, NM 501, and NM 502. It appears in gage station names.

Stage see **gage height**.

Stage-discharge relationship is the relation between the water-surface elevation, termed "gage height," and the volume of water flowing in a channel per unit of time.

Stream flow is the discharge that occurs in a natural channel.

SWSC is sanitary wastewater systems consolidation.

TA is technical area.

USGS is U.S. Geological Survey.

Waste Water Treatment Facility (WWTF) is the Los Alamos County Wastewater Treatment Facility located in TA-74 in Pueblo Canyon. It was previously called the Waste Water Treatment Plant.

Water data report (WDR) is the USGS report that provides the methodology used for data collection.

Water year (WY) in reports dealing with surface water supply is the 12-month period, October 1 through September 30. The water year is designated by the calendar year in which it ends and that includes 9 of the 12 months. Thus, the year ending September 30, 1980, is called the "1980 water year" or WY1980.

APPENDIX J

2017 Drinking Water Quality Data Report

[This page is intentionally left blank.]

Los Alamos Department of Public Utilities
2017 Annual Drinking Water Quality Report

Is my water safe?

We are pleased to present this year's Annual Water Quality Report (Consumer Confidence Report) as required by the Safe Drinking Water Act (SDWA). This report is designed to provide details about where your water comes from, what it contains, and how it compares to standards set by regulatory agencies. This report is a snapshot of last year's water quality. We are committed to providing you with information because informed customers are our best allies.

Do I need to take special precautions?

Some people may be more vulnerable to contaminants in drinking water than the general population. Immuno-compromised persons such as persons with cancer undergoing chemotherapy, persons who have undergone organ transplants, people with HIV/AIDS or other immune system disorders, some elderly, and infants can be particularly at risk from infections. These people should seek advice about drinking water from their health care providers. EPA/Centers for Disease Control (CDC) guidelines on appropriate means to lessen the risk of infection by *Cryptosporidium* and other microbial contaminants are available from the Safe Water Drinking Hotline (800 426 4791).

Where does my water come from?

The water production team with the Los Alamos Department of Public Utilities oversees the pumping of ground water from twelve wells to provide Los Alamos County with quality drinking water. The wells tap the main aquifer under the Pajarito Plateau, part of the Santa Fe formation. A pollution

prevention and wellhead protection program is in place to protect this underground water source. Pumped from depths of 1,000 feet at times, the water is treated with a disinfectant. Drinking water is routinely monitored for constituents and results are published in accordance with federal and state law. Results for the period of January 1, 2017 through December 31, 2017 are included in this brochure.

Water Rights

Total water rights available to the County amount to 5,541.3 acre-feet per year as determined by the New Mexico Office of the State Engineer. In addition, the County has a contract with the U.S. Bureau of Reclamation for another 1,200 acre-feet of water per year from the San Juan/Chama transmountain diversion project. This water is yet to be utilized.

Source water assessment and its availability

The Los Alamos Department of Public Utilities protects drinking water from contamination based on well construction, hydrogeologic settings, and system operations and management. A Source Water Assessment and Protection (SWAP) analysis was performed in 2003 by the New Mexico Environment Department (NMED) to identify any possible sources of contamination. NMED ranked the susceptibility of Los Alamos entire water system as "moderately high." To discuss findings please contact Jack Richardson, Deputy Utilities Manager at 505 662 8333.

2017
Annual Drinking
Water Quality Report

Este informe contiene información muy importante sobre la calidad de su agua beber. Tradúscalo o hable con alguien que lo entienda bien.

LOS ALAMOS
Department of Public Utilities

1000 Central Avenue, Suite 130
Los Alamos, NM 87544

Why are there contaminants in my drinking water?

Drinking water, including bottled water, may reasonably be expected to contain at least small amounts of some contaminants. The presence of contaminants does not necessarily indicate that water poses a health risk. More information about contaminants and potential health effects can be obtained by calling the Environmental Protection Agency's (EPA) Safe Drinking Water Hotline (800 426 4791). The sources of drinking water (both tap water and bottled water) include rivers, lakes, streams, ponds, reservoirs, springs, and wells. As water travels over the surface of the land or through the ground, it dissolves naturally occurring minerals and, in some cases, radioactive material, and can pick up substances resulting from the presence of animals or from human activity:

- **Microbial contaminants**, such as viruses and bacteria, that may come from sewage treatment plants, septic systems, agricultural livestock operations, and wildlife;
- **Inorganic contaminants**, such as salts and metals, which can be naturally occurring or result from urban stormwater runoff, industrial, or domestic wastewater discharges, oil and gas production, mining, or farming;
- **Pesticides and herbicides**, which may come from a variety of sources such as agriculture, urban stormwater runoff, and residential uses;
- **Organic chemical contaminants**, including synthetic and volatile organic chemicals, which are by-products of industrial processes and petroleum production, and can also come from gas stations, urban stormwater runoff, and septic systems; and
- **Radioactive contaminants**, which can be naturally occurring or be the result of oil and gas production and mining activities.

In order to ensure that tap water is safe to drink, EPA prescribes regulations that limit the amount of certain contaminants in water provided by public water systems. Food and Drug Administration (FDA) regulations establish limits for contaminants in bottled water which must provide the same protection for public health.

Description of Water Treatment Process

Your water is treated by disinfection. Disinfection involves the addition of chlorine or other disinfectant to kill dangerous bacteria and microorganisms that may be in the water. Disinfection is considered to be one of the major public health advances of the 20th century.

Sanitary Survey of Drinking Water

The NMED Department of Drinking Water performs a Sanitary Survey of drinking water systems every three years. The 2015 Sanitary Survey Report stated that Los Alamos Municipal Water System is very effectively managed, has a well trained staff, and outstanding housekeeping. There were no significant nor minor deficiencies identified.

Hardness

Los Alamos Department of Public Utilities

drinking water is moderately hard, at 90 mg/L or 5.3 grains of calcium carbonate per gallon. Moderately hard water helps build a protective layer of calcium carbonate on the inside of pipes to protect you from any lead plumbing that may be present in your home. Water hardness is measured as calcium carbonate. Usually when hardness is lower than 60 mg/L the water is "soft." When hardness is higher than 180 mg/L the water is "hard." Additionally, Los Alamos drinking water has high levels of silica, a naturally occurring mineral due to the volcanic formations in the aquifer. These levels give our water its unique flavor, however, also increases the hardness of our water.

Additional Information for Chromium

In 2005 the Los Alamos National Laboratory (LANL) detected hexavalent chromium in a regional aquifer monitoring well at elevated levels. This contamination is a result of legacy waste from past LANL operations. In response, LANL and DPU began increased monitoring of Los Alamos' drinking water supply wells for both total and hexavalent [Cr(VI)] chromium. To date, only naturally occurring chromium, at safe levels, is detected in DPU drinking water wells, and is unrelated to the LANL chromium

contamination. Detections in the drinking water wells range from 4 ppb to 5 ppb and are well below EPA's drinking water standard of 100 ppb and New Mexico's established ground water standard of 50 ppb.

Additional Information for Lead

If present, elevated levels of lead can cause serious health problems, especially for pregnant women and young children. Lead in drinking water is primarily from materials and components associated with service lines and home plumbing. Los Alamos Department of Public Utilities is responsible for providing high quality drinking water, but cannot control the variety of materials used in plumbing components. When your water has been sitting for several hours, you can minimize the potential for lead exposure by flushing your tap for 30 seconds to 2 minutes before using water for drinking or cooking. If you are concerned about lead in your water, you may wish to have your water tested. Information on lead in drinking water, testing methods, and steps you can take to minimize exposure is available from the Safe Drinking Water Hotline or at <http://www.epa.gov/safewater/lead>.

Additional Information for Arsenic

While your drinking water meets EPA's standard for arsenic, it does contain low levels of arsenic. EPA's standard balances the current understanding of arsenic's possible health effects against the costs of removing arsenic from drinking water. EPA continues to research the health effects of low levels of arsenic which is a mineral known to cause cancer in humans at high concentrations and is linked to other health effects such as skin damage and circulatory problems.

How Do I Get Involved?

The Board of Public Utilities governs the county-owned Department of Public Utilities. Comprising five county residents appointed by the County Council, the Board approves rules, regulations and policies to ensure the provision of safe, reliable, utility services.

Board members are Jeff Johnson, Chair; Carrie Walker, Vice Chair; Paul Frederickson; Stephen McLin; and Kathleen Taylor.

More information can be found at <https://rebrand.ly/LACBPU>.

Join us! The board meets every third Wednesday of each month at 5:30 p.m. in Council Chambers, 1000 Central Avenue, Los Alamos. Download agendas or watch the meetings at <http://losalamos.legistar.com/Calendar.aspx>. Select "Board of Public Utilities" in the drop down window.

Water Conservation Tips

Did you know that the average U.S. household uses approximately 400 gallons of water per day or 100 gallons per person per day? Luckily, there are many low-cost and no-cost ways to conserve water. Small changes can make a big difference - try one today and soon it will become second nature.

- Take short showers - a 5 minute shower uses 4 to 5 gallons of water compared to up to 50 gallons for a bath.
- Shut off water while brushing your teeth, washing your hair and shaving and save up to 500 gallons a month.
- Use a water-efficient shower head. They're inexpensive, easy to install, and

can save you up to 750 gallons a month.

- Run your clothes washer and dishwasher only when they are full. You can save up to 1,000 gallons a month.
- Water plants only when necessary.
- Fix leaky toilets and faucets. Faucet washers are inexpensive and take only a few minutes to replace. To check your toilet for a leak, place a few drops of food coloring in the tank and wait. If it seeps into the toilet bowl without flushing, you have a leak. Fixing it or replacing it with a new, more efficient model can save up to 1,000 gallons a month.
- Adjust sprinklers so only your lawn is watered. Apply water only as fast as the soil can absorb it and during the cooler

parts of the day to reduce evaporation.

- Teach your kids about water conservation to ensure a future generation that uses water wisely. Make it a family effort to reduce next month's water bill!

Visit www.epa.gov/watersense for more information.

Cross Connection Control Survey

The purpose of this survey is to determine whether a cross-connection exists at your home or business. A cross connection is an unprotected or improper connection to a public water distribution system that may cause contamination or pollution to enter the system. We will assist you to identify

cross-connection controls, insuring that no contaminants can, under any flow conditions, enter the distribution system. If you have any of the devices listed below please contact us so that we can discuss the issue, and if needed, survey your connection and assist you in isolating it if that is necessary.

- Boiler/ Radiant heater (water heaters not included);
- Underground lawn sprinkler system;
- Pool or hot tub (whirlpool tubs not included);
- Additional source(s) of water on the property;
- Decorative pond; and
- Watering trough.

Water Quality Data Table

In order to ensure that tap water is safe to drink, EPA prescribes regulations which limit the amount of contaminants in water provided by public water systems. The table below lists all of the drinking water contaminants that we detected during the calendar year of this report. Although many more contaminants were tested, only those substances listed below were found

in your water. All sources of drinking water contain some naturally occurring contaminants. At low levels, these substances are generally not harmful in our drinking water. Removing all contaminants would be extremely expensive, and in most cases, would not provide increased protection of public health. A few naturally occurring minerals may actually improve the taste of

drinking water and have nutritional value at low levels. Unless otherwise noted, the data presented in this table is from testing done in the calendar year of the report. The EPA or the State requires us to monitor for certain contaminants less than once per year because the concentrations of these contaminants do not vary significantly from year to year, or the system is not considered

vulnerable to this type of contamination. As such, some of our data, though representative, may be more than one year old. In this table you will find terms and abbreviations that might not be familiar to you. To help you better understand these terms, we have provided the definitions below the table.

Contaminants	MCLG or MRDLG	MCL, TT, or MRDL	Detect In Your Water	Range		Sample Date	Violation	Typical Source
				Low	High			
Disinfectants & Disinfection By-Products								
[There is convincing evidence that addition of a disinfectant is necessary for control of microbial contaminants]								
Chlorine [as Cl ₂] (ppm)	4	4	0.382	0.02	0.62	2017	No	Water additive used to control microbes
Halocetic Acids (HAAS)* (ppb)	NA	60	1	0	0.58	2017	No	By-product of drinking water chlorination
THMs [Total Trihalomethanes]* (ppb)	NA	80	10	2.7	8.8	2017	No	By-product of drinking water disinfection
* The "Range" for Halocetic Acids (HAAS) and THMs (Total Trihalomethanes) are the lowest and highest test sample. The "Detect In Your Water" is the highest locational Running Annual Average (RAA) which includes data from 2016.								
Inorganic Contaminants								
Arsenic (ppb)	0	10	4	0	4	2017	No	Erosion of natural deposits; Runoff from orchards; Runoff from glass and electronics production wastes
Chromium (ppb)	100	100	5	4	5	2017	No	Discharge from steel and pulp mills; Erosion of natural deposits
Fluoride (ppm)	4	4	0.32	0.26	0.32	2017	No	Erosion of natural deposits; Water additive which promotes strong teeth; Discharge from fertilizer and aluminum factories
Nitrate [measured as Nitrogen] (ppm)	10	10	0.47	0.33	0.47	2017	No	Runoff from fertilizer use; Leaching from septic tanks, sewage. Erosion of natural deposits
Radioactive Contaminants								
Alpha emitters (pCi/L)	0	15	0.9	NA	0.9	2014	No	Erosion of natural deposits
Beta/ photon emitters (mrem/yr)	0	4	3.2	NA	3.2	2014	No	Decay of natural and man-made deposits
Radium (combined 226/228) (pCi/L)	0	5	0.06	0.03	0.06	2014	No	Erosion of natural deposits
Volatile Organic Contaminants								
Xylenes (ppm)	10	10	0.0005	NA	0.0005	2017	No	Discharge from petroleum factories; Discharge from chemical factories

Contaminants	MCLG	AL	Your Water (90 th Percentile)	Sample Date	# Samples Exceeding AL	Exceeds AL	Typical Source
Inorganic Contaminants							
Copper - action level at consumer taps (ppm)	1.3	1.3	0.042	2015	0	No	Corrosion of household plumbing systems; Erosion of natural deposits
Inorganic Contaminants							
Lead - action level at consumer taps (ppb)	0	15	0.92	2015	0	No	Corrosion of household plumbing systems; Erosion of natural deposits

Unit Descriptions	
Term	Definition
ppm	ppm: parts per million, or milligrams per liter (mg/L)
ppb	ppb: parts per billion, or micrograms per liter (µg/L)
pCi/L	pCi/L: picocuries per liter (a measure of radioactivity)
mrem/yr	mrem/yr: millirems per year (a measure of radiation absorbed by the body)
NA	NA: not applicable
ND	ND: Not detected
NR	NR: Monitoring not required, but recommended

Important Drinking Water Definitions	
Term	Definition
MCLG	MCLG: Maximum Contaminant Level Goal. The level of a contaminant in drinking water below which there is no known or expected risk to health. MCLGs allow for a margin of safety.
MCL	MCL: Maximum Contaminant Level. The highest level of a contaminant that is allowed in drinking water. MCLs are set as close to the MCLGs as feasible using the best available treatment technology.
TT	TT: Treatment Technique. A required process intended to reduce the level of a contaminant in drinking water.
AL	AL: Action Level. The concentration of a contaminant which, if exceeded, triggers treatment or other requirements which a water system must follow.
Variances and Exemptions	Variances and Exemptions: State or EPA permission not to meet an MCL or a treatment technique under certain conditions.
MRDLG	MRDLG: Maximum residual disinfection level goal. The level of a drinking water disinfectant below which there is no known or expected risk to health. MRDLGs do not reflect the benefits of the use of disinfectants to control microbial contaminants.
MRDL	MRDL: Maximum residual disinfectant level. The highest level of a disinfectant allowed in drinking water. There is convincing evidence that addition of a disinfectant is necessary for control of microbial contaminants.
MNR	MNR: Monitored Not Regulated
MPL	MPL: State Assigned Maximum Permissible Level

For more information please contact:

Wayne Witten
1000 Central Avenue, Suite 130
Los Alamos, NM 87544
Phone: 505-662-8333



APPENDIX K

Executive Summary of the Los Alamos National Laboratory's National Pollutant Discharge Elimination System (NPDES) Permit Re-Application Implementation Plan

[This page is intentionally left blank.]





Environmental Division – Environmental Protection & Compliance – Compliance Programs Group

NPDES PERMIT RE-APPLICATION PROJECT

2019 NPDES Permit Re-Application Implementation Plan

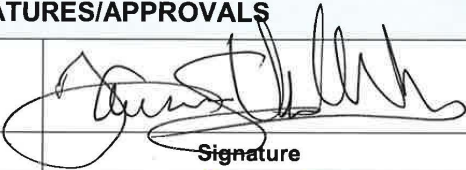
June 2018

SIGNATURES/APPROVALS		
Taunia Van Valkenburg		6/12/18
EPC-CP Group Leader	Signature	Date
Mike Saladen		6/12/18
EPC-CP Water Quality Permitting and Compliance Team Leader	Signature	Date
Patricia Vardaro-Charles		6/12/18
EPC-CP NPDES Program Lead	Signature	Date
Jennifer Griffin		6/12/18
EPC-CP NPDES Permit Re-Application Project Lead	Signature	Date

2019 NPDES Permit Re-Application
Implementation Plan
Revision 0
June 2018

EXECUTIVE SUMMARY

Approximately every five years the Los Alamos National Laboratory (LANL) must apply for renewal and re-certification of the existing Industrial Point Source National Pollutant Discharge Elimination System (NPDES) Permit No. NM0028355 issued by the U.S. Environmental Protection Agency (EPA) under the requirements specified in the Clean Water Act Section 402 and 40 CFR 122. The NPDES regulations require the submittal of a re-application 180 days prior to expiration of the existing permit. LANL's current permit will expire September 30, 2019. The LANL must submit an NPDES Permit Re-Application package by April 4, 2019 or deal with potential consequences that include delays in permit renewal by the EPA or re-certification by the New Mexico Environment Department, potential discharge violations, and could result in fines, penalties, or increased monitoring costs. In the extreme case, discontinuance of an existing permit could cause interruptions in operations or the complete shutdown of several mission critical and mission essential facilities.

The coordination and completion of the LANL's 2019 NPDES Permit Re-Application has been delegated to the Environmental Protection and Compliance Division's, Compliance Programs Group, and the level of effort is summarized in this Implementation Plan (IP). The scope of work includes the preparation of the appropriate EPA forms, fieldwork to collect this data, and sampling that makes up this submittal package. This level of effort is necessary to ensure the re-application is made up of defensible data and information for the following outfalls:

- 001 - Power Plant (TA-3-22)
- 13S - Sanitary Waste Water System (SWWS) Plant (TA-46-347)
- 04A022 – Non-Contact Cooling Water, Storm Water, and Roof Drain Water
- 03A027 - Cooling Tower Blow Down (TA-3-285 and 2327)
- 03A048 - Cooling Tower Blow Down (TA-53-964 and 979)
- 03A113 - Cooling Tower Blow Down (TA-53-293 and 1032)
- 03A160 - Cooling Tower Blow Down (TA-35-124)
- 03A181 - Cooling Tower Blow Down (TA-55-6)
- 03A199 - Cooling Tower Blow Down (TA-3-1837)
- 051 - Radioactive Liquid Waste Treatment Facility (RWLTF) (TA-50-1)
- 05A055 - High Explosives Wastewater Treatment Facility (HEWTF) (TA-16-1508)

The information required includes the location of the outfall, a detailed description of all sources and processes that contribute to the discharged waste stream, the volume and frequency of the discharge, and current analytical data for each effluent waste stream that currently discharges to an outfall. Historical data will be used for those outfalls that no longer discharge but maintain their outfall as a contingency.

2019 NPDES Permit Re-Application
Implementation Plan
Revision 0
June 2018

The effort has the following key milestones:

Project Kick-off – FOD Forum	July 26, 2018
Outfall Survey Field Work Complete	Sep 30, 2018
Outfall Effluent Sampling Complete	Oct 29, 2018
Outfall Survey's Complete	Oct 29, 2018
Formal Internal Review of Draft NPDES Permit Re-Application	Nov 26, 2018 – Dec 10 2018
Socialize Draft NPDES Permit Re-Application with EPA and NMED	Nov 26, 2018
Submit Final NPDES Permit Re-Application Submittal to NNSA/LASO for Signature	Feb 12, 2019
EPA Approves Application as Administratively Complete	Apr 1, 2019

APPENDIX L

**Sampling and Analysis Plan for Los Alamos
National Laboratory's National Pollutant
Discharge Elimination System (NPDES) Permit
Re-Application**

[This page is intentionally left blank.]



Environmental Protection & Compliance Division – Environmental Compliance Programs Group (EPC-CP)
NPDES PERMIT RE-APPLICATION PROJECT

2019 NPDES Permit Re-Application Sampling and Analysis Plan (SAP)

July 2018

SIGNATURES/APPROVALS		
Taunia Van Valkenburg		7/30/18
EPC-CP Group Leader	Signature	Date
Mike Saladen		7/30/18
EPC-CP Water Quality Permitting and Compliance Team Leader	Signature	Date
Patricia Vardaro-Charles		7/30/18
EPC-CP NPDES Program Lead	Signature	Date
Jennifer Griffin		7/27/18
EPC-CP NPDES Permit Re-Application Project Lead	Signature	Date

2019 NPDES Permit Re-Application
Sampling and Analysis Plan (SAP)
July 2018

Table of Contents

1	INTRODUCTION.....	4
1.1	Purpose.....	4
1.2	Scope.....	4
1.3	Applicability.....	4
1.4	Definitions.....	4
2	BACKGROUND.....	5
3	DATA QUALITY OBJECTIVES (DQO).....	5
3.1	Problem (Step 1).....	5
3.2	Goals and Objectives (Step 2).....	5
3.3	Inputs (Step 3).....	6
3.4	Sampling Rationale (Step 4).....	6
3.5	Sampling Approach/Methodology (Step 5).....	7
3.6	Data Management, Verification, and Validation (Step 6).....	8
4	SAMPLING PLAN (Step 7).....	9
4.1	Precautions.....	9
4.2	Limitations.....	9
4.3	Prerequisite Actions.....	9
4.3.1	Planning and Coordination.....	9
4.3.2	Documentation.....	9
4.4	Sampling Equipment.....	10
4.5	Field Methods and Procedures.....	11
4.5.1	Equipment Preparation and Calibration.....	11
4.5.2	Sample Collection.....	11
4.5.3	Documentation.....	11
4.6	Packaging and Transportation.....	12
5	QUALITY CONTROL.....	12
6	TRAINING.....	12
7	WASTE MANAGEMENT.....	12
8	RECORDS.....	12
9	REFERENCES.....	13

**2019 NPDES Permit Re-Application
Sampling and Analysis Plan (SAP)
July 2018**

TABLES

No.	Title
1	Sampling Rational by Outfall
2	Sampling Approach/Methodology by Outfall Category

ATTACHMENTS

No.	Title
A	Form 2C Analytes
B	Tables Showing EPA Application Form 2C Pollutants Approved Methods, Containers, Preservation, and Hold Times

**2019 NPDES Permit Re-Application
Sampling and Analysis Plan (SAP)
July 2018**

LIST OF ACRONYMS

CFR	Code of Federal Regulations
CP	Compliance Programs Group
DOE	U.S. Department of Energy
DQO	Data Quality Objective
EPA	U.S. Environmental Protection Agency
EPC	Environmental Protection & Compliance Division
GC/MS	Gas Chromatography/Mass Spectroscopy (GC/MS)
IWD	Integrated Work Document
LANL	Los Alamos National Laboratory
NPDES	National Pollutant Discharge Elimination System
QC	Quality Control
SAP	Sampling and Analysis Plan
SMO	Sample Management Office
TA	Technical Area
TRC	total residual chlorine
VOA	Volatile Organic Analysis

2019 NPDES Permit Re-Application
Sampling and Analysis Plan (SAP)
July 2018

1 INTRODUCTION

Effluent discharges to surface waters from Laboratory operations are currently regulated under the Laboratory's National Pollutant Discharge Elimination System (NPDES) Permit No. NM0028355 issued by the U.S. Environmental Protection Agency (EPA). Approximately every 5 years the Los Alamos National Laboratory (LANL) must apply for the renewal and re-certification of this NPDES Permit. The NPDES regulations require the submittal of an application 180 days prior to expiration of the existing permit. The LANL's existing permit will expire September 30, 2019, and thus, the re-application is required to be submitted to the EPA by April 4, 2019.

1.1 Purpose

This Sampling and Analysis Plan (SAP) documents the sampling, analysis, and record keeping procedures implemented by Environmental Protection and Compliance (EPC) Division's, Compliance Programs (CP) Group to insure compliance with the guidelines for the 2019 NPDES Permit Re-Application set forth in EPA's Consolidated Permits Program. Information presented in this sampling plan includes:

- Parameters to be quantified for each outfall category (and certain individual outfalls) based on EPA document "Application Form 2C- Wastewater Discharge Information".
- The methods and equipment used to collect, preserve, and analyze samples that satisfies the requirements of "Application Form 2C- Wastewater Discharge Information".
- Timetables for sampling that ensure timely submission of all relevant data requested in Application Form 2C (Rev. August 1990), *General Information*, and Form 1.
- Proper documentation of procedures and results.

1.2 Scope

This SAP applies to EPC-CP personnel, contractors, students, and/or other facility personnel who perform sample collection and field analysis activities to support the 2019 NPDES Permit Re-Application. Samples obtained for analysis may consist of wastewater collected from tanks, process equipment, or the outfall discharge location.

1.3 Applicability

This SAP is only applicable to the collection of samples for the 2019 NPDES Permit Re-Application.

1.4 Definitions

Compliance Sample	A sample collected at an NPDES outfall downstream from final treatment, prior to or at the point of discharge as documented in Part II of LANL's current NPDES Permit No. NM0028355. Analysis of these samples must be by approved methods (40 CFR 136.3) and/or other test procedures specified in LANL's NPDES Permit or approved by the EPA Regional Administrator or designee.
Composite Sample	The term "24-hour composite means a sample consisting of a minimum of three (3) aliquots of effluent collected at regular intervals over a normal 24-hour operating period and combined in proportion to flow or a sample continuously collected in proportion to flow over a normal 24-hour operating period. The term "3-hour composite sample" means a sample consisting of a minimum of one (1) aliquot of effluent collected at a one-hour interval over a period of up to 3 hour discharge.
Grab Sample	A manual grab sample is an individual sample of at least 100 milliliters collected at a randomly selected time over a period not exceeding 15 minutes. Grab samples will be used for pH, temperature, cyanide, total phenols, residual chlorine, oil and grease, and fecal coliform.
ISCO Sampler (3700 Series)	The portable ISCO is a battery operated, programmable, calibrated sampler capable of proportional sampling based on flow and used for composite sampling. These samplers will be used to sample over a 24-hour period and have the capability of sampling a continuous flow, or an intermittent flow (using a flow sensor). Individual manual grabs will be composited at the analytical

2019 NPDES Permit Re-Application
Sampling and Analysis Plan (SAP)
July 2018

Operational Sample	<p>laboratory.</p> <p>A representative sample collected from the wastewater within the treatment process (between units, after chemical addition) that provides data to evaluate, adjust, or maintain the effectiveness of the process equipment and/or chemical addition.</p> <p>An operational sample may also consist of a sample of wastewater from treatment process downstream of final treatment that is representative of the effluent that could be discharged to an NPDES outfall. The purpose of this type of operational sample is to provide data that will support engineering studies, equipment modifications, and/or permit applications.</p>
Representative Sample	<p>A portion of a discharge that is as nearly identical in content and consistency as possible to that in the total discharge.</p>

2 BACKGROUND

The coordination and completion of the LANL's 2019 NPDES Permit Re-Application has been delegated to the EPC-CP Group. The Laboratory is obligated to provide an NPDES Permit Re-Application with the most accurate and complete characterization of discharges from its industrial and sanitary. Characterization of wastewater discharges will be accomplished through lab-wide sampling as required by EPA's application Form 2C. The information provided in the re-application will be reviewed by EPA and will form the basis for establishing the numerical effluent limits in the new NPDES permit. The four basic factors affecting the quality of environmental data provided in the re-application are: sample collection, sample preservation, sample analysis, and record management. Deficiency in anyone of these areas may result in poor data provided in the re-application and consequently impact the development of permit limits.

The foundation of any sampling program is field operations. A quality field-sampling program is based on good housekeeping, collection of representative samples, proper handling and preservation of samples, chain of custody procedures, and records management. It is anticipated that personnel will collect the outfall effluent samples in accordance with this Sampling and Analysis Plan (SAP); EPC-CP-QP-005, Sampling at NPDES Permitted Point-Source Outfalls; and EPC-CP-IWD-005, IWD Part 1, NPDES Outfall Sampling.

3 DATA QUALITY OBJECTIVES (DQO)

3.1 Problem (Step 1)

The 2019 NPDES Permit Re-application will include eleven (11) outfalls located at six (6) different technical areas (TA) within the boundaries of the LANL campus. Each of these outfalls is associated with a treatment process and/or operating facility that produces an effluent with unique characteristics. These effluents need to be sampled to define the effluent characteristics and composition for the 2019 NPDES Permit Re-Application.

3.2 Goals and Objectives (Step 2)

This SAP documents how EPC-CP personnel, contractors, students, and/or other LANL facility personnel will perform sample collection and field analysis activities to support the completion of the EPA provided applications forms. The goals and objectives are:

- Collect representative outfall samples of the wastewater effluent discharged to Outfalls 001, 03A048, 03A113, 03A199, 03A181, and 04A022 for analysis.
- Collect operational samples that are representative of the wastewater after final treatment from the "no flow" Outfalls 13S, 051, 03A027 and 05A055 for analysis.
- Provide accurate and complete characterization data for the wastewater effluents that may be discharged to each outfall.
- Provide validated and defensible analytical data that can be used to complete the EPA NPDES Application Form 2Cs for each outfall.

**2019 NPDES Permit Re-Application
Sampling and Analysis Plan (SAP)
July 2018**

Other objectives for the sampling activity include the following:

- Demonstrate that the treatment system upstream of 13S is capable of meeting the compliance requirements should the facility need to discharge to the outfall
- Demonstrate that the treatment system upstream of 051 is capable of meeting the compliance requirements should the outfall need to be used on a more regular basis.
- Demonstrate that the treatment system upstream of 05A055 is capable of meeting the compliance requirements should the facility need to discharge to the outfall.

3.3 Inputs (Step 3)

The 2019 NPDES Permit Re-Application will include the completion of forms that are provided by the EPA. One of these forms requires that analytical results from of a least one set of Form 2C analytes be provided for each outfall. The list of Form 2C analytics is provided in Attachment A.

3.4 Sampling Rationale (Step 4)

Sampling activities will be performed at 11 outfalls. Five (5) of the 11 are No Flow Outfalls. Two of these No Flow Outfalls (03A027 and 13S) discharge to the consolidated Outfall 001 at TA-3. The remaining three (3) No Flow Outfalls (03A160, 051, and 05A055) are maintained to provide operational redundancy to operations or to an evaporative treatment process. Table 1 provides the sampling rationale for each outfall.

Sample Location/ Outfall ID	Outfall Type/Status	Analytical Parameters	Rationale
001	Consolidated Outfall	Form 2C	<ul style="list-style-type: none"> • Provide defensible data for the Permit Re-Application. • Outfall includes effluent from 13S, 001, Sanitary Effluent Recycle Facility, and 03A027.
03A027	No Flow Outfall	Form 2C	Provide defensible data for the Permit Re-Application.
03A048	Outfall	Form 2C	Provide defensible data for the Permit Re-Application.
03A113	Outfall	Form 2C	Provide defensible data for the Permit Re-Application.
03A160	No Flow Outfall	None	<ul style="list-style-type: none"> • Effluent from the facility does not discharge to the Outfall. • Discharge has been routed to SWWS and the capability to collect a representative sample no longer exists. • Treatment system has been removed. • Evaluating termination of this outfall from the permit.
03A181	Outfall	Form 2C	Provide defensible data for the Permit Re-Application.
03A199	Outfall	Form 2C	Provide defensible data for the Permit Re-Application.
04A022	Outfall	Form 2C	Provide defensible data for the Permit Re-Application.
051	No Flow Outfall	Form 2C	<ul style="list-style-type: none"> • Provide defensible data for the Permit Re-Application. • Provide data to demonstrate that the effluent meets the compliance requirements should the outfall need to be used on a more regular basis.
05A055	No Flow Outfall	Form 2C	<ul style="list-style-type: none"> • Provide defensible data for the Permit Re-Application. • Provide data to demonstrate that the effluent meets the compliance requirements should the outfall need to be used on a more regular basis.
13S	No Flow Outfall	Form 2C	<ul style="list-style-type: none"> • Provide defensible data for the Permit Re-Application. • Provide data to demonstrate that the effluent meets the compliance requirements should the outfall need to be used.

2019 NPDES Permit Re-Application
Sampling and Analysis Plan (SAP)
July 2018

Table 1 Sampling Rationale by Outfall			
Sample Location/ Outfall ID	Outfall Type/Status	Analytical Parameters	Rationale
			<ul style="list-style-type: none"> A representative sample can be collected after the chlorine contact chamber.

3.5 Sampling Approach/Methodology (Step 5)

Samples and measurements taken for the purpose of the permit re-application must be representative of the permitted discharge:

- Outfall samples will be collected at the location specified for compliance sampling in the current permit.
- Operational samples will be collected at a location identified by operations personnel. This location must provide a sample that is representative of the wastewater after final treatment.
- Sufficient volume will be collected to allow duplicate analyses and quality control (QC) testing. All requirements found in the CFR 40 136 will be followed.
- An up-to-date logbook will be maintained, noting environmental conditions and field observations including processing conditions (communication with outfall contact) and date and time of grab sample collection or automatic sampler set-up/shut-down.

Table 2 provides the sampling approach/methodology by outfall category. Attachment B provides the detailed tables that list the Form 2C analytes and the required methods, containers, preservation, and hold times.

Table 2 Sampling Approach/Methodology by Outfall Category				
Outfall Category	Sample Location	Discharge Frequency	Sampling Method	Required Methods, Containers, Preservation, and Hold Times ^{a, b}
01A - Power Plant Discharge	001 TA-3-22	Continuous discharge to the permitted outfall.	Outfall Composite Sample: Sample throughout the 24-hour period using the ISCO Sampler. The composite will be based on flow	Table 1 Table 5 Table 2 Table 6 Table 3 Table 7 Table 4 Table 8
03A - Cooling Towers and Air Washers	03A027 TA-3-285 and 2327	Discharges to the permitted outfall throughout the day based on conductivity of the basin water.	Operational Grab Sample	Table 1 Table 5 Table 2 Table 6 Table 3 Table 7 Table 4 Table 8
	03A199 TA-3-1837		Outfall Grab Sample	
	03A181 TA-55-6		Outfall Grab Sample	
	03A113 TA-53-293 & LEDA		Outfall Grab Sample	
	03A048 TA-53-964 & 979		Outfall Grab Sample	
	03A160		Do NOT Sample	

2019 NPDES Permit Re-Application
Sampling and Analysis Plan (SAP)
 July 2018

Table 2 Sampling Approach/Methodology by Outfall Category				
Outfall Category	Sample Location	Discharge Frequency	Sampling Method	Required Methods, Containers, Preservation, and Hold Times ^{a, b}
	TA-35-124/595 NHMFL			
04A - Non-Contact Cooling Water	04A022 TA-3-224	Discharges of once-through cooling water for emergency only is permitted to outfall	Outfall Grab Sample	Table 1 Table 5 Table 2 Table 6 Table 3 Table 7 Table 4 Table 8
05A - High Explosive Waste Discharges	05A055 TA-16-1508	As needed following treatment at the H.E. Wastewater Treatment Plant	Operational Grab Sample	Table 1 Table 5 Table 2 Table 6 Table 3 Table 7 Table 4 Table 8
13S - Treated Sanitary Sewage Effluent	13S TA-46-347	Discharges to the permitted outfall throughout the day	Operational Composite Sample: Sample throughout the 24-hour period using the ISCO Sampler installed at the chlorine contact chamber (tied into flow level recorder). The composite will be based on flow	Table 1 Table 5 Table 2 Table 6 Table 3 Table 7 Table 4 Table 8
051 - Industrial Waste Treatment Plant Discharge	051 TA-50-1	Discharges to the permitted outfall as needed after batch treatment.	Operational Grab Sample	Table 1 Table 5 Table 2 Table 6 Table 3 Table 7 Table 4 Table 8

a. Form 2C analytes are identified in Attachment A.

b. Tables providing the required methods, containers, preservation, and hold times by analyte are provided in Attachment B.

An analytical laboratory independent of LANL will be contracted to perform the analysis of the samples. The analytical laboratory will use EPA approved methods per 40CFR 136 or as listed in the current NPDES Permit No. NM0028355. The analytical laboratory will be requested to provide a Level 4 Quality Data package with the analyses performed for all re-application samples. The analytical data, upon receipt from the analytical laboratory, will be formally validated by the Sample Management Office (SMO) prior to its use in the re-application.

3.6 Data Management, Verification, and Validation (Step 6)

The validated analytical data packages will be forwarded to EPC-CP from the SMO and will be uploaded onto the Form 2C either by hand or by using an electronic data base. The uploaded data will be checked for accuracy as follows:

- Review 10% of all data uploaded through electronic means will be completely verified to be accurate against the original paper copy provided by the analytical laboratory.
- Review 100% of all data that are uploaded through manual means (by hand) will undergo 100% verification by someone other than the data entry person.

2019 NPDES Permit Re-Application
Sampling and Analysis Plan (SAP)
July 2018

These reviews will be documented, forwarded to the appropriate record series, and a hard copy sent to EPC-CP.

4 SAMPLING PLAN (Step 7)

4.1 Precautions

General safety hazards applicable to all field activities are identified in ENV-DO-QP-100, General Field Safety. All personnel performing sampling activities should be familiar with the categories described in LANL's NPDES Permit No. NM0028355. Material Safety Data Sheets (MSDS) for chemicals used in field analyses and sample preservation are located in the Storm Water Lab (currently at TA-59-1, Room 172). Prior to starting sampling activities, sampling personnel will complete training to EPC-CP-IWD-005, IWD Part 1, NPDES Outfall Sampling which addresses site specific training, hazards and controls, referenced procedures, and training. Additionally, sampling team members must be familiar with the proper operation of field equipment and chemicals used in sampling operations. Proper vehicle operation in normal and inclement weather is also a concern.

4.2 Limitations

Sampling activities will be conducted in accordance with EPC-CP-IWD-005, IWD Part 1 NPDES Outfall Sampling. A Hazard Analysis was performed on the tasks associated with this procedure. Handling sample preservatives and acidic reagents (sulfite analysis) is identified as a **Moderate** Hazard Activity.

4.3 Prerequisite Actions

4.3.1 Planning and Coordination

Sampling personnel will coordinate with the Operations Manager assigned to each outfall prior to collecting the samples required for the NPDES Permit Re-Application. Coordination will include setting a date and time for the collection of samples, scheduling the sampling event with the plan of the day (as appropriate), and completion of site specific training (if applicable).

4.3.2 Documentation

4.3.2.1 Field Parameter Sheets

Field Parameter Sheets will be printed by sampling personnel prior to the start of sampling activities at each outfall. The required information on the Field Parameter Sheet includes:

- The outfall designation number for outfalls to be sampled
- Parameters to be sampled/analyzed
- Methods used for field analysis
- Sampler name and date/time sample was collected
- Analyst name, date and time analyzed
- Comment section where the total residual chlorine results (sample and QA spike) are recorded

4.3.2.2 Sample Collection Log, Field Chain of Custody/Labels

Sampling personnel will request SAMPLE COLLECTION LOG/FIELD CHAIN OF CUSTODY forms from the Sample Management Office (SMO). Required information includes:

- The outfall designation number for outfalls to be sampled
- Sample ID
- Parameters to be sampled/analyzed
- Field prep ID (filtered or unfiltered)
- Sampler name and date/time sample was collected
- Number of containers, type & volume of container and preservative requirement
- Chain of Custody block for relinquishing/receiving the sample
- Comment sections

2019 NPDES Permit Re-Application
Sampling and Analysis Plan (SAP)
July 2018

The SMO concurrently produces container labels that have the same sample ID as the Sample Collection Log form. Required information on the sample container labels generated by the SMO includes:

- Name of the Facility
- Sample ID number
- Container description, number of containers, type & volume of container and preservative requirement
- Analysis requested
- Date and time of collection

4.3.2.3 Equipment Calibration Logs and Field Sampling Logbook

Sampling personnel will complete equipment calibration logs and make entries into the field sampling logbook as described in EPC-CP-QP-005, Sampling at NPDES Point-Source Outfalls.

4.4 Sampling Equipment

Sampling personnel will collect the following equipment and documents to perform the sampling activities specified in this SAP:

- EPC-CP-QP-005, Sampling at NPDES Point-Source Outfalls, and Attachment 1 (this document).
- NPDES Calibration Log Books for total residual chlorine (TRC), pH, and Sulfite located in SW lab.
- NPDES Field Sampling Log Book
- Sampling record forms, 1 for each outfall to be sampled (Attachment 1)
- 250 ml Erlenmeyer flask (field sampling container)
- Certified Thermometer
- pH meter - portable with 3 point standardization (Beckman or HACH SensION +) with Automatic Temperature Compensation for pH and temperature measurements
- Amperometric titrator or HACH spectrophotometer, for chlorine analysis
- Deionized water for rinsing equipment (Ultra-Pure Water for field blanks)
- Sulfite titrator (Iodometric) for SO₃ analysis
- Sample preservation chemicals- 02Si sulfuric, nitric acid, NaOH and others
- E-Coli bottles pre preserved with Sodium Thiosulphate
- 1 quart (1 liter) cubitainers with lids - preferably certified clean ("certified" containers meet or exceed EPA standards for semi-volatiles, pesticides, PCBs and metals analyses
- 250 ml, poly bottles with lids - preferably certified clean ("certified" containers meet or exceed EPA Performance Based Specifications for trace metals and water quality parameters volatile, semi-volatiles, pesticides, PCBs)
- 500 ml poly bottles with lids - preferably certified clean
- 1 gal. cubitainers with lids - preferably certified clean
- 32-ounce glass amber bottles/lids preferably certified clean
- Refrigeration unit, electric cooler, or cooler with ice packs. (WET test requirement 10#s of cubed ice per shipment.)
- ISCO model 3710 or 6712FR refrigerated automated sampler, clean tubing, locks and keys
- Marker pen (permanent, waterproof)
- Ball point pen
- Stop watch
- Graduated wide mouthed container (bucket) and plastic graduated cylinder (250 ml)
- Calculator
- Cellular Telephone or Radio
- Maps with locations of outfalls
- Safety Data Sheets on all chemicals/products used in sampling
- Sampling vehicle with first aid and eye-wash kits, and acid and base neutralizers
- Chemical resistant gloves and leather gloves
- Safety glasses
- Lab coat/Tyvek apron
- Hard hat (if required)
- Field boots and steel-toed boots (if required)
- pH test strips

2019 NPDES Permit Re-Application
Sampling and Analysis Plan (SAP)
July 2018

- Chlorine color wheel
- DPD TRC Chlorine Reagent AccuVac Ampuls
- HACH Chlorine 2ml glass vials
- Calibrated Balance in SW lab
- TRC Standards in SW lab.
- Copy of the current NPDES Permit
- Copy of field analytical methods for pH, Chlorine, and Sulfite analyses
- Copy of Outfall Contact
- Copy of all current IWDs
- RRES-WQH's Environment, Safety, and Health Manual
- Outfall List Sampling Frequency Table
- 60 ml poly bottles used for pH
- Certified graduated cylinder 25 ml
- 50 ml glass beakers minimum of 2
- Certified Buffer 8 for QC pH meter

4.5 Field Methods and Procedures

Samples will be collected using the procedures and processes specified in [EPC-CP-IWD-005, IWD Part 1 NPDES Outfall Sampling](#). Two people maintaining visual and voice contact will be required for fieldwork except in those areas where cellular phone (uncleared areas only) contact or radio contact can be maintained.

Two people may be required during inclement weather conditions or due to any other conditions, which may pose increased risk of incident as determined by the sampler, team leader, or group leader. Contact the EPC-CP team leader or group leader for guidance concerning after hours sampling.

4.5.1 Equipment Preparation and Calibration

Sample personnel will prepare sample containers, preservatives, and equipment prior to each days sampling activities per Section 4.2 of [EPC-CP-QP-005, Sampling at NPDES Point-Source Outfalls](#).

4.5.2 Sample Collection

4.5.2.1 Field Analysis

Field analysis will include flow, pH, TRC, and temperature. Field analysis data will be collected and documented per Section 4.3.2 and 4.3.5 of [EPC-CP-QP-005, Sampling at NPDES Point-Source Outfalls](#).

4.5.2.2 Grab Samples

Grab samples will be collected either at the outfall or at an operation sample location (e.g., TA-50 effluent tank) designated by the owner of the outfall. Grab samples will be collected, preserved, and documented in accordance with Sections 4.3.1, 4.3.3, 4.3.4, and 4.3.5 of [EPC-CP-QP-005, Sampling at NPDES Point-Source Outfalls](#).

4.5.2.3 Automated ISCO Samplers

Samples collected at an ISCO sampler (i.e., Outfall 001) will be collected per the procedures found in Section 4.3.6 and 4.3.7 of [EPC-CP-QP-005, Sampling at NPDES Point-Source Outfalls](#).

4.5.3 Documentation

4.5.3.1 Logbook

Sampling personnel will maintain a field logbook for the 2019 NPDES Permit Re-Application. It will be used to document all sampling activities including discharge descriptions or observations made while sampling (e.g., color, smell, foam, floating solids, etc).

4.5.3.2 Labeling

The SMO will produce container labels that have the same sample identification number as the Sample Collection Log form. Required information on the sample container labels generated by the SMO includes:

- Name of the Facility

2019 NPDES Permit Re-Application
Sampling and Analysis Plan (SAP)
July 2018

- Sample Identification Number
- Container description, number of containers, type & volume of container and preservative requirement
- Analysis requested
- Date and time of collection

4.5.3.3 Chain of Custody

Proper analytical request and chain-of-custody procedures will be followed in sample submission to the selected analytical laboratory. A sample tracking form will be used to verify proper turnaround times. All samples will be handled in accordance with Water Quality and SMO chain-of-custody procedures. Sample collection log/field chain of custody forms will be requested from the SMO and will include the following:

- Outfall Designation.
- Sample Identification Number.
- Parameters to be Sampled/Analyzed.
- Field Preparation (filtered or unfiltered).
- Date, Location, Time, Sampler's Name.
- Number of Containers (type and volume).

4.6 Packaging and Transportation

Sampling personnel from EPC-CP will ensure that the samples collected for each outfall are released from the sampling location with a Shipping Classification Determination Checklist per [ER-SOP-10094](#), [Sample Receiving and Shipping by the ADEM Sample Management Office](#). All samples will be labeled, secured, chilled, listed on the appropriate COC, and delivered to the SMO by EPC-CP sampling personnel. All relevant Laboratory and Department of Transportation "Hazardous Materials Regulations" criteria will be followed when transporting collected wastewater samples to the SMO.

The SMO will prepare the samples for shipment to an approved off-site analytical laboratory for analysis. The contract with the analytical laboratory will require that they use EPA approved methods, follow the appropriate U.S. Department of Energy (DOE) contract requirements, and provide a Level 4 Data Quality Package.

5 QUALITY CONTROL

All samples will be handled in accordance with chain-of-custody procedures established by the analytical laboratory and the DOE Statement of Work. Analytical and QC activities will be governed by the contracted analytical laboratory's established procedures. A minimum of 10% parameter "spikes", duplicates, and blanks will be performed by the analytical laboratory. Analytical and QC procedures will be governed by Statements of Work for Analytical Services. Analytical data will be QC to level four data packages.

6 TRAINING

Sampling personnel are qualified to perform assigned work in accordance with [PD 781-1](#), [Conduct of Training](#) and [ADESH-TPP-301](#), [ADESH Training Program Plan](#).

7 WASTE MANAGEMENT

Wastes generated from activities associated with the 2019 NPDES re-application effort will be properly characterized, managed, and disposed in accordance with [P409-1](#), [LANL Waste Acceptance Criteria](#).

8 RECORDS

The records generated by the implementation of this SAP will be managed in accordance with [ADESH-AP-006](#), [Records Management](#); and [EPC-CP-QAPP-NPDES](#), [Quality Assurance Project Plan for the NPDES Industrial Point Source Permit \(IPSP\) Self-Monitoring Program](#). The following records are anticipated to be generated:

- Logbook(s)

2019 NPDES Permit Re-Application
Sampling and Analysis Plan (SAP)
July 2018

- Instrument Calibration Logs/Documentation
- Chain of Custody Forms
- Field Parameter Sheets/Analytical Request Forms
- Analytical Data Packages (validated)

The Laboratory will retain records of all monitoring information, including all calibration and maintenance records, and records of all data needed to complete the application for this permit. Records of all sampling activities will be kept for a minimum of three years or until the next re-application deadline as a historical record of the 2019 NPDES Permit Re-Application process.

9 REFERENCES

ADESH-AP-006, Records Management

ADESH-AP-006, *Records Management*

ADESH-TPP-301, *ADESH Training Program Plan*.

ENV-DO-QP-100, General Field Safety

EPC-CP IWD-005 for NPDES Compliance Sampling.

EPC-CP-QAPP-NPDES, Quality Assurance Project Plan for the NPDES Industrial Point Source Permit (IPSP) Self-Monitoring Program.

EPC-CP-QP-005, *Sampling at NPDES Point-Source Outfalls*

ER-SOP-10094, *Sample Receiving and Shipping by the ADEM Sample Management Office*

P930-1, *LANL Waste Acceptance Criteria*

PD 781-1, *Conduct of Training*

2019 NPDES Permit Re-Application
Sampling and Analysis Plan (SAP)
July 2018

ATTACHMENT A - FORM 2C Analytes

Pollutant	EPA 625	EPA 624	EPA 608
	Base/Neutral	Volatile	Pesticides/PCB
Biochemical Oxygen Demand	Acenaphthene	Acrolein	Aldrin
Chemical Oxygen Demand	Acenaphthylene	Acrylonitrile	α-BHC
Total Organic Carbon	Anthracene	Benzene	β-BHC
Total Suspended Solids	Benzidine	Bis (Chloro-methyl) Ether	γ-BHC
Ammonia (as N):	Benzo(a)Anthracene	Bromoform	δ-BHC
Temperature (winter)	Benzo(a)Pyrene	Carbon Tetrachloride	Chlordane
Temperature (summer)	3,4-Benzofluoranthrene	Chlorobenzene	4,4'-DDT
pH	Benzo(ghi)Perylene	Chlorodibromomethane	4,4'-DDE
Bromide	Benzo(k)Fluoranthene	Chloroethane	4,4'-DDD
Chlorine, Total Residual	Bis (2-Chloroethoxy) Methane	2-Chloroethylvinyl Ether	Dieldrin
Color	Bis (2-Chloroethyl) Ether	Chloroform	α-Endosulfan
Fecal Coliform	Bis (2-Chloroisopropyl) Ether	Dichlorobromomethane	β-Endosulfan
Flouride	Bis (2-Ethylhexyl) Phthalate	Dichlorodifluoromethane	Endosulfan Sulfate
Nitrate-Nitrite (as N)	4-Bromophenyl Phenyl Ether	1,1-Dichloroethane	Endrin
Nitrogen, Total Organic (as N)	Butyl Benzyl Phthalate	1,2-Dichloroethane	Endrin Aldehyde
Oil and Grease	2-Chloronaphthalene	1,1-Dichloroethylene	Heptachlor
Phosphorus (as P), Total	4-Chlorophenyl Phenyl Ether	1,2-Dichloropropane	Heptachlor Epoxide
Alpha, Total	Chrysene	1,3-Dichloropropylene	Toxaphene
Beta, Total	Dibenzo(a,h)Anthracene	Ethylbenzene	PCB-1242
Radium, Total	1,2-Dichlorobenzene	Methyl Bromide	PCB-1254
Radium 226, Total	1,3-Dichlorobenzene	Methyl Chloride	PCB-1221
Sulfate (as SO4)	1,4-Dichlorobenzene	Methylene Chloride	PCB-1232
Sulfide (as S)	3,3-Dichlorobenzidine	1,1,2,2-Tetrachloroethane	PCB-1248
Sulfite (as SO3)	Diethyl Phthalate	Tetrachloroethylene	PCB-1260
Surfactants	Dimethyl Phthalate	Toluene	PCB-1016
Aluminum, Total	Di-N-Butyl Phthalate	1,2-Trans-Dichloroethylene	
Barium, Total	2,4-Dinitrotoluene	1,1,1-Trichloroethane	
Boron, Total	2,6-Dinitrotoluene	1,1,2-Trichloroethane	
Cobalt, Total	Di-N-Octyl Phthalate	Trichloroethylene	
Iron, Total	1,2-Diphenylhydrazine	Trichlorofluoromethane	
Magnesium, Total	Fluoranthene	Vinyl Chloride	
Molybdenum, Total	Fluorene		
Manganese, Total	Hexachlorobenzene		
Tin, Total	Hexachlorobutadiene		
Titanium, Total	Hexachlorocyclopentadiene		Part A
Antimony, Total	Hexachloroethane		Part B
Arsenic, Total	Indeno(1,2,3-cd)Pyrene		Part C
Beryllium, Total	Isophorone		
Cadmium, Total	Naphthalene		
Chromium, Total	Nitrobenzene		
Copper, Total	N-Nitrosodimethylamine		
Lead, Total	N-Nitrosodi-N-Propylamine		
Mercury, Total	N-Nitrosodiphenylamine		
Nickel, Total	Phenanthrene		
Selenium, Total	Pyrene		
Silver, Total	1,2,4-Trichlorobenzene		
Pollutant	Acid		

2019 NPDES Permit Re-Application
 Sampling and Analysis Plan (SAP)
 July 2018

ATTACHMENT A - FORM 2C Analytes

Thallium, Total	2-Chlorophenol
Zinc, Total	2,4-Dichlorophenol
Cyanide, Total	2,4-Dimethylphenol
Phenols, Total	4,6-Dinitro-O-Cresol
	2,4-Dinitrophenol
	2-Nitrophenol
	4-Nitrophenol
	P-Chloro-M-Cresol
	Pentachlorophenol
	Phenol
	2,4,6-Trichlorophenol
	Dioxin
	2,3,7,8-Tetrachlorodibenzo-P-Dioxin

2019 NPDES Permit Re-Application
Sampling and Analysis Plan (SAP)
July 2018

ATTACHMENT B

**Tables Showing EPA Application Form 2C Pollutants Approved Methods,
Containers, Preservation, and Hold Times**

2019 NPDES Permit Re-Application
Sampling and Analysis Plan (SAP)
July 2018

TABLE 1
EPA APPLICATION FORM 2C – PART A POLLUTANTS

#	Code of Fed Regulations Pollutant	Approved Methods, Containers, Preservation, Holding Times including Notes/Citations from CFR				Max. Holding Time		
		EPA	Std method 18 th Ed.	ASTM	USGS		Container	Preservation
9	Biochemical Oxygen Demand Dissolved Oxygen Depletion	405.1	5210 B	-	I-1578-78 ^a	P, G	Cool, 4°C	48 hours
15	Chemical Oxygen Demand Titrimetric, or	410.1 410.2 410.3	5220 C -	D1252-88(A) -	I-3560-85 I-3562-85	P, G	Cool, 4°C, H ₂ SO ₄ to pH<2	28 days
42	Total Organic Carbon Spectrophotometric, manual or auto.	410.4	5220 D	D1252-88(B)	I-3561-85	P, G	Cool, 4°C, HCl or H ₂ SO ₄ or H ₃ PO ₄ to pH<2	28 days
55	Total Suspended Solids Residue-nonfilterable (TSS) CFR Definition Gravimetric, 103-105 ^c post washing of residue	415.1	5310 B, C, or D	D2579-93 (A or B)	-	P, G	Cool, 4°C	7 days
4	Ammonia (as N): Manual, distillation (at pH 9.5), ^e followed by: Nesslerization Titration Electrode Automated phenate	350.2 350.2 350.2 350.3 350.1	4500-NH ₃ B 4500-NH ₃ C 4500-NH ₃ E 4500-NH ₃ F or G 4500-NH ₃ H	- D1426-93(A) - D1426-93(B)	I-3765-85 I-3520-85 -	P, G	Cool, 4°C, H ₂ SO ₄ to pH<2	28 days
69	Temperature (winter) Thermometric	170.1	2550 B	-	-	P, G	None required	Analyze
69	Temperature (summer) Thermometric	170.1	2550 B	-	-	P, G	None required	Analyze
28	pH Hydrogen ion CFR Definition Electrometric measurement	150.1	4500-H ⁺ B	D1293-84(90)(A or B)	I-1586-85	P, G	None required	Analyze immediately

Numbers from Code of Federal Regulations Table 1B (Inorganic)

2019 NPDES Permit Re-Application
Sampling and Analysis Plan (SAP)
July 2018

TABLE 2
EPA APPLICATION FORM 2C - PART B POLLUTANTS

Code of Fed Regulations	#	Pollutant	Approved Methods, Containers, Preservation, Holding Times including Notes/Citations from CFR					Max.	
			EPA	Std method 18 th Ed.	ASTM	USGS	Container		Preservation
	11	Bromide					P, G	None Required	28 days
		Titrimetric	320.1		D1246-82(88)(C)	-			
	17	Chlorine, Total Residual					P, G	None Required	28 days
		Titrimetric:							
		Amperometric direct	330.1	4500-CI D	D1253-86(92)	-			
		Iodometric direct	330.3	4500-CI B	-	-			
		Back titration ether end-point ⁵ or	330.2	4500-CI C	-	-			
		DPD-FAS	330.4	4500-CI F	-	-			
		Spectrophotometric, DPD	330.5	4500-CI G	-	-			
	21	Color					P, G	Cool, 4°C	48 hours
		CFR definition: color platinum cobalt units or dominant wavelength, hue, luminance purity:							
		Colorimetric (ADMI), or	110.1	2120 E	-	-			
		(Platinum cobalt), or	110.2	2120 B	-	I-1250-85			
		Spectrophotometric	110.3	2120 C	-	-			
		Fecal Coliform							
	1*	number per 100 mL					P, G	Cool, 4°C, 0.008% Na ₂ S ₂ O ₃ ⁵	6 hours
		Most Probable Number (MPN), 5 tube, 3 dilution	p. 132	9221C and E	-	-			
		Membran filter (MF) ⁴ , single step	p. 124	9222D	-	B-0050-85			
	2*	in presence of chlorine, number per 100 mL					P, G	Cool, 4°C, 0.008% Na ₂ S ₂ O ₃ ⁵	6 hours
		MPN, 5 tube, 3 dilution	p. 132	9221C and E	-	-			
		MF ⁴ , single step ⁵	p. 124	9222D	-	-			
	25	Flouride					P	None Required	28 days
		Manual distillation ⁶ followed by:							
		Electrode, manual or	340.2	4500-F C	D1179-93(B)	-			
		Automated	-	-	-	I-4327-85			
		Colorimetric (SPADNS)	340.1	4500-F D	D1179-93(A)	-			
		Or Automated complexone	340.3	4500-F E	-	-			

* Numbers from Code of Federal Regulations Table IA (Biological)
 † Numbers from Code of Federal Regulations Table IE (Radiologic)
 ‡ All other CFR numbers from Table IB (Inorganic)
 § Methods in **BOLD** indicate the method currently used for NPDES permit test procedures.

2019 NPDES Permit Re-Application
Sampling and Analysis Plan (SAP)
July 2018

TABLE 2
EPA APPLICATION FORM 2C - PART B POLLUTANTS

Code of Fed Regulations	#	Pollutant	Approved Methods, Containers, Preservation, Holding Times including Notes/Citations from CFR							Max. Holding Time
			EPA	Std method 18 th Ed.	ASTM	USGS	Container	Preservation		
39		Nitrate-Nitrite (as N)						P, G	Cool, 4°C, H ₂ SO ₄ to pH<2	28 days
		Cadmium reduction, Manual or Automated, or Automated hydrazine	353.3	4500-NO ₂ : E	D3867-90(B)	-				
			353.2	4500-NO ₂ : F	D3867-90(A)	I-4545-85				
			353.1	4500-NO ₂ : H	-	-				
43		Nitrogen, Total Organic (as N)						P, G	Cool, 4°C, H ₂ SO ₄ to pH<2	28 days
		Total Kjeldahl N (Parameter 31)						P, G	Cool, 4°C, H ₂ SO ₄ to pH<2	28 days
		Digestion and distillation followed by:	351.3	4500-NH ₃ B or C	D3590-89(A)	-				
		Titration	351.3	4500-NH ₃ E	D3590-89(A)	-				
		Nesslerization	351.3	4500-NH ₃ C	D3590-89(A)	-				
		Electrode	351.3	4500-NH ₃ F or G	-	-				
		Automated phenate colorimetric	351.1	-	-	I-4551-78 ^a				
		Semi-automated block digester colorimetric, or Manual or block digester Potentiometric	351.2	-	D3590-89(B)	-				
			351.4	-	D3590-89(A)	-				
		minus ammonia N (Parameter 4)					P, G	Cool, 4°C, H ₂ SO ₄ to pH<2	28 days	
41		Manual, distillation (at pH 9.5), ^b followed by:	350.2	4500-NH ₃ B	-	-				
		Nesslerization	350.2	4500-NH ₃ C	D1426-93(A)	I-3520-85				
		Titration	350.2	4500-NH ₃ E	-	-				
		Electrode	350.3	4500-NH ₃ F or G	D1426-93(B)	-				
		Automated phenate	350.1	4500-NH ₃ H	-	I-4523-85				
		Oil and Grease					G	Cool, 4°C, HCl or H ₂ SO ₄ to pH<2	28 days	
50		Gravimetric (extraction)	413.1	5520 B ³⁸	-	-				
		Phosphorus (as P), Total					P, G	Cool, 4°C, H ₂ SO ₄ to pH<2	28 days	
		Persulfate digestion followed by:	365.2	4500-P B.5	-	-				
		Manual or	365.2 or	4500-P E	D515-88(A)	-				
			365.3	-	-	-				
		Automated ascorbic acid reduction	365.1	4500-P F	-	-				
	Semi-automated block digester	365.4	-	D515-88(B)	-					

* Numbers from Code of Federal Regulations Table IA (Biological)
 † Numbers from Code of Federal Regulations Table IE (Radiologic)
 All other CFR numbers from Table IB (Inorganic)
 Methods in **BOLD** indicate the method currently used for NPDES permit test procedures.

2019 NPDES Permit Re-Application
Sampling and Analysis Plan (SAP)
July 2018

TABLE 2
EPA APPLICATION FORM 2C – PART B POLLUTANTS

Code of Fed Regulations		Approved Methods, Containers, Preservation, Holding Times including Notes/Citations from CFR							Max.
#	Pollutant	EPA	Std method 18 th Ed.	ASTM	USGS	Container	Preservation	Holding Time	
1	Alpha, Total	900	7110 B	D1843-90	pp. 75 and 78. ³	P, G	HNO ₃ to pH<2	6 months	
	Proportional or scintillation counter								
3	Beta, Total	900	7110 B	D1890-90	pp. 75 and 78. ³	P, G	HNO ₃ to pH<2	6 months	
	Proportional counter								
5a	Radium, Total	903.0	7500Ra B	D2460-90	-	P, G	HNO ₃ to pH<2	6 months	
	Proportional counter								
5b	Radium 226, Total	903.1	7500Ra C	D3454-91	p.81	P, G	HNO ₃ to pH<2	6 months	
	Scintillation counter								
65	Sulfate (as SO ₄)					P, G	Cool, 4°C	28 days	
	Automated colorimetric (barium chloranilate)	375.1	-	-	-				
	Gravimetric	375.3	4500-SO ₄ ²⁻ C or D	-	-				
	Turbidimetric	375.4	-	D516-90	-				
66	Sulfide (as S)					P, G	Cool, 4°C add zinc acetate plus sodium hydroxide to pH>9	7 days	
	Titrimetric (iodine), or	376.1	4500-S ²⁻ E	-	I-3840-85				
	Colorimetric (methylene blue)	376.2	4500-S ²⁻ D	-	-				
67	Sulfite (as SO ₃)					P, G	None required	Analyze immediately	
	Titrimetric (iodine-iodate) (other methods)	377.1	4500-SO ₃ ²⁻ B	-	-				
68	Surfactants	425.1	5540 C	D2330-88	-	P, G	Cool, 4°C	48 hours	
	Colorimetric (methylene blue)					P, G	HNO ₃ to pH<2	6 months	
3	Aluminum, Total								
	Digestion ^f followed by:								
	AA direct aspiration ^g	202.1	3111 D	-	I-3051-85				
	AA furnace	202.2	3113 B	-	-				
	ICP/AES ^h	5200.7	3120 B	-	-				
	DCP ^h	-	-	D4190-82(88)	-				
	Colorimetric (Eriochrome cyanide R)	-	3500-AI D	-	-	P, G	HNO ₃ to pH<2	6 months	
7	Barium, Total								

* Numbers from Code of Federal Regulations Table IA (Biological)
 † Numbers from Code of Federal Regulations Table IE (Radiologic)
 ‡ All other CFR numbers from Table IB (Inorganic)
 § Methods in **BOLD** indicate the method currently used for NPDES permit test procedures.

2019 NPDES Permit Re-Application
Sampling and Analysis Plan (SAP)
July 2018

TABLE 2
EPA APPLICATION FORM 2C – PART B POLLUTANTS

#	Pollutant	Approved Methods, Containers, Preservation, Holding Times including Notes/Citations from							Max. Holding Time
		Code of Fed Regulations CFR	EPA	Std method 18 th Ed.	ASTM	USGS	Container	Preservation	
	Digestion ⁴ followed by:								
	AA direct aspiration ³⁶		208.1	3111 D	-	I-3084-85			
	AA furnace		208.2	3113 B	D4382-91	-			
	ICP/AES ³⁶		5200.7	3120 B	-	-			
10	Boron, Total						P,PfTE, or Quartz	HNO ₃ to pH<2	6 months
	Colorimetric (curcumin)		212.3	4500-B B	-	I-3112-85			
	ICP/AES, or		5200.7	3120 B	-	-			
	DCP		-	-	D4190-82(88)	-			
20	Cobalt, Total						P,G	HNO ₃ to pH<2	6 months
	Digestion ⁴ followed by:								
	AA direct aspiration		219.1	3111 B or C	D3558-90(A or B)	I-3239-85			
	AA furnace		219.2	3113 B	D3558-90(C)	-			
	ICP/AES		5200.7	3120 B	-	-			
	DCP		-	-	D4190-82(88)	-			
30	Iron, Total						P,G	HNO ₃ to pH<2	6 months
	Digestion ⁴ followed by:								
	AA direct aspiration ³⁶		236.1	3111 B or C	D1068-90(A or B)	I-3381-85			
	AA furnace		236.2	3113 B	D1068-90(C)	-			
	ICP/AES ³⁶		5200.7	3120 B	-	-			
	DCP ³⁶ or		-	-	D4190-82(88)	-			
	Colorimetric (Phenanthroline)		-	3500-Fe D	D1068-90(D)	-			
33	Magnesium, Total						P,G	HNO ₃ to pH<2	6 months
	Digestion ⁴ followed by:								
	AA direct aspiration		242.1	3111 B	D511-93(B)	I-3447-85			
	ICP/AES		5200.7	3120 B	-	-			
	Gravimetric		-	3500-Mg D	-	-			
36	Molybdenum, Total						P,G	HNO ₃ to pH<2	6 months
	Digestion ⁴ followed by:								

* Numbers from Code of Federal Regulations Table IA (Biological)
 † Numbers from Code of Federal Regulations Table IE (Radiologic)
 ‡ All other CFR numbers from Table IB (Inorganic)
 § Methods in **BOLD** indicate the method currently used for NPDES permit test procedures.

2019 NPDES Permit Re-Application
Sampling and Analysis Plan (SAP)
July 2018

**TABLE 2
EPA APPLICATION FORM 2C – PART B POLLUTANTS**

Code of Fed Regulations		Approved Methods, Containers, Preservation, Holding Times including Notes/Citations from Max.						
#	Pollutant	EPA CFR	Std method 18 th Ed.	ASTM	USGS	Container	Preservation	Holding Time
	AA direct aspiration	246.1	3111 D	-	I-3490-85			
	AA furnace	246.2	3113 B	-	-			
	ICP/AES	*200.7	3120 B	-	-			
34	Manganese, Total					P,G	HNO ₃ to pH<2	6 months
	Digestion ⁴ followed by:							
	AA direct aspiration ^{5b}	243.1	3111 B	D858-90(A or B)	I-3464-85			
	AA furnace	243.2	3113 B	D858-90(C)	-			
	ICP/AES ^{5c}	*200.7	3120 B	-	-			
	DCP ³ or	-	-	D4190-82(88)	-			
	Colorimetric (Persulfate)	-	3500-Mn D	-	-			
71	Tin, Total					P,G	HNO ₃ to pH<2	6 months
	Digestion ⁴ followed by:							
	AA direct aspiration	282.1	3111 B	-	I-3850-78 ⁹			
	AA furnace, or	282.2	3113 B	-	-			
	ICP/AES	*200.7	-	-	-			
72	Titanium, Total					P,G	HNO ₃ to pH<2	6 months
	Digestion ⁴ followed by:							
	AA direct aspiration	283.1	3111 D	-	-			
	AA furnace	283.2	-	-	-			

* Numbers from Code of Federal Regulations Table IA (Biological)

◇ Numbers from Code of Federal Regulations Table IE (Radiologic)

All other CFR numbers from Table IB (Inorganic)

Methods in **BOLD** indicate the method currently used for NPDES permit test procedures.

* Numbers from Code of Federal Regulations Table IA (Biological)

◇ Numbers from Code of Federal Regulations Table IE (Radiologic)

All other CFR numbers from Table IB (Inorganic)

Methods in **BOLD** indicate the method currently used for NPDES permit test procedures.

2019 NPDES Permit Re-Application
Sampling and Analysis Plan (SAP)
July 2018

TABLE 3
EPA APPLICATION FORM 2C – PART C POLLUTANTS
METALS, CYANIDE, AND PHENOLS

Code of Fed Regulations #	Base/Neutral	GEL	Approved Methods, Containers, Preservation, Holding Times including Notes/Citations from CFR			Max. Holding Time				
			EPA: GC	EPA:GC/MS	HPLC		ASTM	Container	Preservation	
1	Acenaphthene	Acenaphthene	610	625, 1625	610	6410 B, 6440 B	D4657-92	G, Teflon-lined cap	Cool, 4°C, 0.008% Na ₂ S ₂ O ₅ ⁵ store in dark	7 days until extraction;
2	Acenaphthylene	Acenaphthylene	610	625, 1625	610	6410 B, 6440 B	D4657-92	G, Teflon-lined cap	Cool, 4°C, 0.008% Na ₂ S ₂ O ₅ ⁵ store in dark	40 days after extraction;
5	Anthracene	Anthracene	610	625, 1625	610	6410 B, 6440 B	D4657-92	G, Teflon-lined cap	Cool, 4°C, 0.008% Na ₂ S ₂ O ₅ ⁵ store in dark	7 days until extraction;
7	Benzidine	Benzidine	-	5625, 1625	605	-	-	G, Teflon-lined cap	Cool, 4°C, 0.008% Na ₂ S ₂ O ₅ ⁵	40 days after extraction.
8	Benzo(a)Anthracene	Benzo(a)Anthracene	610	625, 1625	610	6410 B, 6440 B	D4657-92	G, Teflon-lined cap	Cool, 4°C, 0.008% Na ₂ S ₂ O ₅ ⁵ store in dark	7 days until extraction ¹³
9	Benzo(a)Pyrene	Benzo(a)Pyrene	610	625, 1625	610	6410 B, 6440 B	D4657-92	G, Teflon-lined cap	Cool, 4°C, 0.008% Na ₂ S ₂ O ₅ ⁵ store in dark	7 days until extraction;
10	3,4-Benzofluoranthrene	Benzo(b)Fluoranthene	610	625, 1625	610	6410 B, 6440 B	D4657-92	G, Teflon-lined cap	Cool, 4°C, 0.008% Na ₂ S ₂ O ₅ ⁵ store in dark	40 days after extraction.
11	Benzo(ghi)Perylene	Benzo(ghi)Perylene	610	625, 1625	610	6410 B, 6440 B	D4657-92	G, Teflon-lined cap	Cool, 4°C, 0.008% Na ₂ S ₂ O ₅ ⁵ store in dark	7 days until extraction;
12	Benzo(k)Fluoranthene	Benzo(k)Fluoranthene	610	625, 1625	610	6410 B, 6440 B	D4657-92	G, Teflon-lined cap	Cool, 4°C, 0.008% Na ₂ S ₂ O ₅ ⁵ store in dark	40 days after extraction.
15	Bis (2-Chloroethoxy) Methane	Bis (2-Chloroethoxy) Methane	611	625, 1625	-	6410 B	-	G, Teflon-lined cap	Cool, 4°C, 0.008% Na ₂ S ₂ O ₅ ⁵	40 days after extraction.
16	Bis (2-Chloroethyl) Ether	Bis (2-Chloroethyl) Ether	611	625, 1625	-	6410 B	-	G, Teflon-lined cap	Cool, 4°C, 0.008% Na ₂ S ₂ O ₅ ⁵	7 days until extraction;
75	Bis (2-Chloroisopropyl) Ether	2,2-oxylbis(1-Chloropropane)	611	625, 1625	-	6410 B	-	G, Teflon-lined cap	Cool, 4°C, 0.008% Na ₂ S ₂ O ₅ ⁵	40 days after extraction.
17	Bis (2-Ethylhexyl) Phthalate	Bis (2-Ethylhexyl) Phthalate	606	625, 1625	-	6410 B, 6230 B	-	G, Teflon-lined cap	Cool, 4°C	40 days after extraction;
21	4-Bromophenyl Phenyl Ether	4-Bromophenyl-phenyl Ether	611	625, 1625	-	6410 B	-	G, Teflon-lined cap	Cool, 4°C, 0.008% Na ₂ S ₂ O ₅ ⁵	7 days until extraction;
14	Butyl Benzyl Phthalate	Butylbenzylphthalate	606	625, 1625	-	6410 B	-	G, Teflon-lined cap	Cool, 4°C	40 days after extraction.

Numbers from Code of Federal Regulations Table IC (Non-Pesticide Organic Compounds) Methods in **BOLD** indicate the method currently used for NPDES permit test procedures.

2019 NPDES Permit Re-Application
Sampling and Analysis Plan (SAP)
July 2018

TABLE 3
EPA APPLICATION FORM 2C – PART C POLLUTANTS
METALS, CYANIDE, AND PHENOLS

#	Code of Fed Regulations Base/Neutral	GEL	Approved Methods, Containers, Preservation, Holding Times including Notes/Citations from CFR		ASTM	Container	Preservation	Max. Holding Time	
			EPA: GC	EPA: GC/MS					HPLC
29	Benzyl butyl phthalate	2-Chloronaphthalene	612	625,1625	-	G, Teflon-lined cap	Cool, 4°C	40 days after extraction; 7 days until extraction;	
31	4-Chlorophenyl Phenyl Ether	4-Chlorophenyl-phenyl Ether	611	625,1625	-	G, Teflon-lined cap	Cool, 4°C, 0.008% Na ₂ S ₂ O ₅ ⁵	40 days after extraction; 7 days until extraction;	
32	Chrysene	Chrysene	610	625,1625	610	G, Teflon-lined cap	Cool, 4°C, 0.008% Na ₂ S ₂ O ₅ ⁵ store in dark	40 days after extraction; 7 days until extraction;	
33	Dibenzo(a,h)Anthracene	Dibenzo(a,h)Anthracene	610	625,1625	610	G, Teflon-lined cap	Cool, 4°C, 0.008% Na ₂ S ₂ O ₅ ⁵ store in dark	40 days after extraction; 7 days until extraction;	
#	Base/Neutral	GEL	GC	GC/MS	HPLC	Std method 18 th Ed.	Container	Preservation	Holding Time
35	1,2-Dichlorobenzene	1,2-Dichlorobenzene	601,602,612	624,625,1625	-	6410 B, 6230 B, 6220 B	G, Teflon-lined cap	Cool, 4°C	7 days until extraction; 40 days after extraction;
36	1,3-Dichlorobenzene	1,3-Dichlorobenzene	601,602,612	624,625,1625	-	6410 B, 6230 B, 6220 B	G, Teflon-lined septum G, Teflon-lined cap	Cool, 4°C, 0.008% Na ₂ S ₂ O ₅ ⁵ Cool, 4°C	14 days 7 days until extraction;
37	1,4-Dichlorobenzene	1,4-Dichlorobenzene	601,602,612	624,625,1625	-	6410 B, 6220 B, 6230 B	G, Teflon-lined septum G, Teflon-lined cap	Cool, 4°C, 0.008% Na ₂ S ₂ O ₅ ⁵ Cool, 4°C	14 days 7 days until extraction;
38	3,3-Dichlorobenzidine	3,3-Dichlorobenzidine	-	625,1625	605	6410 B	G, Teflon-lined cap	Cool, 4°C, 0.008% Na ₂ S ₂ O ₅ ⁵	7 days until extraction; ¹³
48	Diethyl Phthalate	Diethylphthalate	606	625,1625	-	6410 B	G, Teflon-lined cap	Cool, 4°C	7 days until extraction;
50	Dimethyl Phthalate	Dimethyl Phthalate	606	625,1625	-	6410 B	G, Teflon-lined cap	Cool, 4°C	40 days after extraction;
51	Di-n-Butyl Phthalate	Di-n-Butylphthalate	606	625,1625	-	6410 B	G, Teflon-lined cap	Cool, 4°C	40 days after extraction;
54	2,4-Dinitrotoluene	2,4-Dinitrotoluene	609	625,1625	-	6410 B	G, Teflon-lined cap	Cool, 4°C, 0.008% Na ₂ S ₂ O ₅ ⁵ store in dark	7 days until extraction;
55	2,6-Dinitrotoluene	2,6-Dinitrotoluene	609	625,1625	-	6410 B	G, Teflon-lined cap	Cool, 4°C, 0.008% Na ₂ S ₂ O ₅ ⁵ store in dark	40 days after extraction; 7 days until extraction;

Numbers from Code of Federal Regulations Table IC (Non-Pesticide Organic Compounds)
Methods in **BOLD** indicate the method currently used for NPDES permit test procedures.

2019 NPDES Permit Re-Application
Sampling and Analysis Plan (SAP)
July 2018

TABLE 3
EPA APPLICATION FORM 2C – PART C POLLUTANTS
METALS, CYANIDE, AND PHENOLS

#	Code of Fed Regulations Base/Neutral	GEL	Approved Methods, Containers, Preservation, Holding Times including Notes/Citations from CFR				Max. Holding Time			
			EPA: GC	EPA: GC/MS	HPLC	Std method 18 th Ed.		ASTM	Container	Preservation
52	Di-N-Octyl Phthalate	Di-n-Octyl Phthalate	606	625, 1625	-	6410 B	-	G, Teflon-lined cap	Cool, 4°C	40 days after extraction; 7 days until extraction;
-	1,2-Diphenylhydrazine	Azobenzene		625, 1625*						40 days after extraction.
* Method 625 is used by GEL, but is not listed as an approved method in CFR. Method 1625 is an appropriate method as listed in summary of methods in App. A of CFR.										
58	Fluoranthene	Fluoranthene	610	625, 1625	610	6410 B, 6440 B	D4657-92	G, Teflon-lined cap	Cool, 4°C, 0.008% Na ₂ S ₂ O ₃ ⁵ store in dark	7 days until extraction;
59	Fluorene	Fluorene	610	625, 1625	610	6410 B, 6440 B	D4657-92	G, Teflon-lined cap	Cool, 4°C, 0.008% Na ₂ S ₂ O ₃ ⁵ store in dark	40 days after extraction; 7 days until extraction;
60	Hexachlorobenzene	Hexachlorobenzene	612	625, 1625	-	6410 B	-	G, Teflon-lined cap	Cool, 4°C	40 days after extraction; 7 days until extraction;
61	Hexachlorobutadiene	Hexachlorobutadiene	612	625, 1625	-	6410 B	-	G, Teflon-lined cap	Cool, 4°C	40 days after extraction; 7 days until extraction;
62	Hexachlorocyclopentadiene	Hexachlorocyclopentadiene	612	625, 1625	-	6410 B	-	G, Teflon-lined cap	Cool, 4°C	40 days after extraction; 7 days until extraction;
63	Hexachloroethane	Hexachloroethane	616	625, 1625	-	6410 B	-	G, Teflon-lined cap	Cool, 4°C	40 days after extraction; 7 days until extraction;
64	Indeno(1,2,3-cd)Pyrene	Indeno(1,2,3-cd)Pyrene	610	625, 1625	610	6410 B, 6440 B	D4657-92	G, Teflon-lined cap	Cool, 4°C, 0.008% Na ₂ S ₂ O ₃ ⁵ store in dark	40 days after extraction;
65	Isophorone	Isophorone	609	625, 1625	-	6410 B	-	G, Teflon-lined cap	Cool, 4°C, 0.008% Na ₂ S ₂ O ₃ ⁵ store in dark	40 days after extraction; 7 days until extraction;
68	Naphthalene	Naphthalene	610	625, 1625	610	6410 B, 6440 B	-	G, Teflon-lined cap	Cool, 4°C, 0.008% Na ₂ S ₂ O ₃ ⁵ store in dark	40 days after extraction;
69	Nitrobenzene	Nitrobenzene	609	625, 1625	-	6410 B	-	G, Teflon-lined cap	Cool, 4°C, 0.008% Na ₂ S ₂ O ₃ ⁵ store in dark	40 days after extraction; 7 days until extraction;
72	N-Nitrosodimethylamine	N-Nitrosodimethylamine	607	625, 1625	-	6410 B	-	G, Teflon-lined cap	Cool, 4°C, store in dark, 0.008% Na ₂ S ₂ O ₃ ⁵	7 days until extraction;
73	N-Nitrosodi-N-Propylamine	N-Nitrosodi-N-Propylamine	607	625, 1625	-	6410 B	-	G, Teflon-lined cap	Cool, 4°C, store in dark, 0.008% Na ₂ S ₂ O ₃ ⁵	40 days after extraction;
74	N-Nitrosodiphenylamine	N-Nitrosodiphenylamine	607	625, 1625	-	6410 B	-	G, Teflon-lined cap	Cool, 4°C, store in dark, 0.008% Na ₂ S ₂ O ₃ ⁵	7 days until extraction; 40 days after extraction;

Numbers from Code of Federal Regulations Table IC (Non-Pesticide Organic Compounds) Methods in **BOLD** indicate the method currently used for NPDES permit test procedures.

2019 NPDES Permit Re-Application
Sampling and Analysis Plan (SAP)
July 2018

TABLE 3
EPA APPLICATION FORM 2C – PART C POLLUTANTS
METALS, CYANIDE, AND PHENOLS

Code of Fed Regulations #	Base/Neutral	GEL	Approved Methods		HPLC	Std method 18 th Ed.	ASTM	Container	Notes/Citations from CFR		Max. Holding Time
			EPA: GC	EPA:GC/MS					Preservation		
84	Phenanthrene	Phenanthrene	610	625 ,1625	610	6410 B,6440 B	D4657-92	G, Teflon-lined cap	Cool,4°C,0.008% Na ₂ S ₂ O ₃ ⁵ store in dark	40 days after extraction; 7 days until extraction;	
86	Pyrene	Pyrene	610	625 ,1625	610	6410 B,6440 B	D4675-92	G, Teflon-lined cap	Cool,4°C,0.008% Na ₂ S ₂ O ₃ ⁵ store in dark	40 days after extraction; 7 days until extraction;	
91	1,2,4-Trichlorobenzene	1,2,4-Trichlorobenzene	612	625 ,1625	-	6410 B	-	G, Teflon-lined cap	Cool,4°C	40 days after extraction; 7 days until extraction; 40 days after extraction.	

Numbers from Code of Federal Regulations Table IC (Non-Pesticide Organic Compounds)
Methods in **BOLD** indicate the method currently used for NPDES permit test procedures.

2019 NPDES Permit Re-Application
Sampling and Analysis Plan (SAP)
July 2018

TABLE 4
EPA APPLICATION FORM 2C – PART C POLLUTANTS
DIOXIN

Code of Fed Regulations	Approved Methods, Containers, Preservation, Holding Times including Notes/Citations from CFR						Max. Holding Time			
	GEL	GC	GC/MS	HPLC	Std method 18 th Ed.	ASTM		Container	Preservation	
#	Dioxin									
87	2,3,7,8-Tetrachlorodibenzo-P-Dioxin			5613				G, Teflon-lined cap	Cool, 4°C, 0.008% Na ₂ S ₂ O ₅ ⁵	7 days until extraction;
										40 days after extraction.

Numbers from Code of Federal Regulations Table IC, (Non-Pesticide Organic Compounds)
 Methods in **BOLD** indicate the method currently used for NPDES permit test procedures.

2019 NPDES Permit Re-Application
Sampling and Analysis Plan (SAP)
July 2018

TABLE 5
EPA APPLICATION FORM 2C – PART C POLLUTANTS
GC/MS FRACTION – VOLATILE COMPOUNDS

Code of Fed Regulations	#	Volatile	GEL	Approved Methods, Containers, Preservation, Holding Times including Notes/Citations from CFR			Max. Holding Time			
				EPA, GC	EPA: GC/MS	HPLC Std method 18 th Ed.		ASTM	Container	Preservation
	3	Acrolein	Acrolein	603	624, 1624	-	-	G, Teflon-lined septum	Cool, 4°C, 0.008% Na ₂ S ₂ O ₅ , Adjust pH to 4-5	14 days
	4	Acrylonitrile	Acrylonitrile	603	624, 1624	610	-	G, Teflon-lined septum	Cool, 4°C, 0.008% Na ₂ S ₂ O ₅ , Adjust pH to 4-5	14 days
	6	Benzene	Benzene	602	624, 1624	-	6210 B, 6220 B	G, Teflon-lined septum	Cool, 4°C, 0.008% Na ₂ S ₂ O ₅ , HCl to pH2 ⁹	14 days
	-	Bis (Chloro-methyl) Ether	-	-	-	-	-	-	-	-
	19	Bromoform	Bromoform	601	624, 1624	-	6210 B, 6230 B	G, Teflon-lined septum	Cool, 4°C, 0.008% Na ₂ S ₂ O ₅	14 days
	22	Carbon Tetrachloride	Carbon Tetrachloride	601	624, 1624	-	6230 B, 6410 B	G, Teflon-lined septum	Cool, 4°C, 0.008% Na ₂ S ₂ O ₅	14 days
	24	Chlorobenzene	Chlorobenzene	601, 602	624, 1624	-	6210 B, 6220 B, 6230 B	G, Teflon-lined septum	Cool, 4°C, 0.008% Na ₂ S ₂ O ₅	14 days
	34	Chlorodibromomethane	Dibromochloromethane	601	624, 1624	-	6210 B, 6230 B	G, Teflon-lined septum	Cool, 4°C, 0.008% Na ₂ S ₂ O ₅	14 days
	25	Chloroethane	Chloroethane	601	624, 1624	-	6210 B, 6230 B	G, Teflon-lined septum	Cool, 4°C, 0.008% Na ₂ S ₂ O ₅	14 days
	26	2-Chloroethylvinyl Ether	2-Chloroethylvinyl Ether	601	624, 1624	-	6210 B, 6230 B	G, Teflon-lined septum	Cool, 4°C, 0.008% Na ₂ S ₂ O ₅	14 days
	27	Chloroform	Chloroform	601	624, 1624	-	6210 B, 6230 B	G, Teflon-lined septum	Cool, 4°C, 0.008% Na ₂ S ₂ O ₅	14 days
	18	Dichlorobromomethane	Bromodichloromethane	601	624, 1624	-	6230 B	G, Teflon-lined septum	Cool, 4°C, 0.008% Na ₂ S ₂ O ₅	14 days
	39	Dichlorodifluoromethane	-	601	-	-	-	-	-	-
	40	1,1-Dichloroethane	1,1-Dichloroethane	601	624, 1624	-	6230 B, 6210 B	G, Teflon-lined septum	Cool, 4°C, 0.008% Na ₂ S ₂ O ₅	14 days
	41	1,2-Dichloroethane	1,2-Dichloroethane	601	624, 1624	-	6230 B, 6210 B	G, Teflon-lined septum	Cool, 4°C, 0.008% Na ₂ S ₂ O ₅	14 days
	42	1,1-Dichloroethylene	1,1-Dichloroethylene	601	624, 1624	-	6230 B, 6210 B	G, Teflon-lined septum	Cool, 4°C, 0.008% Na ₂ S ₂ O ₅	14 days
	45	1,2-Dichloropropane	1,2-Dichloropropane	601	624, 1624	-	6230 B, 6210 B	G, Teflon-lined septum	Cool, 4°C, 0.008% Na ₂ S ₂ O ₅	14 days
	46	1,3-Dichloropropylene	dis-1,3-Dichloropropene	601	624, 1624	-	6230 B, 6210 B	G, Teflon-lined septum	Cool, 4°C, 0.008% Na ₂ S ₂ O ₅	14 days
	47		trans-1,3-Dichloropropene	601	624, 1624	-	6230 B, 6210 B	G, Teflon-lined septum	Cool, 4°C, 0.008% Na ₂ S ₂ O ₅	14 days
	57	Ethylbenzene	Dichloropropene	602	624, 1624	-	6220 B, 6210B	G, Teflon-lined septum	Cool, 4°C, 0.008% Na ₂ S ₂ O ₅ , HCl to pH 2 ⁹	14 days
	20	Methyl Bromide	Ethylbenzene	601	624, 1624	-	6210 B, 6230 B	G, Teflon-lined septum	Cool, 4°C, 0.008% Na ₂ S ₂ O ₅	14 days
	28	Methyl Chloride	Bromomethane	601	624, 1624	-	6210 B, 6230 B	G, Teflon-lined septum	Cool, 4°C, 0.008% Na ₂ S ₂ O ₅	14 days
	66	Methylene Chloride	Chloromethane	601	624, 1624	-	6230 B	G, Teflon-lined septum	Cool, 4°C, 0.008% Na ₂ S ₂ O ₅	14 days
	88	1,1,2,2-Tetrachloroethane	Methylene Chloride	601	624, 1624	-	6230 B, 6210 B	G, Teflon-lined septum	Cool, 4°C, 0.008% Na ₂ S ₂ O ₅	14 days
	89	Tetrachloroethylene	1,1,2,2-Tetrachloroethane	601	624, 1624	-	6230 B, 6210 B	G, Teflon-lined septum	Cool, 4°C, 0.008% Na ₂ S ₂ O ₅	14 days
	90	Toluene	Tetrachloroethane	601	624, 1624	-	6230 B, 6210 B	G, Teflon-lined septum	Cool, 4°C, 0.008% Na ₂ S ₂ O ₅	14 days
	43	1,2-Trans-Dichloroethylene	Toluene	602	624, 1624	-	6210 B, 6220 B	G, Teflon-lined septum	Cool, 4°C, 0.008% Na ₂ S ₂ O ₅ , HCl to pH 2 ⁹	14 days
	92	1,1,1-Trichloroethane	trans-1,2-Dichloroethene	601	624, 1624	-	6230 B, 6210 B	G, Teflon-lined septum	Cool, 4°C, 0.008% Na ₂ S ₂ O ₅	14 days
	93	1,1,2-Trichloroethane	1,1,1-Trichloroethane	601	624, 1624	-	6210 B, 6230 B	G, Teflon-lined septum	Cool, 4°C, 0.008% Na ₂ S ₂ O ₅	14 days
	94	Trichloroethylene	1,1,2-Trichloroethane	601	624, 1624	-	6210 B, 6230 B	G, Teflon-lined septum	Cool, 4°C, 0.008% Na ₂ S ₂ O ₅	14 days
			Trichloroethene	601	624, 1624	-	6210 B, 6230 B	G, Teflon-lined septum	Cool, 4°C, 0.008% Na ₂ S ₂ O ₅	14 days

Numbers from Code of Federal Regulations Table IC (Non-Pesticide Organic Compounds)
Methods in **BOLD** indicate the method currently used for NPDES permit test procedures.

2019 NPDES Permit Re-Application
Sampling and Analysis Plan (SAP)
July 2018

TABLE 5
EPA APPLICATION FORM 2C – PART C POLLUTANTS
GC/MS FRACTION – VOLATILE COMPOUNDS

Code of Fed Regulations	GEL	Approved Methods, Containers, Preservation, Holding Times including Notes/Citations from CFR					Max. Holding Time		
		EPA: GC	EPA: GC/MS	HPLC	Std method 18 th Ed.	ASTM		Container	Preservation
95	Trichlorofluoromethane (extra)	601	624	-	6210 B, 6230 B	-	G, Teflon-lined septum	Cool, 4°C, 0.008% Na ₂ S ₂ O ₃ §	14 days
97	Vinyl Chloride	601	624, 1624	-	6210 B, 6230 B	-	G, Teflon-lined septum	Cool, 4°C, 0.008% Na ₂ S ₂ O ₃ §	14 days

Numbers from Code of Federal Regulations Table IC (Non-Pesticide Organic Compounds)
Methods in **BOLD** indicate the method currently used for NPDES permit test procedures.

2019 NPDES Permit Re-Application
Sampling and Analysis Plan (SAP)
July 2018

TABLE 6
EPA APPLICATION FORM 2C – PART C POLLUTANTS
GC/MS FRACTION – ACID COMPOUNDS

Code of Fed Regulations		Approved Methods, Containers, Preservation, Holding Times including Notes/Citations from CFR							Max. Holding Time	
#	Acid	GC	GC/MS	HPLC	Std method	18 th Ed.	ASTM	Container	Preservation	
30	2-Chlorophenol	604	625, 1625	-	6410 B, 6420 B	-	-	G, Teflon-lined cap	Cool, 4°C, 0.008% Na ₂ S ₂ O ₃ ⁵	7 days until extraction; 40 days after extraction.
44	2,4-Dichlorophenol	604	625, 1625	-	6420 B, 6410 B	-	-	G, Teflon-lined cap	Cool, 4°C, 0.008% Na ₂ S ₂ O ₃ ⁵	7 days until extraction; 40 days after extraction.
49	2,4-Dimethylphenol	604	625, 1625	-	6420 B, 6410 B	-	-	G, Teflon-lined cap	Cool, 4°C, 0.008% Na ₂ S ₂ O ₃ ⁵	7 days until extraction; 40 days after extraction.
67	4,6-Dinitro-O-Cresol	604	625, 1625	-	6420 B, 6410 B	-	-	G, Teflon-lined cap	Cool, 4°C, 0.008% Na ₂ S ₂ O ₃ ⁵	7 days until extraction; 40 days after extraction.
-	2,4-Dinitrophenol	604 *	625, 1625 *	-	-	-	-	G, Teflon-lined cap *	Cool, 4°C, 0.008% Na ₂ S ₂ O ₃ ⁵ *	*7 days until extraction; 40 days after extraction.
70	2-Nitrophenol	604	625, 1625	-	6410 B, 6420 B	-	-	G, Teflon-lined cap	Cool, 4°C, 0.008% Na ₂ S ₂ O ₃ ⁵	7 days until extraction; 40 days after extraction.
71	4-Nitrophenol	604	625, 1625	-	6410 B, 6420 B	-	-	G, Teflon-lined cap	Cool, 4°C, 0.008% Na ₂ S ₂ O ₃ ⁵	7 days until extraction; 40 days after extraction.
23	p-Chloro-m-Cresol	604	625, 1625	-	6410 B, 6420 B	-	-	G, Teflon-lined cap	Cool, 4°C, 0.008% Na ₂ S ₂ O ₃ ⁵	7 days until extraction; 40 days after extraction.
83	Pentachlorophenol	604	625, 1625	-	6410 B, 6630 B	-	-	G, Teflon-lined cap	Cool, 4°C, 0.008% Na ₂ S ₂ O ₃ ⁵	7 days until extraction; 40 days after extraction.
85	Phenol	604	625, 1625	-	6420 B, 6410 B	-	-	G, Teflon-lined cap	Cool, 4°C, 0.008% Na ₂ S ₂ O ₃ ⁵	7 days until extraction; 40 days after extraction.
96	2,4,6-Trichlorophenol	604	625, 1625	-	6410 B, 6240 B	-	-	G, Teflon-lined cap	Cool, 4°C, 0.008% Na ₂ S ₂ O ₃ ⁵	7 days until extraction; 40 days after extraction.

* Appropriate methods as listed in summaries of methods in App. A of CFR.
* Assumed from "Phenols group" listing in Table II

Numbers from Code of Federal Regulations Table IC (Non-Pesticide Organic Compounds)
Methods in BOLD indicate the method currently used for NPDES permit test procedures.

2019 NPDES Permit Re-Application
Sampling and Analysis Plan (SAP)
July 2018

TABLE 7
EPA APPLICATION FORM 2C – PART C POLLUTANTS
GC/MS FRACTION – BASE/NEUTRAL COMPOUNDS

Code of Fed Regulations		Approved Methods, Containers, Preservation, Holding Times including Notes/Citations from CFR										Max. Holding Time
#	Base/Neutral	GEL	EPA: GC	EPA: GC/MS	HPLC	Std method 18 th Ed.	ASTM	Container	Preservation			
1	Acenaphthene	Acenaphthene	610	625, 1625	610	6410 B, 6440 B	D4657-92	G, Teflon-lined cap	Cool, 4°C, 0.008% Na ₂ S ₂ O ₃ ⁵ store in dark		7 days until extraction;	
2	Acenaphthylene	Acenaphthylene	610	625, 1625	610	6410 B, 6440 B	D4657-92	G, Teflon-lined cap	Cool, 4°C, 0.008% Na ₂ S ₂ O ₃ ⁵ store in dark		40 days after extraction;	
5	Anthracene	Anthracene	610	625, 1625	610	6410 B, 6440 B	D4657-92	G, Teflon-lined cap	Cool, 4°C, 0.008% Na ₂ S ₂ O ₃ ⁵ store in dark		7 days until extraction;	
7	Benzidine	Benzidine	-	5625, 1625	605	-	-	G, Teflon-lined cap	Cool, 4°C, 0.008% Na ₂ S ₂ O ₃ ⁵		40 days after extraction;	
8	Benzo(a)Anthracene	Benzo(a)Anthracene	610	625, 1625	610	6410 B, 6440 B	D4657-92	G, Teflon-lined cap	Cool, 4°C, 0.008% Na ₂ S ₂ O ₃ ⁵ store in dark		7 days until extraction; ¹³	
9	Benzo(a)Pyrene	Benzo(a)Pyrene	610	625, 1625	610	6410 B, 6440 B	D4657-92	G, Teflon-lined cap	Cool, 4°C, 0.008% Na ₂ S ₂ O ₃ ⁵ store in dark		7 days until extraction;	
10	3,4-Benzofluoranthene	Benzo(b)Fluoranthene	610	625, 1625	610	6410 B, 6440 B	D4657-92	G, Teflon-lined cap	Cool, 4°C, 0.008% Na ₂ S ₂ O ₃ ⁵ store in dark		40 days after extraction;	
11	Benzo(ghi)Perylene	Benzo(ghi)Perylene	610	625, 1625	610	6410 B, 6440 B	D4657-92	G, Teflon-lined cap	Cool, 4°C, 0.008% Na ₂ S ₂ O ₃ ⁵ store in dark		7 days until extraction;	
12	Benzo(k)Fluoranthene	Benzo(k)Fluoranthene	610	625, 1625	610	6410 B, 6440 B	D4657-92	G, Teflon-lined cap	Cool, 4°C, 0.008% Na ₂ S ₂ O ₃ ⁵ store in dark		40 days after extraction;	
15	Bis (2-Chloroethoxy) Methane	Bis (2-Chloroethoxy) Methane	611	625, 1625	-	6410 B	-	G, Teflon-lined cap	Cool, 4°C, 0.008% Na ₂ S ₂ O ₃ ⁵		40 days after extraction;	
16	Bis (2-Chloroethyl) Ether	Bis (2-Chloroethyl) Ether	611	625, 1625	-	6410 B	-	G, Teflon-lined cap	Cool, 4°C, 0.008% Na ₂ S ₂ O ₃ ⁵		7 days until extraction;	
75	Bis (2-Chloroisopropyl) Ether	2,2-oxybis(1-Chloropropane)	611	625, 1625	-	6410 B	-	G, Teflon-lined cap	Cool, 4°C, 0.008% Na ₂ S ₂ O ₃ ⁵		40 days after extraction;	
17	Bis (2-Ethylhexyl) Phthalate	Bis (2-Ethylhexyl) Phthalate	606	625, 1625	-	6410 B, 6230 B	-	G, Teflon-lined cap	Cool, 4°C		40 days after extraction;	
21	4-Bromophenyl Phenyl Ether	4-Bromophenyl-phenyl Ether	611	625, 1625	-	6410 B	-	G, Teflon-lined cap	Cool, 4°C, 0.008% Na ₂ S ₂ O ₃ ⁵		7 days until extraction;	

Numbers from Code of Federal Regulations Table IC (Non-Pesticide Organic Compounds)
Methods in **BOLD** indicate the method currently used for NPDES permit test procedures.

2019 NPDES Permit Re-Application
Sampling and Analysis Plan (SAP)
July 2018

TABLE 7
EPA APPLICATION FORM 2C – PART C POLLUTANTS
GC/MS FRACTION – BASE/NEUTRAL COMPOUNDS

Code of Fed Regulations		Approved Methods, Containers, Preservation, Holding Times including Notes/Citations from CFR										Max. Holding Time
#	Base/Neutral	GEL	EPA: GC	EPA: GC/MS	HPLC	Std method 18 th Ed.	ASTM	Container	Preservation			
14	Butyl Benzyl Phthalate	Butylbenzylphthalate	606	625, 1625	-	6410 B	-	G, Teflon-lined cap	Cool, 4°C		7 days until extraction;	
	Benzyl butyl phthalate	GCFR definition									40 days after extraction.	
29	2-Chloronaphthalene	2-Chloronaphthalene	612	625, 1625	-	6410 B	-	G, Teflon-lined cap	Cool, 4°C		7 days until extraction;	
											40 days after extraction.	
31	4-Chlorophenyl Phenyl Ether	4-Chlorophenyl-phenyl Ether	611	625, 1625	-	6410 B	-	G, Teflon-lined cap	Cool, 4°C, 0.008% Na ₂ S ₂ O ₃ ⁵		7 days until extraction;	
											40 days after extraction.	
32	Chrysene	Chrysene	610	625, 1625	610	6410 B, 6440 B	D4657-92	G, Teflon-lined cap	Cool, 4°C, 0.008% Na ₂ S ₂ O ₃ ⁵ store in dark		7 days until extraction;	
											40 days after extraction.	
33	Dibenz(a,h)Anthracene	Dibenz(a,h)Anthracene	610	625, 1625	610	6410 B, 6440 B	D4657-92	G, Teflon-lined cap	Cool, 4°C, 0.008% Na ₂ S ₂ O ₃ ⁵ store in dark		7 days until extraction;	
											40 days after extraction.	
35	1,2-Dichlorobenzene	1,2-Dichlorobenzene	601, 602, 612	624, 625, 1625	-	6410 B, 6230 B, 6220 B	-	G, Teflon-lined cap	Cool, 4°C		40 days after extraction;	
											7 days until extraction;	
36	1,3-Dichlorobenzene	1,3-Dichlorobenzene	601, 602, 612	624, 625, 1625	-	6410 B, 6230 B, 6220 B	-	G, Teflon-lined septum	Cool, 4°C, 0.008% Na ₂ S ₂ O ₃ ⁵		40 days after extraction.	
											14 days	
											7 days until extraction;	
37	1,4-Dichlorobenzene	1,4-Dichlorobenzene	601, 602, 612	624, 625, 1625	-	6410 B, 6220 B, 6230 B	-	G, Teflon-lined septum	Cool, 4°C, 0.008% Na ₂ S ₂ O ₃ ⁵		40 days after extraction.	
											14 days	
											7 days until extraction;	
38	3,3-Dichlorobenzidine	3,3-Dichlorobenzidine	606	625, 1625	605	6410 B	-	G, Teflon-lined cap	Cool, 4°C, 0.008% Na ₂ S ₂ O ₃ ⁵		7 days until extraction ¹³	
48	Diethyl Phthalate	Diethylphthalate	606	625, 1625	-	6410 B	-	G, Teflon-lined cap	Cool, 4°C		7 days until extraction;	
											40 days after extraction.	
50	Dimethyl Phthalate	Dimethyl Phthalate	606	625, 1625	-	6410 B	-	G, Teflon-lined septum	Cool, 4°C, 0.008% Na ₂ S ₂ O ₃ ⁵		40 days after extraction.	
											14 days	
51	Di-n-Butyl Phthalate	Di-n-Butylphthalate	606	625, 1625	-	6410 B	-	G, Teflon-lined cap	Cool, 4°C		40 days after extraction.	
											7 days until extraction.	
54	2,4-Dinitrotoluene	2,4-Dinitrotoluene	609	625, 1625	-	6410 B	-	G, Teflon-lined cap	Cool, 4°C, 0.008% Na ₂ S ₂ O ₃ ⁵ store in dark		40 days after extraction.	
											7 days until extraction;	
55	2,6-Dinitrotoluene	2,6-Dinitrotoluene	609	625, 1625	-	6410 B	-	G, Teflon-lined cap	Cool, 4°C, 0.008% Na ₂ S ₂ O ₃ ⁵ store in dark		40 days after extraction.	
											7 days until extraction;	

Numbers from Code of Federal Regulations Table IC (Non-Pesticide Organic Compounds)
Methods in **BOLD** indicate the method currently used for NPDES permit test procedures.

2019 NPDES Permit Re-Application
Sampling and Analysis Plan (SAP)
July 2018

TABLE 7
EPA APPLICATION FORM 2C – PART C POLLUTANTS
GC/MS FRACTION – BASE/NEUTRAL COMPOUNDS

#	Code of Fed Regulations	Base/Neutral	GEL	EPA: GC	EPA: GC/MS	HPLC	Std method 18 th Ed.	ASTM	Container	Preservation	Max. Holding Time
52		Di-n-Octyl Phthalate		606	625, 1625	-	6410 B	-	G, Teflon-lined cap	dark Cool, 4°C	40 days after extraction; 7 days until extraction; 40 days after extraction.
-		1,2-Diphenylhydrazine			625, 1625*						
58		Fluoranthene		610	625, 1625	610	6410 B, 6440 B	D4657-92	G, Teflon-lined cap	Cool, 4°C, 0.008% Na ₂ S ₂ O ₅ store in dark	7 days until extraction; 40 days after extraction.
59		Fluorene		610	625, 1625	610	6410 B, 6440 B	D4657-92	G, Teflon-lined cap	Cool, 4°C, 0.008% Na ₂ S ₂ O ₅ store in dark	7 days until extraction; 40 days after extraction.
60		Hexachlorobenzene		612	625, 1625	-	6410 B	-	G, Teflon-lined cap	Cool, 4°C	40 days after extraction; 7 days until extraction;
61		Hexachlorobutadiene		612	625, 1625	-	6410 B	-	G, Teflon-lined cap	Cool, 4°C	40 days after extraction; 7 days until extraction;
62		Hexachlorocyclopentadiene		612	625, 1625	-	6410 B	-	G, Teflon-lined cap	Cool, 4°C	40 days after extraction; 7 days until extraction;
63		Hexachloroethane		616	625, 1625	-	6410 B	-	G, Teflon-lined cap	Cool, 4°C	40 days after extraction; 7 days until extraction;
64		Indeno(1,2,3-cd)Pyrene		610	625, 1625	610	6410 B, 6440 B	D4657-92	G, Teflon-lined cap	Cool, 4°C, 0.008% Na ₂ S ₂ O ₅ store in dark	40 days after extraction; 7 days until extraction;
65		Isophorone		609	625, 1625	-	6410 B	-	G, Teflon-lined cap	Cool, 4°C, 0.008% Na ₂ S ₂ O ₅ store in dark	40 days after extraction; 7 days until extraction;
68		Naphthalene		610	625, 1625	610	6410 B, 6440 B	-	G, Teflon-lined cap	Cool, 4°C, 0.008% Na ₂ S ₂ O ₅ store in dark	40 days after extraction; 7 days until extraction;
69		Nitrobenzene		609	625, 1625	-	6410 B	-	G, Teflon-lined cap	Cool, 4°C, 0.008% Na ₂ S ₂ O ₅ store in dark	40 days after extraction; 7 days until extraction;
72		N-Nitrosodimethylamine		607	625, 1625	-	6410 B	-	G, Teflon-lined cap	Cool, 4°C, store in dark, 0.008% Na ₂ S ₂ O ₅	40 days after extraction; 7 days until extraction;
73		N-Nitrosodi-N-Propylamine		607	625, 1625	-	6410 B	-	G, Teflon-lined cap	Cool, 4°C, store in dark, 0.008% Na ₂ S ₂ O ₅	40 days after extraction; 7 days until extraction;
74		N-Nitrosodiphenylamine		607	625, 1625	-	6410 B	-	G, Teflon-lined cap	Cool, 4°C, store in dark, 0.008% Na ₂ S ₂ O ₅	40 days after extraction; 7 days until extraction;

Numbers from Code of Federal Regulations Table IC (Non-Pesticide Organic Compounds)
Methods in **BOLD** indicate the method currently used for NPDES permit test procedures.

2019 NPDES Permit Re-Application
Sampling and Analysis Plan (SAP)
July 2018

TABLE 7
EPA APPLICATION FORM 2C – PART C POLLUTANTS
GC/MS FRACTION – BASE/NEUTRAL COMPOUNDS

Code of Fed Regulations	Approved Methods, Containers, Preservation, Holding Times including Notes/Citations from CFR							Max. Holding Time		
	Base/Neutral	GEL	EPA: GC	EPA: GC/MS	HPLC	Std method 18 th Ed.	ASTM		Container	Preservation
84	Phenanthrene		610	625, 1625	610	6410 B, 6440 B	D4657-92	G, Teflon-lined cap	Cool, 4°C, 0.008% Na ₂ S ₂ O ₃ store in dark	40 days after extraction; 7 days until extraction;
86	Pyrene		610	625, 1625	610	6410 B, 6440 B	D4675-92	G, Teflon-lined cap	Cool, 4°C, 0.008% Na ₂ S ₂ O ₃ store in dark	40 days after extraction; 7 days until extraction;
91	1,2,4-Trichlorobenzene		612	625, 1625	-	6410 B	-	G, Teflon-lined cap	Cool, 4°C	40 days after extraction; 7 days until extraction; 40 days after extraction;

Numbers from Code of Federal Regulations Table IC (Non-Pesticide Organic Compounds)
Methods in **BOLD** indicate the method currently used for NPDES permit test procedures.

2019 NPDES Permit Re-Application
Sampling and Analysis Plan (SAP)
July 2018

TABLE 8
EPA APPLICATION FORM 2C – PART C POLLUTANTS
GC/MS FRACTION – PESTICIDES

Code of Fed Regulations		Approved Methods, Containers, Preservation, Holding Times including Notes/Citations from CFR										Max. Holding Time
#	Pesticides	GEL	METHOD	EPA	Std method 18 th Ed.	ASTM	Container	Preservation				
1	Aldrin	Aldrin	GC	608	6630 B & C	D3086-90	G, Teflon-lined cap	Cool, 4°C, pH 5-9 ¹⁵				7 days until extraction;
			GC/MS	625	6410 B	-						40 days after extraction.
8	α-BHC	alpha-BHC	GC	608	6630 B & C	D3086-90	G, Teflon-lined cap	Cool, 4°C, pH 5-9 ¹⁵				7 days until extraction;
			GC/MS	⁶²⁵	6410 B	-						40 days after extraction.
9	β-BHC	beta-BHC	GC	608	6630	D3086-90	G, Teflon-lined cap	Cool, 4°C, pH 5-9 ¹⁵				7 days until extraction;
			GC/MS	⁶²⁵	6410 B	-						40 days after extraction.
10	γ-BHC	gamma-BHC (Lindane)	GC	608	6630 B & C	D3086-90	G, Teflon-lined cap	Cool, 4°C, pH 5-9 ¹⁵				7 days until extraction;
			GC/MS	⁶²⁵	6410 B	-						40 days after extraction.
11	δ-BHC	delta-BHC	GC	608	6630 B & C	D3086-90	G, Teflon-lined cap	Cool, 4°C, pH 5-9 ¹⁵				7 days until extraction;
			GC/MS	⁶²⁵	6410 B	-						40 days after extraction.
15	Chlordane	Chlordane	GC	608	6630 B & C	D3086-90	G, Teflon-lined cap	Cool, 4°C, pH 5-9 ¹⁵				7 days until extraction;
			GC/MS	625	6410 B	-						40 days after extraction.
20	4,4'-DDT	4,4'-DDT	GC	608	6630 B & C	D3086-90	G, Teflon-lined cap	Cool, 4°C, pH 5-9 ¹⁵				7 days until extraction;
			GC/MS	625	6410 B	-						40 days after extraction.
19	4,4'-DDE	4,4'-DDE	GC	608	6630 B & C	D3086-90	G, Teflon-lined cap	Cool, 4°C, pH 5-9 ¹⁵				7 days until extraction;
			GC/MS	625	6410 B	-						40 days after extraction.
18	4,4'-DDD	4,4'-DDD	GC	608	6630 B & C	D3086-90	G, Teflon-lined cap	Cool, 4°C, pH 5-9 ¹⁵				7 days until extraction;
			GC/MS	625	6410 B	-						40 days after extraction.
28	Dieldrin	Dieldrin	GC	608	6630 B & C	D3086-90	G, Teflon-lined cap	Cool, 4°C, pH 5-9 ¹⁵				7 days until extraction;
			GC/MS	625	6410 B	-						40 days after extraction.
32	α-Endosulfan	Endosulfan I	GC	608	6630 B & C	D3086-90	G, Teflon-lined cap	Cool, 4°C, pH 5-9 ¹⁵				7 days until extraction;
			GC/MS	⁶²⁵	6410 B	-						40 days after extraction.
33	β-Endosulfan	Endosulfan II	GC	608	6630 B & C	D3086-90	G, Teflon-lined cap	Cool, 4°C, pH 5-9 ¹⁵				7 days until extraction;
			GC/MS	⁶²⁵	6410 B	-						40 days after extraction.
34	Endosulfan Sulfate	Endosulfan sulfate	GC	608	6630 C	D3086-90	G, Teflon-lined cap	Cool, 4°C, pH 5-9 ¹⁵				7 days until extraction;
			GC/MS	625	6410 B	-						40 days after extraction.
35	Endrin	Endrin	GC	608	6630 B & C	D3086-90	G, Teflon-lined cap	Cool, 4°C, pH 5-9 ¹⁵				7 days until extraction;
			GC/MS	⁶²⁵	6410 B	-						40 days after extraction.
36	Endrin Aldehyde	Endrin Aldehyde	GC	608	-	-	G, Teflon-lined cap	Cool, 4°C, pH 5-9 ¹⁵				7 days until extraction;
			GC	⁶²⁵	-	-						40 days after extraction.
40	Heptachlor	Heptachlor	GC	608	6630 B & C	D3086-90	G, Teflon-lined cap	Cool, 4°C, pH 5-9 ¹⁵				7 days until extraction;

Numbers from Code of Federal Regulations Table IC (Non-Pesticide Organic Compounds)
Methods in **BOLD** indicate the method currently used for NPDES permit test procedures.

2019 NPDES Permit Re-Application
Sampling and Analysis Plan (SAP)
July 2018

TABLE 8
EPA APPLICATION FORM 2C – PART C POLLUTANTS
GC/MS FRACTION – PESTICIDES

Code of Fed Regulations	Approved Methods, Containers, Preservation, Holding Times including Notes/Citations from CFR										Max. Holding Time
	Pesticides	GEL	METHOD	EPA	Std method 18 th Ed.	ASTM	Container	Preservation			
			GC/MS	625	6410 B	-					40 days after extraction.
41	Heptachlor Epoxide	Heptachlor Epoxide	GC	608	6630 B	D3086-90	G, Teflon-lined cap	Cool, 4°C, pH 5-9 ¹⁵			7 days until extraction.
69	Toxaphene	Toxaphene	GC/MS	625	6410 B	-					40 days after extraction.
			GC	608	6630 B & C	D3086-90	G, Teflon-lined cap	Cool, 4°C, pH 5-9 ¹⁵			7 days until extraction;
			GC/MS	625	6410 B	-					40 days after extraction.
79*	PCB-1242	Arochlor 1242	608	625	6410 B	-	G, Teflon-lined cap	Cool, 4°C			7 days until extraction;
											40 days after extraction.
81*	PCB-1254	Arochlor 1254	608	625	6410 B	-	G, Teflon-lined cap	Cool, 4°C			7 days until extraction;
											40 days after extraction.
77*	PCB-1221	Arochlor 1221	608	625	6410 B	-	G, Teflon-lined cap	Cool, 4°C			7 days until extraction;
											40 days after extraction.
78*	PCB-1232	Arochlor 1232	608	625	6410 B	-	G, Teflon-lined cap	Cool, 4°C			7 days until extraction;
											40 days after extraction.
80*	PCB-1248	Arochlor 1248	608	625	6410 B	-	G, Teflon-lined cap	Cool, 4°C			7 days until extraction;
											40 days after extraction.
82*	PCB-1260	Arochlor 1260	608	625	6410 B; 6630 B	-	G, Teflon-lined cap	Cool, 4°C			7 days until extraction;
											40 days after extraction.
76*	PCB-1016	Arochlor 1016	608	625	6410 B	-	G, Teflon-lined cap	Cool, 4°C			7 days until extraction;
											40 days after extraction.

NOTE: PCBs will be analyzed using the Method 1668 (congener).

Parameter	Method	Type	Filter	Preservative	Container	Hold Time
PCB	Method 1668	24-hr	NA	Cool less than or equal to 6°C	2 - 1 Liter Amber Glass	1 year

Numbers from Code of Federal Regulations Table IC (Non-Pesticide Organic Compounds)
Methods in **BOLD** indicate the method currently used for NPDES permit test procedures.

APPENDIX M

State of New Mexico Classified Stream Segments, 20.6.4 NMAC

State of New Mexico Classified Stream Segments on the Pajarito Plateau

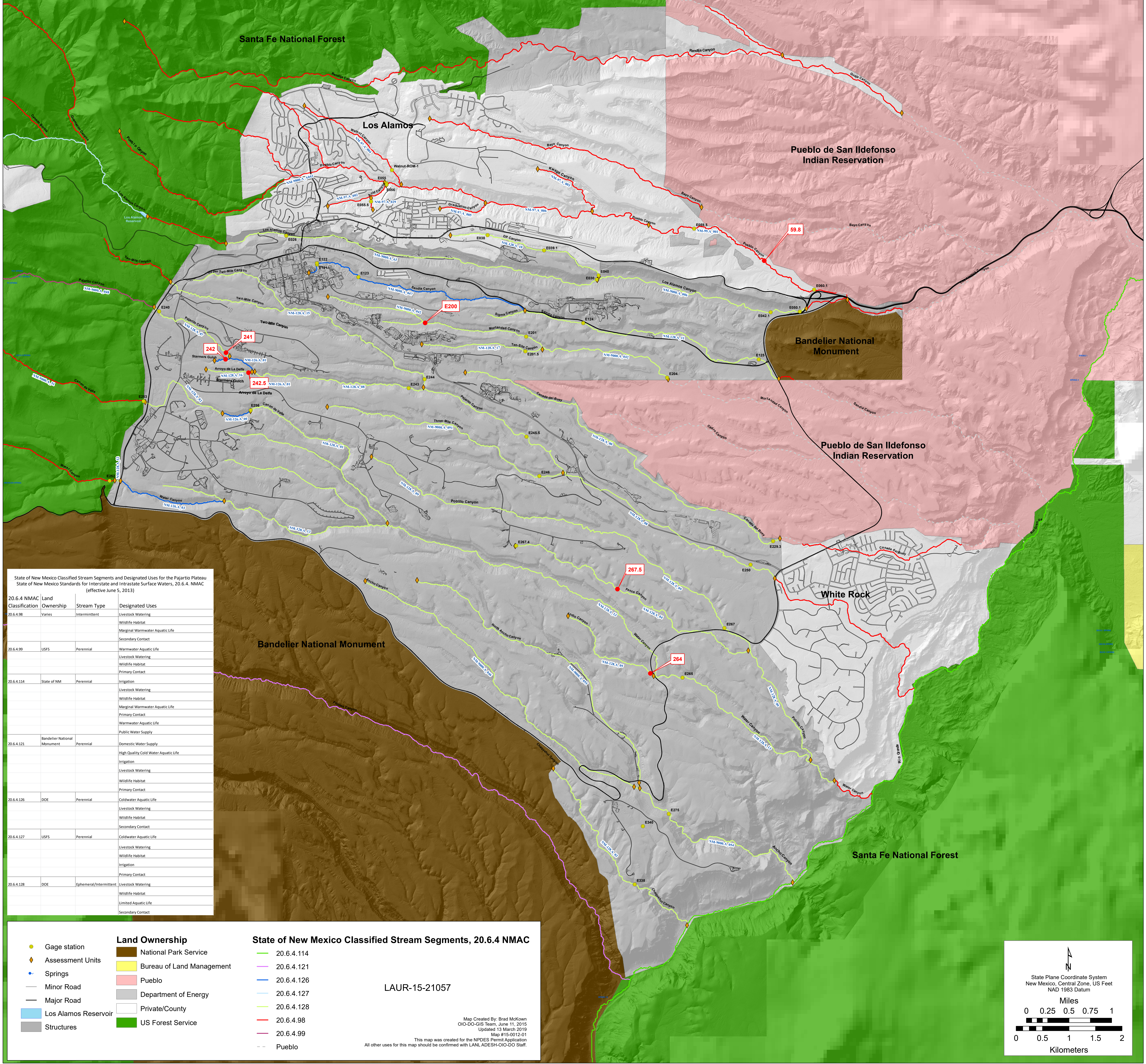

State of New Mexico Classified Stream Segments and Designated Uses for the Pajarito Plateau
State of New Mexico Standards for Interstate and Intrastate Surface Waters, 20.6.4. NMAC (effective June 5, 2013)

20.6.4 NMAC Classification	Land Ownership	Stream Type	Designated Uses
20.6.4.98	Varies	Intermittent	Livestock Watering Wildlife Habitat Marginal Warmwater Aquatic Life Secondary Contact
20.6.4.99	USFS	Perennial	Warmwater Aquatic Life Livestock Watering Wildlife Habitat Primary Contact
20.6.4.114	State of NM	Perennial	Irrigation Livestock Watering Wildlife Habitat Marginal Warmwater Aquatic Life Primary Contact Warmwater Aquatic Life
20.6.4.121	Bandelier National Monument	Perennial	Domestic Water Supply High Quality Cold Water Aquatic Life Irrigation Livestock Watering Wildlife Habitat Primary Contact
20.6.4.126	DOE	Perennial	Coldwater Aquatic Life Livestock Watering Wildlife Habitat Secondary Contact
20.6.4.127	USFS	Perennial	Coldwater Aquatic Life Livestock Watering Wildlife Habitat Irrigation Primary Contact
20.6.4.128	DOE	Ephemeral/Intermittent	Livestock Watering Wildlife Habitat Limited Aquatic Life Secondary Contact

Land Ownership

- National Park Service
- Bureau of Land Management
- Pueblo
- Department of Energy
- Private/County
- US Forest Service

State of New Mexico Classified Stream Segments, 20.6.4 NMAC

- 20.6.4.114
- 20.6.4.121
- 20.6.4.126
- 20.6.4.127
- 20.6.4.128
- 20.6.4.98
- 20.6.4.99
- Pueblo

Laur-15-21057

Map Created By: Brad McKown
OIO-DO-GIS Team, June 11, 2015
Updated 13 March 2019
Map #15-0012-01
Map #15-0012-01
This map was created for the NPDES Permit Application
All other uses for this map should be confirmed with LANL ADESH-OIO-DO Staff.

